

No part of this handbook may be reproduced,
transcribed, translated into any language or transmitted
in any form whatsoever without the prior written
consent of Codan Pty Ltd.

© Copyright 1996 Codan Pty Ltd.

Codan Part N° 15-04070 Issue 2, February 1996



Contents

1 About this handbook

Standards and icons	1-2
Glossary.....	1-3
Other documents.....	1-6

2 Overview

Equipment	2-1
The console	2-2
Power	2-2
The interface.....	2-3
Mounting options.....	2-3
Power.....	2-3
Selective calling.....	2-3
System configurations	2-4
The basic arrangement	2-4
Multiple control systems.....	2-5
Separate transmitter and receiver sites.....	2-8

3 Installation

Checking the equipment supplied.....	3-2
Precautions	3-2
Installing the console—8570.....	3-3
Connecting the console to the power supply.....	3-4
External alarm.....	3-6
Installing the interface—8571	3-7
Connecting to power.....	3-8
Connecting to the transceiver.....	3-8

Connecting the remote control system.....	3-9
2-wire interface connections	3-9
4-wire interface connections	3-10
Disabling the interface line links.....	3-11
Installing single or multiple site systems	3-13
Basic single site	3-16
Separate transmitter and receiver sites—split sites.....	3-17
Daisy chain split site with master transmitter.....	3-18
Daisy chain split site with master receiver	3-20
Star split site	3-22
Installation checks	3-24
Checking the remote site.....	3-24
Checking the base site.....	3-25
Setting line parameters	3-26
Displaying the Line Parameters menu.....	3-27
Resetting line parameters to default settings.....	3-28
Terminating the line.....	3-29
Setting the console configuration.....	3-30
Setting line parameters for the interface	3-32
Setting line parameters for the console	3-40
Setting a system backup	3-43
Selecting the backup transceiver operating mode	3-45
Enabling and disabling consoles.....	3-47

4 Ancillary equipment

IPC-500 Radio telephone interconnect.....	4-2
8580 Data modem	4-3
Data transmission.....	4-3
Setting the S101 switches	4-4
Baud rate—S101.....	4-5
Parity—S101	4-6
Data width—S101	4-6
Stop bits—S101.....	4-7

Setting the S102 switches	4-7
Interface parameters—S102	4-8
Buffering parameters—S102	4-9
Setting backplane link positions	4-10
P304A and P304B	4-11
Connector P304A and P304B	4-12
Console software configuration	4-12
9300 ALE Controller.....	4-14
9001 HF Fax and data interface and 9002 data modem	4-15
Computer	4-16

5 Accessories

ALE split site switch cable	5-2
RS-232/I ² C Interface	5-2
Setup	5-3
RS-232/I ² C Interface address.....	5-4
Setting up the inputs and outputs (Option GPIO).....	5-5

6 Setup functions and options

Functions and options available	6-1
Viewing the setup functions menus	6-3
Using setup mode	6-4
Making changes	6-6
Group 0—Console setup options.....	6-7
Setting a PIN (password)—function 0	6-7
General setup options—function 1	6-10
Access priority options—function 2	6-20
Set startup mute—function 3	6-25
Set display backlight intensity—function 4	6-26
Enable/disable monitor mode—function 5	6-26
Backup transceiver setup—function 7	6-27
Group 1—System information options.....	6-28
Transceiver—function 10	6-29

Remote control software—function 11	6-29
Local supply voltage—function 14.....	6-30
Remote supply voltage—function 15.....	6-31
Update channel frequency memory—function 18.....	6-31
Group 2—Line setup options	6-32
Line parameters—function 20	6-33
Line equalisation parameters—function 21	6-36
Miscellaneous menu—function 25	6-37
RS-232 terminal menu—function 30	6-42
Function key set up—function 31	6-46
RS-232 Window—function 35.....	6-47
View configuration—function 99	6-47

7 Appendices

Specifications	7-1
Display messages.....	7-3
Messages and operator errors	7-3
System error messages	7-5
Supply monitor warning messages.....	7-5
Options and accessories.....	7-8
Accessory codes.....	7-9
Power supplies	7-10
Pin assignment for 4-wire interface connector.....	7-10
Pin assignment for 2-wire interface connector.....	7-10

Index

Figures

Figure 2.1 Basic system arrangement for remote control system	2-5
Figure 2.2 Basic multiple control system	2-6
Figure 2.3 Multiple control points on a basic system	2-7
Figure 2.4 Control points over four separate lines on a basic system	2-8
Figure 2.5 Separate transmitter and receiver sites (daisy chain).....	2-9
Figure 2.6 Star configuration split site system	2-9
Figure 3.1 Console rear panel connections	3-3
Figure 3.2 AC mains input module	3-4
Figure 3.3 Interface rear panel connections	3-7
Figure 3.4 Disabling the line link positions.....	3-11
Figure 3.5 System configuration switch	3-13
Figure 3.6 Basic single site	3-16
Figure 3.7 Daisy chain split site with master transmitter.....	3-18
Figure 3.8 Daisy chain split site with master receiver	3-20
Figure 3.9 Star split site	3-22
Figure 4.1 Data switch S101/S102 locations.....	4-4
Figure 4.2 Interface RCI backplane data link positions	4-10
Figure 6.1 Console front panel display PCB setup link.....	6-3



Contents

1 About this handbook

The 8570/8571 remote control system is used to control a remotely sited transceiver. This handbook explains how to install the system. It assumes that you already know how to operate the transceiver and power supply, which are supplied separately.

The handbook contains seven chapters:

Chapter 2 describes the main features of the 8570 and 8571 remote control system, and the various ways of setting up the remote control system

Chapter 3 describes how to install and set up the remote control system.

Chapter 4 describes how to set up and use ancillary equipment.

Chapter 5 contains information about accessories.

Chapter 6 describes setup functions and operations that are infrequently used.

Chapter 7 contains specifications and a list of error or warning messages.



Standards and icons

The following standards and icons are used in this handbook:

- the names of buttons and knobs appear in bold typeface—for example: ‘press the **Tune** button on the remote control console’
- menu names and text requiring emphasis are in italics

This icon...

Means...



the end of a subject.



a warning.



Glossary

This term...	Means...
ARQ	Automatic Repeat Request—a type of signalling in which the call is repeated until answered
Called ID	the ID of the station being called (the receiving station's self ID).
Called address	Four or six digit identification number of a station being called
CB	Citizens Band
CICS	Computer Interface Command Set
Selcall station	a location of a transceiver able to transmit and receive Selcalls
EPROM	Erasable Programmable Read Only Memory
EEPROM	Electrically Erasable Programmable Read Only Memory
FEC	Forward Error Correction—a type of signalling that does not require an answer; parity checks are carried with the data signal
Group call	a Selcall to all transceivers within a selected group
HF	High Frequency
ID	Identification
I/O	Input/output
LCD	Liquid Crystal Display

LED	Light Emitting Diode
LSB	Lower Sideband
PCB	Printed Circuit Board
PIN	Personal Identification Number
PSTN	Public Switched Telephone Network
PTT	Press-To-Talk
Revertive signal	A signal automatically transmitted back from a receiving transceiver to indicate message received and decoded satisfactorily. The signal is not transmitted for group calls.
RF	Radio Frequency
RFDS	Royal Flying Doctor Service (of Australia)
Rx	Receive
SDE	Selective calling option that transmits to a pre-set address; also decodes incoming calls
SDEM	Selective calling option that transmits a programmable address; also decodes incoming calls
SE2	Selective calling option that transmits to a pre-set address; does not decode incoming calls
Self-identification	Four or six digit identification number of a calling or local station

SEM	Selective calling option that transmits a programmable address; also decodes incoming calls
Tcvr	Transceiver
Tx	Transmit
USB	Upper Sideband

Other documents

For information on how to use the remote control system, refer to the *8570 and 8571 Remote control operators handbook* (Codan part number 15-04018).

For information on ALE calling, refer to the *9300 ALE controller user guide* (Codan part number 15-04046).

For information on the installation and operation of an 8580 data modem, refer to the *8580 Data modem user guide* (Codan part number 15-04022).

For information on the installation and operation of the 9001 interface refer to the *9001 HF Fax and data interface user guide* (Codan part number 15-04038).

For information on the installation and operation of the 9002 modem refer to the *9002 HF Data modem user guide* (Codan part number 15-04041).

For information on using an IPC-500 Radio telephone interconnect unit refer to the *IPC-500 Interconnect user guide and Installation manual* (Codan part number 15-04064 or 15-04064).



2 Overview

This chapter describes:

- the main features of the 8570 and 8571 remote control system (2-1)
- the various ways of setting up the remote control system (2-5).

The remote control system is used to control a selected range of Codan high frequency (HF) transceivers. It allows you to install your transceiver in a remote location and control it from another site. This enables you, for example, to site your receiver or transceiver in an electrically quiet location while controlling it from a poor reception area.

Equipment

The system consists of two units:

- the 8570 remote control console (the console)
- the 8571 remote control interface (the interface)

The console is a stand-alone desktop unit. The interface is bench or rack-mounted with the transceiver and power supply. The console and interface are connected by a land line or VHF/UHF radio link.

Options and accessories available for the remote control system are listed in *Chapter 7, Appendices, Options and accessories*.



The console

For information on the buttons and knobs that control the console, refer to the *8570 and 8571 Remote control operators handbook*, Chapter 2, *Overview*, *The console*.

Power

The console is powered from the AC mains—100/120/220/240 V. An optional stand-by battery is available. The standby battery is charged while the console remains connected to the AC mains.

The interface

The 8571 remote control interface is the interface between the console and the transceiver. For more complex system configurations, up to four 2-wire land lines or 4-wire radio links can be accommodated.

Mounting options

The interface is mechanically similar in size to the Codan range of transceivers and power supply units. You can stack it with the transceiver and power supply (as shown in Figure 2.1) or mount it in an optional sub-rack frame. The frame fits on a 483 mm (19 inch) rack.

Power

The interface is powered from the transceiver's unswitched 12 volt DC supply or directly from the power supply using a suitable cable or adapter.

Selective calling

The remote control system allows you to send Selcalls and group calls using the Selcall ID's of the stations in your network. If the remotely controlled transceiver is a 9323 or 9360, Selcall is fitted as standard. It is optional if the transceiver is a 8525 or 8528. You can control all aspects of selective calling from the 8570 remote control console, including programming scan channels and accessing the transceiver's call memory.

If your system has several consoles—multi point control—each can be programmed with a different Selcall address.



For split site systems all connected transceivers (receivers and transmitters) must not be programmed with a Selcall self address ID. If the installed transceiver originally had this facility it must be deleted—refer to the appropriate transceiver handbook. It is operationally acceptable for the transceiver in a basic single site to have the transceiver self address ID programmed.



System configurations

System connection and the placement of consoles will be determined largely by the availability of sites and the operating performance in each of the sites. Consideration must be given to the effect of electrical interference into the receiver, or on equipment near the transmitter.

The console and interface can be arranged to support a number of operating system interconnects that will maximise the conditions available. For example you can have up to twelve consoles connected by four lines to the interface (i.e. up to three consoles in parallel on each line). You can also separate the transmit and receive sites.

Line loss and equalisation adjustments are automatic.

The basic arrangement

This example shows a basic arrangement consisting of one console and one interface.

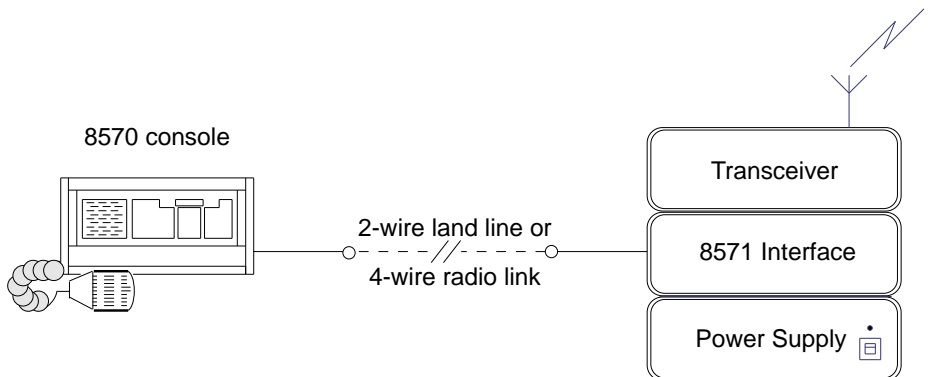

Figure 2.1 Basic system arrangement for remote control system

Multiple control systems

You can connect up to three consoles in parallel to one interface using a single line. Using separate lines or radio links, you can connect up to four consoles to one interface. Figures 2.2 to 2.6 show the possible system connections for multiple console control.

See *Chapter 3, Installation* for more information on these configurations.

Multiple control consoles on a local network

This example shows a system arrangement with three consoles connected to a transceiver through a single line to an interface.

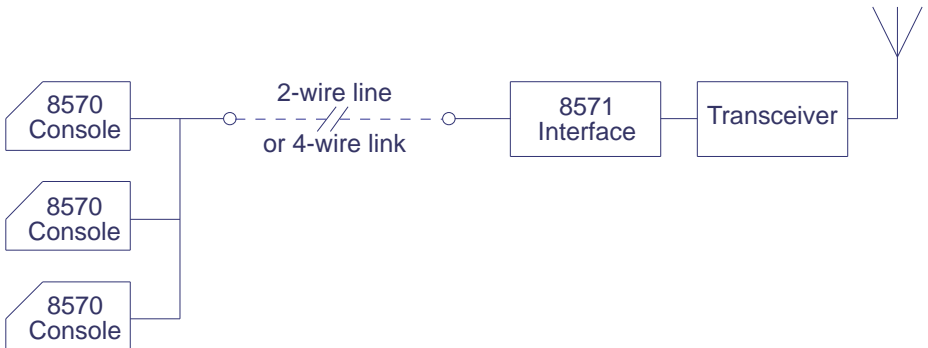

Figure 2.2 Basic multiple control system

Multiple control consoles

This arrangement has consoles in two separate locations. All are connected to the same interface and operating transceiver.

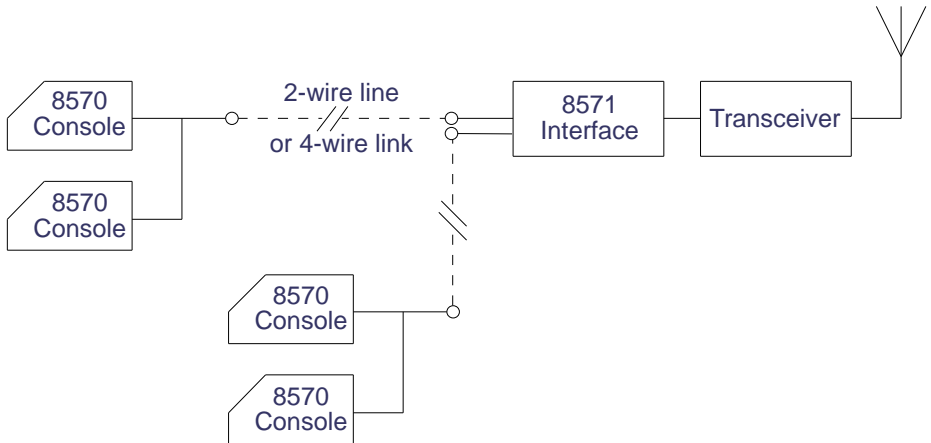

Figure 2.3 Multiple control points on a basic system

Note: The maximum number of consoles connected in parallel to each land line or radio link is three.

Control consoles over four separate lines

This example shows an arrangement using the maximum of four land lines or radio links between the consoles and interface.

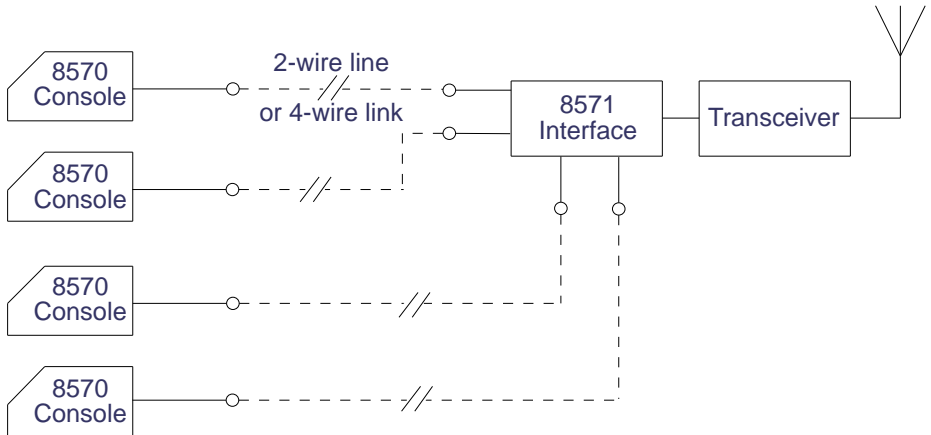

Figure 2.4 Control points over four separate lines on a basic system

Note: The maximum number of consoles connected in parallel to each land line or radio link is three.

Separate transmitter and receiver sites

This example shows an arrangement of a split site system, where the receiver and transmitter are at different locations. You can also combine multiple control points and split transmitter and receiver sites.

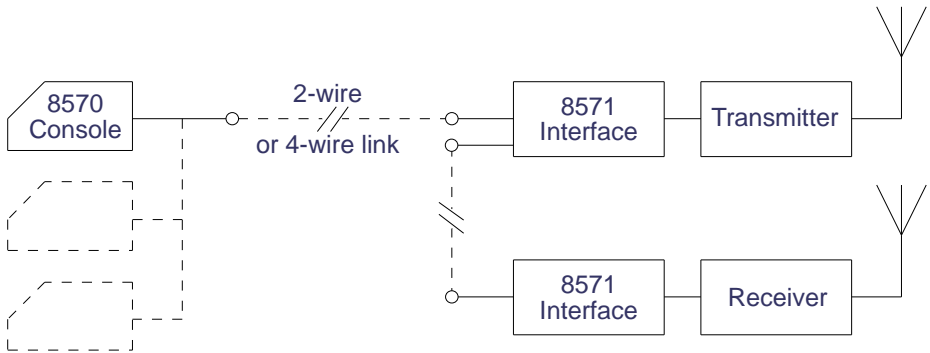

Figure 2.5 Separate transmitter and receiver sites (daisy chain)

Figure 2.6 shows a split transmitter and receiver site with three interface units and one console.

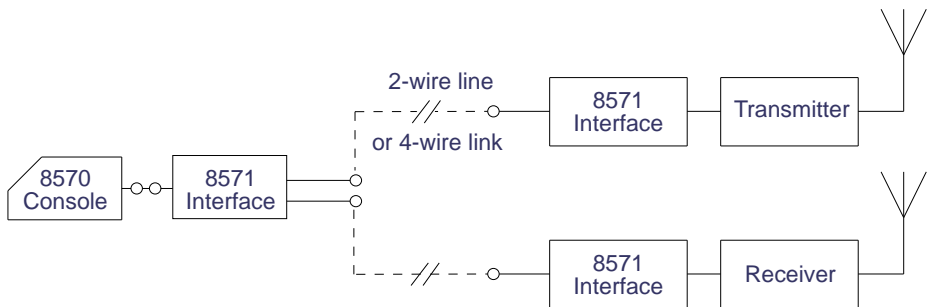

Figure 2.6 Star configuration split site system



Overview

3 Installation

This chapter explains how to install a basic system or a separate split site system. It does not include instructions for installing equipment such as the transceiver or antenna tuner—installation of these is covered in the manuals supplied with these units.

This chapter covers:

- Checking the equipment supplied (3-2)
- Precautions (3-2)
- Installing the console—8570 (3-3)
- Installing the interface—8571 (3-7)
- Connecting the remote control system (3-9)
- Installing single or multiple site systems (3-13)
- Separate transmitter and receiver sites—split sites (3-17)
- Installation checks (3-24)
- Setting line parameters (3-26)
- Setting a system backup (3-43)
- Enabling and disabling consoles (3-47)

The 8570 remote control console is referred to as the console, and the 8571 remote control interface is referred to as the interface.

The remote control system may be installed by a competent technician or an approved authority. The land line connecting the console to the interface is installed by the telephone company (Telstra in Australia). Alternatively a 4-wire VHF/UHF radio link may be used.

You can connect a maximum of three consoles in parallel to each land line or radio link, thus providing up to twelve consoles to a remote site.

You should read all relevant parts of this chapter before you begin to install your remote control system.



Checking the equipment supplied

Before you begin to install the equipment, check that you have received all equipment and accessories listed on the packing lists.



Precautions



When you install the system, make sure the console and interface are properly earthed. If the mains is not earthed, you must earth the console independently.

Ensure the interface and the transceiver share the same earth. Use the earth strap provided to connect the two together.



Installing the console—8570

You should install the console in a convenient location that allows for ease of operation and access to mains power and the lines used for the remote control operation.

The steps required to install the console are:

- Connect the console to the power supply
- Connect the console to a land line or a radio link.

Figure 3.1 shows the connectors at the back of the console.

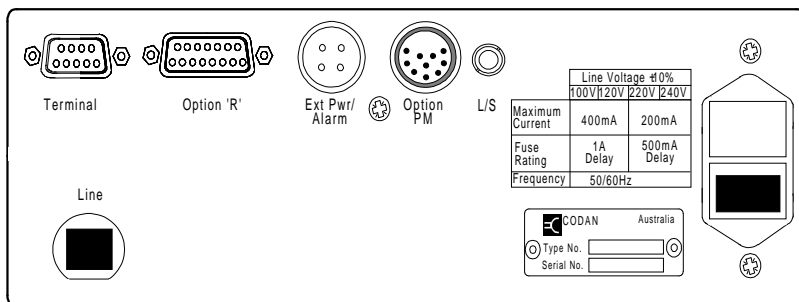

Figure 3.1 Console rear panel connections

You install the console by connecting it to the AC mains and, via a land line or radio link, to the interface.

Connecting the console to the power supply

The console is powered by AC mains through an input module (IEC 320), shown in Figure 3.2. This module includes a fuse holder with two fuses, and a line voltage selector.

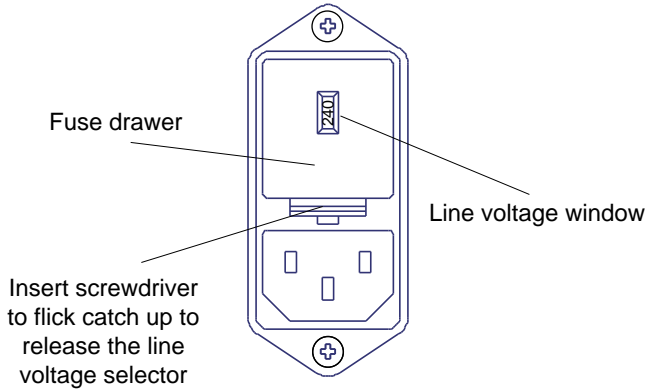

Figure 3.2 AC mains input module

A power cable with an Australian Standard 3-pin mains plug is supplied. Outside Australia you may need to fit an alternative plug or cable.



Ensure that the AC mains voltage setting is correct for the local supply. See Setting the mains line voltage on page 3-5 for details.

Setting the mains line voltage

The console is set for 240 volts unless a different voltage was specified when the console was ordered.

To alter the voltage setting:

1. Remove the fuse drawer.
2. Gently pull the voltage selector insert out and rotate it so that the rating you want is etched on the edge facing you. Selected voltages at 50-60Hz are 100, 120, 220 and 240 volts.
3. Push the voltage selector insert back into position.



Do not force the voltage selector into position. If it is difficult to insert, check that it is not upside down.

4. Check the fuse rating printed on the rear panel of the console to make sure the fuses are still acceptable. If necessary, replace with the following ratings:
 - 500 mA for 220/240 volts
 - 1 A for 110/120 volts.



To prevent electric shock if the internal insulation fails, you must connect the console to an outlet provided with protective earthing. This is especially important in countries where two-pin (unearthed) outlets are commonly used.

The console has an Australian Safety Standards rating of Class I.

External alarm

A connector can be mounted on the rear panel of the console and connected to an external alarm to alert operators that a call has been received. The connection provides contact closure for two minutes after a call is received. The relay contact closure completes the circuit for an external supply source to operate an alarm.

The contacts are rated 50 V DC, 1 Amp.

Connections to the contacts are on pins 2 and 3 of the plug.



Installing the interface—8571

The interface is normally installed close to the transceiver. Standard cables supplied allow the two units to be installed vertically or side by side. If stacked vertically, you can clamp the two units together using an optional 2-unit module clamp (code 121) or with the power supply using an optional 3-unit module clamp (code 122).



If you stack the units vertically, put the transceiver on top to avoid restricting the airflow around the heatsink. Never stack anything on top of the transceiver fins.

Figure 3.3 shows the connectors at the back of the interface.

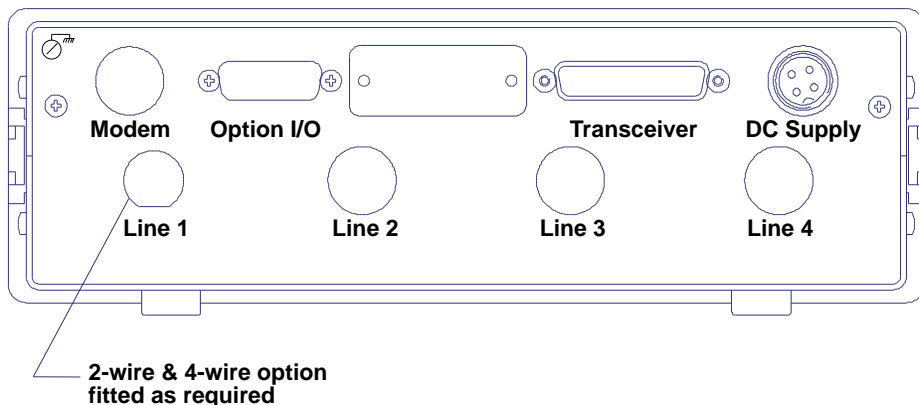

Figure 3.3 Interface rear panel connections

Connecting to power

The interface must be powered by the same DC supply as the transceiver.

If you ordered a 12 volt installation a cable (part no. 08-04159) is supplied to connect the interface DC supply to the transceiver power lead.

If you ordered 24 volt installation a cable (part no. 08-040166) is supplied to connect the interface DC supply connector directly to the 24-volt power supply.



Low voltage circuits are connected to the metal case. Power must be supplied from a battery or Safety Extra Low Voltage (SELV) power supply or approved plugpack. If you plan to use an Extra Low Voltage (ELV) power supply, connect the earth terminal (at the rear top left hand position of the case) to a protective earth. Use an earthing conductor with a cross section area of not less than 2.5 mm².

Connecting to the transceiver

To connect the interface to a transceiver, use the cable supplied (part no.08-04160) to connect the transceiver's 15-pin **Remote Control** connector to the interface unit's 25-pin **Transceiver** connector.



Connecting the remote control system

The instructions to connect the console to the interface assume all power supplies are already connected to the console, interface and antenna units.

The console is connected to the interface by two or four-wire connections.

2-wire

Use a 2-wire land line if the console and interface can be connected by standard telephone lines, or when they are installed in a building with standard cabling. In these installations the console is connected to the land line via an internally fitted line isolation unit (LIU).

4-wire

A 4-wire option can be used to connect the console to a VHF/UHF radio link. Use this option if no wire telephone link exists and a radio link is needed between the console and interface.

2-wire interface connections

For standard 2-wire connections the console and interface both contain a 2-wire private line interface (option 2W), which is an internally fitted isolation unit.

To connect the interface to the console, the FCC-68 modular jacks (labelled 'Line') in the rear access panel of each unit is normally plugged into a wall socket. A wall socket is connected to a telephone jack, one at each end of the land line.

In Australia, suitable cabling is supplied for connecting to a Telstra 611 socket wired for Connection Mode 14. Outside Australia, equipment is supplied with an FCC-68 modular plug-to-plug cable and a universal wall-mounted modular socket.

You can connect up to three consoles to the same line by parallel wiring the wall sockets. When you do this, ensure that only one console is set up for terminating the line. See page 3-28, *Terminating the line*.

4-wire interface connections

For 4-wire sites the console and interface are both fitted with a 4-wire VHF/UHF link interface (option 4W). This provides incoming and outgoing audio paths (transformer isolated) and a PTT (press-to-talk) output—an isolated relay contact—that can be used for keying the link transmitter.

Note: Link transmitters do not normally need to be keyed.

You can connect up to three consoles to the same link by parallel connection of the audio and PTT circuits.

If you are converting your system from a two-wire to a four-wire connection, you will need to enable the line links, as described below.

Disabling the interface line links

The interface circuits can be set up for two or four line connections. The interface is set up at the factory for the appropriate number of lines by adding the correct line interface unit (option 2W for two-wire; 4W for four-wire).

There are provisions for two lines which are either 2-wire or 4-wire. Unused lines should be disabled to prevent signal interference between the interface and any connected consoles.

The lines are disabled by a link on the interface backplane PCB assembly 08-03994, as shown in Figure 3.4. Lines one and two can be disabled by a link fitted to connector P6. Lines three and four (if fitted) can be disabled by a link fitted to connector P105. Refer to the table of link connections on page 3-12.

Note: The card is normally set up in the factory. You will only need to alter this if you add or remove lines.

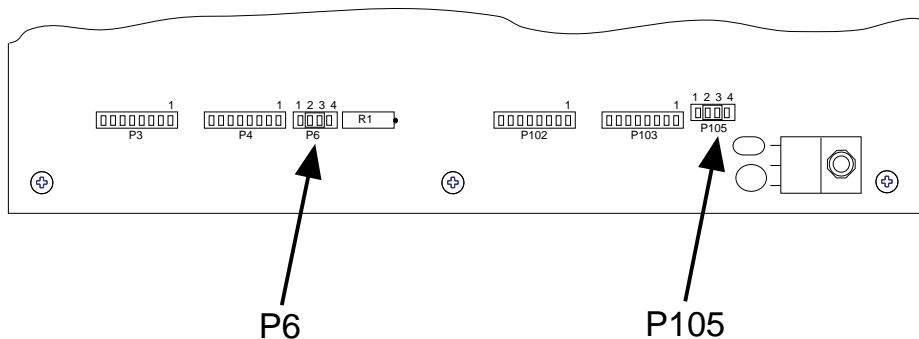

Figure 3.4 Disabling the line link positions

Line Links—8571

Connector P6		
enabled	disabled	jumper pins
line 1	line 2	3-4
line 2	line 1	1-2
lines 1 & 2	none	2-3

Connector P105		
enabled	disabled	jumper pins
line 3	line 4	3-4
line 4	line 3	1-2
lines 3 & 4	none	2-3



Installing single or multiple site systems

If your system has more than one interface each must be set up so that it interprets commands correctly. This is normally done in the factory. Information about these settings is included here for reference.

Each interface has a system configuration selector switch (S1) which is fitted on the Microprocessor and Tcvr Interface PCB Assembly, part number 08-03993 which is located at the top left position when viewed from the front of the interface unit.



Disconnect power to the unit before accessing the switch.

To access the switch remove the front panel and carefully withdraw the PCB assembly.

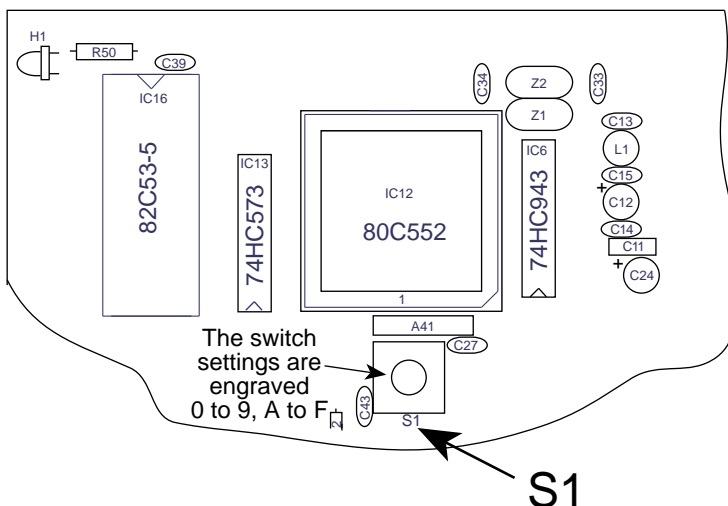

Figure 3.5 System configuration switch

The switch settings are labelled from 0 to 9 and A to F. The switch is normally set at **0** for the basic single site configuration but may be at a different setting for other operating functions.

The possible switch settings are shown below:

System configuration selector switch settings

S1 Pos'n	System configuration	Function
0	Basic single site	Consoles connect to control lines 1, 2, 3 and 4 of this remote interface. The transceiver operating in transmit-receive mode is connected to the interface. Refer to figures 2.2, 2.3 and 2.4.
1	Daisy chain split site—master transmitter	<p>Consoles connect to control lines 2, 3 and 4 of this remote master interface, which is connected to a transceiver operating in transmit only mode.</p> <p>Line 1 of this master interface connects to the slave interface and a transceiver operating in receive mode.</p> <p>If the receiver of line 1 fails, the transmit mode transceiver can also be used as the backup transceiver.* Refer to figure 3.7.</p>
2	Daisy chain split site—master receiver	Consoles connect to control lines 2, 3 and 4 of the remote 'master' interface which is connected to a transceiver operating in receive only mode. Line 1 of this master interface connects to the slave interface and a transceiver operating in transmit only mode. If the transmitter of line 1 fails, the receive mode transceiver can also be used as the backup transmitter.* Refer to figure 3.8.

S1 Pos'n	System configuration	Function
3	Daisy chain/star split site—slave transmitter	<p>Consoles do not directly connect to this remote 'slave' interface which is connected to a transceiver operating in transmit only mode. Line 1 of this 'slave' interface connects to the 'master' interface.</p> <p>If the system receiver fails, the transmit mode transceiver can also be used as the backup receiver.* Refer to figures 3.8 and 3.9.</p>
4	Daisy chain/star split site	<p>Consoles do not directly connect to this remote 'slave' interface which is connected to a transceiver operating in receive only mode. Line 1 of this 'slave' interface connects to the 'master' interface.</p> <p>If the system transmitter fails, the receive mode transceiver can also be used as the backup transmitter.* Refer to figures 3.7 and 3.9.</p>
5	Star split site	<p>Consoles connect to control lines 3 and 4 of this local 'master' interface. Line 1 of the 'master' interface connects to a remote 'slave' interface and transceiver operating in receive only mode. Line 2 connects to a remote 'slave' interface and transceiver operating in transmit only mode.</p> <p>If either the system receiver or transmitter fails, the remaining operating transceiver will assume the backup role operating in both transmit and receive modes.* Refer to figure 3.9.</p>

* For system backup operation the console has to be appropriately programmed to the function 7 setup mode.

S1 Pos'n	System configuration	Function
6, 7, 8, 9, A, B, C & F		Reserved for later use.
D		Resets all settings to default.
E		Equalises all lines connected to the interface.



Basic single site

The transceiver operating in transmit-receive mode may be at a remote site or close to the control station. The transceiver is connected to the interface.

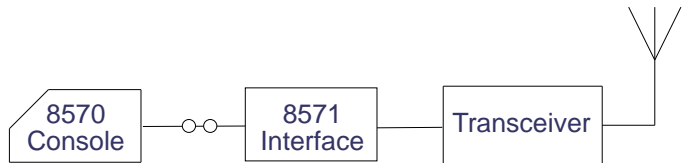

Figure 3.6 Basic single site

The system configuration switch (S1) is set to position **0** for the basic single site system configuration. The switch is on the Microprocessor and TCVR Interface PCB Assembly, part number 08-03993 which is located at the top left position when viewed from the front of the interface unit. To access the switch remove the front panel and carefully withdraw the PCB assembly.

Separate transmitter and receiver sites—split sites

There are three common system configurations for remotely controlled transceivers operating in either transmit only mode or receive only mode. These site systems are:

- daisy chain split site with master transmitter
- daisy chain split site with master receiver
- star split site.

The term ‘daisy chain’ represents the serial connection method 1–2–3 between the control site (console) and the other two sites, with the control station being 1 and with 2 and 3 being either the transmitter or receiver sites respectively. In daisy chain sites, 1 can only communicate with 3 through site 2. The control station is 1, while 2 and 3 are master and slave sites.

Note: For simplicity, the transceiver operating in transmit mode only is called the transmitter, and the transceiver operating in the receive only mode is called the receiver.

Daisy chain split site with master transmitter

Figure 3.7 shows the configuration for a transceiver operating in transmit mode as the master transmitter. The transmitter is connected directly to the control station. The receiver communicates with the control station only through the transmitter site.

In this system the receiver is installed at the remote site. The transmitter may be at a remote site (as shown below) or close to the control station. Numbers shown within a circle in the figures refer to the selected position of the system configuration switch, S1. Refer to *Installing single or multiple* site systems on page 3-13 for details.

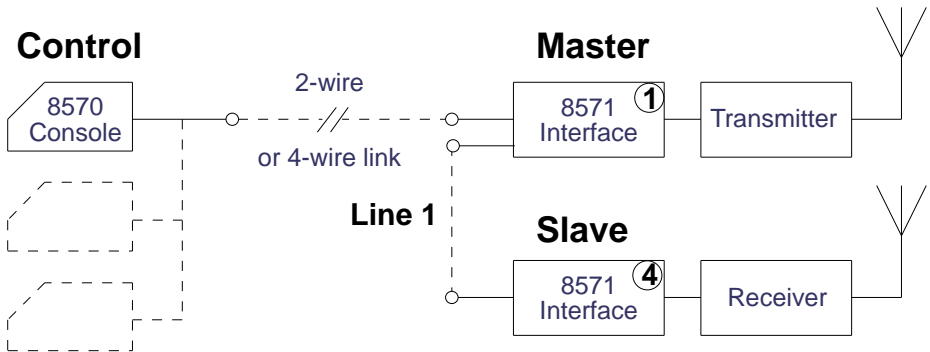

Figure 3.7 Daisy chain split site with master transmitter

The master interface (also called an arbitrator for the role played in the system) will have a minimum connection of two lines. Additional lines will be required if more consoles are used.



The line connecting the master to the slave (commonly known as ‘the split’) must be connected through line 1 of both interfaces.

You can connect system control consoles to lines 2, 3 or 4 of the master interface. The maximum number of control consoles for any daisy chain system is nine, i.e. three consoles connected in parallel to interface lines 2,3 and 4.

Setting the configuration selector switch (daisy chain—master transmitter)

You need to set the configuration selector switch of each interface so that it can identify itself as master or slave. The switch (S1) is on the Microprocessor and Tcvt Interface PCB Assembly, part number 08-03993 which is located at the top left position when viewed from the front of the interface unit. Set the switch as follows:

- *master*—set to position **1**
- *slave*—set to position **4**

See Figure 3.5, *System configuration switch* for the location of this switch.

Note: For split site systems all connected transceivers (operating receivers and transmitters) must not be programmed with a Selcall self address ID. See *Chapter 2, Overview, Selective calling* for more information.

Daisy chain split site with master receiver

Figure 3.8 shows the configuration for a transceiver operating in receive mode as the master receiver. The receiver is connected directly to the control station. The transmitter communicates with the control site only through the receiver site.

In this system the transmitter is installed at the remote site. The receiver may be at a remote site (as shown below) or close to the control station. Numbers shown within a circle in the figures refer to the selected position of the system configuration switch, S1. Refer to *Installing single or multiple* site systems on page 3-13 for details.

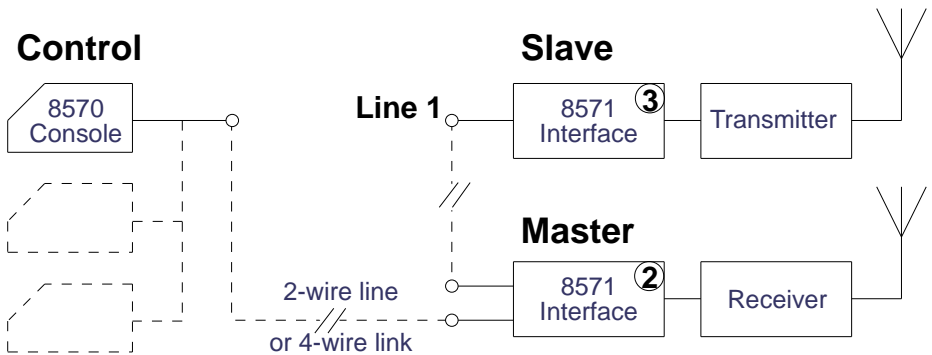

Figure 3.8 Daisy chain split site with master receiver

The master interface will have a minimum connection of two lines. Additional lines will be required if more consoles are used.



The line connecting the master interface to the slave interface (commonly known as 'the split') must be connected through line 1 of both interfaces.

You can connect system control consoles to lines 2, 3 or 4 of the master interface. The maximum number of consoles for any daisy chain system is nine, i.e. three consoles connected in parallel to interface lines 2,3 and 4.

Setting the configuration selector switch (daisy chain—master receiver)

You need to set the configuration selector switch of each interface so that it can identify itself as master or slave. The switch (S1) is on the Microprocessor and Tcvr Interface PCB Assembly, part number 08-03993 which is located at the top left position when viewed from the front of the interface unit. Set the switch as follows:

- *master*—set to position **2**
- *slave*—set to position **3**

See Figure 3.5, *System configuration switch* for the location of this switch.

Note: For split site systems all connected transceivers (operating receivers and transmitters) must not be programmed with a Selcall self address ID. See *Chapter 2, Overview, Selective calling* for more information.

Star split site

Figure 3.9 shows the configuration for a star split site. This configuration uses an additional interface (usually at the control site) to act as an ‘arbitrate master’. The remotely operating transmitter and receiver interface units are both slaves.

Use this configuration when direct lines or links between the two remote sites are impractical and where the required standard grade line length required is greater than 35 kilometres.

In this system the transmitter is installed at the remote site. The receiver may be at the remote site (as shown below) or close to the control station. Numbers shown within a circle in the figures refer to the selected position of the system configuration switch, S1. Refer to *Installing single or multiple* site systems on page 3-13 for details.

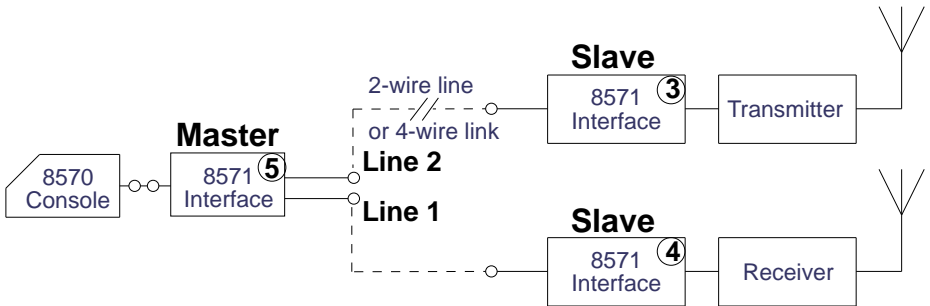

Figure 3.9 Star split site

The master interface will have at least three ‘line’ interface options fitted—2W or 4W—depending on the number of consoles connected.



The lines connecting the master interface to the slave interface units (commonly termed the 'split') must be connected from line 1 of the master to the slave receiver and line 2 of the master to the slave transmitter.

You can connect consoles to lines 3 or 4 of the master. This limits to six the number of consoles in a star configuration system, i.e. three consoles connected in parallel to each line termination to interface lines 3 and 4.

Setting the configuration selector switch (star split site)

You need to set the configuration selector switch of each interface so that it can identify itself as master or slave. The switch (S1) is on the Microprocessor and Tcvr Interface PCB Assembly, part number 08-03993 which is located at the top left position when viewed from the front of the interface unit. Set the switch as follows:

- *master*—set to position **5**
- *slave receiver*—set to position **4**
- *slave transmitter*—set to position **3**

See Figure 3.5, *System configuration switch* for the location of this switch.

Note: For split site systems all connected transceivers (operating receivers and transmitters) must not be programmed with a Selcall self address ID. See *Chapter 2, Overview, Selective calling* for more information.



Installation checks

Refer to the appropriate diagram Figures 2.1 to 2.6 and 3.7 to 3.9 as you install your system. For split site configurations refer to *Separate transmitter and receiver sites (split sites)* on page 3-13. Connect the components using the interface and power cables provided, then check the equipment as follows:

Checking the remote site

1. Switch on the power source.
2. If the transceiver has front panel controls, use the controls to verify that the transceiver operates correctly and that the display is functioning normally.
3. Check that accessories such as antenna tuners are functioning normally.
4. Perform an on-air test to verify the operation of the antenna and RF installation.
5. It is recommended on a new installation or before equalising the lines that the interface line parameters be set to default. To do this:
 - Disconnect power to the interface.
 - Set position of S1 to select D (see Figure 3.5, *System configuration switch* for the location of this switch).
 - Reconnect power to the interface.
 - Wait until the LED flashes at about 1Hz rate.
 - Disconnect power from the interface.
 - Reset switch S1 to the required system configuration, e.g. **0** for basic site configuration.
 - Reconnect power to the interface.
 - Line equalisation can now be carried out from the local site via the console.

Checking the base site

1. Switch on the console and check that the display is working correctly. It displays the software version and issue date and the status of the transceiver.
2. Carry out the line compensation procedure as explained in *Setting line parameters*, from page 3-26.

Note: At this stage, the quality of the received audio and reliability of control signalling may be poor due to the default line compensation settings not matching the line/link characteristics. The following line compensation adjustment procedure should remedy this.



Setting line parameters

The console and interface have DC-controlled gain and equalisation circuits for compensation of the 2-wire line/4-wire link characteristics. The 300 Hz control tone detectors have DC-controlled thresholds which must be adjusted. These parameters are controlled by the microprocessors that generate exchange audio tones.

The compensation procedure is fully automatic, but it must be initiated for each unit in the system. Resulting values are stored in non-volatile EEPROM so that they remain available for re-use each time the power is switched on.

The compensation circuits are designed to cope with typical 2-wire private line characteristics. Some line loss occurs at low frequencies due to wire resistance. Losses increase at higher frequencies due to shunt line capacitance. As a result, the automatic procedure may fail to compensate some installations, such as:

- 2-wire line with built in compensating amplifiers (at the exchange or elsewhere)
Depending on how the compensating amplifiers have been adjusted, this may result in gain rather than loss at some frequencies, or a rising rather than falling frequency response.
- 4-wire VHF/UHF link equipment that has been adjusted for a gain greater than unity, or with an unusual frequency response.

The link must neither clip nor compress the speech signal or control tones.







In both cases successful compensation is normally achievable if the line/link is readjusted for unity gain and a flat frequency response.

To adjust line compensation, you use the remote control console key-pad, as detailed in *Displaying the Line Parameters menu*, page 3-27.

Displaying the Line Parameters menu

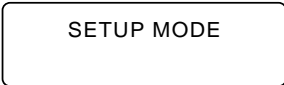
Many instructions in this book require the Line Parameters menu (function 20) to be displayed.

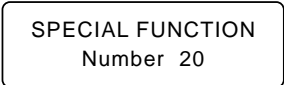
To display the Line Parameters menu:

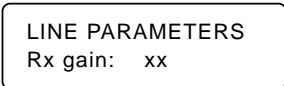

	Action	Notes
1.	Press  to switch off the console.	
2.	Press and hold down the  and  buttons together for approximately 2 seconds to select setup mode.	The display flashes and shows:  Note: the Function button is held slightly before and after the Control On/Off button.
3.	Press  2 0 within 2 seconds to access the <i>Special Functions</i> options.	The display shows: 
4.	Press  to select the <i>Line Parameters</i> menu.	The display shows: 

Resetting line parameters to default settings

To reset line parameters, you need to:

- reset to factory defaults
- terminate each line.

To reset line parameters to factory defaults:



Action	Notes
<p>1. Display the <i>Line Parameters</i> menu.</p>	<p>See <i>Displaying the Line Parameters menu</i>, page 3-27 for instructions.</p>
<p>2. Press  then  buttons to reset line parameters to the factory defaults.</p>	<p>The console beeps and the display briefly shows</p> <div data-bbox="680 786 958 868" style="border: 1px solid black; padding: 5px; text-align: center;"> <p>Menu settings defaulted</p> </div> <p>then returns to the <i>Line Parameters</i> menu.</p>



Repeat the instructions above for each console in your system. Leave the *Line Parameters* menu displayed, ready for the next step.

Terminating the line

Now you need to terminate each line connected to the interface with a terminating resistor. This is done from the console attached to *each* line. If two or more consoles are connected in parallel to the same line, only one console should provide the terminating resistor for the line.

To terminate the line:

Action	Notes
1. Display the <i>Line Parameters</i> menu.	See <i>Displaying the Line Parameters menu</i> , page 3-27 for instructions.
2. Press <div style="text-align: center; margin: 10px 0;">  Review  </div> up or down until the display shows the termination parameter.	The display shows: <div style="border: 1px solid black; padding: 5px; margin: 10px 0; width: fit-content;"> LINE PARAMETERS Termination: on </div>

	Action	Notes
3.	<p>Press</p> <div style="text-align: center;">  Channel  </div> <p>up or down to toggle the termination status between ON and OFF.</p>	<p>If the console is to have a termination, ensure the status is ON (factory default) and that the termination status for all parallel consoles on the same line is OFF.</p> <p>Leave the <i>Line Parameters</i> menu displayed, ready for the next step.</p>





Setting the console configuration

If your system has more than one console connected, each must be configured correctly.

Note: If your system has only one interface, ignore these instructions and go to *Setting line parameters for the interface*, page 3-31.

To set the console configuration:

	Action	Notes
1.	Display the <i>Line Parameters</i> menu.	See <i>Displaying the Line Parameters menu</i> , page 3-27 for instructions.

Action	Notes
<p>2. Press</p> <div style="text-align: center;">  Review  </div> <p>up or down until the display shows the system configuration (cfg) parameter.</p>	<p>The display shows:</p> <div style="border: 1px solid black; padding: 5px; width: fit-content; margin: 10px auto;"> <p>LINE PARAMETERS Cfg: not split</p> </div>
<p>3. Press</p> <div style="text-align: center;">  Channel  </div> <p>up or down to toggle between the options. These are 'not split', 'daisy chain' or 'star split'.</p>	<p>The configuration displayed is selected.</p> <p>Note: 'not split' refers to the basic single site system.</p>

Repeat this procedure for each console in your system.

Leave the *Line Parameters* menu displayed ready for the next step.

Setting line parameters for the interface

You use the *Line Parameters* (function 20) menu again to adjust line compensation. You should have defaulted to the factory settings and terminated all consoles correctly, as described in *Resetting line parameters to default settings* on page 3-28, before you begin this procedure. Perform this procedure for one console *per line*.

Note: You must initiate this procedure from a console with *termination* already set to on.

To set the line parameters for the interface:

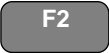
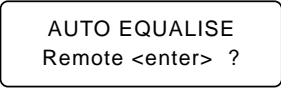
	Action	Notes
1.	Display the <i>Line Parameters</i> menu.	See <i>Displaying the Line Parameters menu</i> , page 3-27 for instructions.
2.	Press  to select the automatic line compensation (equalisation) procedure.	The display shows: 

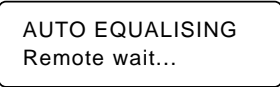
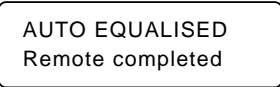
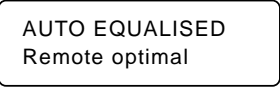
Action	Notes
<p data-bbox="262 220 284 242">3.</p> <p data-bbox="396 220 452 242">Press</p> <div data-bbox="400 277 463 331"></div> <p data-bbox="396 354 613 596">to start the sequence. The compensation procedure is executed by the interface for the line or link connected to it.</p>	<p data-bbox="676 220 874 242">The display shows</p> <div data-bbox="680 264 960 351"></div> <p data-bbox="676 373 1039 587">The F2 indicator light comes on. Other consoles connected in the system will have their setup mode display interrupted by a series of BUSY messages. The F2 indicators on these consoles are also lit.</p> <p data-bbox="676 619 1039 705">The console beeps twice. The F2 light(s) go off and the display shows either</p> <div data-bbox="680 727 960 813"></div> <p data-bbox="676 836 698 858">or</p> <div data-bbox="680 880 960 967"></div> <p data-bbox="676 986 990 1011">depending on line conditions.</p>

Action	Notes
<p>4. If the display shows 'remote failed', or if no result was received, refer to <i>Problems with the 8571 line compensation</i> on page 3-38.</p>	<p>If the procedure fails, the display will show:</p> <div data-bbox="678 296 960 379" style="border: 1px solid black; padding: 5px; margin: 10px auto; width: fit-content;"> <p style="text-align: center;">AUTO EQUALISED Remote failed</p> </div>

5. Press
- F2
- again to return to the *Line Parameters* menu.

Repeat the procedure above for any other consoles connected to the interface over a separate line (lines 2, 3 or 4).

Note: If your system is a basic single site configuration you can now perform line compensation for the console. Turn to *Setting line parameters for the console* on page 3-40.

If your system is a daisy chain or star split site you must now equalise the lines connecting the slave interface to the master interface, described in *Master – Slave interface split systems line configuration*, page 3-35.

Master – Slave interface split systems line configuration

You can carry out this procedure from any console within the system. You only need to do it once.

With the *Line Parameters* menu displayed:

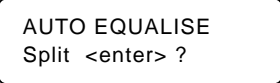
Action	Notes
1. Display the <i>Line Parameters</i> menu.	See <i>Displaying the Line Parameters menu</i> , page 3-27 for instructions.
2. Ensure the configuration setting 'cfg: star split' or 'cfg: daisy chain' is selected.	
3. Press  to select the split line compensation (equalisation) procedure.	The display shows: 

Action	Notes
<p>4. Press</p>  <p>to start the sequence. The compensation procedure is executed by the interface for the line or link connected to it.</p>	<p>The display shows:</p> <div data-bbox="678 264 958 352" style="border: 1px solid black; padding: 5px; margin: 5px 0;"> <p>AUTO EQUALISING Split wait...</p> </div> <p>The F3 light comes on. Other consoles connected in the system have their setup mode display interrupted by a series of BUSY messages. Their F3 lights also come on.</p> <p>(See page 3-37 for a list of messages you will see during this procedure.)</p> <p>The initiating console beeps twice. The F3 light(s) go off and this message is displayed:</p> <div data-bbox="678 798 958 885" style="border: 1px solid black; padding: 5px; margin: 5px 0;"> <p>AUTO EQUALISING Split completed</p> </div> <p>The interface completes the procedure automatically.</p>

During the procedure the following messages are displayed:

star split	Split 25% done	master Rx completed
	Split 50% done	master Tx completed
	Split 75% done	slave Rx completed
	Split completed	slave Tx completed and total procedure completed satisfactorily
daisy chain	Split 50% done	master completed
	Split completed	total procedure completed satisfactorily

If the procedure fails, the display will show:

AUTO EQUALISING
Split failed

In this case, or if no result was received, refer to the troubleshooting procedure in *Problems with the interface line compensation*, on page 3-38.



Problems with the interface line compensation

Possible reasons for the interface line compensation to fail are:

- *line or link connections are not connected or operating properly—check the connections and verify full duplex operation if duplex is used*
- *the line or link characteristics are unusual—check and correct as required, or contact your Codan dealer*
- *line parameters in the interface are not factory default settings—repeat the default procedure described in *Resetting line parameters to default settings*, page 3-28.*
- *more than one console per line has termination switched on*
- *the software in the console and interface is incompatible—contact your Codan dealer.*

If the reason for failure is not obvious or cannot be remedied from the console, perform line compensation from the remote site, as follows:

1. Switch off the power source to the interface.
2. Remove the front panel of the interface.
3. Remove the Microprocessor and Tcvr Interface PCB Assmby, part number 08-03993 which is located at the top left position as viewed from the front of the interface unit.
4. To return all line parameters to factory default settings, set the configuration selector switch **S1** on the PCB to **D**.
5. Replace the PCB assembly and switch the power on.
6. Check that the LED on the PCB flashes (at about 1Hz rate) after the process is completed.
7. Switch the power off and again remove the PCB assembly.

8. Set the configuration selector switch to **E** to enable the compensation procedure to be initiated from the remote site, thus avoiding the need to return to the console.
9. Replace the PCB assembly and switch the power on.
10. Check that the LED on the PCB assembly lights and remains on while line compensation takes place. This procedure is automatic for all connected lines. When the LED flashes on and off at about 1Hz rate, the process is complete.
11. Turn the power off, remove the PCB assembly and reset the configuration selector switch to **0** or the appropriate system setting.
12. Replace the PCB assembly and switch the power on. The interface is now ready for use.

Setting line parameters for the console

From the *Line Parameters* menu adjust line compensation for the console. All setup work described previously must be complete before you begin this procedure.

To set line parameters for the console:

Action	Notes
<p>1. Display the <i>Line Parameters</i> menu.</p>	<p>See <i>Displaying the Line Parameters menu</i>, page 3-27 for instructions.</p>
<p>2. Press</p> <div data-bbox="398 724 508 778" style="border: 1px solid black; border-radius: 10px; padding: 5px; display: inline-block; margin: 10px 0;">F1</div> <p>to select automatic equalisation.</p>	<p>The display shows:</p> <div data-bbox="680 721 984 812" style="border: 1px solid black; padding: 10px; display: inline-block;"> <p>AUTO EQUALISE Local <enter> ?</p> </div>
<p>3. Press</p> <div data-bbox="398 954 463 1008" style="border: 1px solid black; border-radius: 10px; padding: 5px; display: inline-block; margin: 10px 0;">Enter</div> <p>to start the sequence, which continues automatically.</p>	<p>The F1 light comes on. A series of beeps indicates the progress of the procedure.</p>
<p>4. The 300 Hz detector threshold is set.</p>	<p>The display shows:</p> <div data-bbox="680 1256 958 1339" style="border: 1px solid black; padding: 10px; display: inline-block;"> <p>DETECT threshold min [■■■] max</p> </div>

Action	Notes
5. This sets the gain/equalisation stage.	<p>The display shows:</p> <div data-bbox="678 264 960 352" style="border: 1px solid black; padding: 5px; margin: 10px 0;"> GAIN rms = xxx mV min [■■■] max </div> <p>The nominal value of 200 mV is expected. The tone frequency is 300 Hz.</p>
6. Equalisation is adjusted.	<p>The display shows:</p> <div data-bbox="678 564 960 652" style="border: 1px solid black; padding: 5px; margin: 10px 0;"> EQU rms = xxx mV min [■■■] max </div> <p>Equalisation is being adjusted with a 2kHz signal: nominal voltage—80 mV.</p>
7.	<p>The console beeps twice when the process is complete. The F1 light goes off and the display shows either that an accurate compensation was achieved:</p> <div data-bbox="678 963 964 1051" style="border: 1px solid black; padding: 5px; margin: 10px 0;"> AUTO EQUALISE Local optimal </div> <p>or that an acceptable compensation was achieved:</p> <div data-bbox="678 1155 964 1243" style="border: 1px solid black; padding: 5px; margin: 10px 0;"> AUTO EQUALISE Local completed </div> <p>It should be noted that as the line compensation for the interface was successful, the procedure for the console is unlikely to fail unless the forward and return paths of the line or link are not the same.</p>

Action	Notes
8. Repeat the procedure for every console on the system.	
9. When all steps have been successfully completed, switch the console power off.	This exits the setup mode and saves all the settings. When you turn the consoles on again the system will be ready for operation.



Setting a system backup



If your system is a split site configuration, you can set up one of the transceivers to operate as backup transmitter or receiver—as appropriate—if there is an equipment failure. The backup is intended to be used only in emergency situations.







If the receiver is coupled to a receive antenna through a multicoupler, or if it shares the same site with other receivers, it is not recommended that the receiver is setup as a backup transceiver. If it is operated as a transmitter, transmitted RF energy would undoubtedly damage a multicoupler and could severely affect other receivers at the same site.

To allow a console to change backup transceiver modes of operation, put the console in setup mode.



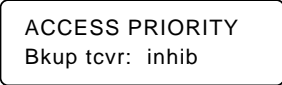
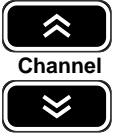

To select the backup transceiver:

Action	Notes
<p>1. To use setup mode, first switch off the console.</p>	
<p>2. Press and hold down</p> <div style="text-align: center;">  and  </div> <p>together for approximately two seconds.</p>	<p>The display flashes:</p> <div style="text-align: center; border: 1px solid black; padding: 10px; width: fit-content; margin: 10px auto;"> <p>SETUP MODE</p> </div> <p>Note: the Function button is held slightly before and after the Control On/Off button.</p>

Action	Notes
<p>3. Press</p>  <p>within 2 seconds to use the access priority menu.</p>	
<p>4. Press</p>  <p>up or down to select the Backup Transceiver enable option.</p>	<p>The display shows:</p> 
<p>5. Press</p>  <p>up or down to select the 'Bkup tcvr: allow' option.</p>	
<p>6. Press</p>  <p>off, then on, to return to normal mode.</p>	

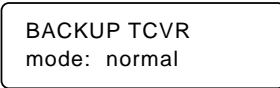
Selecting the backup transceiver operating mode

To select the backup transceiver operating mode:

	Action	Notes
1.	Press  to select the <i>Backup Transceiver</i> menu.	The display shows: 
2.	Press  Channel 	This enables the transmitting or receiving site(Tx and Rx) to operate as a transceiver. Select mode: use Tx to enable receiving at the transmitting site use Rx to enable transmitting at the receiving site normal to remain as originally setup with separate transmitting and receiving sites.
3.	Press  to exit.	You return to setup mode.

If you are using the transmitting site as a transceiver to also receive, the console display indicates this by flashing 'tcvr' in the transmit (Tx) frequency at one second intervals during normal operation. Similarly, if you are using a receiving site as a backup transceiver to transmit 'tcvr' flashes in the Receive (Rx) frequency display.

Note: Actual selection of the backup transceiver mode can be done in either setup mode or normal operating mode.

'tcvr' will only be displayed on consoles that have the backup mode enabled (when backup is selected).



Enabling and disabling consoles

If your system has several consoles, you can set up one console as the master to control the operation of the other consoles (slaves) in the system with the use of the function button **F1**.

To do this, you use special function 31 to set the master console to 'control 8570', and the others to 'disable 8570'.

See *Chapter 6, Setup functions and options*, function 31 of Group 2, for instructions on setting up this procedure.

Normally consoles can perform all operating functions until you press the **F1** button on the master console. If you do this, all except the master console are disabled and can only monitor activity. The master console **F1** button LED is lit to indicate it has taken control. The disabled consoles can use mute and volume controls but no longer have control over channel selection and microphone operation. A message: 'DISABLED' appears on the display instead of the frequency.

To return the slave consoles to normal operating condition, press the master console **F1** button again.



4 Ancillary equipment

This chapter provides information about ancillary equipment which can be used with your remote control system. These are:

- IPC-500 Radio telephone interconnect (4-2)
- 8580 Data modem (4-3)
- 9300 ALE controller (4-14)
- 9001 HF Fax and data interface (4-15)
- 9002 Data modem (4-15)
- Computer (4-16).

IPC-500 Radio telephone interconnect

The remote control system is able to fully support an IPC-500 Radio telephone interconnect unit allowing radio telephone calls to be established. The IPC-500 normally resides at the console end of the system and interfaces with the 8570 Option R facility.

A console will recognise that an IPC-500 is attached and automatically re-configure operation of the **Scan** keypad at every console in the system to initiate IPC scanning. The display on each console in the system can be returned to any console operator by again pressing any **Scan** keypad. This action places a busy condition on the IPC-500. When in the busy condition the IPC-500 will not decode any Selcall received on the channel or answer any incoming telephone calls originating from the telephone exchange that is connected.

The remote control system should be setup for long preamble time. It should also have the Autoscan feature switched on so that the IPC-500 resumes scanning automatically. This should be set to two minutes unless ALE is connected (see the note below).

Operating transceivers 8525 and 8528 in a remote control system with the IPC-500 will require that the scanned channels are programmed as P-channels (P1–P15) for single frequency single channels or P-channels P81–P95 for two-frequency simplex channels.

Both the console and the IPC-500 should be programmed with different Selcall ID's to differentiate incoming calls.

For further details refer to the *IPC-500 Interconnect user guide and installation manual*.

Note: If the remote control system has both 9300 ALE and IPC-500 connected, the Autoscan must be set to off. This ensures that when the IPC-500 is set to Auto the ALE scan is not initiated by Autoscan. This would present a conflict between the two units attempting to control the scan sequence.



8580 Data modem

You can use the remote control system with an 8580 modem to transfer serial data between the console and an interface.

ARQ (Automatic Repeat Request) and FEC (Forward Error Correction) data can be transmitted if you have an 8580 modem. If your network is established with either ARQ, selective or two-tone calling capabilities you can log these calls to either a terminal or printer from the RS-232 port on the console.

Data transmission

You can use the remote control system for reliable, accurate data communication over point-to-point HF links. To do this locate the transceiver, the interface, and the modem at the remote site and locate the console and personal computer or terminal at the operator's local site.

Refer to the *8580 Data modem user guide* for installation and operation.

For the 8580 remote control system to operate the interface must be fitted with option RS and setup in accordance with the following instructions covering:

- Setting the S101 switches (4-4)
- Baud rate—S101 (4-5)
- Parity—S101 (4-6)
- Data width—S101 (4-6)
- Stop bits—S101 (4-7)
- Setting the S102 switches (4-7)
- Interface parameters—S102 (4-8)
- Buffering parameters—S102 (4-9)
- Setting backplane links P303A and P303B (4-10)
- Setting backplane links P304A and P304B (4-11)
- Console software configuration (4-12)

Setting the S101 switches

You must set the S101 switches on the Option RS General Purpose I/O printed circuit board assembly (GPIO)—Part number 08 04644-001—to the correct configuration. The board is located in the top right PCB slot of the interface (viewed from the front). You need to determine the following information from the modem and terminal handbooks before you can set up the PCB to suit:

- baud rate
- parity selection
- data width
- stop bit.

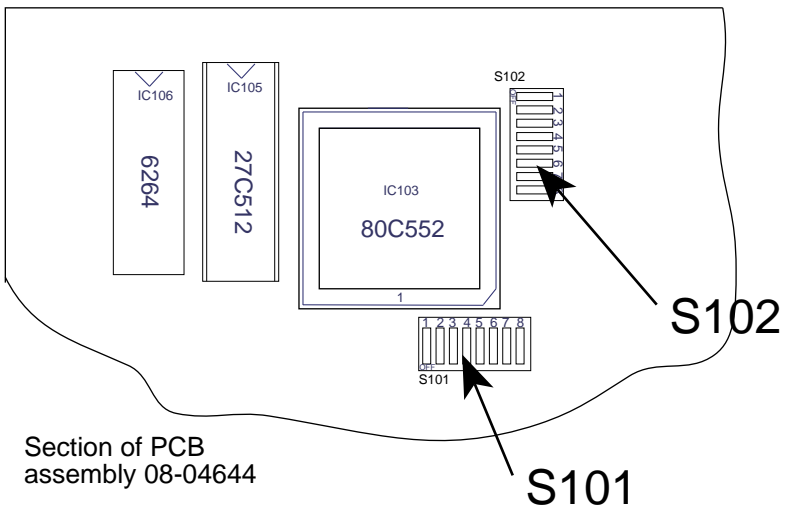

Figure 4.1 Data switch S101/S102 locations

The S101 has eight on/off switches which are numbered from left to right. Refer to the following sections to select the correct configuration.

Baud rate—S101

This is the bit rate in bits per second which can be selected for the interface to communicate with the modem. Switches 1, 2 and 3 determine the baud rate:

Baud rate (bps)	Switch 1	Switch 2	Switch 3
50	off	off	off
300	on	off	off
1200	off	on	off
2400	on	on	off
4800	off	off	on
9600	on	off	on
19200	off	on	on
38400	on	on	on

Parity—S101

Parity provides a simple error detection method by the addition of an error check bit to the end of each serially transmitted word. Switches 4 and 5 determine parity:

Parity	Switch 4	Switch 5
None	off	off
Even	on	off
Odd	off	on
Undefined (none)	on	on

Data width—S101

This parameter controls the length of the word being sent or received. It is determined by switches 6 and 7:

Word length (No. of bits)	Switch 6	Switch 7
5	off	off
6	on	off
7	off	on
8	on	on

Stop bits—S101

Stop bits determine the number of dummy bit periods expected after all data bits are received in RS-232 communication. Set switch 8 as follows:

Number of stop bits	Data width	Switch 8
2	Any	off
1.5	5	on
1	6, 7 or 8	on

Example

The standard set up for an 8570/8571/8580 system using a personal computer as the terminal, for 2400 baud, no parity, 8 bit word length and 1 stop bit is:

Switch 1	Switch 2	Switch 3	Switch 4	Switch 5	Switch 6	Switch 7	Switch 8
on	on	off	off	off	on	on	on

Setting the S102 switches

Switches 1 and 2 are used to set interface parameters. Switches 3 to 6 set the buffering parameters. Switches 7 and 8 are not used.

See Figure 4.1, Data switch S101/S102 locations for the location of this switch.

Interface parameters—S102

The I²C interface parameters are set by S102 switches 1 and 2, as follows:

Interface setting	Switch 1	Switch 2
Slave Rx, Slave Tx, no I ² C interrupt (this is the normal factory setting)	off	off
Slave Rx, Slave Tx, I ² C interrupt when Rx buffer not empty.	off	on
Reserved	on	off
Reserved	on	on

Buffering parameters—S102

Buffering size for $I^2C \rightarrow RS-232$ are set by S102 switches 3 and 4, as follows:

Buffer size (bytes)	Switch 3	Switch 4
32	off	off
128	off	on
1028	on	off
MAX	on	on

The normal factory setting is 1028 bytes.

Buffering size for $I^2C \leftarrow RS-232$ are set by S102 switches 5 and 6, as follows:

Buffer size (bytes)	Switch 5	Switch 6
32	off	off
128	off	on
1028	on	off
MAX	on	on

The normal factory setting is 1028 bytes.

Setting backplane link positions

The backplane printed circuit board (part number 08-3994) is located inside the interface and is the common connection for the other inserted assemblies. You must access this to set up the links on this board before you can use the remote control system with the 8580 modem.

P303A and P303B

For ease of referral the GPIO card inside the interface is termed Data Terminal Equipment (DTE), whereas the 8580 modem is termed Data Communications Equipment (DCE).

Before you can transfer data between the interface and an 8580 modem, you must set the links on the P303A and P303B on the backplane at the DTE position as shown in Figure 4.2, and according to the table on page 4-11. This is because the interface is emulating the terminal connected to the console.

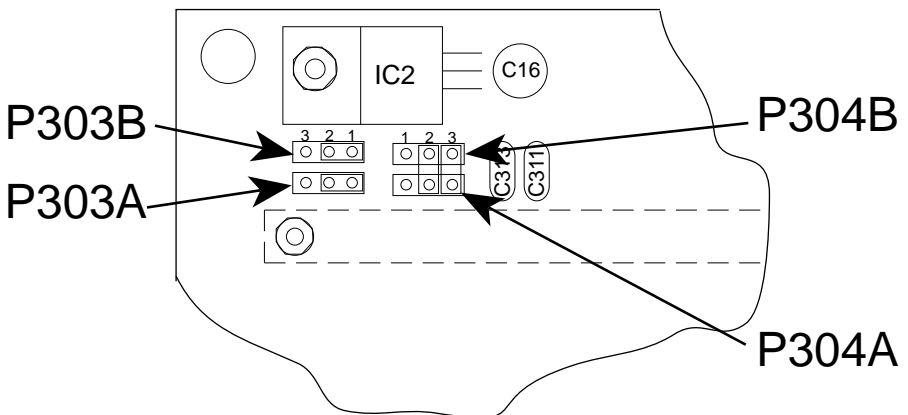

Figure 4.2 Interface RCI backplane data link positions

If you are connecting a terminal to the interface to communicate directly with another terminal connected to the console, position the links at the DCE position.

Connector P303A and P303B

Function	Jumper Pins
DTE	303A/1 – 303A/2 303B/1 – 303B/2
DCE	303A/2 – 303A/3 303B/2 – 303B/3

P304A and P304B

The 8580 modem is normally set up to communicate using RS-232 Xon/Xoff (transmit on/transmit off) software handshaking. RS-232 CTS/RTS (clear to send/ready to send) hardware handshaking will be disabled or turned off.

Make sure that the default link settings on P304A and P304B on the interface backplane reflect the true situation (see Figure 4.2, *Interface RCI backplane data link positions*). If CTS/RTS handshaking is required, position the links according to the table on page 4-12:

Note: Xon/Xoff handshaking is not supported for 5 bit data word length. If this word length is used, you must set the links to CTS/RTS.

Connector P304A and P304B

Function	Jumper Pins
Xon/Xoff	304A/2 – 304B/2 304A/3 – 304B/3
CTS/RTS (DTE)	304A/1 – 304A/2 304B/1 – 304B/2
CTS/RTS (DCE)	304A/2 – 304A/3 304B/2 – 304B/3

Console software configuration

When the hardware is ready, set up the console software. Use the RS-232 Terminal menu (function 30) to do this.

See *Chapter 6, Setup functions and options, RS-232 terminal menu—function 30* for further information on this menu.

To use this menu, ensure the console is in setup mode, then press **Function, 30** and **Enter**.

Use the **Review** buttons to scroll through the options. Use the **Channel** buttons to step between the selections under each option. Use **Enter** to select the displayed option.

You must set the options in this menu to suit the real conditions. An example, for an 8580 modem and terminal, is shown below:

Parameter	Setting
Mode	8580
Bit length	8
Parity	None
Stop bits	1
Baud rate	2400
Handshake	Xon/Xoff

To save your changes, press **Function** again. Exit setup mode by turning the console off then on again.

Note: Make sure only one console in your system is in 8580 mode, because the call structure does not contain individual console addressing information. If more than one console has 8580 enabled, system performance will be unpredictable.

The remote control system system is now ready for data transmission. Follow the instructions in your modem handbook.



9300 ALE Controller

The 9300 ALE Controller simplifies sending calls using Codan transceivers in a remote control system.

Using the 9300 removes the need to send selective beacon calls on different channels to find the best channel to communicate on. The 9300 automatically selects the channel which it has identified as the best operating channel available. It establishes an ALE link with the station you want to call.

In an ALE call, you specify the address of the other station, not the channel.

For single site configuration, the 9300 is connected via a cable to the GP connector located at the rear of the transceiver. For split site configuration, it is installed at the receiver site and connected between the transceiver and the interface using a special cable (Codan part number 08-05180-001).

For setting up the 9300 refer to the *9300 ALE controller user guide*. See also the *8570 and 8571 remote control operators handbook*.



9001 HF Fax and data interface and 9002 data modem

The 9001 provides for the transmission and reception of facsimile and data messages over an HF link. Fully automatic in operation, it can be used to interface data capable 8525/8528 and 9323/9360 transceivers operating with 8570/8571 remote control equipment.

The 9002 provides for data transmission but does not have the facsimile capability.

For installation and operation of the 9001 interface refer to the *9001 HF Fax and data interface user guide* and for the 9002 refer to the *9002 HF Data modem user guide*.

If either the 9001 or the 9002 is used with an 9300 ALE controller it will be necessary to configure the console's RS-232 terminal to 9001/2. Refer to *Chapter 6, Setup functions and options, RS-232 terminal menu—function 30*.

Because there is only one RS-232 port shared by the Terminal and Option PM connectors only one of these connectors can be used at a time. If a 9001 or 9002 is required as well as a computer, an optional RS-232/I²C Interface unit should be connected to the Option R outlet to create an additional RS-232 port for the computer.

Alternatively, if used with an 9300 ALE controller the 9001 or 9002 can be connected to the modem input connector located on the rear panel of the 9300.

The 'Qline' of function 25 must be enabled to 'modem' for operation of either the 9001 HF Fax and data interface or the 9002 HF Data modem. See *Chapter 6, Setup functions and options, Miscellaneous menu—function 25* for information about Qline mode.



Computer

An IBM (or compatible) computer can be connected to the RS-232 terminal input of the console. The RS-232 port must be set up as detailed *Chapter 6, Setup functions and options, RS-232 terminal menu—function 30*, and set to the following parameters:

Mode	CICS
Bit length	8
Parity	none
Stop bits	1
Baud	9600
HShake	none



5 Accessories

This chapter explains how to set up accessories available for use with your remote control system.

This chapter covers:

- ALE split site switch cable (5-2)
- RS-232/I2C Interface (5-2)
- Setting up the inputs and outputs (5-5).

ALE split site switch cable

When an 9300 ALE controller is used in a split site configuration, it must be located with the receiver (transceiver operating in receive mode only).

The FSK data output from the 9300 has to be switched (when it initiates a transmit command) through the interface at the receiver site. It is then switched via land line or radio link to the interface at the transmitter site, and then finally to the transmitter audio input.

A special cable containing the switch circuit connects the transceiver, 9300 ALE controller and the interface at the receiver site. This cable, called the ALE split site switch cable (part number 08-05180), switches the audio input line of the interface from the receiver output to the 9300 FSK transmit output and is controlled by PTT action.

RS-232/I²C Interface

The RS-232/I²C Interface unit is used to provide two additional serial ports for the remote control system. The unit is normally located at the console but it can be connected to the interface or 9323/9360 transceiver.

Serial port number one must be used as a computer interface and serial port number two for a GPS receiver. A maximum of two RS-232/I²C Interface units may be connected to the transceiver or remote control console.

Operation of the RS-232/I²C Interface unit within the remote control system will require setting up as shown under *Setup* on page 5-3 and *RS-232/I²C Interface address* on page 5-4.

Setup

Before using the RS-232/I²C Interface unit it is necessary to configure each port for the GPS and Computer. This is achieved by setting the dip switches located within the box, as applicable.

To gain access to the dip switches located on the PCB it is necessary to remove the single screw securing the back cover (identified by the silk screened title RS-232/I²C Interface) and remove the cover.

Each RS-232 port may be configured with a baud rate using dip switches as shown in the tables below.

Baud rate (GPS)

S1 dip 5 switch	S1 dip 4 switch	Setting
on	on	9600 baud no parity 1 stop
on	off	4800 baud no parity 1 stop
off	on	2400 baud no parity 1 stop
off	off	1200 baud no parity 1 stop

Baud rate (computer)

S1 dip 7 switch	S1 dip 6 switch	Setting
on	on	9600 baud no parity 1 stop
on	off	4800 baud no parity 1 stop
off	on	2400 baud no parity 1 stop
off	off	1200 baud no parity 1 stop

Enabling Ports

S1 dip 1 switch	GPS
on	disabled
off	enabled

S1 dip 2 switch	Computer
on	disabled
off	enabled

Note: Disabling unused ports will reduce data processing time.

RS-232/I²C Interface address

If you have two RS-232/I²C Interface units connected to one transceiver or control console then each unit must be set to a different address. To do this you set S1 dip 3 switch as detailed in the table below.

Note: Either RS-232/I²C Interface can be identified as the first unit.

RS-232/I ² C	S1 dip 3 switch
First unit	off
Second unit	on



Setting up the inputs and outputs (Option GPIO)

If your system software is version 3.50 or later (indicated in the display startup messages), you can use the remote control system with an optional Input/Output (I/O) board fitted within the interface.

A typical use for this feature is to set up the console to provide an output to drive an antenna.

These options are set up by programming the **F1** to **F4** buttons, using special function 31.

See *Chapter 6, Setup functions and options* for instructions on setting up these options.

When you install the I/O board and program the function buttons, the function button LEDs indicate the status of the input or output programmed for the button.

An additional option is known as a ‘bweep’ alarm (a sliding frequency ‘beep’). You set this up using special function 31. If this option is enabled, you hear the alarm every four seconds after an I/O has changed state. The alarm continues for 15 minutes, or until the operator cancels it (by pressing any controller button or the **PTT** button of the microphone).



6 Setup functions and options

This chapter explains how to use the setup functions and programmable options incorporated into your remote control system.

This chapter covers:

- Functions and options available (6-1)
- Viewing the setup functions menus (6-3)
- Using setup mode (6-4)
- Group 0—Console setup options (6-7)
- Group 1—System information options (6-28)
- Group 2—Line setup options (6-32).

Functions and options available

The functions are divided into three groups:

Group 0 *console set up*—used to set up the console

Group 1 *system information*—general setup options for the system as a whole

Group 2 *line set up*—includes function and option menus specific to the line or link connecting the system equipment.

Within each group there are functions that are identified with a number:



	Function	Description
Group 0 (Console setup options)	0	Setting a PIN (password)
	1	General setup options
	2	Access priority options
	3	Set start-up mute
	4	Set display backlight intensity
	5	Enable/disable monitor mode
	7	Backup transceiver setup
Group 1 (System information)	10	Transceiver details
	11	Remote control software details
	14	Local supply voltage
	15	Remote supply voltage
	18	Update channel frequency memory
Group 2 (Line setup options)	20	Line parameters
	21	Line equalisation parameters
	25	Miscellaneous menu
	30	RS-232 terminal menu
	31	Function key setup
	35	RS-232 window
	99	View configuration



Viewing the setup functions menus

You can view the setup functions menus and their options while the console is in normal operating mode.

To view the setup functions:

	Action	Notes
1.	Press	
		
2.	Enter the relevant function number within two seconds and press Enter .	
3.	Press  Review  up or down to scroll through the menu.	

To return to the normal operating display press **Function** again (or leave the keys untouched for one minute, after which time the display resets to normal).

Many of the setup functions described in this chapter cannot be changed while the console is in normal operating mode. To change these, use the console in setup mode.

Using setup mode

You use setup mode to change most setup options, though some options can be changed from normal operating mode, as indicated in the following instructions.

Enter setup mode in one of two ways:

1. If your console incorporates an EPROM of issue 3.10 or later (the version is shown in the opening messages on the console display at switch on). You can enter setup mode by switching the console on while holding down both the **Function** and **Control On/Off** keys for about two seconds.

Note: Only EPROM issue numbers 4.00 and above include support for 9323 and 9360 transceivers.

If your console has a PIN number, after the **Function** and **Control On/Off** keys are held down the display will show 'SECURITY PIN'. Enter the PIN number and press **Enter**.

2. For all consoles you can enter setup mode by fitting a jumper between connector pins located on the Front Panel Display PCB (assembly 08-03978). To access the assembly remove the four screws securing the front panel of the console to the chassis. The connector, shown in Figure 6.1, should be identified and the jumper moved to the SETUP POSITION.

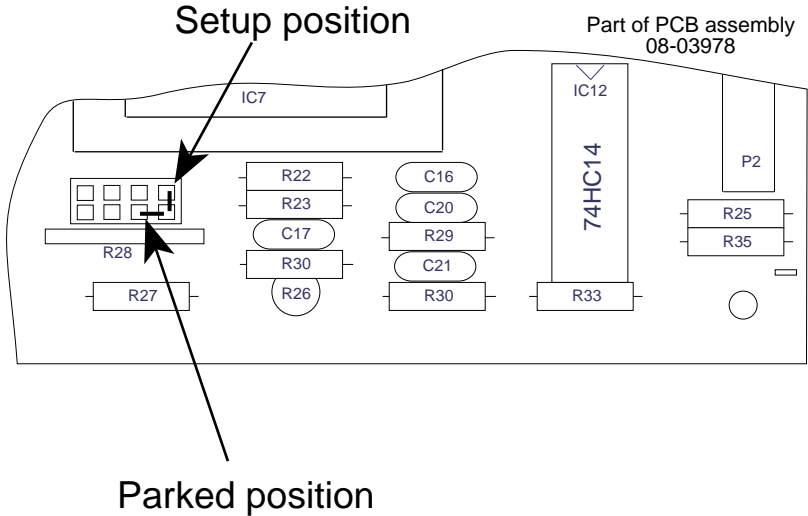

Figure 6.1 Console front panel display PCB setup link

Instead of the normal transceiver display, the display flashes:

SETUP MODE

When in setup mode you can:

- Review the function menus
- Change the functions to suit operating conditions.

Making changes

You make changes to the special functions in the same way regardless of which function or menu you are using. The functions are dealt with in detail in the following sections, but in summary, to change an option:

1. Enter the setup mode as described on page 6-4
2. Press **Function**, then press the relevant function number within two seconds.
3. Press **Enter** to use the selected menu.
4. Press the **Review** keys to scroll through the menu options.
5. Press the **Channel** keys to scroll to the required option setting.
6. When the required setting is displayed, press **Function** again to save it and return to the setup mode opening display.
7. To leave setup mode, switch the console off using the **Control On/Off** key.
8. In consoles where you set the front panel display link jumper to gain access to setup mode, with the console off, return the jumper to the Parked position and replace the front panel and retaining screws.



Group 0—Console setup options

To use the Console setup options, the console must be in setup mode. Refer to *Using setup mode* on page 6-4.

To use these options, press **Function** then the function number and **Enter**. Use the **Review** keys to scroll through the menu options, and the **Channel** keys to scroll through the settings for each option.

Group 0 of the setup functions contains the following console setup options.

	Function	Description
Group 0 (Console setup options)	0	Setting a PIN (password)
	1	General setup options
	2	Access priority options
	3	Set start-up mute
	4	Set display backlight intensity
	5	Enable/disable monitor mode
	6	Selective call test mode
	7	Backup transceiver setup

Setting a PIN (password)—function 0

Use this function to set a security PIN (personal identification number) of up to six digits for the console to prevent unauthorised access. Once you have set the PIN you must enter it each time you switch on the console.





*If you lose the number you will have to return the unit to the factory for re-setting. If you wish to delete your PIN, refer to *Deleting a PIN* on page 6-9.*

Setting a PIN

The console must be in setup mode before you can enter a PIN. For information about setup mode see *Using setup mode* on page 6-4.

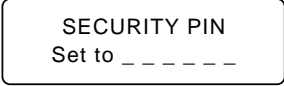
To set a PIN:

Action	Notes
<p>1. Press the keys:</p>  <p>You must press the 0 within two seconds.</p>	<p>The display shows:</p> 
<p>2. Enter the PIN of up to six digits. (Press Delete if you make a mistake during entry.)</p>	<p>The PIN is displayed as you type it in. <i>Make sure the number is correct before you continue.</i> If you forget the number later, the unit must be returned to Codan for re-setting.</p>
<p>3. Press</p>  <p>to store the number and return to the initial setup screen.</p>	<p>The display shows:</p> 

If you fail to complete the process within one minute, the program times out and displays the message:





The initial setup screen is then displayed.

Deleting a PIN

The console must be in setup mode before you can delete a PIN. For information about setup mode see *Using setup mode* on page 6-4.

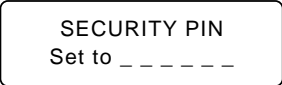
To delete a PIN:

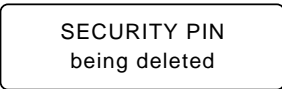
Action	Notes
<p>1. Press the keys:</p>  <p>You must press the 0 within two seconds.</p>	<p>The display shows:</p> 
<p>2. Press</p>  <p>to delete any existing PIN and return to the initial setup screen.</p>	<p>The display shows:</p> 



General setup options—function 1

To access the General setup options the console must be in setup mode. Refer to *Using setup mode* on page 6-4. To use these options, press **Function** then **1** and **Enter**.

Use the **Review** keys to scroll through the menu options, and the **Channel** keys to scroll through the settings for each option.

General setup menu options are:

- ‘intercom identity number’—the console’s intercom address (6-11)
- ‘intercom answer mode’—sets whether connection to the intercom network is automatic or manual (6-11)
- ‘selective call self-identification’—selective calling address the console responds to (6-12)
- ‘selective call called address’—sets an address to be called automatically when you press the **Call** button (6-12)
- ‘s’call preamble length’—short or long for 8525/8528 only (6-13)
- ‘selective call revertive type’—digital or tone (6-13)
- ‘99 beacon’—sets this mode off or on. For systems where this mode must be enabled, see *Sending a ‘99’ beacon call*, in Chapter 4. (6-14)
- ‘autoscan’—sets a time after which automatic scanning begins if no system activity occurs (6-15)
- ‘scan mute’—sets muting to off, pause, hold or selective calling mute for 8525/8528 and IPC 500 only (6-16)
- ‘selcall lockout’—turns Selcall lockout on or off (6-16)
- ‘digits’—sets 4 or 6 digit address (6-17)
- ‘emergency mode’—displays ‘off’, ‘all’ or ‘adr’ to set emergency call self-identification addresses (6-17)
- ‘PTT timer’—sets a timer for interruption of continuous transmission after a set time (6-19)

Details of the menu content and display details are given in the following pages.

If the 'emergency mode'—'adr' option has been programmed the menu listing will now include:

- 'emergency1 ID'—sets the first station self-identification address (6-18)
- 'emergency2 ID'—sets the second station self-identification address (6-18).

Intercom identity number

This is the intercom address for the console. The address can be single or double digit, in the range 00 to 63. The number must be unique to each console in the same system. Use the numeric key-pad to enter the number.

Example of the display:

```
GENERAL SETUP
Intercom ID: 01
```

Refer to *Using setup mode* on page 6-4 for the procedure for making changes.

Intercom answer mode

This function sets the configuration connection when a call is made. There are two options:

- 'auto'—only two rings are given before the console is connected automatically to the intercom network
- 'manual'—eight rings and the console is only connected if the **PTT** button is pressed.

Example of the display:

```
GENERAL SETUP
Intercom: auto
```

Refer to *Using setup mode* on page 6-4 for the procedure for making changes.

Selective call self-identification

This function sets your console's address for selective calling. The console only responds to selective calls made to this address. Use the numeric key-pad to enter the address:

- maximum of 4 digits for 8525/8528 transceivers
- maximum of 6 digits for 9323/9360 transceivers.

Note: Do not use an address ending in 00 or 99. These numbers are reserved for State, All calls and 99 beacon calls.

For split site systems all connected transceivers (operating receivers and transmitters) must not be programmed with a Selcall self address ID. See *Chapter 2, Overview, Selective calling* for more information.

Example of the display:

GENERAL SETUP S'call ID 2525

Refer to *Using setup mode* on page 6-4 for the procedure for making changes.

Selective call called address

This option sets an address to be called automatically each time you press the **Call** key. If you do not set an address you can enter any address when you press **Call**:

- maximum of 4 digits for 8525/8528 transceivers
- maximum of 6 digits for 9323/9360 transceivers.

Example of the display:

GENERAL SETUP S'call addr xxxx

Refer to *Using setup mode* on page 6-4 for the procedure for making changes.

S'call preamble length

This function sets the preamble length. There are two options:

- 'short'—two seconds
- 'long'—six seconds.

You must use a long preamble if you are calling a scanning station. This is applicable for type 8525/8528 series transceiver.

For transceiver type 9323/9360 the preamble length is setup in the transceiver when ALE scan is selected.

Example of the display:

GENERAL SETUP Preamble: long

Refer to *Using setup mode* on page 6-4 for the procedure for making changes.

Selective call revertive type

This function sets the type of selective call revertive sent to a calling station. The revertive can be either:

- 'tone'—the standard revertive type
- 'digi'—digital—only used under special circumstances.

Example of the display:

GENERAL SETUP Revertive: tone

Refer to *Using setup mode* on page 6-4 for the procedure for making changes.

99 Beacon mode

This function sets 99 beacon mode on or off. If your system has software version 3.50 or later, you do not need to enable beacon mode.

With your system enabled for beacon mode, it will transmit a beacon signal on receipt of a selective call ending in 99.

The thousand and hundred digits of the address must be the same for both the beacon transmitting and receiving stations.

If transceivers in a network have the beacon enabled, the first two digits of each transceiver's self-identification address should be set to a different number so that they do not all transmit a beacon response together.

Only the station sending the beacon signal needs to have beacon mode enabled.

Note: The normal Selcall beacon is available at all times and cannot be changed in Setup.

See the *8570 and 8571 Operators handbook, Chapter 4, Sending and receiving calls, Sending a selective beacon call* for more information on beacon calls.

You can select:

- 'on'
- 'off'.

Example of the display:

GENERAL SETUP 99 Beacon: off

Refer to *Using setup mode* on page 6-4 for the procedure for making changes.

Autoscan

This function sets a time after which scanning starts automatically if no system activity occurs. ('Activity' can be key presses, **PTT**, voice traffic, commands, or data transfer mode traffic.) It is good practice to enable autoscan because it ensures the console returns to scan even if you forget to do this.

Scanning is started in S'call mute mode. Time can be set by pressing the **channel** button up or down.

You can select:

- 'off'
- intervals of one minute through to ten minutes.

Example of the display:

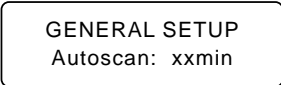

```
GENERAL SETUP
Autoscan: xxmin
```

Refer to *Using setup mode* on page 6-4 for the procedure for making changes.

Scan mute

Scan mute determines the autoscan mute setting for the transceiver. This mute is updated during scanning if system activity has not occurred within the set autoscan period.

The settings are:

- 'off'
- 'pause'
- 'hold'
- 's'call'.

This is available for 8525/8528 and IPC500 only.

Example of the display:

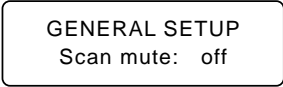

GENERAL SETUP
Scan mute: off

Refer to *Using setup mode* on page 6-4 for the procedure for making changes.

Selcall lockout

This function switches Selcall lockout on or off.

The options are:

- 'on'
- 'off'.

Example of the display:

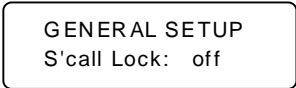

GENERAL SETUP
S'call Lock: off

Refer to *Using setup mode* on page 6-4 for the procedure for making changes.

Digits

This function allows communication with stations whose address is either 4 or 6 digits.

The options are:

- '4 or 6'—to allow 4-digit and 6-digit addresses
- '6 only'—to allow 6-digit addresses only.

Example of the display:

```
GENERAL SETUP
Digits : 4 or 6
```

Refer to *Using setup mode* on page 6-4 for the procedure for making changes.

Emergency mode

This function allows you to set up identification addresses to receive emergency calls.

The options are:

- 'off'—disables emergency mode
- 'all'—receives and responds to all emergency Selcalls
- 'adr'—provides a menu for programming two selected identification addresses received in an emergency call. This is in addition to the console self ident.

Example of the display:

```
GENERAL SETUP
Emergency mode : adr
```

Refer to *Using setup mode* on page 6-4 for the procedure for making changes.

Emergency 1 and 2 (ID)

This option can only be accessed once the ‘adr’ option has been selected and programmed in the *Emergency mode* menu. To enter the Emergency ID enter setup mode of function 1 and scroll through the menu—‘Emergency1 ID’ follows ‘Emergency mode’.

- ‘Emergency1 ID’—sets up the first station self-identification address to be received in an emergency call
- ‘Emergency2 ID’—sets up the second station self-identification address to be received in an emergency call.

Example of the display:

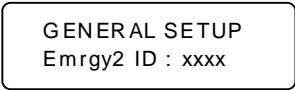

```
GENERAL SETUP
Emrgy2 ID : xxxx
```

Refer to *Using setup mode* on page 6-4 for the procedure for making changes.

PTT timer

This function prevents the transceiver from being left on in the transmit state by mistake.

If the transmit time exceeds the time set for PTT transmit cutout, the transceiver switches to receive and displays an error message.

You can select:

- 'OFF'—transmission never cuts out
- intervals of one minute between 5 minutes and 35 minutes.

Normal operation resumes when the **PTT** button is released. The timer is factory set to 10 minutes.

Example of the display:

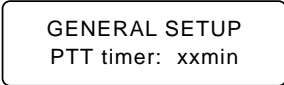

GENERAL SETUP
PTT timer: xxmin

Refer to *Using setup mode* on page 6-4 for the procedure for making changes.



Access priority options—function 2

To use the *Access Priority* menu, the console must be in setup mode. Refer to *Using setup mode* on page 6-4.

Press **Function** then **2** and **Enter** within two seconds to use the menu. Use the **Review** keys to scroll through the menu options, and the **Channel** keys to scroll through the possible settings for each option.

Access Priority menu options are:

- ‘program-P channel inhibits’—governs how P-channels can be changed or deleted and whether frequencies are displayed (for 8525/8528 only) (6-21)
- ‘scan programming enable’—sets whether scan programming is permitted (6-21)
- ‘selective call mute enable’—Selcall mute on/off (6-22)
- ‘backup transceiver enable’—used for split sites to enable backup transceiver mode (6-22)
- ‘monitor audio’—allows access to monitor mode (6-23)
- ‘State call/All call enable’—enables State or All calls, or inhibits both (6-24).

Program P-channel inhibits—for 8525/8528

Four options govern P channel programming:

- ‘std P chan inhib’—existing channels cannot be changed but you can add new ones
- ‘all P chan inhib’—no new P-channels may be programmed or existing ones changed or deleted; this option also disables Tune Rx
- ‘freq display off’—the same as ‘all P chan inhib’, except that transmit and receive frequencies are also not displayed
- ‘no P chan inhib’—P-channels may be programmed normally.

Example of the display:

```
ACCESS PRIORITY
No P chan inhib
```

Refer to *Using setup mode* on page 6-4 for the procedure for making changes.

Scan programming enable

The options are:

- ‘allow’—scan programming is allowed
- ‘inhib’—you cannot enter or change scan programs.

Example of the display:

```
ACCESS PRIORITY
Scan prog:  allow
```

Refer to *Using setup mode* on page 6-4 for the procedure for making changes.

Selective call mute enable

If switched on, selective call mute operates normally for systems that have selective calling. If switched off, the **S'call mute** key is disabled.

The options are:

- 'on'—enables S'call mute
- 'off'—disables S'call mute.

Example of the display:

```
ACCESS PRIORITY
S'call mute: off
```

Refer to *Using setup mode* on page 6-4 for the procedure for making changes.

Backup transceiver enable

This option is specific to separate transmit and receive sites (split sites).

The options are:

- 'inhib'—to prevent backup transceiver mode
- 'allow'—to enable the transmitter or receiver (as applicable) to act as a transceiver in emergencies. With this option selected, program the backup transceiver mode as detailed for function 7 page 6-27.

Refer to *Chapter 3, Installation, Setting a system backup*, for more information.

Example of the display:

```
ACCESS PRIORITY
Bkup tcvr: allow
```

Refer to *Using setup mode* on page 6-4 for the procedure for making changes.

Monitor audio

This option sets the console to allow or inhibit monitoring of other consoles in the system when they are transmitting.

The options are:

- ‘allow’—enables monitor mode
- ‘inhibit’—disables monitor mode.

Example of the display:

```
ACCESS PRIORITY
Monitor: allow
```

Refer to page 6-3 for the procedure to review a function.

Note: If the ‘allow’ monitor mode has been selected, as above, it will be possible for the operator to switch this mode on or off without entering the setup mode. Press **Function, 5** and **Enter** to toggle the mode on/off. See also *Enable/disable monitor mode—function 5* on page 6-26.

State call/All call enable

This option enables State calls or All calls.

A State call signals all stations beginning with the same digit as your self-identification address (that is, up to 1000 stations on the same frequency with addresses, for example, in the range 5000 to 5999). These calls are used for broadcasts to a large group of stations within your network.

An All call allows all stations in the network to be called. (that is, up to 10,000 stations on the same frequency and having addresses in the range 0000 to 9999). These calls are normally reserved for emergencies.

There are three options:

- ‘no State/ALL call’—neither State nor All call is enabled
- ‘State call on’—State call is enabled
- ‘All call on’—All call is enabled.

See the *8570 and 8571 Remote control operator handbook, Chapter 4, Sending and receiving calls, State and All calls* for more information.

Example of the display:

ACCESS PRIORITY
No State/ALLcall

Refer to *Using setup mode* on page 6-4 for the procedure for making changes.

Set startup mute—function 3

This function determines what the mute and audio volume settings are when the console is switched on. It is not necessary to enter setup mode to access this function—it is operator controlled.

The options are:

- ‘mute off’
- ‘audio mute on’
- ‘S’call mute on’.

To set the controls, which is done from normal operating mode, select the required position of the **Mute**, **S’call mute** and **Volume** controls. Then press **Function, 3** and **Enter** within two seconds. The selected operating condition of the controls will now be held in memory and reproduced at switch-on.

Example of the display:

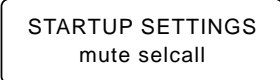

STARTUP SETTINGS
mute selcall

Set display backlight intensity—function 4

This function sets the display backlight level. It is not necessary to enter setup mode to access this function—it is operator controlled.

To access the function mode press **Function, 4** and **Enter** within 2 seconds. Press and hold the **Channel** keys to make the adjustment, then press **Function** to store the setting and return to normal operation.

Note: You can also dim the backlight level while the console is in normal operating mode by pressing the **Recall** key twice within one second. This method is temporary and the setting is lost when you switch off the console.

Example of the display:



Backlight level
adjustment

Enable/disable monitor mode—function 5

It is not necessary to enter setup mode to access this function—it is operator controlled.

When monitor mode is enabled—see also function 2: *Monitor audio* on page 6-23—you can monitor audio from other consoles in the same system when they are transmitting. The mode toggles on/off each time you select **Function, 5** and **Enter**. After two seconds the normal operating display returns and your selection is stored.

Example of the display:

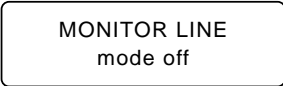

MONITOR LINE
mode off

Backup transceiver setup—function 7

This function is only applicable to split sites, and is used to allow the receiver or transmitter to be used as a normal transceiver when one or the other unit fails. Backup transceiver mode is intended to be used only in emergency situations with its selection indicated by 'TCVR' flashing every second in the transmit or receive frequency display.

It is not necessary to enter setup mode to access this function—it is operator controlled.

The menu has three options:

- 'mode: use Rx'—receiver to be used as a transceiver
- 'mode: use Tx'—transmitter to be used as a transceiver
- 'mode: normal'—used for non-split sites or split sites where the backup transceiver setup is not enabled.

Example of the display:

BACKUP TCVR
 mode: normal

To view the status press **Function, 7** and **Enter** within two seconds and scroll through the options by pressing **Channel**. Press **Function** to save the setting.

Operation of this function should be read in conjunction with function 2: *Backup transceiver enable* on page 6-22.

You can only change the mode if backup transceiver is enabled. See *Chapter 3, Installation, Setting a system backup*.



If the receive only transceiver is coupled to a receiving antenna through a multicoupler, or shares the same site with other receive only equipment, do not select this as the backup transceiver as this will damage the multicoupler and connected equipment. Systems set up in the factory usually have the transmitter disabled to prevent this occurring.



Group 1—System information options

You can view system information options with the console in normal operating mode. These options are view-only—you cannot make changes.

It is not necessary to enter setup mode to access any function in this group—it is operator controlled.

	Function	Description
Group 1 (System information)	10	Transceiver details
	11	Remote control software details
	14	Local supply voltage
	15	Remote supply voltage
	18	Update channel frequency memory

There are three forms of presentation in this group:

- ‘single page’—displays all information available
- ‘multiple page’—displays the first of several ‘pages’ of information
- ‘menu’—displays one of a number of menu items.

The options are displayed in sequence at eight second intervals, or you can scroll through them by pressing the **Review** keys or the microphone **PTT** button.

To use these options, press **Function**, then the appropriate function number and **Enter** within two seconds. Use the **Review** keys to scroll through the menu options, and the **Channel** keys to scroll through the settings for each option.

To return to normal mode press **Function**.

Transceiver—function 10

This function is in a multiple page form that displays transceiver software and hardware details. This includes the transceiver type and EPROM part number (including issue/version number) for example:

Example of the display:

```
Tcvr 8528 V5.40
P/N 90-20278-1
```

whether Land/Marine and enabled TXD/TXE:

Example of the display:

```
Land Version
TxD
```

and Tx and Rx frequency ranges:

Example of the display:

```
Tx 2.00-24.0MHz
Rx 0.25-30.0MHz
```

Refer to page 6-28 for the procedure for viewing options.

Remote control software—function 11

This function is in a multiple page form that displays the console (local) and interface (remote) EPROM part numbers:

```
Loc 8570 V3.50
P/N 90-20368-001
```

and

```
Rem 8571 V3.50
P/N 90-20368-001
```

If the system is set up in a daisy chain split site configuration the 'Rem 8571' display is replaced by multiple page displays of Tx8571 and Rx8571, thus providing EPROM part numbers for both interfaces.

If the system is set up in a star split site configuration an additional page, 'Arb 8571', is included. It provides information on the 'arbitrator' which is the master interface.

Refer to page 6-28 for the procedure for viewing options.

Local supply voltage—function 14

This function displays the console (local) primary power supply voltage.

Example of the display:

Loc supply
voltage = 15.4 V

Refer to page 6-28 for the procedure for viewing options.



If the console is in setup mode and you select function 14, the display will show:

Example of the display:

BACKUP BATTERY
adjust <enter> ?

*You can use the **Channel** keys to recalibrate the voltage measurement. Do not do this unless you have an accurate voltmeter. (If you accidentally select this function when the console is in setup mode, do not enter any value. Wait one minute for the console to return to the setup mode screen.)*

Remote supply voltage—function 15

This function displays the primary supply voltage at the remote site(s). A warning is given if the supply is below 11 V for 12 V systems and 22 V for 24 V systems.

If the system is set up as a daisy chain split site system the 'Rem' supply display is replaced by multiple page displays of Tx supply and Rx supply.

If the system is set up as a star split site system an additional page, 'Arb' supply, is included. It provides battery supply information on the 'arbitrator' which is the master interface.

Example of the display:

<p>Rem supply voltage = 13.6 V</p>
--

Refer to page 6-28 for the procedure for viewing options.

Update channel frequency memory—function 18

This function loads the channel frequencies from the transceiver into the console memory. This enables the channel frequency to be displayed during scanning and allows the operator to step through channels while viewing their respective frequencies.

This information is lost when the console is switched off.

Example of the display:

<p>Chans <input type="checkbox"/></p> <p>98 RX 2200.0</p>

Refer to page 6-28 for the procedure for viewing options.



Group 2—Line setup options

Group 2 of the special functions contains the line setup options. The console must be in setup mode for you to access the functions 20,21,25,30 and 31. It is not necessary to access setup mode for functions 35 and 99—these are operator controlled. Refer to *Using setup mode* on page 6-4 for the procedure for making changes.

	Function	Description
Group 2 (Line setup options)	20	Line parameters
	21	Line equalisation parameters
	25	Miscellaneous menu
	30	RS-232 terminal menu
	31	Function key setup
	35	RS-232 window
	99	View configuration

To use these options, press **Function**, then the appropriate function number and **Enter**. Use the **Review** keys to scroll through the menu options, and the **Channel** keys to scroll through the settings for each option.

See *Chapter 3, Installation* for instructions for setting up these functions.

Line parameters—function 20

To access the line parameters the console must be in setup mode.

To use these options press **Function, 20** and **Enter** within two seconds. Use the **Review** keys to scroll through the menu options and the **Channel** key to scroll through the settings.

The line parameters menu options are:

- Receiver—‘RX gain’
- Receiver Equalisation—‘Rx equ’
- Control tone detector threshold—‘Threshold’
- Line termination resistor—‘Termination’
- System configuration—‘cfg’.

Note: to reset the line parameters it is necessary to return the settings to the factory default. First enter setup mode, press **Enter** then **Recall**. Refer to *Chapter 3, Installation, Resetting line parameters to default setting*.

Receiver (Rx) gain

This parameter allows for setting the overall line gain of the received signal. Its value ranges from 0 to 63, with 63 indicating maximum line gain.

Example of the display:

LINE PARAMETERS
Rx gain: 17

Refer to *Using setup mode* on page 6-4 to for the procedure for making changes.

Receiver Equalisation (Rx equ)

This parameter controls the high frequency equalisation (boost) of the received signal. Its value ranges from 0 to 63, with 63 indicating maximum frequency boost.

Example of the display:

```
LINE PARAMETERS
Rx equ: 0
```

Refer to *Using setup mode* on page 6-4 to for the procedure for making changes.

Control tone detector threshold

This parameter sets the 300 Hz control tone detector sensitivity. Its value ranges from 0 to 63. A value of 63 indicates maximum sensitivity.

Example of the display:

```
LINE PARAMETERS
Threshold: 11
```

Refer to *Using setup mode* on page 6-4 to for the procedure for making changes.

Line termination resistor

This parameter sets the status of the line terminating resistor. It can be on or off. If on, then a resistive load is placed on the line to provide correct termination. This setting is independent of the console being switched on and off.

Example of the display:

```
LINE PARAMETERS
Termination: off
```

Note: Only one console should provide the termination on each line to the 8571 interface. This console should preferably be the furthest from the interface.

Refer to *Using setup mode* on page 6-4 to for the procedure for making changes.

System configuration (cfg)

This parameter determines whether the system is:

- 'not split'
- 'daisy chain'
- 'star split'.

See *Chapter 2, Overview* and *Chapter 3, Installation* for full details of these configurations.

Example of the display:

```
LINE PARAMETERS
cfg: daisy chain
```

Refer to *Using setup mode* on page 6-4 to for the procedure for making changes.

Line equalisation parameters—function 21

This is a multiple page view-only function that displays the threshold, gain and equalisation values for the console (local) and each line connected to the interface (remote).

To access the line equalisation parameters menu the console must be in setup mode. Refer to *Using setup mode* on page 6-4 for the procedure for using setup mode.

To view these options, press **Function, 21** and **Enter** within one second.

Example of the display:

Loc Thr, Gain, Equ
17% 27% 0%

For daisy chain and star split systems the display toggles through 'Loc', 'Tx ln1', 'Tx ln2', 'Rx ln1', 'Rx ln2'.

For a basic single site configuration (not split) the display toggles through 'Loc' and 'Rem lnX' page displays, where X is between 1 and 4, depending on the number of lines fitted.

The values are normalised to the 0 to 100% range, i.e. represented as a percentage of the total range.

Miscellaneous menu—function 25

This menu includes other useful features to customise your console and includes the following options:

- Console messages—‘Messages’
- Qline mode—‘Qline’
- ‘Console ID’
- 4-wire link transmitting transceiver delay—‘Tcvr delay’
- Console command tries—‘Command tries’
- Automatic system update—‘Auto update’.

To access the miscellaneous menu the console must be in setup mode. Refer to *Using setup mode* on page 6-4 for the procedure for making changes.

Console messages

Console messages can be either brief or full. They apply to systems with more than one console. If activity is taking place at another console and this menu parameter is set to brief, the console displays 'BUSY' until the activity ceases. If the parameter is set to full, the console display indicates the nature of the activity taking place.

To change these parameters, press **Function, 25** and **Enter** within two seconds. Use the **Review** keys to scroll through the menu options, and the **Channel** keys to scroll through the settings for each option.

Press **Channel** to toggle between:

- 'brief'
- 'full'.

Example of the display:



MISCELLANEOUS
Messages: brief

Refer to *Using setup mode* on page 6-4 for the procedure for making changes.

Qline mode

The Qline is a *quiet line* parameter used with the 9001 and 9002. This sends a radio function command to the receiver requesting the data mode hardware to be activated and for scanning to pause if activated. It ensures that data transmission overrides voice or selective call activity.

This parameter has three options:

- ‘ignore’—the default setting
- ‘modem’—must be used if a modem is connected to ensure that data transmissions take precedence over voice or selective calls
- ‘mute’—specialised use only.

Example of the display:

```
MISCELLANEOUS
QLine: : ignore
```

Refer to *Using setup mode* on page 6-4 for the procedure for making changes.

Console identification

This is used on systems with more than one console. Each console must have a unique number from 00 to 47. This ID is used to determine console number priorities in the unlikely event of instructions being originated from more than one console at exactly the same time.

Enter the ID number using the numeric key-pad and press **Enter**.

Example of the display:

```
MISCELLANEOUS
Console ID: 00
```

Refer to *Using setup mode* on page 6-4 for the procedure for making changes.

4-wire link transmitting transceiver delay

If the 4-wire link transmitting transceiver is keyed (rather than running continuously) the link PTT delay can be accommodated by this parameter. The value can be from 0 to 400 ms. Enter the required time delay using the numeric keys followed by **Enter**. The value is rounded to 4 mS increments. If an incorrect setting is made press **Delete** and start again.

Example of the display:

```
MISCELLANEOUS
Tcvr delay: 000ms
```

Refer to *Using setup mode* on page 6-4 for the procedure for making changes.

Console command tries

This is the number of times the console is to re-send a command if a response is not received within a certain period of time. If no response is received after this number of tries a request failure is signalled. Valid values are 1 to 5. Enter the number using the numeric key-pad, or use **Channel** to scroll through the values.

Example of the display:

```
MISCELLANEOUS
Command tries: 3
```

Refer to *Using setup mode* on page 6-4 for the procedure for making changes.

Automatic system update

If the line or link is considered unreliable, the transceiver status display can be refreshed automatically after the programmed interval. This parameter sets the number of minutes before refreshing the display, and can be from 5 to 60 minutes, or off.

Example of the display:



MISCELLANEOUS
Auto update: 10m

Use the **Channel** button to scroll through the values. Use **Enter** to select the value. Values below 5 turn updating off. Values above 60 minutes are reduced to 60. If status information fails to return, then an error message is displayed.

Example of the display:

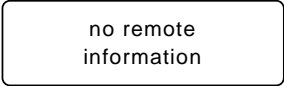

no remote
information

Refer to *Using setup mode* on page 6-4 for the procedure for making changes.

RS-232 terminal menu—function 30

This menu determines the way in which the console's optional terminal port is set up. The terminal port is set up as a DTE RS-232 connection, and you should select parameters to match the connected terminal equipment. Consult with the equipment user manual for the terminal details when setting the port parameters.

The menu options are:

- 'Mode'
- 'Bit length'
- 'Parity'
- 'Stop bits'
- 'Baud' (Baud rate setting)
- 'Hshake' (Handshake).

Enter setup mode and press **Function, 30** and **Enter**. Use the **Review** keys to change between the following displays. Use the **Channel** keys to step between the selections under each menu. To select the displayed value, press **Enter**.

Mode

The following options are available:

- ‘not used’—the default setting—choose this setting if no RS-232 option is fitted or if the port is not required.
- ‘CICS’—select when a computer is connected to the RS-232 Terminal.
- ‘8580’—select when an 8580 modem is connected. Only one per system.
- ‘9001/2’—select when a 9001 Data and Fax or 9002 Data modem is used with an 9300 ALE Controller. Only one per system.
- ‘debug’—select for fault finding data between the console and interface. This is an aid to a service technician.

Example of the display:

```
RS-232 TERMINAL
Mode: not used
```

Refer to *Using setup mode* on page 6-4 for the procedure for making changes.

Bit length

This parameter determines the length of the word being sent or received. It can be from 5 to 8 bits and excludes the parity bit setting. Enter details using the numeric key-pad and press **Enter**.

Example of the display:

```
RS-232 TERMINAL
Bit length: 7
```

Refer to *Using setup mode* on page 6-4 for the procedure for making changes.

Parity

The following options are available:

- ‘none’—the default setting—no parity is generated when sending a character or required when receiving one
- ‘even’—a parity bit is added so that the total word length modulo 2 is equal to 0—a received character is discarded if the parity is incorrect
- ‘odd’—a parity bit is added so that the total word length modulo 2 is equal to 1—a received character is discarded if the parity is incorrect
- ‘all zeroes’ (0’s)—an extra bit of value 0 is added to the word length—the parity bit received is forced to be 0
- ‘all ones’ (1’s)—an extra bit of value 1 is added to the word length—the parity bit is forced to be 1.

Example of the display:

```
RS-232 TERMINAL
Parity: none
```

Refer to *Using setup mode* on page 6-4 for the procedure for making changes.

Stop bits

Stop bits can be 1, 1.5 or 2 bits in length. Use **Channel** to scroll through the values, and **Enter** to select the value.

Example of the display:

```
RS-232 TERMINAL
Stop bits: 1
```

Refer to *Using setup mode* on page 6-4 for the procedure for making changes.

Baud rate setting

This is the bit rate per second at which the console communicates with the connected terminal equipment. It can be 50, 75, 110, 150, 300, 600, 1200, 2400, 4800, 9600, 19200 or 38400. Select the bit rate using **Channel**.

Example of the display:

```
RS-232 TERMINAL
Baud: 9600
```

Refer to *Using setup mode* on page 6-4 for the procedure for making changes.

Handshake

This is used to control the flow of data to and from the 8570 console. The following choices are available:

- ‘none’—no handshaking
- ‘Xon/Xoff’—software handshaking is used for both transmit and receive
- ‘Cts/Rts’—hardware handshaking is used for both transmit and receive
- ‘both’—both Xon/Xoff and Cts/Rts handshaking are used
- ‘pact’—a limited form of hardware handshaking that uses Rts only. This choice is required for interfacing to the Philips PACT 250 teleprinter or a similar teletype machine.

Select the handshake option using the **Channel** button.

Example of the display:

```
RS-232 TERMINAL
Hshake: Xon/Xoff
```

Refer to *Using setup mode* on page 6-4 for the procedure for making changes.

Function key set up—function 31

If your system has software version 3.50 or later, you can use function 31 to set up the four function keys (**F1–F4**) to control specific functions in the radio or optional I/O card. You can program each key to toggle a radio function, an option I/O relay output with a choice of displaying either the option I/O input state or the selected relay output state.

To access the function key set up menu the console must be in setup mode. Refer to *Using setup mode* on page 6-4 for the procedure for making changes.

Example of the display:

```
DEFINE F-KEYS  
F1 : disable 8570
```

The options are:

- ‘disable 8570’—(**F1** key only) console will be disabled when the control console’s **F1** key is pressed
- ‘control 8570’—(**F1** key only) sets this console as a control console that can disable others in the system if required
- ‘ignore’—function key not used
- ‘radio’—causes a selected radio function to occur (toggle)
- ‘output’—provides a current loop that can be used with customised systems to produce a selected output. The LED for the key will show O/P status.
- ‘input’—provides a current loop that can be used with customised systems to respond to a selected input. The LED for the key will show I/P status.

A further option on this menu allows you to set up the input to either a quiet or alarm state. This allows you to select quiet or audio alarm from equipment connected to the **GP I/O** option connector.

RS-232 Window—function 35

You use this option to test the RS-232 communication link. Use the **Channel** or **Review** keys to scroll an ASCII character into the display window.

The character is automatically sent to the serial port when you press these keys. You can re-send the character by pressing any of the keys on the numeric key-pad (**0** to **9**, **Recall** or **Enter**).

Any characters received from the serial port are displayed in a right to left scrolling window on the bottom display line.

It is not necessary to enter setup mode to access any function in this group—it is operator controlled.

Example of the display:

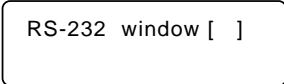

```
RS-232 window [ ]
```

View configuration—function 99

This is a read-only function that allows you to view all the console setup options (functions 1 to 30) in turn. To view, press **Function, 99** and **Enter** within one second. Press **Review** to display the range of console settings.

It is not necessary to enter setup mode to access any function in this group—it is operator controlled.

Example of the display:

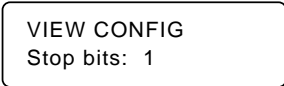

```
VIEW CONFIG
Stop bits: 1
```



7 Appendices

This section contains three appendices:

- specifications for the remote control system (8-1)
- a list of warning and error messages you may see displayed on the console window (8-3)
- options and accessories available (8-8).



Specifications

Feature	Details
AUSTEL Permit No.	A91/19/0129
System operating range (2-wire line)	Greater than 30 km with 0.64 mm diameter copper wire (10 lb line) Greater than 40 km with 0.9 mm diameter copper wire (20 lb line) Range corresponds to maximum line loss of 20 dB at 300 Hz, and 45 dB at 2000 Hz Telstra (Australia) now offer private lines with guaranteed performance levels. The remote control system will operate on standard grade lines Note: 2-wire lines (and radio link) must be duplex operation.
Frequency response	400 to 2500 Hz \pm 3 dB
Signal to noise ratio	Better than 45 dB (excludes line/radio link noise)

Feature	Details																				
Signalling	1070/1270 Hz FSK (part BELL 103) 550 Baud. Parity check and revertive 300 Hz control tone used for signalling and for PTT.																				
Controls	<table border="0" style="width: 100%;"> <tr> <td>Power on/off</td> <td>Audio mute</td> </tr> <tr> <td>0– 9 numeric key-pad</td> <td>Intercom</td> </tr> <tr> <td>Channel ↑ ↓</td> <td>Recall</td> </tr> <tr> <td>Volume ↑ ↓</td> <td>Enter</td> </tr> <tr> <td>Clarifier ↑ ↓</td> <td>Call</td> </tr> <tr> <td>Tune</td> <td>Delete</td> </tr> <tr> <td>Mode—USB/LSB</td> <td>Review ↑ ↓</td> </tr> <tr> <td>Transceiver on/off</td> <td>Special functions—F keys</td> </tr> <tr> <td>Scan</td> <td></td> </tr> <tr> <td>Selcall mute</td> <td></td> </tr> </table>	Power on/off	Audio mute	0– 9 numeric key-pad	Intercom	Channel ↑ ↓	Recall	Volume ↑ ↓	Enter	Clarifier ↑ ↓	Call	Tune	Delete	Mode—USB/LSB	Review ↑ ↓	Transceiver on/off	Special functions—F keys	Scan		Selcall mute	
Power on/off	Audio mute																				
0– 9 numeric key-pad	Intercom																				
Channel ↑ ↓	Recall																				
Volume ↑ ↓	Enter																				
Clarifier ↑ ↓	Call																				
Tune	Delete																				
Mode—USB/LSB	Review ↑ ↓																				
Transceiver on/off	Special functions—F keys																				
Scan																					
Selcall mute																					
Display	Backlit LCD; 2 line x 16 character																				
Power	<p>8570: AC mains—selected 220 or 240 volts ± 10%, 50-60 Hz 125 mA nominal 100 or 120 volts ± 10%, 50-60 Hz 250 mA nominal</p> <p>8571: 12 volt nominal—200 mA (supplied from the transceiver) 24 volt nominal—100 mA (supplied from an external source)</p>																				
Size and weight	<p>8570: 305 mm W x 260 mm D x 120 mm H (3.8 kg)</p> <p>8571: 250 mm W x 320 mm D x 78 mm H (2.5 kg)</p>																				



Display messages

Apart from the normal display of frequencies, the 8570 console displays messages indicating the result of an operation, an error, or a warning message associated with both local and remote status. These messages are usually accompanied by one or more ‘beeps’ to alert the operator.

Satisfactory operation and operator error messages are displayed for five seconds then normal operation resumes automatically. Normal operation will also resume if you press any console key or the **PTT** button within this time.

System error messages remain displayed until the transceiver is switched off and the fault rectified.

Messages and operator errors

This message:	With these beeps:	Means this:
Not tuned	Three	You have tried to transmit before the antenna has been tuned.
Transmit inhibit	Two	You have tried to transmit on a receive-only channel, or while scan mode is selected.
Scan fail	Two	You have tried to select scan mode while the transceiver is transmitting, or before any channels have been entered into the scan program.
Scan program full	Two	You have tried to enter too many channels in the scan program.

This message:	With these beeps:	Means this:
Scan program x N`	None	Displayed with a channel that is in the scan program, and the number of times it has been entered.
No such channel	Two	No Tx or Rx frequencies have been allocated to the channel number selected.
No calls	Two	Calling is not enabled. For example, an emergency call, option TE call, or a selective call has been attempted on a channel where this function is not programmed.
PTT cutout	Four	The microphone PTT has been active for a longer time than that set in the timer.

System error messages

This message:	With these beeps:	Means this:
Frequency unlock	Three	The internal synthesizer in the transceiver is unlocked. All transmission is inhibited and the receiver is muted. If the problem persists, return the transceiver for service.
Antenna tuner problem	Two	The external tuner has not completed a tune operation within two minutes.
No remote	Two	There has been a failure associated with the line/link between the 8570/8571 and the 8570 has entered standby mode.

Supply monitor warning messages

Console local supply

The control console can be powered from a variety of supply sources, derived either from the mains or from standby battery (Option SB).

If the DC voltage to the unit falls below a critical value (such as with a low mains condition or low reserve in the standby battery) a warning message appears on the display. To preserve battery life and prevent erratic performance, the console can switch off automatically.

The following table summarises the events that will occur under specific conditions:

Mains supply status	Internal supply range		Action
ON	greater than	10.0 V	Notes 1 & 7
ON	less than or equal to	10.0 V	Notes 4 & 6
OFF	greater than	11.0 V	Notes 2 & 7
OFF	less than or equal to	11.0 V	Notes 2 & 3
OFF	less than or equal to	10.5 V	Notes 2, 4 & 5
OFF	less than	10.0 V	Notes 2, 4 & 6

Notes:

1. If the mains supply has just been restored, the display backlight will return to the stored setting.
2. If the mains supply has just failed, two ‘beeps’ are given and the message ‘Mains power fail using backup’ is displayed. The display backlight intensity is halved to reduce power consumption.
3. Three ‘beeps’ are given and the message ‘Warning supply voltage low’ is displayed.
4. Three ‘beeps’ are given and the message ‘Warning supply voltage very low’ is displayed.
5. The console switches itself off in 10 minutes.
6. The console switches itself off in 30 seconds.
7. The console switch-off sequence is aborted.

Interface remote supply

The interface can be powered from either a 12 V or 24 V DC source. If the DC voltage to the unit falls below a critical value, a warning message is given on the console's display as shown below:

Internal supply status	Frequency of message	Displayed message
(nom. 12 V)		
< 11.0 V	Every 10 minutes	Remote supply voltage low
< 10.5 V	Every 3 minutes	Remote supply voltage very low
(nom. 24 V)		
< 22.0 V	Every 10 minutes	Remote supply voltage low
< 21.5 V	Every 3 minutes	Remote supply voltage very low

For split site systems (separate transmitter and receiver) the word 'Remote' in the above messages is replaced by 'Transmit' for the transmitter site, 'Receive' for the receiver site, and 'Arbitrate' for the master 8571 in the star configuration.



Options and accessories

Options for the console are listed below:

Option...	Supplied for...
2W	2-wire operation
4W	4-wire operation
FS	Footswitch facility
M	Morse facility
PH	Headphone output
PM	Miscellaneous facilities interface
R	Extended control interface
RS	RS-232 port facility (includes computer interface cable terminated with 9-way connector)
SB	Standby battery—5 hours nominal operation

Options for the interface are:

Option...	Supplied for...
2W	2-wire operation
4W	4-wire operation
ML	3 or 4 line/link capability
RS	RS-232 port facility—includes DC power cable adaptor to interface 8571 with AC power supply and transceiver
GPIO	General Purpose I/O facility

Accessory codes

Code...	Refers to...
121	2-module clamp suitable for locking 8571 with another unit of compatible mechanical design
122	3-module clamp suitable for locking 8571 with two other units of compatible mechanical design
123	4-module clamp suitable for locking 8571 with three other units of compatible mechanical design
164	Rack mounting frame (483 mm) for type 8571
602	Headphones complete with cable and connector
641	Desk microphone complete with cable and connector
649	Extension loudspeaker
652	Morse key complete with base, cable and connector
654	Telephone handset complete with speaker switch, mounting cradle, cable and connector
655	Foot operated PTT switch complete with cable and connector
2038	Service manual for type 8570/8571

Power supplies

Code...	Refers to...
508	Voltage regulator (24 to 12 V operation)
9114	AC power supply, 13.8 V DC regulated. Includes interface cable.

Pin assignment for 4-wire interface connector

Pin No.	Function
1	Balanced audio input from link receiver (input impedance > 3 k Ω)
2	
3	Balanced audio input to link receiver (input impedance > 600 Ω nom)
4	
5	Frame
6	Ground
7	PTT for keying link transmitter (N/O contact 1 A rating)
8	

Pin assignment for 2-wire interface connector

In Australia, the 2-wire interface is supplied with a Telstra type 604 plug wired for modes 12 or 14 (2-wire circuit on pins 4 and 6).

Outside of Australia, the 2-wire interface is supplied with a modular telephone plug (conforming to FCC part 68), and a suitable wall mounted socket. The 2-wire circuit is connected to pins 2 and 5.



Index



—9—		—D—	
99 beacon mode	6-14	daisy chain split site	3-18, 3-20
—A—		data modem	4-3, 4-15
accessories	5-1, 7-8	digits	6-17
ALE controller	4-14	display messages	7-3
ALE split site switch cable	5-2	—E—	
All call	6-24	emergency mode	6-17
ancillary equipment	4-1	error messages	7-3, 7-5
autoscan	6-15	external alarm	3-6
—B—		—F—	
backlight intensity	6-26	function key set up	6-46
backplane link positions	4-10	—G—	
backup transceiver	6-22	general setup options	6-10
backup transceiver setup	6-27	glossary	1-3
base site	3-25	GPS	5-2
buffering parameters	4-9	group call	2-3
—C—		—I—	
computer	4-16, 5-2	installation	3-1
connections	3-9	intercom	6-11
connectors	4-11	interface	2-3, 3-7
console	2-2, 3-3	line parameters	3-30, 3-32
configuration	3-30	parameters	4-8
enabling and disabling	3-47	IPC-500 Radio telephone interconnect	4-2
line parameters	3-40		
messages	6-38		
setup options	6-7		
software configuration	4-12		

	—L—		—R—
line equalisation parameters	6-36	remote control system	3-9
line links	3-11	remote site	3-24
line parameters	3-26, 6-33	RS-232 Terminal	4-12
line setup options	6-32	RS-232 terminal menu	6-42
	—M—	RS-232 window	6-47
master receiver	3-20	RS-232/I2C Interface	5-2
master transmitter	3-18		
messages	7-3, 7-5	—S—	
mode		scan mute	6-16
99 beacon	6-14	Selcall lockout	6-16
monitor	6-26	selective call	2-3, 6-12
mounting options	2-3	mute enable	6-22
multiple control systems	2-5, 3-13	separate sites	2-8
	—O—	setup functions menus	6-3
operating the system	<i>See</i> 8570 and 8571	setup mode	6-4
Remote control operators handbook		software	6-29
options	7-8	specifications	7-1
access priority	6-20	split sites	3-1, 3-17
console setup	6-7	Star split site	3-22
general setup	6-10	startup mute	6-25
	—P—	State call	6-24
PIN	6-7	supply voltage	
power supply	3-4	local	6-30
PTT timer	6-19	remote	6-31
	—Q—	system backup	3-43
Qline mode	6-39	system configurations	2-4
		system information options	6-28
		—T—	
		terminating the line	3-29
		transceiver details	6-29