

No part of this handbook may be reproduced, transcribed, translated into any language or transmitted in any form whatsoever without the prior written consent of Codan Pty Ltd.

© Copyright 1997 Codan Pty Ltd.

Codan part number 15-04082, Issue 1, June 1997

Table of contents

1 About this guide

Standards and icons.....	1-2
Definitions	1-3
Acronyms and abbreviations	1-3
Glossary.....	1-5
Units.....	1-7
Unit multipliers	1-7
About this issue.....	1-8
Associated documents.....	1-8

2 Overview

About HF SSB radio transmission	2-2
Frequency, distance and time of day.....	2-3
Channels.....	2-5
Networks and scanning.....	2-6
Etiquette for the use of HF radio.....	2-7
About the HF SSB Transceiver 9780	2-9
Operating modes	2-10
Standard features.....	2-11
TxE	2-11
Emergency selcall.....	2-11
LU	2-11
Cloning.....	2-11

Types of calls.....	2-12
Controls.....	2-13
The microphone	2-13
The front control panel and extended control head	2-14
Display for Channel mode	2-17
Options.....	2-19
TxD	2-19
Option S.....	2-19
Option ST	2-22
Option D.....	2-23
Option M	2-24
Option AM.....	2-24
Option LF	2-24
Option PH.....	2-24

3 Getting started

Switching on the transceiver.....	3-2
Entering a PIN	3-2
Switching off the transceiver	3-3
Selecting an operating mode	3-4
Adjusting the basics.....	3-6
Adjusting the volume	3-6
Adjusting the brightness of the display using Volume.....	3-6
Adjusting the brightness of the display using Setup	3-6
Adjusting the contrast of the display using Select	3-7
Adjusting the contrast of the display using Setup.....	3-7
Adjusting the loudness of the beeps	3-8
Adjusting the clock	3-9

Adjusting the calibration of the clock.....	3-12
Using Select and Volume to enter information.....	3-14
Viewing the settings that control your transceiver.....	3-15
Selecting the sideband.....	3-16
Tuning the antenna	3-17
Automatic tuning whip antenna	3-17
Long wire with automatic antenna tuner	3-18
Tapped whip antenna.....	3-18
Clarifying the received signal.....	3-19
Using the microphone	3-20
Muting the transceiver.....	3-21
Using Voice Mute while not scanning.....	3-21
Using Voice Mute while scanning.....	3-21

4 Working with channels

Selecting a channel	4-2
Selecting a channel by scrolling through a list of channels	4-2
Selecting a channel by recalling its channel number	4-2
Selecting a channel by recalling its receive frequency	4-3
Enabling/Disabling the ability to recall channels by frequency	4-4
Viewing the options of a selected channel.....	4-6
Creating or editing a channel (TxE).....	4-7
Creating or editing a channel (TxD).....	4-13
Deleting a channel	4-19

5 Working with scan tables

Enabling/Disabling the editing of scan tables.....	5-2
Creating or editing a scan table.....	5-4
Deleting a scan table.....	5-9
Scanning for incoming calls	5-11
Selecting a scan table for scanning	5-11
Responding to an incoming call while scanning (Option S or ST only).....	5-12
Enabling/Disabling automatic scanning	5-12

6 Working with emergency selcalls

Setting up to make an emergency selcall.....	6-2
Making an emergency selcall.....	6-6
Making an emergency selcall using the preset channels.....	6-6
Making an emergency selcall using manual channel selection.....	6-7
Setting up to receive an emergency selcall	6-9
Receiving an emergency selcall.....	6-12

7 Working with voice calls

Making a voice call.....	7-2
Receiving a voice call	7-3

8 Working with Selcall (Option S, ST)

Setting up a selcall group.....	8-2
Setting the selcall address size compatibility.....	8-6
Enabling/Disabling selcall lockout.....	8-8
Adjusting the call preamble	8-10
Making a selective beacon call.....	8-12

Making a selcall 8-14

Enabling/Disabling selcall mute 8-16

 Using selcall mute..... 8-17

Receiving a beacon call 8-18

Enabling/Disabling the response to a 99-beacon call..... 8-19

Receiving a selcall..... 8-21

Reviewing calls held in memory 8-22

 Returning the most recent call..... 8-22

 Returning a call held in memory 8-23

 Deleting a call held in memory 8-25

9 Working with telcalls (Option ST)

Setting up a telephone directory..... 9-2

Enabling/Disabling telcalls..... 9-5

Making a telcall 9-7

Receiving a telcall 9-10

10 Working with status calls (Option D)

Enabling/Disabling the display of local diagnostic
information 10-2

Enabling/Disabling the ability to use status calls 10-4

Enabling/Disabling call privacy..... 10-6

Making a status call 10-8

Receiving a status call 10-13

Using diagnostic information 10-14

11 Other features

Setting the frequency display mode.....	11-2
Changing the power up settings	11-4
Enabling the power up message.....	11-4
Changing the power up mute setting	11-6
Enabling/Disabling the power up address display	11-7
Changing PTT settings	11-9
Enabling PTT release beep	11-9
Enabling and setting the PTT transmit cut out time.....	11-10
Using the transceiver as a free tune receiver.....	11-12
Enabling/Disabling Free Tune Receiver mode	11-12
Setting a receive frequency	11-13
Setting up a tone call group	11-16
Making a tone call	11-18
Cloning a transceiver.....	11-20
Enabling transceiver options using a password	11-22
Finding the ID of your transceiver	11-22
Entering a password.....	11-23
Enabling/Disabling RF gain.....	11-25

Index

List of tables

Table 2-1: HF communication distances	2-5
Table 2-2: Phonetic Alphabet	2-8

List of figures

Figure 2-1: Reflective properties of the ionosphere	2-3
Figure 2-2: Front panel of the 9780	2-14
Figure 2-3: Extended control head of 9780	2-14
Figure 2-4: The display for Channel mode.....	2-17
Figure 2-5: The keypad microphone	2-20
Figure 2-6: Private network for making telephone calls	2-23

Table of contents

1 About this guide

This user guide describes how to use the HF SSB Transceiver 9780.

This guide assumes that you have limited knowledge of the HF communication medium or of how to use a radio.

This user guide contains 11 chapters:

Chapter 1 provides lists of all terms, abbreviations and units used in this guide.

Chapter 2 provides a general overview of HF communication and the range of features available on your transceiver.

Chapter 3 describes basic procedures that you will need to start using your transceiver.

Chapter 4 describes the range of tasks required to manipulate channels on your transceiver.

Chapter 5 describes how to use scan tables.

Chapter 6 describes how to set up your transceiver to make and receive emergency selcalls.

Chapter 7 describes how to use your transceiver for voice calls.

Chapter 8 describes how to use selcalls (Options S and ST).

Chapter 9 describes how to use telcalls (Option ST).

Chapter 10 describes how to use status calls and local diagnostics (Option D).

Chapter 11 describes the other features of your transceiver.

There is an index at the end of this guide.

Standards and icons

The following standards and icons are used in this guide:

This typeface Means

Bold the name of a button, knob or LED and a segment of text from the display

Italic a cross-reference or text requiring emphasis

This icon Means



A step within a task



Warning: It is possible that you will seriously damage yourself or the equipment



Caution: Proceed with caution as your actions may lead to loss of data, privacy or signal quality



Note: The text provided next to this icon may be of interest to you

This text contains cross-references to sections within this book and other books.

A cross-reference to text within the same task will consist of the subheading of the step to which you are referring, e.g. repeat the steps from *Deleting a channel from a scan table*.

A cross-reference to a different task or topic will consist of the page number, followed by the subheading of the task or topic to which you are referring, e.g. see page 2-11, *Standard features*.

When a function button is referred to, the name of the button will be stated followed in brackets by the function given in the relevant field of the display, e.g. **F2(ENTER)** or **F2(PROG)**.

Definitions

Acronyms and abbreviations

This term	Means
AM	amplitude modulation
BBRAM	battery backup random access memory
D	diagnostics
EEPROM	electrically erasable programmable read only memory
EPROM	erasable programmable read only memory
ES	emergency selcall
FSK	frequency shift keying
HF	high frequency
ID	identification number
LCD	liquid crystal display
LSB	lower sideband
LU	choice of upper or lower sideband
NP	not protected
P	protected
PA	power amplifier
PIN	personal identification number
PSTN	public switched telephone network
PTT	press-to-talk
RAM	random access memory
RDD	radphone direct dial

This term	Means
RTC	real time clock
Rx	receive
S	selcall
SEE	see SEEPROM
SEEPROM	serial electrically erasable programmable read only memory
SLO	selcall lockout
SSB	single sideband
ST	selcall/telcall
Tx	transmit
TxD	transmit frequency programming disabled
TxE	transmit frequency programming enabled
USB	upper sideband
VCO	voltage controlled oscillator

Glossary

This term	Means
address	This is the number of your transceiver. It is the radio equivalent of a telephone number. With Option S or ST, if someone wants to call you directly, they enter this number and send the call. This term is used interchangeably with ID.
automatic tuning whip antenna	This is a whip antenna designed for use with multi-channel transceivers. It uses a micro-controlled stepper motor to give continuous tuning over the operating frequency range of the transceiver.
broadband antenna	This is an antenna that is capable of receiving and sending a range of frequencies without having to tune the antenna each time the frequency changes.
channel	A label for a frequency.
channel comment	This is an optional description of the use of a channel. It appears at the top of the display for Channel mode.
channel frequency	This is the frequency of the selected channel.
channel number	This is the identification number given to a channel.
control cable	A cable connecting two items of equipment that allows control information to be passed between the equipment.
extended control head	A control device that is remotely attached to the transceiver unit. It performs exactly the same function as the front control panel of the transceiver unit. Its primary use is in situations where the control device and transceiver unit cannot be located together.

This term	Means
fixed base station	This is a permanent station. It cannot be moved without some preparation. Its antenna may be a broadband antenna.
frequency	The frequency of a radio wave is the number of oscillations per second of the generated or received signal.
front panel	A control device that is attached directly to the transceiver unit.
FSK calibration	Frequency Shift Keying is the modulation technique used in making selcalls and telcalls.
ID	<p>This is the number of your transceiver. It is the radio equivalent of a telephone number. With Option S or ST, if someone wants to call you directly, they enter this number and send the call. This term is used interchangeably with address.</p> <p>ID may also refer to the 14 digit identification number of your transceiver.</p>
Link Setup mode	This is a special mode that is accessed by repositioning a link within your transceiver. It provides access to setup functions that are only used in special circumstances.
mobile station	This is a station that can function while it is mobile or can be moved readily.
network	This consists of two or more stations that communicate on the same frequencies.
Setup mode	This mode allows you to set up your transceiver according to your requirements.
station	A station consists of a power supply, a transceiver, an antenna, ancillary equipment and appropriate connecting cables.

Units

Measurement	Unit	Abbreviation
Current	amp	A
Distance	metre	m
Frequency	hertz	Hz
Power	watt	W
Power ratio	decibel	dB
Voltage	volt	V

Unit multipliers

Unit	Name	Multiplier
M	mega	10^6
k	kilo	10^3
d	deci	10^{-1}
c	centi	10^{-2}
m	milli	10^{-3}
μ	micro	10^{-6}

About this issue

This is the first issue of the HF SSB Transceiver 9780 User Guide.

Associated documents

This user guide is one of a series of publications related to the HF SSB Transceiver 9780. Other associated documents are:

- HF SSB Transceiver 9780 Reference Manual (Codan part number 15-04083)
- HF SSB Transceiver 9780 Quick Reference Card (Codan part number 06-01884)
- HF SSB Transceiver 9323/9360/9390/9780 Technical Service Manual (Codan part number 15-02051)

2 Overview

This chapter provides an overview of:

- HF radio transmission, describing the factors that will affect successful communication (2-2)
- etiquette for the use of HF radio (2-7)
- the transceiver and the range of standard features (2-9)
- the control of the transceiver (2-13)
- the display of the transceiver (2-16)
- the range of optional features (2-18)

About HF SSB radio transmission

The High Frequency (HF) band is the range of frequencies between 3 to 30 MHz. HF radios usually include a frequency range of 2 to 30 MHz.

Single Sideband (SSB) is the term used to describe the method of compressing the transmitted information, voice or data, into a more compact signal. This has the benefit of reducing the power required to send a signal over a certain distance. This form of transmission uses only half of the radio bandwidth that AM radios use (double sideband). Since only one sideband signal is transmitted, SSB allows more channels for communication within the HF spectrum.

HF SSB radios are primarily used for long range communications where distances of 3000 km and more are possible. Obstructions such as buildings and mountains have little effect on long range communications. HF radio can cover such large distances because of the way that the transmitted radio signal propagates.

HF radio waves are propagated in three ways simultaneously:

- ground wave
- direct wave
- sky wave

Ground wave

The ground wave travels near the ground for short distances, typically up to 100 km over land and 300 km over sea. The distance covered depends upon operating frequency, transmitted power and type of terrain.

Direct wave

The direct wave travels in a direct line-of-sight from the transmitter to the receiver.

Sky wave

The sky wave is the most important form of HF propagation. The radio wave is transmitted toward the sky, where it is reflected by the ionosphere to a distant receiver back on Earth.

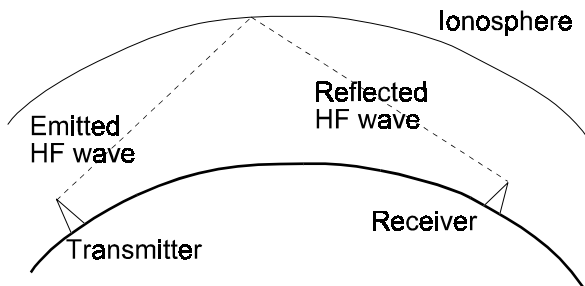

Figure 2-1: Reflective properties of the ionosphere

The reflective properties of the ionosphere change throughout the day, from season to season and yearly.

Frequency, distance and time of day

The amount of reflection of the radio wave will depend upon the frequency used. If the frequency is too low, the signal will be absorbed by the ionosphere. If the frequency is too high, the signal will pass straight through the ionosphere. Within the HF band, low frequencies are generally considered to be in the range 2 to 10 MHz. High frequencies are above 10 MHz.

A frequency chosen for daytime transmission may not necessarily be a suitable frequency for night-time use. During the day, the ionosphere has many layers. These layers absorb lower frequencies and reflect higher frequencies. At night, the ionosphere becomes very thin. The low frequencies that were absorbed during the day will now be reflected. The high frequencies that were reflected during the day will now pass straight through the ionosphere.

Summer HF communications usually operate on higher frequencies than those used in winter over the same distance.

Solar activity varies over an eleven year cycle with the peak of activity requiring the use of higher frequencies.

It is important to remember that you may need to change the frequency to achieve the best communication. It is usual practice to provide three or four channels per network to give a frequency spread to suit all conditions throughout the day.

The general rules of thumb for HF communication are:

- the higher the sun, the higher the frequency
- the further the distance, the higher the frequency

Use the following table *as a guide only* to HF communication distances. Actual performance will vary depending upon conditions.

Table 2-1: HF communication distances

Frequency (MHz)	Range (day) (km)	Range (night) (km)
3	150	250
5	500	700
7	1100	1500
9	1800	2000
11	2200	2700
13	2800	3500
15	3300	4000
17	4000	4800

Channels

A channel is a label given to a frequency. The frequency may be any frequency within the HF range. The channel will also have a sideband and other properties nominated by the user.

For example:

Channel	Frequency (kHz)	Sideband	Protection
1	2500	USB	P
3	2500	LU	NP
12	7580	USB	P

Networks and scanning

If you are using your transceiver as part of a network, there will be a range of frequencies allocated to your network. These frequencies will cover the frequencies required to maintain HF communication throughout the day.

Your transceiver comes fitted with the ability to scan a range of frequencies.

In order to maintain the opportunity to receive communication from others in your network, it is recommended that you set your transceiver to scan when you are not using the transceiver of conversing.

Etiquette for the use of HF radio

There is a standard procedure for communicating over the radio.

When you first establish communication with the other party, it is customary to state their callsign, then your own. For example:

"Alpha Bravo One, this is Alpha Bravo Two. Do you receive me? Over."

In this situation, you are calling a party with callsign AB1. Your callsign is AB2 (see Table 2-2 for an explanation of the phonetic alphabet).

The word "Over" is used to signify the end of your transmission. You may also set up your transceiver to beep for you when you release **PTT** (see page 11-9, *Enabling **PTT** release beep*). When your conversation with the other party is finished, the final speaking party should say "Out".

Before transmitting, listen to the channel that you are going to use. Ensure that there is no voice or data communication taking place. Wait until the channel is clear or select another channel.

Swearing or foul language should not be used—heavy penalties can apply.

Keep communications as short as possible.

Table 2-2: Phonetic Alphabet

Letter	Word	Letter	Word
A	Alpha	N	November
B	Bravo	O	Oscar
C	Charlie	P	Papa
D	Delta	Q	Quebec
E	Echo	R	Romeo
F	Foxtrot	S	Sierra
G	Golf	T	Tango
H	Hotel	U	Uniform
I	India	V	Victor
J	Juliet	W	Whiskey
K	Kilo	X	X-Ray
L	Lima	Y	Yankee
M	Mike	Z	Zulu

About the HF SSB Transceiver 9780

The transceiver is available with either front panel control or with an extended control head using a separate loudspeaker. It can also operate in a multi-control system consisting of a front control panel and up to three extended control heads. The transceiver is designed for fixed base and mobile installations.

The control panel features 10 buttons (sealed membrane switches), two knobs and a Liquid Crystal Display (LCD). The display for Channel mode shows the operating status of the transceiver, including channel number, frequency, channel option settings and channel comment. There is a bar graph indication of the transmit and receive signal strengths.

The transceiver can be programmed with up to 15 channels.

The transceiver has the ability to disable the Setup menu (refer to HF SSB Transceiver 9780 Reference Manual Chapter 4, *Turning Setup mode availability on and off*). If this ability has been disabled, you will not be able to perform any of the set up functions or reconfigure your transceiver.

Operating modes

The transceiver has six operating modes:

- Channel mode
- Clarifier mode
- Channel Options mode
- Free Tune Receiver mode
- Setup mode
- View All Settings mode

Channel mode is used most frequently during normal operation.

Clarifier mode is used to adjust the audio signal when receiving, to compensate for frequency shifts (see page 3-19, *Clarifying the received signal*). This can improve the quality of the audio output.

Channel Options mode allows you to view the options for a particular channel (see page 4-6, *Viewing the options of a selected channel*).

Free Tune Receiver mode allows you to use your transceiver to receive a frequency that is not programmed on a specific channel (see page 11-12, *Using the transceiver as a free tune receiver*).

Setup mode is used to configure the transceiver in the way that you want it to operate.

View All Settings mode is used to view all of the settings that control your transceiver (see page 3-15, *Viewing the settings that control your transceiver*). It summarises the options that are fitted and the options that you have tailored to suit your needs.

Standard features

Your transceiver comes fitted with a range of standard features:

- programming of transmit frequencies (TxE)
- emergency selcall
- choice of upper or lower sideband (LU)
- cloning

TxE

TxE means "transmit enabled". It allows you to program transmit frequencies on your transceiver. In some countries, licensing authorities do not allow programming of transmit channel frequencies. In these cases, radios will be fitted with Option TxD or "transmit disabled" (see page 2-18, *TxD*).

Emergency selcall

An emergency selcall is a simple and automatic way of calling any station in an emergency. The ringing tones are like a siren.

LU

This feature allows you to program either upper or lower sideband on a particular channel. When you use a channel with this setting, you will be able to switch between USB and LSB by pressing **USB/LSB**.

Cloning

The cloning feature allows you to copy frequencies and settings from one transceiver to another. This is useful if you are managing a network of transceivers that you want to set up in the same way.

Types of calls

An emergency selcall is a simple and automatic way of calling any station in an emergency.

A voice call is the simplest type of call to make. Your call can be heard by any station tuned to or scanning your current channel. However, due to the nature of HF radio waves, the success rate of establishing communications with the desired party using voice call only may be low. Successful establishment of communication with a particular party is greatly enhanced with the use of selcall (see page 8-1, *Working with selcalls*).

A tone call allows you to call a station that is capable of recognising your two tone calling signal. Tone calls are used in some networks to allow mobile operators to alert base station operators.

Controls

The microphone

Your microphone has only one button on it, the press-to-talk or **PTT** button located on the side of the microphone. The microphone socket is the main socket on the front panel or extended control head.

If you have purchased Option PH, there will be another smaller socket on the front panel directly above the microphone socket (see page 2-23, *Option PH*).

If you have purchased Option S or Option ST you will have a microphone with a keypad (see page 2-18, *Option S*).

The front control panel and extended control head

The transceiver can be controlled by either the front control panel or the extended control head.

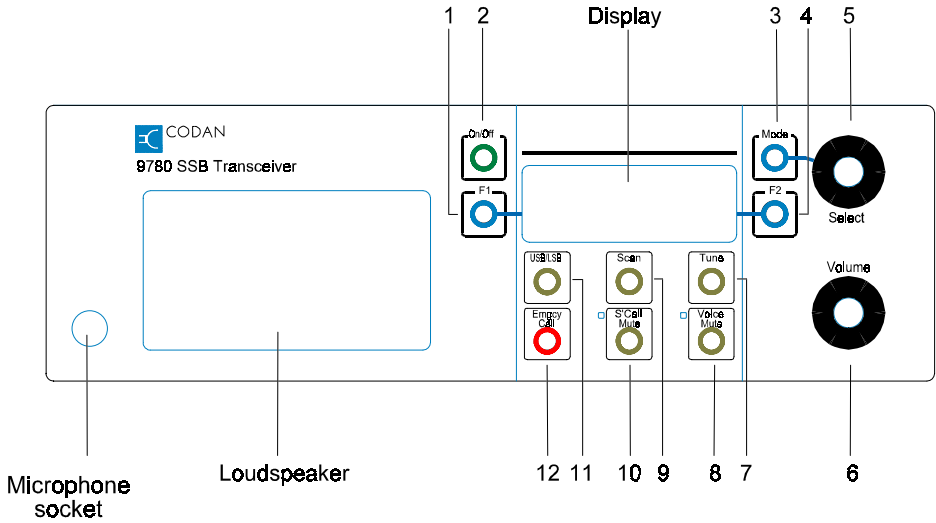

Figure 2-2: Front panel of the 9780

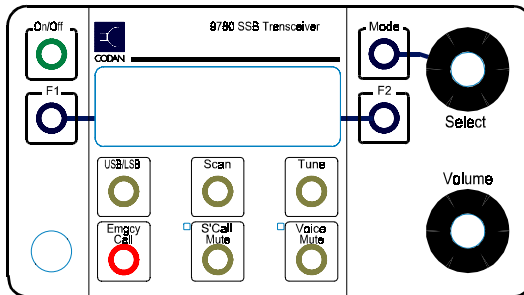

Figure 2-3: Extended control head of 9780

No.	Button/knob	Function
1	F1	Performs the operation stated in the F1 field of the display (see page 2-16, <i>Display for Channel mode</i>)
2	On/Off	Switches on or off the power to the transceiver
3	Mode	Used to cycle between the operating modes of the transceiver (see page 3-4, <i>Selecting an operating mode</i>)
4	F2	Performs the operation stated in the F2 field of the display (see page 2-16, <i>Display for Channel mode</i>)
5	Select	Used to select channels and enter information (see page 3-14, <i>Using Select and Volume to enter information</i>)
6	Volume	Used to change the volume and enter information (see page 3-14, <i>Using Select and Volume to enter information</i>)
7	Tune	Tunes an automatic tuning whip antenna to the frequency of the selected channel
8	Voice Mute	Removes normal background noise when there is no audio signal
9	Scan	Switches on and off the scanning of channels in a scan table
10	S'call Mute	Removes normal background noise until a selcall is received
11	USB/LSB	Selects upper or lower sideband, if available for the selected channel
12	Emgcy Call	Makes an emergency call

Display for Channel mode

The display for Channel mode consists of 10 fields that provide you with information on the current status of your transceiver.

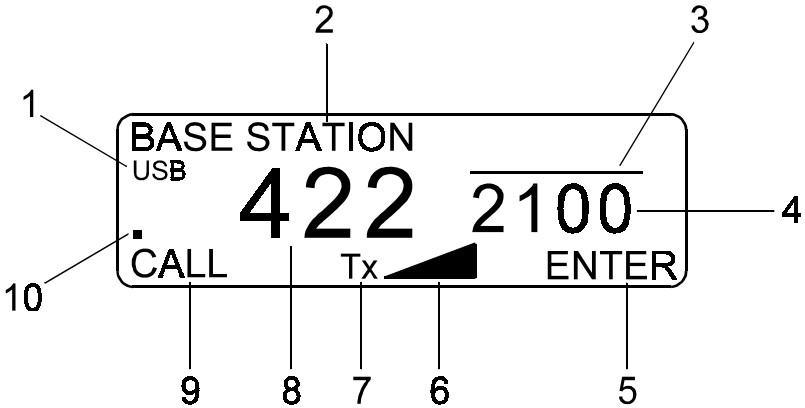

Figure 2-4: The display for Channel mode

No.	Field	Function
1	Sideband	Shows the sideband option selected for this channel
2	Channel Comment	Shows a description of the use of the channel (optional)
3	Receive Bar	Indicates that the channel is a receive-only channel; if the bar does not appear in this field, then you can transmit on this channel
4	Channel frequency	Shows the transmit or receive frequency (kHz) of the current channel
5	F2	Indicates the current function of the F2 button next to the bottom right of the display

No.	Field	Function
6	Signal Strength	Indicates the strength of the signal being transmitted or received
7	Tx/Rx	Indicates whether the transceiver is transmitting or receiving
8	Channel Number	Shows the channel number of the current channel
9	F1	Indicates the current function of the F1 button next to the bottom left of the display
10	Channel Protection	Indicates that the channel is unprotected; if the current channel is protected, this field will be empty

In non-channel modes the display will show information that is relevant to the task you are performing. This information will be discussed in the context in which it is used.

Options

The following options are available:

- programming of transmit frequencies disabled (TxD)
- Option S—selcall including selcall lockout
- Option ST—selcall including selcall lockout and telcall
- Option D—status calls and local diagnostics
- Option M—morse code
- Option AM—AM transmission
- Option LF—extension of lower frequency range to 1.6 MHz
- Option PH—headphones

TxD

This option disables the programming of channels with new transmit frequencies and prevents deletion of protected channels. If you edit a transmit channel and change its frequency, it automatically becomes a receive-only channel.

Option S

Option S allows you to make or receive selcalls. You can call a station in a similar manner to making a regular telephone call. You will need to know the selcall address of the station that you want to call and have channel frequencies in common with that station.

If you have purchased Option S you will have a microphone with a keypad.

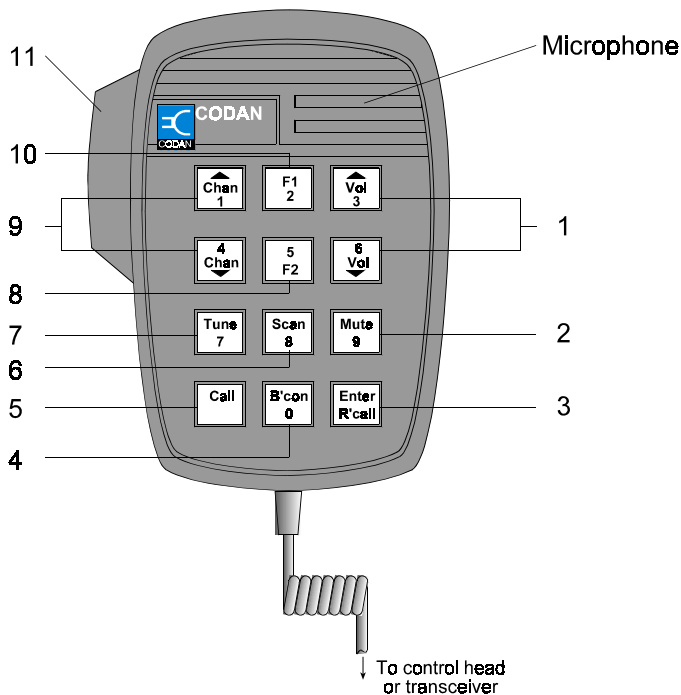













Figure 2-5: The keypad microphone

No.	Button	Function
1		Used to change the volume when the transceiver is in Channel mode
		Used to enter 3 and 6 when a number can be entered
2		Switches on and off the mute in whichever mute setting was last selected on the control panel
		Used to enter 9 when a number can be entered

No.	Button	Function
3		Used to enter information into the transceiver; can be used in place of F2 if the function of the F2 field is ENTER
4		Prepares the transceiver to make a beacon call Used to enter 0 when a number can be entered
5		Makes a call on the current channel
6		Switches on and off the scanning of channels in a scan table Used to enter 8 when a number can be entered
7		Tunes an automatic antenna or tuner to the frequency of the selected channel Used to enter 7 when a number can be entered
8		Performs the operation stated in the F2 field of the display (see page 2-16, <i>Display for Channel mode</i>) when the transceiver is in Channel mode Used to enter 5 when a number can be entered
9		Used to change the channel when the transceiver is in Channel mode
		Used to enter 1 and 4 when a number can be entered

No.	Button	Function
10		Performs the operation stated in the F1 field of the display (see page 2-16, <i>Display for Channel mode</i>) when the transceiver is in Channel mode Used to enter 2 when a number can be entered
11	PTT	Used to transmit a voice call Resets the display to the previous level in the menu or to Channel mode



In most instances, you can use the keys on the microphone instead of the keys or knobs on the front panel. For example, **Enter/R'call** on the microphone can replace **F2(ENTER)** on the front panel (other **F2** functions will require you to press **F2**). Channel numbers or frequencies can be entered using the keypad. Menu option numbers can be entered using the keypad—you do not have to press **Enter/R'call** or **F2(ENTER)** after each number.

Option ST

This option is the same as Option S except that you have the added option of making telephone calls through your transceiver. To do this, you must have access to a radio network that is connected to a Telephone Interconnect (IPC-500) system.

You can make telcalls to stations privately equipped with telephone interconnect units such as the IPC-500.



Your conversation can be monitored by anyone tuned to your transmit frequency.

Private networks

Figure 2-6 shows a typical private network for making telephone calls. Mobile stations wanting to make telephone calls send telcalls to the base station.

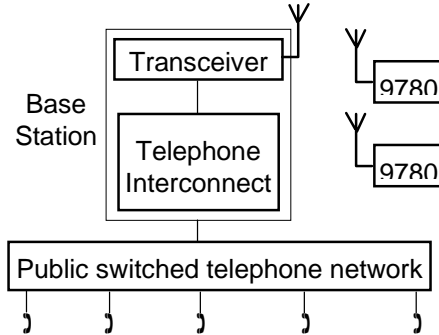

Figure 2-6: Private network for making telephone calls

You can specify up to sixteen digits for the telephone number. To save you from having to enter the telephone number each time you make a call, you can set up to ten telephone numbers in a telephone directory (see page 9-2, *Setting up a telephone directory*).

Option D

This option allows you to obtain information about a remote transceiver. The transceiver that you poll will respond automatically, if it also has the status call option enabled.

Local diagnostics provides information on the performance of your own transceiver.

The information provided is useful for technicians during installation and fault finding.

Option M

This option allows you to send morse code from your transceiver. If you have purchased this option, your rear panel will have an extra socket for the morse equipment.

Option AM

This option allows you to transmit a modified AM transmission to AM stations that are incapable of sideband communication. The signal consists of a carrier and one sideband. The AM setting automatically operates as USB on receive.

Option LF

This option extends the lower frequency limit of the transceiver to 1.6 MHz.

Option PH

This option allows you to use headphones with your transceiver. There will be an additional socket on the front panel of your transceiver directly above the microphone socket.

3 Getting started

This chapter contains basic procedures that will familiarise you with the basic operation and menu options of your transceiver.

The topics covered in this chapter are:

- switching on the transceiver (3-2)
- selecting an operating mode (3-4)
- adjusting the basics—volume, brightness, contrast, loudness of beeps and the setting and calibrating of the clock (3-6)
- using **Select** and **Volume** to enter information (3-14)
- viewing the settings that control your receiver (3-15)
- selecting a sideband (3-16)
- tuning the antenna (3-17)
- clarifying the received signal (3-19)
- using the microphone (3-20)
- muting the transceiver (3-21)

Switching on the transceiver

- ❑ Press **On/Off**.

Power up messages are shown briefly.

If your transceiver does not require a Personal Identification Number (PIN), you will see a display that is similar to the following.

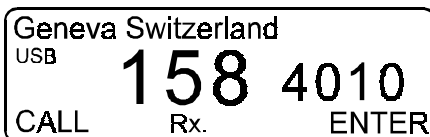

Entering a PIN

- ❑ If your transceiver is set up with PIN access, you will see the following display.



- ❑ Enter your PIN (see page 3-14, *Using **Select** and **Volume** to enter information*).
- ❑ Press **F2(ENTER)** to enter your PIN.

If your PIN is entered correctly, the display shown at the top of the page will appear.

If your PIN is entered incorrectly, the transceiver automatically switches off. Repeat the steps from *Switching on the transceiver*.



If you forget your PIN, you will have to obtain a special password from Codan to delete the PIN before you can use the transceiver again (see page 11-22, *Enabling transceiver options using a password*).

Switching off the transceiver

- Press **On/Off**.

Selecting an operating mode

Your transceiver has six different operating modes. If your transceiver is not in Channel mode and has been left untouched for more than 30 seconds, it will revert to Channel mode. A typical display for Channel mode is shown below.

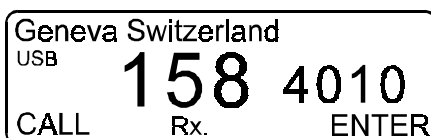

- Press **Mode** to see the display for Clarifier mode.

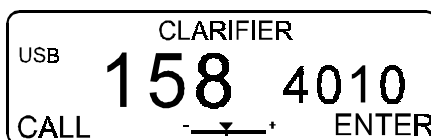

- Press **Mode** again to see the display for Channel Options mode.

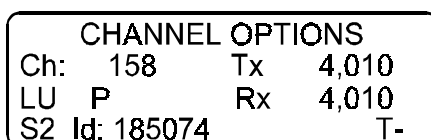

- Press **Mode** again to see the display for Free Tune Receiver mode.

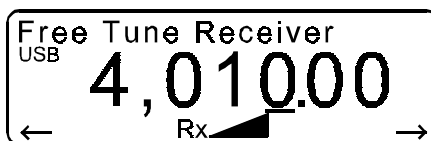

- Press **Mode** again to see the display for Setup mode.

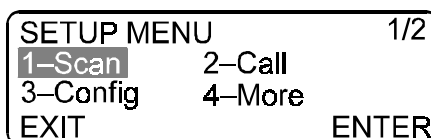

- ❑ Press **Mode** again to see the display for View All Settings mode.



- ❑ Press **Mode** again to return to Channel mode.

Adjusting the basics

Adjusting the volume

- ❑ Rotate **Volume** clockwise to increase the volume.

If you want to decrease the volume, rotate **Volume** counter-clockwise.

Adjusting the brightness of the display using Volume

- ❑ If you want to increase the brightness of the display, press and hold **On/Off** while rotating **Volume** clockwise.

If you want to decrease the brightness of the display, press and hold **On/Off** while rotating **Volume** counter-clockwise.

Adjusting the brightness of the display using Setup

Selecting Setup mode

- ❑ Press **Mode** repeatedly until the display for **SETUP MENU** appears.

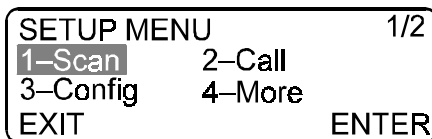

- ❑ Rotate **Select** to highlight each option, then press **F2(ENTER)**, to navigate through the Setup menu.

Number	Option	To see display for
3	Config	CONFIG MENU
1	Display	DISPLAY MENU
1	Bright	LCD Brightness

LCD Brightness Adjust brightness with Select knob. EXIT	ENTER
------------------------------------------------------------------	-------

Adjusting the brightness

- If you want to increase the brightness of the display, rotate **Select** clockwise.
If you want to decrease the brightness of the display, rotate **Select** counter-clockwise.
- Press **F2(ENTER)** to save the setting of the brightness.
- Press **Mode** to return to Channel mode.

Adjusting the contrast of the display using Select

- If you want to darken the background of the display, press and hold **On/Off** while rotating **Select** clockwise.
If you want to lighten the background of the display, press and hold **On/Off** while rotating **Select** counter-clockwise.

Adjusting the contrast of the display using Setup

Selecting Setup mode

- Press **Mode** repeatedly until the display for **SETUP MENU** appears.

SETUP MENU	1/2
1-Scan	2-Call
3-Config	4-More
EXIT	ENTER

- ❑ Rotate **Select** to highlight each option, then press **F2(ENTER)**, to navigate through the Setup menu.

Number	Option	To see display for
3	Config	CONFIG MENU
1	Display	DISPLAY MENU
2	Contrast	LCD Contrast

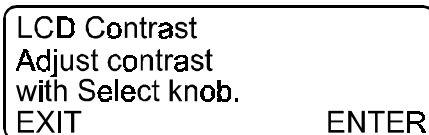

Adjusting the contrast

- ❑ If you want to darken the background of the display, rotate **Select** clockwise.

If you want to lighten the background of the display, rotate **Select** counter-clockwise.

- ❑ Press **F2(ENTER)** to save the setting of the contrast.
- ❑ Press **Mode** to return to Channel mode.

Adjusting the loudness of the beeps

Selecting Setup mode

- ❑ Press **Mode** repeatedly until the display for **SETUP MENU** appears.

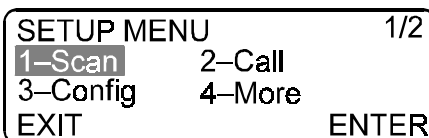

- ❑ Rotate **Select** to highlight each option, then press **F2(ENTER)**, to navigate through the Setup menu.

Number	Option	To see display for
3	Config	CONFIG MENU
3	Beeps	Adjust Beep Volume

You will see a display that is similar to the following.

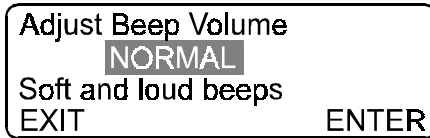

Selecting the loudness of the beeps

- ❑ Rotate **Select** to highlight the option you want.
 - Normal** Loud error beeps and soft acceptance beeps
 - Soft** All soft beeps
 - Loud** All loud beeps
- ❑ Press **F2(ENTER)** to save the setting of the loudness of the beeps.
- ❑ Press **Mode** to return to Channel mode.

Adjusting the clock

The clock is used for timing incoming emergency selcalls (and selcalls, telcalls and status calls if you have Option S, ST or D fitted). The time is recorded in call memory.



You must complete all of the steps in this procedure in order to change the time. If you exit the procedure before the end, all of your changes will be discarded.

Selecting Setup mode

- ❑ Press **Mode** repeatedly until the display for **SETUP MENU** appears.

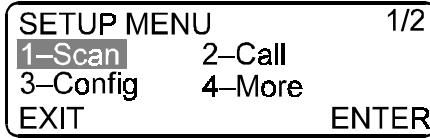

- ❑ Rotate **Select** to highlight each option, then press **F2(ENTER)**, to navigate through the Setup menu.

Number	Option	To see display for
4	More	SETUP MENU
1	Time	TIME SETUP MENU
1	Set	TIME SETUP

You will see a display that is similar to the following.



The clock stops. The display tells you to **Enter hours**.

Entering the time

- ❑ Enter the hour using **Select** and **Volume** (see page 3-14, *Using **Select** and **Volume** to enter information*).

Use a 24 hour time format, e.g. 14 for 2 pm.

- ❑ Press **F2(ENTER)**.

The display tells you to **Enter minutes**.

- ❑ Enter the minutes using **Select** and **Volume**.

Enter a time that is a few minutes in advance of the current time. This allows you time to enter the date.

- Press **F2(ENTER)**.

The display tells you to **Select date format**.

Entering the date

- Rotate **Select** to highlight the date format you want.

D/M/Y Day/Month/Year

M/D/Y Month/Day/Year

- Press **F2(ENTER)**.

The display tells you to **Enter days** or **Enter months** depending upon your choice of date format.

- Enter the day or month using **Select** and **Volume**.

- Press **F2(ENTER)**.

The display tells you to **Enter months** or **Enter days** depending upon your choice of date format.

- Enter the month or day using **Select** and **Volume**.

- Press **F2(ENTER)**.

The display tells you to **Enter years**.

- Enter the year using **Select** and **Volume**.

- Press **F2(SAVE)** when the current time matches that on the display of the transceiver.

- Press **Mode** to return to Channel mode.



If you are setting the clock for the first time, you may need to calibrate the clock (see page 3-12, *Adjusting the calibration of the clock*).

Adjusting the calibration of the clock

Over a period of time, you may find that the clock on your transceiver is running ahead of or behind real time. You can change the speed at which the clock on your transceiver operates by adjusting the number of seconds that the clock gains or loses each month.



When you calibrate the clock for the first time, set the calibration value to zero.

Selecting Setup mode

- Press **Mode** repeatedly until the display for **SETUP MENU** appears.

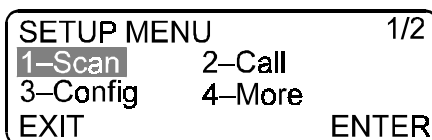

- Rotate **Select** to highlight each option, then press **F2(ENTER)**, to navigate through the Setup menu.

Number	Option	To see display for
4	More	SETUP MENU
1	Time	TIME SETUP MENU
2	Calib	TIME CALIBRATION

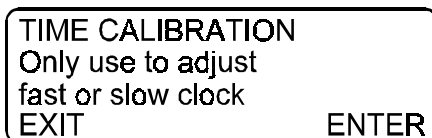

- Press **F2(ENTER)** to see a display that is similar to the following.

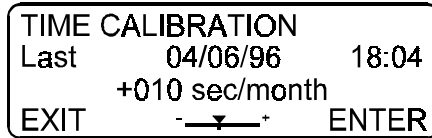

The display shows the date and time at which the last calibration of the clock was performed.

Calibrating the clock

- Rotate **Select** to adjust the calibration.

The calibration range is -155 to +310 seconds per month in steps of 10 seconds.

- Press **F2(ENTER)** to save the calibration value.
- Press **Mode** to return to Channel mode.

Using Select and Volume to enter information

In situations where you need to use this procedure, a character within the display will already be highlighted by a flashing cursor.

- ❑ Rotate **Volume** to move the flashing cursor to the character that you want to change within the same editable field.
- ❑ Rotate **Select** to increase or decrease the value of the character.
- ❑ Repeat these steps until you have made all of the changes that you want within the one editable field.

Viewing the settings that control your transceiver

You can view the settings that control the operation of your transceiver in View All Settings mode. The displays show information relating to all of the standard features on your transceiver, as well as any optional features you have fitted.

Selecting View All Settings mode

- Press **Mode** repeatedly until you see a display that is similar to the following.

Option TxE	
No of Channels:	12
	SLOES
EXIT	NEXT

- Rotate **Select** clockwise or press **F2(NEXT)** to cycle through each display.

If you want to return to a previous display, rotate **Select** counter-clockwise.

- Press **F1(EXIT)** or **Mode** to return to Channel mode.

Selecting the sideband

The **USB/LSB** button on the control panel switches between upper sideband, lower sideband and AM (if Option AM is fitted) depending on the current channel setting. You can only swap between USB and LSB on a channel that is programmed for LU, receive-only channels and for free tuning.

If Option AM is fitted, you can transmit an AM transmission to AM stations that are incapable of sideband communication.

You can receive AM transmission on any AM, USB and LSB setting. You may find that switching between USB and LSB improves the reception of an AM broadcast.

- If your transceiver is scanning, press **Scan** or **PTT** to stop scanning.
- Press **USB/LSB** to cycle through the sideband options until you see the option you want.

Tuning the antenna

If you have a manual or automatic antenna tuner, you must tune the antenna after selecting the channel on which you want to transmit or receive.

Automatic tuning whip antenna

- Rotate **Select** until you see the channel that you want to use.

You can also select the channel by its channel number or by its frequency (see page 4-2, *Selecting a channel*).

- Check that the channel is clear of any voice or data traffic.
- Press **Tune**.

The status of the tuning process is indicated in the table below.

Message	Beeps	Meaning
Tune Fail	Two loud low beeps	Unable to tune antenna
Tune Pass	Two soft high beeps	Successful antenna tune
Tuner Fault (displayed for 10 seconds)	Two loud low beeps	Failed to tune the antenna after two minutes
Tuning	Two soft high beeps every second	Tuning the antenna now

Long wire with automatic antenna tuner

- Rotate **Select** until you see the channel that you want to use.
You can also select the channel by its channel number or by its frequency (see page 4-2, *Selecting a channel*).
- Check that the channel is clear of any voice or data traffic.
- Press **Tune**.

Tapped whip antenna

- Place the antenna lead into the tap point corresponding to the channel frequency that you want to use.
Take care to wind the antenna lead evenly along the length of the antenna whip.
- Rotate **Select** until you see the channel on which you want to transmit.

Clarifying the received signal

If the voice signal that you are receiving is not very clear, you may be able to improve the clarity of the signal by slightly varying the frequency of your current channel to match that of the received signal.

- Press **Mode** repeatedly until you see the display for Clarifier mode.

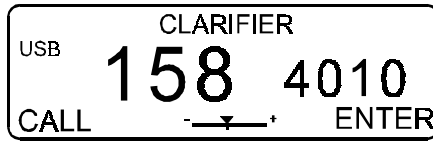

- Rotate **Select** to clarify the received voice signal.
- Press **Mode** to return to Channel mode.

The adjustment that you made to the clarity will remain with the channel until you change to another channel at which time the adjustment will be reset to the centre value.

Using the microphone

- ❑ Wait until the channel is clear of all voice and data traffic.
- ❑ Hold the microphone side-on and close to your mouth.
- ❑ Press and hold down **PTT** when you want to speak.

Speak clearly at your normal volume and rate of speech.

Say "over" to indicate that you have finished speaking (or see page 11-9, *Enabling PTT release beep*).

- ❑ Release **PTT**.



Remember that your conversation can be monitored by anyone tuned to your transmit frequency.

Muting the transceiver

Muting allows you to silence the transceiver so that you do not hear unwanted background noise on the channel until a voice is detected or you receive a Selcall (Options S and ST only).



Sometimes the mute will be switched off by excessive noise on the channel.

Using Voice Mute **while not scanning**

- Press **Voice Mute** to silence the transceiver.

If you want to listen to the traffic on the transceiver, press **Voice Mute** again.

Using Voice Mute **while scanning**

- Press **Voice Mute** to change the type of scanning.

Pause Scan
(first press)

Scanning will be continuous until voice is detected on a channel. Scanning will pause for five seconds, then resume.

Hold Scan
(second press)

Scanning will be continuous until voice is detected on a channel. Scanning will hold on that channel for as long as voice is detected, then resume.

Scanning
(third press)

Scanning is continuous. Voice transmission can be heard. Mute is not turned on.

4 Working with channels

A channel is a label for a group of parameters that define a communication path. The basis of a channel is its receive and transmit frequency, sideband, protection setting and channel comment. Additional parameters may be tone group and selcall group.

Your transceiver has the ability to program channel transmit frequencies. This is fitted as standard. If you are operating your transceiver in a country that has stringent licensing regulations, you may not be permitted to use this function. Instead, the preferred option may be Option TxD.

Your transceiver has up to 15 channels.

This chapter describes the following tasks:

- selecting a channel (4-2)
- viewing the options of a selected channel (4-6)
- creating or editing a channel (TxE) (4-7)
- creating or editing a channel (TxD) (4-13)
- deleting a channel (4-19)

Selecting a channel

You need to select an appropriate channel before you can make a call. This will depend upon the time of day and the distance over which you want to transmit (see page 2-3, *Frequency, distance and time of day*).

There are three ways of selecting a channel:

- selecting a channel by scrolling through a list of channels
- selecting a channel by recalling its channel number
- selecting a channel by recalling its channel frequency

Selecting a channel by scrolling through a list of channels

Selecting Channel mode

- If you are not in Channel mode, press **Mode** repeatedly until the display for Channel mode appears.

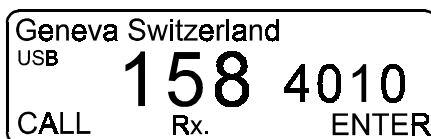

Selecting a channel

- Rotate **Select** until you see the channel on which you want to transmit or receive.

Selecting a channel by recalling its channel number

Selecting Channel mode

- If you are not in Channel mode, press **Mode** repeatedly until the display for Channel mode appears.

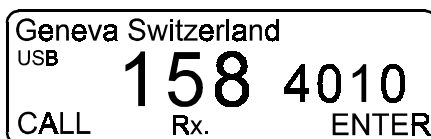

Selecting a channel

- Press **F2(ENTER)** to see the display for **Recall Chan.**

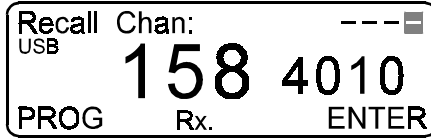

- Enter the channel number using **Select** and **Volume** (see page 3-14, *Using **Select** and **Volume** to enter information*).
- Press **F2(ENTER)**.

If you enter a channel number that does not exist on your transceiver, the transceiver will beep and show a message saying **Channel not found**, then select the channel with the next higher channel number.

Selecting a channel by recalling its receive frequency

Selecting Channel mode

- If you are not in Channel mode, press **Mode** repeatedly until the display for Channel mode appears.

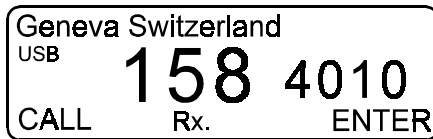

Selecting a channel

- Press **F2(ENTER)** to see the display for **Recall Chan.**

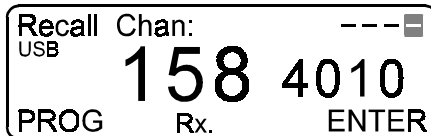

- ❑ Enter the channel receive frequency using **Select** and **Volume** (see page 3-14, *Using **Select** and **Volume** to enter information*).

Enter the frequency as a five or six digit number e.g. enter 20400 for 2040 kHz. The display will change and look similar to the following.

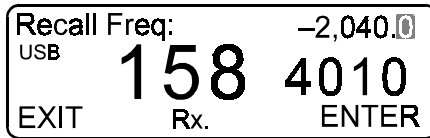

If you cannot enter a five or six digit number, then the ability to recall a channel by its receive frequency has been disabled (see page 4-4, *Enabling/Disabling the ability to recall channels by frequency*).

- ❑ Press **F2(ENTER)**.

If you enter a channel frequency that does not exist on your transceiver, the transceiver will beep and show a message saying **Frequency Not Found**, then select the channel with the next higher channel frequency.

Enabling/Disabling the ability to recall channels by frequency

- ❑ Press **Mode** repeatedly until the display for **SETUP MENU** appears.

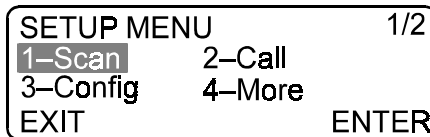

- ❑ Rotate **Select** to highlight each option, then press **F2(ENTER)**, to navigate through the Setup menu.

Number	Option	To see display for
3	Config	CONFIG MENU
2	Recall	Recall by Frequency

You will see a display that is similar to the following.

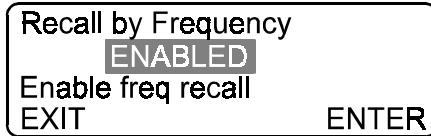

- ❑ Rotate **Select** to highlight the option you want.

DISABLED You will not be able to select a channel by recalling its frequency

ENABLED You will be able to select a channel by recalling its frequency



Disabling the ability to recall a channel by frequency will also deactivate Free Tune Receiver mode *and* you will no longer be able to program receive channels.

- ❑ Press **F2(ENTER)** to save the recall option you want.
- ❑ Press **Mode** to return to Channel mode.

Viewing the options of a selected channel

The Channel Options display shows information on how the channel is set up.

Selecting Channel Options mode

- Press **Mode** repeatedly until the display for Channel Options mode appears.

CHANNEL OPTIONS			
Ch:	158	Tx	4,010
LU	P	Rx	4,010
S2 Id:	185074		T-

The channel that is shown in the display was the current channel when you pressed **Mode**.

- If you want to see the options for another channel, rotate **Select** until you see the channel you want.
- Press **Mode** repeatedly to return to Channel mode.

Creating or editing a channel (TxE)

As standard, your transceiver is fitted with the ability to program transmit frequencies (TxE) as well as receive frequencies.

Transmit channels consist of:

- receive frequency
- transmit frequency
- sideband
- tone call group
- selcall group (option)
- channel protection
- channel comment

Selecting Channel mode

- If you are not in Channel mode, press **Mode** repeatedly until the display for Channel mode appears.

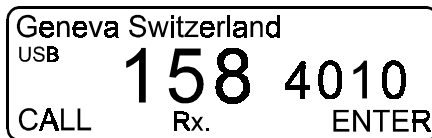

Selecting a channel

- If you want to edit an existing channel, select the channel you want (see page 4-2, *Selecting a channel*).

If you want to create a new channel, select any channel then proceed to the next step.

- ❑ Press **F2(ENTER)** *twice* to see the display for **Enter Channel No.**

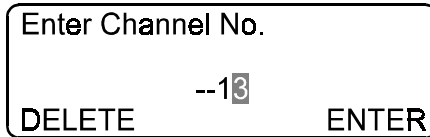

Entering the channel number

- ❑ Enter the channel number of the channel you want to create using **Select** and **Volume** (see page 3-14, *Using **Select** and **Volume** to enter information*).

If you do not want to change the channel number, proceed to the next step.

- ❑ Press **F2(ENTER)**.

If you are editing an existing channel, the transceiver will beep and a message will appear saying **Channel used**. Press **F2(ENTER)** to continue.

You will see a display that is similar to the following.

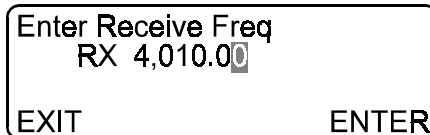

The display tells you to **Enter Receive Freq**.

Setting the receive frequency

- ❑ Enter the receive frequency using **Select** and **Volume**.

If you do not want to change the receive frequency, proceed to the next step.

- Press **F2(ENTER)** to see a display that is similar to the following.

```

Enter Transmit Freq
  RX 4,010.00
  TX 4,010.00
EXIT                               ENTER

```

The display tells you to **Enter Transmit Freq.**

Setting the transmit frequency

- Enter the transmit frequency using **Select** and **Volume**.

If you want to change the channel to a receive-only channel, enter a transmit frequency of 0 Hz.

If you do not want to change the transmit frequency, proceed to the next step.

- Press **F2(ENTER)** to see a display that is similar to the following.

```

Enter Options
U   T1 S1           NP
Upper sideband
EXIT                               ENTER

```

The display tells you to **Enter Options.**

Setting the sideband

- Rotate **Select** to highlight the sideband that you want.

USB upper sideband

LSB lower sideband

LU lower and upper sideband may be selected to suit needs

AM AM transmission is available
(Option AM)

If you do not want to change the sideband, proceed to the next step.

Setting the tone call group

- Rotate **Volume** to highlight the tone call group.
- Rotate **Select** to highlight the tone call group that you want.

T- Tone call disabled

T1 Tone call group 1

T2 Tone call group 2

T3 Tone call group 3

T4 Tone call group 4

If you do not want to change the tone call group setting, proceed to the next step.

Setting the selcall group (Option S, ST)



The selcall group will be selectable even if you *do not* have Option S or ST fitted. In this case, your selection will be used for emergency selcalls only.

- Rotate **Volume** to highlight the selcall group.
- Rotate **Select** to highlight the selcall group that you want.

S-	Selcalls not enabled
S1	Selcall group 1
S2	Selcall group 2
S3	Selcall group 3
S4	Selcall group 4
S5	Selcall group 5

If you do not want to change the selcall group setting, proceed to the next step.

Setting the channel protection

- Rotate **Volume** to highlight the channel protection status.
- Rotate **Select** to highlight the option you want.

P	protected
NP	not protected

If you do not want to change the channel protection status, proceed to the next step.

- ❑ Press **F2(ENTER)** to see a display that is similar to the following.

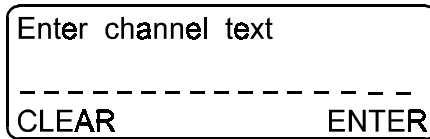

Enter channel text

CLEAR ENTER

The display tells you to **Enter channel text**.

Entering a channel comment

- ❑ Enter the channel comment using **Select** and **Volume**.

If you do not want to change the channel comment, proceed to the next step.

- ❑ Press **F2(ENTER)** to save the channel settings.

The display returns to Channel mode.

Creating or editing a channel (TxD)

If you have Option TxD fitted, you will not be able to program transmit frequencies. You are able to program receive frequencies only.

Receive channels consist of:

- receive frequency
- sideband
- channel protection
- channel comment

The protected channels installed by Codan should have transmit frequencies. You can copy these frequencies to new channel numbers. If you alter the transmit frequency, the channel will automatically become a receive-only channel.

Selecting Channel mode

- If you are not in Channel mode, press **Mode** repeatedly until the display for Channel mode appears.

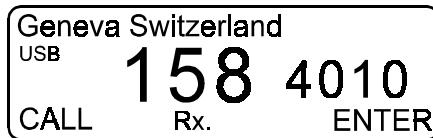

Selecting a channel

- If you want to edit an existing channel, select the channel you want (see page 4-2, *Selecting a channel*).

If you want to create a new channel, select any channel then proceed to the next step.

- ❑ Press **F2(ENTER)** *twice* to see the display for **Enter Channel No.**

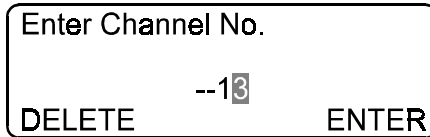

Entering the channel number

- ❑ Enter the channel number of the channel you want to create using **Select** and **Volume** (see page 3-14, *Using **Select** and **Volume** to enter information*).

If you do not want to change the channel number, proceed to the next step.

- ❑ Press **F2(ENTER)**.

If the channel number you entered is that of a protected channel, the transceiver will beep and a message will appear saying **Channel protected**. The display will then ask you to **Enter channel text**. Continue from *Entering a channel comment*.

If the channel number you entered is that of an unprotected channel, the transceiver will beep and a message will appear saying **Channel used**. Press **F2(ENTER)** to continue.

You will see a display that is similar to the following.

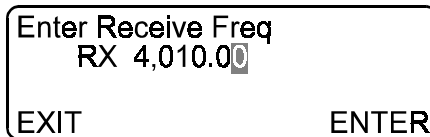

The display tells you to **Enter Receive Freq**.

Setting the receive frequency

- Enter the receive frequency using **Select** and **Volume**.

If you do not want to change the receive frequency, proceed to the next step.

- Press **F2(ENTER)** to see a display that is similar to the following.

Enter Options		
U	T1 S1	NP
Upper sideband		
EXIT		ENTER

The display tells you to **Enter Options**.

Setting the sideband

- Rotate **Select** to highlight the sideband that you want.

USB upper sideband

LSB lower sideband

LU lower and upper sideband may be selected to suit needs

AM AM transmission is available
(Option AM)

If you do not want to change the sideband, proceed to the next step.

Setting the tone call group



If you changed the receive frequency, this option will not be available as it is only applicable to transmit channels. Changing the receive frequency of an unprotected Tx/Rx channel (using Option TxD) automatically makes it a receive-only channel.

- Rotate **Volume** to highlight the tone call group.
- Rotate **Select** to highlight the tone call group that you want.

T-	Tone call disabled
T1	Tone call group 1
T2	Tone call group 2
T3	Tone call group 3
T4	Tone call group 4

If you do not want to change the tone call group setting, proceed to the next step.

Setting the selcall group (Option S, ST)



If you changed the receive frequency, this option will not be available as it is only applicable to transmit channels. Changing the receive frequency of an unprotected Tx/Rx channel (using Option TxD) automatically makes it a receive-only channel.



The selcall group will be selectable even if you *do not* have Option S or ST fitted. In this case, your selection will be used for emergency selcalls only.

- Rotate **Volume** to highlight the selcall group.

- Rotate **Select** to highlight the selcall group that you want.

S-	Selcalls not enabled
S1	Selcall group 1
S2	Selcall group 2
S3	Selcall group 3
S4	Selcall group 4
S5	Selcall group 5

If you do not want to change the selcall group setting, proceed to the next step.

Setting the channel protection

- Rotate **Volume** to highlight the channel protection status.
- Rotate **Select** to highlight the option you want.

P	Protected—the channel cannot be deleted except by using special tasks described in the Reference Manual Chapter 4, <i>Link Setup mode</i> .
NP	Not Protected

If you do not want to change the channel protection status, proceed to the next step.

- Press **F2(ENTER)** to see a display that is similar to the following.

Enter channel text

CLEAR
ENTER

The display tells you to **Enter channel text**.

Entering a channel comment

- ❑ Enter the channel comment using **Select** and **Volume**.

If you want to clear existing channel text, press **F1(CLEAR)**, then enter the new text you want.

If you do not want to change the channel comment, proceed to the next step.

- ❑ Press **F2(ENTER)** to save the channel settings.

The display returns to Channel mode.

Deleting a channel

You can delete a protected or unprotected channel if you have Option TxE. If you have Option TxD you can only delete unprotected channels.



Unprotected channels are identified by a dot in the Channel Protection field.

Selecting Channel mode

- If you are not in Channel mode, press **Mode** repeatedly until the display for Channel mode appears.



Selecting a channel

- Select the channel you want to delete (see page 4-2, *Selecting a channel*).
- Press **F2(ENTER)** twice to see the display for **Enter Channel No.**

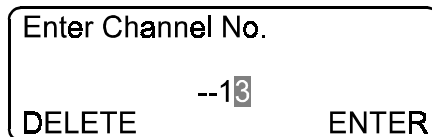

Deleting the channel

- ❑ Press **F1(DELETE)** to see a display that is similar to the following.

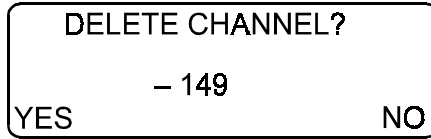

The display asks you to confirm **DELETE CHANNEL?**

- ❑ Press **F1(YES)**.

If you select a channel that is an emergency channel, the transceiver will beep and show a message saying **Is Emergency Channel**. You will not be able to delete the channel until it is removed from the preset emergency channels (see page 6-2, *Setting up to make an emergency selcall*).

If you do not want to delete the channel, press **F2(NO)**.

The display returns to Channel mode.

5 Working with scan tables

When you are not actively using your transceiver, it should be set up to scan for incoming calls. The channels that your transceiver scans are determined by the scan table you choose.

This chapter describes the following tasks:

- enabling/disabling the editing of scan tables (5-2)
- creating or editing a scan table (5-4)
- deleting a scan table (5-8)
- scanning for incoming calls (5-10)

Enabling/Disabling the editing of scan tables

You will only be able to edit scan tables if this ability has been enabled through the Setup mode. After you have set up your scan tables, you may want to disable the ability to edit scan tables. This will protect your scan tables against accidental changes or deletions.

Selecting Setup mode

- Press **Mode** repeatedly until the display for **SETUP MENU** appears.

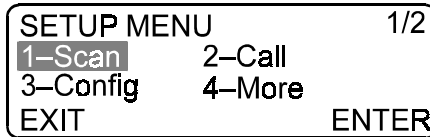

- Rotate **Select** to highlight each option, then press **F2(ENTER)**, to navigate through the Setup menu.

Number	Option	To see display for
1	Scan	SCAN MENU
2	Enable	Scan Programming

You will see a display that is similar to the following.

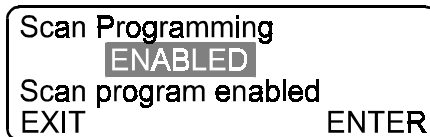

- Rotate **Select** to highlight the option you want.

ENABLED You are able to program scan tables

DISABLED You are not able to program scan tables

- Press **F2(ENTER)** to save the option you want.
- Press **Mode** to return to Channel mode.

Creating or editing a scan table

A scan table can hold up to 10 channels.

Selecting Channel mode

- ❑ If you are not in Channel mode, press **Mode** repeatedly until the display for Channel mode appears.



Selecting a scan table

- ❑ Press **Scan** to see the display for **Scan Table**.

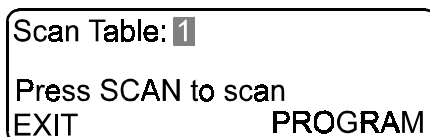

- ❑ Rotate **Select** to highlight the scan table number that you want to create or edit.
- ❑ Press **F2(ENTER)** to see a display that is similar to the following.

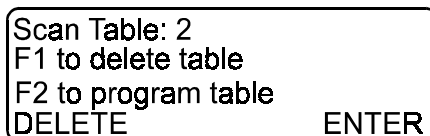

- ❑ Press **F2(ENTER)** to create or edit the scan table name.

Scan Table: 2
 [] -----
 Enter scan name
 CLEAR ENTER

The display tells you to **Enter scan name**.

Entering the scan table name

- ❑ Enter the name of the scan table using **Select** and **Volume** (see page 3-14, *Using **Select** and **Volume** to enter information*).

If you want to clear the existing name, press **F1(CLEAR)**, then repeat this step to enter the new name.

If you do not want to change the name of the scan table, proceed to the next step.

- ❑ Press **F2(ENTER)** to save the name of the scan table.

You will see a display that is similar to the following.

Scan Table: 2
 Default Scan: Cont
 Continuous Scan
 EXIT ENTER

Changing the type of default scan

- ❑ Rotate **Select** to highlight the type of scanning that you want to set as default.

Cont Scanning is continuous. Voice transmission can be heard. Mute is not turned on. Each channel is scanned for 0.6 seconds. If you have Option S or ST, scanning will stop for a selcall.

Pause Scanning will be continuous until voice is detected on a channel. Scanning will pause for five seconds, then resume. Each channel is scanned for one second. If you have Option S or ST, scanning will stop for a selcall.

Hold Scanning will be continuous until voice is detected on a channel. Scanning will hold on that channel for as long as voice is detected, then resume. Each channel is scanned for one second. If you have Option S or ST, scanning will stop for a selcall.

Selcall Scanning will only stop for a selcall.
(Option S, ST)



Sometimes the mute will be switched off by excessive noise on the channel.

If you do not want to change the default scan type, proceed to the next step.

- ❑ Press **F2(ENTER)** to save the default scan type.

You will see a display that is similar to the following.

Scan Table: 2	Prog x1
Local Network	
USB 149	2,040.0
DELETE	PROGRAM

Adding a channel to the scan table

- If you want to add a channel to the scan table, rotate **Select** until you see the channel that you want to add to the scan table, then press **F2(PROGRAM)**.
Prog x1 appears in the top line of the display. This indicates the number of times that this channel has been programmed into the scan table. If the channel has been programmed twice, **Prog x2** will appear etc.
- If you want to add another channel to the scan table, continue from *Adding a channel to the scan table*.

Deleting a channel from a scan table

- If you want to delete a channel from a scan table, rotate **Select** until you see the channel that you want to delete from the scan table, then press **F1(DELETE)**.
- If you want to delete another channel from the scan table, continue from *Deleting a channel from a scan table*.

Saving the scan table

- Press **Scan** to save the changes you have made to the scan table.
The display returns to Channel mode.
- If you want to program another scan table, repeat the steps from *Selecting a scan table*.

Deleting a scan table

Selecting Channel mode

- ❑ If you are not in Channel mode, press **Mode** repeatedly until the display for Channel mode appears.



Selecting a scan table

- ❑ Press **Scan** to see the display for **Scan Table**.

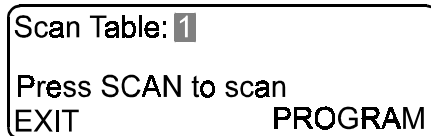

- ❑ Rotate **Select** to highlight the scan table number that you want to delete.
- ❑ Press **F2(ENTER)** to see a display that is similar to the following.

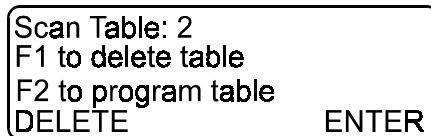

- ❑ Press **F1(DELETE)** to see a display that is similar to the following.

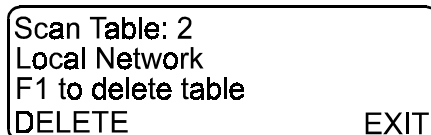

The display says **F1 to delete table**.

- Press **F1(DELETE)** to delete this scan table.
The transceiver returns to Channel mode.

Scanning for incoming calls

Scanning allows the transceiver to detect incoming calls on more than one channel frequency. This is useful if you expect to receive calls from several stations or from stations that transmit on more than one frequency.

The transceiver scans the list of channels set up in a scan table.

Selecting a scan table for scanning

Selecting Channel mode

- If you are not in Channel mode, press **Mode** repeatedly until the display for Channel mode appears.



Selecting a scan table

- Press **Scan** to see the display for **Scan Table**.

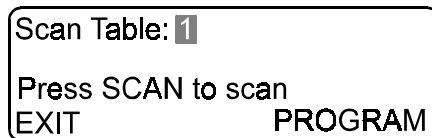

- Rotate **Select** to highlight the scan table number that you want to use for scanning.
- Press **Scan**.

If you have chosen a scan table that is empty, the transceiver will beep and show a message saying **Empty Scan Table**, then return to Channel mode. Repeat the steps from *Selecting a scan table for scanning*.

If you want to stop the transceiver scanning, press **PTT** or **Scan**.

Responding to an incoming call while scanning (Option S or ST only)

- Press **Scan** or **PTT** to stop your transceiver scanning.
- Press **PTT** to speak. Hold the microphone side-on and close to your mouth. Speak clearly at your normal volume and rate of speech.
- Release **PTT** to hear the reply.

Enabling/Disabling automatic scanning

If you enable automatic scanning, your transceiver will return to scanning after the time period you have set. It will scan on the last scan table used.

Selecting Setup mode

- Press **Mode** repeatedly until the display for **SETUP MENU** appears.

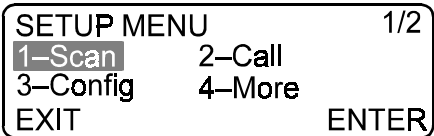

- Rotate **Select** to highlight each option, then press **F2(ENTER)**, to navigate through the Setup menu.

Number	Option	To see display for
1	Scan	SCAN MENU
1	Auto	Auto Scan Setup

You will see a display that is similar to the following.

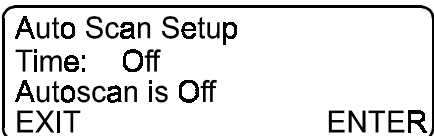

Setting automatic scanning

- Rotate **Select** to highlight the option you want.

Off Automatic scanning is turned off

1min - 10min Your transceiver will automatically return to scanning after the specified period of time

- Press **F2(ENTER)** to save the option you want.
- Press **Mode** to return to Channel mode.

6 Working with emergency selcalls

Emergency selcall is a simple and automatic method of selectively calling any station in an emergency.

The emergency selcall alerts the operator of the receiving station with a special emergency alarm.

This chapter describes the following tasks:

- setting up to make an emergency selcall (6-2)
- making an emergency selcall (6-6)
- setting up to receive an emergency selcall (6-9)
- receiving an emergency selcall (6-12)

Setting up to make an emergency selcall

Selecting Setup mode

- Press **Mode** repeatedly until the display for **SETUP MENU** appears.

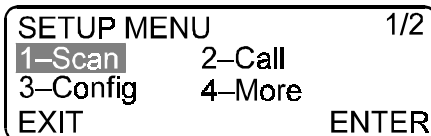

- Rotate **Select** to highlight each option, then press **F2(ENTER)**, to navigate through the Setup menu.

Number	Option	To see display for
2	Call	CALL MENU
4	More	CALL MENU
4	More	CALL MENU
2	Emgcy	EMGCY S'CALL MENU
1	Transmit	Emergency Selcall

You will see a display that is similar to the following.

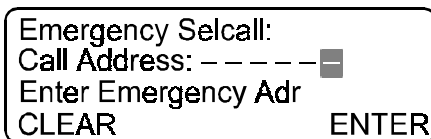

Entering the emergency selcall address

- Enter the address of the station that you want to emergency selcall using **Select** and **Volume** (see page 3-14, *Using Select and Volume to enter information*).

The station to which you want to make an emergency selcall must be set up to receive emergency selcalls.

- ❑ Press **F2(ENTER)** to save the emergency selcall address.

You will see a display that is similar to the following.

```

Emergency Channel: 1
Channel: - - - -
EXIT                PROGRAM
  
```

Selecting an emergency channel

- ❑ Rotate **Select** to highlight the emergency channel that you want to set up.
- ❑ Press **F2(PROGRAM)** to see a display that is similar to the following.

```

Emergency Channel: 1
Channel: - - - -█
Enter Emgcy channel
DELETE                ENTER
  
```

The display tells you to **Enter Emgcy channel**.

Entering the channel number

- ❑ Enter the channel number for this emergency channel using **Select** and **Volume**.

If you want to clear the existing channel number, press **F1(DELETE)** then repeat the steps from *Selecting an emergency channel*.

If you do not want to change the channel number, proceed to the next step.

- ❑ Press **F2(ENTER)**.

You may be presented with one of the following error messages if your channel is not accepted. Wait a few seconds, then repeat the steps from the suggested heading.

Error Message	Problem	Continue from
Channel not found	You entered a channel number that does not exist	<i>Selecting an emergency channel</i>
Transmit Inhibited	You entered the channel number of a receive-only channel	<i>Entering the channel number</i>
Channel used	You entered the channel number of a channel that is already being used as an emergency channel	<i>Entering the channel number</i>
Selcall Disabled	You entered the channel number of a channel that does not have a selcall address	<i>Entering the channel number</i>

- ❑ If the channel you selected has lower or upper sideband selectable, continue from *Selecting the sideband*.

Otherwise, continue from *Saving the emergency channel*.

Selecting the sideband

If the channel you have selected for the emergency channel has both lower and upper sidebands selectable, you will see a display that is similar to the following.

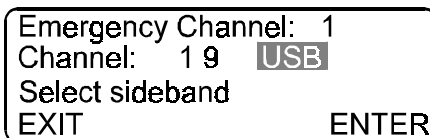

- Rotate **Select** to highlight the sideband option you want.

USB upper sideband

LSB lower sideband

LU lower and upper sideband may be selected to suit needs

AM AM transmission is available
(Option AM)

Saving the emergency channel

- Press **F2(ENTER)** to save the emergency channel.
- If you want to set up another emergency channel, repeat the steps from *Selecting an emergency channel*.
- Press **Mode** to return to Channel mode.

Making an emergency selcall

You can make an emergency selcall using the preset channels or you can manually select the channel at the time of your call. If you use the preset channels, the transceiver will cycle through all of the preset emergency channels. If you choose to manually select the channel on which you want to make your emergency call, your transceiver will make the first call on that channel.



You must have a self ID set up and the channel you select must have a selcall group (see page 8-2, *Setting up a selcall group*).

Making an emergency selcall using the preset channels



You must preset the emergency channels (see page 6-2, *Setting up to make an emergency selcall*).

- Press and hold down **Emgcy Call** for two seconds.

The transceiver will beep rapidly. The channel changes to the first emergency channel.

You will hear your transceiver making the call. The transceiver waits 10 seconds to receive a siren-like revertive signal from the station it has called. If voice communication is not initiated by your pressing **PTT**, the transceiver will repeat the call on the next preset emergency channel.

If you want to stop the emergency call process at any stage, press **PTT**.

- Press **PTT** *after* you hear a revertive signal from the called station. Hold the microphone side-on and close to your mouth. Speak clearly at your normal volume and rate of speech.
- Release **PTT** to hear the reply.

Making an emergency selcall using manual channel selection

- Press **Emgcy Call**.

The transceiver will beep at a moderate rate and show a display that is similar to the following.

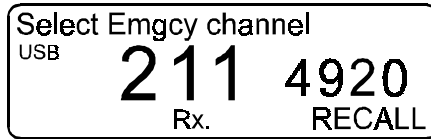

The display tells you to **Select Emgcy channel**.

You must select the channel within 30 seconds before your transceiver reverts to Channel mode.

Selecting the emergency channel

- Rotate **Select** until you see the channel on which you want to transmit.

You can also select the channel by its channel number or by its frequency (see page 4-2, *Selecting a channel*).

Making the call

- Press and hold down **Emgcy Call** for two seconds.

Your transceiver makes an emergency call on the nominated channel.

If you have selected a channel that does not have a self ID, your transceiver will beep and you will see a message saying **No Selcall send**. Press **Mode**, then repeat the steps from *Making an emergency selcall using manual channel selection*, this time selecting a channel that has a selcall group (see page 4-6, *Viewing the options of a selected channel*).

The station answering the emergency call on that channel will send a siren-like revertive.

- ❑ Press **PTT** *after* you hear a revertive signal from the responding station. Hold the microphone side-on and close to your mouth. Speak clearly at your normal volume and rate of speech.
- ❑ Release **PTT** to hear the reply.

Setting up to receive an emergency selcall

Selecting Setup mode

- Press **Mode** repeatedly until the display for **SETUP MENU** appears.

```

SETUP MENU 1/2
1-Scan 2-Call
3-Config 4-More
EXIT ENTER
  
```

- Rotate **Select** to highlight each option, then press **F2(ENTER)**, to navigate through the Setup menu.

Number	Option	To see display for
2	Call	CALL MENU
4	More	CALL MENU
4	More	CALL MENU
2	Emgcy	EMGCY S'CALL MENU
2	Receive	Emgcy S'call Receive

You will see a display that is similar to the following.

```

Emgcy S'call Receive
SELECTIVE
Only selected emgcys
EXIT ENTER
  
```

Selecting the type of emergency selcall

- Rotate **Select** to highlight the type of emergency selcall that you want to receive.

DISABLED You will not receive any emergency selcalls

RECEIVE-ALL You will receive all emergency selcalls on channels scanned by your transceiver

SELECTIVE You will receive emergency selcalls sent to your emergency selcall receive ID

- Press **F2(ENTER)**.

If you selected **DISABLED** or **RECEIVE-ALL**, continue from *Returning to Channel mode*.

If you selected **SELECTIVE**, you will see a display that is similar to the following.

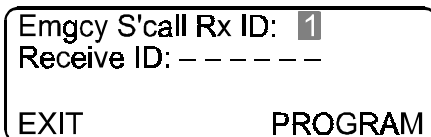

Emgcy S'call Rx ID: 1
Receive ID: - - - - -
EXIT PROGRAM

Entering alternative emergency IDs

- Rotate **Select** until you see the emergency ID that you want to program.
- Press **F2(ENTER)** to see a display that is similar to the following.

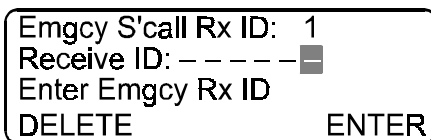

Emgcy S'call Rx ID: 1
Receive ID: - - - - -
Enter Emgcy Rx ID
DELETE ENTER

The display tells you to **Enter Emgcy Rx ID**.

Entering the ID for receiving emergency selcalls

- Enter the emergency receive ID of another station whose calls you want to receive using **Select** and **Volume** (see page 3-14, *Using **Select** and **Volume** to enter information*).
- Press **F2(ENTER)** to save the emergency receive ID.
- If you want to program another emergency ID, repeat the steps from *Entering alternative emergency IDs*.

Returning to Channel mode

- Press **Mode** to return to Channel mode.

Receiving an emergency selcall

When your transceiver receives an emergency selcall, it automatically sends a siren-like revertive to the station that has called.

Your transceiver will ring with a "hee-haw" sound that will repeat for up to five minutes.

Your transceiver will automatically tune itself (except for a tapped whip antenna), then send a siren-like revertive to the calling station.

- Press **PTT** to stop your transceiver from scanning.
- Wait for the station to talk to you, then press and hold **PTT** to respond.

Hold the microphone side-on and close to your mouth. Speak clearly at your normal volume and rate of speech.

- Release **PTT** to hear the reply.

7 Working with voice calls

Voice calls are the simplest type of call to make. Your call can be heard by any station tuned to or scanning your current channel. However, due to the nature of HF radio waves, the success rate of establishing communications with the desired party using voice call only may be low. Successful establishment of communication with a particular party is greatly enhanced with the use of selcall (see page 8-1, *Working with selcalls*).

This chapter describes the following tasks:

- making a voice call (7-2)
- receiving a voice call (7-3)

Making a voice call

Selecting Channel mode

- If you are not in Channel mode, press **Mode** repeatedly until the display for Channel mode appears.

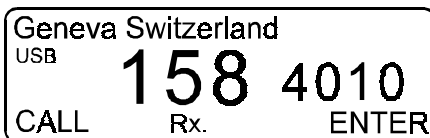

Selecting a channel

- Select the channel on which you want to transmit (see page 4-2, *Selecting a channel*).
- Press **Tune** to tune the antenna.

Making the call

- Wait until the channel is clear of all voice and data traffic.
- Press **PTT**. Hold the microphone side-on and close to your mouth. Speak clearly at your normal volume and rate of speech.
- Release **PTT** to hear the reply.

Receiving a voice call

- Press **PTT** to stop your transceiver from scanning.
- Press **Tune**.
- Wait for the station to talk to you, then press and hold **PTT** to respond.

Hold the microphone side-on and close to your mouth. Speak clearly at your normal volume and rate of speech.

- Release **PTT** to hear the reply.

8 Working with Selcall (Option S, ST)

Selective calling simplifies the calling of other stations. Each transceiver has its own address or ID, rather like a telephone number. You can call a station by specifying its address. If the station is unattended, your call details are automatically recorded.

This chapter describes the following tasks:

- setting up a selcall group (8-2)
- setting the selcall address size compatibility (8-6)
- enabling/disabling selcall lockout (8-8)
- adjusting the call preamble (8-10)
- making a selective beacon call (8-12)
- making a selcall (8-14)
- enabling/disabling selcall mute (8-16)
- receiving a beacon call (8-18)
- enabling/disabling the response to 99-beacon call (8-19)
- receiving a selcall (8-21)
- reviewing calls held in memory (8-22)

Setting up a selcall group

Selcall groups can be set up and assigned to any channel.

Selecting Setup mode

- ❑ Press **Mode** repeatedly until the display for **SETUP MENU** appears.

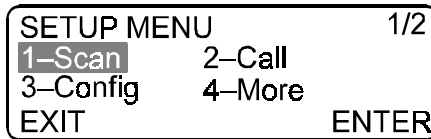

- ❑ Enter the numbers in the following table, using the keypad, to navigate through the Setup menu.

Number	Option	To see display for
2	Call	CALL MENU
1	Selcall	SELCALL MENU
1	ID	SelCall Group

You will see a display that is similar to the following.

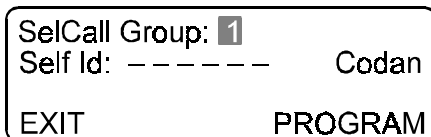

Creating or editing a selcall group

- Enter the number of the selcall group that you want to create or edit using the keypad.
- Press **F2(PROGRAM)** to see a display that is similar to the following.

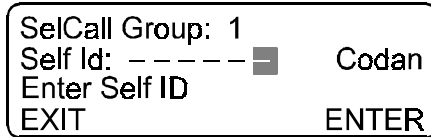

The display tells you to **Enter Self ID**.

Entering the self ID

- Enter the self ID of your station using the keypad.

Your self ID is the number that others will call when they want to communicate with you.

If you have Option ST fitted, enter the number that the network operator asked you to use as your ID when making telcalls.

If you do not want to change the self ID of your station, proceed to the next step.

- Press **Enter/R'call** to see a display that is similar to the following.

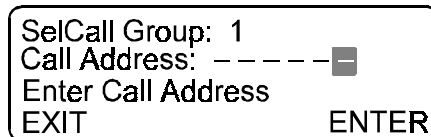

The display tells you to **Enter Call Address**.

Entering the call address

- ❑ If you want to call only one other station from your transceiver, enter the call address for this station using the keypad.

If you want to be able to call any station, leave this address blank.

- ❑ Press **Enter/R'call** to see a display that is similar to the following.

SelCall Group: 1	
Self Id: 1 2 3 4	Codan
Select Selcall Type	
EXIT	ENTER

Setting the type of selcall

- ❑ Rotate **Select** to highlight the option you want.

Codan Used for normal selcalls

RDD Used for secure RDD telcalls—this is only for use with radio telephone network base stations that support encrypted telephone numbers

- ❑ Press **Enter/R'call**.

If you selected **RDD**, you will see a display that is similar to the following.

SelCall Group: 1	
PIN: - - - - -	RDD
Enter RDD PIN	
EXIT	ENTER

Enter the PIN using the keypad, then press **Enter/R'call**. The PIN is a number that you choose. Its purpose is to provide security. The number is encrypted with your self ID when the telcall is sent. This prevents others sending calls on your self ID.

You will see a display that is similar to the following.

SelCall Group: 1	
Self Id:	1 2 3 4 RDD

CLEAR	ENTER

Entering a description for the selcall group

- Enter a description of the selcall group using **Select** and **Volume**.
- Press **Enter/R'call**.
- If you want to program another selcall group, repeat the steps from *Creating or editing a selcall group*.
- Press **Mode** to return to Channel mode.



Any changes that you make to a selcall group that has already been assigned to a channel will automatically be transferred to the channel. For details on how to assign a selcall group to a channel, see page 4-7, *Creating or editing a channel (TxE)* or page 4-13, *Creating or editing a channel (TxD)*.

Setting the selcall address size compatibility

Selcall IDs may be either 4-digit or 6-digit. If you have some stations in your network that can only use 4-digit IDs and some that use 6-digit IDs, you will have to set up those stations using 6-digit IDs to respond to an abbreviated 4-digit ID. The abbreviated ID uses the last four digits of a 6-digit ID.

If you have only 6-digit stations in your network, then it is preferable to set up your station to respond to 6-digit selcalls only. This means that you will not get erroneous calls to the 4-digit compatible number.

Selecting Setup mode

- Press **Mode** repeatedly until the display for **SETUP MENU** appears.

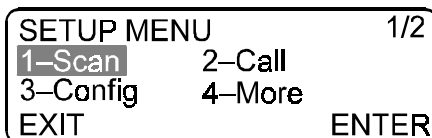

- Enter the numbers in the following table, using the keypad, to navigate through the Setup menu.

Number	Option	To see display for
2	Call	CALL MENU
1	Selcall	SELCALL MENU
3	ID size	S'call Compatibility

You will see a display that is similar to the following.



Setting the address size option

- Rotate **Select** to highlight the option you want.

4-DIGIT-COMPATIBLE Your station will receive calls to its 6-digit ID as well as an abbreviated ID consisting of the last four digits of the 6-digit ID

6-DIGIT-ONLY Your station will receive calls to its 6-digit ID only

- Press **Enter/R'call** to save the selcall ID size.
- Press **Mode** to return to Channel mode.

Enabling/Disabling selcall lockout

Selcall lockout prevents you from making selective calls if your transceiver detects that another station is in process of making a selective call on the same channel as the one on which you want to transmit.

Selcall lockout does not apply to voice or tone calls.

Selecting Setup mode

- Press **Mode** repeatedly until the display for **SETUP MENU** appears.

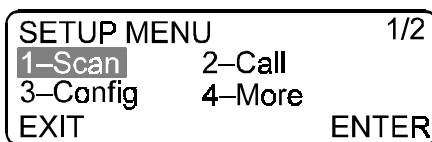

- Enter the numbers in the table, using the keypad, to navigate through the Setup menu.

Number	Option	To see display for
2	Call	CALL MENU
4	More	CALL MENU
4	More	CALL MENU
1	Lockout	S'call Lockout Setup

You will see a display that is similar to the following.

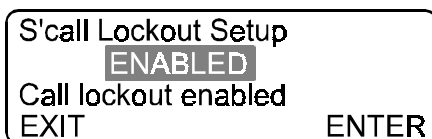

Setting the selcall lockout option

- Rotate **Select** to highlight the option you want.

ENABLED Your station will not be able to make a selcall if the channel is already being used for a selcall by another station

DISABLED Your station will be able to make a selcall at all times (it is not good practice to interrupt another station's call except in an emergency)

- Press **Enter/R'call** to save the selcall lockout option.
- Press **Mode** to return to Channel mode.

Adjusting the call preamble

The call preamble is the initial noise that your transceiver sends when you make a selcall. The preamble alerts the station you are calling. The preamble must be long enough so that if the called station is scanning channels in a scan table, it will be able to cycle through all of the channels in the table within the time span of the preamble. The called station will stop scanning to receive the call. A network using an Automatic Link Establishment (ALE) controller may require a longer preamble time.

Selecting Setup Mode

- Press **Mode** repeatedly until the display for **SETUP MENU** appears.

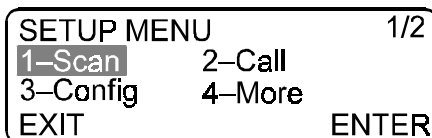

- Enter the numbers in the following table, using the keypad, to navigate through the Setup Menu.

Number	Option	To see display for
2	Call	CALL MENU
4	More	CALL MENU
2	Preamble	Setup Call Preamble

You will see a display that is similar to the following.

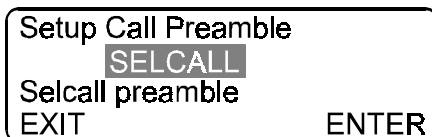

- Rotate **Select** to highlight the option you want.

SELCALL The length of preamble is suitable for making selective calls

ALE The length of preamble is suitable for calling a station that has an ALE controller

- Press **Enter/R'call** to save the preamble option you want.
- Press **Mode** to return to Channel mode.

Making a selective beacon call

You can use a selective beacon to determine which channel will give you the best transmission or reception before making a selcall.

The station to which you make the selective beacon will automatically respond with four beeps if it receives your signal. The quality of these beeps will depend upon the channel used, the time of day and the distance covered (see page 2-3, *Frequency, distance and time of day*). You should beacon the same station over several channels to determine the best signal.



You must have a self ID set up and the channel you select must have a selcall group (see page 8-2, *Setting up a selcall group*).

Selecting Channel mode

- If you are not in Channel mode, press **Mode** repeatedly until the display for Channel mode appears.

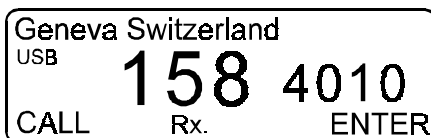

Selecting a channel

- Select the channel on which you want to transmit (see page 4-2, *Selecting a channel*).

Making the beacon call

- Wait until the channel is clear of all voice and data traffic.
- Press **B'con/0** to see a display that is similar to the following.

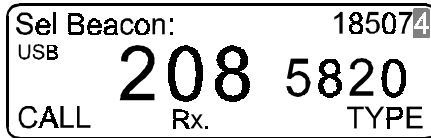

The ID of the last station called is shown at the top of the display.

- Enter the ID of the station to which you want to make the beacon, if it is different from that shown.
- Press **Call**.

You will hear your transceiver making the beacon call. The station you have called should respond within 20 seconds with four reverberate beeps.

If there is no response, then the combination of frequency, time of day and distance is wrong. Try another frequency.

- If you want to test the beacon signal strength on another frequency, repeat the steps from *Selecting a channel*.

Making a selcall



You must have a self ID set up and the channel you select must have a selcall group (see page 8-2, *Setting up a selcall group*).

Selecting Channel mode

- If you are not in Channel mode, press **Mode** repeatedly until the display for Channel mode appears.

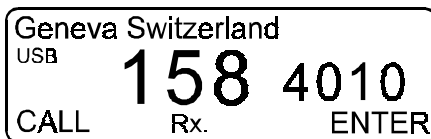

Selecting a channel

- Select the channel on which you want to transmit (see page 4-2, *Selecting a channel*.)

Making the call

- Wait until the channel is clear of all voice and data traffic.
- Press **Call** to see a display that is similar to the following.

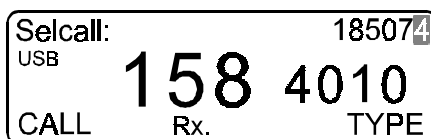

The ID of the last station called is shown at the top of the display.

- Enter the ID of the station to which you want to make the call, if it is different from that shown.

If the transceiver beeps when you enter the number, the channel you are using has been set up with a fixed address (see page 8-2, *Setting up a selcall group*).

Press **Call**.

You will hear your transceiver making the call. The station you have called should respond within 20 seconds with six reverberating beeps. The beeps indicate that the call has successfully reached the station.

Wait for the station to talk to you, then press and hold **PTT** to respond.

Hold the microphone side-on and close to your mouth. Speak clearly at your normal volume and rate of speech.

If the station does not respond to you, your self ID will be registered in the memory of the station that you called, along with the date and time of the call.

Enabling/Disabling selcall mute

Selcall mute allows you to scan a series of channels while muting out all noise from those channels. You will only hear receiver noise from your transceiver when you receive a selcall.

S'call mute scanning overrides the default scan type set for a scan table (see page 5-4, *Creating or editing a scan table*).

Selecting Setup mode

- Press **Mode** repeatedly until the display for **SETUP MENU** appears.

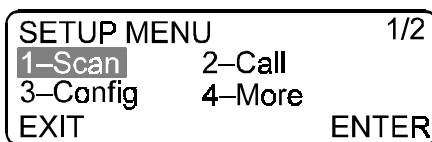

- Enter the numbers in the following table, using the keypad, to navigate through the Setup menu.

Number	Option	To see display for
2	Call	CALL MENU
1	Selcall	SELCALL MENU
2	Mute	Selcall Mute

You will see a display that is similar to the following.

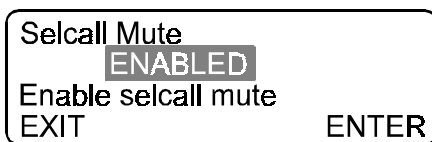

Selecting the mute setting

- Rotate **Select** to highlight the option you want.
 - ENABLED** Selcall mute is enabled
 - DISABLED** Selcall mute is disabled
- Press **Enter/R'call** to save the mute setting you want.
- Press **Mode** to return to Channel mode.

Using selcall mute

- Press **S'call Mute** to block out all noise on your transceiver.
- If you want to pause the scan, press **Voice Mute** (see page 3-21, *Muting the transceiver*).
If you want to resume continuous selcall scanning, press **S'call Mute**.

Receiving a beacon call

When your transceiver receives a selective beacon call, it responds automatically by making a revertive signal to the station that sent the beacon call.

Your transceiver will automatically do the following:

- temporarily pause from scanning
- tune the antenna (if your station has an automatic tuning antenna)
- show **Tx**  on the display

Enabling/Disabling the response to a 99-beacon call

99-beacon calls are used by stations that do not support selective beacon calls. If you have any stations like this in your network, you will need to enable this response to a 99-beacon call.

Selecting Setup mode

- ❑ Press **Mode** repeatedly until the display for **SETUP MENU** appears.

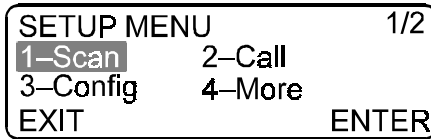

- ❑ Enter the numbers in the following table, using the keypad, to navigate through the Setup menu.

Number	Option	To see display for
2	Call	CALL MENU
4	More	CALL MENU
1	Beacon	99Beacon Setup

You will see a display that is similar to the following.

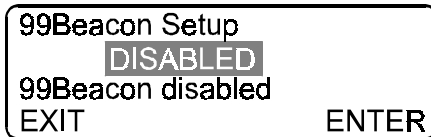

Selecting the 99-beacon call response

- ❑ Rotate **Select** to highlight the option you want.

ENABLED Your station will be able to respond to a 99-beacon call

DISABLED Your station will not be able to respond to a 99-beacon call

- ❑ Press **Enter/R'call** to save the 99-beacon response option.
- ❑ Press **Mode** to return to Channel mode.

Receiving a selcall

When a selcall is detected at your station, your transceiver will pause scanning for 30 seconds and ring in a manner similar to a telephone.

- Press **PTT** to stop your transceiver from scanning and to answer the call.

S'call mute will be switched off automatically.

- Press **PTT**. Hold the microphone side-on and close to your mouth. Speak clearly at your normal volume and rate of speech.
- Release **PTT** to hear the reply.



If you miss the call, your transceiver will beep once every four seconds. To review the call see page 8-22, *Reviewing calls held in memory*.

Reviewing calls held in memory

If your station receives a call while it is unattended, the call will be held in memory. Your transceiver will beep once every four seconds until you press **PTT** or **Enter/R'call**.

Returning the most recent call



Your transceiver must be beeping once every four seconds.

- Press **F1(CALL)**.

Your transceiver automatically makes a selcall to the station that called you most recently.

You will hear your transceiver making the call. The station you have called should respond within 20 seconds with six revertive beeps. The beeps indicate that the call has successfully reached the station.

- Wait for the station to talk to you, then press and hold **PTT** to respond.

Hold the microphone side-on and close to your mouth. Speak clearly at your normal volume and rate of speech.

If the station does not respond to you, your self ID will be registered in the memory of the station that you called, along with the date and time of the call.

Returning a call held in memory

Your transceiver can store up to ten messages in memory, including any calls that you have answered immediately. The last call received has the highest entry number.

If a station has called you more than once on the same channel, only the last entry is retained. If you receive more than ten calls, the first entry in memory is deleted and all calls are moved down one place in the list. Entries for all other call types are deleted in preference to emergency selcalls.

Entries in the call memory are not lost when you switch off your transceiver. An entry can only be removed from the list if you delete it (see page 8-25, *Deleting a call held in memory*) or it is overwritten by a later call.

The following table contains examples of a typical display for each type of call received.

Call	Call memory display	Details
Emergency selcall	<pre>Review: 1 Chan: 208 185074: 23/03 20:18 Emgcy: CALL DELETE</pre>	ID of caller, date and time
Selcall	<pre>Review: 1 Chan: 208 185074: 23/03 20:18 CALL DELETE</pre>	ID of caller, date and time
Telcall	<pre>Review: 1 Chan: 208 185074: 23/03 20:18 Tel:08305031 CALL DELETE</pre>	ID of caller, date, time and telephone number



You must have a self ID set up and the channel you select must have a selcall group (see page 8-2, *Setting up a selcall group*).

Selecting Channel mode

- ❑ If you are not in Channel mode, press **Mode** repeatedly until the display for Channel mode appears.

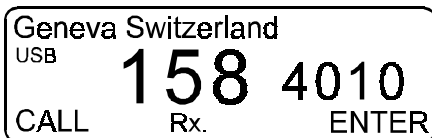

Selecting a call

- ❑ Press **Enter/R'call** to see the display for recalling a channel.

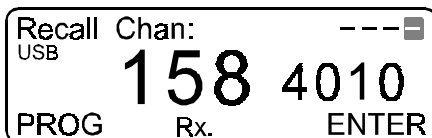

- ❑ Press **Call** to see a display that is similar to the following.

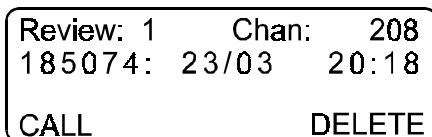

- ❑ Rotate **Select** until you see the call message that you want to return.

Making the call

- ❑ Press **Call**.

You will hear your transceiver making the call. The station you have called should respond within 20 seconds with six reverberating beeps. The beeps indicate that the call has successfully reached the station.

If you do not want to make the call, press **PTT** or **Mode**.

- Wait for the station to talk to you, then press and hold **PTT** to respond.

Hold the microphone side-on and close to your mouth. Speak clearly at your normal volume and rate of speech.

If the station does not respond to you, your self ID will be registered in the memory of the station that you called, along with the date and time of the call.

- If you want to return another call held in memory, repeat the steps from *Selecting a call*.

Deleting a call held in memory

Selecting Channel mode

- If you are not in Channel mode, press **Mode** repeatedly until the display for Channel mode appears.

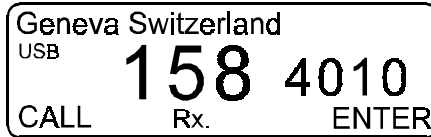

Selecting a call

- Press **Enter/R'call** to see the display for recalling a channel.

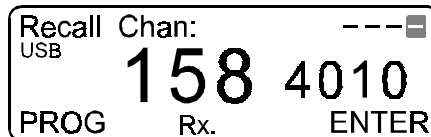

- Press **Call** to see a display that is similar to the following.

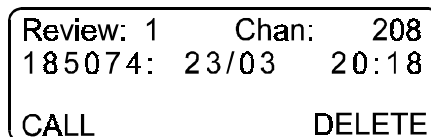

- Rotate **Select** until you see the call message that you want to delete.

Deleting the call

- Press **F2(DELETE)**.
- If you want to delete another call held in memory, select another message, then repeat the steps from *Deleting the call*.
- Press **Mode** to return to Channel mode.

9 Working with telcall (Option ST)

Your transceiver can be used to transmit and receive telephone calls through the Public Switched Telephone Network (PSTN). It can also use a more secure system called the Radphone Direct Dial (RDD) telcall service. This chapter describes the following tasks:

- setting up a telephone directory (9-2)
- enabling/disabling telcalls (9-5)
- making a telcall (9-7)
- receiving a telcall (9-10)

Setting up a telephone directory

If your transceiver has Option ST fitted, you can create a telephone directory. The directory operates like a telephone book that can hold ten telephone entries (numbered 0–9), each consisting of a telephone number and a comment.

You can only access the telephone directory from channels attached to a selcall group. To check the selcall group setting for a channel, see page 4-6, *Viewing the options of a selected channel*.

Selecting Channel mode

- If you are not in Channel mode, press **Mode** repeatedly until the display for Channel mode appears.

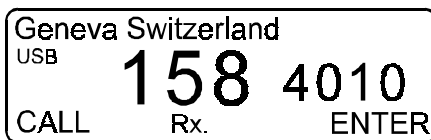

Selecting a channel

- Select a channel that is set up for selcalling (see page 4-2, *Selecting a channel*).

Creating or editing an entry

- Press **Call** to see a display that is similar to the following.

Selcall:	185074
USB	
158	4010
CALL	Rx. TYPE

- Press **Enter/R'call** *twice* to see a display that is similar to the following.

Ch: 149	Tel-Dir: 0
Tel: -----	
CALL	Rx. PROG

Selecting an entry number

- Rotate **Select** until you see the entry that you want to create or edit.
- Press **F2(PROG)** to see a display that is similar to the following.

Edit Tel	Tel-Dir: 3
Tel: -----	
EXIT	Rx. ENTER

- Use the microphone keypad to enter the telephone number.

If you want to cancel an existing number and leave this entry unused, enter 0.

If you do not want to change the number, proceed to the next step.

- ❑ Press **F2(ENTER)** to save the number.

You will see a display that is similar to the following.

Edit Text	Tel-Dir:3
Tel: -----	0883050311
CLEAR	Rx. ENTER

- ❑ If you want to enter a comment, enter each character using **Select** and **Volume** (see page 3-14, *Using **Select** and **Volume** to enter information*).

The comment can be up to 20 characters in length. Use it, for example, to enter the person's name and location.

To clear any existing text, press **F1(CLEAR)**, then enter a new comment if required.

If you do not want to change the text, proceed to the next step.

- ❑ Press **F2(ENTER)** to save the changes.
- ❑ If you want to set up another number, repeat the steps from *Selecting an entry number*.
- ❑ Press **Mode** to return to Channel mode.

Enabling/Disabling telcalls

Selecting Setup mode

- Press **Mode** repeatedly until the display for **SETUP MENU** appears.

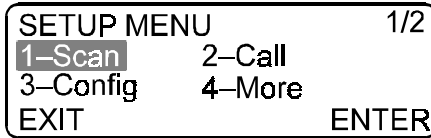

- Enter the numbers in the table, using the keypad, to navigate through the Setup menu.

Number	Option	To see display for
2	Call	CALL MENU
2	Telcall	Telcall Setup

You will see a display that is similar to the following.



Selecting the telcall option

- ❑ Rotate **Select** to highlight the option you want.

ENABLED Your station will be able to respond to telcall

DISABLED Your station will not be able to respond to a telcall

- ❑ Press **Enter/R'call** to save the option you want.
- ❑ Press **Mode** to return to Channel mode.

Making a telcall



You must have a self ID set up and the channel you select must have a selcall group (see page 8-2, *Setting up a selcall group*). The ability to make telcalls must be enabled (see page 9-5, *Enabling/Disabling telcalls*).

Selecting Channel mode

- If you are not in Channel mode, press **Mode** repeatedly until the display for Channel mode appears.

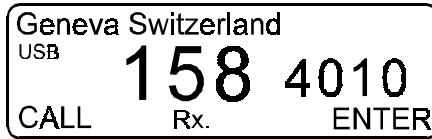

Selecting a channel

- Select the channel on which you want to transmit (see page 4-2, *Selecting a channel*).

Making the call

- Wait until the channel is clear of all voice and data traffic.
- Press **Call** to see a display that is similar to the following.

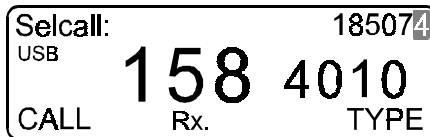

The ID of the last station called is shown at the top of the display.

- Enter the ID of the station to which you want to make the call, if it is different from that shown.

If the transceiver beeps when you enter the number, the channel you are using has been set up with a fixed address (see page 8-2, *Setting up a selcall group*).

- ❑ Press **Enter/R'call** to see a display that is similar to the following.

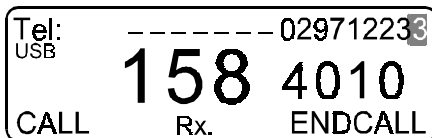

Entering the telephone number

- ❑ Enter the number you want to call using the keypad, if it is different from that shown.

If you want to select a number from the telephone directory, press **Enter/R'call**, then rotate **Select** until you see the number you want to call.

Making the call

- ❑ Press **Call** to see a display that is similar to the following.

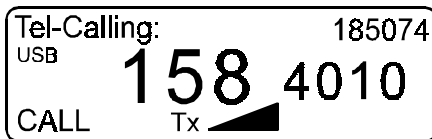

You will hear your transceiver making the call. The station you have called should respond within 20 seconds with four reverting beeps. The beeps indicate that the call has successfully reached the station.

After a pause, you will hear the telephone ring.

- ❑ Wait for the telephone to be answered, then press and hold **PTT** to respond.

Hold the microphone side-on and close to your mouth. Speak clearly at your normal volume and rate of speech.



Your conversation can be monitored by anyone tuned to your transmit frequency.

If the station does not respond to you, your self ID will be registered in the memory of the station that you called, along with the date and time of the call.

Ending the call using the telephone

- Ask the person on the telephone to dial 99 on a DTMF-tone phone before they hang up.

You will hear a disconnect tone consisting of five beeps.

Ending a call using the ENDCALL message

- Press **Call** to see a display that is similar to the following.

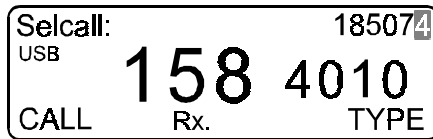

- Press **Enter/R'call** to see a display that is similar to the following.

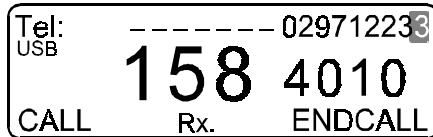

- Press **F2(ENDCALL)** to end the call.

The transceiver transmits the **ENDCALL** message. After several seconds, you will hear a disconnect tone of five beeps. The transceiver reverts automatically to Channel mode.

Receiving a telcall

Telephone subscribers can book a radio-telephone call to you using the public telephone network.

Other users in your own network can send you a telcall (see page 9-7, *Making a telcall*).

When a selcall is detected at your station, your transceiver will pause scanning for 30 seconds and ring, in a manner similar to a telephone.

- ❑ Press **PTT** to stop your transceiver from scanning and to answer the call.

S'call mute will be switched off automatically.

- ❑ Press **PTT**. Hold the microphone side-on and close to your mouth. Speak clearly at your normal volume and rate of speech.

- ❑ Release **PTT** to hear the reply.



If you miss the call, your transceiver will beep once every four seconds. To review the call see page 8-22, *Reviewing calls held in memory*. If you received an RDD telcall but the caller did not include their telephone number, return the call as a selcall instead of a telcall. The telephone operator will know who called you and will help you make the connection.

10 Working with status calls (Option D)

Status calls are used to obtain information from a remote transceiver without assistance from the operator at the remote station.

There are two types of status call:

Type	Description of status call
Remote diagnostics	Obtains diagnostic measurements of the remote transceiver
Remote config call	Obtains some configuration details of the remote transceiver

Diagnostics are a subset of status calls. They are used for providing limited measurements of parameters such as battery voltage, signal strength, voltage Standing Wave Ratio (SWR) and power output.

The topics covered in this chapter are:

- enabling/disabling display of local diagnostics (10-2)
- enabling/disabling the use of status calls (10-4)
- enabling/disabling call privacy (10-6)
- making a status call (10-8)
- receiving a status call (10-13)
- using local diagnostics (10-14)

Enabling/Disabling the display of local diagnostic information

Diagnostic information is useful for service technicians who want to monitor transceiver operation. Different information is displayed when the transceiver is receiving and when the antenna is being tuned. The information appears on the top line of the Channel display.

Operation	Information displayed
Receiving	Receive signal strength (μ V and dB) Battery voltage (V)
Tuning	SWR Battery voltage (V)

Selecting Setup mode

- Press **Mode** repeatedly until the display for **SETUP MENU** appears.

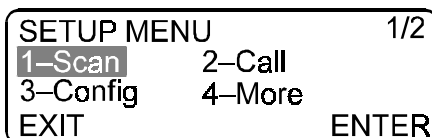

- Enter the numbers in the following table, using the keypad, to navigate through the Setup menu.

Number	Option	To see display for
3	Config	CONFIG MENU
1	Display	DISPLAY MENU
4	dB Volt	dB-Volt Test Display

You will see a display that is similar to the following.



Setting the diagnostic display option

- Rotate **Select** to highlight the option you want.
 - ENABLED** Diagnostic information will be shown at the top of the display for Channel mode
 - DISABLED** Diagnostic information will not be shown
- Press **Enter/R'call** to save the option you want.
- Press **Mode** to return to Channel mode.

Enabling/Disabling the ability to use status calls

Status calls are required when you want to obtain diagnostic or configuration information from a remote transceiver.

Selecting Setup mode

- ❑ Press **Mode** repeatedly until the display for **SETUP MENU** appears.

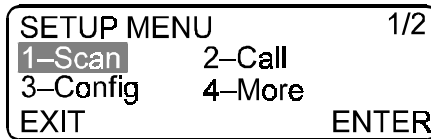

- ❑ Enter the numbers in the following table, using the keypad, to navigate through the Setup menu.

Number	Option	To see display for
2	Call	CALL MENU
4	More	CALL MENU
4	More	CALL MENU
4	More	CALL MENU
2	Status	Status Call Setup

You will see a display that is similar to the following.

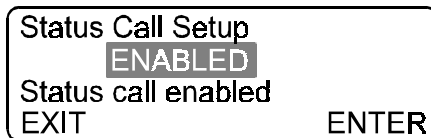

Setting the status call option

- Rotate **Select** to highlight the option you want.

ENABLED You will be able to make and receive status calls

DISABLED You will not be able to make or receive status calls

- Press **Enter/R'call** to save the option you want.
- Press **Mode** to return to Channel mode.

Enabling/Disabling call privacy

Call privacy restricts other parties from receiving your status call information. When you set a privacy key of up to six digits, only other stations using that same privacy key can access your information.

Selecting Setup mode

- Press **Mode** repeatedly until the display for **SETUP MENU** appears.

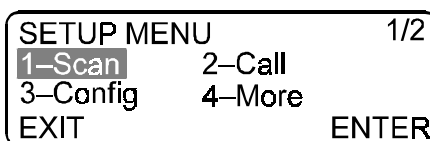

- Enter the numbers in the following table, using the keypad, to navigate through the Setup menu.

Number	Option	To see display for
2	Call	CALL MENU
4	More	CALL MENU
4	More	CALL MENU
3	Privacy	Enter Privacy Key

If a privacy key is not set, you will see the following display.

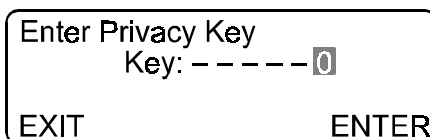

If a privacy key is set, you will see the following display.

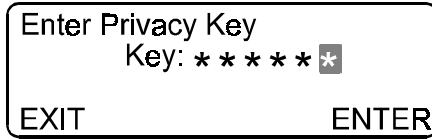

Setting the privacy key

- If you want to set a privacy key, enter the number using the keypad, then press **Enter/R'call**.

Continue at *Returning to Channel mode*.

- If you want to remove the privacy key, enter 0 using the keypad, then press **Enter/R'call**.

Returning to Channel mode

- Press **Mode** to return to Channel mode.

Making a status call



You must have a self ID set up and the channel you select must have a selcall group (see page 8-2, *Setting up a selcall group*). The station you are calling should also be set up to receive status calls. You may need to set a privacy key (see page 10-6, *Enabling/Disabling call privacy*).

The diagnostic status call generates a sequence of actions at the called station that measure various operating parameters. This information is sent back to the calling station as a revertive signal.

The configuration status call requests information on the software and fitted options at the called station. This information is sent back to the calling station as a revertive signal.

Selecting Channel mode

- If you are not in Channel mode, press **Mode** repeatedly until the display for Channel mode appears.

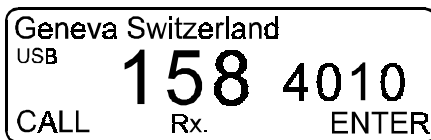

Selecting the channel

- Select the channel on which you want to transmit (see page 4-2, *Selecting a channel*).

Making the call

- Wait until the channel is clear of all voice and data traffic.
- Press **Call** to see a display that is similar to the following.

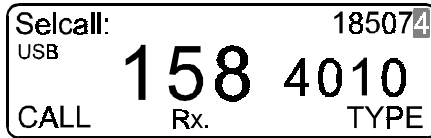

The ID of the last station called is shown at the top of the display.

- Press **F2(TYPE)** repeatedly until you see the display for **Status Call**.

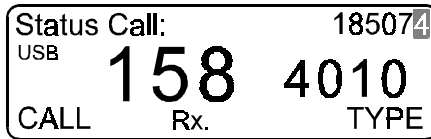

- Enter the ID of the station to which you want to make the status call, if it is different from that shown.
- Press **Call** to see a display that is similar to the following.

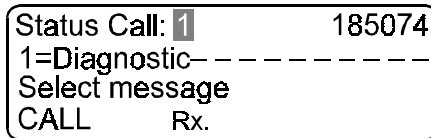

Setting the type of status call

- Rotate **Select** to highlight the option you want.

- | | |
|----------------------|-------------------------------------------|
| Diagnostic | You will make a diagnostic status call |
| Configuration | You will make a configuration status call |

Press **Call**.

You will hear your transceiver making the call. You will see a display similar to the following while you wait for a reply.

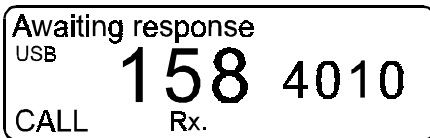

If the call is successful, the display will return to Channel mode. If you want to view the results of the status call, continue from *Viewing the results of a status call*.

If the call is still unsuccessful after 60 seconds, your transceiver will beep and you will see a display that is similar to the following.

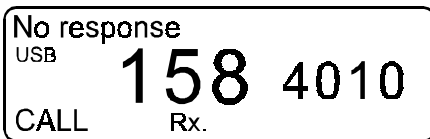

If you want to try the status call on another channel, repeat the steps from *Selecting the channel*.

Viewing the results of a status call

- If you want to view the results of a status call, press **Enter/R'call** to see the display for recalling a channel.

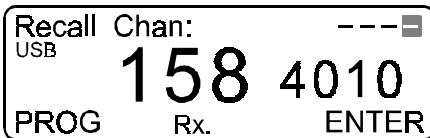

- Press **Call** to see a display that is similar to the following.

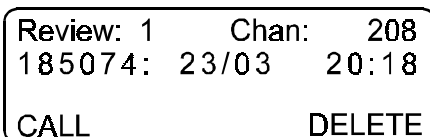

- ❑ Rotate **Select** until you see the status call message that you want to view.

If you want to view a diagnostic status call, you will see a display that is similar to the following.

Review: 1	Chan:	208
185074	23/03	20:18
Rx=11.2V	Tx=10.3V	
CALL	DELETE	

The second line of the display contains the ID of the station that sent the diagnostic information, the date and the time of the call.

The following information will scroll across the third line of the display.

This term Means

Rx=	Battery voltage during receive, measured in volts
Tx=	Battery voltage during tuning, measured in volts
S1=	Strength of signal while receiving the call, measured in μV EMF
S2=	Strength of signal two seconds after the call was received, measured in μV EMF
Gain=	Setting of RF gain
SWR=	Standing Wave Ratio of the antenna at the end of an auto-tune
Pwr=	Output power of the transceiver
PA=	Output of the PA

For an explanation of diagnostic information, see page 10-14, *Using diagnostic information*.

If you want to view a configuration status call, you will see a display that is similar to the following.

```
Review: 1      Chan: 208
185074 23/03 20:18
S SLO TxE ES AM
CALL                               DELETE
```

The second line of the display contains the ID of the station that sent the configuration information, the date and the time of the call.

The following information will scroll across the third line of the display.

This term	Means
nnn- <u>nnn</u> /nn.nn	Last six digits of 90-20nnn- <u>nnn</u> software set number and software version number (nn.nn) for the main processor
nnn- <u>nnn</u> /n.nn	Last six digits of 90-20nnn- <u>nnn</u> software set number and software version number (nn.nn) for the control head
TxE/TxD	Channel programming capability
S	Selcall fitted
ST	Selcall and telcall fitted
ES	Emergency selcall fitted
AM	AM transmission fitted

- Press **Mode** to return to Channel mode.

Receiving a status call

If you want to receive status calls, you must enable the ability to use status calls (see page 10-4, *Enabling/Disabling the ability to use status calls*).

Your transceiver will respond automatically to a status call.

Using diagnostic information

Diagnostic information is used by technicians during installation, fault finding or routine checking of equipment.

The signal strength in μV or dB is a measure of the signal being received. The value of the signal strength will vary according to conditions.

The battery voltage is a measure of the voltage supplied by the car battery from which your transceiver draws its power supply. If your car engine is running, the battery voltage should be between 14 and 14.5 volts. If the engine is turned off, the battery voltage should be greater than 11.5 volts.

The standing wave ratio (SWR) should be less than two—the lower, the better. The SWR will depend largely on the quality of the antenna installation and the close proximity of large metal objects.

11 Other features

This chapter describes the following additional features of the transceiver:

- setting the frequency display mode (11-2)
- changing power up settings (11-4)
- changing **PTT** settings (11-9)
- using the transceiver as a free tune receiver (11-12)
- setting up a tone call group (11-16)
- making a tone call (11-18)
- cloning a transceiver (11-20)
- enabling transceiver options using a password (11-22)
- enabling/disabling RF gain (11-25)

Setting the frequency display mode

The frequency can be displayed in three ways.

With channels that have a different transmit and receive frequency, the transmit frequency will appear above the receive frequency if the display is set up to show **RX/TX**. These channels are known as two-frequency simplex channels. An arrow on the display moves from the receive frequency to the transmit frequency during transmission.

For other channels, where the transmit and receive frequencies are the same, this setting displays the single frequency.

The **RX ONLY** setting displays the frequency in use, whether single frequency or two-frequency simplex. The frequency shown during transmission is the transmit frequency.

If the display has been set to **INHIBIT**, no frequency will be displayed.

Selecting Setup mode

- Press **Mode** repeatedly until the display for **SETUP MENU** appears.

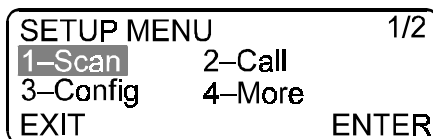

- Rotate **Select** to highlight each option, then press **F2(ENTER)**, to navigate through the Setup menu.

Number	Option	To see display for
3	Config	CONFIG MENU
1	Display	DISPLAY MENU
3	Format	Freq. display format

You will see a display that is similar to the following.

```

Freq. display format
  RX/TX
Show Tx and Rx freq
EXIT                               ENTER
  
```

Setting the type of frequency display

- Rotate **Select** to highlight the option you want.

RX/TX The transmit frequency is displayed above the receive frequency; an arrow points to whichever frequency is currently being used

INHIBIT No frequency is shown on the display

RX ONLY The receive frequency only is shown on the display



If you select **INHIBIT**, you will deactivate Free Tune Receiver mode.

- Press **F2(ENTER)** to save the change.
- Press **Mode** to return to Channel mode.

Changing the power up settings

When the transceiver is switched on, a message may be displayed, a mute may be applied, and/or your address may be displayed briefly. You can set any of these options as required.

Enabling the power up message

A message of your choice may be displayed when the transceiver is switched on.

Selecting Setup mode

- Press **Mode** repeatedly until the display for **SETUP MENU** appears.

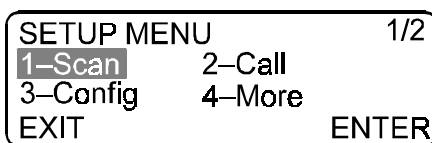

- Rotate **Select** to highlight each option, then press **F2(ENTER)**, to navigate through the Setup menu.

Number	Option	To see display for
3	Config	CONFIG MENU
4	More	CONFIG MENU
4	More	CONFIG MENU
1	PowerUp	POWER UP MENU
1	Message	Power Up Message

You will see a display that is similar to the following.



- ❑ Rotate **Select** to highlight the option you want.

ENABLED A message will be displayed each time you switch on your transceiver

DISABLED No message will be displayed when you switch on your transceiver

- ❑ Press **F2(ENTER)** to save the option you want.

If you selected **DISABLED**, continue from *Returning to Channel mode*.

If you selected **ENABLED**, you will see a display that is similar to the following.

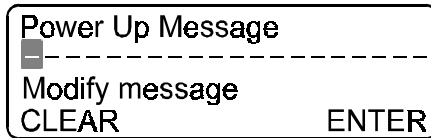

Enter the message using **Select** and **Volume** (see page 3-14, *Using **Select** and **Volume** to enter information*).

If you want to clear an existing message, press **F1(CLEAR)**, then enter a new message if required.

If you do not want to change the message, proceed to the next step.

- ❑ Press **F2(ENTER)**.

Returning to Channel mode

- ❑ Press **Mode** to return to the Channel mode.

Changing the power up mute setting

This procedure is used to select the initial mute setting that will apply when the transceiver is switched on.

You can select:

- **NO MUTE**
- **AUDIO MUTE**
- **SELCALL MUTE** (if selcall mute availability is switched on)

Selecting Setup mode

- Press **Mode** repeatedly until the display for **SETUP MENU** appears.

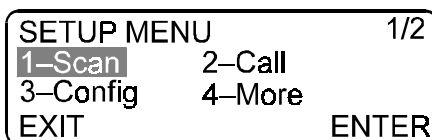

- Rotate **Select** to highlight each option, then press **F2(ENTER)**, to navigate through the Setup menu.

Number	Option	To see display for
3	Config	CONFIG MENU
4	More	CONFIG MENU
4	More	CONFIG MENU
1	PowerUp	POWER UP MENU
2	Mute	Mute Power Up

You will see a display that is similar to the following.



Selecting the power up mute setting

- Rotate **Select** to highlight the option you want.

NO MUTE No mute will be applied when you switch on your transceiver

AUDIO MUTE Voice mute will be applied when you switch on your transceiver

SELCALL MUTE Selcall mute will be applied when you switch on your transceiver if selcall mute is available (see page 8-16, *Enabling/Disabling selcall mute*)
(Option S or ST)

- Press **F2(ENTER)** to save the power up mute setting.
- Press **Mode** to return to Channel mode.

Enabling/Disabling the power up address display

This procedure is used to select whether or not your address (set up in selcall group 1) is displayed for several seconds when the transceiver is switched on.

Selecting Setup mode

- Press **Mode** repeatedly until the display for **SETUP MENU** appears.

SETUP MENU		1/2
1-Scan	2-Call	
3-Config	4-More	
EXIT		ENTER

- ❑ Rotate **Select** to highlight each option, then press **F2(ENTER)**, to navigate through the Setup menu.

Number	Option	To see display for
3	Config	CONFIG MENU
4	More	CONFIG MENU
4	More	CONFIG MENU
1	PowerUp	POWER UP MENU
3	Show ID	Power Up Self ID

You will see a display that is similar to the following.

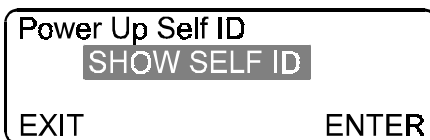

Selecting the power up display setting

- ❑ Rotate **Select** to highlight the option you want.

SHOW SELF ID Your self ID (set in selcall group 1) will be shown briefly when you switch on your transceiver

HIDE SELF ID No self ID will be shown when you switch on your transceiver

- ❑ Press **F2(ENTER)** to save the display option you want.
- ❑ Press **Mode** to return to Channel mode.

Changing PTT settings

The **PTT** settings of your transceiver can be customised to suit your requirements. You can set:

- **PTT** release beep on or off
- **PTT** transmit cut out time

Enabling PTT release beep

The **PTT** can be set to emit a beep when you release it. When this feature is on, the transceiver automatically indicates that you have finished talking by making a beep when you release **PTT**. This saves you from having to say 'over' every time you release the button.

You do not hear the beeps at your station.

Selecting Setup mode

- Press **Mode** repeatedly until the display for **SETUP MENU** appears.

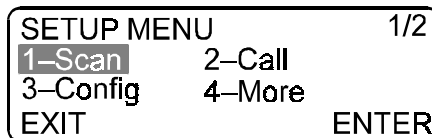

- Rotate **Select** to highlight each option, then press **F2(ENTER)**, to navigate through the Setup menu.

Number	Option	To see display for
3	Config	CONFIG MENU
4	More	CONFIG MENU
3	PTT	CONFIG PTT MENU
2	PTT Beep	PTT Beeps

You will see a display that is similar to the following.

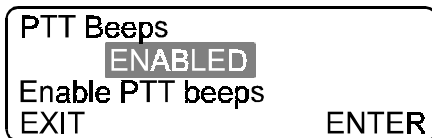

Selecting the PTT beep option

- Rotate **Select** to highlight the option you want.

ENABLED Your transceiver will send a beep to the called station when you release PTT

DISABLED Your transceiver will not send any beep when you release PTT

- Press **F2(ENTER)** to save the PTT beep option you want.
- Press **Mode** to return to Channel mode.

Enabling and setting the PTT transmit cut out time

The **PTT** can be set up with a cut out time that prevents it from being left on in the transmit state by mistake. If the transmit time exceeds the time set for **PTT** transmit cut out, the transceiver switches to receive and displays an error message.

Selecting Setup mode

- Press **Mode** repeatedly until the display for **SETUP MENU** appears.

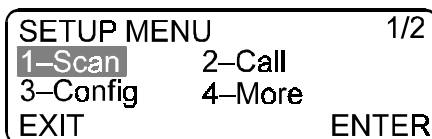

- Rotate **Select** to highlight each option, then press **F2(ENTER)**, to navigate through the Setup menu.

Number	Option	To see display for
3	Config	CONFIG MENU
4	More	CONFIG MENU
3	PTT	PTT CONFIG MENU
1	Timer	PTT cutout timer

You will see a display that is similar to the following.



Selecting the timer cut out

- Rotate **Select** to highlight the option you want.

OFF The transceiver never cuts out during transmission

5, 10, 15, 20, 25, 30, 35 The transceiver cuts out during transmission after the period of time chosen has lapsed

- Press **F2(ENTER)** to save the cutout time you want.
- Press **Mode** to return to Channel mode.

Using the transceiver as a free tune receiver

Your transceiver can be used as a free tune receiver covering the receiver world broadcast bands over the transceiver's operating range of 250 kHz to 30 MHz.

Using the transceiver as a free tune receiver allows you to tune it to any frequency in its operating range.

You can temporarily change the frequency of the current channel or you can enter a new frequency directly. When you return to Channel mode, the frequency is reset to the original value.

If you want to save the frequency you set in Free Tune Receiver mode, you must create a channel that has this frequency (see page 11-15, *Creating a receive-only channel*).

Enabling/Disabling Free Tune Receiver mode

Selecting Setup Mode

- Press **Mode** repeatedly until the display for **SETUP MENU** appears.

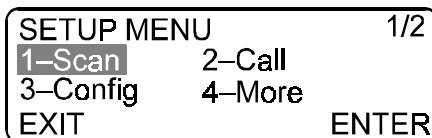

- Rotate **Select** to highlight each option, then press **F2/ENTER**, to navigate through the Setup Menu.

Number	Option	To see display for
3	Config	CONFIG MENU
4	More	CONFIG MENU
4	More	CONFIG MENU
2	Receiver	Receive Frequencies

You will see a display that is similar to the following.



- Rotate **Select** to highlight the option you want.

ENABLED You will be able to select Free Tune Receiver mode

DISABLED You will not be able to select Free Tune Receiver mode

- Press **F2(ENTER)** to save the option you want.
- Press **Mode** to return to Channel mode.



If you have enabled Free Tune Receiver mode but you are still unable to see it as you cycle through the modes, it may be disabled as a side-effect of inhibiting the display of frequencies or not allowing recall by channel frequency (see page 11-2, *Setting the frequency display mode* and page 4-3, *Selecting a channel by recalling its receive frequency*).

Setting a receive frequency

Selecting Free Tune Receiver mode

- Press **Mode** repeatedly until the display for Free Tune Receiver mode appears:

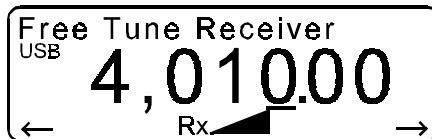

The frequency shown is that of the current channel.

□ Press **Tune**.

Type of antenna	Tuning method
Automatic tuning whip	Turn off Voice or S'call Mute , then press Tune
Long wire with automatic antenna tuner	Turn off Voice or S'call Mute , then press Tune
Tapped whip antenna	Select a tap closest to the receive frequency—cannot effectively tune the transceiver in Free Tune Receiver mode using a manual antenna

Note that tuning the antenna at this stage is effective over a broad band of frequencies. It is not necessary to tune the antenna again while the transceiver is in Free Tune Receiver mode.

□ Enter the frequency using **Select**, **F1(←)** and **F2(→)**.

Use **F1** and **F2** in place of **Volume** to move between digits (see page 3-14, *Using **Select** and **Volume** to enter information*). In Free Tune Receiver mode, **Volume** is required to regulate the volume of the received signal.

If you have Option S or ST fitted, you can enter the frequency using the numeric keypad. Press **Enter/R'call** to see a display that is similar to the following.

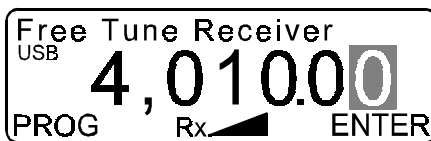

Enter the frequency in kHz to two decimal places. For example, a frequency of 3920 kHz must be entered as 392000. Press **Enter/R'call** to return to Free Tune Receiver mode.

The frequency is now set and you can listen in to traffic on the channel.

Creating a receive-only channel

- If you want to create a receive-only channel from the frequency to which you have free tuned, press **F1(PROG)**, then continue from page 4-14, *Entering the channel number*.

Returning to Channel mode

- Press **Mode** to return to Channel mode.

The frequency is automatically reset to the original value.

Setting up a tone call group

Tone calls are used in some networks to allow mobile operators to alert base station operators. They do not allow addressing of specific stations.

Tone call groups can be set up and assigned to any channel. The tone frequencies can be set in the range 300 to 2800 Hz.

Selecting Setup mode

- Press **Mode** repeatedly until the display for **SETUP MENU** appears.

```

SETUP MENU 1/2
1-Scan 2-Call
3-Config 4-More
EXIT ENTER
  
```

- Rotate **Select** to highlight each option, then press **F2(ENTER)**, to navigate through the Setup menu.

Number	Option	To see display for
2	Call	CALL MENU
3	Tone	Tone Pair

You will see a display that is similar to the following.

```

Tone Pair: 1
Hi: - - - - Hz Low: - - - - Hz
EXIT PROGRAM
  
```

Creating or editing a tone call group

- Rotate **Select** until you see the tone pair group that you want to create or edit.
- Press **F2(PROGRAM)**.
- Enter the high frequency of the tone pair using **Select** and **Volume** (see page 3-14, *Using Select and Volume to enter information*).

If you do not want to change the high frequency, proceed to the next step.

- Press **F2(ENTER)**.
- Enter the low frequency of the tone pair using **Select** and **Volume**.

If you do not want to change the low frequency, proceed to the next step.

- Press **F2(ENTER)**.
- If you want to edit or create another tone pair, repeat the steps from *Creating or editing a tone call group*.
- Press **Mode** to return to Channel mode.



Any changes that you make to a tone call group that has already been assigned to a channel will automatically be transferred to the channel. For details on how to assign a tone call group to a channel, see page 4-7, *Creating or editing a channel (TxE)* or page 4-13, *Creating or editing a channel (TxD)*.

Making a tone call

Selecting Channel mode

- ❑ If you are not in Channel mode, press **Mode** repeatedly until the display for Channel mode appears.

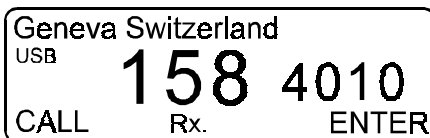

Selecting a channel

- ❑ Rotate **Select** until you see the channel on which you want to transmit.

The channel must have a tone call group (see page 4-6, *Viewing the options of a selected channel*, page 4-7, *Creating or editing a channel (TxE)* and page 4-13, *Creating or editing a channel (TxD)*).

Making the call

- ❑ Press **F1(CALL)** to see the display for **Tone Call**.

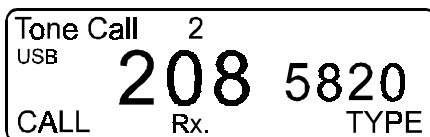

If you have Option S or ST, the display may show the last selcall number called. Press **F2(TYPE)** until you see the display for **Tone Call**.

- ❑ Press **F1(CALL)** and hold down for 10 seconds.
You will hear the tone call being sent. You will *not* hear a revertive signal from the station you have called.
- ❑ Wait for the operator at the station you have called to respond, then press **PTT**. Hold the microphone side-on and close to your mouth. Speak clearly at your normal volume and rate of speech.

Cloning a transceiver

Cloning copies the settings from one transceiver to another. This allows you to set up several transceivers that all work in exactly the same way, without having to set up each one individually.

Cloning is done by connecting the microphone socket of the transceiver that is already set up (the master) to the microphone socket of the transceiver that is to become a clone.

You can obtain the cable required for this procedure from any authorised Codan dealer.

The part number is Codan 08-05138-001.

The cloning procedure over-writes all settings in the transceiver to which you are copying, except for the PIN and selcall group information.

- Connect the microphone sockets of the two transceivers using the cloning cable.
- Switch on both transceivers.

Selecting Setup mode on the master transceiver

- Press **Mode** repeatedly until the display for **SETUP MENU** appears.

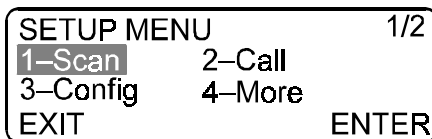

- Rotate **Select** to highlight each option, then press **F2(ENTER)**, to navigate through the Setup menu.

Number	Option	To see display for
4	More	SETUP MENU
3	Clone	Clone transceiver

Clone transceiver.
Connect cable and
press F2 to begin
EXIT ENTER

- ❑ Press **F2(ENTER)** to begin the transfer of information.

Clone transceiver.

▶◀▶◀▶◀▶◀▶◀▶◀▶◀▶◀▶◀▶◀▶◀▶◀▶◀▶◀▶◀▶◀▶◀▶

After about two minutes, cloning finishes and the master transceiver beeps twice. You will see the following display.

Please remove the
cloning cable to
return to the Setup
menu

Disconnect the cable and switch off both transceivers.

Enabling transceiver options using a password

This procedure is used to enable options that are built into your transceiver. It is also used to recover the use of your transceiver if you forget the PIN for your transceiver.

If you want to purchase an additional feature for your radio, contact your Codan representative. They will give you a password that will enable the option. There is a separate password for each transceiver option. Each password is unique to your transceiver.

If you want to disable an option that you have previously enabled by password, repeat this procedure with the same password.



You must have a keypad microphone to complete this task. If you do not have a keypad microphone, contact your Codan representative.

Finding the ID of your transceiver

Selecting Setup mode

- Press **Mode** repeatedly until the display for **SETUP MENU** appears.

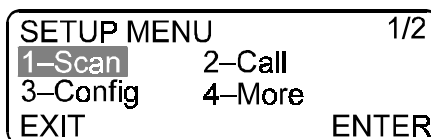

- Enter the numbers in the following table, using the keypad, to navigate through the Setup menu.

Number	Option	To see display for
4	More	SETUP MENU
2	Password	PASSWORD

You will see a display that is similar to the following.

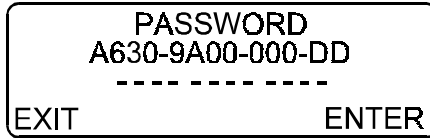

Write down the number shown on the display of your transceiver. This is the ID of your transceiver.

- Contact your Codan representative for a password—you will need the ID of your transceiver.

Entering a password

Selecting Setup mode

- Press **Mode** repeatedly until the display for **SETUP MENU** appears.

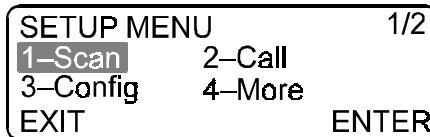

- Enter the numbers in the following table, using the keypad, to navigate through the Setup menu.

Number	Option	To see display for
4	More	SETUP MENU
2	Password	PASSWORD

You will see a display that is similar to the following.

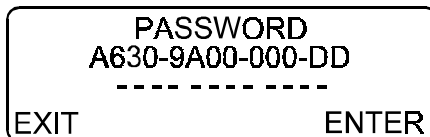

Entering the password

- ❑ Enter the password that you obtained from Codan.

If you enter the password correctly, you will see a display that is similar to the following.

```

      PASSWORD
      A630-9A00-000-DD
Local Diag enabled
EXIT                               ENTER

```

If you enter the password incorrectly, you will see a display that is similar to the following.

```

      PASSWORD
      A630-9A00-000-DD
Password invalid
EXIT                               ENTER

```

The transceiver will switch off automatically. Switch on the transceiver then repeat the steps from *Entering a password*.

- ❑ Press **Mode** to return to Channel mode.



If you need to enter a password to regain access to your transceiver (after forgetting your PIN), press **Mode** while viewing the PIN entry screen. Enter the password to delete the PIN.

Enabling/Disabling RF gain

The RF gain changes the receive sensitivity of the transceiver.

Selecting Setup Mode

- Press **Mode** repeatedly until the display for **SETUP MENU** appears.

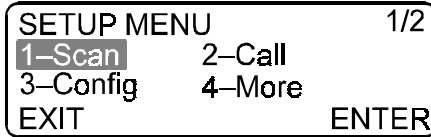

- Rotate **Select** to highlight each option, then press **F2/ENTER**, to navigate through the Setup Menu.

Number	Option	To see display for
3	Config	CONFIG MENU
4	More	CONFIG MENU
4	More	CONFIG MENU
3	RF Gain	RF Gain Control

You will see a display that is similar to the following.

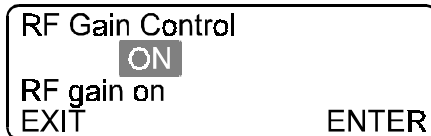

- ❑ Rotate **Select** to highlight the option you want.
 - ON** You should use this option for a mobile station or for an area where electrical interference is low
 - OFF** You should use this option for a base station that has large antennae or for an area where electrical interference is high
- ❑ Press **F2(ENTER)** to save the option you want.
- ❑ Press **Mode** to return to Channel mode.

Index

address
 call, 8-4
 display, 11-7
 self, 8-3
AM, 2-2, 2-23
antenna, 11-14
 automatic tuner, 11-14
 automatic tuning whip, 3-17, 11-14
 long wire, 3-18, 11-14
 tapped whip, 3-18, 11-14
 tuning, 3-17

A

base station, 2-22
battery voltage, 10-1, 10-14
beacon call
 99-beacon, 8-19
 receiving, 8-18
beep
 loudness, 3-8
 PTT, 11-9

B

call
 preamble, 8-10
 privacy, 10-6
callsign, 2-7
channel, 2-5, 2-9, 4-1
 comment, 2-16, 4-7, 4-13
 creating, 4-7, 11-15
 deleting, 4-19
 editing, 4-7
 frequency, 2-16, 4-3, 4-4
 manual selection, 6-7
 number, 2-17, 4-2
 preset, 6-6

C

 programming, 4-5
 protection, 2-17, 4-7, 4-13
 receive-only, 2-16
 selecting, 4-2
 simplex, 11-2
channel programming
 free tune receiver, 11-15
 TxD, 2-11, 2-18
 TxE, 2-11, 4-7
clock
 calibrating, 3-12
 setting, 3-9
cloning, 2-11, 11-20
configuration information, 10-12
control
 extended, 2-14, 2-23
 front panel, 2-14, 2-23
controls
 extended, 2-9
 front panel, 2-9
 multi, 2-9
cutout, 11-10

D

dB Volt, 10-3
diagnostic information, 10-11, 10-14
 display, 10-2
display, 2-9
distance, 2-3, 2-4
DTMF tone, 9-9

E

emergency selcall, 2-11
 making, 6-6
 preset channels, 6-6
 receive address, 6-11
 receive ID, 6-11
 receiving, 6-12

- setting up to make, 6-2
- setting up to receive, 6-9
- type, 6-10

enabling options

- password, 11-22

endcall, 9-9

etiquette, 2-7

F

free tune receiver, 11-12

frequency, 2-3

- display, 11-2
- low, 2-3
- range, 2-6
- receive, 4-7, 4-13
- transmit, 4-7

HF, 2-2

HF propagation

- direct, 2-2
- ground, 2-2
- sky, 2-3

high frequency, 2-2

H

ID

- self, 8-3

ionosphere, 2-3

IPC-500, 2-21

L

LCD

- brightness, 3-6
- contrast, 3-7

local diagnostics, 2-22

M

memory

- deleting a call, 8-25
- returning calls, 8-23
- reviewing calls, 8-22

message

- power up, 11-4

microphone

- keypad, 2-13, 2-19
- standard, 2-13
- using, 3-20

mobile station, 2-22

mode

- Channel, 2-10, 2-16, 3-4
- Channel Options, 2-10, 3-4, 4-6
- Clarifier, 2-10, 3-4, 3-19
- Free Tune Receiver, 2-10, 3-4, 4-5, 11-14
- operating, 2-10, 3-4
- Setup, 2-10, 3-4
- View All Settings, 2-10, 3-5, 3-15

morse code, 2-23

mute, 3-21

- selcall, 8-16
- setting, 11-6

N

network, 2-22

O

option

- AM, 2-23, 3-16
- D, 2-22
- LF, 2-23
- M, 2-23
- PH, 2-13, 2-23
- S, 2-18
- ST, 2-21

password
 entering, 11-23
 phonetic alphabet, 2-7
 PIN
 entering, 3-2
 power
 off, 3-3
 on, 3-2
 output, 10-1
 power up
 message, 11-4
 mute, 11-6
 settings, 11-4
 preamble, 8-10
 privacy key, 10-6
 private network, 2-22
 PSTN, 9-1
 PTT
 cutout, 11-10
 release beep, 11-9
 settings, 11-9

radio-telephone call, 9-10
 RDD, 9-1, 9-7
 receiver
 free tune, 11-12
 remote configuration, 10-1
 remote diagnostics, 10-1

S'call Mute
 using, 8-17

scan
 automatic return to, 5-11
 cont, 5-6
 hold, 3-21, 5-6
 incoming calls, 5-10, 5-11
 pause, 3-21, 5-6
 selcall, 5-6
 scan table
 adding a channel, 5-7
 creating, 5-4

P

default scan type, 5-6
 deleting a channel, 5-7
 deleting a scan table, 5-8
 editing, 5-2, 5-4
 name, 5-5
 selcall
 address, 8-1
 address size, 8-6
 ID, 8-1
 ID size, 8-6
 lockout, 8-8
 making, 8-14
 mute, 8-16
 receiving, 8-21
 selcall address, 2-18
 selcall group, 4-7
 description, 8-5
 setting up, 8-2
 selcall ID, 2-18
 Select, 3-7, 3-14
 selective beacon
 making, 8-12
 selective calling, 8-1
 self address, 8-3
 self ID, 8-3, 8-12, 11-8
 sideband, 2-16, 4-7, 4-13

R

double, 2-2
 lower, 3-16
 LU, 2-11
 single, 2-2
 upper, 3-16
 signal

S

clarify, 3-19
 signal strength, 2-17, 10-1, 10-14
 SSB, 2-2
 standing wave ratio, 10-1, 10-14
 status call
 call privacy, 10-6
 configuration, 10-8
 diagnostic, 10-8
 enabling, 10-4
 making, 10-8

Index

receiving, 10-13
reviewing results, 10-10

telcall
 making, 9-7
 receiving, 9-10
telephone, 2-22
telephone directory
 creating, 9-2
 editing, 9-2
time of day, 2-3
tone call, 11-16
 frequency range, 11-16
 making, 11-18
 receiving, 7-3
tone call group, 4-7
 setting up, 11-16
transceiver
 cloning, 11-20
 password, 11-22
tuners, 11-14

T

tuning, 11-14
TxD, 2-11, 2-18
TxE, 2-11, 4-7
types of call
 emergency selcall, 6-1
 selcall, 8-1
 status, 10-1
 telcall, 9-1
 tone, 11-16
 voice, 7-1
types of calls
 emergency selcall, 2-12
 selcalls, 2-18
 tone, 2-12
 voice, 2-12

V

voice call, 7-1
 making, 7-2
 receiving, 7-3
volume, 3-6, 3-14