

CONTENTS

GENERAL	2	ADJUSTMENT	33
SYSTEM SET-UP	2	PC BOARD VIEWS	
OPERATING FEATURES	3	DISPLAY UNIT (X54-3250-10)	45
REALIGNMENT	7	TX-RX UNIT (X57-588X-XX)	47
DISASSEMBLY FOR REPAIR	15	SCHEMATIC DIAGRAM	53
CIRCUIT DESCRIPTION	16	BLOCK DIAGRAM	57
SEMICONDUCTOR DATA	20	LEVEL DIAGRAM	59
DESCRIPTION OF COMPONENTS	22	KNB-14/KNB-15A (Ni-Cd BATTERY)	60
PARTS LIST	23	OPTIONS	61
EXPLODED VIEW	31	SPECIFICATIONS	BACK COVER
PACKING	32		

GENERAL / SYSTEM SET-UP

INTRODUCTION

SCOPE OF THIS MANUAL

This manual is intended for use by experienced technicians familiar with similar types of commercial grade communications equipment. It contains all required service information for the equipment and is current as of the publication date. Changes which may occur after publication are covered by either Service Bulletins or Manual Revisions. These are issued as required.

ORDERING REPLACEMENT PARTS

When ordering replacement parts or equipment information, the full part identification number should be included. This applies to all parts, components, kits, or chassis. If the part number is not known, include the chassis or kit number of which it is a part, and a sufficient description of the required component for proper identification.

Unit Model & destination		TX-RX Unit	Display Unit	Frequency range	Remarks
TK-372G	K	X57-5880-11	X54-3250-10	450~470MHz	IF1 : 44.95MHz LOC : 50.4MHz
	K2	X57-5880-16		470~490MHz	
	K3	X57-5880-17		490~512MHz	
	K4	X57-5880-13		403~430MHz	

PERSONNEL SAFETY

The following precautions are recommended for personnel safety:

- DO NOT transmit until all RF connectors are verified secure and any open connectors are properly terminated.
- SHUT OFF and DO NOT operate this equipment near electrical blasting caps or in an explosive atmosphere.
- This equipment should be serviced by a qualified technician only.

SERVICE

This radio is designed for easy servicing. Refer to the schematic diagrams, printed circuit board views, and alignment procedures contained within.

SYSTEM SET-UP

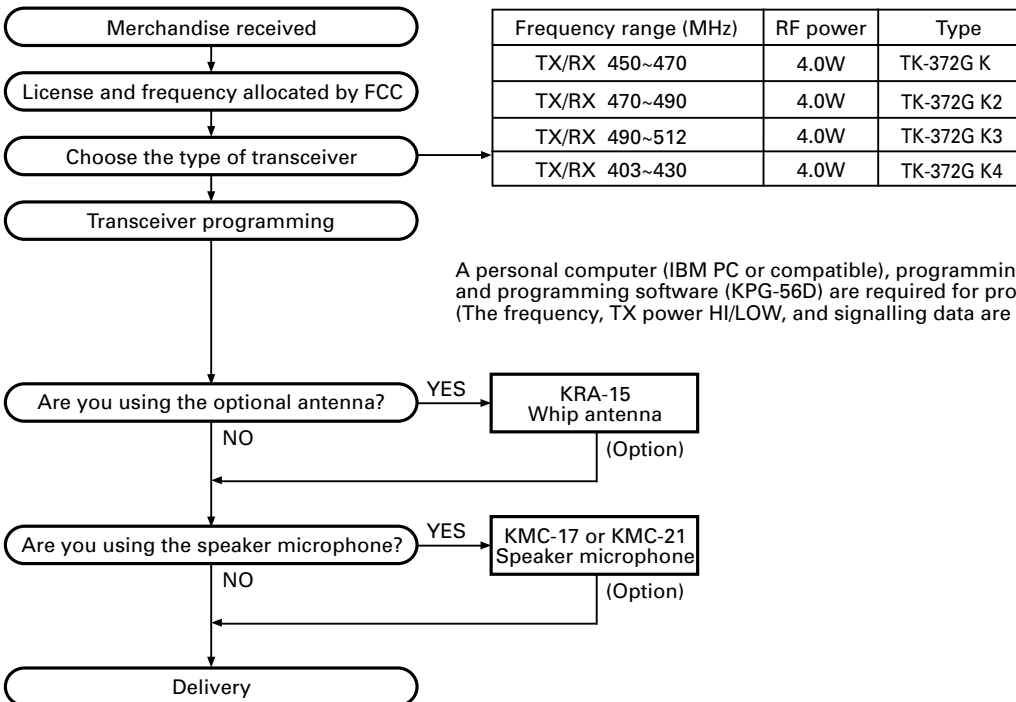

OPERATING FEATURES

1. Operation Features

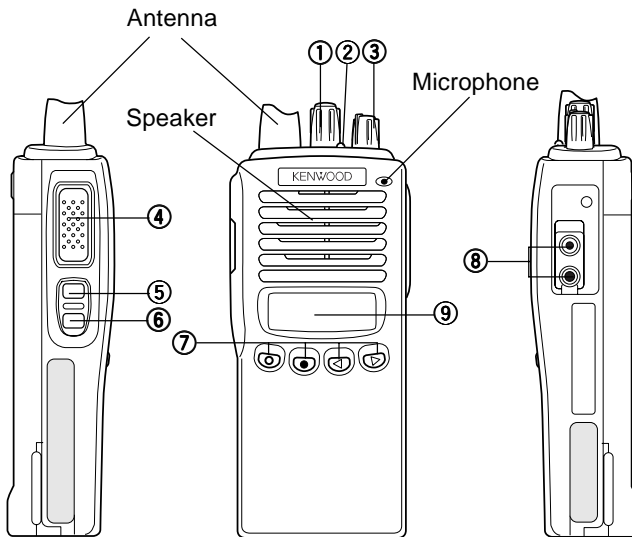

The transceiver is shown with the optional KNB-14 battery pack.

① Rotary encoder

Your dealer can program the encoder as either Group Up/Down (only when the trunking board is installed) or Channel Up/Down (default setting). Rotate to select a group or channel. Also rotate to adjust the squelch in Squelch Adjustment mode.

② LED indicator

Lights red while transmitting. Lights green while receiving. Flashes orange while receiving a Code Squelch or Selective Call code, or a 2-Tone or DTMF signal that matches the one set up in your transceiver. Flashes red when the battery power is low while transmitting.

③ Power switch/ Volume control

Turn clockwise to switch ON the transceiver. Rotate to adjust the volume. To switch OFF the transceiver, turn counterclockwise fully.

④ PTT (Push-to-Talk) switch

Press this switch, then speak into the microphone to call a station.

⑤ Side 1 key

This is a PF (Programmable Function) key. Press it to activate its auxiliary function.

⑥ Side 2 key

This is a PF (Programmable Function) key. Press it to activate its auxiliary function.

⑦ O, ●, ◀, ▶ keys

These are PF (Programmable Function) keys. Press each key to activate its auxiliary function.

⑧ SP/MIC jacks

Connect an optional speaker/ microphone here.

⑨ Display

Note: The PF keys are programmed with default functions:

- **Side 1 key:** Lamp
- **Side 2 key:** Monitor A
- **O key:** Scan
- **● key:** Scan Del/Add
- **◀ key:** Talk Around
- **▶ key:** RF Power Lo

Programmable Auxiliary Functions

Side 1, Side 2, O, ●, ◀, and ▶ can be programmed with the auxiliary functions listed below.

- Channel Down
- Channel Up
- Display Character
- Group Down ²
- Group Up ²
- Home Channel
- Key Lock
- Lamp
- Monitor A (Monitor Unmute–Momentary)
- Monitor B (Monitor Unmute–Toggle)
- Monitor C (Carrier Squelch–Momentary)
- Monitor D (Carrier Squelch–Toggle)
- None
- Operator Sel Tone ¹
- Redial
- RF Power Lo
- Scan
- Scan Del/Add
- Talk-Around
- 2-Tone Encode
- Trunking Group Code Select ²

¹ Available for K market models only.

² Available only when using Trunking function.

2. Programmable keys

The functions the FPU programs to the function keys are described in the following sections.

1) Channel up/down

When the key is pressed each time, the channel number to be selected is incremented/decremented and repeats if held for one second or longer.

2) Display character

This key switches the LCD display between the group/channel number and group/channel name.

3) Group up/down

When the key is pressed each time, the group number to be selected is incremented/decremented and repeats if held for one second or longer.

OPERATING FEATURES

4) Home Channel

Press this key once, the channel switches to the pre-programmed home channel.

5) Key lock

When the KEY LOCK switch is held down for one second or more, keys other than [PTT], [Side1], [Side2], [VOL], [POWER], and KEY LOCK are locked. When 12/16 KEY LOCK is set with the FPU, the DTMF key is locked and when front-panel KEY LOCK is set, the DTMF key and the [PF] key are locked.

6) Lamp

This key illuminates the LCD and keys on the front panel. When the key is pressed, the LED lamp goes on. When it is released, the lamp goes off after about five seconds. If any key is pressed while the LED lamp is on, the lamp is kept on for five seconds.

7) Monitor

Used to release signalling or squelch when operating in conventional mode. It is also used to reset option signalling.

8) Operator Selectable Tone

This key switches the pre-set decode QT/DQT and encode QT/DQT to OST (Operator Selectable Tone) tone pair. Press this key, the transceiver enters OST mode. In this mode, the display shows "OFF" and the operator can select one of the OST tone pair using the tuning control. The display shows "TONE **" and tone pair No. ** is selected. Press OST key again, the transceiver exits from OST mode, and returns to the group/channel mode. 16 tones pair for OST can be programmed by KPG-56D. OST is useful to access the repeater with same radio frequency and different tone (QT/DQT).

9) 2-Tone Encode Select

- ① Press the key programmed as 2-tone Encode Select.
 - A pre-programmed 2-tone code name appears on the display.
- ② Press the key programmed as Rotary encoder to select you desired 2-tone code name.
- ③ Press PTT switch and 2-Tone Encode Select key to transmit and release them to receive.

10) RF power low

Used to temporarily switch transmission output to low power. Turning the function on enables:
Hi→Low, Low→Low
Key states are backed up, except in the PC mode when they are reset.

11) Scan

Pressing this key starts scanning. Pressing this key again stops scanning.

12) Scan Del/Add

This key switches the currently displayed channel between "Delete" and "Add".

The "Add" channel is contained in the scan sequence, the "Delete" channel is not contained. In the scan mode, this key switches the channel between delete or add, temporarily.

13) Talk Around

Press this key, the transceiver uses the receive frequency and tone for transmission. The operator can call the other party directly (without repeater). Press this key again, the talk around function goes off.

14) None

An error operation beep sounds, and no action will occur. Use this function when the transceiver is required to be operated more simply.

3. Display

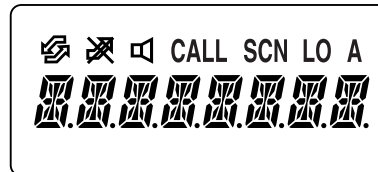

Icon	Description
	Appears while using Smar Trunk.
	Appears when the selected channel is busy.
	Appears when QT, DQT, DTMF, or 2-Tone decoding is deactivated (by pressing the Monitor key).
CALL	Appears when you receive a Code Squelch, Selective Call, 2-Tone, or DTMF Signalling call. Also appears when you transmit using Code Squelch or Selective Call.
SCN	Appears while scanning.
LO	Appears when using low power on the selected channel.
A	Appears when the selected channel is included in the scanning sequence.
	Displays the selected channel, the squelch level, DTMF digits (when entering digits, confirming digits, or making a call), and messages received via Selective Call.

4. Scan Operating

1) Scan types

• Single Group Scan

You can scan all valid (ADD) channels in the displayed group that can be selected with the group selector.

OPERATING FEATURES

- **Multiple Group Scan**

You can scan all valid (ADD) channels in all valid (ADD) groups.

2) Scan Start Condition

One or more non-priority channels must be added to all channels that can be scanned. The transceiver must be in normal receive mode (PTT off).

When you activate the key programmed to the scan function, scan starts. The scan icon ("SCN") lights and "SCAN" is indicated on display.

3) Scan Stop Condition

The scan stops temporarily if the following conditions are satisfied.

- ① The receiving signal matches the signalling code in your radio that is set by the programming software (KPG-56D).
- ② When the monitor key is depressed.

4) Scan Channel Types

- ① Priority channel is the most important channel for scan, and always detects a signal during scan and when the scan stops temporarily.
- ② Non-priority channels detect a signal during scan. For the channels that can be selected with the group or channel selector when the scan does not occur, the "A" icon lights.

5) Priority Channel Setting

A priority channel can be set as follows with the programming software (KPG-56D).

- ① Specify a priority channel as a fixed priority channel.
- ② Make a selected channel a priority channel.
Specify the initial channel before the operator changes it.

6) Scan Type According to the Priority Channel

- ① When no priority channel is set : Only the non-priority channels are scanned.
If a non-priority channel stops temporarily, it stops until there is no signal on the channel.
- ② When priority channel is set : Either priority channel is scanned.
If a non-priority channel stops temporarily, a priority channel signal is detected at certain intervals.
If a priority channel stops temporarily, it stops until there is no signal on the priority channel.

7) Revert Channel

The revert channel is used to transmit during scanning and set by the programming software (KPG-56D).

- ① Priority
The transceiver reverts to the priority channel.
- ② Priority with talkback
The transceiver reverts to the priority channel.
If you press PTT during a resume timer (dropout delay time, TX dwell time) or calling, you can transmit on the current

channel to answer to the call however revert channel is set to priority channel.

After resume time, scan re-starts and the transmission channel returns to the priority channel.

- ③ Selected channel
The transceiver reverts to the channel before scanning or the channel that you changed during scan.
- ④ Last called channel
The transceiver reverts to the last called channel during scan.
- ⑤ Last used channel
The transceiver reverts to the last used (transmitted) channel during scan. "Last used" revert channel includes talkback function.
- ⑥ Selected with talkback
The transceiver reverts to the channel before scanning or the channel that you changed during scan.

8) Scan End

When you reactivate the key programmed to the scan function during scan mode, scan ends.

The scan icon ("SCN") and "SCAN" or revert channel (programmable) display goes off.

9) Temporarily Delete/Add

It is possible to delete or add a channel temporarily during scan. When scan stops on an unnecessary channel, for example by interference of the other party, press the delete/add key, then that channel is deleted temporarily and scan will re-start immediately.

When you would like to add a deleted channel temporarily to the scan sequence, select the desired (deleted) channel during scan, and press the delete/add key before scan re-starts.

That channel is added temporarily to the scan sequence.

The temporarily deleted or added channels are returned to their pre-set delete/add conditions when the transceiver exits from scan mode.

5. Details of Features

1) Time-out timer

The time-out timer can be programmed in 15 seconds increments from 15 seconds to 300. If the transmitter is keyed continuously for longer than the programmed time, the transmitter is disabled and a warning tone sounds while the PTT button is held down. The alert tone stops when the PTT button is released.

2) PTT ID

PTT ID provides a DTMF ANI to be sent with the PTT button every time it is used (Begin of TX ID at beginning of transmission, End of TX ID at end of transmission, or both).

You can program the PTT ID as one of the followings.

Off, BOT (Begin of TX ID), EOT (End of PTT ID), BOTH.

The contents of ID are programmed for each channel.

OPERATING FEATURES

The transceiver is capable of having ID. The format is DTMF. The timing that the transceiver sends the ID is programmable.

Begin of TX ID (BOT) : Begin of TX ID is sent at the beginning of transmission.

End of TX ID (EOT) : End of TX ID is sent at the end of transmission.

Both : Begin of TX ID is sent at the beginning of transmission and End of TX ID is sent at the end of transmission.

There is also a "PTT ID" setting for each channel.

3) Battery Warning

This transceiver has a battery warning feature. If low voltage is detected during transmission, the transceiver warns you by a flashing red "LED".

When the voltage is detected to be even lower during transmission, the transceiver stops transmission and warns you by a flashing red "LED" and a beep.

Please notice "indication" for the battery exchange, charging time by flashing red LED and beep.

4) "TOT" Pre-Alert

The transceiver has a "TOT" pre-alert timer. This parameter selects the time at which the transceiver generates a "TOT" pre-alert tone before the "TOT" is expired.

"TOT" will expire when the selected time passes from the TOT pre-alert tone.

5) "TOT" Re-Key Time

The transceiver has a "TOT" re-key timer. This timer is the time you cannot transmit after the "TOT" is exceeded. After the "TOT" re-key time expires you can transmit again.

6) "TOT" Reset Time

The transceiver has a "TOT" reset timer. This timer is the minimum wait time allowed during a transmission that will reset the "TOT" count.

"TOT" reset time causes the "TOT" to continue even after the PTT is released, unless the "TOT" reset timer has expired.

7) OST (Operator Selectable Tone)

The transceiver is capable of having the "OST" function and 16 tone pairs (QT/DQT) with a max 10-digit name for each tone pair.

8) Clear to Transpond

The transceiver waits for an acknowledgment signal until the channel become free.

This feature ensures the acknowledgment signal is receive by another party.

9) Battery Save

This is the automatic battery saver during standby mode operation. The receiver circuit is turned on and off to conserve the battery life.

6. Option Signalling (DTMF/2 tone)

Built-in DTMF decoder is available for option signalling.

Built-in 2-Tone decoder is available for option signalling.

It is possible to use individual call, group call, DBD (Dead Beat Disable). **Note** : DBD is only DTMF

Preset operation is triggered when there is match with Option Signaling.

When Option Signaling matches on a Group Channel where it is set to Yes, the Option Signaling display flashes and Option Signaling is canceled. Settings after this will cause "Transpond" or "Alert" to sound.

Setting the Selective Call Alert LED will cause the LED to start flashing orange.

Mute or Unmute is triggered by the ID/QT/DQT/Carrier when option signaling matches (when Option Signal is deactivated by a transmission).

AND/OR

Option Signaling match conditions can be selected with AND/OR logic.

	Alert/Transpond	AF Mute Open
AND	Triggers at match with QT/DQT/ID+DTMF(2tone);Opt	Triggers at match with QT/DQT/ID+DTMF(2tone);Opt
OR	Triggers at match with DTMF(2tone) ; Opt	Triggers only for match with QT/DQT/ID;Signaling

Even if set as OR, there is no Alert/Transpond just with DTMF.

Even if set as OR, AF mute cannot be canceled just by a match with DTMF.

In conventional channels not set with QT/DQT, signaling is a match just by receiving the carrier.

Auto Reset

When Option Signaling matches on a Group channel where it is set to Yes, Option Signaling is canceled when it matches a group channel set to Yes.

After Option Signaling matches, Option Signaling can automatically Reset after a specified time.

Dead Beat Disable

When the D.B.D (Dead Beat Disable) code matches, a preset operation is performed.

When D.B.D matches on all group channels regardless of whether Option Signaling = Yes/No, then TX Inhibit or TX RX Inhibit is activated by the settings performed afterwards. D.B.D is canceled when the D.B.D. code + "#" is received.

Transpond is always activated when the D.B.D code is a matches. Alert is not output. An Option Signaling match is not displayed.

OPERATING FEATURES/ REALIGNMENT

7. Audible user feedback tones

The transceiver outputs various combinations of tones to notify the user of the transceiver operating state. The main tones are listed below

The high tone is 1477Hz, the mid tone is 941Hz, and the low tone is 770Hz.

- **Power on tone**

This tone is output when the transceiver is turned on. (The high tone is output for 500ms.)

- **Alert tone**

This tone is output when the transceiver is in TX inhibition for TOT, battery warning and PLL unlocked. It is output until the PTT button is released. (The 697Hz tone is output.)

- **Busy Tone**

This informs the user of a busy channel lock out

- **Group Call Tone**

The group call tone informs the user of a group call in DTMF/ 2 Tone Option Signaling. This tone repeats 7 times.

770Hz		770Hz
30ms	30ms	30ms

- **Individual Tone**

Individual tone is issued on receiving selective call by DTMF/ 2 Tone Option Signaling.

2000Hz		2000Hz		2000Hz
100ms	100ms	100ms	100ms	100ms

- **Pre Alert tone**

Informs the user when nearing transmit inhibit (transmit cutoff) time due to TOT.

The Pre Alert Tone is issued from the time set for TOT Pre Alert until the TOT triggers.

1633Hz		1633Hz		1633Hz
50ms	50ms	50ms	50ms	50ms

REALIGNMENT

1. Modes

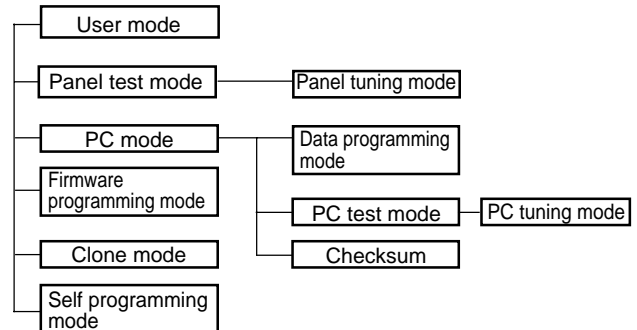

Mode	Function
User mode	For normal use.
Panel test mode	Used by the dealer to check the fundamental characteristics.
Panel tuning mode	Used by the dealer to tune the radio.
PC mode	Used for communication between the radio and PC (IBM compatible).
Data programming mode	Used to read and write frequency data and other features to and from the radio.
PC test mode	Used to check the radio using the PC. This feature is included in the FPU. See panel tuning.
Firmware programming mode	Used when changing the main program of the flash memory.
Clone mode	Used to transfer programming data from one radio to another.
Self programming mode	Frequency, signalling and features.

2. How to Enter Each Mode

Mode	Operation
User mode	Power ON
Panel test mode	[◀]+Power ON (Two seconds)
PC mode	Received commands from PC
Panel tuning mode	[Panel test mode]+[O]
Firmware programming mode	[Side1]+[Side2]+Power ON (Two seconds)
Clone mode	[Side1]+[▶]+Power ON (Two seconds)
Self programming mode	[Side1]+[●]+Power ON (Two seconds)

3. For the panel Test Mode

For the setting method, refer to ADJUSTMENT.

3-1. For the panel Tuning Mode

For the setting method, refer to ADJUSTMENT.

REALIGNMENT

4. Checksum

Executing this function, "TUNING" appears on the display of TK-372G while calculating the checksum .

When the calculation is completed, the display returns to normal and PC displays the checksum of the radio.

5. PC Mode

5-1. Preface

The TK-372G transceiver is programmed using a personal computer, a programming interface (KPG-22) and programming software (KPG-56D).

The programming software can be used with an IBM PC or compatible. Figure 1 shows the setup of an IBM PC for programming.

5-2. Connection procedure

1. Connect the TK-372G to the personal computer with the interface cable.
2. When the POWER is switched on, user mode can be entered immediately. When the PC sends a command, the radio enters PC mode.
When data is transmitted from transceiver, the red LED blink.
When data is received by the transceiver, the green LED blinks.

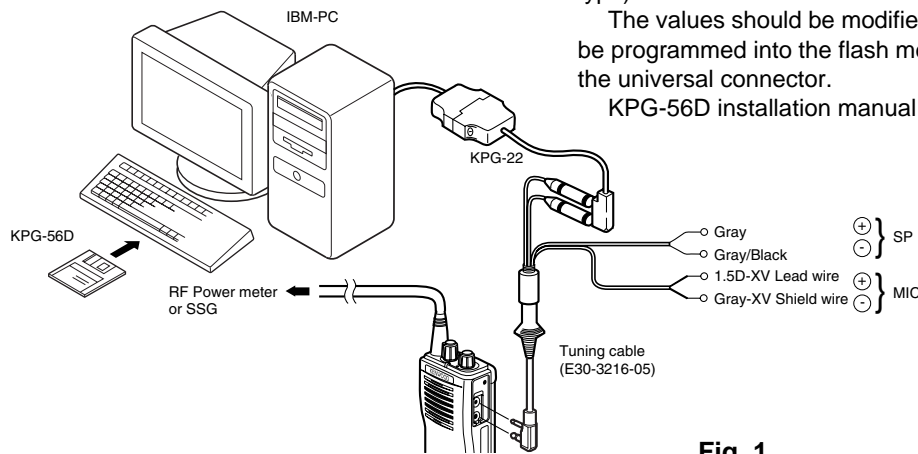

Fig. 1

6. Firmware Programming Mode

6-1. Preface

Flash memory is mounted on the TK-372G. This allows the TK-372G to be upgraded when new features are released in the future. (For details on how to obtain the firmware, contact Customer Service.)

6-2. Connection procedure

Connect the TK-372G to the personal computer (IBM PC or compatible) with the interface cable (KPG-22). (Connection is the same as in the PC Mode.)

6-3. Programming

1. Start up the programming software (KPG-56D), select "firmware program" in the "Program" item, and press the Return key on your personal computer. This starts up the firmware programmer.

Notes:

- The data stored in the personal computer must match model type when it is written into the flash memory.
- Change the TK-372G to PC mode, then attach the interface cable.

5-3. KPG-22 description

(PC programming interface cable: Option)

The KPG-22 is required to interface the TK-372G to the computer. It has a circuit in its D-subconnector (25-pin) case that converts the RS-232C logic level to the TTL level.

The KPG-22 connects the SP/MIC connector of the TK-372G to the computers RS-232C serial port.

5-4. Programming software description

The KPG-56D programming disk is supplied in 3-1/2" disk format. The software on this disk allows a user to program the TK-372G radios via a programming interface cable (KPG-22).

5-5. Programming with IBM PC

If data is transferred to the transceiver from an IBM PC with the KPG-56D, the destination data (basic radio information) for each set can be modified. Normally, it is not necessary to modify the destination data because their values are determined automatically when the frequency range (frequency type) is set.

The values should be modified only if necessary. Data can be programmed into the flash memory in RS-232C format via the universal connector.

KPG-56D installation manual part No. : B62-1153-XX

2. The top screen is displayed. Press any key to advance to the next screen.
3. Set the communications speed (normally, 57600 bps) and communications port in the Setup item.
4. Set the firmware to be updated by File select (=F1).
5. Hold down the [Side1] and [Side2] switches on the TK-372G, and press the power switch.

When the [Side1] and [Side2] switches are held down for two seconds, "PROG 576" appears on the display and the LED lights orange. When "PROG 576" is displayed, release the switches.

6. Check the connection between the TK-372G and the personal computer, and make sure that the TK-372G is in Program mode.

REALIGNMENT

- Press F10 on the personal computer. A window opens on the display to indicate the writing progress. When the TK-372G begins to receive data, the LED lights green.
- When data is received successfully, a checksum appears on the display.
- If you want to continue programming other TK-372Gs, repeat steps 5 to 8.

Notes:

- To start the Firmware Programmer from KPG-56D, the Fpro path must be set up by the KPG-56D Setup.
- This mode cannot be entered if the Firmware Programming mode is set to Disable in the Programming software (KPG-56D).
- When programming the firmware, it is recommend to copy the data from the floppy disk to your hard disk before you update the radio firmware.
Directly copying from the floppy disk to the radio may not work because the access speed is too slow.

6-4. Function

- If you press the [Side2] switch while "PROG XXX" is displayed, the checksum is displayed. If you press the [Side2] switch again (while the checksum is displayed), "PROG XXX" is redisplayed.
- A transmission speed can be selected by pressing the [Side1] switch while "PROG XXX" is displayed.
 - 19200 bps: The LED flashes green and red alternately.
 - 38400 bps: The LED flashes orange.
 - 57600 bps: The LED lights orange.

Note:

Normally, write in the high-speed mode.

7. Clone Mode

Programming data can be transferred from one radio to another by connecting them via their SP/MIC connectors. The operation is as follows (the transmit radio is the master and the receive radio is the slave).

- Turn the master TK-372G power ON with the [Side1]+[▶] key held down. The TK-372G displays "▯▯CLONE▯".
- Power on the slave TK-372G.
- Connect the cloning cable to the SP/MIC connectors on the master and slave.
- Press the [○] key on the master while the master displays "▯▯CLONE▯". The data of the master is sent to the slave. While the slave is receiving the data, "-PC-" is displayed. When cloning of data is completed, the master displays "END", and the slave automatically operates in the User mode. The slave can then be operated by the same program as the master.
- The other slave can be continuously cloned. When the [○] key on the master is pressed while the master displays "END", the master displays "▯▯CLONE▯". Carry out the operation in steps 2 to 4.

Note: You can clone the programmed data between the transceiver frequency version must be same.
Use the new cloning cable for TK-372G.
You cannot use the old cloning cable for TK-360/370.

Cloning cable parts No.

E30-3410-05 (TK-372G → TK-372G)

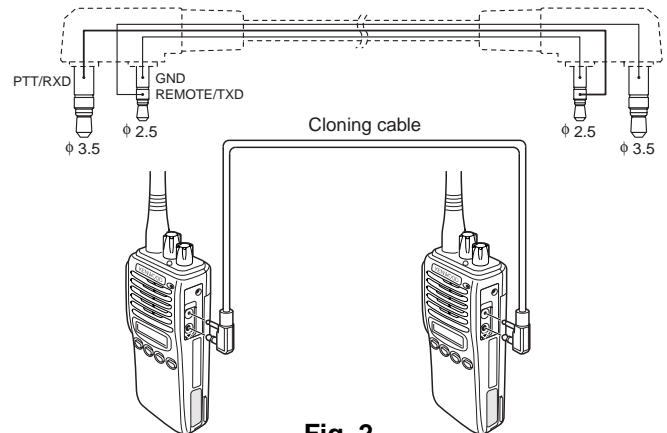

Fig. 2

8. Self Programming Mode

Write mode for frequency data and signalling etc. Mainly used by the person maintaining the user equipment.

8.1 Self programming mode setting

Remove D17 from the TX-RX unit (Figure 3) (K, K4 models only). Hold down the [Side1]+[●] switches and turn the power switch on.

When the self programming mode is entered, [SELF] appears on the display. The mode changes automatically to Model Select Mode and "PORTABLE" is displayed in about one second.

Note :

This mode (self programming mode) cannot be set when it has been disabled with the FPU.

Note :

Self Programming is disabled if "a Trunking Board is installed in this Radio" is selected in FPU.

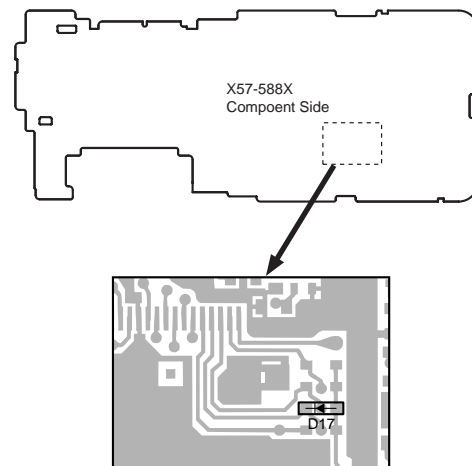
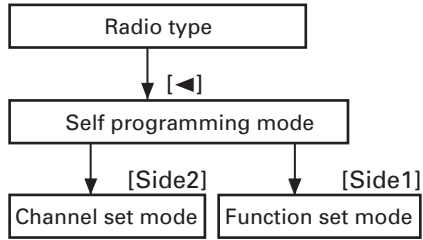

Fig. 3

REALIGNMENT

• Flow Chart



8-2. Channel Setting Mode

This is a mode for making channel settings with the panel keys without using the FPU.

Pressing [Side2] when "SELF" is displayed, sets Channel Setting Mode.

Select an item set using [▶] then change the selection with the encoder.

The data displayed using [◀] is stored in the memory and then proceeds to the next item. Pressing [▶] proceeds to the next item without storing it in the memory.

Press [Side2] to set the display to "SELF" and return to reset (default) status.

All channel data is cleared when pressing [◀] key with the blank RX frequency.

No.	Function	Choices	Display	Remarks
	Select Channel	1-128	_1-1_	We recomend up to 32 CH for TK-372G.
1	RX frequency	Step 2.5kHz-1MHz	STP_250 STP_1000	Display when an item is selected or when a step is changed (about 0.5 seconds) [●] Step change UHF : 5.0,6.25kHz,1MHz,Step
		Blank	R. _____	[Side1] : Freq On/Blank switching
		100.0000-550.0000MHz	R.100.0000	The rightmost dot indicates 50Hz digit (On=5; Off=0).
2	Rx Signaling	OFF	_____	[Side1] : Off/QT/DQT switching
		QT 67.0-250.3Hz (EIA Mode)	QT_67.0_	[●] : Mode switching
			QT_250.3_	[○] : Normal/Inverse switching
		QT 67.0-250.3Hz (0.1Hz Step Mode)	QT_67.0*	
			QT_250.3*	
		DQT 000-777 (Normal) (1 Step Mode)	DQT000N*	
			DQT777N*	
		DQT 023-754 (Normal) (Standard Table Mode)	DQT023N	
			DQT754N	
		DQT 000-777 (Inverse) (1 Step Mode)	DQT000I*	
	DQT777I*			
DQT 023-754 (Inverse) (Standard Table Mode)	DQT023I			
	DQT754I			
3	TX frequency	Step 2.5kHz-1MHz	STP_250 STP_1000	Same as RX frequency.
		Blank	T. _____	
		100.0000-550.0000MHz	T.100.0000	
4	TX Signaling			Same as RX signaling.

No.	Function	Choices	Display	Remarks
5	Option Signaling	OFF	NONE_	← Default
		DTMF	DTMF_	
		2-TONE	2TONE_	
6	ID	000-9999999999	___ID_	Display when an item is selected (about 0.5 seconds)
			12345678	Display of the current setting (If it is 8 or more digits, scroll it.)
			___987	Display when a code is input (Input it with DTMF key.) *1
		Blank	_____	[Side1] : Data clear
7	Busy Channel Lockout	NO	BCL_NO_	← Default
		YES	BCL_YES	BCL_YES for K, K4 type
8	Beat shift	No	SHFT_NO_	← Default
		Yes	SHFT_YES	
9	RF Power	High Power	PWR_H_	← Default
		Low Power	PWR_L_	
10	Wide/Narrow	Wide	WIDE_	K, K4, destination only
		Narrow	NARROW_	
11	Scan	DELETE	SCAN_DEL	← Default
		Delete/ADD	SCAN_ADD	
12	Priority Channel	No	P.CH_NO_	Not used when (Scan) Priority is not Fixed.
		Yes	P.CH_YES_	
13	Home Channel	No	H.CH_NO_	Not used when Home Channel is not set in Key Assignment.
		Yes	H.CH_YES_	
14	Compannder	No	COMP_NO_	
		Yes	COMP_YES	
15	PTT ID	OFF	P.ID_OFF	
		Begin of TX	P.ID_1	
		End of TX	P.ID_2	
		Both	P.ID_3	
16	Begin of TX ID	000-9999999999999999	___BOT_ID_	Not valid if Dial ID=Disable and PTT ID=OFF, or EOT is set. Display when an item is selected (about 0.5 seconds)
			12345678	Display of the current setting (If it is 8 or more digits, scroll it.)
			___987	Display when a code is input (Input it with DTMF key.) *1
		Blank	_____	[Side1] : Data clear
17	END of TX ID	000-9999999999999999	___EOT_ID_	Not valid if Dial ID=Disble and PTT ID=OFF, or BOT is set. Display when an item is selected (about 0.5 seconds)
			12345678	Display of the current setting (If it is 8 or more digits, scroll it.)
			___987	Display when a code is input (Input it with DTMF key.) *1
		Blank	_____	[Side1] : Data clear

*1. There is no keys, so it can't be changed.

REALIGNMENT

Flow Chart

Channel Setting Mode

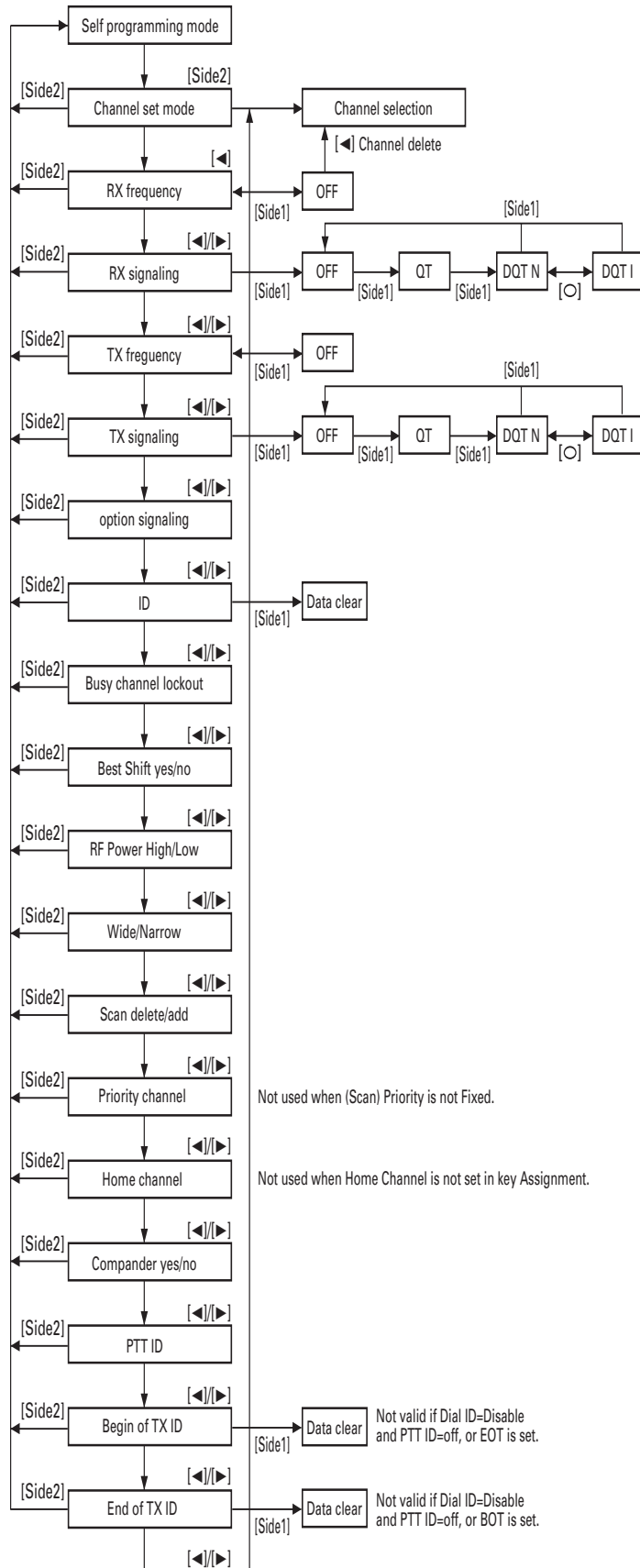

8-3. Function Setting Mode

This is a mode for using the panel keys to make function settings without using the FPU, that operate on all channels.

Pressing the [Side1] when "SELF" is displayed, sets the Function Setting Mode.

Select an item set using [▶] then change the selection with the encoder.

The data displayed using [◀] is stored in the memory and then proceeds to the next item. Pressing [▶] proceeds to the next item without storing it in memory.

Press [Side1] to display "SELF" and return to reset (default) status.

Function Setting Mode

No.	Function	Choices	Display	Remarks
Function Key				
1	[Side1]	No Function	LAMP_OFF	← Default
		Talk Around	LAMP_3	
		Display Character	LAMP_5	
		Home Channel	LAMP_7	
		Channel Down	LAMP_8	
		Channel Up	LAMP_9	
		Keylock	LAMP_10	
		Lamp	LAMP_11	← Default
		2-Tone Encode Select	LAMP_16	
		Monitor A	LAMP_17	
		Monitor B	LAMP_18	
		Monitor C	LAMP_19	
		Monitor D	LAMP_20	
		RF Power Low	LAMP_21	
Scan	LAMP_22			
Scan DEL/ADD	LAMP_23			
Operator Selectable Tone	LAMP_27			
2	[Side2]	No Function	MON_OFF	
		Talk Around	MON_3	
		Display Character	MON_5	
		Home Channel	MON_7	
		Channel Down	MON_8	
		Channel Up	MON_9	
		Keylock	MON_10	
		Lamp	MON_11	
		2-Tone Encode Select	MON_16	
		MONitor A	MON_17	← Default
		MONitor B	MON_18	
MONitor C	MON_19			
MONitor D	MON_20			

REALIGNMENT

No.	Function	Choices	Display	Remarks
2	[Side2]	RF Power Low	MON_21	
		Scan	MON_22	
		Scan DEL/ADD	MON_23	
		Operator Selectable Tone	MON_27	
3	[O]	No Function	KEY1_OFF	
		Talk Around	KEY1_3	
		Display Character	KEY1_5	
		Home Channel	KEY1_7	
		Channel Down	KEY1_8	
		Channel Up	KEY1_9	
		Keylock	KEY1_10	
		Lamp	KEY1_11	
		2-Tone Encode Select	KEY1_16	
		Monitor A	KEY1_17	
		Monitor B	KEY1_18	
		Monitor C	KEY1_19	
		Monitor D	KEY1_20	
		RF Power Low	KEY1_21	
		Scan	KEY1_22	
		Scan DEL/ADD	KEY1_23	← Default
Operator Selectable Tone	KEY1_27			
4	[●]	No Function	KEY2_OFF	
		Talk Around	KEY2_3	
		Display Character	KEY2_5	
		Home Channel	KEY2_7	
		Channel Down	KEY2_8	
		Channel Up	KEY2_9	
		Keylock	KEY2_10	
		Lamp	KEY2_11	
		2-Tone Encode Select	KEY2_16	
		Monitor A	KEY2_17	
		Monitor B	KEY2_18	
		Monitor C	KEY2_19	
		Monitor D	KEY2_20	
		RF Power Low	KEY2_21	
		Scan	KEY2_22	
		Scan DEL/ADD	KEY2_23	
Operator Selectable Tone	KEY2_27			
5	[◀]	No Function	KEY3_OFF	
		Talk Around	KEY3_3	← Default
		Display Character	KEY3_5	
		Home Channel	KEY3_7	
		Channel Down	KEY3_8	

No.	Function	Choices	Display	Remarks
5	[◀]	Channel Up	KEY3_9	
		Keylock	KEY3_10	
		Lamp	KEY3_11	
		2-Tone Encode Select	KEY3_16	
		Monitor A	KEY3_17	
		Monitor B	KEY3_18	
		Monitor C	KEY3_19	
		Monitor D	KEY3_20	
		RF Power Low	KEY3_21	← Default
		Scan	KEY3_22	
		Scan DEL/ADD	KEY3_23	
Operator Selectable Tone	KEY3_27			
6	[▶]	No Function	KEY4_OFF	
		Talk Around	KEY4_3	
		Display Character	KEY4_5	
		Home Channel	KEY4_7	
		Channel Down	KEY4_8	
		Channel Up	KEY4_9	
		Keylock	KEY4_10	
		Lamp	KEY4_11	
		2-Tone Encode Select	KEY4_16	
		Monitor A	KEY4_17	
		Monitor B	KEY4_18	
Monitor C	KEY4_19			
Monitor D	KEY4_20			
RF Power Low	KEY4_21	← Default		
Scan	KEY4_22			
Scan DEL/ADD	KEY4_23			
Operator Selectable Tone	KEY4_27			
7	[CH]	Channel Up/Down	CH_UP/DN	← Default
		No Function	KNOB_OFF	
Optional Feature				
8	Power On Tone	YES/NO	PONT_YES	Default: YES
9	Control Tone	YES/NO	CNTT_YES	Default: YES
10	Warning Tone	YES/NO	WART_YES	Default: YES
11	Time Out Timer	OFF, 15-300/15s Step	TOT_60	Default: 60s
12	TOT Pre-Alert Time	OFF, 1-10/1s Step	TOTP_PFF	Cannot be set when TOT is OFF. Default: OFF
13	TOT Rekey Time	OFF1-60/1s Step	TOTK_OFF	Cannot be set when TOT is OFF. Default: OFF
14	TOT Reset Time	OFF1-15/1s Step	TOTS_OFF	Cannot be set when TOT is OFF. Default: OFF
15	Clear to Transpond (BCL for Transpond)	YES	CTT_YES	
		NO	CTT_NO	← Default

REALIGNMENT

No.	Function	Choices	Display	Remarks
16	Battery Save	ON	BATT_ON	← Default
		OFF	BATT_OFF	
17	Signaling	OR	SIG_OR	← Default
		AND	SIG_AND	
18	Squelch Level	0-9/1 Step	SQL_5	Default;5
19	Priority	None	PRI_NONE	← Default
		Fixed	PRI_FIX_	
		Selected	PRI_SEL_	
20	Lock Back Time A	0.5-5.0/0.05	LBA_500	Default:500ms Cannot be set when Priority = none.
21	Lock Back Time B	0.5-5.0/0.05	LBB_2000	Default:2000ms Cannot be set when Priority = none.
22	Revert Channel	Selected	REV_SEL	
		Last Called	REV_L/C_	← Default
		Last Used	REV_L/U_	
		Selected + Talk Back	REV_S/T_	
		Priority	REV_PRI_	
23	Dropout Delay Time	0-300/1s	DODT__3	Default;3s
24	Dwell Time	0-300/1s	DWL__3	Default;3s
DTMF				
25	Digit Time	50-200/10ms	DIGT__50	Default;50ms
26	Inter Digit Time	50-200/10ms	IDT__50	Default;50ms
27	First Digit Time	50-200/10ms	FDT__50	Default;50ms
28	First Digit Delay	100-1000/50ms	RIST_100	Default;100ms
29	Rise Time with QT	100-1000/50ms	RTWQ_100	Default;100ms
30	DIAL ID	Enable	DID_ENA	*1
		Disable	DID_DIS	← Default
31	No.of DTMF Key	12Key	NODK_12	← Default *1
		16Key	NODK_16	*1
32	DTMF Hold Time	ON	DHT_ON	← Default *1
		OFF	DHT_OFF	
33	Store and Send	Enable	SAS_ENA	*1
		Disable	SAS_DIS	← Default
34	D Key Assignment	D Code	DKA_D_CD	← Default
		1-16/1s	DKA_16__	
35	DTMF Signaling	Code SQ	DTMS_CSQ	← Default
		SEL CALL	DTMS_SEL	
36	Inter Mediate Code	0-9,A-D,*,#	IMC__#_	Default: # (Can be set only when DTMF signaling = SEL CALL.)
37	Group Code	A-D,*,#	GPCD_FF_	Default;OFF
38	Auto Rest Time	OFF	ART_OFF_	
		1-15/1s	ART__10	Default;10s
39	Call Alert/ Transpond	OFF	CA/T_OFF	← Default
		Call Alert	CA/T_C/A	
		Transpond (Call Alert)	CA/T_T/A	

No.	Function	Choices	Display	Remarks
		Transpond (ID Code)	CA/T_T/I	
		Transpond (Transpond Code)	CA/T_T/T	
Others				
40	Panel Test/panel Tuning MODE	Enable	PTM_ENA	← Default
		Disable	PTM_DIS	

*1. This function is not available on TK-372G.

8-4. Memory Reset Mode

This mode is used to clear data for functions that can be set in Self Programming Mode or to return to reset values (default).

Pressing [O] when "SELF" is shown, sets the display to "CANCEL".

Turning the encoder alternately switches the display between "CANCEL" ←→ "READY".

Pressing [O] when "READY" is shown, clears the data and sets the display to "CLEAR".

Pressing [O] again, returns the display to "SELF".

Pressing [O] when "CANCEL" is shown, returns the display to "SELF" without resetting the data.

When the memory is reset, mode data and model data are not reset.

REALIGNMENT

• Flow Chart

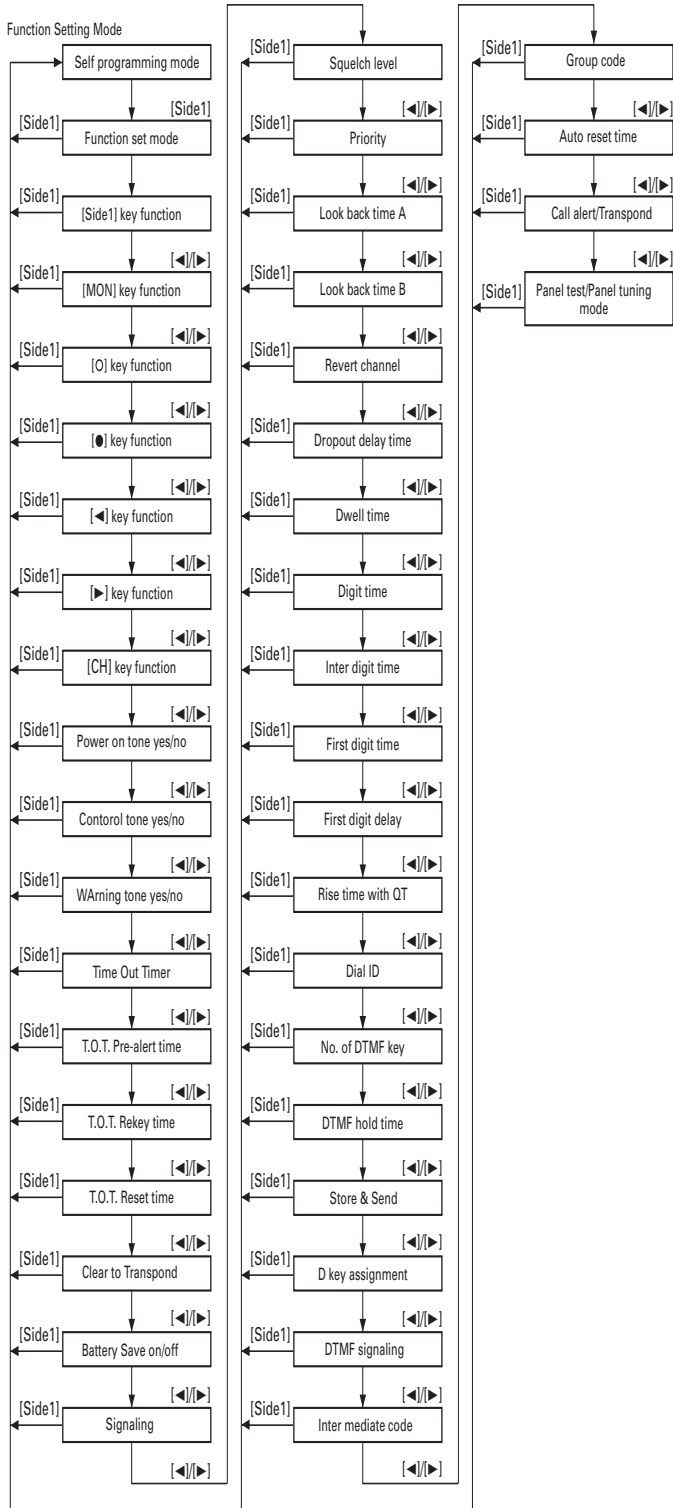

DISASSEMBLY FOR REPAIR

Separating the case assembly from the chassis.

1. Remove the two knobs ① and three round units ②.
2. Remove the two screws ③.
3. Expand the right and left sides of the bottom of the case assembly, lift the chassis, and remove it from the case assembly ④.

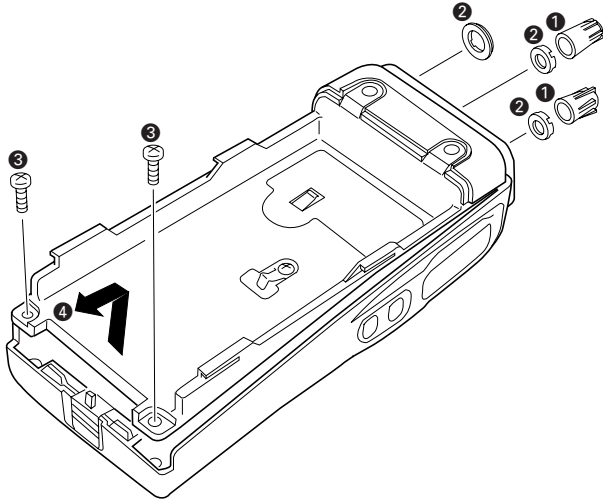

4. Taking care not to cut the speaker lead ⑤, open the chassis and case assembly, and pull the speaker lead with connector ⑥.

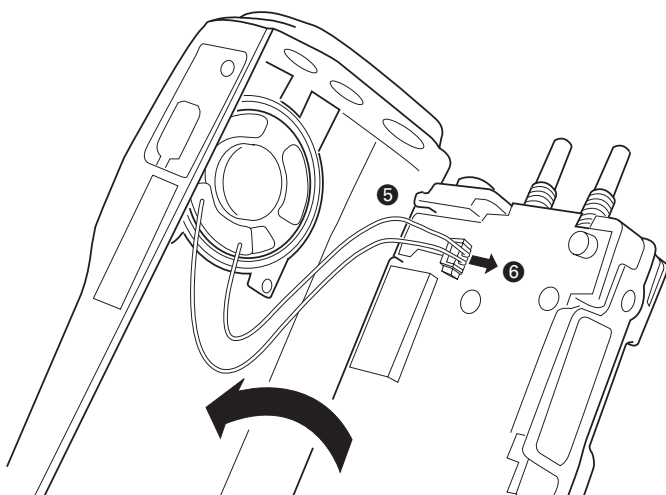

Separating the chassis from the unit.

1. Remove the three screws ⑨.
Lift the unit (X54), and rise up the connector lever in the arrow with your finger ⑩.
Remove the three hexagonal bosses ⑪, and remove the twelve screws ⑦.
2. Remove the solder from the antenna terminal using a soldering iron, then lift the unit off (X57).

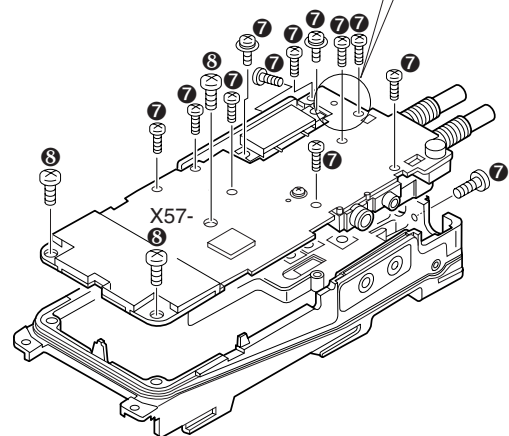
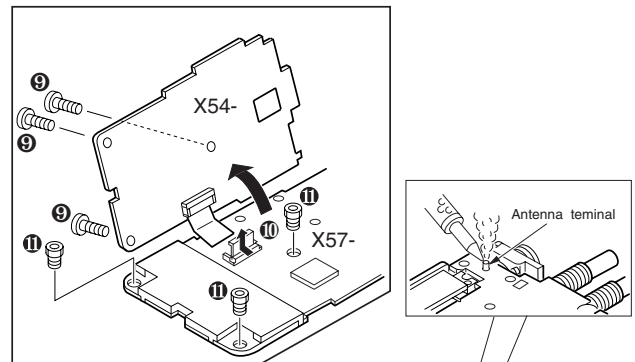

CIRCUIT DESCRIPTION

1. Frequency configuration

The receiver utilizes double conversion. The first IF is 49.95 MHz and the second IF is 450 kHz. The first local oscillator signal is supplied from the PLL circuit.

The PLL circuit in the transmitter generates the necessary frequencies. Fig. 1 shows the frequencies.

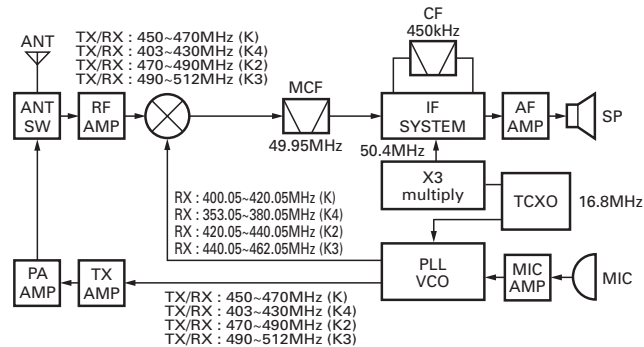

Fig. 1 Frequency configuration

2. Receiver

The frequency configuration of the receiver is shown in Fig. 2.

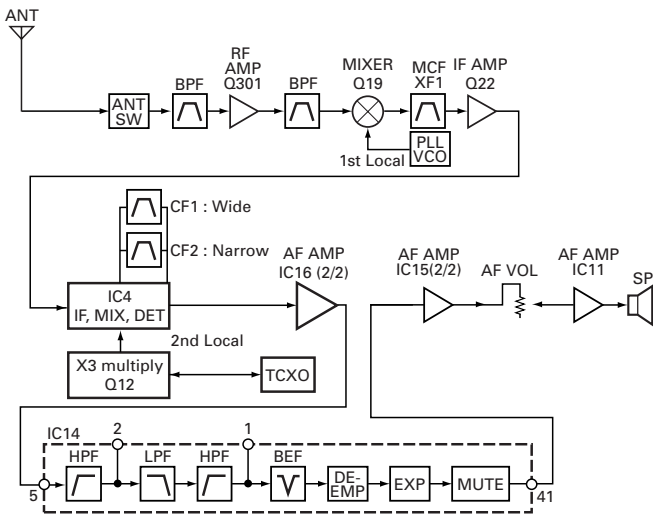

Fig. 2 Receiver section

1) Front end (RF AMP)

The signal coming from the antenna passes through the transmit/receive switching diode circuit, (D3,D7) passes through a BPF, and is amplified by the RF amplifier (Q301). The resulting signal passes through a BPF and goes to the mixer.

2) First mixer

The signal from the front end is mixed with the first local oscillator signal generated in the PLL circuit by Q19 to produce a first IF frequency of 49.95 MHz.

The resulting signal passes through the XF1 MCF to cut the adjacent spurious and provide the optimum characteristics, such as adjacent frequency selectivity.

3) IF Amplifier circuit

The first IF signal is passed through a four-pole monolithic crystal filter (XF1) to remove the adjacent channel signal. The filtered first IF signal is amplified by the first IF amplifier (Q22) and then applied to the IF system IC (IC4). The IF system IC provides a second mixer, second local oscillator, limiting amplifier, quadrature detector and RSSI (Received Signal Strength Indicator). The second mixer mixes the first IF signal with the 50.4MHz of the second local oscillator output (TCXO X3) and produces the second IF signal of 450kHz.

The second IF signal is passed through the ceramic filter (CF1; Wide, CF2 ; Narrow) to remove the adjacent channel signal. The filtered second IF signal is amplified by the limiting amplifier and demodulated by the quadrature detector with the ceramic discriminator (CD1). The demodulated signal is routed to the audio circuit.

4) Wide/Narrow changeover circuit

Narrow and Wide settings can be made for each channel by switching the ceramic filters CF1 (Wide) and CF2 (Narrow).

The WIDE (high level) and NARROW (low level) data is output from IC5 (OUTPUT EXPANDER), pin 4.

When a WIDE (high level) data is received, Q14 turn off and Q17 turn on. When a NARROW (low level) data is received, Q14 turn on and Q17 turn off. D14 and D13 are switched to ceramic filters when a high/low level data is received.

Q23 turns on/off with the Wide/Narrow data and the IC4 detector output level is changed to maintain a constant output level during wide or narrow signals.

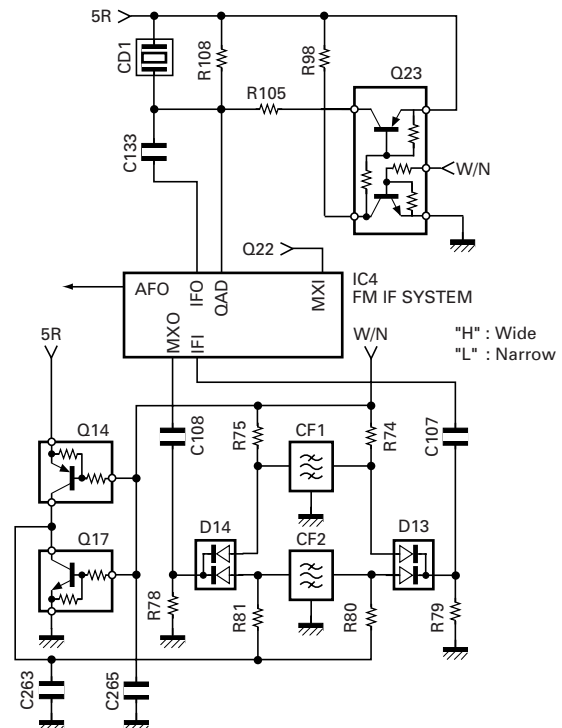

Fig. 3 Wide/Narrow changeover circuit

CIRCUIT DESCRIPTION

5) Audio amplifier circuit

The demodulated signal from IC4 is amplified by IC16 (2/2), high-pass filtered, low-pass filtered, high-pass filtered, band-eliminate filtered, and de-emphasized by IC14.

The signal then goes through an AF amplifier IC15 (2/2), an AF volume control (VR2), and is routed to an audio power amplifier (IC11) where it is amplified and output to the speaker.

6) Squelch

Part of the AF signal from the IC enters the FM IC (IC4) again, and the noise component is amplified and rectified by a filter and an amplifier to produce a DC voltage corresponding to the noise level.

The DC signal from the FM IC goes to the analog port of the microprocessor (IC13). IC13 determines whether to output sounds from the speaker by checking whether the input voltage is higher or lower than the preset value.

To output sounds from the speaker, IC6 sends a high signal to the SP MUTE line and turns IC11 on through Q32, Q33, Q34 and Q30. (See Fig. 4)

7) Receive signaling

(1) QT/DQT

300Hz and higher audio frequencies of the output signal from IF IC are cut by a low-pass filter (IC19). The resulting signal enters the microprocessor (IC13). IC13 determines whether the QT or DQT matches the preset value, and controls the SP MUTE and the speaker output sounds according to the squelch results.

(2) 2-TONE

Part of the received AF signal output from the AF amplifier IC16(2/2), and then pass through an audio processor (IC14), goes to the other AF amplifier IC15(1/2), is compared, and then goes to IC13. IC13 checks whether 2-TONE data is necessary. If it matches, IC13 carries out a specified operation, such as turning the speaker on. (See Fig. 4)

(3) DTMF

The DTMF input signal from the IF IC(IC4) is amplified by IC16(2/2) and goes to IC18, the DTMF decoder. The decoded information is then processed by the CPU. During transmission and standby, the DTMF IC is set to the power down mode when the PD terminal is High. When the line is busy, the PD terminal becomes Low, the power down mode is canceled and decoding is carried out.

3. PLL frequency synthesizer

The PLL circuit generates the first local oscillator signal for reception and the RF signal for transmission.

1) PLL

The frequency step of the PLL circuit is 5 or 6.25kHz.

A 16.8MHz reference oscillator signal is divided at IC2 by a fixed counter to produce oscillator (VCO) output signal which is buffer amplified by Q3 then divided in IC2 by a dual-module programmable counter. The divided signal is compared in phase with the 5 or 6.25kHz reference signal from the phase comparator in IC2. The output signal from the phase comparator is filtered through a low-pass filter and passed to the VCO to control the oscillator frequency. (See Fig. 5)

2) VCO

The operating frequency is generated by Q2 in transmit mode and Q10 in receive mode. The oscillator frequency is controlled by applying the VCO control voltage, obtained from the phase comparator, to the varactor diodes (D2 and D4 in transmit mode and D9 and D11 in receive mode). The T/R pin is set high in receive mode causing Q7 and Q8 to turn Q2 off and turn Q10 on.

The T/R pin is set low in transmit mode. The outputs from Q10 and Q2 are amplified by Q3 and sent to the buffer amplifiers.

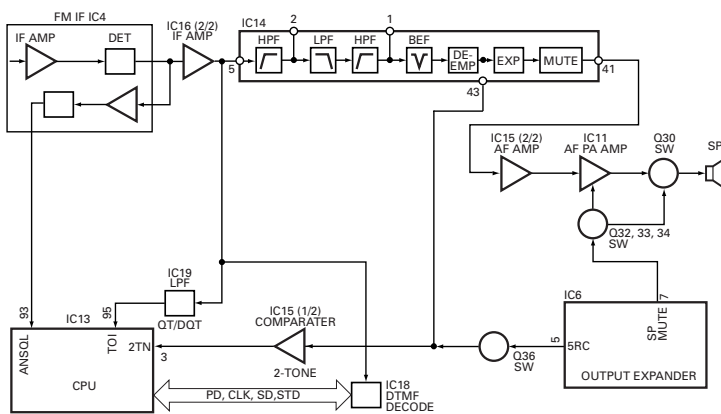

Fig. 4 AF Amplifier and Squelch

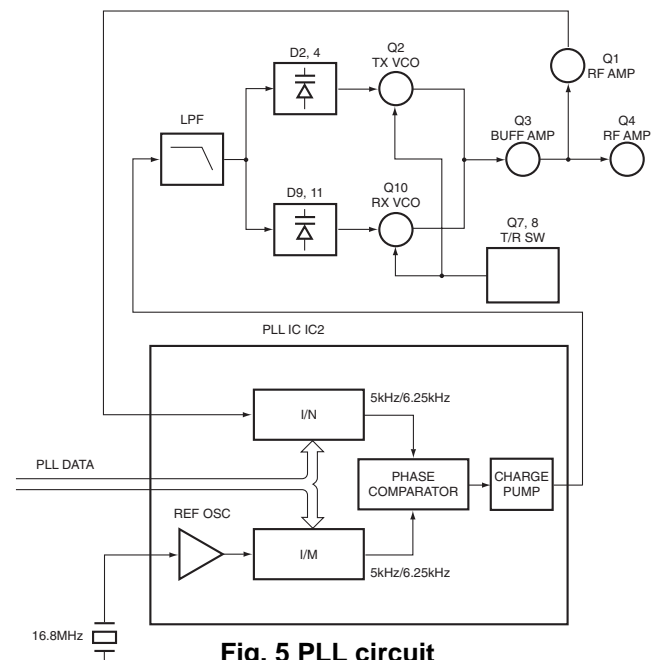

Fig. 5 PLL circuit

CIRCUIT DESCRIPTION

3) UNLOCK DETECTOR

If a pulse signal appears at the LD pin of IC2, an unlock condition occurs, and the DC voltage obtained from D1, R1, and C6 causes the voltage applied to the microprocessor to go low. When the microprocessor detects this condition, the transmitter is disabled, ignoring the push-to-talk switch input signal. (See Fig. 6)

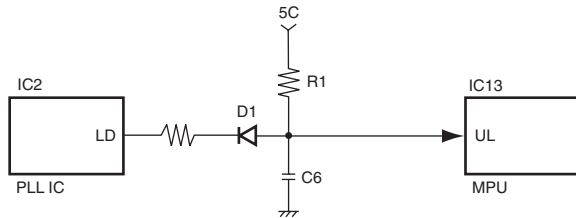

Fig. 6 Unlock detector circuit

4. Transmitter System

1) Microphone amplifier

The signal from the microphone passes through the limiter circuit in D23, and through the high-pass filter, the ALC circuit, the low-pass filter, the high-pass filter, and pre-emphasis/IDC circuit IC14. When encoding DTMF, the mute switch (Q35) is turned OFF for muting the microphone input signal.

The signal passes through the D/A converter (IC17) for the maximum deviation adjustment, and goes to the VCXO modulation input.

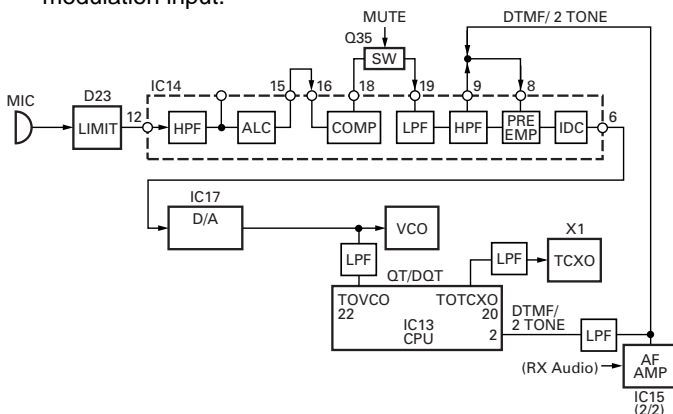

Fig. 7 Microphone amplifier

2) Drive and Final amplifier

The signal from the T/R switch (D5 is on) is amplified by the pre-drive (Q5) and drive amplifier (Q6) to 50mW. The output of the drive amplifier is amplified by the RF power amplifier (IC1) to 4.0W (1W when the power is low). The RF power amplifier consists of two MOS FET stages. The output of the RF power amplifier is then passed through the harmonic filter (LPF) and antenna switch (D3 is on) and applied to the antenna terminal.

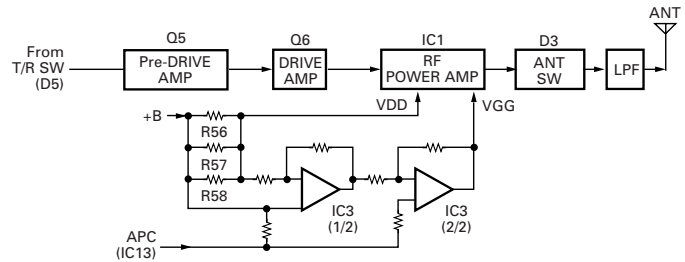

Fig. 8 Drive and final amplifier and APC circuit

3) APC circuit

The APC circuit always monitors the current flowing through the RF power amplifier (IC1) and keeps a constant current. The voltage drop at R56, R57 and R58 is caused by the current flowing through the RF power amplifier and this voltage is applied to the differential amplifier IC3(1/2).

IC3(2/2) compares the output voltage of IC3(1/2) with the reference voltage from IC13, and the output of IC3(2/2) controls the VGG of the RF power amplifier to make both voltages the same.

The change of power high/low is carried out by the change of the reference voltage.

4) Encode signaling

(1) QT/DQT

QT, DQT data of the TOTCXO Line is output from pin 20 of the CPU. The signal passes through a low-pass CR filter and goes to the TCXO (X1).

The QT, DQT data of the TOVCO Line is output from pin 22 of the CPU. The signal passes through a low pass CR filter, mixes with the audio signal, and goes to the VCO modulation input. TX deviation is adjusted by the CPU. (See fig.7)

(2) DTMF/2 TONE

High-speed data is output from pin 2 of the CPU. The signal passes through a low-pass CR filter, and provides a TX and SP out tone, and is then applied to the audio processor (IC14). The signal is mixed with the audio signal and goes to the VCO.

TX deviation is adjusted by the CPU. (See fig.7)

5. Power supply

There are five 5V power supplies for the microprocessor: 5V, 5M, 5C, 5R, and 5T. 5V for microprocessor is always output while the power is on. 5M is always output, but turns off when the power is turned off to prevent malfunction of the microprocessor.

5C is a common 5V and is output when SAVE is not set to OFF.

5R is 5V for reception and output during reception.

5T is 5V for transmission and output during transmission.

CIRCUIT DESCRIPTION

6. Control Circuit

The control circuit consists of a microprocessor (IC13) and its peripheral circuits. It controls the TX-RX unit and transfers data to and from the display unit. IC13 mainly performs the following:

- (1) Switching between transmission and reception by the PTT signal input.
- (2) Reading system, group, frequency, and program data from the memory circuit.
- (3) Sending frequency program data to the PLL.
- (4) Controlling squelch on/off by the DC voltage from the squelch circuit.
- (5) Controlling the audio mute circuit by the decode data input.
- (6) Transmitting tone and encode data.

1) Frequency shift circuit

The microprocessor (IC13) operates at a clock of 9.8304MHz. This oscillator has a circuit that shifts the frequency by BEAT SHIFT SW (Q31).

2) Memory circuit

Memory circuit consists of the CPU (IC13) and a flash memory (IC12). A flash memory has a capacity of 2M bits that contains the transceiver control program for the CPU and data such as transceiver channels and operating features.

This program can be easily written from an external device. Data, such as DTMF memories and the operating status, are programmed into the EEPROM (IC10).

• Flash Memory

Note : The flash memory holds data such as written with the FPU (KPG-56D) and firmware program (User mode, Test mode, Tuning mode, etc.). This data must be rewritten when replacing the flash memory.

• EEPROM

Note : The EEPROM stores tuning data (Deviation, Squelch, etc.).

Realign the transceiver after replacing the EEPROM.

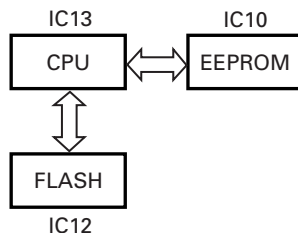

Fig. 9 Memory circuit

3) Low battery warning

The battery voltage is monitored by the microprocessor (IC13). When the battery voltage falls below the voltage set by the Low Battery Warning adjustment, the LED flashes red to notify the operator that it is time to replace the battery. If the battery voltage falls even more (approx. 5.8V), a beep sounds and transmission is stopped.

Low battery warning	Battery condition
The red LED flashes during transmission.	The battery voltage is low but the transceiver is still usable.
The red LED flashes and a continuous beep sounds while PTT is pressed.	The battery voltage is low and the transceiver is not able to make calls.

7. Optional Board Terminal

Terminals for mounting the option board are provided at the bottom edge of the TX-RX unit. The table below shows the correspondence between the board and terminals.

Optional Board Terminal Function (CN5)

Pin	Name	I/O	Function
1	GND	-	GND
2	SB	O	Power output after power switch
3	AUX3	I/O	Board control
4	TXAFI	I	Modulation output from board
5	AUX2	I/O	Board control
6	AUX6	O	Board control
7	AUX1	I	Board control
8	AUX5	O	Board control
9	AUX4	O	Board control
10	TXAFO	O	Modulation input to board
11	5C	O	5V
12	RXAFO	O	Received signal input to board
13	NC	-	NC
14	RXAFI	I	Received signal output from board
15	NC	-	NC
16	ALTTONE	I	ALART TONE output form board
17	NC	-	NC
18	NC	-	NC
19	NC	-	NC
20	GND	-	GND

CIRCUIT DESCRIPTION/SEMICONDUCTOR DATA

8. CONTROL SYSTEM

Keys and channel selector circuit.

The signal from keys and channel selector input to microprocessor directly as shown in fig. 10.

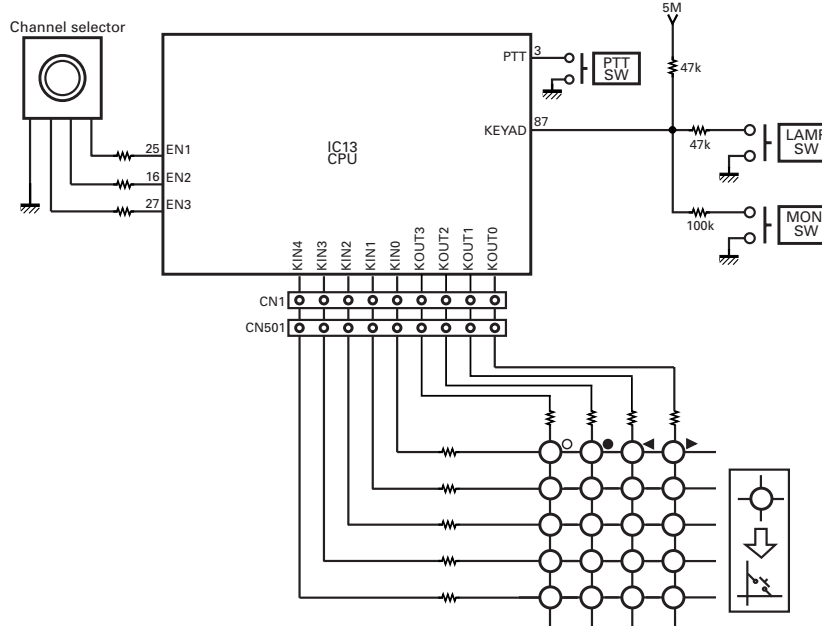
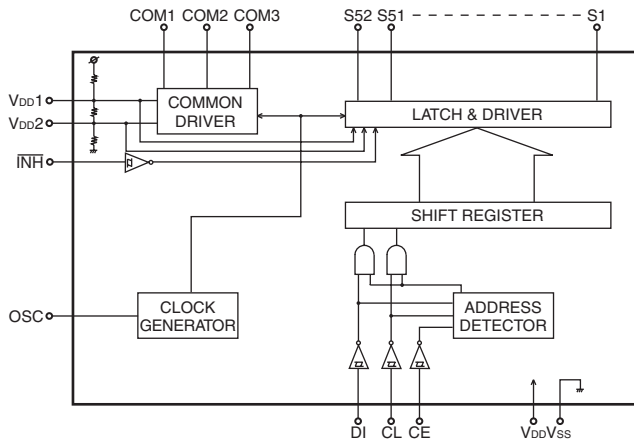

Fig. 10 Control system

SEMICONDUCTOR DATA

LCD Driver : LC75823W (Display UNIT IC501)
(TK-370G only)

■ Block diagram



■ Pin function

Pin No.	Name	I/O	Active	Function
1-52	S1-S52	O	-	Segment output for displaying data transferred from serial data.
53-55	COM1-COM4	O	-	Common drive output. Frame frequency $f_o = (f_{osc}/384)Hz$
56	VDD	-	-	
57	\overline{INH}	I	L	The display to turn off $\overline{INT=L}$: Turn off $\overline{INT=H}$: Turn on
58	VDD1	I	-	Apply 2/3 the LCD drive bias voltage from outside. If 1/2 the bias is applied, connect to VDD2.
59	VDD2	I	-	Apply 1/3 the LCD drive bias voltage from outside. If 1/2 the bias is applied, connect to VDD1.
60	VSS	-	-	
61	OSC	I/O	-	Oscillation terminal
62	CE	I	H	Chip enable. Serial data transfer terminal. Connected to the microprocessor.
63	CL	I		Synchronizing clock. Serial data transfer terminal. Connected to the microprocessor.
64	DI	I	-	Transfer data. Serial data transfer terminal. Connected to the microprocessor.

SEMICONDUCTOR DATA

Microprocessor : 30622M4102GP (TX-RX UNIT : IC13)

■ Pin function

Pin No.	Port Name	I/O	Function
1	APC	O	TX:Automatic Power Control data output
2	DTMF	O	DTMF/2TONE BEEP output
3	2TN	I	2TONE decode pulse input
4	DTMSTD	I	DTMF decode detect detect:H
5	SIM	I	Destination select
6	BYTE	I	+5V(5M)
7	CNVSS	I	GND
8	AFSTB	O	Base Band IC strobe/rest output
9	AFFCLK	O	Base Band IC frame rest/system reset output
10	RESET	I	Reset
11	XOUT	O	Clock output
12	VSS	-	GND
13	XIN	I	Clock input
14	VCC	-	+5V
15	NC	I	NC
16	EN2	I	Encoder pulse input 2
17	AUX3	I/O	Option board port 3 *Smar Trunk: Clock output *E Trunk: Step pulse input
18	INT	I	Battery voltage monitor input Low battery:L
19	OE	I	Not used
20	TOTCXO	I	QT/DQT modulation output(TCXO)
21	EEPDAT	I/O	EEPROM data input/output
22	TOVCO	O	QT/DQT modulation output(VCO)
23	AUX1	I	Option board port 1 *Smar Trunk: Req/Ack input *E Trunk: TX Request input
24	SFTSTB	O	Shift register strobe output
25	EN1	O	Encoder pulse input 1
26	DACS	I	Chip select output(Max dev) Select:L
27	EN3	I	CH selector input (TK-360G)
28	NC	O	NC
29	AUX4	O	Option board port 4 *Smar Trunk: Data output
30	AUX2	I/O	Option board port 2 *Smar Trunk: Data input *E Trunk: Synchronizing input
31	KOUT3	O	Key scan output 3
32	KOUT2	O	Key scan output 2
33	TXD	O	Serial data
34	PTT/RXD	I	PTT on: L/Serial data
35	KOUT1	O	Key scan output 1
36	KOUT0	O	Key scan output 0
37	RDY	-	Not used
38	ALE	O	Not used
39	HOLD	I	Not used
40	HLDA	O	Not used
41	BLCK	O	Not used
42	RDY	O	READ signal
43	BHE	O	Not used
44	WR	O	WRITE signal
45	LCDCS	O	LCD chip enable output
46	CNTDAT	O	Common data output (EEPROM,LCD,SHIFT REG,1bit D/A MODEM)
47	CNTCLK	O	Common clock output (EEPROM,LCD,SHIFT REG,1bit D/A MODEM)

Pin No.	Port Name	I/O	Function
48	CSO	-	Chip select signal
49	A19	-	Not used
50-59	A18-A9	-	Flash memory address bus
60	ACC	-	+5V
61	A8	-	Flash memory address bus
62	VSS	-	GND
63-70	A7-A0	-	Flash memory address bus
71-75	KIN0-KIN4	I	Key scan input
76	PLLUL	O	PLL unlock detect input unlock: L
77	PLLSTB	O	PLL strobe output Latch: L
78	SAVE	I	Battery save output
79-86	D7-D0	-	Flash memory data bus
87	KEYAD	I	MONI LAMP key input
88	BATT	I	Battery voltage input
89	RFDAT	O	PLL data output
90	RFCLK	O	PLL clock output
91	NC	-	NC
92	RSSQL	I	Receive signal strength indicator input
93	ANLSQL	I	Analog squelch level input
94	AVSS	-	GND
95	TOI	I	QT/DQT signal input
96	VREF	-	Reference voltage input
97	AVCC	-	GND
98	DTMPD	O	DTME IC power control Power down: H
99	DTMCLK	O	DTME IC decode clock output
100	DTMDAT	I	DTME IC decode data input

Shift register 1:BU4094BCFV(IC5)

■ Pin function

Pin No.	Port	I/O	Function
4	W/N	O	Wide/Narrow SW Narrow: L
5	MUTE	O	RX audio/MIC mute Mute: L
6	NC	O	NC
7	LED0	O	RED LED LED lights: H
11	BSHIFT	O	Beat Shift Shift on: H
12	REG2	O	Base Band IC inter register select 2
13	REG1	O	Base Band IC inter register select 1
14	LED1	O	GREEN LED LED lights: H

Shift register 2:BU4094BCFV(IC6)

■ Pin function

Pin No.	Port	I/O	Function
4	5MC	O	5MC control Power on: L
5	5RC	O	5R control Power on: L
6	5TC	O	5T control Power on: H
7	SPMUTE	O	AF amp power supply control Power on: H
11	AUX6	O	Option board port 6
12	AUX5	O	Option board port 5
13	LCDBLK	O	LCD back light Back light on: L
14	RX	O	RX/TX VCO SW RX: L

DESCRIPTION OF COMPONENTS

DISPLAY UNIT (X54-3250-10)

Ref. No.	Use/Function	Operation/Condition
IC501	IC	LCD driver
Q501	Transistor	Current driver / LCD back light LED AVR
Q502	Transistor	DC switch
D505	Diode	Speed up
D506	LED	LCD back light
D507	Diode	Voltage reference
D508~510	LED	LED / Key pad back light
D511	LED	LCD back light
D512~516	LED	LED / Key pad back light

TX-RX UNIT (X57-588X-XX)

Ref. No.	Use/Function	Operation/Condition
IC1	IC	RF Power Module
IC2	IC	PLL system
IC3	IC	Comparator (APC)
IC4	IC	FM IF system
IC5,6	IC	Shift register / Output expander
IC7	IC	Voltage regulator / 5V
IC8	IC	Voltage detector / Reset
IC9	IC	Voltage detector / INT
IC10	IC	EEPROM
IC11	IC	AF Power amplifier
IC12	IC	Flash memory
IC13	IC	Microprocessor
IC14	IC	Audio processor
IC15(1/2)	IC	2Tone amplifier
IC15(2/2)	IC	AF Pre amplifier
IC16(1/2)	IC	Bias buffer
IC16(2/2)	IC	AF Buffer amplifier
IC17	IC	D/A converter (TX AF adjustment)
IC18	IC	DTMF decoder
IC19	IC	Active filter / For LSD in
Q1	Transistor	PLL IC fin amplifier
Q2	Transistor	VCO oscillation (TX)
Q3	Transistor	RF Buffer amplifier
Q4,5	Transistor	RF amplifier
Q6	Transistor	RF amplifier / TX driver
Q7	FET	DC switch
Q8,Q9	Transistor	DC switch
Q10	FET	VCO oscillation (RX)
Q11	Transistor	Ripple filter
Q12	Transistor	Tripler
Q13	Transistor	DC switch
Q14	Transistor	2 nd IF W/N switch sets to on when Narrow
Q15	Transistor	DC switch
Q16	Transistor	DC switch / 5R
Q17	Transistor	2 nd IF W/N switch sets to on when Wide
Q18	Transistor	DC switch / 5T, Save
Q19	FET	Mixer
Q20,Q21	Transistor	DC switch / 5T, Save
Q22	Transistor	IF amplifier
Q23	Transistor	DC switch / W/N audio amplitude adjust

Ref. No.	Use/Function	Operation/Condition
Q24	Transistor	DC switch / LED (Red)
Q25	Transistor	DC switch / LED (Green)
Q26	Transistor	DC switch / Squelch
Q27	FET	DC switch / 5T, Save
Q28	Transistor	DC switch / 5M
Q30	FET	SP Mute switch
Q31	Transistor	Clock frequency shift
Q32~34	Transistor	DC switch / SP Mute
Q35(1/2)	FET	Mute switch / MIC line mute
Q35(2/2)	FET	DC switch
Q36	FET	Mute switch
Q301	FET	RF amplifier
D1	Diode	Unlock detect
D2	Variable capacitance diode	Frequency control
D3	Diode	ANT switch
D4	Variable capacitance diode	Frequency control
D5	Diode	TX/RX switch
D6	Variable capacitance diode	TX modulation
D7	Diode	ANT switch
D8	Zener Diode	Overload protection
D9	Variable capacitance diode	Frequency control
D10	Diode	ANT switch
D11	Variable capacitance diode	Frequency control
D12	Diode	Current steering
D13,14	Diode	RF switch (2 nd IF wide/narrow)
D15	Diode	Reverse protection
D17	Diode	Model check
D18	LED	LED/ Red, Green
D19	Diode	Model check
D21	Diode	Voltage drop
D22	Diode	Reverse protection
D23	Diode	Voltage clamp

PARTS LIST

* New Parts. Δ indicates safety critical components.
 Parts without **Parts No.** are not supplied.
 Les articles non mentionnés dans le **Parts No.** ne sont pas fournis.
 Teile ohne **Parts No.** werden nicht geliefert.

L: Scandinavia K: USA P: Canada
 Y: PX (Far East, Hawaii) T: England E: Europe
 Y: AAFES (Europe) X: Australia M: Other Areas

TK-372G

Ref. No.	Address	New parts	Parts No.	Description	Destination
TK-372G					
1	1A	*	A02-3568-23	CABINET ASSY	
2	3B		A82-0036-02	REAR PANEL	
3	2C		B09-0351-03	CAP (SP/MIC)	
4	2B		B11-1220-03	ILLUMINATION GUIDE	
5	2B		B38-0820-05	LCD	
6	1D		B46-0470-00	WARRANTY CARD	
7	1D	*	B62-1388-00	INSTRUCTION MANUAL	
8	3B		E04-0413-05	RF COAXIAL RECEPTACLE(SMA)	
9	3A		E23-1183-04	RELAY TERMINAL (BATT-)	
10	2A		E23-1184-14	RELAY TERMINAL (BATT+)	
11	2B		E29-1177-04	INTER CONNECTOR (LCD)	
12	2A		E37-0805-05	FLAT CABLE (TX/RX-DISP)	
13	1B		E37-0829-05	PROCESSED LEAD WIRE	
14	3A		E37-0830-05	FLAT CABLE (PTT)	
15	2B		F10-2302-04	SHIELDING COVER(POWER MODULE)	
16	2A		F10-2304-03	SHIELDING COVER(TX-RX UNIT)	
17	2A		F20-3307-04	INSULATING SHEET(TX-RX UNIT)	
18	2A		F20-3308-04	INSULATING SHEET(TX-RX UNIT)	
19	1A		G01-0881-04	COIL SPRING (BATT RELEASE)	
20	1B		G10-1232-04	FIBROUS SHEET (SPEAKER)	
21	3B		G13-1744-14	CUSHION (CHASSIS-BATT)	
-	-		G13-1834-04	CUSHION (TERMINAL + -)	
22	1B		G53-0882-03	PACKING (SPEAKER/ECM)	
23	3A		G53-0883-04	PACKING (BATT TERMINAL)	
24	1A		G53-0891-04	PACKING (PTT KNOB)	
25	1A	*	G53-1530-02	PACKING (SIDE)	
26	2B	*	G53-1531-03	PACKING (SP/MIC)	
27	1C,2C		H12-1487-02	PACKING FIXTURE	
28	3C	*	H12-3093-02	PACKING FIXTURE	
29	3D	*	H12-3094-03	PACKING FIXTURE	
30	2D	*	H21-0769-04	PROTECTION COVER	
31	1C		H25-0085-04	PROTECTION BAG (100/200/0.07)	
32	2C		H25-2012-04	PROTECTION BAG (75/100/0.08)	
33	1C	*	H52-1698-02	ITEM CARTON CASE	
34	1A		J19-1572-04	HOLDER (BATT RELEASE)	
35	2B		J19-5352-03	HOLDER (VOL/ENC)	
36	2A		J19-5353-14	HOLDER (BATT TERMINAL)	
37	2C		J21-4493-04	SP/MIC HOLDER	
38	2B		J21-8377-03	LCD HOLDER	
39	1B		J21-8378-04	SPEAKER FIXTURE	
40	1C		J29-0658-05	BELT HOOK	
41	2A		J32-0925-04	HEXAGON BOSS	
42	1B		K29-5331-03	KNOB (ENCODER)	
43	1B		K29-5332-03	KNOB (VOLUME)	
44	1A		K29-5333-13	BUTTON KNOB (MONI/LAMP)	
45	1A		K29-5334-13	BUTTON KNOB (PTT)	
46	1A		K29-5337-03	LEVER KNOB (BATT RELEASE)	
47	1A	*	K29-9043-02	KEY TOP	
A	3B		N09-2319-05	BINDING HEAD SCREW	

Ref. No.	Address	New parts	Parts No.	Description	Destination
B	2A		N09-2331-05	SPECIAL SCREW	
C	1B		N14-0582-14	CIRCULAR NUT	
D	1B		N14-0583-04	CIRCULAR NUT	
E	3A		N30-2606-46	PAN HEAD MACHINE SCREW	
F	2A		N39-2030-46	PAN HEAD MACHINE SCREW	
G	2B		N67-2005-46	PAN HEAD SEMS SCREW W	
H	1B,3A,3B		N78-2045-46	PAN HEAD TAPTITE SCREW	
I	3A		N79-2030-46	PAN HEAD TAPTITE SCREW	
J	2A,2B		N83-2005-46	PAN HEAD TAPTITE SCREW	
K	2C		N99-2012-05	SCREW SET	
VR2	-		R31-0628-15	VARIABLE RESISTOR	
SP	1B		T07-0326-05	SPEAKER	
S1	-		W02-1969-15	ENCODER	
48	2D		W09-0940-15	BATTERY ASSY	
DISPLAY UNIT (X54-3250-10)					
D506			B30-2210-05	LED(TLY)	
D508-510			B30-2171-05	LED(D)	
D511			B30-2210-05	LED(TLY)	
D512-516			B30-2171-05	LED(D)	
C501-509			CC73GCH1H221J	CHIP C 220PF J	
C513			CK73GB1H102K	CHIP C 1000PF K	
C515,516			CC73GCH1H101J	CHIP C 100PF J	
CN501			E40-6012-05	FLAT CABLE CONNECTOR	
L501,502			L92-0138-05	FERRITE CHIP	
CP501			R90-0748-05	MULTI-COMP 47K X4	
CP502,503			R90-0724-05	MULTI-COMP 1K X4	
R501-510			RK73GB1J102J	CHIP R 1.0K J 1/16W	
R511			R92-1252-05	CHIP R 0 OHM	
R512			RK73GB1J102J	CHIP R 1.0K J 1/16W	
R513-515			RK73GB1J103J	CHIP R 10K J 1/16W	
R516			RK73GB1J473J	CHIP R 47K J 1/16W	
R517			RK73GB1J103J	CHIP R 10K J 1/16W	
R518			RK73GB1J471J	CHIP R 470 J 1/16W	
R519-522			RK73GB1J102J	CHIP R 1.0K J 1/16W	
R523			RK73GB1J473J	CHIP R 47K J 1/16W	
R524			RK73GB1J471J	CHIP R 470 J 1/16W	
D501-504			MA2S111	DIODE	
D505			1SS373	DIODE	
D507			MA2S111	DIODE	
IC501			LC75823W	MOS IC	
Q501			2SB1132(Q,R)	TRANSISTOR	
Q502			2SC4617(S)	TRANSISTOR	
TX-RX UNIT (X57-5880-XX)					
-11:TK-372G K		-16:TK-372G K2		-17:TK-372G K3	
-13:TK-370G K4					
D18			B30-2019-05	LED(RED/GRE)	
C1			CK73GB1H471K	CHIP C 470PF K	
C2			CC73GCH1H020C	CHIP C 2.0PF C	
C3			CC73GCH1H010B	CHIP C 1.0PF B	K4

K : TK-372G K K3 : TK-372G K3
 K2 : TK-372G K2 K4 : TK-372G K4

PARTS LIST

DISPLAY UNIT (X54-3250-10)
TX-RX UNIT (X57-5880-XX)

Ref. No.	Address	New parts	Parts No.	Description	Destination	Ref. No.	Address	New parts	Parts No.	Description	Destination
C3			CC73GCH1H1R5B	CHIP C 1.5PF B	K3	C48,49			C92-0001-05	CHIP-C 0.1UF 35WV	
C3-5			CC73GCH1H010B	CHIP C 1.0PF B	K2	C51			C92-0004-05	CHIP-TAN 1.0UF 16WV	K,K2
C4			CC73GCH1H0R5B	CHIP C 0.5PF B	K4	C51			C92-0585-05	CHIP-TAN 4.7UF 16WV	K3,K4
C4			CC73GCH1H010B	CHIP C 1.0PF B	K3	C52			CC73GCH1H020B	CHIP C 2.0PF B	K3
C4,5			CC73GCH1H010B	CHIP C 1.0PF B	K	C52			CC73GCH1H030B	CHIP C 3.0PF B	K2,K4
C5			CC73GCH1H0R5B	CHIP C 0.5PF B	K3	C52			CC73GCH1H040B	CHIP C 4.0PF B	K
C5			CC73GCH1H020B	CHIP C 2.0PF B	K4	C53			CK73GB1H471K	CHIP C 470PF K	
C6			CK73GB1C104K	CHIP C 0.10UF K		C54			CK73FB1C474K	CHIP C 0.47UF K	
C8			CC73GCH1H030B	CHIP C 3.0PF B		C55			CK73GB1H471K	CHIP C 470PF K	
C9			CK73GB1H471K	CHIP C 470PF K		C57			CK73FB1C474K	CHIP C 0.47UF K	
C10			CC73GCH1H080B	CHIP C 8.0PF B	K,K2	C58			CK73GB1H103K	CHIP C 0.010UF K	
C10			CC73GCH1H180G	CHIP C 18PF G	K3	C60			CK73GB1H103K	CHIP C 0.010UF K	
C10			CC73GCH1H270G	CHIP C 27PF G	K4	C62			CC73GCH1H560J	CHIP C 56PF J	
C11			CC73GCH1H080D	CHIP C 8.0PF D	K,K2,K3	C63			CC73GCH1H070B	CHIP C 7.0PF B	
C11			CC73GCH1H120J	CHIP C 12PF J	K4	C64			CC73GCH1H010B	CHIP C 1.0PF B	
C12			CC73GCH1H070D	CHIP C 7.0PF D	K,K2,K3	C68			C92-0565-05	CHIP-TAN 6.8UF 10WV	
C12			CC73GCH1H110J	CHIP C 11PF J	K4	C70			CK73GB1H103K	CHIP C 0.010UF K	
C13			CK73GB1H471K	CHIP C 470PF K		C71			CC73GCH1H101J	CHIP C 100PF J	
C14			CC73GCH1H0R5B	CHIP C 0.5PF B		C72			CC73GCH1H180G	CHIP C 18PF G	K2,K3,K4
C16			CC73GCH1H060B	CHIP C 6.0PF B	K,K3	C72			CC73GCH1H330G	CHIP C 33PF G	K
C16			CC73GCH1H080B	CHIP C 8.0PF B	K2	C73			CK73GB1H471K	CHIP C 470PF K	
C16,17			CC73GCH1H040B	CHIP C 4.0PF B	K4	C74			CK73FB1E104K	CHIP C 0.10UF K	
C17			CC73GCH1H040B	CHIP C 4.0PF B	K,K2,K3	C75			CK73GB1H471K	CHIP C 470PF K	
C18			CC73GCH1H060B	CHIP C 6.0PF B	K	C76			CK73GB1H102K	CHIP C 1000PF K	
C18			CC73GCH1H100C	CHIP C 10PF C	K2,K3	C77			CC73GCH1H010B	CHIP C 1.0PF B	K3,K4
C18			CC73GCH1H270J	CHIP C 27PF J	K4	C77			CC73GCH1H030B	CHIP C 3.0PF B	K
C20			CC73GCH1H020B	CHIP C 2.0PF B	K2,K3	C77			CC73GCH1H040B	CHIP C 4.0PF B	K2
C20			CC73GCH1H030B	CHIP C 3.0PF B	K	C78			CC73GCH1H470J	CHIP C 47PF J	
C20			CC73GCH1H040B	CHIP C 4.0PF B	K4	C81			CC73GCH1H010C	CHIP C 1.0PF C	
C21			CC73GCH1H0R5B	CHIP C 0.5PF B	K4	C82			CK73GB1H102K	CHIP C 1000PF K	K
C22			CC73GCH1H101J	CHIP C 100PF J		C84,85			CK73GB1H471K	CHIP C 470PF K	
C23			CC73GCH1H020B	CHIP C 2.0PF B	K	C86,87			CC73GCH1H100D	CHIP C 10PF D	
C23			CC73GCH1H050B	CHIP C 5.0PF B	K2,K3,K4	C88			CC73GCH1H020B	CHIP C 2.0PF B	K2
C24			CC73GCH1H030B	CHIP C 3.0PF B	K	C88			CC73GCH1H040B	CHIP C 4.0PF B	K,K4
C24			CC73GCH1H060B	CHIP C 6.0PF B	K3	C88			CC73GCH1H1R5B	CHIP C 1.5PF B	K3
C24			CC73GCH1H080B	CHIP C 8.0PF B	K2	C89			CC73GCH1H070B	CHIP C 7.0PF B	
C24,25			CC73GCH1H080B	CHIP C 8.0PF B	K4	C90			C92-0560-05	CHIP-TAN 10UF 6.3WV	
C25			CC73GCH1H040B	CHIP C 4.0PF B	K	C94			C92-0560-05	CHIP-TAN 10UF 6.3WV	
C25			CC73GCH1H070B	CHIP C 7.0PF B	K3	C95,96			CK73GB1H471K	CHIP C 470PF K	
C25			CC73GCH1H090B	CHIP C 9.0PF B	K2	C98			C92-0560-05	CHIP-TAN 10UF 6.3WV	
C26			CC73GCH1H020B	CHIP C 2.0PF B	K4	C99			CK73GB1C104K	CHIP C 0.10UF K	
C26			CC73GCH1H1R5B	CHIP C 1.5PF B	K,K2,K3	C100			C92-0507-05	CHIP-TAN 4.7UF 6.3WV	
C27			CC73GCH1H0R5B	CHIP C 0.5PF B		C101			CK73GB1H471K	CHIP C 470PF K	
C28			CC73GCH1H060D	CHIP C 6.0PF D	K,K2,K3	C104			CK73GB1H471K	CHIP C 470PF K	
C28			CC73GCH1H070D	CHIP C 7.0PF D	K4	C107,108			CK73GB1C104K	CHIP C 0.10UF K	
C29			CC73GCH1H220J	CHIP C 22PF J		C109			C92-0560-05	CHIP-TAN 10UF 6.3WV	
C30			CC73GCH1H060D	CHIP C 6.0PF D	K,K2,K3	C110			CK73GB1H103K	CHIP C 0.010UF K	
C30			CC73GCH1H080D	CHIP C 8.0PF D	K4	C111			CK73GB1H471K	CHIP C 470PF K	
C31			C92-0507-05	CHIP-TAN 4.7UF 6.3WV		C112			CC73GCH1H050B	CHIP C 5.0PF B	
C32			CK73GB1C104K	CHIP C 0.10UF K		C113			CK73GB1H471K	CHIP C 470PF K	
C33			CC73GCH1H060B	CHIP C 6.0PF B	K	C114			CK73GB1H391K	CHIP C 390PF K	
C33			CC73GCH1H080B	CHIP C 8.0PF B	K3,K4	C115			CK73GB1C104K	CHIP C 0.10UF K	
C33			CC73GCH1H100C	CHIP C 10PF C	K2	C116			CK73GB1H471K	CHIP C 470PF K	K3,K4
C35-41			CK73GB1H471K	CHIP C 470PF K		C118			CK73GB1H471K	CHIP C 470PF K	
C42-44			CC73GCH1H101J	CHIP C 100PF J		C119			CK73FB1A105K	CHIP C 1.0UF K	
C45			CK73GB1H471K	CHIP C 470PF K		C120,121			CK73GB1H471K	CHIP C 470PF K	

PARTS LIST

TX-RX UNIT (X57-5880-XX)

Ref. No.	Address	New parts	Parts No.	Description	Destination	Ref. No.	Address	New parts	Parts No.	Description	Destination
C122			CK73FB1A105K	CHIP C 1.0UF K		C204			CK73FB1C474K	CHIP C 0.47UF K	
C123			CK73GB1H391K	CHIP C 390PF K		C205			CK73GB1H103K	CHIP C 0.010UF K	
C124			CC73GCH1H390J	CHIP C 39PF J	K,K4	C206-208			CK73GB1C104K	CHIP C 0.10UF K	
C124			CC73GCH1H560J	CHIP C 56PF J	K2,K3	C209			CK73GB1H392K	CHIP C 3900PF K	
C125,126			CK73GB1H103K	CHIP C 0.010UF K		C210			CK73GB1H102K	CHIP C 1000PF K	
C128			CC73GCH1H040C	CHIP C 4.0PF C		C211			C92-0507-05	CHIP-TAN 4.7UF 6.3WV	
C130			CK73GB1H471K	CHIP C 470PF K		C212			CK73GB1H122K	CHIP C 1200PF K	
C131			CC73GCH1H100D	CHIP C 10PF D		C213			CK73GB1H103K	CHIP C 0.010UF K	
C132			CK73GB1H103K	CHIP C 0.010UF K		C215			CK73GB1C104K	CHIP C 0.10UF K	
C133			CC73GCH1H820J	CHIP C 82PF J		C216			CK73GB1H392K	CHIP C 3900PF K	
C135			CK73GB1H103K	CHIP C 0.010UF K		C217			CK73GB1E153K	CHIP C 0.015UF K	
C136			CC73GCH1H060B	CHIP C 6.0PF B	K4	C218			CK73FB1H563K	CHIP C 0.056UF K	
C136			CC73GCH1H080D	CHIP C 8.0PF D	K,K2,K3	C219,220			CK73GB1C104K	CHIP C 0.10UF K	
C137			CK73GB1H471K	CHIP C 470PF K		C221			CK73GB1H471K	CHIP C 470PF K	
C138			CK73GB1C104K	CHIP C 0.10UF K		C222			CK73GB1H103K	CHIP C 0.010UF K	
C139			CC73GCH1H181J	CHIP C 180PF J		C223			C92-0560-05	CHIP-TAN 10UF 6.3WV	
C140			CK73GB1H103K	CHIP C 0.010UF K		C224			CK73GB1H122K	CHIP C 1200PF K	
C141			CK73GB1C104K	CHIP C 0.10UF K		C225			CC73GCH1H101J	CHIP C 100PF J	
C142			CK73FB1A105K	CHIP C 1.0UF K		C226,227			CK73GB1H562J	CHIP C 5600PF J	
C143,144			CK73GB1H471K	CHIP C 470PF K		C229			CK73FB1H471K	CHIP C 470PF K	
C146,147			CK73GB1C104K	CHIP C 0.10UF K		C230			CK73GB1H562J	CHIP C 5600PF J	
C148			CK73GB1H103K	CHIP C 0.010UF K		C231			C92-0521-05	CHIP-TAN 0.47UF 20WV	
C150			CK73GB1H102K	CHIP C 1000PF K		C232			CK73GB1H471K	CHIP C 470PF K	
C151-153			CK73GB1H471K	CHIP C 470PF K		C233			CC73GCH1H151J	CHIP C 150PF J	
C155			C92-0662-05	CHIP-TAN 15UF 6.3WV		C234,235			CK73GB1H272J	CHIP C 2700PF J	
C156,157			CK73GB1H471K	CHIP C 470PF K		C236			CK73GB1C104K	CHIP C 0.10UF K	
C158			CK73FB1A105K	CHIP C 1.0UF K		C238			CK73GB1H392K	CHIP C 3900PF K	
C159			CK73GB1H471K	CHIP C 470PF K		C239			CK73GB1C104K	CHIP C 0.10UF K	
C161			CK73GB1H471K	CHIP C 470PF K		C240			CK73GB1H272J	CHIP C 2700PF J	
C162			CK73GB1H103K	CHIP C 0.010UF K		C241			CK73GB1H471K	CHIP C 470PF K	
C163,164			CK73GB1H471K	CHIP C 470PF K		C242			C92-0560-05	CHIP-TAN 10UF 6.3WV	
C165			CK73GB1H103K	CHIP C 0.010UF K		C243			CK73FB1A105K	CHIP C 1.0UF K	
C166			CK73FF1E104Z	CHIP C 0.10UF Z		C244			C92-0560-05	CHIP-TAN 10UF 6.3WV	
C167			CK73GB1H471K	CHIP C 470PF K		C245			CK73GB1H471K	CHIP C 470PF K	
C170,171			CK73GB1H471K	CHIP C 470PF K		C246			CK73FB1A105K	CHIP C 1.0UF K	
C173			C92-0567-05	CHIP-TAN 68UF 6.3WV		C247			CK73GB1E123K	CHIP C 0.012UF K	
C174			CK73GB1H471K	CHIP C 470PF K		C248			CK73GB1H103K	CHIP C 0.010UF K	
C176			CC73GCH1H101J	CHIP C 100PF J		C249			CK73GB1H222K	CHIP C 2200PF K	
C177			CK73GB1C473K	CHIP C 0.047UF K		C250			CK73GB1C683K	CHIP C 0.068UF K	
C178			C92-0560-05	CHIP-TAN 10UF 6.3WV		C251			CK73GB1C104K	CHIP C 0.10UF K	
C179			CK73GB1C104K	CHIP C 0.10UF K		C252			CK73GB1C473K	CHIP C 0.047UF K	
C180			CK73GB1H103K	CHIP C 0.010UF K		C253,254			CK73GB1H103K	CHIP C 0.010UF K	
C181			CK73GB1C393K	CHIP C 0.039UF K		C255			CK73GB1H183K	CHIP C 0.018UF K	
C182			CK73GB1H102K	CHIP C 1000PF K		C257			CK73GB1E153K	CHIP C 0.015UF K	
C183,184			CK73GB1C104K	CHIP C 0.10UF K		C258			CK73GB1C333K	CHIP C 0.033UF K	
C185			CC73GCH1H180J	CHIP C 18PF J		C259			CC73GCH1H121J	CHIP C 120PF J	
C186,187			CK73GB1C104K	CHIP C 0.10UF K		C260			CK73GB1H183K	CHIP C 0.018UF K	
C189			CK73GB1H103K	CHIP C 0.010UF K		C261			CK73GB1E153K	CHIP C 0.015UF K	
C190,191			CK73GB1C104K	CHIP C 0.10UF K		C262			CK73GB1H102K	CHIP C 1000PF K	
C192,193			CC73GCH1H300J	CHIP C 30PF J		C263			CK73GB1C104K	CHIP C 0.10UF K	
C194			C92-0507-05	CHIP-TAN 4.7UF 6.3WV		C265,266			CK73GB1C104K	CHIP C 0.10UF K	
C196			CC73GCH1H101J	CHIP C 100PF J		C268			CK73GB1H102K	CHIP C 1000PF K	
C198,199			CK73GB1H103K	CHIP C 0.010UF K		C269			CK73GB1H152K	CHIP C 1500PF K	
C200			CK73GB1A224K	CHIP C 0.22UF K		C270			CK73GB1H222K	CHIP C 2200PF K	
C201			CK73GB1H103K	CHIP C 0.010UF K		C271			CK73GB1H102K	CHIP C 1000PF K	
C202,203			CK73GB1C104K	CHIP C 0.10UF K		C302			CC73GCH1HOR3B	CHIP C 0.3PF B	K3

K : TK-372G K
K2 : TK-372G K2

K3 : TK-372G K3
K4 : TK-372G K4

PARTS LIST

TX-RX UNIT (X57-5880-XX)

Ref. No.	Address	New parts	Parts No.	Description	Destination	Ref. No.	Address	New parts	Parts No.	Description	Destination
C302			CC73GCH1H0R5B	CHIP C 0.5PF B	K2	L1			L40-2275-92	SMALL FIXED INDUCTOR(22NH)	K4
C302			CC73GCH1H010B	CHIP C 1.0PF B	K	L2			L92-0138-05	FERRITE CHIP	
C302			CC73GCH1H020B	CHIP C 2.0PF B	K4	L3			L40-3391-86	SMALL FIXED INDUCTOR(3.3U)	
C303			CC73GCH1H020B	CHIP C 2.0PF B	K	L4			L33-0744-05	SMALL FIXED INDUCTOR	K,K4
C303			CC73GCH1H040B	CHIP C 4.0PF B	K2	L4			L33-0750-05	SMALL FIXED INDUCTOR	K2
C303			CC73GCH1H1R5B	CHIP C 1.5PF B	K3	L4			L33-1266-05	SMALL FIXED INDUCTOR	K3
C303			CC73GCH1H220G	CHIP C 22PF G	K4	L5-7			L34-4546-05	AIR-CORE COIL	K2,K3
C304			CC73GCH1H100D	CHIP C 10PF D	K2	L5-7			L34-4547-05	AIR-CORE COIL	K
C304			CC73GCH1H150G	CHIP C 15PF G	K,K3	L5,6			L34-4547-05	AIR-CORE COIL	K4
C304			CK73GB1H471K	CHIP C 470PF K	K4	L7			L34-4546-05	AIR-CORE COIL	K4
C305,306			CC73GCH1HR75B	CHIP C 0.75PF B	K4	L8			L40-1575-92	SMALL FIXED INDUCTOR(15NH)	
C305,306			CC73GCH1H0R5B	CHIP C 0.5PF B	K,K2,K3	L9			L40-1075-92	SMALL FIXED INDUCTOR(10NH)	K,K2,K3
C307			CC73GCH1H220J	CHIP C 22PF J		L9			L40-1275-92	SMALL FIXED INDUCTOR(12NH)	K4
C309			CK73GB1H471K	CHIP C 470PF K		L10			L40-1095-34	SMALL FIXED INDUCTOR(1UH)	
C311			CC73GCH1H020B	CHIP C 2.0PF B	K	L11			L40-1092-81	SMALL FIXED INDUCTOR	
C311			CC73GCH1H030B	CHIP C 3.0PF B	K4	L12			L40-2702-86	SMALL FIXED INDUCTOR(27U)	K2,K3,K4
C311			CC73GCH1H060B	CHIP C 6.0PF B	K2	L12			L40-3391-86	SMALL FIXED INDUCTOR(3.3U)	K
C311			CC73GCH1H1R5B	CHIP C 1.5PF B	K3	L14			L40-1875-92	SMALL FIXED INDUCTOR(18NH)	K,K4
C312			CC73GCH1H0R3B	CHIP C 0.3PF B	K3	L14,15			L40-1875-92	SMALL FIXED INDUCTOR(18NH)	K2,K3
C312			CC73GCH1H010B	CHIP C 1.0PF B	K4	L15			L40-2275-92	SMALL FIXED INDUCTOR(22NH)	K
C312			CC73GCH1H030B	CHIP C 3.0PF B	K2	L15			L40-2775-92	SMALL FIXED INDUCTOR(27NH)	K4
C312			CC73GCH1H040B	CHIP C 4.0PF B	K	L17			L34-4546-05	AIR-CORE COIL	K2,K3
C314			CC73GCH1H010B	CHIP C 1.0PF B	K3	L17			L34-4547-05	AIR-CORE COIL	K,K4
C314			CC73GCH1H020B	CHIP C 2.0PF B	K2	L18-20			L92-0138-05	FERRITE CHIP	
C314			CC73GCH1H030B	CHIP C 3.0PF B	K	L21			L40-1275-92	SMALL FIXED INDUCTOR(12NH)	K3
C316,317			CK73GB1H471K	CHIP C 470PF K		L21			L40-1875-92	SMALL FIXED INDUCTOR(18NH)	K,K2,K4
C319			CK73GB1H471K	CHIP C 470PF K	K3,K4	L22			L40-1085-92	SMALL FIXED INDUCTOR(100NH)	K
C320			CC73GCH1H030B	CHIP C 3.0PF B	K4	L22			L40-1585-92	SMALL FIXED INDUCTOR(150NH)	K2,K3
C320,321			CC73GCH1H040B	CHIP C 4.0PF B	K3	L22			L40-1885-92	SMALL FIXED INDUCTOR(180NH)	K4
C322			CK73GB1H471K	CHIP C 470PF K	K3	L23			L92-0138-05	FERRITE CHIP	
C325,326			CK73GB1H471K	CHIP C 470PF K		L24			L40-5681-86	SMALL FIXED INDUCTOR(0.56U)	
C327			CC73GCH1H080B	CHIP C 8.0PF B	K	L25			L40-1085-92	SMALL FIXED INDUCTOR(100NH)	K
C327			CC73GCH1H120G	CHIP C 12PF G	K2,K4	L25			L40-1585-92	SMALL FIXED INDUCTOR(150NH)	K2,K3
C327			CC73GCH1H270G	CHIP C 27PF G	K3	L25			L40-1885-92	SMALL FIXED INDUCTOR(180NH)	K4
C328,329			CK73GB1H471K	CHIP C 470PF K	K3,K4	L26			L33-0744-05	SMALL FIXED INDUCTOR	K,K2,K3
C330,331			CC73GCH1H040B	CHIP C 4.0PF B	K3	L26			L33-0745-05	SMALL FIXED INDUCTOR	K4
C330,331			CC73GCH1H050B	CHIP C 5.0PF B	K4	L27			L92-0149-05	FERRITE CHIP	
C332			CC73GCH1H040B	CHIP C 4.0PF B	K4	L30			L40-2702-86	SMALL FIXED INDUCTOR(27U)	
C332			CC73GCH1H050B	CHIP C 5.0PF B	K3	L31			L40-1085-92	SMALL FIXED INDUCTOR(100NH)	K
TC1,2			C05-0384-05	CERAMIC TRIMMER CAP(10P)		L31			L40-1585-92	SMALL FIXED INDUCTOR(150NH)	K2,K3
TC301-303			C05-0383-05	CERAMIC TRIMMER CAP(6P)	K,K2	L31			L40-1885-92	SMALL FIXED INDUCTOR(180NH)	K4
TC301,302			C05-0383-05	CERAMIC TRIMMER CAP(6P)	K4	L32			L40-1005-85	SMALL FIXED INDUCTOR(10U)	
TC302,303			C05-0382-05	CERAMIC TRIMMER CAP(3P)	K3	L35			L40-1075-92	SMALL FIXED INDUCTOR(10NH)	K2
TC303			C05-0382-05	CERAMIC TRIMMER CAP(3P)	K4	L35			L40-1275-92	SMALL FIXED INDUCTOR(12NH)	K,K3
CN1			E40-6012-05	FLAT CABLE CONNECTOR		L35			L40-2775-92	SMALL FIXED INDUCTOR(27NH)	K4
CN3			E40-5662-05	PIN ASSY SOCKET		L36			L40-1085-85	SMALL FIXED INDUCTOR(0.10U)	
CN5			E40-5932-05	PIN ASSY SOCKET		L37			L40-6885-85	SMALL FIXED INDUCTOR(0.68U)	
J1			E11-0457-05	PHONE JACK (2.5/3.5D)		L38			L92-0138-05	FERRITE CHIP	
F1			F53-0130-05	FUSE		L39			L92-0149-05	FERRITE CHIP	
F1			F53-0217-05	FUSE		L40,41			L92-0138-05	FERRITE CHIP	
CD1			L79-1474-05	TUNING COIL		L42			L92-0131-05	FERRITE CHIP	
CF1			L72-0968-05	CERAMIC FILTER		L43,44			L92-0138-05	FERRITE CHIP	
CF2			L72-0969-05	CERAMIC FILTER		L301			L40-3975-92	SMALL FIXED INDUCTOR(39NH)	K2
L1			L40-1575-92	SMALL FIXED INDUCTOR(15NH)	K2,K3	L301			L40-5675-92	SMALL FIXED INDUCTOR(56NH)	K,K3,K4
L1			L40-1875-92	SMALL FIXED INDUCTOR(18NH)	K	L302			L34-4546-05	AIR-CORE COIL	
						L303			L40-2275-92	SMALL FIXED INDUCTOR(22NH)	K4

PARTS LIST

TX-RX UNIT (X57-5880-XX)

Ref. No.	Address	New parts	Parts No.	Description	Destination	Ref. No.	Address	New parts	Parts No.	Description	Destination
L303			L40-3975-92	SMALL FIXED INDUCTOR(39NH)	K2	R35			RK73GB1J104J	CHIP R 100K J 1/16W	
L303			L40-5675-92	SMALL FIXED INDUCTOR(56NH)	K,K3	R36			RK73GB1J473J	CHIP R 47K J 1/16W	
L304-306			L34-4546-05	AIR-CORE COIL	K,K2	R37			RK73GB1J392J	CHIP R 3.9K J 1/16W	
L304,305			L34-4546-05	AIR-CORE COIL	K3,K4	R38			RK73GB1J101J	CHIP R 100 J 1/16W	
L307			L40-4785-85	SMALL FIXED INDUCTOR(0.47U)		R39			RK73GB1J220J	CHIP R 22 J 1/16W	
L308-310			L34-4546-05	AIR-CORE COIL	K,K2	R41			RK73GB1J100J	CHIP R 10 J 1/16W	
L308,309			L34-4546-05	AIR-CORE COIL	K3,K4	R42			RK73GB1J220J	CHIP R 22 J 1/16W	
L311			L33-1301-05	SMALL FIXED INDUCTOR	K3	R43			RK73GB1J101J	CHIP R 100 J 1/16W	
L311			L40-8268-53	SMALL FIXED INDUCTOR(8.2NH)	K4	R44			RK73GB1J102J	CHIP R 1.0K J 1/16W	
L312			L40-1575-92	SMALL FIXED INDUCTOR(15NH)	K2	R45			RK73GB1J222J	CHIP R 2.2K J 1/16W	K
L312			L40-2775-92	SMALL FIXED INDUCTOR(27NH)	K	R45			RK73GB1J562J	CHIP R 5.6K J 1/16W	K2,K3,K4
L313			L40-1275-92	SMALL FIXED INDUCTOR(12NH)	K3	R46			RN73GH1J154D	CHIP R 150K D 1/16W	
X1		*	L77-1833-05	TCXO (16.8MHZ)		R47			RK73GB1J104J	CHIP R 100K J 1/16W	
X2			L78-0479-05	RESONATOR (3.58MHZ)		R48			RK73GB1J334J	CHIP R 330K J 1/16W	
X3			L77-1810-05	CRYSTAL RESONATOR(9.8304MHZ)		R49			RK73GB1J103J	CHIP R 10K J 1/16W	
X3			L77-1835-05	CRYSTAL RESONATOR(9.8304MHZ)		R50			RN73GH1J154D	CHIP R 150K D 1/16W	
XF1			L71-0546-05	CRYSTAL FILTER (49.95MHZ)		R51			RK73GB1J102J	CHIP R 1.0K J 1/16W	
CP1			R90-0724-05	MULTI-COMP 1K X4		R52			RK73GB1J181J	CHIP R 180 J 1/16W	
CP2-9			R90-0741-05	MULTIPLE RESISTOR		R53			RK73GB1J472J	CHIP R 4.7K J 1/16W	
CP10			R90-0724-05	MULTI-COMP 1K X4		R54			RN73GH1J154D	CHIP R 150K D 1/16W	
CP11-18			R90-0741-05	MULTIPLE RESISTOR		R55			RK73GB1J105J	CHIP R 1.0M J 1/16W	
CP19			R90-0718-05	MULTI-COMP 4.7K X4		R56-58			RK73EB2ER39K	CHIP R 0.39 K 1/4W	
CP20			RK75HA1J472J	CHIP-COM 4.7K J 1/16W		R59			RN73GH1J154D	CHIP R 150K D 1/16W	
R1			RK73GB1J124J	CHIP R 120K J 1/16W	K,K2	R60			R92-1252-05	CHIP R 0 OHM	
R1			RK73GB1J394J	CHIP R 390K J 1/16W	K3,K4	R61			RK73GB1J104J	CHIP R 100K J 1/16W	
R2			RK73GB1J104J	CHIP R 100K J 1/16W		R62			RN73GH1J154D	CHIP R 150K D 1/16W	
R3			RK73GB1J392J	CHIP R 3.9K J 1/16W	K	R64,65			RK73GB1J104J	CHIP R 100K J 1/16W	
R3			RK73GB1J472J	CHIP R 4.7K J 1/16W	K2,K3,K4	R67			RK73GB1J273J	CHIP R 27K J 1/16W	
R4			RK73GB1J102J	CHIP R 1.0K J 1/16W		R68			RN73GH1J154D	CHIP R 150K D 1/16W	
R5			RK73GB1J152J	CHIP R 1.5K J 1/16W		R69			RK73GB1J220J	CHIP R 22 J 1/16W	
R6			R92-1252-05	CHIP R 0 OHM		R70			RK73GB1J104J	CHIP R 100K J 1/16W	K
R7			RK73GB1J100J	CHIP R 10 J 1/16W		R71			RK73GB1J124J	CHIP R 120K J 1/16W	
R8			RK73GB1J102J	CHIP R 1.0K J 1/16W		R72			RK73GB1J103J	CHIP R 10K J 1/16W	
R9			RK73GB1J332J	CHIP R 3.3K J 1/16W		R73			RK73GB1J273J	CHIP R 27K J 1/16W	
R10			RK73GB1J331J	CHIP R 330 J 1/16W		R74,75			RK73GB1J223J	CHIP R 22K J 1/16W	
R13			RK73GB1J472J	CHIP R 4.7K J 1/16W		R76			R92-0670-05	CHIP R 0 OHM	
R14			RK73GB1J332J	CHIP R 3.3K J 1/16W		R77			R92-1252-05	CHIP R 0 OHM	
R16			RK73GB1J391J	CHIP R 390 J 1/16W		R78,79			RK73GB1J153J	CHIP R 15K J 1/16W	
R17			RK73GB1J103J	CHIP R 10K J 1/16W		R80,81			RK73GB1J223J	CHIP R 22K J 1/16W	
R18			RK73GB1J124J	CHIP R 120K J 1/16W		R82			RK73GB1J102J	CHIP R 1.0K J 1/16W	
R19			RK73GB1J332J	CHIP R 3.3K J 1/16W		R83			RK73GB1J104J	CHIP R 100K J 1/16W	K3,K4
R20			RK73GB1J122J	CHIP R 1.2K J 1/16W		R84			RK73GB1J394J	CHIP R 390K J 1/16W	K2,K3,K4
R21			RK73GB1J331J	CHIP R 330 J 1/16W		R84			RK73GB1J474J	CHIP R 470K J 1/16W	K
R22			RK73GB1J561J	CHIP R 560 J 1/16W		R85			RK73GB1J102J	CHIP R 1.0K J 1/16W	
R23			RK73GB1J222J	CHIP R 2.2K J 1/16W		R86			RK73GB1J334J	CHIP R 330K J 1/16W	
R24			RK73GB1J682J	CHIP R 6.8K J 1/16W		R87			R92-1252-05	CHIP R 0 OHM	
R25			RK73GB1J470J	CHIP R 47 J 1/16W		R88			RK73GB1J102J	CHIP R 1.0K J 1/16W	
R26			RK73GB1J561J	CHIP R 560 J 1/16W		R89			RK73GB1J821J	CHIP R 820 J 1/16W	
R27			RK73GB1J390J	CHIP R 39 J 1/16W		R90,91			RK73GB1J332J	CHIP R 3.3K J 1/16W	
R28,29			RK73GB1J271J	CHIP R 270 J 1/16W		R92			RK73GB1J100J	CHIP R 10 J 1/16W	
R30			RK73GB1J152J	CHIP R 1.5K J 1/16W	K4	R93			RK73GB1J332J	CHIP R 3.3K J 1/16W	
R30			RK73GB1J182J	CHIP R 1.8K J 1/16W	K3	R94			RK73GB1J221J	CHIP R 220 J 1/16W	
R30			RK73GB1J472J	CHIP R 4.7K J 1/16W	K,K2	R95			RK73GB1J102J	CHIP R 1.0K J 1/16W	K2
R31			RK73GB1J101J	CHIP R 100 J 1/16W		R95			RK73GB1J222J	CHIP R 2.2K J 1/16W	K,K3
R33			RK73GB1J101J	CHIP R 100 J 1/16W		R95			RK73GB1J561J	CHIP R 560 J 1/16W	K4
R34			RK73GB1J473J	CHIP R 47K J 1/16W		R96			RK73GB1J181J	CHIP R 180 J 1/16W	K,K3,K4

K : TK-372G K
K2 : TK-372G K2K3 : TK-372G K3
K4 : TK-372G K4

PARTS LIST

TX-RX UNIT (X57-5880-XX)

Ref. No.	Address	New parts	Parts No.	Description	Destination	Ref. No.	Address	New parts	Parts No.	Description	Destination
R96			RK73GB1J820J	CHIP R 82 J 1/16W	K2	R161			RK73GB1J563J	CHIP R 56K J 1/16W	
R97			RK73GB1J183J	CHIP R 18K J 1/16W		R162			RN73GH1J333D	CHIP R 33K D 1/16W	
R98			RK73GB1J473J	CHIP R 47K J 1/16W		R163			RN73GH1J274D	CHIP R 270K D 1/16W	
R99			RK73GB1J684J	CHIP R 680K J 1/16W		R164			RK73GB1J184J	CHIP R 180K J 1/16W	
R100			RK73GB1J473J	CHIP R 47K J 1/16W		R165			RK73GB1J473J	CHIP R 47K J 1/16W	
R101			RK73GB1J104J	CHIP R 100K J 1/16W		R166			RK73GB1J103J	CHIP R 10K J 1/16W	
R102,103			RK73GB1J272J	CHIP R 2.7K J 1/16W		R167			RK73GB1J564J	CHIP R 560K J 1/16W	
R104			RK73GB1J472J	CHIP R 4.7K J 1/16W		R168			RK73GB1J102J	CHIP R 1.0K J 1/16W	
R105			RK73GB1J222J	CHIP R 2.2K J 1/16W		R169			RK73GB1J473J	CHIP R 47K J 1/16W	
R106			RK73GB1J272J	CHIP R 2.7K J 1/16W		R170			RK73GB1J394J	CHIP R 390K J 1/16W	
R107			RK73GB1J470J	CHIP R 47 J 1/16W		R171			RK73GB1J474J	CHIP R 470K J 1/16W	
R108			RK73GB1J222J	CHIP R 2.2K J 1/16W		R172			RK73GB1J473J	CHIP R 47K J 1/16W	
R109			RK73GB1J102J	CHIP R 1.0K J 1/16W		R173			RK73GB1J104J	CHIP R 100K J 1/16W	
R110,111			RK73GB1J103J	CHIP R 10K J 1/16W		R174			R92-1252-05	CHIP R 0 OHM	
R112			RK73GB1J102J	CHIP R 1.0K J 1/16W		R175			RK73GB1J103J	CHIP R 10K J 1/16W	
R113			RK73GB1J391J	CHIP R 390 J 1/16W		R176			R92-1252-05	CHIP R 0 OHM	
R114,115			RK73GB1J103J	CHIP R 10K J 1/16W		R177			RK73GB1J473J	CHIP R 47K J 1/16W	
R116,117			RK73GB1J153J	CHIP R 15K J 1/16W		R178,179			RK73GB1J104J	CHIP R 100K J 1/16W	
R118			RK73GB1J473J	CHIP R 47K J 1/16W		R180			RK73GB1J222J	CHIP R 2.2K J 1/16W	
R119			R92-1252-05	CHIP R 0 OHM		R181			RK73GB1J472J	CHIP R 4.7K J 1/16W	
R120,121			RK73GB1J473J	CHIP R 47K J 1/16W		R182,183			R92-1252-05	CHIP R 0 OHM	
R122			RK73GB1J102J	CHIP R 1.0K J 1/16W		R184			RK73GB1J333J	CHIP R 33K J 1/16W	
R123			RK73GB1J104J	CHIP R 100K J 1/16W		R185			RK73GB1J102J	CHIP R 1.0K J 1/16W	
R124			RK73GB1J334J	CHIP R 330K J 1/16W		R186			RK73GB1J155J	CHIP R 1.5M J 1/16W	
R126			RK73GB1J472J	CHIP R 4.7K J 1/16W		R198			RK73GB1J154J	CHIP R 150K J 1/16W	
R127			RK73GB1J333J	CHIP R 33K J 1/16W		R199			RK73GB1J103J	CHIP R 10K J 1/16W	
R128			RK73GB1J102J	CHIP R 1.0K J 1/16W		R200			RK73GB1J101J	CHIP R 100 J 1/16W	
R129			RK73GB1J224J	CHIP R 220K J 1/16W		R201			R92-1252-05	CHIP R 0 OHM	
R130			R92-1252-05	CHIP R 0 OHM		R202			RK73GB1J474J	CHIP R 470K J 1/16W	
R131			RK73GB1J101J	CHIP R 100 J 1/16W		R203			R92-1252-05	CHIP R 0 OHM	
R132			RK73GB1J104J	CHIP R 100K J 1/16W		R204			RK73GB1J104J	CHIP R 100K J 1/16W	
R133			R92-1252-05	CHIP R 0 OHM		R205			RK73GB1J182J	CHIP R 1.8K J 1/16W	
R135			RK73GB1J100J	CHIP R 10 J 1/16W		R206			RK73GB1J471J	CHIP R 470 J 1/16W	
R137			RK73GB1J101J	CHIP R 100 J 1/16W		R207			RK73GB1J101J	CHIP R 100 J 1/16W	
R138			RK73GB1J102J	CHIP R 1.0K J 1/16W		R208			RN73GH1J682D	CHIP R 6.8K D 1/16W	
R139			RK73GB1J151J	CHIP R 150 J 1/16W		R209			RK73GB1J224J	CHIP R 220K J 1/16W	
R140			RK73GB1J102J	CHIP R 1.0K J 1/16W		R210			RK73GB1J474J	CHIP R 470K J 1/16W	
R142			R92-1252-05	CHIP R 0 OHM		R211			RK73GB1J103J	CHIP R 10K J 1/16W	
R143			RK73GB1J184J	CHIP R 180K J 1/16W		R212			RN73GH1J683D	CHIP R 6.8K D 1/16W	
R144			R92-1252-05	CHIP R 0 OHM		R213			RN73GH1J682D	CHIP R 6.8K D 1/16W	
R145			RK73GB1J474J	CHIP R 470K J 1/16W		R214			RK73GB1J184J	CHIP R 180K J 1/16W	
R146			RK73GB1J472J	CHIP R 4.7K J 1/16W		R215			RK73GB1J474J	CHIP R 470K J 1/16W	
R147			RK73GB1J470J	CHIP R 47 J 1/16W		R218			R92-1252-05	CHIP R 0 OHM	
R148			RK73GB1J220J	CHIP R 22 J 1/16W		R219			RK73GB1J273J	CHIP R 27K J 1/16W	
R149			RK73GB1J104J	CHIP R 100K J 1/16W		R220,221			RK73GB1J184J	CHIP R 180K J 1/16W	
R150			RK73GB1J102J	CHIP R 1.0K J 1/16W		R222			RK73GB1J153J	CHIP R 15K J 1/16W	
R151			RK73GB1J473J	CHIP R 47K J 1/16W		R223			RK73GB1J223J	CHIP R 22K J 1/16W	
R152			RK73GB1J823J	CHIP R 82K J 1/16W		R224			RK73GB1J103J	CHIP R 10K J 1/16W	
R153			RK73GB1J104J	CHIP R 100K J 1/16W		R225			RK73GB1J153J	CHIP R 15K J 1/16W	
R154			RK73GB1J564J	CHIP R 560K J 1/16W		R226			R92-1252-05	CHIP R 0 OHM	
R155			RK73GB1J473J	CHIP R 47K J 1/16W		R230			RK73GB1J223J	CHIP R 22K J 1/16W	
R156			RN73GH1J683D	CHIP R 68K D 1/16W		R231			RK73GB1J104J	CHIP R 100K J 1/16W	
R157			RK73GB1J102J	CHIP R 1.0K J 1/16W		R232			RK73GB1J182J	CHIP R 1.8K J 1/16W	K
R158			R92-1252-05	CHIP R 0 OHM		R232,233			R92-1252-05	CHIP R 0 OHM	K2,K3,K4
R159			RK73GB1J102J	CHIP R 1.0K J 1/16W		R233			R92-1252-05	CHIP R 0 OHM	K
R160			RK73GB1J222J	CHIP R 2.2K J 1/16W		R234			RK73GB1J124J	CHIP R 120K J 1/16W	

PARTS LIST

TX-RX UNIT (X57-5880-XX)

Ref. No.	Address	New parts	Parts No.	Description	Destination	Ref. No.	Address	New parts	Parts No.	Description	Destination
R235			RK73GB1J334J	CHIP R 330K J 1/16W		D12			MA2S111	DIODE	
R237			R92-1252-05	CHIP R 0 OHM		D13,14			DAN235E	DIODE	
R239			RK73GB1J153J	CHIP R 15K J 1/16W		D15			HSC277	DIODE	
R240			RK73GB1J223J	CHIP R 22K J 1/16W		D17			MA2S111	DIODE	
R241			RK73GB1J334J	CHIP R 330K J 1/16W		D21			1SS373	DIODE	
R242			R92-1252-05	CHIP R 0 OHM		D22			1SR154-400	DIODE	
R244			RK73GB1J391J	CHIP R 390 J 1/16W	K4	D23			RB706F-40	DIODE	
R244			RK73GB1J561J	CHIP R 560 J 1/16W	K,K2,K3	D302			HVC350B	VARIABLE CAPACITANCE DIODE	K4
R249			R92-1252-05	CHIP R 0 OHM		D302,303			1SV285	VARIABLE CAPACITANCE DIODE	K3
R250			RK73GB1J472J	CHIP R 4.7K J 1/16W		D305-307			HVC350B	VARIABLE CAPACITANCE DIODE	K4
R251			RK73GB1J474J	CHIP R 470K J 1/16W		D305-307			1SV285	VARIABLE CAPACITANCE DIODE	K3
R252,253			R92-1252-05	CHIP R 0 OHM		IC1			M68732H	IC (RF POWER MODULE)	K
R254			RK73GB1J184J	CHIP R 180K J 1/16W		IC1			M68732UH	IC (RF POWER MODULE)	K2
R255			RK73GB1J474J	CHIP R 470K J 1/16W		IC1			M68732SH	IC (RF POWER MODULE)	K3
R256			R92-1252-05	CHIP R 0 OHM		IC1			M68732L	IC (RF POWER MODULE)	K4
R258			R92-1252-05	CHIP R 0 OHM		IC2			MB15A02	MOS IC	
R259			RK73GB1J473J	CHIP R 47K J 1/16W		IC3			NJM2904V	MOS IC	
R260,261			RK73GB1J224J	CHIP R 220K J 1/16W		IC4			TA31136FN	MOS IC	
R301			R92-0679-05	CHIP R 0 OHM		IC5,6			BU4094BCFV	MOS IC	
R303			RK73GB1J100J	CHIP R 10 J 1/16W	K2	IC7			S-81350HG-KD	MOS IC	
R303			RK73GB1J470J	CHIP R 47 J 1/16W	K,K4	IC8			PST9140NR	MOS IC	
R303			R92-1252-05	CHIP R 0 OHM		IC9			RN5VL45C	MOS IC	
R304			R92-1252-05	CHIP R 0 OHM	K,K2,K4	IC10			AT2408N10SI2.5	ROM IC	
R305			RK73GB1J102J	CHIP R 1.0K J 1/16W	K	IC11			TA7368F	MOS IC	
R305			RK73GB1J222J	CHIP R 2.2K J 1/16W	K2,K3K4	IC12			AT29C020-90TI	ROM IC	
R306			RK73GB1J332J	CHIP R 3.3K J 1/16W	K,K2,K3	IC13			30622M4102GP	MPU	
R306			RK73GB1J472J	CHIP R 4.7K J 1/16W	K4	IC14			TC35453F	MOS IC	
R308			R92-1252-05	CHIP R 0 OHM	K3,K4	IC15			TA75W01FU	MOS IC	
R309			RK73GB1J101J	CHIP R 100 J 1/16W		IC16			TC75W51FU	MOS IC	
R310			RK73GB1J151J	CHIP R 150 J 1/16W	K3	IC17			X9C103SI	ANALOG IC	
R310			RK73GB1J221J	CHIP R 220 J 1/16W	K4	IC18			LC73872M	MOS IC	
R310			RK73GB1J331J	CHIP R 330 J 1/16W	K,K2	IC19			TA75W01FU	MOS IC	
R311			RK73GB1J104J	CHIP R 100K J 1/16W	K4	Q1			2SC5108(Y)	TRANSISTOR	
R311,312			RK73GB1J104J	CHIP R 100K J 1/16W	K3	Q2			2SC4226(R24)	TRANSISTOR	
R314			RK73GB1J224J	CHIP R 220K J 1/16W		Q3-5			2SC5108(Y)	TRANSISTOR	
R315-318			RK73GB1J104J	CHIP R 100K J 1/16W	K3,K4	Q6			2SC4988	TRANSISTOR	
R318			RK73GB1J104J	CHIP R 100K J 1/16W	K,K2	Q7			2SJ243	FET	
R320			R92-1252-05	CHIP R 0 OHM		Q8			UMC4	TRANSISTOR	
R600			R92-1252-05	CHIP R 0 OHM	K3,K4	Q9			DTC144EE	DIGITAL TRANSISTOR	
VR1			R12-7491-05	TRIMMING POT.(68K)		Q10			2SK508NV(K52)	FET	
S401			S70-0457-05	TACT SWITCH		Q11			2SC4617(S)	TRANSISTOR	
S402,403			S70-0424-05	TACT SWITCH		Q12			2SC4649(N,P)	TRANSISTOR	
MIC1			T91-0579-05	MIC ELEMENT		Q13,14			DTA144EE	DIGITAL TRANSISTOR	
D1			MA2S111	DIODE		Q15			DTC114EE	DIGITAL TRANSISTOR	
D2			MA2S376	VARIABLE CAPACITANCE DIODE		Q16			DTA114YE	DIGITAL TRANSISTOR	
D3			HVU131	DIODE		Q17			DTC144EE	DIGITAL TRANSISTOR	
D4			MA2S376	VARIABLE CAPACITANCE DIODE		Q18			FP210	TRANSISTOR	
D5			HSC277	DIODE		Q19			3SK228	FET	
D6			MA360	VARIABLE CAPACITANCE DIODE		Q20,21			UMG3N	TRANSISTOR	
D7			HSC277	DIODE	K	Q22			2SC4619	TRANSISTOR	
D7			HVC131	DIODE	K2,K3,K4	Q23			UMC4	TRANSISTOR	
D8			HZU5ALL	DIODE		Q24,25			DTC114EE	DIGITAL TRANSISTOR	
D9			MA2S376	VARIABLE CAPACITANCE DIODE		Q26			DTA114EE	DIGITAL TRANSISTOR	
D10			HSC277	DIODE		Q27			UPA572T	FET	
D11			MA2S376	VARIABLE CAPACITANCE DIODE		Q28			DTA114YE	DIGITAL TRANSISTOR	
						Q30			2SK1588	FET	

K : TK-372G K
K2 : TK-372G K2K3 : TK-372G K3
K4 : TK-372G K4

TK-372G

PARTS LIST

TX-RX UNIT (X57-5880-XX)

Ref. No.	Address	New parts	Parts No.	Description	Destination	Ref. No.	Address	New parts	Parts No.	Description	Destination
Q31			2SC4619	TRANSISTOR							
Q32			2SA1362(GR)	TRANSISTOR							
Q33,34			DTC144EE	DIGITAL TRANSISTOR							
Q35			UPA672T	FET							
Q36			2SK1824	FET							
Q301			3SK228	FET							

EXPLODED VIEW

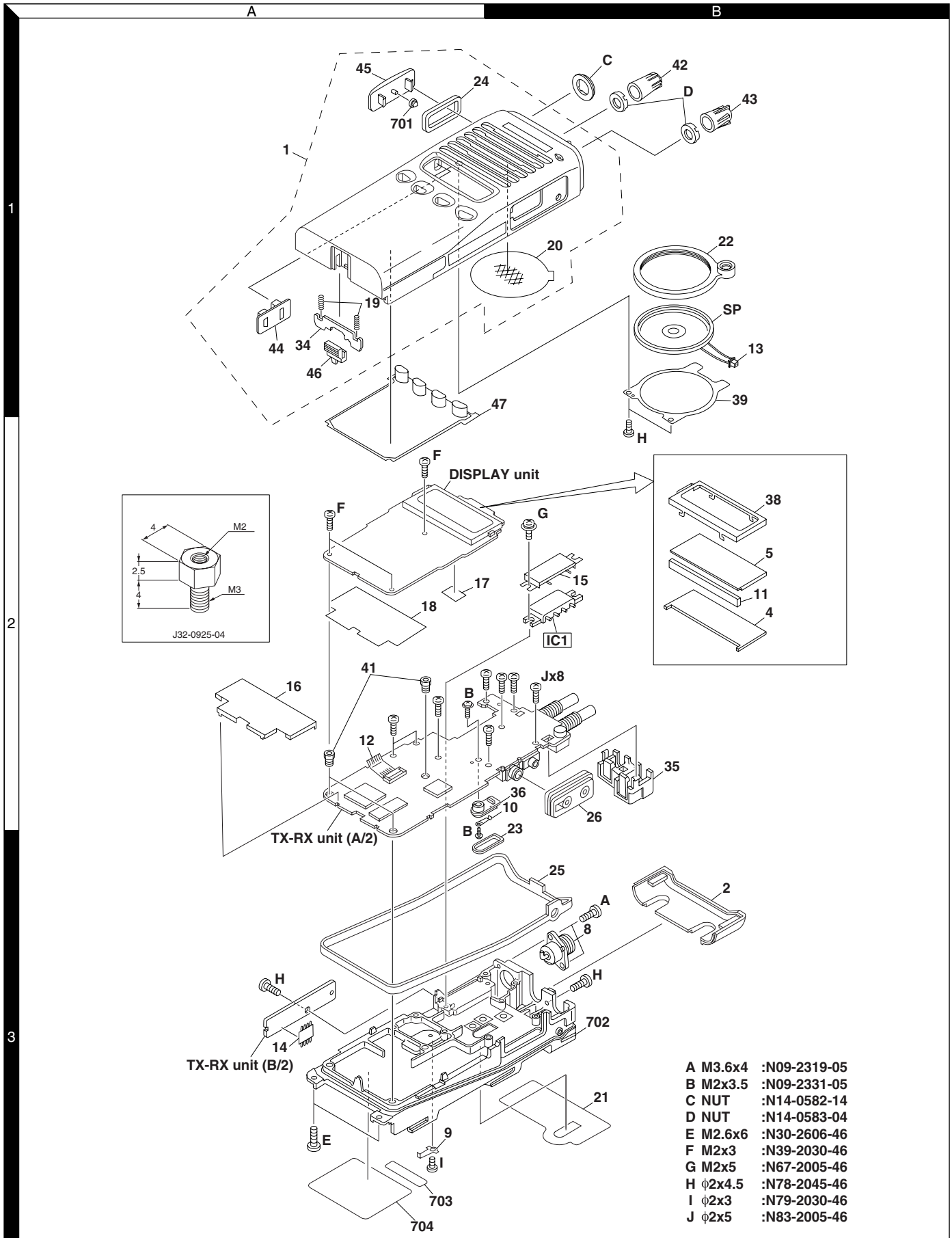

PACKING

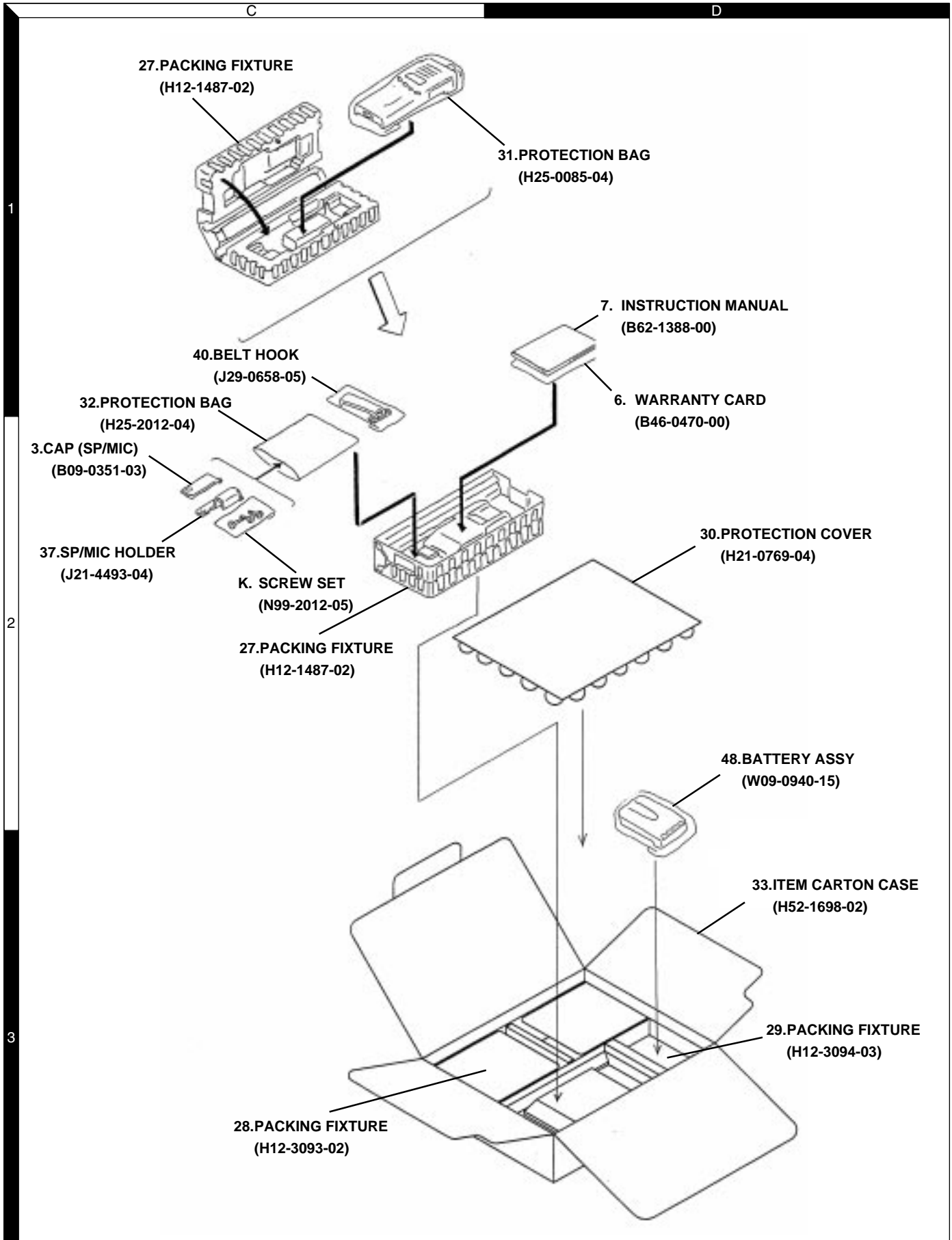

ADJUSTMENT

Test Equipment Required for Alignment

Test Equipment	Major Specifications	
1. Standard Signal Generator (SSG)	Frequency Range	450 to 470MHz (K) 403 to 430MHz (K4) 470 to 490MHz (K2) 490 to 512MHz (K3)
	Modulation	Frequency modulation and external modulation.
	Output	-127dBm/0.1μV to greater than -47dBm/1mV
2. Power Meter	Input Impedance	50Ω.
	Operation Frequency	450 to 470MHz (K) 403 to 430MHz (K4) 470 to 490MHz (K2) 490 to 512MHz (K3) or more.
	Measurement Range	Vicinity of 5W
3. Deviation Meter	Frequency Range	450 to 470MHz (K) 403 to 430MHz (K4) 470 to 490MHz (K2) 490 to 512MHz (K3)
4. Digital Volt Meter (DVM)	Measuring Range	10mV to 10V DC
	Input Impedance	High input impedance for minimum circuit loading.
5. Oscilloscope		DC through 30MHz.
6. High Sensitivity Frequency Counter	Frequency Range	10Hz to 1000MHz.
	Frequency Stability	0.2ppm or less.
7. Ammeter		5A.
8. AF Volt Meter (AF VTVM)	Frequency Range	50Hz to 10kHz.
	Voltage Range	1mV to 10V.
9. Audio Generator (AG)	Frequency Range	50Hz to 5kHz or more.
	Output	0 to 1V.
10. Distortion Meter	Capability	3% or less at 1kHz.
	Input Level	50mV to 10Vrms.
11. Spectrum Analyzer	Measuring Range	DC to 1GHz or more
12. Tracking Generator	Center frequency	50kHz to 600MHz
	Output Voltage	100mV or more
13. 8Ω Dummy Load		Approx. 8Ω, 3W.
14. Regulated Power Supply		5V to 10V, approx. 3A Useful if ammeter equipped.

■ The following parts are required for adjustment

1. Antenna connector adapter

The antenna connector of this radio uses an SMA terminal.

Use an antenna connector adapter [SMA(f) – BNC(f) or SMA(f) – N(f)] for adjustment. (The adapter is not provided as an option, so buy a commercially-available one.)

Note

When the antenna connector adapter touches the knob, draw out the knob to mount the connector.

Repair Jig (Chassis)

- Jig (chassis : Part No. A10-4009-03) for adjustment.
- Use the jig as follows.
 - Place the TX-RX unit on the jig and fix it with thirteen screws ①.
 - Solder the antenna terminal of the TX-RX unit.
- Supply power from an external power supply.

Relay terminal : + (7.5)
Jig (Chassis) : -

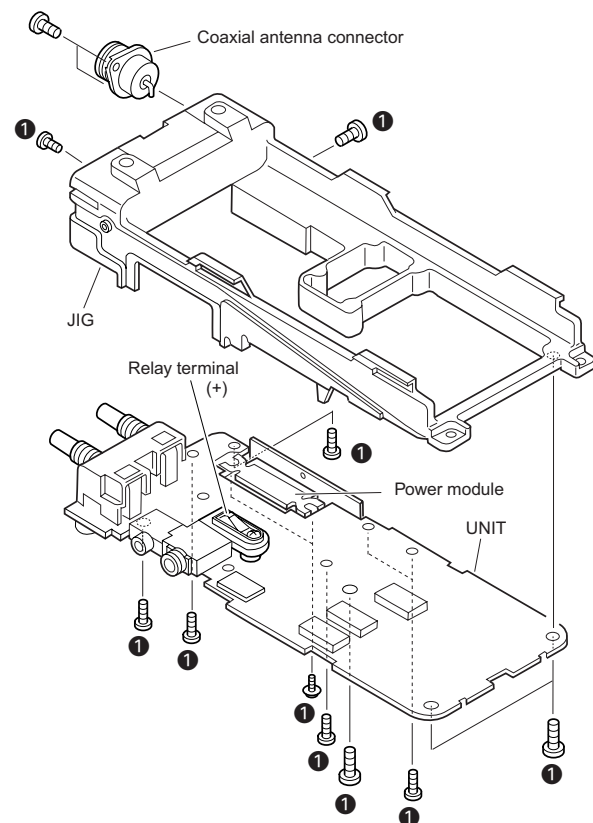

ADJUSTMENT

Repair Jig (Extension Flat cable : part No. E37-0851-05)

This cable is used for connecting the TK-372G display unit and TX/RX unit when you test or repair the transceiver.

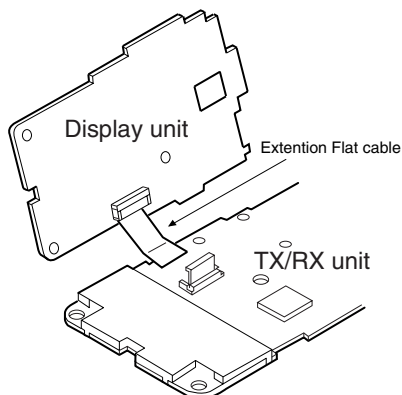

Caution : You must connect TK-372G display unit when you test or repair the transceiver.

Test Mode

■ Test mode operating features

This transceiver has a test mode. **To enter test mode, press the [◀] key and turn the power on. Hold the [◀] key until the test channel No. and test signalling No. appear on LCD.** Test mode can be inhibited by programming. To exit test mode, switch the power on again. The following functions are available in test mode.

• Controls

[PTT]	Used when making a transmission.
[Side2]	Monitor ON and OFF.
[Side1]	Changes wide and narrow.
[O]	Sets to the Tuning mode.
[●]	Unused
[◀]	RF power HIGH and LOW.
[▶]	Changes signalling.
[ENCODER]	Changes channel.

• LCD indicator

“LO” Lights at RF Power Low.
 “🔊” Lights at monitor ON.

• LED indicator

Red LED Lights during transmission. Blinks during low battery voltage warning.
 Green LED Lights when there is a carrier.

■ Frequency and signalling

The set has been adjusted for the frequencies shown in the following table. When required, re-adjust them following the adjustment procedure to obtain the frequencies you want in actual operation.

Frequency (MHz) (K type)

Channel No.	RX Frequency	TX Frequency
1	460.05000	460.00000
2	450.05000	450.00000
3	469.95000	470.00000
4	460.00000	460.00000
5	460.20000	460.20000
6	460.40000	460.40000
7~16	—	—

Frequency (MHz) (K4 type)

Channel No.	RX Frequency	TX Frequency
1	416.55000	416.50000
2	403.05000	403.00000
3	429.95000	430.00000
4	416.00000	416.00000
5	416.20000	416.20000
6	416.40000	416.40000
7~16	—	—

Frequency (MHz) (K2 type)

Channel No.	RX Frequency	TX Frequency
1	480.05000	480.00000
2	470.05000	470.00000
3	489.95000	490.00000
4	480.00000	480.00000
5	480.20000	480.20000
6	480.40000	480.40000
7~16	—	—

Frequency (MHz) (K3 type)

Channel No.	RX Frequency	TX Frequency
1	501.05000	501.00000
2	490.05000	490.00000
3	511.95000	512.00000
4	501.00000	501.00000
5	501.20000	501.20000
6	501.40000	501.40000
7~16	—	—

ADJUSTMENT

Signalling

Signalling No.	RX	TX
1	None	None
2	None	100Hz square wave
3	QT 67.0Hz	QT 67.0Hz
4	QT 151.4Hz	QT 151.4Hz
5	QT 210.7Hz	QT 210.7Hz
6	QT 250.3Hz	QT 250.3Hz
7	DQT D023N	DQT D023N
8	DQT D754I	DQT D754I
9	DTMF DEC, (159D)	DTMF ENC, (159D)
10	None	DTMF tone 9
11	2 tone 321.7/928.1Hz	ENC
12	Single tone 1200Hz	Single tone 1200Hz

• Preparations for tuning the transceiver

Before attempting to tune the transceiver, connect the unit to a suitable power supply.

Whenever the transmitter is tuned, the unit must be connected to a suitable dummy load (i.e. power meter).

The speaker output connector must be terminated with a 8Ω dummy load and connected to an AC voltmeter and an audio distortion meter or a SINAD measurement meter at all times during tuning.

• Transceiver tuning

(To place the transceiver in tuning mode)

Channel appears on the LCD. Set the channel according to the tuning requirements.

LCD display (Test mode)

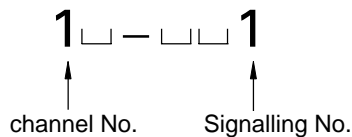

Press [O], to enter tuning mode. Use the [◀] key to write tuning data through the tuning modes, and the channel selector knob to adjust the tuning requirements (1 to 256 appears on LCD).

Use the [▶] key to select the adjustment item through the tuning modes. Use the [●] key to adjust 3 or 5 point tuning, and use the [Side1] key to switch between Wide/Narrow.

LCD display (Tuning mode)

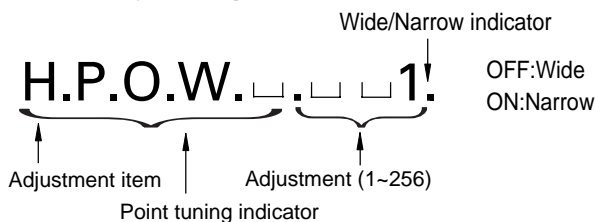

Panel Tuning Mode (K type)

	450-470(MHz)	
TEST Ch	RX frequency (MHz)	TX frequency (MHz)
Low	450.05000	450.00000
Low'	455.05000	455.00000
Center	460.05000	460.00000
High'	465.05000	465.00000
High	469.95000	470.00000

Panel Tuning Mode (K4 type)

	403-430(MHz)	
TEST Ch	RX frequency (MHz)	TX frequency (MHz)
Low	403.05000	403.00000
Low'	409.80000	409.75000
Center	416.55000	416.50000
High'	423.30000	423.25000
High	429.95000	430.00000

Panel Tuning Mode (K2 type)

	470-490(MHz)	
TEST Ch	RX frequency (MHz)	TX frequency (MHz)
Low	470.05000	470.00000
Low'	475.05000	475.00000
Center	480.05000	480.00000
High'	485.05000	485.00000
High	489.95000	490.00000

Panel Tuning Mode (K3 type)

	490-512(MHz)	
TEST Ch	RX frequency (MHz)	TX frequency (MHz)
Low	490.05000	490.00000
Low'	495.55000	495.50000
Center	501.05000	501.00000
High'	506.55000	506.50000
High	511.95000	512.00000

ADJUSTMENT

■ Tuning mode

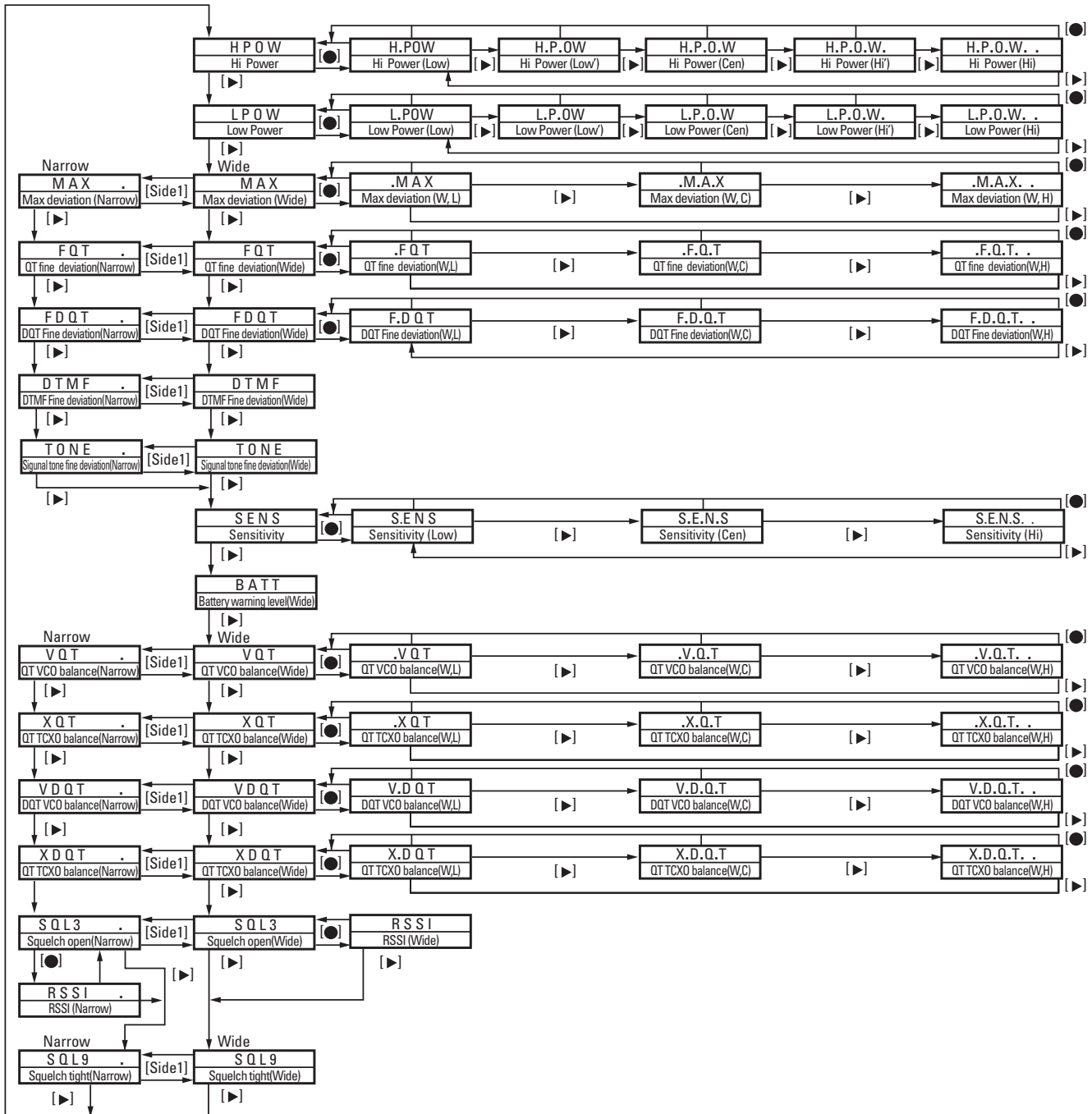

ADJUSTMENT

Note

Precision parts are used for the PTT, side1, and side2 switches.

In order to avoid damaging these switches, do not press them using your fingers. However, if it is necessary to press these switches, be sure to press them at 90° angles, pressing them at other angles can easily damage the parts.

Common Section

Item	Condition	Measurement		Adjustment		Specifications/ Remark
		Test equipment	Terminal	Parts	Method	
1. Setting	1) BATT terminal voltage:7.5V 2) SSG Standard modulation [Wide] MOD:1kHz, DEV:3kHz [Narrow] MOD:1kHz, DEV:1.5kHz [Semi wide] MOD:1kHz, DEV:2.4kHz					
2. VCO lock voltage RX	[Panel Test Mode] 1) CH-Sig:2-1 2) CH-Sig:3-1	Power meter DVM	ANT CV(LV)		Check	0.8V or more
						4.0V ± 0.1V (K)
						4.0V ± 0.1V (K4)
						4.1V ± 0.1V (K2)
TX	3) CH-Sig:2-1 PTT:ON 4) CH-Sig:3-1 PTT:ON					0.8V or more
						4.0V ± 0.1V (K, K2, K3)
						3.5V ± 0.1V (K4)

Transmitter Section

Item	Condition	Measurement		Adjustment		Specifications/ Remark
		Test equipment	Terminal	Parts	Method	
1. Frequency Adjust	1) PTT:ON	Freq. Counter Power meter Am meter	ANT	VR1		Center frequency (460.0 MHz) ± 100Hz (K) (416.5 MHz) ± 100Hz (K4) (480.0 MHz) ± 100Hz (K2) (501.0 MHz) ± 100Hz (K3)
2. Max Power Check	1) Adj item [HPOW] Adjust [256] 2) Adj item [H.P O W] → [H.P.O W] → [H.P.O.W] → [H.P.O.W.] → [H.P.O.W. .] Adjust [256] PTT:ON				Check	4.2W or more
3. Hight Power Adjust	1) Adj item [HPOW] Adjust [***] 2) Adj item [H.P O W] → [H.P.O W] → [H.P.O.W] → [H.P.O.W.] → [H.P.O.W. .] Adjust [***] PTT:ON			Encoder knob	4.2W	±0.1W 2.2A or less
4. Hight Power Check	[Panel Test Mode] 1) CH-Sig:1-1 PTT:ON 2) CH-Sig:2-1 PTT:ON 3) CH-Sig:3-1 PTT:ON				Check	3.0~5.0W 2.3A or less
5. Low Power Adjust	1) Adj item [LPOW] Adjust [***] 2) Adj item [L.P O W] → [L.P.O W] → [L.P.O.W] → [L.P.O.W.] → [L.P.O.W. .] Adjust [***] PTT:ON			Encoder knob	1.0W	±0.1W 1.0A or less

ADJUSTMENT

Item	Condition	Measurement		Adjustment		Specifications/ Remark
		Test equipment	Terminal	Parts	Method	
6. Low Power Check	[Panel Test Mode] 1) CH-Sig:1-1 Set low power (Push [◀]) PTT:ON				Check	0.5~1.5W 1.2A or less
	2) CH-Sig:2-1 PTT:ON					
	3) CH-Sig:3-1 PTT:ON					
7. Max DEV Adjust [Wide]	1) Adj item [MAX] Adjust [***] AG:1kHz / 150mV Dev meter filter LPF:15kHz HPF:OFF 2) Adj item [.M A X] → [.M.A.X] → [.M.A.X. .]	Power meter Dev meter Oscilloscope AG AF VTVM	ANT SP/MIC connector	Encoder knob	4.2kHz (According to the larger +,-)	±50Hz
	[Narrow]					
8. MIC Sensitivity Check	[Panel Test Mode] 1) CH-Sig:1-1 AG:1kHz / 15mV LPF:15kHz PTT:ON				Check	2.2~3.6kHz
9. QT TCXO Balance	Adj item [X Q T] Adjust [200] : K, K2 Adjust [229] : K3, K4 Wide, Narrow	Power meter Dev meter Oscilloscope AG AF VTVM	ANT SP/MIC connector	Encoder knob		
10.DQT TCXO Balance	Adj item [X D Q T] Adjust [150] : K, K2 Adjust [172] : K3, K4 Wide, Narrow					
11.DQT VCO Balance Adjust [Wide]	1) Adj item [VDQT] Adjust [***] LPF:3kHz HPF:OFF 2) Adj item [V.D Q T] → [V.D.Q.T] → [V.D.Q.T. .]	Power meter Dev meter Oscilloscope			Make the demodulation waves into square waves.	
	[Narrow]					
12.QT VCO Balance	Adj item [***] $[VDQT] \times \frac{200}{150} = [VQT]$ (K, M, K2, M2) $[VDQT] \times \frac{229}{172} = [VQT]$ (K3, M3, K4, M4)					

ADJUSTMENT

Item	Condition	Measurement		Adjustment		Specifications/ Remark
		Test equipment	Terminal	Parts	Method	
13. QT Deviation Adjust [Wide]	1) Adj item [FQT] Adjust [***] LPF:3kHz HPF:OFF	Power meter Dev meter Oscilloscope	ANT SP/MIC connector	Encoder knob	Wide:0.90kHz Narrow:0.42kHz	±40Hz ±40Hz
	2) Adj item [.F Q T] → [.F.Q.T] → [.F.Q.T. .] Adjust [***] PTT:ON					
[Narrow]	3) Adj item [FQT .] Adjust [***] PTT:ON					
14. DQT Deviation Adjust [Wide]	1) Adj item [FDQT] Adjust [***] LPF:3kHz HPF:OFF				Wide:0.75kHz Narrow:0.35kHz	±50Hz
	2) Adj item [F.D Q T] → [F.D.Q.T] → [F.D.Q.T. .] Adjust [***] PTT:ON					
[Narrow]	3) Adj item [FDQT .] Adjust [***] PTT:ON				Wide:0.75kHz Narrow:0.35kHz	±50Hz
15.DTMF Deviation Adjust [Wide]	1) Adj item [DTMF] Adjust [***] LPF:15kHz HPF:OFF PTT:ON				Wide:2.5kHz Narrow:1.25kHz	±0.1kHz
	[Narrow]					
16.TONE Deviation Adjust [Wide]	1) Adj item [TONE] Adjust [***] LPF:15kHz HPF:OFF PTT:ON				Wide:3.0kHz Narrow:1.5kHz	±0.1kHz
	[Narrow]					
17.BATT Detection Writing	1) Adj item [BATT] Adjust [***] PTT:ON	Power meter DVM	ANT BATT terminal	Encoder knob	After pressing the PTT switch, confirm that one predeter- mined numeric in the range of 1 to 256 appears and then press the [◀] key. That number will be stored in memory.	BATT terminal voltage:5.9V
18.BATT Detection Check	[Panel Test Mode] 1) CH-Sig:1-1 BATT terminal voltage:6.5V PTT:ON				Check	No blinking of LED
	2) BATT terminal voltage:5.7V PTT:ON					Blinking of LED

ADJUSTMENT

Item	Condition	Measurement		Adjustment		Specifications/ Remark
		Test equipment	Terminal	Parts	Method	
K type						
1. BPF Adjustment	(PANEL TEST MODE) CH-Sig 1-1 Tra-G setting -40dBm	Tracking generator Spectrum analyzer	ANT BPF	TC301, TC302, TC303	Adjust wave form to figure 1.	
		<p style="text-align: center;">Fig. 1</p>				
2. Sensitivity Check	[Panel Test Mode] 1) CH-Sig:1-1 SSG OUT Wide:-118dBm (0.28μV) (MOD:1kHz / ±3kHz) Narrow:-116dBm (0.35μV) (MOD:1kHz / ±1.5kHz)	SSG AF VTVM Oscilloscope	ANT		Check	12dB SINAD or more
3. Squelch (Open) Adjust [Wide]	1) Adj item [SQL3] Adjust [***] SSG OUT: -124dBm				Encoder knob squelch.	Adjust to the squelch threshold point
[Narrow]	2) Adj item [SQL3.] Adjust [***] SSG OUT: -123dBm					
4. Squelch(Tight) Adjust [Wide] [Narrow]	1) Adj item [SQL9] Adjust [***] SSG OUT:-117dBm (0.3μV) 2) Adj item [SQL9.] SSG OUT:-116dBm (0.35μV)					Adjust to the squelch threshold point
5. Squelch Check	[Panel Test Mode] 1) CH-Sig:1-1 SQ Level : [SQL5] SSG OUT: -118dBm (0.28μV) 2) SSG OUT:OFF				Check	Squelch must be opened. Squelch must be closed.

ADJUSTMENT

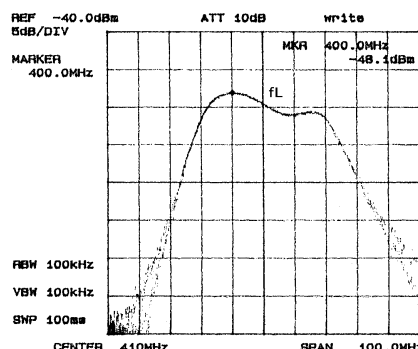
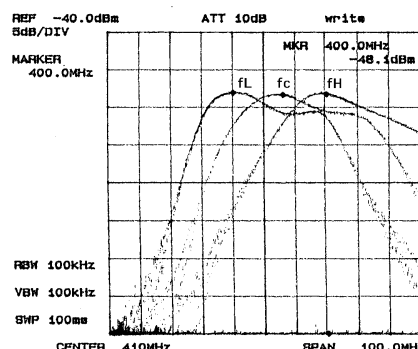
Item	Condition	Measurement		Adjustment		Specifications/ Remark
		Test equipment	Terminal	Parts	Method	
K4 type						
1. Sensitivity Adjustment	Adj item [SENS] DVM Adjust [***] f _L f _c f _H [S.E.N.S] → [S.E.N.S] → [S.E.N.S. .]			Encoder knob	f _L : ([S.E.N.S]) : [55] f _c : (S.E.N.S) : [125] f _H : (S.E.N.S. .) : [190]	
2. BPF	(PANEL TEST MODE) CH-Sig 2-1 Tra-G setting -40dBm	Tracking generator	ANT	TC301, TC302, TC303	Adjust wave form to figure 1.(f _L)	
	CH-Sig 1-1		BPF		Check wave form to figure 2.(f _c)	
	CH-Sig 3-1				Check wave form to figure 2.(f _H)	
						
		Fig. 1		Fig. 2		
3. Sensitivity Check	[Panel Test Mode] 1) CH-Sig:1-1 SSG OUT Wide:-118dBm (0.28μV) (MOD:1kHz / ±3kHz) Narrow:-116dBm (0.35μV) (MOD:1kHz / ±1.5kHz)	SSG AF VTVM Oscilloscope	ANT		Check	12dB SINAD or more
4. Squelch (Open) Adjust	[Wide] 1) Adj item [SQL3] Adjust [***] SSG OUT Wide:-123dBm				Encoder knob squelch.	Adjust to the squelch threshold point
	[Narrow] 2) Adj item [SQL3.] Adjust [***] SSG OUT Narrow:-126dBm					
5. Squelch(Tight) Adjust	[Narrow] 1) Adj item [SQL9] Adjust [***] 2) Adj item [SQL9.] SSG OUT:-115dBm (0.4μV)					Adjust to the squelch threshold point
6. Squelch Check	[Panel Test Mode] 1) CH-Sig:1-1 SQ Level : [SQL5] SSG OUT: -118dBm (0.28μV) 2) SSG OUT:OFF				Check	Squelch must be opened. Squelch must be closed.

ADJUSTMENT

Item	Condition	Measurement		Adjustment		Specifications/ Remark
		Test equipment	Terminal	Parts	Method	
K2 type						
1. BPF Adjustment	(PANEL TEST MODE) CH-Sig 1-1 Tra-G setting -40dBm	Tracking generator Spectrum analyzer	ANT BPF	TC301, TC302, TC303	Adjust wave form to figure 1.	
		<p style="text-align: center;">Fig. 1</p>				
2. Sensitivity Check	[Panel Test Mode] 1) CH-Sig:1-1 SSG OUT Wide:-118dBm (0.28μV) (MOD:1kHz / ±3kHz) Narrow:-116dBm (0.35μV) (MOD:1kHz / ±1.5kHz)	SSG AF VTVM Oscilloscope	ANT		Check	12dB SINAD or more
3. Squelch (Open) Adjust [Wide]	1) Adj item [SQL3] Adjust [***] SSG OUT: -124dBm				Encoder knob squelch.	Adjust to the squelch threshold point
[Narrow]	2) Adj item [SQL3.] Adjust [***] SSG OUT: -123dBm					
4. Squelch(Tight) Adjust [Wide] [Narrow]	1) Adj item [SQL9] Adjust [***] SSG OUT:-116dBm (0.35μV) 2) Adj item [SQL9.] SSG OUT:-115dBm (0.4μV)					Adjust to the squelch threshold point
5. Squelch Check	[Panel Test Mode] 1) CH-Sig:1-1 SQ Level : [SQL5] SSG OUT: -118dBm (0.28μV) 2) SSG OUT:OFF				Check	Squelch must be opened. Squelch must be closed.

ADJUSTMENT

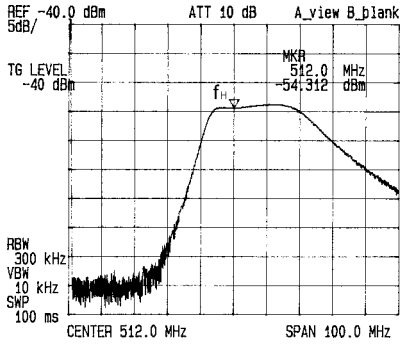
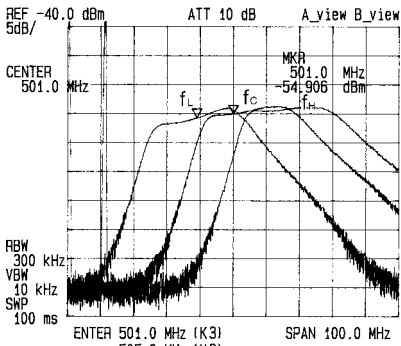
Item	Condition	Measurement		Adjustment		Specifications/ Remark
		Test equipment	Terminal	Parts	Method	
K3 type						
1. Sensitivity Adjustment	Adj item [SENS] DVM Adjust [***] f _L f _c [S.E.N.S] → [S.E.N.S] → [S.E.N.S. .]		f _H	Encoder knob	f _L : ([S.E.N.S]) : [53] f _c : (S.E.N.S) : [130] f _H : (S.E.N.S. .) : [208]	
2. BPF	(PANEL TEST MODE) CH-Sig 3-1 Tra-G setting -40dBm	Tracking generator spectrum analyzer	ANT BPF	TC301, TC302, TC303	Adjust wave form to figure 1.(f _H)	
 <p style="text-align: center;">Fig. 1</p>						
3. Sensitivity Adjustment	Adj item [SENS] Adjust [***] f _L [S.E.N.S] Tra-G setting -40dBm Adj item [SENS] Adjust [***] f _c [S.E.N.S] Tra-G setting -40dBm	Tracking generator spectrum analyzer	ANT BPF	Encoder knob	Adjust wave form to figure 2.(f _L)	
 <p style="text-align: center;">Fig. 2</p>						
4. Sensitivity Check	[Panel Test Mode] 1) CH-Sig:1-1 SSG OUT Semi wide:-116dBm (0.35μV) (MOD:1kHz / ±2.4kHz)	SSG AF VTVM Oscilloscope	ANT		Check	12dB SINAD or more
5. Squelch (Open) Adjust [Wide]	1) Adj item [SQL3] Adjust [***] SSG OUT Narrow:-124dBm				Encoder knob squelch.	Adjust to the squelch threshold point
[Narrow]	Adjust [***] SSG OUT Semi wide:-123dBm					

ADJUSTMENT

Item	Condition	Measurement		Adjustment		Specifications/ Remark
		Test equipment	Terminal	Parts	Method	
6. Squelch(Tight) Adjust [Wide]	1) Adj item [SQL9] Adjust [***] Wide:-117dBm (0.3μV) Narrow:-116dBm (0.35μV)					Adjust to the squelch
7. Squelch Check	[Panel Test Mode] 1) CH-Sig:1-1 SQ Level : [SQL5] SSG OUT: -118dBm (0.28μV) 2) SSG OUT:OFF				Check	Squelch must be opened. Squelch must be closed.

Adjustment points TX-RX unit (X57-588) Component side view

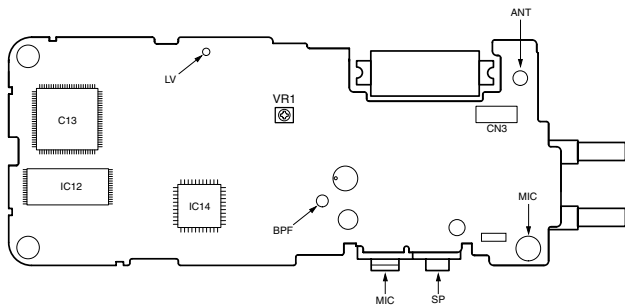

VR1 : Frequency adjustment

Foil Side View

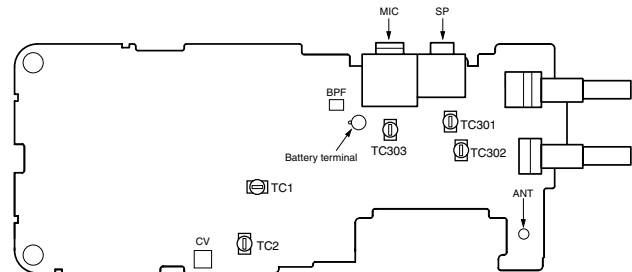

TC1 : Transmit lock voltage adjustment
 TC2 : Receive lock voltage adjustment
 TC301 : } Band-pass filter waveform adjustment
 TC302 : }
 TC303 : }
 BPF : Band-pass filter test point
 CV(LV) : Lock voltage adjustment terminal.

Fig. 2 Adjustment points

DISPLAY UNIT (X54-3250-10) Component Side View

DISPLAY UNIT (X54-3250-10) Foil Side View

DISPLAY UNIT (X54-3250-10)
Component Side View

Ref. NO.	Address
IC501	4E
Q501	4H
Q502	4G
D501	4D
D502	5F
D503	5F
D504	5F
D505	4D
D506	4H
D507	4G
D508	8G
D509	9G
D510	10G
D511	4C
D512	8D
D513	9D
D514	10D
D515	7G
D516	7D

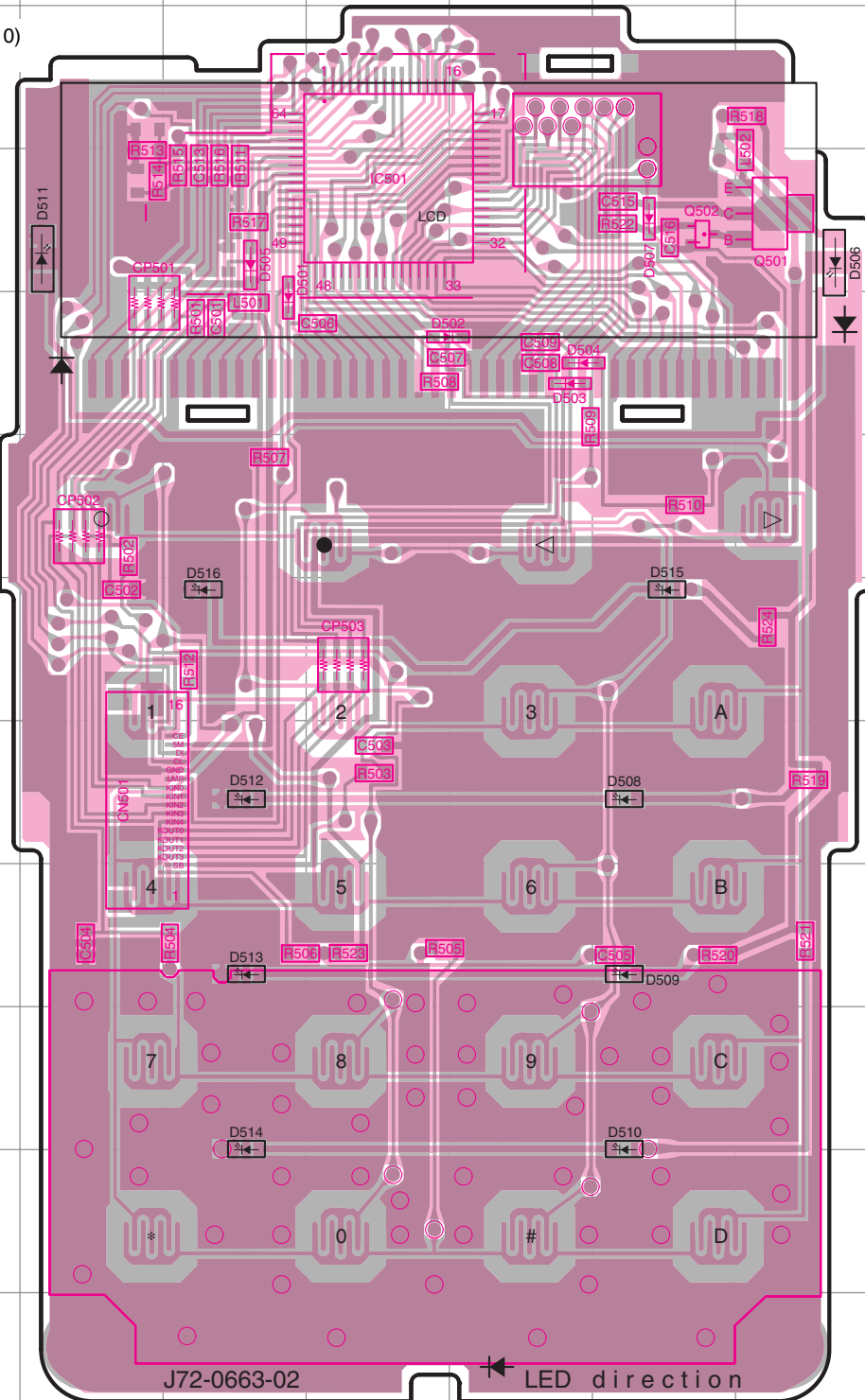

DISPLAY UNIT (X54-3250-10)
Foil Side View

Ref. NO.	Address
IC501	4N
Q501	4K
Q502	4L
D501	4O
D502	5M
D503	5M
D504	5M
D505	4O
D506	4K
D507	4L
D508	8L
D509	9L
D510	10L
D511	4P
D512	8O
D513	9O
D514	10O
D515	7L
D516	7O

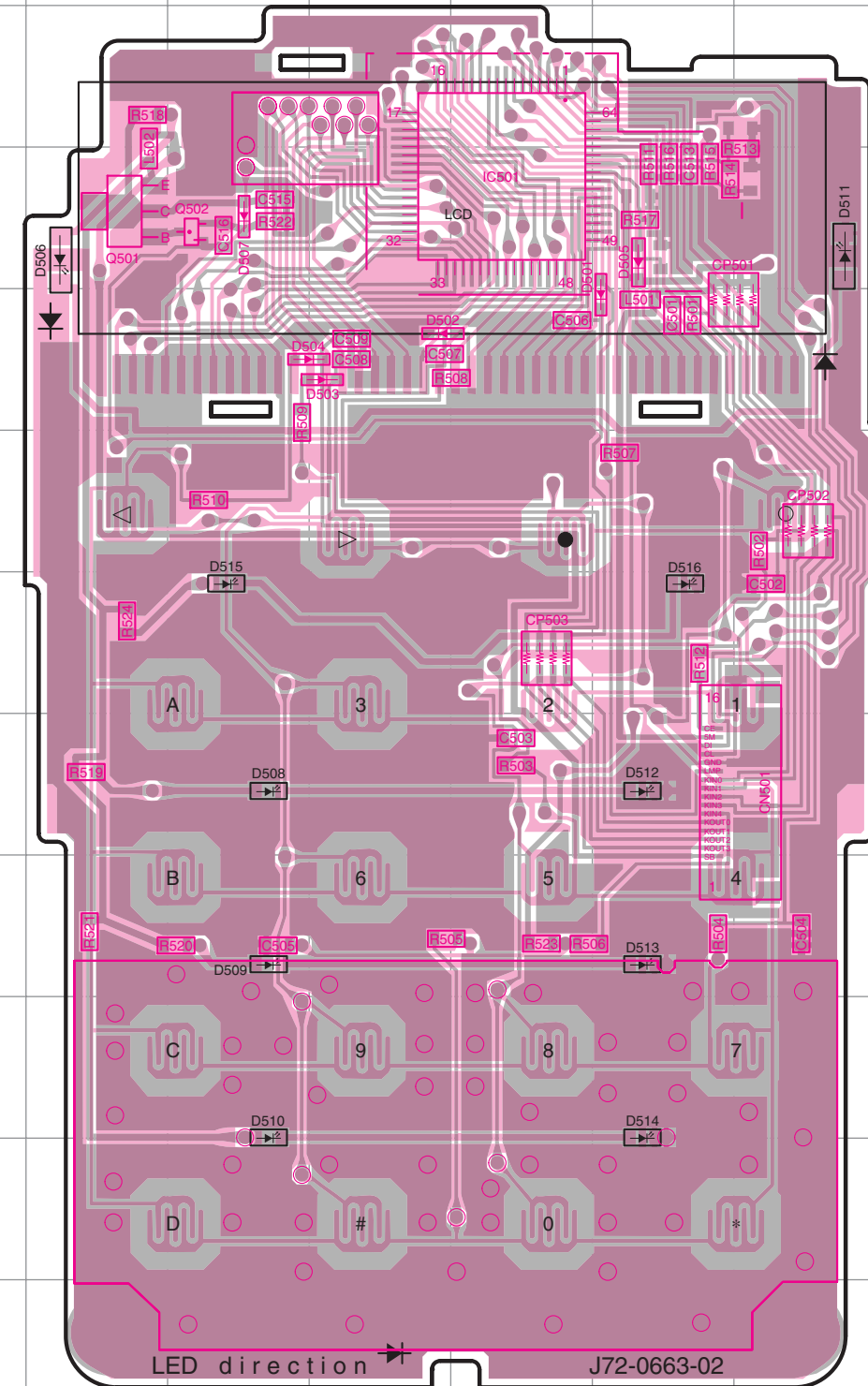

Component Side
Foil Side

Component Side
Foil Side

2SC4617(S)

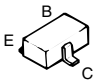

2SB1132(Q,R)

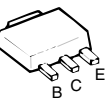

LC75823W

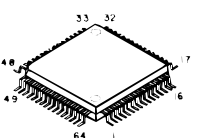

TK-372G

PC BOARD VIEW

TX-RX UNIT (X57-588X-XX) Component Side View
 0-11:TK-372G K, 0-16:TK-372G K2,
 0-17:TK-372G K3, 0-13:TK-372G K4

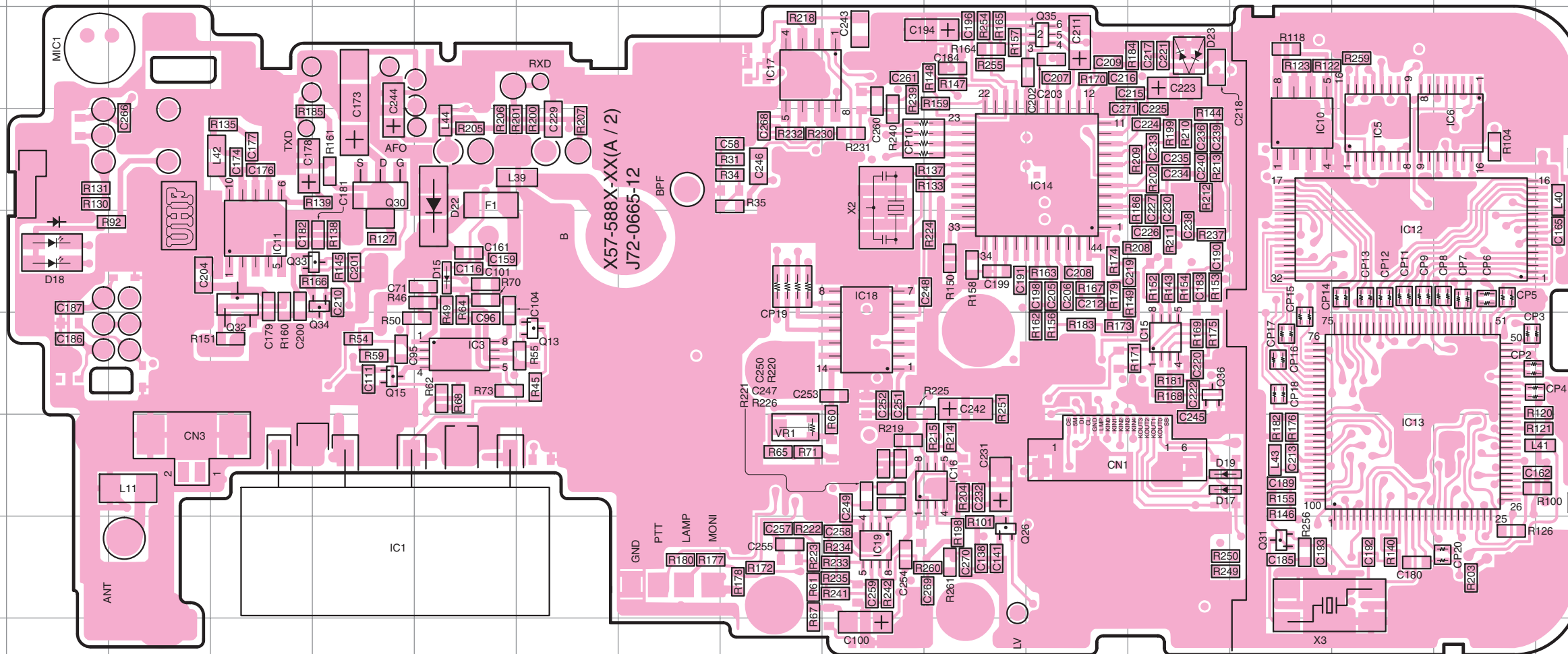

TX-RX UNIT (X57-588X-XX)
 Component Side View

Ref. NO.	Address
IC1	8E
IC3	6F
IC5	4O
IC6	4P
IC10	4N
IC11	5D
IC12	5O
IC13	7O
IC14	4L
IC15	6M
IC16	7K
IC17	3I
IC18	6J
IC19	8J
Q13	6G
Q15	6E
Q26	8K
Q30	4E
Q31	8N
Q32	5D
Q33	5D
Q34	5E
Q36	6M
D15	5F
D17	7M
D18	5B
D19	7M
D22	4F
D23	3M

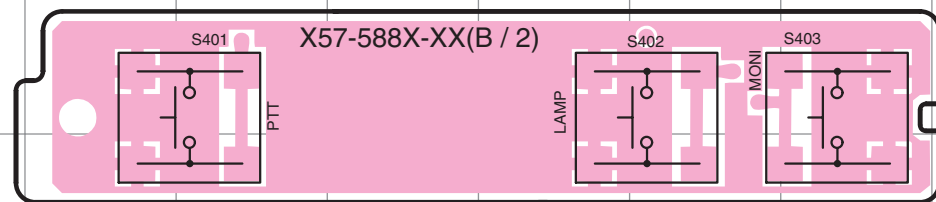

30622M4102GP

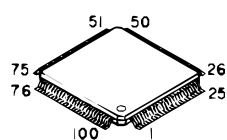

DTA114EE
 DTA144EE
 DTC114EE
 DTC144EE
 2SA1362(GR)
 2SC4617(S)
 2SC4619
 2SC4649(N,P)

2SK1588

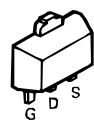

2SK1824

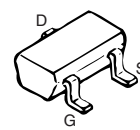

TA7368F

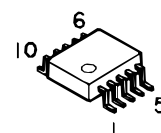

48

UPA572T



X9C103SI

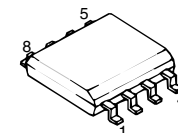

AT29C020-90T1

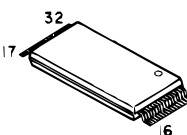

AT2408SN10SI2.5

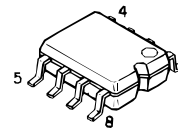

TC35453F

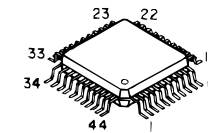

BU4094BCFV

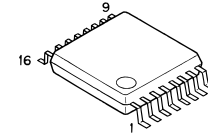

NJM2904V

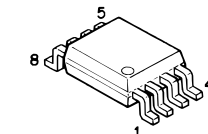

TA73W01FU
 TC75W51FU

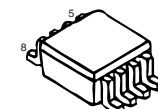

LC73872M

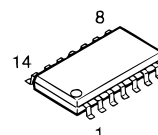

PF0314-03

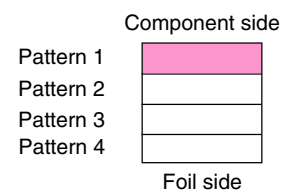
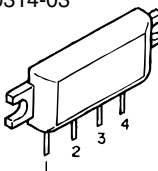

TX-RX UNIT (X57-588X-XX) Foil Side View
0-11:TK-372G K, 0-16:TK-372G K2,
0-17:TK-372G K3, 0-13:TK-372G K4

TX-RX UNIT (X57-588X-XX)
Foil Side View

Ref. NO.	Address
IC2	7H
IC4	4J
IC7	8D
IC8	5D
IC9	6D
Q1	7I
Q2	7K
Q3	7K
Q4	7L
Q5	7L
Q6	7L
Q7	6K
Q8	6J
Q9	7N
Q10	8J
Q11	6J
Q12	5I
Q14	5I
Q16	8G
Q17	5I
Q18	8F
Q19	5L
Q20	8F
Q21	8F
Q22	3J
Q23	3I
Q24	5Q
Q25	5R
Q27	8E
Q28	8E
Q301	5N
D1	7I
D2	7J
D3	7P
D4	7J
D5	6L
D6	6J
D7	6P
D8	7O
D9	7J
D10	6L
D11	8I
D12	6J
D13	4I
D14	4I
D21	7D
D302	6N
D305	5O
D306	5O
D307	5O

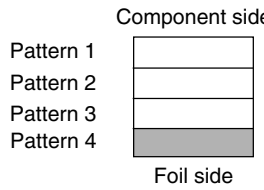
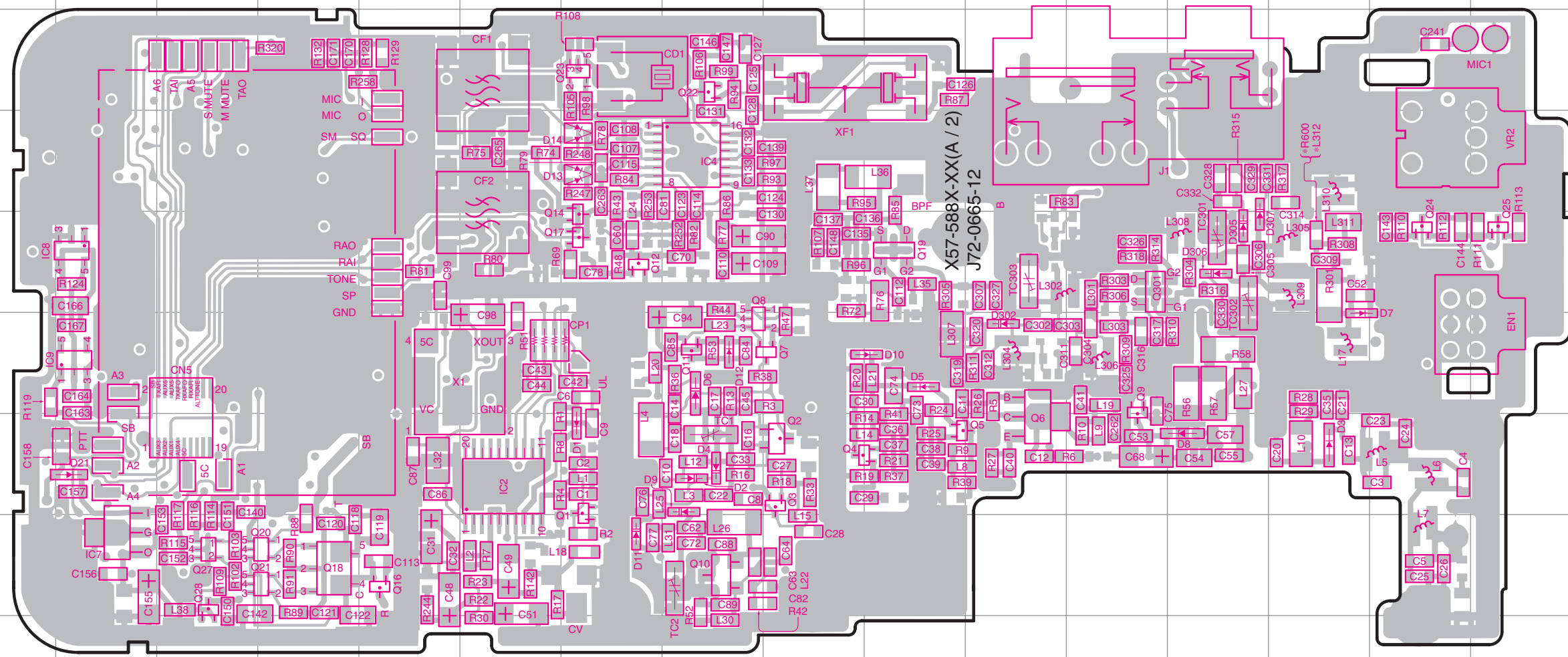

DTA114YE
2SC4226(R24)
2SC4617(S)
2SC5108(Y)
2SC4649(N,P)

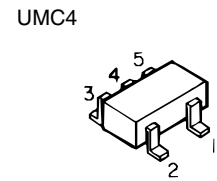
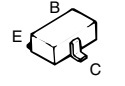

2SK1215(E)



2SK508NV(K52)



UPA572T

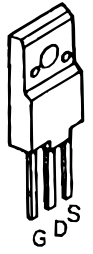

2SJ243

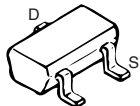

S-81350HG-KD



PST9140NR
RN5VL45C

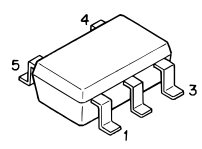

MB15A02

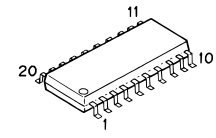

UPB1509GV

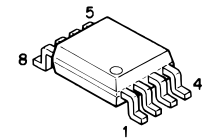

TA31136FN

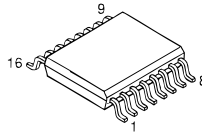

TK-372G

PC BOARD VIEW

TX-RX UNIT (X57-588X-XX) Component Side View + Foil Side View
 0-11:TK-372G K, 0-16:TK-372G K2,
 0-17:TK-372G K3, 0-13:TK-372G K4

FP210

PF0314-03

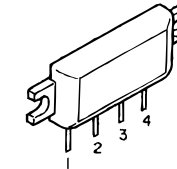
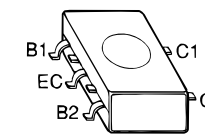

TX-RX UNIT (X57-588X-XX)
 Component Side + Foil Side View

Ref. NO.	Address	Ref. NO.	Address
IC1	8E	Q21	8N
IC2	7H	Q22	3J
IC3	6F	Q23	3L
IC4	4J	Q24	5C
IC5	4O	Q25	5B
IC6	4P	Q26	8K
IC7	8P	Q27	8O
IC8	5P	Q28	8O
IC9	6D	Q30	4E
IC10	4N	Q31	8N
IC11	5D	Q32	5D
IC12	5O	Q33	5D
IC13	7O	Q34	5E
IC14	4L	Q35	3L
IC15	6M	Q36	6M
IC16	7K	Q301	5N
IC17	3I	D1	7K
IC18	6J	D2	7J
IC19	8J	D3	7D
Q1	8K	D4	7J
Q2	7I	D5	6H
Q3	7I	D6	6J
Q4	7H	D7	6J
Q5	7H	D8	7E
Q6	7H	D9	8J
Q7	6I	D10	6H
Q8	6J	D11	8K
Q9	6F	D12	6J
Q10	8J	D13	4K
Q11	6J	D14	4I
Q12	5K	D15	5F
Q13	6G	D17	7M
Q14	5K	D18	5B
Q15	6E	D19	7M
Q16	8M	D21	7P
Q17	5K	D22	4F
Q18	8N	D23	3M
Q19	5H	D302	6G
Q20	8N	D305	5E
		D306	5E
		D307	5O

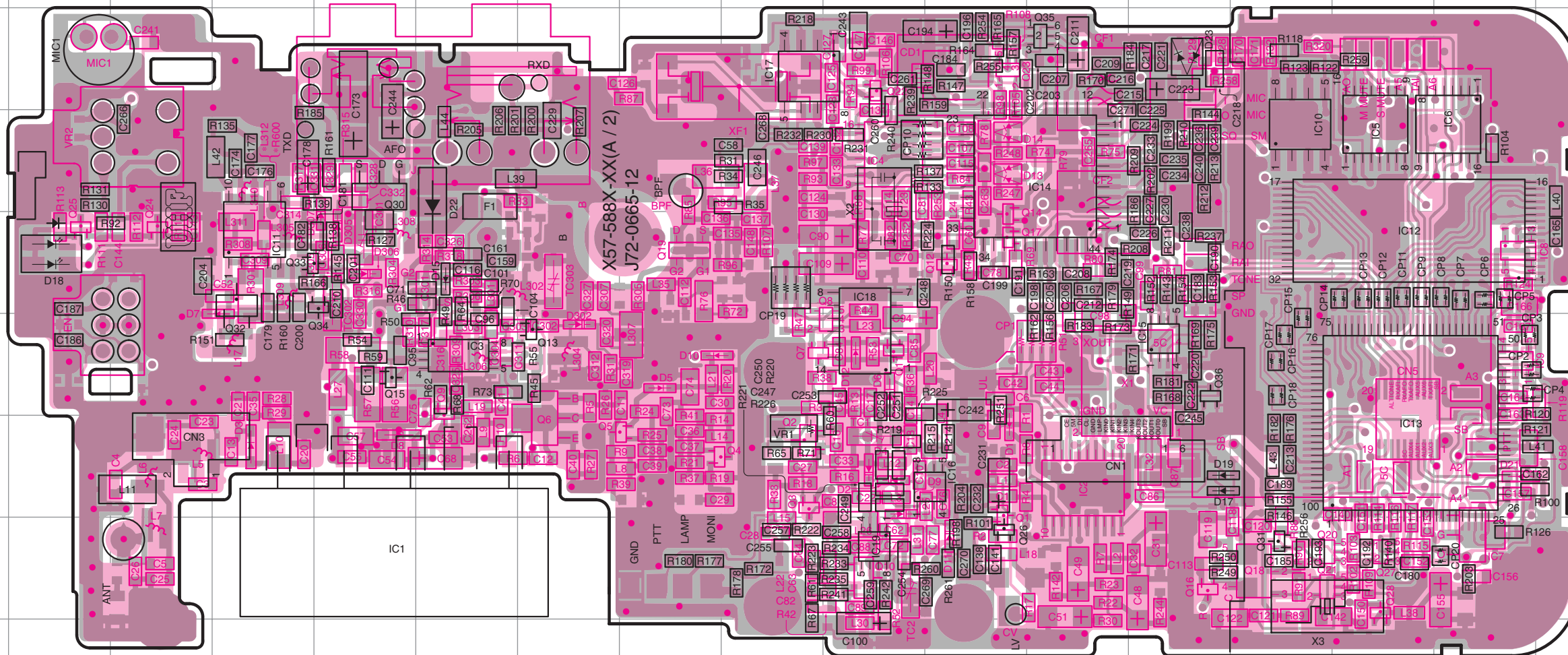

● Connect 1 and 4.
 Component side

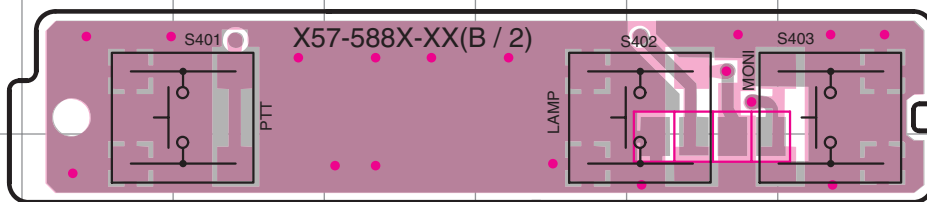
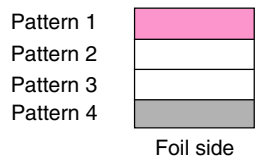

- DTA114EE
- DTA114YE
- DTA144EE
- DTC114EE
- DTC144EE
- 2SA1362(GR)
- 2SC4226(R24)
- 2SC4617(S)
- 2SC4619
- 2SC5108(Y)
- 2SC4649(N,P)

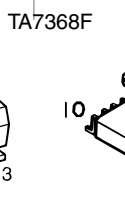
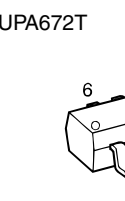
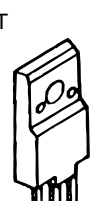
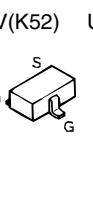
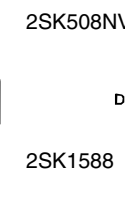
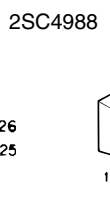
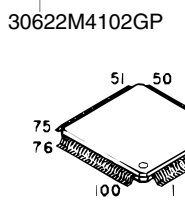

AT29C020-90TI

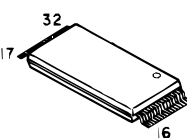

PST9140NR
 RN5VL45C

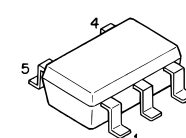

NJM2904V
 UPB1509GV

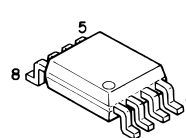

X9C103SI

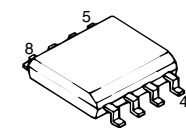

AT2408SN10SI2.5

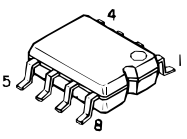

MB15A02

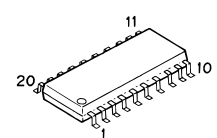

TA73W01FU
 TC75W51FU

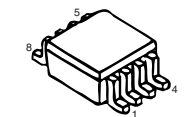

LC73872M

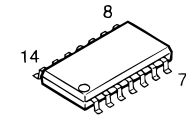

TC35453F

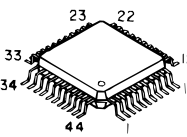

BU4094BCFV

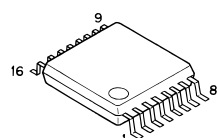

TA31136FN

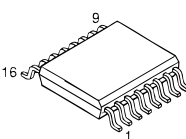

UMG3N

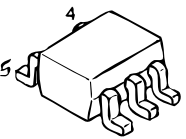

51

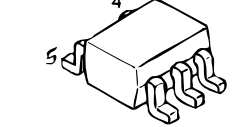
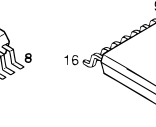
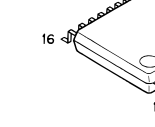
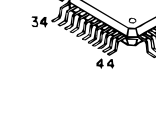
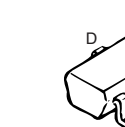
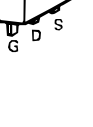
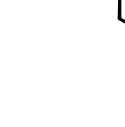
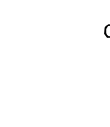
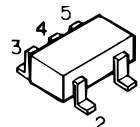
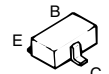

14

OPTIONS

KMC-17 (Speaker microphone)



KMC-17 Parts List

Ref. No.	New parts	Parts No.	Description	Re- marks
		A02-0907-08	Case (Front)	
		A02-0908-08	Case (Rear)	
		B09-0316-08	Cap	
		D10-0606-08	Lever (PTT)	
		E11-0421-05	Phone jack	
		E30-3138-08	Curl cord	
		F07-0889-08	Silicon rubber (PTT)	
		G53-0569-08	Packing (MIC case)	
		J29-0440-08	Clip assy	
		J39-0601-08	Packing (MIC)	
		N46-2605-60	Screw (Clip assy)	
		N46-3016-60	Screw (Case)	
		N80-2005-41	Screw (MIC unit)	
		S50-1415-05	Tact switch (PTT)	
		T07-0290-05	Loudspeaker (1W, 8Ω)	
		T91-0534-08	Condenser MIC	

KMC-21 (Speaker microphone)



KMC-21 Parts List

Ref. No.	New parts	Parts No.	Description	Re- marks
		A02-1979-08	Case (Front)	
		A02-0980-08	Case (Rear)	
		E11-0453-08	Phone jack	
		E30-3239-08	Curl cord	
		F07-1414-08	Cover	
		K29-5077-08	Lever (PTT)	
		S70-0444-08	Tact switch (PTT)	
		T07-0335-05	Loudspeaker	
		T91-0564-08	Condenser MIC	

TK-372G

SPECIFICATION

General

Frequency Range.....	450~470MHz (K) 470~490MHz (K2) 490~512MHz (K3) 403~430MHz (K4)
Number of channels	Max. 32
Channel Spacing	25kHz (Wide) 12.5kHz (Narrow)
PLL channel stepping	5kHz, 6.25kHz
Operating Voltage	7.5 VDC \pm 20%
Battery Life	More than 4 hours at 5 watts (5-5-90 duty cycle with KNB-14 battery) More than 8 hours at 4 watts (5-5-90 duty cycle with KNB-15A battery)
Operating Temperature range.....	-30°C to +60°C (-22 °F to +140 °F)
Dimensions and Weight	
With KNB-14 (7.2V 600mAh battery)	58 (2-5/16) W x 135 (5-5/16) H x 32 (1-1/4) D mm (in) 400g (0.88lbs)
With KNB-15A (7.2V 1100mAh battery)	58 (2-5/16) W x 135 (5-5/16) H x 35 (1-3/8) D mm (in) 440g (0.97lbs)

Receiver (Measurements made per EIA standard EIA-RS316B)

Sensitivity	
EIA 12dB SINAD	0.25 μ V (Wide)/0.28 μ V (Narrow)
Selectivity	70dB (Wide)/65dB (Narrow)
Intermodulation	65dB (Wide)/60dB (Narrow)
Spurious response	60dB
Audio Power Output	500mW
Frequency Stability.....	\pm 2.5ppm
Channel Frequency Spread	20MHz (K, K2) 22MHz (K3) 27MHz (K4)

Transmitter (Measurements made per EIA standard EIA 316B)

RF Power output	4W/1W
Spurious and Harmonics	70dB
Modulation.....	16K ϕ F3E (Wide)/11K ϕ F3E (Narrow)
FM Noise	45dB (Wide)/40dB (Narrow)
Audio Distortion	Less than 5%
Frequency Stability.....	\pm 2.5ppm
Channel Frequency Spread	20MHz (K, K2) 22MHz (K3) 27MHz (K4)

KENWOOD CORPORATION

14-6, Dogenzaka 1-chome, Shibuya-ku, Tokyo 150-8501, Japan

KENWOOD SERVICE CORPORATION

P.O. BOX 22745, 2201 East Dominguez Street, Long Beach, CA 90801-5745, U.S.A.

KENWOOD ELECTRONICS CANADA INC.

6070 Kestrel Road, Mississauga, Ontario, Canada L5T 1S8

KENWOOD ELECTRONICS DEUTSCHLAND GMBH

Rembrücker Str. 15, 63150 Heusenstamm, Germany

KENWOOD ELECTRONICS BELGIUM N.V.

Mechelsesteenweg 418 B-1930 Zaventem, Belgium

KENWOOD ELECTRONICS FRANCE S.A.

13, Boulevard Ney, 75018 Paris, France

KENWOOD ELECTRONICS U.K. LIMITED

KENWOOD House, Dwight Road, Watford, Herts., WD1 8EB United Kingdom

KENWOOD ELECTRONICS EUROPE B.V.

Amsterdamseweg 37, 1422 AC Uithoorn, The Netherlands

KENWOOD ELECTRONICS ITALIA S.p.A.

Via G. Sirtori, 7/9 20129 Milano, Italy

KENWOOD IBERICA S.A.

Bolivia, 239-08020 Barcelona, Spain

KENWOOD ELECTRONICS AUSTRALIA PTY. LTD.

(A.C.N. 001 499 074)

16 Giffnock Avenue, North Ryde, N.S.W. 2113, Australia

KENWOOD ELECTRONICS (HONG KONG) LTD.

Unit 3712-3724, Level 37, Tower one Metroplaza, 223 Hing Fong Road, Kwai Fong, N.T., Hong Kong

KENWOOD ELECTRONICS TECHNOLOGIES(S) PTE LTD.

Sales Marketing Division
1 Ang Mo Kio Street 63, Singapore 569110