

## **INTRODUCTION**

This easy-to-build professional grade function generator kit provides precision sine, square, and triangle waveforms from 1 Hz to 1 MHz in six decade ranges. Waveform amplitude is continuously adjustable from 0 to 12-Volts peak-to-peak. DC offset is adjustable from -6 to +6 VDC. Output impedance is 400 Ohms, with short-circuit output protection. Simple-to-follow step-by-step instructions guide you through assembly and alignment. Circuitry is constructed on a rugged professional-quality glass-epoxy PC board with a solder mask and silk-screened component-placement legend. Your kit uses only high-quality components throughout, and it comes complete with a sturdy molded cabinet and silk-screened aluminum front panel. AC power adapter included.

## **TOOLS AND SUPPLIES**

**Construction Area:** Kit construction requires a clean, smooth, and well-lighted area where you can easily organize and handle small parts without losing them. An inexpensive sheet of white poster board makes an excellent construction surface, while providing protection for the underlying table or desk. Diffused overhead lighting is a plus, and a supplemental high-intensity desk lamp is especially helpful for close-up work. Safety is always important! Use a suitable high-temperature stand for your soldering iron, and keep the work area free of clutter.

**Universal Kit-building Tools:** No special tools are required to complete this kit beyond common items normally used for bench construction. We recommend the following:

- Soldering Iron (grounded-tip and temperature-controlled preferred)
- High-temperature Iron Holder with Cleaning Sponge
- Solder, 60/40 or 37/63 with rosin or "no-clean" flux (.031" dia. is good size)
- Needle Nose Pliers or Surgical Hemostats
- Diagonal Cutters or "Nippy Cutters"
- Solder Sucker (squeeze or vacuum pump type), or Desoldering Braid
- Bright Desk Lamp
- Magnifying Glass

## **BEFORE YOU START BUILDING**

Experience shows there are *four common mistakes* builders make. Avoid these, and your kit will probably work on the first try! Here's what they are:

- 1. Installing the Wrong Part:** It always pays to double-check each step. A 1K and a 10K resistor may look *almost* the same, but they may act very differently in an electronic circuit! Same for capacitors--a device marked 102 (or .001 uF) may have very different operating characteristics from one marked 103 (or .01uF).
- 2. Installing Parts Backwards:** Always check the polarity of electrolytic capacitors to make sure the positive (+) lead goes in the (+) hole on the circuit board. Transistors have a flat side or emitter tab, and ICs have a notch or dot at one end indicating the correct direction of insertion. Diodes are polarized with a band to indicate the cathode end. LED polarity is coded by lead length. Always double-check--especially before applying power to the circuit!
- 3. Faulty Solder Connections:** Inspect for cold-solder joints and solder bridges. Cold solder joints happen when you don't fully heat the connection--or when metallic corrosion and oxide contaminate a component lead or pad. Solder bridges form when a trail of excess solder shorts pads or tracks together (see Soldering Tips below).
- 4. Omitting or Misreading a Part:** This is easier to do than you might think! Always double-check to make sure you completed each step in an assembly sequence.

**Soldering Tips:** *Cleanliness* and *good heat distribution* are the two secrets of professional soldering. Before you install and solder each part, inspect leads or pins for oxidation. If the metal surface is dull, sand with fine emery paper until shiny. Allow the tip of your iron to contact both the lead and pad for about one second (count "one-thousand-one") before feeding solder to the connection. Surfaces must become hot enough for solder to *flow smoothly*. Feed solder to the opposite side of the lead from your iron tip--solder will wick around the lead toward the tip, wetting all exposed surfaces. Apply solder sparingly, and do not touch solder directly to the hot iron tip to promote rapid melting. Keep a damp sponge handy to wipe your soldering tip on. This removes excess solder, and keeps the tip properly tinned. If the iron is going to sit idling for long periods, wipe the tip, add some fresh solder, and unplug the iron.

**Desoldering Tips:** If you make a mistake and need to remove a part, follow these instructions carefully! First, grasp the component with hemostats or needle-nose pliers. Heat the pad beneath the lead you intend to extract, and pull gently. The lead should come out. Repeat for the other lead. Solder may fill in

behind the lead as you extract it--especially if you are working on a double-sided board with plate-through holes. Should this happen, try heating the pad again and inserting a common pin into the hole. Solder won't stick to the pin's chromium plating. When the pad cools, remove the pin and insert the correct component. For ICs or multiple-pin parts, use desoldering braid to remove excess solder before attempting to extract the part. Alternatively, a low-cost vacuum-bulb or spring-loaded solder sucker may be used. Parts damaged or severely overheated during extraction should be replaced rather than reinstalled.

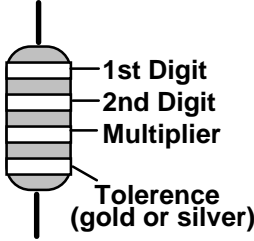

**Work Habits:** Kit construction requires the ability to follow detailed instructions and, in many cases, to perform new and unfamiliar tasks. To avoid making needless mistakes, work for short periods when you're fresh and alert. Recreational construction projects are more informative and more fun when you take your time. Enjoy!

**Sorting and Reading Resistors:** The electrical value of resistors is indicated by a color code (shown below). You don't have to memorize this code to work with resistors, but you do need to understand how it works:

Resistor Color Code			
	<b>Black</b> = 0 (tens)	<b>Blue</b> = 6	
	<b>Brown</b> = 1 (hundreds)	<b>Violet</b> = 7	
	<b>Red</b> = 2 (K)	<b>Gray</b> = 8	
	<b>Orange</b> = 3 (10K)	<b>White</b> = 9	
	<b>Yellow</b> = 4 (100K)	<b>Silver</b> = 10%	
	<b>Green</b> = 5 (1Meg)	<b>Gold</b> = 5%	

When you look at a resistor, check its multiplier code first. Any resistor with a black multiplier band falls between 10 and 99 ohms in value. Brown designates a value between 100 and 999 ohms. Red indicates a value from 1000 to 9999 ohms, which is also expressed as 1.0K to 9.9K. An orange multiplier band designates 10K to 99K, etc. To inventory resistors, first separate them into groups by multiplier band (make a pile of 10s, 100s, Ks, 10Ks, etc.). Next, sort each group by specific value (1K, 2.2K, 4.7K, etc). This procedure makes the inventory easier, and also makes locating specific parts more convenient later on during construction. Some builders find it especially helpful to arrange resistors in ascending order along a strip of double-sided tape.

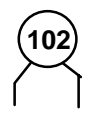
**Reading Capacitors:** Unlike resistors, capacitors no longer use a color code for value identification. Instead, the value, or a 3-number code, is printed on the body.

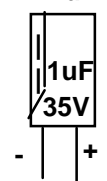
Value	Code			
10 pF	= 100	<b>Multilayer</b> (270 pF) 	<b>Ceramic Discs</b> (.001 uF)      (.1 uF)	
100 pF	= 101			
1000 pF	= 102			
.001 uF	= 102*			
.01 uF	= 103			
.1 uF	= 104			
			<b>Electrolytic</b> 1 uF 	

As with resistors, it's helpful to sort capacitors by type, and then to arrange them in ascending order of value. Small-value capacitors are characterized in pF (or pico-Farads), while larger values are labeled in uF (or micro-Farads). The transition from pF to uF occurs at 1000 pF (or .001 uF)\*. Today, *most* monolithic and disc-ceramic capacitors are marked with a three-number code. The first two digits indicate a numerical value, while the last digit indicates a multiplier (same as resistors).

Electrolytic capacitors are always marked in uF. Electrolytics are polarized devices and must be oriented correctly during installation. If you become confused by markings on the case, remember the uncut negative lead is slightly shorter than the positive lead.

**Diodes:** Diodes are also polarized devices that must be installed correctly. Always look for the banded--or cathode--end when installing, and follow instructions carefully.

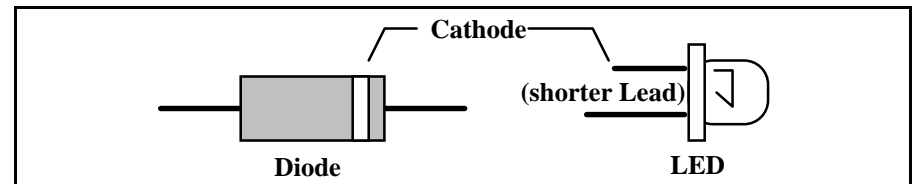

**Transistors:** If transistors are installed incorrectly, damage may result when power is applied. Transistors in metal cases have a small tab near the emitter lead to identify correct positioning. Semiconductors housed in small plastic cases (TO-92) have an easily-identified flat side to identify mounting orientation. Many specialized diodes and low-current voltage regulators also use this type packaging. Larger plastic transistors and voltage regulators use a case backed with a prominent metal tab to dissipate heat (T-220). Here, orientation is indicated by the positioning of the cooling tab.

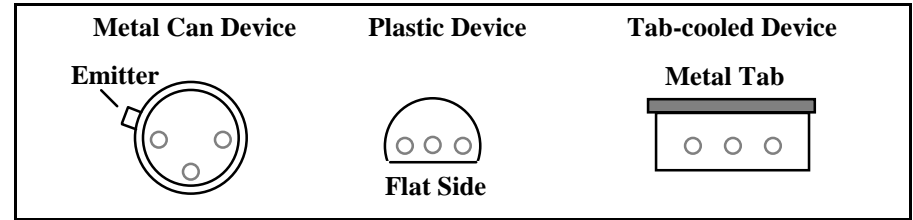

**Integrated Circuits:** Proper IC positioning is indicated by a dot or square marking located on one end of the device. A corresponding mark will be silk-screened on the PC board and printed on the kit's parts-placement diagram. To identify specific IC pin numbers for testing purposes, see the following diagram. Pin numbers always start at the keyed end of the case and progress counter-clockwise around the device, as shown:

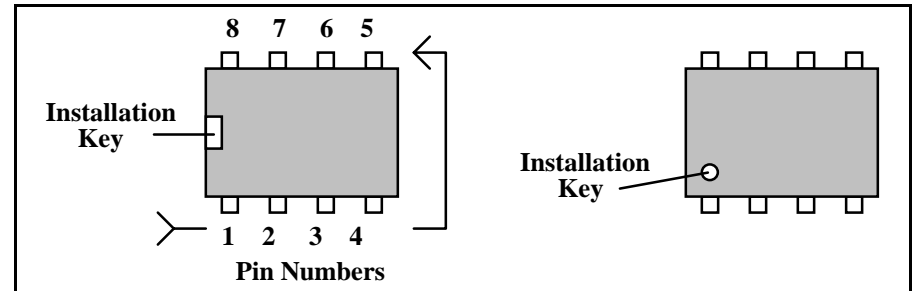

**PARTS LIST**

Your kit should contain all of the parts listed below. Please identify and inventory each item on the checklist before you start building. If any parts are missing or damaged, refer to the manual's warranty section for replacement instructions. If you can't positively identify an unfamiliar item on the basis of the information given, set it aside until all other items are checked off. You may then be able to identify it by process of elimination. Finally, your kit will go together more smoothly if parts are organized by type and arranged by value ahead of time. Use this inventory as an opportunity to sort and arrange parts so you can identify and find them quickly.

<input checked="" type="checkbox"/>	Qty	Part Description	Designation	VEC P/N
<input type="checkbox"/>	1	51 ohm resistor (green-brown-black)	R16	100-1510
<input type="checkbox"/>	2	100 ohm resistor (brown-black-brown)	R25,R26	100-2100
<input type="checkbox"/>	1	680 ohm resistor (blue-gray-brown)	R15	100-2680
<input type="checkbox"/>	1	1K resistor (brown- black-red)	R19	100-3100
<input type="checkbox"/>	8	1.6K resistor (brown- blue-red)	R28-R35	100-3160
<input type="checkbox"/>	1	2K resistor (red- black-red)	R17	100-3200
<input type="checkbox"/>	2	3K resistor (orange- black-red)	R13,R21	100-330
<input type="checkbox"/>	4	12K resistor (brown- red-orange)	R11,R12,R14,R 20	100-4120
<input type="checkbox"/>	2	22K resistor (red-red- orange)	R24,R27	100-4220
<input type="checkbox"/>	1	24K resistor (red- yellow-orange)	R18	100-4240
<input type="checkbox"/>	2	27K resistor (red- violet-orange)	R22,R23	100-4270
<input type="checkbox"/>	1	1K trimpot (102)	R10	133-3100
<input type="checkbox"/>	6	5K trimpot (502)	R4-R9	133-3500
<input type="checkbox"/>	3	10K 24-mm potentiometer (103)	R1,R2,R3	162-4100- 1

<input type="checkbox"/>	1	680 pF disc ceramic capacitor (681)	C20	200-0680-1
<input type="checkbox"/>	2	.001 $\mu$ F disc ceramic capacitor (102)	C22,C23	200-1100
<input type="checkbox"/>	13	.1 $\mu$ F disc ceramic capacitor (104)	C3,C4,C5,C6,C9,C10,C13,C14,C25,C26,C27,C28,C29	200-3100
<input type="checkbox"/>	1	.0068 $\mu$ F polyester ceramic capacitor	C19	230-1680
<input type="checkbox"/>	1	.082 $\mu$ F polyester ceramic capacitor	C18	230-2820
<input type="checkbox"/>	2	1 $\mu$ F tantalum capacitor	C21,C24	272-4100-1
<input type="checkbox"/>	1	1 $\mu$ F electrolytic capacitor	C17	270-4100-2
<input checked="" type="checkbox"/>	<b>Qty</b>	<b>Part Description</b>	<b>Designation</b>	<b>VEC P/N</b>
<input type="checkbox"/>	1	10 $\mu$ F electrolytic capacitor	C16	270-5100-1
<input type="checkbox"/>	5	100 $\mu$ F electrolytic capacitor	C7,C8,C11,C12,C15	270-6100-1
<input type="checkbox"/>	2	2200 $\mu$ F electrolytic capacitor	C1,C2	270-7220-1
<input type="checkbox"/>	2	1N4148 switching diode	D3,D4	300-4148
<input type="checkbox"/>	2	1N4007 rectifier diode	D1,D2	300-4007
<input type="checkbox"/>	1	2N3904 npn transistor	Q1	305-3904
<input type="checkbox"/>	1	2N3906 pnp transistor	Q2	305-3906
<input type="checkbox"/>	1	78L05 voltage regulator IC	U6	307-7805L
<input type="checkbox"/>	1	78L12 voltage regulator IC	U4	307-7812L
<input type="checkbox"/>	1	79L05 voltage regulator IC	U7	307-7905L
<input type="checkbox"/>	1	79L12 voltage regulator IC	U5	307-79L12
<input type="checkbox"/>	1	LM318 op-amp	U2	324-0318

<input type="checkbox"/>	1	LM358 dual op-amp	U3	324-0358
<input type="checkbox"/>	1	MAX038CPP function generator IC	U1	325-0038
<input type="checkbox"/>	1	Six-position rotary switch	SW2	500-1008
<input type="checkbox"/>	1	2P2T slide switch	SW1	501-1003
<input type="checkbox"/>	1	4P4T slide switch	SW3	501-1043
<input type="checkbox"/>	1	2.1-mm coaxial power jack	J1	601-6121
<input type="checkbox"/>	1	Binding post, red	J2	606-0003
<input type="checkbox"/>	1	Binding post, black	J3	606-0004
<input type="checkbox"/>	2	IC socket, 8 pin		625-0008
<input type="checkbox"/>	1	IC socket, 20 pin		625-0020
<input type="checkbox"/>	1	Switch-style knob		760-0036
<input type="checkbox"/>	3	Control knob		760-0033
<input type="checkbox"/>	6	6" hook-up wire, black		871-2422-0600
<input type="checkbox"/>	6	6" hook-up wire, red		871-2422-0600
<input type="checkbox"/>	5	6" hook-up wire, yellow		871-2444-0600
<input type="checkbox"/>	1	PC board, single-sided		861-VEC4001
<input type="checkbox"/>	1	Instruction manual		925-VEC4001K
<input type="checkbox"/>	1	Case, plastic		840-0524
<input type="checkbox"/>	1	Faceplate, VEC-4001		804-VEC4001
<input type="checkbox"/>	2	Screw, 2-56 x 3/8"		652-0375
<input checked="" type="checkbox"/>	<b>Qty</b>	<b>Part Description</b>	<b>Designation</b>	<b>VEC P/N</b>
<input type="checkbox"/>	2	Nut, 2-56		705-0256
<input type="checkbox"/>	4	Screw, 4-40 x 1/4"		654-0250B
<input type="checkbox"/>	4	Nut, 4-40		705-0440
<input type="checkbox"/>	12	Screw, black, 6-32 x 1/4"		656-0250B



<input checked="" type="checkbox"/>	Qty	Part Description	Designation	VEC P/N
<input type="checkbox"/>	2	Nut, 2-56		705-0256
<input type="checkbox"/>	4	Screw, 4-40 x 1/4"		654-0250B
<input type="checkbox"/>	4	Nut, 4-40		705-0440
<input type="checkbox"/>	12	Screw, black, 6-32 x 1/4"		656-0250B
<input type="checkbox"/>	4	Spacer, aluminum, 6-32 x 1-1/4"		716C-1250
<input type="checkbox"/>	4	Rubber feet		770-1162
<input type="checkbox"/>	1	AC Adapter, 12 VAC		407-1072

## PARTS PLACEMENT DIAGRAM

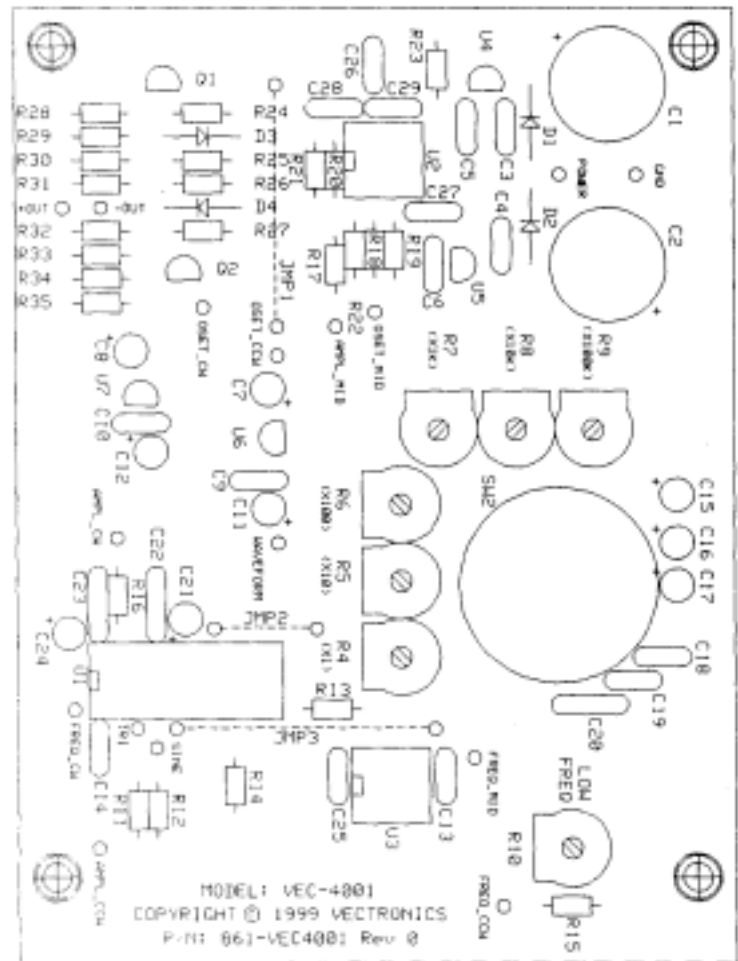

## **STEP-BY-STEP CONSTRUCTION**

In these instructions, when you see the term *install*, this means to locate, identify, and insert the part into its mounting holes on the PC board. This includes pre-bending or straightening leads as needed so force is not required to seat the part. Once a component is mounted, bend each lead over to hold it in place. Use sharp side-cutters to clip off excess lead length before soldering. Make sure trimmed leads don't touch other pads and tracks, or a short circuit may result:

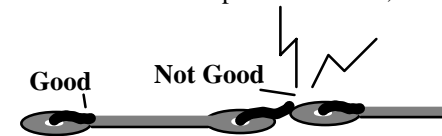

The term *solder* means to solder the part's leads in place, and to inspect both (or all) solder connections for flaws or solder bridges. Nip off excess protruding leads with a sharp pair of side cutters.

This kit has 25 fixed-value resistors. Mount these now, starting with the smallest value and moving to the largest. Before mounting each one, carefully bend both leads close to the resistor body to form right-angles, as shown below:

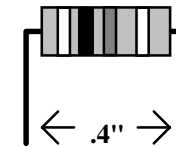

- 1. Find a 51 Ohm resistor (green-brown-black). Install at R16 and solder.

Locate two (2) 100 Ohm resistors (brown-black-brown).

- 2. Install a 100 Ohms at R25 and solder.
- 3. Install a 100 Ohms at R26 and solder.
- 4. Find a 680 Ohm resistor (blue-gray-brown). Install at R15 and solder.

- 5. Find a 1K resistor (brown-black-red). Install at R19 and solder.

Locate eight (8) 1.6K resistors (brown-blue-red).

- 6. Install a 1.6K at R28 and solder.
- 7. Install a 1.6K at R29 and solder.
- 8. Install a 1.6K at R30 and solder.

- 9. Install a 1.6K at R31 and solder.
- 10. Install a 1.6K at R32 and solder.
- 11. Install a 1.6K at R33 and solder.
- 12. Install a 1.6K at R34 and solder.
- 13. Install a 1.6K at R35 and solder.
- 14. Find a 2K resistor (red-black-red). Install at R17 and solder.

Locate two (2) 3K resistors (orange-black-red).

- 15. Install a 3K at R13 and solder.
- 16. Install a 3K at R21 and solder.

Locate four (4) 12K resistors (brown-red-orange).

- 17. Install a 12K at R11 and solder.
- 18. Install a 12K at R12 and solder.
- 19. Install a 12K at R14 and solder.
- 20. Install a 12K at R20 and solder.

Locate two (2) 22K resistors (red-red-orange).

- 21. Install a 22K at R24 and solder.
- 22. Install a 22K at R27 and solder.
- 23. Find a 24K resistor (red-yellow-orange). Install at R18 and solder.

Locate two (2) 27K resistors (red-violet-orange).

- 24. Install a 27K at R22 and solder.
- 25. Install a 27K at R23 and solder.

This completes installation of the 25 fixed-value resistors (trim pots and potentiometers will be installed later). Take a moment to confirm each fixed-value resistor is positioned in the right location on the PC board.

Next, we'll install the kit's diodes. . ***Diodes are polarized and must be oriented correctly in order to work.*** The banded end of the diode should align with the single-lined end of the diode symbol on the PC board (see following diagram).

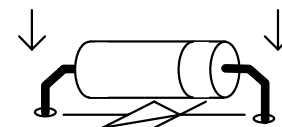

Locate two (2) 1N4007 diodes.

- 26. Install a 1N4007 at D1 and solder.
- 27. Install a 1N4007 at D2 and solder.

Locate two (2) 1N4148 diodes.

- 28. Install a 1N4148 at D3 and solder.
- 29. Install a 1N4148 at D4 and solder.

Next, we'll install the kit's capacitors--starting with the disc-ceramic types.

- 30. Find a 680 pF disc ceramic capacitor (681). Install at C20 and solder.

Locate two (2) .001  $\mu$ F disc ceramic capacitors (102).

- 31. Install a .001  $\mu$ F at C22 and solder.
- 32. Install a .001  $\mu$ F at C23 and solder.

Locate thirteen (13) .1  $\mu$ F disc ceramic capacitors.

- 33. Install a .1  $\mu$ F at C3 and solder.
- 34. Install a .1  $\mu$ F at C4 and solder.
- 35. Install a .1  $\mu$ F at C5 and solder.
- 36. Install a .1  $\mu$ F at C6 and solder.
- 37. Install a .1  $\mu$ F at C9 and solder.
- 38. Install a .1  $\mu$ F at C10 and solder.
- 39. Install a .1  $\mu$ F at C13 and solder.
- 40. Install a .1  $\mu$ F at C14 and solder.
- 41. Install a .1  $\mu$ F at C25 and solder.
- 42. Install a .1  $\mu$ F at C26 and solder.
- 43. Install a .1  $\mu$ F at C27 and solder.
- 44. Install a .1  $\mu$ F at C28 and solder.
- 45. Install a .1  $\mu$ F at C29 and solder.
- 46. Find the .0068  $\mu$ F polyester ceramic capacitor (green, marked 682). Install at C19 and solder.

47. Find the .082  $\mu\text{F}$  polyester ceramic capacitor (green, marked .082). Install at C18 and solder.

The last group of capacitors in your kit are electrolytic. ***Electrolytic caps are polarized and must be installed the correct way in order to work.*** Each capacitor's plus (+) mounting hole is marked on both the circuit board and parts placement diagram. If the markings on the capacitor body are unclear, the plus (+) lead is always the longer of the two. Most polarized caps you'll install are aluminum-encased electrolytics. However, your kit also contains two specialized 1  $\mu\text{F}$  electrolytics called *tantalum capacitors*. These are small bulbous parts with a tan-colored dipped-epoxy coating. Do not confuse these with the 1  $\mu\text{F}$  aluminum type electrolytic also supplied in the kit.

**Tantalum Electrolytic      Aluminum Electrolytic**

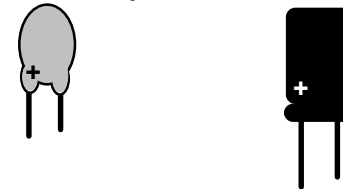

Find the two (2) 1  $\mu\text{F}$  tantalum caps (marked 1  $\mu\text{D}$ ). Identify the longer plus lead (marked +).

48. Observing polarity, install a 1  $\mu\text{F}$  tantalum cap at C21.  
  49. Observing polarity, install a 1  $\mu\text{F}$  tantalum cap at C24.

The remaining polarized caps are standard aluminum-case electrolytics.

50. Locate a 1  $\mu\text{F}$  electrolytic. Observing polarity, install at C17 and solder.  
  51. Locate a 10  $\mu\text{F}$  electrolytic. Observing polarity, install at C16 and solder.

Find five (5) 100  $\mu\text{F}$  electrolytics. Observing polarity, install as follows:

52. Install a 100  $\mu\text{F}$  at C7 and solder.  
  53. Install a 100  $\mu\text{F}$  at C8 and solder.  
  54. Install a 100  $\mu\text{F}$  at C11 and solder.  
  55. Install a 100  $\mu\text{F}$  at C12 and solder.  
  56. Install a 100  $\mu\text{F}$  at C15 and solder.

Find two (2) 2200  $\mu\text{F}$  electrolytics. Observing polarity:

- 57. Install a 2200  $\mu$ F at C1 and solder.
- 58. Install a 2200  $\mu$ F at C2 and solder.

This completes installation of all capacitors. Before moving on construction, re-check the polarity of each electrolytic one more time to confirm all are installed correctly.

The first group of semiconductor include four (4) small ICs and two (2) transistors. These are all packaged exactly alike. To avoid confusion, read markings carefully before installing! Like the electrolytic caps, transistors and ICs must be oriented correctly to work.

#### Transistors



#### Voltage Regulators

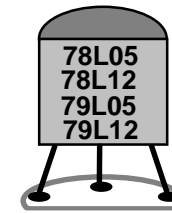

- 59. Find a 78L05 voltage regulator IC. Install at U6 and solder.
- 60. Find a 78L12 voltage regulator IC. Install at U4 and solder.
- 61. Find a 79L05 voltage regulator IC. Install at U7 and solder.
- 62. Find a 79L12 voltage regulator IC. Install at U5 and solder.
- 63. Find a 2N3904 transistor. Install at Q1 and solder.
- 64. Find a 2N3906 transistor. Install at Q2 and solder.

The remaining ICs will be installed in sockets. Locate the two (2) eight-pin IC sockets and one (1) 20-pin socket provided. Identify the notch (or key) at one end. During installation, each socket will be oriented so that this notch corresponds to the key on the PC layout.

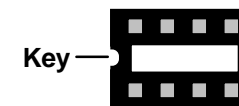

When installing sockets, make sure all pins enter the mounting holes and appear on the opposite side of the PC board (it's easy to fold them under the socket). Also, when soldering, make sure the socket remains flush with the board surface.

- 65. Find a eight-pin IC socket. Orient to U2, install, and solder all 8 pins.
- 66. Find a eight-pin IC socket. Orient to U3, install, and solder all 8 pins.
- 67. Find a twenty-pin IC socket. Orient to U1. install, and solder all 20 pins.

The ICs will be installed later.

Your kit contains seven (7) calibration trimpots. Locate these now. From this group, identify the 1K trimpot (marked 1K or 102). This will be installed first. All others are 5K (marked 5K or 502). Make sure the trimpot body is flush against the PC board before soldering in place.

- 68. Install a 1K trimpot at R10 and solder.
- 69. Install a 5K trimpot at R4 and solder.
- 70. Install a 5K trimpot at R5 and solder.
- 71. Install a 5K trimpot at R6 and solder.
- 72. Install a 5K trimpot at R7 and solder.
- 73. Install a 5K trimpot at R8 and solder.
- 74. Install a 5K trimpot at R9 and solder.

Find the 6-position rotary switch. Orient at SW2, as shown below--noting the raised "key" next to the shaft.

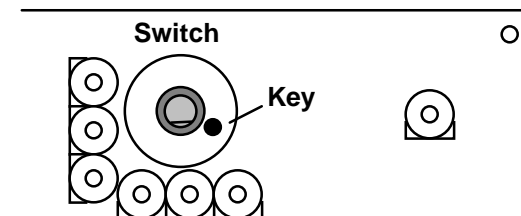

The switch must be seated firmly before soldering to ensure shaft alignment with the front panel.

- 75. Install the 6-position rotary switch at SW2 and solder all pins in place.

Three insulated jumpers are needed to complete PC board assembly. To prepare, cut hook-up wire to the prescribed length and strip 1/4" of insulation from both ends. Find a 6" length of yellow hook-up wire and cut as follows:

- 76. Cut to 1 3/4" and prepare jumper. Install at JMP3 and solder.
- 77. Cut to 1 3/4" and prepare jumper. Install at JMP1 and solder.
- 78. Cut to 1" and prepare jumper. Install at JMP2 and solder.

Finally, locate the remaining three (3) ICs. Each has a round key or a notch at one end to indicate correct orientation. Before installing, inspect carefully and confirm all pins are straight. During installation, align pins carefully and insert slowly to avoid bending or folding. Observing orientation, install as follows:

- 79. Install the LM318 op-amp IC at U2.
- 80. Install the LM358 op-amp IC at U3.
- 81. Install the MAX038CPP function-generator IC at U1.

All components should now be installed on your PC board. Next, you'll install switches, controls, and jacks on the front panel and wire them to the PC board. Before starting this procedure, give the PC board a thorough inspection.

This is the final phase of construction. To begin, position the front panel with the silk-screened side down, as shown below. Locate the remaining switches, jacks, and potentiometers. Install as follows:

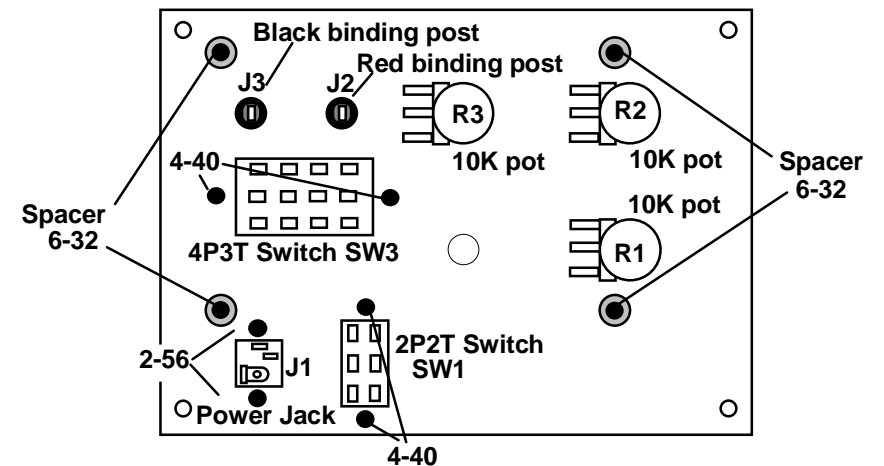

Find two (2) binding posts. When installing, use care not to overtighten--plastic threads may be damaged by excessive torque.

- 82. Install the black binding post at J3.
- 83. Install the red binding post at J2.



Locate three (3) 10K pots (marked B103 or B10K). Using a flat washer and a nut, install each at the position indicated. Orient with solder terminals to the left side:

- 84. Install a 10K pot at R1.
- 85. Install a 10K pot at R2.
- 86. Install a 10K pot at R3.
- 87. Find the 4P3P slide switch. Using 4-40 hardware, install at SW3.
- 88. Find the 2P2T slide switch. Using 4-40 hardware, install at SW1.
- 89. Find the 2.1-mm power jack. Position as shown, with the larger riveted (+) terminal at the bottom. Using 2-56 hardware, install at J1 from the front side of the panel.

Locate four (4) 1-1/4" aluminum spacers. Using 6-32 screws, install on the front panel at the positions shown:

- 90. Install a spacer above J3.
- 91. Install a spacer next to J1.
- 92. Install a spacer below R1.
- 93. Install a spacer above R2.

This concludes mounting of front-panel components. Double-check to make sure each is positioned correctly. Begin wiring by installing a short jumper between the power jack and power switch. Find a length of yellow wire and prepare as follows:

- 94. Cut a 1 1/2" length of yellow wire. Remove 1/4" insulation from one end and 3/8" insulation from the other.
- 95. Thread the stripped 3/8" end through the bottom two terminals of SW1, as shown in the following diagram. Solder to both pins.
- 96. Connect the other end to the riveted (+) terminal of power jack J1 and solder (see following diagram).

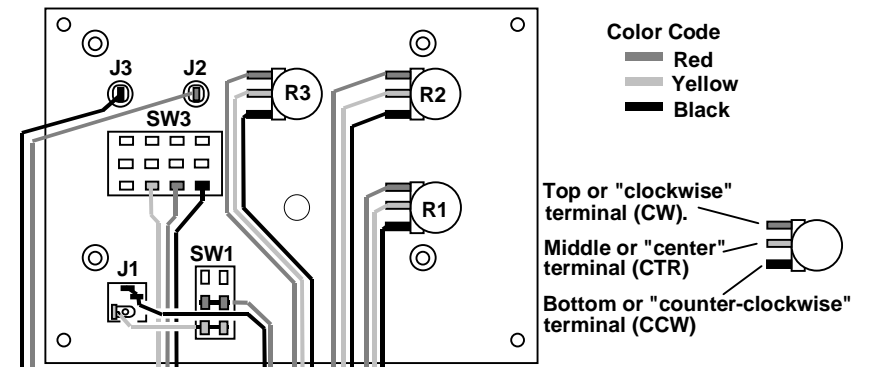

The remaining wires will be installed one control at a time, and twisted together for routing to the PC board. To prepare, cut each to the specified length and remove 1/4" insulation from each end. Wrap tab or lug connections before soldering (see following diagram):

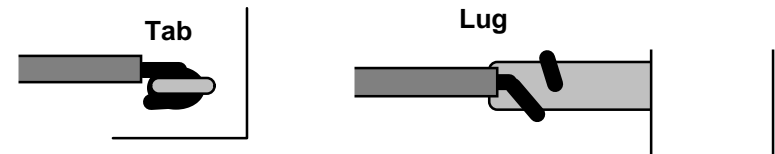

- 97. Begin by wiring R1. Cut and prep a set of 6" red, yellow, and black lead. Find R1 and install as follows:
- 98. Attach a red lead to the top (CW) terminal of R1 and solder.
- 99. Attach a yellow lead to the center (CTR) terminal of R1 and solder.
- 100. Attach a black lead to the bottom (CCW) terminal of R1 and solder.
- 101. Twist all three wires together, leaving about 1 1/2" unwound at the far end.
- 102. Cut and prep another set of 6" wires (red, yellow, and black). Find R2.
- 103. Attach a red lead to the top (CW) terminal of R2 and solder.
- 104. Attach a yellow lead to the center (CTR) terminal of R2 and solder.
- 105. Attach a black lead to the bottom (CCW) terminal of R2 and solder.
- 106. Twist all three wires together, leaving about 1 1/2" unwound at the far end.

- 107. Cut and prep another set of 6" wires (red, yellow, and black). Find R3.
- 108. Attach a red lead to the top (CW) terminal of R3 and solder.
- 109. Attach a yellow lead to the center (CTR) terminal of R3 and solder.
- 110. Attach a black lead to the bottom (CCW) terminal of R3 and solder.
- 111. Twist all three wires together, leaving about 1 1/2" unwound at the far end.
- 112. Cut and prep a 6" red and black lead. Find binding posts J2, J3.
- 113. Connect the red wire to J2 and solder.
- 114. Connect the black wire to J3 and solder.
- 115. Twist together.
- 116. Cut and prep a 6" red, yellow, and black lead. Find SW3 and locate the lower right-hand terminal (see diagram).
- 117. Attach a black lead on the bottom right-hand terminal and solder.
- 118. Move left one terminal and attach a red lead. Solder.
- 119. Move left again, and attach a yellow lead. Solder.
- 120. All three leads should be connected on the bottom row. Twist wires together.
- 121. Cut a 6" red and black lead. Remove 1/4" insulation from one end and 3/8" insulation from the other end on each.
- 122. Thread the 3/8" end of the black lead through the two free terminals on J1. Solder.
- 123. Thread the 3/8" end of the red wire through the center terminals on SW1. Solder.
- 124. Twist both together.

This completes front-panel wiring. Check your work against the wiring pictorial for errors. The next group of connections will be made on the PC board.

Locate the three-wire harness connected to *Frequency* control R1. Connect to the PC board as follows:

- 125. Connect R1 red wire to *FREQ\_CW* (near key end of U1).
- 126. Connect R1 yellow wire to *FREQ\_MID* (near unkeyed end of U3).
- 127. Connect R1 black wire to *FREQ\_CCW* (near R10).

Locate the three-wire harness connected to *Amplitude* control R2.

128. Connect R2 red wire to AMPL\_CW (near R16).

129. Connect R2 yellow wire to AMPL\_MID (near R17).

130. Connect R2 black wire to AMPL\_CCW (near R11).

Locate the three-wire harness connected to *DC Offset* control R3.

131. Connect R3 red wire to OSET\_CW (near Q2).

132. Connect R3 yellow wire to OSET\_MID (near R18).

133. Connect R3 black wire to OSET\_CCW (near end of JMP1).

Locate the three-wire harness connected to *Waveform* switch SW3.

134. Connect SW3 red wire to WAVEFORM (near C11).

135. Connect SW3 yellow wire to TRI (near R11).

136. Connect SW3 black wire to SINE (near R12).

Locate the two-wire pair connected to *On/Off* switch SW1 and *12VAC* jack J1.

137. Connect SW1/J1 red wire to POWER (between C1 and C2).

138. Connect SW1/J1 black wire to GND (same).

Finally, locate the two-wire pair connected to *Output* binding posts J2, J3.

139. Connect J2 red wire to +OUT (between R31 and R32).

140. Connect J3 black wire to -OUT (same).

This concludes wiring of your VEC-4001K Function Generator Kit. Before moving on to the next section, give your kit a thorough QC (quality control) inspection. This will help you discover any inadvertent assembly errors that might prevent the unit from working or cause damage to parts. Follow this procedure:

1. Compare parts locations with the parts-placement diagram. Was each part installed where it is supposed to be? Was the correct value used? Start at one side of the board and work your way across in an organized pattern.
2. Inspect the solder side of the board for cold-solder joins and solder bridges between tracks or pads. Use a magnifying glass to obtain a clear view of the track area. If you suspect a solder bridge, hold the board in front of a bright light for a better view. All joints should be smooth and shiny, indicating good solder wetting and flow. Resolder any beaded or dull-appearing connections. Also, check the front-panel jacks, switches, and connectors for defective solder connections.

3. Finally, check electrolytic capacitors and diodes for correct polarity. Does the plus (+) polarity symbol on the part agree with the pictorial and with the pattern on the PC board? Is the banded end of each diode positioned correctly? Were all ICs and transistors installed correctly?

**Be sure to correct *all* errors before moving on.**

## **TESTING AND ALIGNMENT**

Before applying power and testing, mount the circuit board and install the unit's control knobs:

- Orient the PC board so the shaft of *Multiplier* switch SW2 aligns with its panel opening. Align mounting holes with the aluminum spacers. Secure the PC board in place using four (4) 6-32 screws.
- Find three (3) 3/4" skirted knobs. Install these on the *Frequency*, *DC Offset*, and *Amplitude* controls.
- Find the 3/4" pointer knob. Install on the *Multiplier* control.

**Note:** If you want the pointer knob even with the skirted knobs, simply trim 1/8" off the *Multiplier* control shaft before installing the pointer knob. This can be done using large or heavy duty cutters on the plastic shaft.

**Power-Up:** Your unit is designed to run from 12 VAC *only* and will not work with conventional 12 VDC power sources. Use only the wall-adaptor transformer supplied or an equivalent AC source. Before plugging in the power adaptor, position the Generator's *On/Off* switch to "off".

To check the internal power supply circuitry, connect a DVM to the *Output* posts observing (+) and (-) polarity. Set meter for the 10 VDC range. Position *DC Offset* and *Frequency* at 12:00 o'clock. Set *Multiplier* for  $10^2$ . Turn *Amplitude* fully down (counter-clockwise). *Waveform* setting isn't important for now. Apply power by setting the *Off/On* switch to "on".

1. Rotate *DC Offset* to the (-) side. The DVM should read a progressively stronger negative voltage down to -6 volts.
2. Rotate *DC Offset* toward (+). This should yield a corresponding positive voltage up to +6 volts.

If you fail to obtain this result, re-check power supply circuitry around U4-U7 and note the orientation of U2 in its socket. Also, check Q1/Q2.

**Waveform Check:** Before conducting this check, adjust all internal calibration trimpots (R4-R10) for midscale (12:00). These are all accessible through the back side of the PC board, as shown.

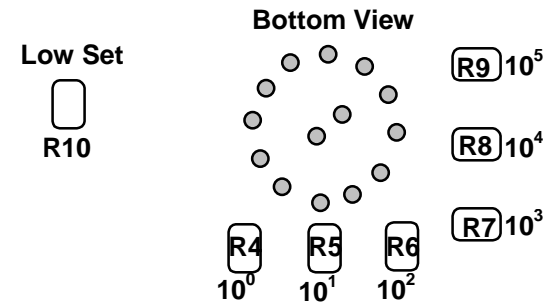

To check the generator's output signal, set an oscilloscope to measure 10 Vpp with a 1 mS sweep rate. Connect scope input to *Output*. Set the generator's *DC Offset*, *Amplitude*, and *Frequency* for 12:00, and switch *Multiplier* to  $10^2$ .

3. Set *Waveform* for sinewave and check output trace.
4. Set for triangle and check output trace.
5. Set for squarewave and check output trace.
6. Adjust *Amplitude* up and down observing change.

The generator's peak-to-peak output should roughly coincide with scale markings on the *Amplitude* control. If you fail to obtain the correct waveforms, check switch wiring and PC-board connections. If amplitude is substantially inaccurate, check for errors around R2.

**Frequency Calibration:** You may calibrate your generator using an audio frequency counter or an oscilloscope with a calibrated sweep. Note that some wide-range RF counters may not perform well at audio frequencies below 100 kHz.

**A. Counter Method:** Connect counter to *Output* terminals. Set *DC Offset* and *Amplitude* at 12:00. Set *Frequency* to 10 (CW) and *Waveform* to square.

1. Set *Multiplier* to  $10^5$  and adjust R9 for 1 MHz output.
2. Switch *Multiplier* to  $10^4$  and adjust R8 for 100 kHz output.
3. Switch *Multiplier* to  $10^3$  and adjust R7 for 10 kHz output.
4. Switch *Multiplier* to  $10^2$  and adjust R6 for 1 kHz output.
5. Switch *Multiplier* to  $10^1$  and adjust R5 for 100 Hz output.
6. Switch *Multiplier* to  $10^0$  and adjust R4 for 10 Hz output.\*
7. Set *Frequency* control to 1 (CCW).
8. Switch *Multiplier* back to  $10^2$  and adjust R10 for 100 Hz output.

\* Note that counters designed for RF work may not read 10 Hz or even 100 Hz with accuracy. If your counter has an input filter, it should be switched "on" when measuring frequencies in this range.

**B. Scope Method #1:** Connect a scope with calibrated sweep to *Output*. Set *DC Offset* and *Amplitude* for 12:00. Set *Frequency* to 10 (CW) and *Waveform* to square. Trimpots will be adjusted to yield period of 5 divisions. When adjusting the trimpots, make sure the waveform is symmetrical; that is, the high transition time equals to the low transition time.

1. Set *Multiplier* to  $10^5$  and set *Sweep* for .2  $\mu\text{S}/\text{div}$ . Adjust R9 for 5 division period.
2. Switch *Multiplier* to  $10^4$  and set *Sweep* for 2  $\mu\text{S}/\text{div}$ . Adjust R8 for 5 division period.
3. Switch *Multiplier* to  $10^3$  and set *Sweep* for 20  $\mu\text{S}/\text{div}$ . Adjust R7 for 5 division period.
4. Switch *Multiplier* to  $10^2$  and set *Sweep* for .2 mS/div. Adjust R6 for 5 division period.
5. Switch *Multiplier* to  $10^1$  and set *Sweep* for 2 mS/div. Adjust R5 for 5 division period.
6. Switch *Multiplier* to  $10^0$  and set *Sweep* for 20 mS/div. Adjust R4 for 5 division period.\*
7. Set *Frequency* control to 1 (CCW).
8. Switch *Multiplier* back to  $10^2$  and *Sweep* for 2 mS/div. Adjust R10 for 5 division period.

\* Note the period might be longer than 5 divisions due to component tolerance. To compromise for this tolerance, adjust for longer than 5-division period when adjusting trimpot R10 so the frequency ranges will overlapped.

**C. Scope Method #2:** Connect a scope with calibrated sweep to *Output*. Set *DC Offset* and *Amplitude* for 12:00. Set *Frequency* to 10 (CW) and *Waveform* to triangle. Trimpots will be adjusted to yield 1 Hz per division. To ensure accuracy, each waveform peak should align with horizontal divisions all the way across the screen (see the following diagram).

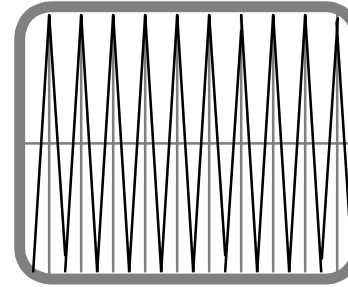
**Generator Range**

$10^0$	1-10 Hz
$10^1$	10-100 Hz
$10^2$	100-1000 Hz
$10^3$	1 kHz - 10 kHz
$10^4$	10 kHz - 100 kHz
$10^5$	100 kHz - 1 MHz

1. Set *Multiplier* to  $10^5$  and set *Sweep* for 1  $\mu$ S. Adjust R9 for 1 Hz/Div.
2. Switch *Multiplier* to  $10^4$  and set *Sweep* for 10  $\mu$ S. Adjust R8 for 1 Hz/Div.
3. Switch *Multiplier* to  $10^3$  and set *Sweep* for .1 mS. Adjust R7 for 1 Hz/Div.
4. Switch *Multiplier* to  $10^2$  and set *Sweep* for 1 mS. Adjust R6 for 1 Hz/Div.
5. Switch *Multiplier* to  $10^1$  and set *Sweep* for 10 mS. Adjust R5 for 1 Hz/Div.
6. Switch *Multiplier* to  $10^0$  and leave *Sweep* at 10 mS. Adjust R4 so 1 Hz spans the entire screen (all 10 divisions).\*
7. Set *Frequency* control to 1 (CCW).
8. Switch *Multiplier* back to  $10^2$  and leave *Sweep* at 10 mS. Adjust R10 for 1 Hz/Div.

\* Note 1 Hz might span longer than 10 divisions due to component tolerance. To compromise for this tolerance, adjust for greater than one division cycle when adjusting trimpot R10 so the frequency ranges will overlapped.

This concludes calibration. If your generator fails to calibrate properly on one or more *Multiplier* settings, check component values in the affected range(s) for errors.

To complete your unit, install the the front panel (with the pc board attached) to the plastic enclosure. Use the four (4) remaining 6-32 screws to secure the front panel to the enclosure. Finally, place the four (4) rubber feet on the bottom of the enclosure. Place one at each corner.



## OPERATING INSTRUCTIONS

**Control Functions:** See the following diagram for control locations:

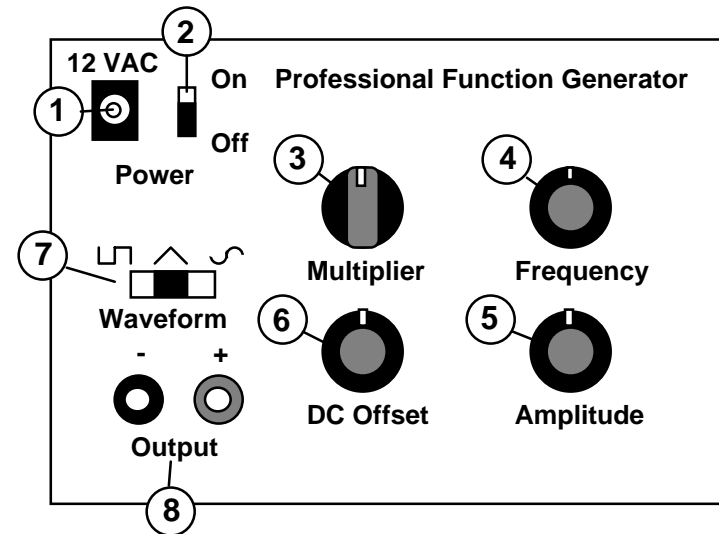

1. **Power Adapter:** Generator requires 12-VAC adapter (do not use DC types).
2. **Power Switch:** Turns power on and off.
3. **Multiplier:** Selects generator frequency range as a power of 10 (1 Hz to 1 MHz).
4. **Frequency:** Varies frequency from 1 to 10 times the Multiplier setting.
5. **Amplitude:** Adjusts output amplitude from 0 to 12-volts p-p.
6. **DC Offset:** Adjusts DC bias on waveform from -6 to +6 VDC.
7. **Waveform:** Selects square, triangle, or sine waveform output.
8. **Output:** Binding posts provide connection to device under test.

To set for a given output signal, first select the desired increment using the *Frequency* control. Then, set the desired *Multiplier*. For example, a *Frequency* setting of 5 and a *Multiplier* of  $10^2$  yields a 500-Hz ( $5 \times 10^2$ ) signal. *Amplitude* is calibrated in volts p-p. To obtain low-level signals for AF amplifier testing, install a 10:1 or 100:1 voltage divider across the output terminals using 1/4-watt resistors. At low signal levels, the use of a shielded test cable is recommended.

## **IN CASE OF DIFFICULTY**

If your VEC-4001K Generator fails to perform to your expectation, please try these simple steps before seeking outside assistance. If you are still unable to resolve the problem, technical assistance and repair services are available from Vectronics (see warranty for terms and conditions).

**Unit won't power up:** Check AC adapter. Also, check plug at Generator's power jack--this must be 2.1-mm type to transfer power. AC wall adapter must have 12-VAC output (DC adapters won't work). Check cable for breaks, etc.

**No Output:** Check cable from generator *Output* to DUT. Check U2 for damage.

**Hum on Output Signal:** Open ground on test line. Also, ground loop on bench. Make sure all test equipment and other power sources are tied to a common ground.

**Low Generator Output:** Low-Z load or shorted test cable.

**Distortion on Waveform:** Low-Z load or short on output of generator. Also, damage to U2 or incorrect components installed during construction.

If these checks fail to uncover the problem, repeat the "QC" check one more time. Service records show that, for most malfunctioning kits, outright component failure is relatively rare. In most cases, the culprit is a misplaced part, reverse-polarized capacitor or diode, improperly installed transistor, or faulty solder connection. If, despite your best effort, you cannot solve the problem, kit repair services are available through Vectronics. See the warranty on the inside front cover for complete instructions.

## **THEORY OF OPERATION AND SPECIFICATIONS**

Your generator kit is built around the MAX038CPP, a special-function IC at U1 which provides sinewave, squarewave, and triangle-wave output over a wide frequency range. Op-amp U2 buffers the generator IC's output signal and establishes adjustable DC Offset. U3 buffers the IC's VCO reference voltage to ensure stability. Q1/Q2 provide low-Z output with short-circuit protection. All source voltages are regulated (U4-U7).

### **Typical Specifications:**

Power Requirements:.....12 VAC

Frequency Range:.....1 Hz to 1 MHz in six decade ranges

Amplitude Range:.....0 to 12 volts peak-to-peak

DC Offset Range: .....-6 volts to +6 volts

Output Impedance: .....400 ohms, short-circuit protected

**SCHMATIC**

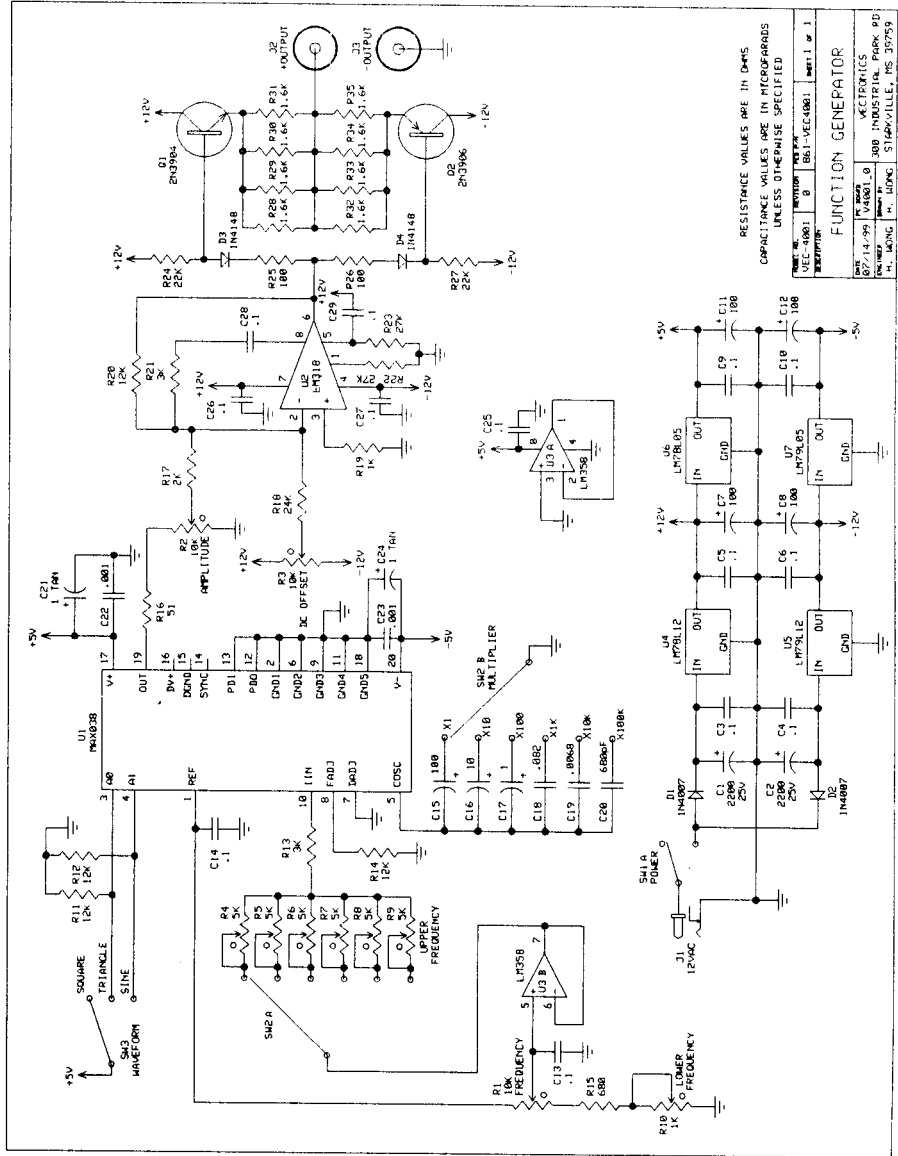

**ENCLOSURE**

