

## **IMPORTANT WARRANTY INFORMATION! PLEASE READ**

Return Policy on Kits When Not Purchased Directly From Vectronics: Before continuing any further with your VEC kit check with your Dealer about their return policy. If your Dealer allows returns, your kit must be returned *before you begin construction*.

Return Policy on Kits When Purchased Directly From Vectronics: Your VEC kit may be returned to the factory *in its pre-assembled condition only*. The reason for this stipulation is, once you begin installing and soldering parts, you essentially take over the role of the device's manufacturer. From this point on, neither Vectronics nor its dealers can reasonably be held accountable for the quality or the outcome of your work. Because of this, Vectronics cannot accept return of any kit-in-progress or completed work as a warranty item for any reason whatsoever. If you are a new or inexperienced kit builder, we urge you to read the manual carefully and determine whether or not you're ready to take on the job. If you wish to change your mind and return your kit, you may--but you must do it *before you begin construction*, and within ten (10) working days of the time it arrives.

Vectronics Warrants: Your kit contains each item specified in the parts list.

Missing Parts: If you determine, during your pre-construction inventory, that any part is missing, please contact Vectronics and we'll send the missing item to you free of charge. However, *before you contact Vectronics, please look carefully* to confirm you haven't misread the marking on one of the other items provided with the kit. Also, make certain an alternative part hasn't been substituted for the item you're missing. If a specific part is no longer available, or if Engineering has determined that an alternative component is more suitable, Vectronics reserves the right to make substitutions at any time. In most cases, these changes will be clearly noted in an addendum to the manual.

Defective Parts: Today's electronic parts are physically and electrically resilient, and defective components are rare. However, if you discover an item during your pre-construction inventory that's obviously broken or unserviceable, we'll replace it. Just return the part to Vectronics at the address below accompanied with an explanation. Upon receipt, we'll test it. If it's defective and appears unused, we'll ship you a new one right away at no charge.

Missing or Defective Parts After You Begin Assembly: Parts and materials lost or damaged *after construction begins* are not covered under the terms of this warranty. However, most parts supplied with VEC kits are relatively inexpensive and Vectronics can replace them for a reasonable charge. Simply contact the factory with a complete description. We'll process your order quickly and get you back on track.

Factory Repair After You Begin Assembly: *Kits-in progress and completed kits are specifically excluded from coverage by the Vectronics warranty.* However, as a service to customers, technicians are available to evaluate and repair malfunctioning kits for a minimum service fee of 518.00 (1/2 hour rate) plus 57.00 shipping and handling (prices subject to change). To qualify for repair service, your kit must be fully completed, unmodified, and the printed circuit board assembled using rosin-core solder. In the event your repair will require more than an hour to fix (or 536.00, subject to change), our technicians will contact you in advance by telephone before performing the work. Defective units should be shipped prepaid

Vectronics

1007 HWY 25 South  
Starkville, MS 39759

When shipping, pack your kit well and include the minimum payment plus shipping and handling charges (525.00 total). No work can be performed without pre-payment. Also, provide a valid UPS return address and a day time phone number where you may be reached.

## INTRODUCTION

Thank you for purchasing the VEC-830K Single Side-Band Filter kit. The VEC-830K is a four stage, switch selectable filter, that will make "cleaning up" Single Side-Band signals effortless and easy. With the VEC-830K you bring up any hard to hear signal out of a "band pile up," for easy listening, or get rid of unwanted, annoying signals. The VEC-830K also features a headphone output that will allow the use of standard mono headphones. Although small in size, the VEC-830K is high on performance and reliability. Powered from a 9volt transistor batten', the VEC-830K will provide you with many hours of use.

## TOOLS AND SUPPLIES

Construction Area: Kit construction requires a clean, smooth, and welllighted area where you can easily organize and handle small parts without losing them. An inexpensive sheet of white poster board makes an excellent construction surface, while providing protection for the underlying table or desk. Well-diffused overhead lighting is a plus, and a supplemental high intensity desk lamp will prove especially helpful for close-up work. Safety is an important consideration. Be sure to use a suitable high-temperature stand for your soldering iron, and keep the work area free of combustible clutter.

Universal Kit-building Tools: Although your particular kit may require additional items to complete, virtually all construction projects require a work area outfitted with the following tools and supplies:

- 30-60 watt Soldering Iron
- High-temperature Iron Holder with a Moist Cleaning Sponge
- Rosin-core Solder (thin wire-size preferred)
- Needle Nose Pliers or Surgical Hemostats
- Diagonal Cutters or "Nippy Cutters"
- Wire Strippers
- Solder Sucker, Vacuum Pump, or Desoldering Braid
- Bright Desk Lamp
- Magnifying Glass

## BEFORE YOU START BUILDING

Experience shows there are jour *common mistakes* builders make. Avoid these, and your kit will probably work on the first try! Here's what they are:

1. Installing the Wrong Part: It always pays to double-check each step. A 1K and a 10K resistor may look *almost* the same, but they may act very differently in an electronic circuit! Same for capacitors--a device marked 102 (or .001 uF) may have very different operating characteristics from one marked 103 (or .01uF).
2. Installing Parts Backwards: Always check the polarity of electrolytic capacitors to make sure the positive (+) lead goes in the (+) hole on the circuit board. Transistors have a flat side or emitter tab to help you identify the correct mounting position. ICs have a notch or dot at one end indicating the correct direction of insertion. Diodes have a banded end indicating correct polarity. Always double-check--especially before applying power to the circuit!
3. Faulty Solder Connections: Inspect for cold-solder joints and solder bridges. Cold solder joints happen when you don't fully heat the connection--or when metallic corrosion and oxide contaminate a component lead or pad. Solder bridges form when a trail of excess solder shorts pads or tracks together (see Soldering Tips below).
4. Omitting or Misreading a Part: This is easier to do than you might think! Always double-check to make sure you completed each step in an assembly sequence.

### Soldering Tips:

*Cleanliness* and good *heat distribution* are the two secrets of professional soldering. Before you install and solder each part, inspect leads or pins for oxidation. If the metal surface is dull, sand with fine emery paper until shiny. Also, clean the oxidation and excess solder from the soldering iron tip to ensure maximum heat transfer. Allow the tip of your iron to contact both the lead and pad for about one second (count "one-thousand-one") before feeding solder to the connection. Surfaces must become hot enough for solder to flow *smoothly*. Feed solder to the opposite side of the lead from your iron tip--solder will wick around the lead toward the tip, wetting all exposed surfaces. Apply solder sparingly, and do not touch solder directly to the hot iron tip to promote rapid melting.

**Desoldering Tips:**

If you make a mistake and need to remove a part, follow these instructions carefully! First, grasp the component with a pair of hemostats or needle-nose pliers. Heat the pad beneath the lead you intend to extract, and pull gently. The lead should come out. Repeat for the other lead. Solder may fill in behind the lead as you extract it--especially if you are working on a double-sided board with plate-through holes. Should this happen, try heating the pad again and inserting a common pin into the hole. Solder won't stick to the pin's chromium plating. When the pad cools, remove the pin and insert the correct component. For ICs or multi-pin parts, use desoldering braid to remove excess solder before attempting to extract the part. Alternatively, a low-cost vacuum-bulb or spring-loaded solder sucker may be used. Parts damaged or severely overheated during extraction should be replaced rather than reinstalled.

**Work Habits:**

Kit construction requires the ability to follow detailed instructions and, in many cases, to perform new and unfamiliar tasks. To avoid making needless mistakes, work for short periods when you're fresh and alert. Recreational construction projects are more informative and more fun when you take your time. Enjoy!

**Sorting and Reading Resistors:**

The electrical value of resistors is indicated by a color code (shown below). You don't have to memorize this code to work with resistors, but you do need to understand how it works:

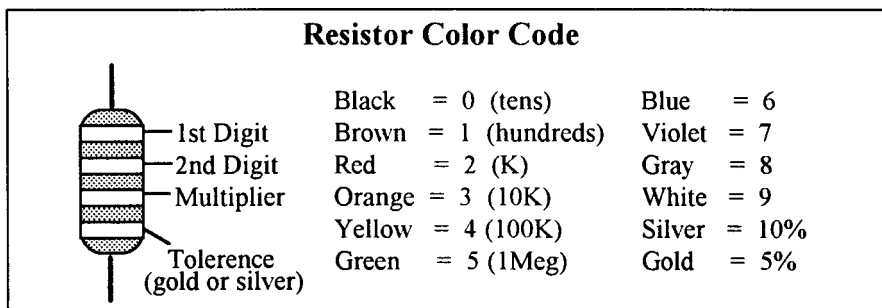





When you look at a resistor, check its multiplier code first. Any resistor with a black multiplier band falls between 10 and 99 ohms in value. Brown designates a value between 100 and 999 ohms. Red indicates a value from 1000 to 9999 ohms, which is also expressed as 1.0K to 9.9K. An orange multiplier band designates 10K to 99K, etc. To sort and inventory resistors, first separate them into groups by multiplier band (make a pile of 10s, 100s, Ks,

10Ks, etc.). Next, sort each group by specific value (1K, 2.2K, 4.7K, etc.). This procedure makes the inventory easier, and also makes locating specific parts more convenient later on during construction. Some builders find it especially helpful to arrange resistors in ascending order along a strip of double-sided tape.

Some VEC kits may contain molded chokes which appear, at first glance, similar to resistors in both shape and band marking. However, a closer look will enable you to differentiate between the two--chokes are generally larger in diameter and fatter at the ends than resistors. When doing your inventory, separate out any chokes and consult the parts list for specific color-code information.

#### Reading Capacitors:

Unlike resistors, capacitors no longer use a color code for value identification. Instead, the value, or a 3-number code, is printed on the body.

Value	Code			
10 pF	= 100			
100 pF	= 101			
1000 pF	= 102			
.001 uF	= 102*			
.01 uF	= 103			
.1 uF	= 104			
		Multilayer (270 pF)	Ceramic Discs (.001 uF)    (.1 uF)	Electrolytic 1 uF
			 	

As with resistors, it's helpful to sort capacitors by type, and then to arrange them in ascending order of value. Small-value capacitors are characterized in pF (or pico-Farads), while larger values are labeled in uF (or micro-Farads). The transition from pF to uF occurs at 1000 pF (or .001 uF)\*. Today, most monolithic and disc-ceramic capacitors are marked with a three-number code. The first two digits indicate a numerical value, while the last digit indicates a multiplier (same as resistors).

Electrolytic capacitors are always marked in uF. Electrolytics are polarized devices and must be oriented correctly during installation. If you become confused by markings on the case, remember the uncut negative lead is slightly shorter than the positive lead.

#### Diodes:

Diodes are also polarized devices that must be installed correctly. Always look for the banded or cathode end when installing, and follow instructions carefully.

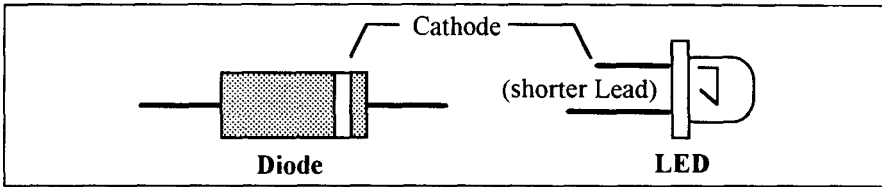

Transistors:

If transistors are installed incorrectly, damage may result when power is applied. Transistors in metal cases have a small tab near the emitter lead to identify correct positioning. Semiconductors housed in small plastic cases (TO-92) have an easily-identified flat side to identify mounting orientation. Many specialized diodes and low-current voltage regulators also use this type packaging. Larger plastic transistors and voltage regulators use a case backed with a prominent metal tab to dissipate heat (T-220). Here orientation is indicated by the position of the colling tab.

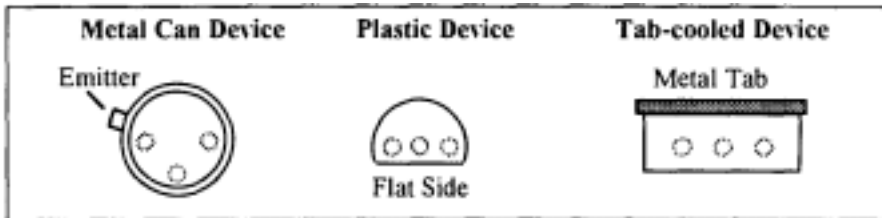

Integrated Circuits:

Proper IC positioning is indicated by a dot or square marking located on one end of the device. A corresponding mark will be silk-screened on the PC board and printed on the kit's parts-placement diagram. To identify specific IC pin numbers for testing purposes, see the diagram below. Pin numbers always start at the keyed end of the case and progress counter-clockwise around the device, as shown:

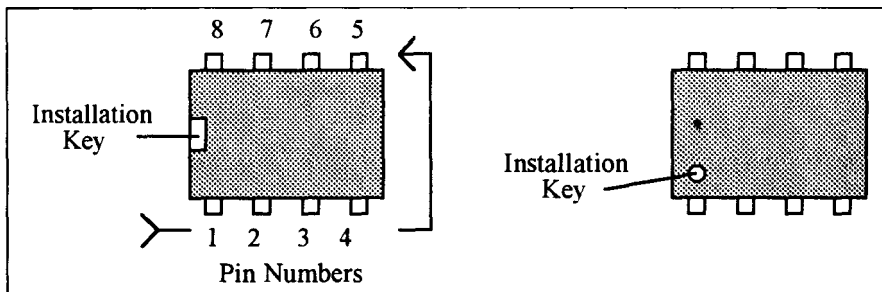

## PARTS LIST

Your kit should contain all of the parts listed below. Please go through the parts bag to identify and inventory each item on the checklist before you start building. If any parts are missing or damaged, refer to the warranty section of this manual for replacement instructions. If you can't positively identify an unfamiliar item in the bag on the basis of the information given, set it aside until all other items are checked off. You may then be able to identify it by process of elimination. Finally, your kit will go together more smoothly if parts are organized by type and arranged by value ahead of time. Use this inventory as an opportunity to sort and arrange parts so you can identify and find them quickly.

Qty	Part Description	Designation
2	100K ohm resistor (brown-black-yellow-gold)	R2,R3
2	150K ohm resistor (brown-green-yellow-gold)	R4,R5
2	240K ohm resistor (red-yellow-yellow-gold)	R6,R7
1	300K ohm resistor (orange-black-yellow-gold)	R1
2	1.2M ohm resistor (brown-red-green-gold)	R8,R9
5	1000 pF ploysterene capacitor (1000J)	C1,C2,C3,C4,C
3	470pF ploysterene capacitor (470J)	C6,C7,C8
1	10 uF electrolytic capacitor (IOuf)	C9
2	LM747 Op Amp IC	U1, U2
2	14-Pin Low Profile IC Socket	For U1, U2
1	4P4T Slide Switch	SW1
8	6" insulated wires	Circuit wiring
2	4-40 x 1/4" Phillips Machine Screws	
1	9-volt battery snap; 8"	GND, VCC
1	Single Sided PC board VEC-830K	
1	Instruction Manual	

PARTS PLACEMENT DIAGRAM

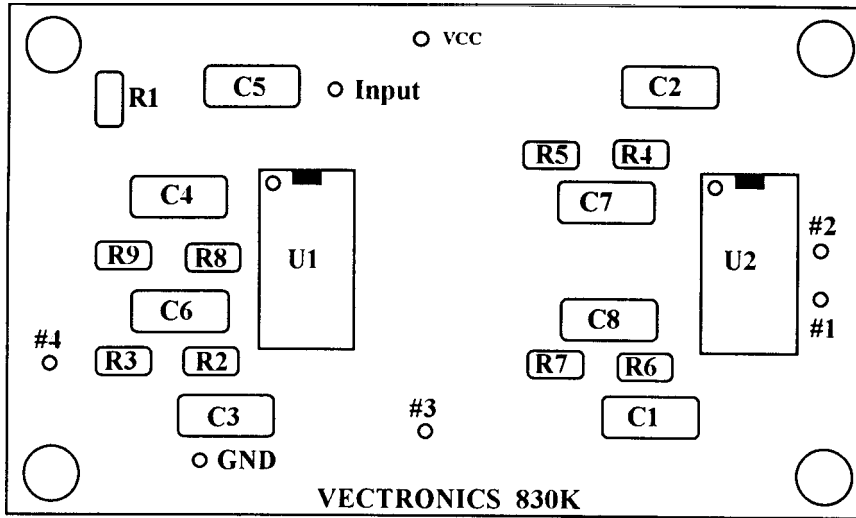

Figure 1

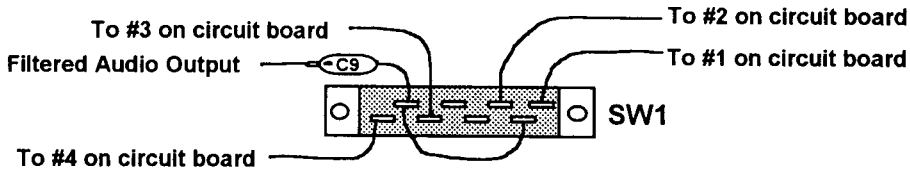
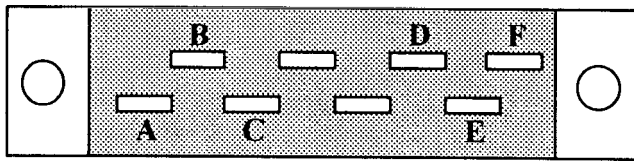

Figure 3



**STEP-BY-STEP ASSEMBLY**

Before assembling your kit, please take time to read and understand the VEC kit warranty printed on the inside cover of this manual. Also, read through the assembly instructions to make sure the kit does not exceed your skill level. Once you begin construction, your kit will be non-returnable. Finally, if you haven't already done so, please verify that all parts listed in the inventory are included.

If anything is missing or broken, refer to the warranty instructions for replacing missing or damaged parts.

Note that part designators, such as R1, C3, etc., appear on a silk-screened legend on the component-mounting side of the printed circuit board. This corresponds with the parts placement page in the manual. All parts will be inserted on the silk-screen side of the board.

If you have last-minute questions about what you need to build your kit, please refer back to the section titled "Tools and Supplies". If you're ready to begin now, here we go! The directions use two sets of check boxes. Check one when a step is complete and use the other for double-checking your work before operation.

1. Locate resistor R1. This is a 300K ohm resistor (orange-black-yellow-gold).

Carefully bend the leads close to the resistor body to form right-angles (see following diagram).

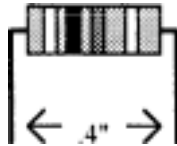

2. Insert R1 into its mounting holes so the resistor body rests against the board. Solder in place and trim the leads.
3. Locate resistor R2. This is a 100K ohm resistor (brown-black-yellow-gold).
4. Insert R2 into its mounting holes so the resistor body rests against the board. Solder in place and trim the leads.
5. Locate resistor R3. This is a 100K ohm resistor (brown-black-yellow-gold).
6. Locate resistor R4. This is a 150K ohm resistor (brown-green-yellow-gold).

- 7. Insert R4 into its mounting holes so the resistor body rests against the board. Solder in place and trim the leads.
- 8. Locate resistor R5. This is a 150K ohm resistor (brown-green-yellow-gold).
- 9. Insert R5 into its mounting holes so the resistor body rests against the board. Solder in place and trim the leads.
- 10. Locate resistor R6. This is a 240K ohm resistor (red-yellow-vellow-gold).
- 11. Insert R6 into its mounting holes so the resistor body rests against the board. Solder in place and trim the leads.
- 12. Locate resistor R7. This is a 240K ohm resistor (red-yellow-yellow-gold).
- 13. Insert R7 into its mounting holes so the resistor body rests against the board. Solder in place and trim the leads.
- 14. Locate resistor R8. This is a 1.2M ohm resistor (brown-red-greengold).
- 15. Insert R8 into its mounting holes so the resistor body rests against the board. Solder in place and trim the leads.
- 16. Locate resistor R9. This is a 1.2M ohm resistor (brown-red-greengold).
- 17. Insert R9 into its mounting holes so the resistor body rests against the board. Solder in place and trim the leads.

**Important Note:** Capacitors C1-C8 are made of a polystyrene type material. Avoid overheating these components when soldering to prevent melting the capacitor body.

- 18. Locate capacitor C1 (1000pF). This is a polystyrene capacitor and will be marked "10001" (actual value in pF). Carefully install C1, solder in place, and trim the leads.
- 19. Locate capacitor C2 (1000pF). This is another polystyrene capacitor and will be marked "10001" (actual value in pF). Carefully install C2 in the same manner as C1, solder in place, and trim the leads.
- 20. Locate capacitor C3 (1000pF). This is another polystyrene capacitor and will be marked "10001" (actual value in pF). Carefully install C3 in the same manner as C2, solder in place, and trim the leads.

- 21. Locate capacitor C4 (1000pF). This is another polystyrene capacitor and will be marked "1000J" (actual value in pF). Carefully install C4 in the same manner as C3, solder in place, and trim the leads.
- 22. Locate capacitor C5 (1000pF). This is another polystyrene capacitor and will be marked "1000J" (actual value in pF). Carefully install C5 in the same manner as C4, solder in place, and trim the leads.
- 23. Locate capacitor C6 (470pF). This is a polystyrene capacitor and will be marked "470J" (actual value in pF). Carefully install C6 in the same manner as C5, solder in place, and trim the leads.
- 24. Locate capacitor C7 (470pF). This is a polystyrene capacitor and will be marked "470J" (actual value in pF). Carefully install C7 in the same manner as C6, solder in place, and trim the leads.
- 25. Locate capacitor C8 (470pF). This is a polystyrene capacitor and will be marked "470J" (actual value in pF). Carefully install C8 in the same manner as C7, solder in place, and trim the leads.
- 26. Locate two (2) 6" insulated wires. Cut these wires in half, making four (4) 3" pieces.
- 27. Using the wire strippers, remove the about 1/4" of the insulation from the insulated ends of each 3" piece of insulated wire.
- 28. Locate Point #1 on the circuit board. Insert one of the 3" wires into the hole at Point #1 on the circuit board. Solder in place and trim the lead.
- 29. Locate Point #2 on the circuit board. Insert one of the 3" wires into the hole at Point #2 on the circuit board. Solder in place and trim the lead.
- 30. Locate Point #3 on the circuit board. Insert one of the 3" wires into the hole at Point #3 on the circuit board. Solder in place and trim the lead.
- 31. Locate Point #4 on the circuit board. Insert one of the 3" wires into the hole at Point #4 on the circuit board. Solder in place and trim the lead.
- 32. Locate one (1) 6" insulated wire. Cut this wire in half, making two (2) 3" pieces.
- 33. Using the wire strippers, remove the about 1/4" of the insulation from the insulated ends of each 3" piece of insulated wire.

- □ 34. Locate the hole on the circuit board labeled INPUT. Insert one of the 3" wires into this hole, solder in place and trim the lead.
- □ 35. Locate the hole on the circuit board labeled GND. Insert the remaining 3" wire into this hole, solder in place and trim the lead.
- □ 36. Locate the 8" battery snap. Insert the RED wire of the battery snap into the hole on the circuit board labeled VCC. Solder in place and trim the lead.
- □ 37. Locate the wire located at Point GND on the circuit board, and the BLACK wire on the battery snap. Twist these two wires together, being careful not to poke yourself.
- □ 38. Locate a piece of insulated wire. Twist one end of this wire together with the wires in the previous step and solder. Wrap this solder joint with a small piece of electrical tape to keep it from shorting to other parts of the circuit board. The other end is for audio ground.
- □ 39. Locate (1) 14 pin IC
- □ 40. Install the IC socket at the U 1 location on the circuit board. Be careful to orient the socket correctly according to the "Parts Placement" section Figure 1.
- □ 41. Carefully bend over the four corner pins of the socket against the solder pads on the solder side of the board. Solder all pins in place.
- □ 42. Locate the remaining 14 pin IC
- □ 43. Install the IC socket at the U2 location on the circuit board. Be careful to orient the socket correctly according to the "Parts Placement" section Figure 1.
- □ 44. Carefully bend over the four corner pins of the socket against the solder pads on the solder side of the board. Solder all pins in place.
- □ 45. Locate both LM747 op amp integrated circuits. Insert them into IC sockets for U 1 and U2. Please refer to the "Parts Placement" and Before You Start Building sections for proper orientation and placement. Be sure not to bend any of the pins underneath the IC body, and that all pins are inserted into the socket.
- □ 46. Locate the 4P4T slide switch (SW)
- □ 47. Inspect the slide switch for tarnished contacts. Remove any tarnish with very fine sandpaper so the contacts are nice and shiny. This will provide a good soldering surface.

**Note:** Please refer to the section titled "Parts Placement" Figures 2 and 3 for Steps 47 through 56.

- 48. Connect wire located at Point #4 to Point A on SW1. Solder in place and trim the lead.
- 49. Locate capacitor C9 (IOuF). This is an electrolytic type capacitor and will be marked "IOuF" with an arrow pointing to the negative end.
- 50. Trim the positive lead of C9 so about only 3/8" of the lead remains.
- 51. Connect the positive lead of C9 at Point B on SW1. Do not solder this switch contact yet.
- 52. Locate one (1) 6" insulated wire and cut it in half, making two (2) 3" wires.
- 53. Cut one (1) 3" wire in half making two (2) 1 1/2" pieces.
- 54. Using the wire strippers, remove about 1/4" of the insulation from each 1 1/2" pieces of wire.
- 55. Connect one (1) 1 1/2" piece of wire between Points B and E on SW1. Solder both ends in place and trim the excess from switch contact. lead the
- 56. Connect wire located at Point #3 to Point C on SW1. Solder place and trim the lead.
- 57. Connect wire located at Point #2 to Point D on SW1. Solder place and trim the lead.
- 58. Connect wire located at Point #1 to Point F on SW1. Solder place and trim the lead.

At this point, your kit is finished and it's time to take a well-earned break! When you come back, be sure to give your work a close "quality control" inspection.

#### **PC Board Inspection:**

Before applying power to your kit, give it a thorough QC (quality control) inspection. This will help you find inadvertent assembly errors that might prevent the filter from working or cause damage to sensitive parts. Follow this procedure:

- Compare parts locations against the parts-placement diagram. Was each part installed where it is supposed to be? Was the correct value used?

Start at one side of the board and work your way across in an organized pattern.

Inspect the solder side of the board for cold-solder joints and solder bridges between tracks or pads. Use a magnifying glass to obtain a clear view of the track area. If you suspect a solder bridge, hold the board in front of a bright light for a better view. All joints should be smooth and shiny, indicating good solder wetting and flow. Resolder any beaded or dull-appearing connections.

If you find a construction error and need to remove a part or two, it will be easier if you have the right tools. One very convenient item for freeing soldered-in parts is a "solder sucker". This consists of a suction bulb or a spring loaded vacuum pump that draws molten solder away from the pad and lead. Alternatively, you may use a special copper braid called "solder wick" (solder suckers and solder wick are both available at your local Radio Shack or electronics supply house). If you suspect you've damaged a component during removal, better to replace it than risk reusing it!

Finally, rosin flux can absorb moisture, which may cause a problem for some electronic equipment. To remove flux, use isopropyl alcohol (or 95% grain alcohol) and an old toothbrush. Apply a generous amount of alcohol with the toothbrush and scrub gently. Once the flux has fully dissolved, blot the bottom of the board dry with an untreated tissue. Give it a final alcohol wash, and allow to dry thoroughly.

**CAUTION: ALCOHOL IS HIGHLY FLAMMABLE AND MUST BE USED WITH ADEQUATE VENTILATION! USE SAFETY GOGGLES, AND AVOID PROLONGED SKIN CONTACT. IT'S ALSO BEST TO DO THIS OUTDOORS.**

Now that assembly and inspection is completed, you're ready to begin the testing and alignment phase of construction.

## TESTING AND ALIGNMENT

The best way to test the VEC-830K is with a calibrated audio signal generator and oscilloscope. However, the VEC-830K does not require any alignment. The filter has three switch selectable selectivity cutoff points, Hi-Pass, 2.5kHz, 2.0kHz, and 1.5kHz. The switch positions on SW1 from left to right are HiPass, 2.5kHz, 2.0kHz, and 1.5kHz. The 1.5kHz hertz cutoff is the fourth switch position from the left and is the narrowest filter cutoff, while the 2.5kHz cutoff is the second position from the left and is the widest filter cutoff.

Probably the best method of seeing if the VEC-830K is working, or not, is to listen to some "on the air" side-band signals. Then using SW1, select the filter cutoff position that best cleans up the signal being received.

Carefully tune in a weak signal with the filter in the HI-PASS position. The HI-PASS position is the left most switch position on SW1. Turn the filter on and experiment with the selectivity switch to obtain the cleanest signal. The 2.5kHz upper cutoff could be used when signals are not too cluttered with QRM and more fidelity is required. The 2.0kHz upper cutoff position will give you the best compromise between QRM reduction and fidelity. Where signals are really bad, with a lot of QRM, try the 1.5kHz upper cutoff. The 1.5kHz upper cutoff will slice off a large amount of the QRM at the expense of fidelity. The HI-PASS position will not affect the high frequencies and removes low frequencies below 375 hertz, including 60 and 120 hertz hum. The Hi-Pass filter is automatically in effect when using the 2.5kHz, 2.0kHz, and 1.5kHz positions.

## OPERATING INSTRUCTIONS

You may use the VEC-830K with any communications receiver or scanner. The VEC-830K requires a 9-volt battery power source.

There are a few items that you will need to operate the VEC-830K. We have provided a list of these items below for your convenience.

Communications Receiver or scanner with the proper cables.

9-Volt transistor radio battery

External speaker with clip leads

### Receiver or Scanner Operation

As mentioned previously you can use the VEC-830K with a communications receiver or scanner. The filter requires audio from the external speaker or headphones output of the receiver or scanner. The positive side of this audio signal is applied to the insulated wire connected to point on the circuit board labeled INPUT. The negative side of the audio is applied to the point on the circuit board labeled GND. Use the open end piece of insulated wire that is emerging from the junction point with the electrical tape. Please refer to the "Parts Placement" section, Figure I for the location of signal INPUT point.

Next, connect the POSITIVE lead of the external speaker to the NEGATIVE end of C9. Please refer to the "Parts Placement" section Figure 3 for the location of C9. Connect the NEGATIVE lead of the external speaker to the wire labeled GND on the circuit board. Again please refer to the "Parts

Placement" section Figure 1 for the location of the point labeled GND on the circuit board.

Next, turn the receiver volume all the way down, then clip the 9-volt battery to battery snap. Set SW 1 to the far left position (Hi-Pass). Now turn the receiver up slightly so you can hear the received signals on the external speaker. The signal you are listening to is the signal with the high frequencies unaffected, but all low frequencies below 375 hertz are removed. Using the tuning knob on the radio, go find a side-band signal. A good place to find side-band signals is in the Amateur Radio bands. Once you find a side-band signal, switch SW 1 to the different filter cutoff positions and notice the affect that the filter has on the received signal. As you progress through the filter cutoffs from 2.5kHz to 1.5kHz you will find the switch position that gives you the best sounding and cleanest signal.

## IN CASE OF DIFFICULTY

### No Signal Filtering:

A newly constructed filter that fails to work upon initial power up, generally requires a very close and careful inspection of all work. Please go back through all steps of assembly and inspection, referring to the "Parts Placement" Figures 1, 2, and 3. Most of the time there will be a part that is not installed or not installed properly, a wrong value part in place of another, or a broken part. A close inspection at this point will reveal some accidental mistake(s).

### Intermittent Filter Operation:

A filter that operates intermittently may have poor solder connections, a problem with broken wires, or low voltage power source. Self-oscillation, may be caused by a defective U1 or U2. Also check for dirty or intermittent switch operation.

### Filter Stops Filtering:

A working filter that fails "in-service" generally indicates a failure of one or both U1 or U2. If you suspect a bad U1 or U2, then **do not touch** the part with your fingers. If the part is bad, it could be HOT and could cause a serious burn. Other things that should be checked is the supply voltage of the 9-volt battery and/or broken wires to and from the circuit board and switch.

### No Speaker Audio:

No speaker audio can be a symptom of a bad SW 1, a broken wire or a bad C9. Also check the voltage from the 9-volt battery. A broken wire at the audio input to the filter can also attribute to no speaker audio.



If technical assistance or factory repair is desired, please refer to the warranty instructions on the inside front cover.

## THEORY OF OPERATION AND SPECIFICATIONS

### Operation:

The VEC-830K uses two UA747 operational amplifier integrated circuits to form four, flat cascaded Butterworth filter stages. Unlike passive filters using inductors, no impedance matching is necessary for optimum performance. Also, there is no insertion loss within the passband. This results in minimum amplitude distortion and unity passband gain for all selectivity settings.

### Specifications:

Filter Cutoffs: .....Hi-Pass, 2.5kHz, 2.0kHz, 1.5kHz

Insertion Loss: ..... None

Power Required: ..... 9-18 volts DC; 3-4mA typical

PC Board Dimensions: ..... 2" x 3"

## ENCLOSURE

Vectronics has designed a matching enclosure just for your VEC-830K SSB Audio Filter Kit. The matching enclosure is an all metal box which includes knobs, hardware, decals, and rubber feet. The Vectronics model number for matching enclosure is VEC-830KC.

