



**MOTOROLA INC.**

**test equipment**

**Communications  
System Analyzer  
OPERATOR'S MANUAL**

**R-2001D**

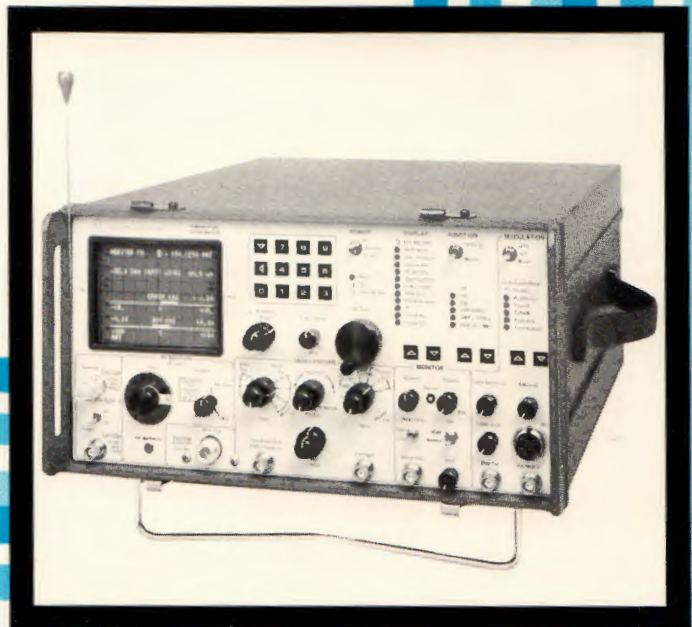

**MOTOROLA TEST EQUIPMENT PRODUCTS  
LIMITED WARRANTY  
(EXCLUDES EXPORT SHIPMENTS)**

Motorola Test Equipment Products (herein the "product") that are manufactured or distributed by Motorola Communications Group Parts Department are warranted by Motorola for a period of one (1) year from date of shipment against defects in material and workmanship.

This express warranty is extended to the original purchaser only. In the event of a defect, malfunction, or failure during the period of warranty, Motorola, at its option, will either repair, or replace the product providing that Motorola receives written notice specifying the nature of the defect during the period of warranty, and the defective product is returned to Motorola at 1313 East Algonquin Road, Schaumburg, IL 60196 transportation prepaid. Proof of purchase and evidence of date of shipment (packing list or invoice) must accompany the return of the defective product. Transportation charges for the return of the product to Purchaser shall be prepaid by Motorola.

This warranty is void, as determined in the reasonable judgement of Motorola, if:

- (a) The product has not been operated in accordance with the procedures described in the operating instruction;
- (b) The seals on non-user serviceable components or modules are broken;
- (c) The product has been subject to misuse, abuse, damage, accident, negligence, repair or alteration.

In no event shall Motorola be liable for any special, incidental, or consequential damages.

In the event Motorola elects to repair a defective product by replacing a module or subassembly, Motorola, at its option, may replace such defective module or subassembly with a new or reconditioned replacement module or subassembly. Only the unexpired warranty of the warranty product will remain in force on the replacement module or subassembly. EXCEPT AS SPECIFICALLY SET FORTH HEREIN. ALL WARRANTIES EXPRESS OR IMPLIED, INCLUDING ANY IMPLIED WARRANTY OF FITNESS FOR A PARTICULAR PURPOSE OR MERCHANTABILITY, ARE EXCLUDED.

EPS-30828-O

**SUPPORT SERVICES**

For service on your Motorola test equipment in the U.S. contact the Test Equipment Service Center, Schaumburg, 1313 E. Algonquin Rd., Schaumburg, Illinois 60196 or call the Test Equipment Service Hotline: 800/323-6967 during normal business hours. In Illinois call 1-312-576-7025. Outside the U.S. contact your nearest Motorola representative.

**MODULE EXCHANGE PROGRAM**

Modular construction of the R2001 allows field replacement of individual assemblies. Contact the Test Equipment Service Center for pricing and delivery. Outside the U.S. contact your nearest Motorola representative.

**COMPUTER SOFTWARE COPYRIGHTS**

The Motorola products described in this instruction manual may include copyrighted Motorola computer programs stored in semiconductor memories or other media. Laws in the United States and other countries preserve for Motorola certain exclusive rights for copyrighted computer programs, including the exclusive right to copy or reproduce in any form the copyrighted computer program. Accordingly, any copyrighted Motorola computer programs contained in the Motorola products described in this instruction manual may not be copied or reproduced in any manner without the express written permission of Motorola. Furthermore, the purchase of Motorola products shall not be deemed to grant either directly or by implication, estoppel, or otherwise, any license under the copyrights, patents or patent applications of Motorola, except for the normal non-exclusive, royalty free license to use that arises by operation of law in the sale of a product.

EPS-34440-B

Specifications subject to change without notice.

© Motorola, Private-Line, and Digital Private-Line are trademarks of Motorola, Inc.  
■ Printed in U.S.A. ■ © 1985 Motorola Inc.



**MOTOROLA**  
Communications  
Sector



# COMMUNICATIONS SYSTEM ANALYZER R-2001D



**Motorola Test  
Equipment Products**

1313 E. Algonquin Rd.  
Schaumburg, IL 60196

©Motorola, Inc. 1985  
All Rights Reserved  
Printed in U.S.A.

**68P81069A66-B**  
7/15/85 PHI

# TELEPHONE COMMUNICATIONS SYSTEM

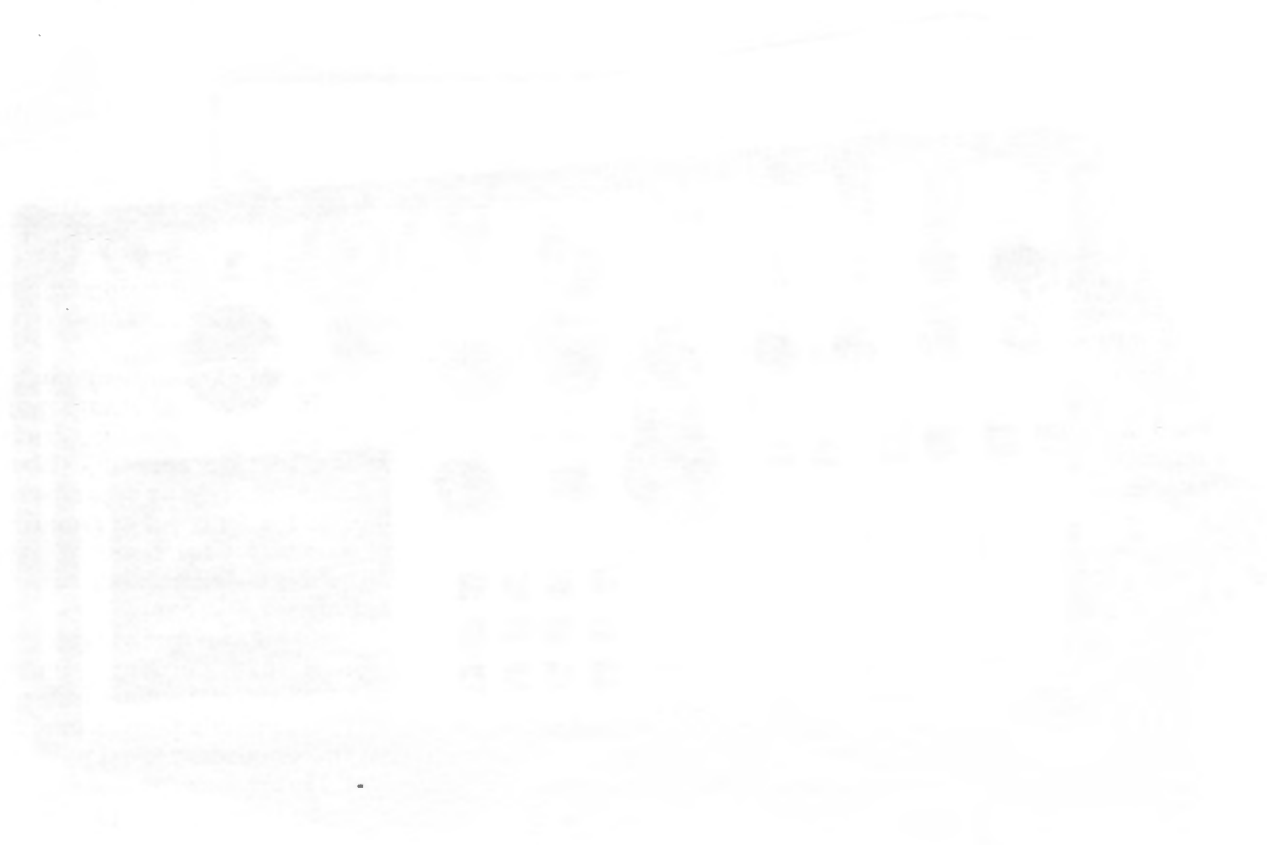



# SAFE HANDLING OF CMOS INTEGRATED CIRCUIT DEVICES

---

Many of the integrated circuit devices used in communications equipment are of the CMOS (Complementary Metal Oxide Semiconductor) type. Because of their high open circuit impedance, CMOS ICs are vulnerable to damage from static charges. Care must be taken in handling, shipping, and servicing them and the assemblies in which they are used.

Even though protection devices are provided in CMOS IC inputs, the protection is effective only against overvoltage in the hundreds of volts range such as are encountered in an operating system. In a system, circuit elements distribute static charges and load the CMOS circuits, decreasing the chance of damage. *However, CMOS circuits can be damaged by improper handling of the modules even in a system.*

To avoid damage to circuits, observe the following handling, shipping, and servicing precautions.

1. Prior to and while servicing a circuit module, particularly after moving within the service area, momentarily touch *both* hands to a bare metal earth grounded surface. This will discharge any static charge which may have accumulated on the person doing the servicing.

#### NOTE

Wearing Conductive Wrist Strap (Motorola No. RSX-4015A) will minimize static buildup during servicing.

---

#### WARNING

When wearing Conductive Wrist Strap, be careful near sources of high voltage. The good ground provided by the wrist strap will also increase the danger of lethal shock from accidentally touching high voltage sources.

---

2. Whenever possible, avoid touching any electrically conductive parts of the circuit module with your hands.

3. Normally, circuit modules can be inserted or removed with power applied to the unit. However, check the INSTALLATION and MAINTENANCE sections of the manual as well as the module schematic diagram to insure there are no objections to this practice.

4. When servicing a circuit module, avoid carpeted areas, dry environments, and certain types of clothing (silk, nylon, etc.) because they contribute to static buildup.

5. All electrically powered test equipment should be grounded. *Apply the ground lead* from the test equipment to the circuit module *before* connecting the *test probe*. Similarly, *disconnect the test probe prior* to removing the *ground lead*.

6. If a circuit module is removed from the system, it is desirable to lay it on a conductive surface (such as a sheet of aluminum foil) which is connected to ground through 100k of resistance.

---

#### WARNING

If the aluminum foil is connected directly to ground, be cautious of possible electrical shock from contacting the foil at the same time as other electrical circuits.

---

7. When soldering, be sure the soldering iron is grounded.

8. Prior to connecting jumpers, replacing circuit components, or touching CMOS pins (if this becomes necessary in the replacement of an integrated circuit device), be sure to discharge any static buildup as described in procedure 1. Since voltage differences can exist across the human body, it is recommended that only one hand be used if it is necessary to touch pins on the CMOS device and associated board wiring.

9. When replacing a CMOS integrated circuit device, leave the device in its metal rail container or conductive foam until it is to be inserted into the printed circuit module.

10. All low impedance test equipment (such as pulse generators, etc.) should be connected to CMOS

device inputs after power is applied to the CMOS circuitry. Similarly, such low impedance equipment should be disconnected before power is turned off.

11. Replacement modules shipped separately from the factory will be packaged in a conductive material. Any modules being transported from one area to another should be wrapped in a similar material (aluminum foil may be used). NEVER USE NON-CONDUCTIVE MATERIAL for packaging these modules.



# R-2001D Communications System Analyzer

## Specifications

<p><b>Signal Generator Mode</b></p> <p><b>Operating/Display Modes:</b> AM/FM/CW/SSB Monitor AM/FM/CW/DSBSC Generate Signalling Simulator Spectrum Analyzer Duplex Generator Memory Tables Frequency Counter Digital Voltmeter Wattmeter IF Display Oscilloscope Signal Strength Meter SINAD/Distortion Meter</p>	<p><b>Monitor Mode (Continued)</b></p> <p><b>DEVIATION MEASUREMENT</b> <b>Scales:</b> 1, 10, 100 kHz full scale <b>Accuracy:</b> ± 5% of reading <b>Peak Deviation Limit:</b> Set via keyboard to 100 Hz resolution (0 kHz to 99.9 kHz). Audible alarm indicates limit condition and will be active in all Monitor Modes.</p> <p><b>AM MODULATION MEASUREMENTS</b> <b>Range:</b> 0 to 100% <b>Accuracy:</b> ± 5% of reading</p> <p><b>SIGNAL STRENGTH METER</b> <b>Range:</b> 1 MHz to 999.9999 MHz <b>Sensitivity:</b> -100 dBm to +52 dBm, combined specification of antenna and transceiver ports. <b>Selectivity:</b> 30 kHz Max. @ 3 dB bandwidth</p> <p><b>RF WATTMETER</b> <b>Range:</b> .1 Watts to 125 Watts <b>Scales:</b> 9.99, 99.9, 125 Watts <b>Accuracy:</b> ± 10% from 1 Watt to 125 Watts <b>Protection:</b> Over-temperature</p>
<p><b>FREQUENCY</b> <b>Range:</b> 10 kHz to 999.9999 MHz <b>Resolution:</b> 100 Hz <b>Accuracy:</b> Refer to accuracy of master oscillator <b>Stabilization Time:</b> .1 Sec</p>	<p><b>General</b></p>
<p><b>OUTPUT</b> <b>Attenuator:</b> 16 dB variable plus 10 dB steps over 13 ranges <b>Range FM:</b> .1 <math>\mu</math>V to 1 VRMS <b>Range AM:</b> .1 <math>\mu</math>V to 4 VRMS <b>Accuracy:</b> ± 3 dB maximum with step attenuator in 0 dB position. ± 4 dB maximum in any other state</p>	<p><b>SPECTRUM ANALYZER</b> <b>Frequency Range:</b> 1 MHz to 1 GHz <b>Dynamic Range:</b> 75 dB minimum <b>Scan Width:</b> 100 kHz per division to 1 MHz per division continuously adjustable -95 dBm minimum <b>Sensitivity:</b></p>
<p><b>SPECTRAL PURITY</b> <b>Spurious:</b> -40 dBc <b>Harmonics:</b> -15 dBc</p>	<p><b>DUPLEX GENERATOR</b> <b>Frequency Offset:</b> 0 MHz to ± 10 MHz and fixed ± 45 MHz <b>Frequency Resolution:</b> 5 kHz <b>Frequency Accuracy:</b> ± .002% <b>Output Level:</b> -35 dBm minimum into 50 ohm load <b>Deviation Range:</b> 0 to ± 20 kHz peak <b>Frequency Response:</b> 5 Hz to 20 kHz, ± 3 dB</p>
<p><b>FREQUENCY MODULATION</b> <b>Deviation:</b> 0-75 kHz peak <b>Residual FM:</b> 20 Hz max. @ 300 to 3 kHz from <math>f_c</math> <b>Residual AM:</b> 1.0% max. @ 300 to 3 kHz from <math>f_c</math> <b>External/Internal Frequency Range:</b> 5 Hz to 20 kHz, ± 3 dB <b>Modes:</b> Internal, external, microphone or all simultaneously</p>	<p><b>OSCILLOSCOPE</b> <b>CRT Size:</b> 8 cm x 10 cm <b>Frequency Response:</b> DC to .5 MHz, 3 dB point <b>External Vertical Input Ranges:</b> 10 mV, 100 mV, 1V, 10V per div. <b>Sweep Rates:</b> 1 <math>\mu</math>s, 10 <math>\mu</math>s, .1 ms, 1 ms, .01 sec, .1 sec. per division <b>Synchronization:</b> Internal, normal, and automatic mode with adjustable trigger level.</p>
<p><b>AMPLITUDE MODULATION</b> <b>Range:</b> 0 to 80% from 1 to 500 MHz <b>External/Internal Frequency Range:</b> 5 Hz to 10 kHz, ± 3 dB <b>External Input:</b> Approx. 150 mV for 80% <b>Modes:</b> Internal, external, microphone or all simultaneously</p>	<p><b>FREQUENCY COUNTER</b> <b>Normal</b> <b>Range:</b> 10 Hz to 35 MHz <b>Display:</b> 5 digit autoranging <b>Input Sensitivity:</b> 50 mV minimum <b>Period Counting Frequency Determination</b> <b>Range:</b> 10 Hz - 100 kHz <b>Display:</b> 4 digit autoranging to 3 kHz, 3 digit autoranging to 100 kHz</p>
<p><b>DOUBLE SIDEBAND SUPPRESSED CARRIER</b> <b>Range:</b> 1 MHz to 500 MHz <b>Carrier Suppression:</b> -15 dB</p>	<p><b>Auto Tune (SCAN LOCK)</b> <b>Range:</b> In the monitor mode, the unit has the capability to automatically find and then tune to an input signal above -30 dBm. Operates from 1 MHz to 1 GHz <b>Acquisition Time:</b> 5 sec. typical to less than 1 sec. IF limited scan is utilized. <b>Accuracy:</b> ± 1 Hz of actual input frequency</p>
<p><b>SWEEP GENERATOR MODE</b> Adjustable sweep width from 10 kHz to 10 MHz at a fixed sweep rate. Synchronized to internal scope display.</p>	<p style="text-align: right;"><i>Specifications continued on next page</i></p>
<p><b>Monitor Mode</b></p> <p><b>Frequency Range:</b> 1 MHz to 999.9999 MHz <b>Resolution:</b> 100 Hz <b>Accuracy:</b> Equal to that of master oscillator time base</p> <p><b>FREQUENCY ERROR Indicator:</b> Autoranging CRT display. Resolution ± 10 Hz for frequency error measurements on 1.0 kHz, 10.0 kHz and 100.0 kHz full scale ranges. 1 Hz resolution for frequency error less than 100 Hz. Special function control will allow direct frequency readout to 1 Hz resolution.</p> <p><b>Input Sensitivity (over the 4 MHz to 999.9999 MHz range):</b> 1.5 <math>\mu</math>V for 10 dB EIA SINAD (narrow band ± 6 kHz mod. acceptance) 7.0 <math>\mu</math>V for 10 dB EIA SINAD (wide band ± 100 kHz mod. acceptance)</p> <p><b>Spurious Response:</b> -40 dB typical 0 dB image at ± 21.4 MHz -10 dB at L.O. harmonics ± 10.7 MHz</p>	

# R-2001D Communications System Analyzer

General (Continued)	
<b>DIGITAL VOLTMETER</b>	
<b>Readout:</b>	Autorangeing 3 digit display 1, 10, 100, 300 volt full scale
<b>DC Accuracy:</b>	± 1% of full scale ± 1 LSD
<b>AC Accuracy:</b>	± 5% of full scale
<b>AC Bandwidth:</b>	50 Hz to 20 kHz
<b>SIGNALLING SIMULATOR</b>	
<b>Modes of Operation:</b>	Encode and Decode capability for 1 kHz fixed tone Single Tone Variable Frequency Two-Tone sequential paging Universal 10 tone sequential Digital sub-audible squelch Base Station Tone Remote Mobile Telephone IMTS MTS 2805 Hz 5/6 tone paging Select V Signalling
<b>Frequency Range:</b>	5 Hz to 9999.99 Hz encode, 5.0 Hz to 9999.9 Hz decode
<b>Resolution:</b>	0.1 Hz, 5 Hz to 9999.9 Hz
<b>Output Level:</b>	3 Volts RMS into 600 ohm
<b>Input Impedance:</b>	10 K ohms minimum
<b>SINAD/DISTORTION METER</b>	
<b>Input Level:</b>	0.5 V to 10 Volts RMS
<b>SINAD Accuracy:</b>	± 1 dB at 12 dB SINAD
<b>Distortion Range:</b>	1% to 20%
<b>Distortion Accuracy:</b>	0.5% distortion in 1% to 10% range 2% distortion in 10% to 20% range
<b>ANALOG SYNTHESIZER TUNING (AST)</b>	
<b>Step Size:</b>	Variable steps from 3200 Hz to 3.2 GHz per 360° of rotation.
<b>Calibration:</b>	32 steps per 360° rotation (approximately)
<b>TIME BASE</b>	
<b>Standard TCXO:</b>	Aging: ± 1 x 10 <sup>-6</sup> per year Temp: ± 1 x 10 <sup>-6</sup> maximum error over the 0° to +55°C temperature range
<b>Optional Ovenized High Stability:</b>	Aging: ± 1 x 10 <sup>-6</sup> per year Temp: ± .05 x 10 <sup>-6</sup> maximum error over the 0° to +55°C temperature range. (Warmup to ± 5 x 10 <sup>-7</sup> of final frequency within 20 minutes)

General (Continued)	
Power and Environmental	
<b>AC:</b>	100 VAC to 130 VAC or 200 VAC to 260 VAC switch selectable 47 Hz to 63 Hz and 400 Hz + 11.0 to + 16 VDC external input
<b>DC:</b>	+ 11.0 to + 16 VDC external input
<b>Battery Option:</b>	13.6 Volts, 50 minutes typical
<b>Dimensions:</b>	8.25 in. high x 15.50 in. wide x 20.00 in. deep. (21 cm x 39.4 cm x 50.8 cm)
<b>Weight:</b>	35.5 pounds (basic model) excluding battery pack, cover accessories (16.1 kg)

## Model Nomenclature

R-2001D Basic Model
R-2001D/HS With high stability oscillator
R-2002D With IEEE-488 option
R-2002D/HS High stability oscillator and IEEE-488 Bus option
R-2004D With Motorola DES option
R-2004D/HS High stability oscillator and Motorola DES option
R-2005D With Motorola SECURENET option
R-2005D/HS High stability oscillator and Motorola SECURENET option
R-2008D With cellular option
R-2008D/HS High stability oscillator and cellular option
R-2009D With IEEE-488 Bus and cellular options
R-2009D/HS With high stability oscillator, IEEE-488 Bus and cellular option
R-2010D With UK cellular option
R-2010D/HS High stability oscillator and UK cellular option
R-2011D With IEEE-488 Bus and UK cellular option
R-2011D/HS High stability oscillator, IEEE-488 Bus, and UK cellular option
R-2021D With Motorola Trunked Radio option
R-2021D/HS High stability oscillator and Motorola Trunked Radio option
R-2045D With Motorola DES and SECURENET options
R-2045D/HS High stability oscillator and Motorola's DES and SECURENET options
NOTE: Factory set 220 Volt models are also available. Add "/220" to model number.

## Optional Accessories

RTP-1002A Battery Pack
RTL-4056B Protective Canvas Cover
RTL-4065A Transit Case
RTL-4075A RF Detector Probe
RTA-4000A Telescoping Antenna



**OPERATOR'S MANUAL  
COMMUNICATIONS SYSTEM ANALYZER R-2001D  
TABLE OF CONTENTS**

	<b>Page</b>		<b>Page</b>
Limited Warranty	ii	RF Sweep Generator	3-5
Safe Handling	v	Monitor Mode	3-5
Specifications	vii	Special Function Mode	3-6
Table of Contents	ix	Special Function Control Codes	3-7
List of Illustrations	xi	Auto Tune Mode	3-8
List of Tables	xii	Scan Latch Mode	3-8
List of Abbreviations	xiii	Monitor Section	3-8
<b>Section 1 – Introduction</b>		Volume And Squelch Controls	3-8
Scope of Manual	1-1	Off-The-Air Monitor	3-8
Service	1-1	Signal Strength Meter	3-8
Test Equipment Service Centers	1-1	FM Demodulation	3-8
Replacement Parts Orders	1-2	Audio Filters	3-9
Area Parts Offices	1-2	AM Demodulation	3-9
Installation	1-3	Single Sideband Demodulation	3-9
Packing	1-3	Audio Monitor	3-9
Initial Set-up	1-3	Modulation	3-9
Battery Pack	1-3	Spectrum Analyzer	3-9
Trace Rotation Adjustment	1-3	Duplex Generator	3-10
Accessories	1-4	RF Memory	3-10
<b>Section 2 – Description</b>		Entry With Memory Table	3-11
Description	2-1	Entry Without Memory Table	3-11
Front Panel	2-2	Preset Turn-On	3-11
Rear Panel	2-10	Signaling Sequence	3-11
Bottom Panel	2-10	Signaling Sequence Menu	3-11
<b>Section 3 – Operation</b>		Decode Mode Screens	3-11
General	3-1	PL Decode	3-12
Power Section	3-1	DPL Decode	3-13
Self-Test	3-1	A/B Encode	3-13
Keypad	3-1	Two-Tone Sequential Paging	3-13
CRT Display Screen	3-2	5/6 Tone Encode	3-13
System Warnings	3-2	Cap Codes	3-14
Function Section	3-2	5/6 Tone Decode	3-14
Modulation Section	3-3	Select V Encode	3-14
Fixed 1 KHz Tone	3-3	Select V Decode	3-15
Code Synthesizer	3-3	General Encode	3-15
Modulation/Function	3-3	General Decode	3-15
External Level	3-4	Mobile Telephone Signaling	3-15
Display Section	3-4	IMTS Mobile Originated	3-16
Generate/Monitor Metering	3-4	IMTS Base Originated	3-16
Generate	3-4	MTS Mobile Telephone	3-16
RF Level	3-4	2805 Base Originated	3-17
RF Output Level	3-4	Tone Sequence	3-17
Generate Mode	3-5	Tone Remote (Encode)	3-17
RF Scan Control	3-5	Tone Remote (Decode)	3-17
Analog Synthesizer Tuning (AST)	3-5	Frequency Counter	3-18
		(DVM/DIST) Digital Voltmeter/Distortion Mode	3-18
		External Wattmeter	3-19
		Intermediate Frequency (IF) Mode	3-19
		Oscilloscope Section	3-20
		Scope AC or Scope DC	3-20
		Addendum – Self Test Displays	3-21

	<b>Page</b>
<b>Section 4 – Applications</b>	
Service Shop Setups	4-1
Receiver Sensitivity Test, 12 DB SINAD, Audio Distortion	4-3
Receiver Sensitivity Test, 20 DB Quieting	4-5
Squelch Sensitivity Test	4-7
Audio Power Output Test	4-7
Audio Frequency Response	4-9
Modulation Acceptance Bandwidth	4-9
RF Preselector Shape and Bandwidth	4-11
Receiver Frequency Adjustment	4-13
Basic FM Transmitter Tests: Power, Frequency, & Deviation	4-15
Basic Terminated Measurements	4-15
Off-The-Air Measurements	4-15
“In-Line” Power Measurements	4-16
Audio Distortion	4-19
Audio Frequency Response	4-21

	<b>Page</b>
AM Modulation Test	4-23
AM Modulation Linearity Test	4-24
Analyzer IF DISPLAY	4-25
Community Repeater Modulation	4-26
Wire Line Remote Base Modulation	4-28
Wire Line Remote Base; Phone Line Levels	4-30
Phone Line Levels	4-30
Transmit Line Input	4-30
Receive Line Input	4-30
Measuring Levels Across A Balanced Line	4-32
Generating Signals Across A Balanced Line	4-34
Bandpass Cavity Tuning	4-36
Cavity & Duplexer Tuning; Bandpass Adjustment	4-38
Passband Adjustment	4-38
Adjustment of Reject Notch On Receive Leg	4-40
Adjustment of Reject Notch On Transmit Leg	4-42
Desensitization Test: In-Service Duplexer	4-44
Ferrite Isolator Test	4-46
Service Request Form	4-49

## LIST OF ILLUSTRATIONS

Figure		Page
	Communications System Analyzer R-2001D	iii
1-1	Communications System Analyzer R-2001D	1-1
1-2	Typical Packaging - Communications System Analyzer	1-3
2-1	Front Panel Controls, Indicators, and Connectors	2-1
2-2	Rear Panel	2-9
3-1	Power Controls	3-1
3-2	Keypad	3-1
3-3	Cathode Ray Tube Display Screen	3-2
3-4	Function Section	3-2
3-5	CW Display	3-2
3-6	AM Display	3-2
3-7	SSB Display	3-3
3-8	SWP Display	3-3
3-9	Modulation Section	3-3
3-10	Display Modes	3-4
3-11	RF Section	3-4
3-12	Generate Mode Metering Display	3-4
3-13	RF Scan Control	3-5
3-14	Monitor Mode Metering Display	3-6
3-15	Monitor Section	3-8
3-16	Modulation Display	3-9
3-17	Spectrum Analyzer Display	3-9
3-18	Duplex Generator Section	3-10
3-19	Duplex Generator Display	3-10
3-20	RF Memory Display	3-10
3-21	Signaling Sequence Menu Display	3-11
3-22	Private Line Decode Display	3-12
3-23	DPL Decode Display	3-13
3-24	Two Tone (A/B) Encode Display	3-13
3-25	5/6 Tone Encode Display	3-13
3-26	5/6 Tone Decode Display	3-14
3-27	Select V Encode Display	3-14
3-28	Select V Decode Display	3-15
3-29	General Encode Display	3-15
3-30	General Decode Display	3-15
3-31	IMTS Mobile Originated Display	3-16
3-32	IMTS Base Originated Display	3-16
3-33	MTS Mobile Telephone Display	3-16
3-34	2805 Base Originated Display	3-17

Figure		Page
3-35	Frequency Counter Display	3-17
3-36	AC DVM Display	3-18
3-37	DC DVM Display	3-18
3-38	Distortion Analyzer Display	3-19
3-39	External Wattmeter Display	3-19
3-40	Oscilloscope Section	3-20
3-41	Destructive RAM Test Error Screen	3-21
3-42	Non-volatile RAM Error Screen	3-21
3-43	Checkerboard Pattern	3-21
3-44	Non Destructive RAM Test Error	3-22
3-45	Checksum Error Screen	3-22
4-1	12 DB SINAD Test Setup and Display	4-2
4-2	20 DB Quieting	4-4
4-3	Squelch Sensitivity Test Setup	4-6
4-4	Audio Frequency Response; EIA Standard RS-204C	4-8
4-5	Probe Setup	4-10
4-6	Frequency Adjustment Setup	4-12
4-7	Transmitter Tests Setup	4-14
4-8	Transmitter Test Setup; Power Measurements	4-17
4-9	Audio Distortion Setup	4-18
4-10	Audio Frequency Response Setup	4-20
4-11	Audio Frequency Response; EIA Standard RS-152B	4-21
4-12	AM Modulation Test Setup	4-22
4-13	AM Modulation Linearity Test Setup	4-24
4-14	Analyzer IF DISPLAY	4-25
4-15	Community Repeater Modulation Setup	4-27
4-16	Modulation Setup; Remote Base	4-29
4-17	Phone Line Levels Setup	4-31
4-18	BALUN Setup; Measuring Levels	4-33
4-19	BALUN Setup; Generating Signals	4-35
4-20	Bandpass Cavities Setup	4-37
4-21	Duplexer Passband Adjustment Setup	4-39
4-22	Duplexer Adjustment Setup; Reject Notch On Receive Leg	4-41
4-23	Duplexer Adjustment Setup; Reject Notch On Transmit Leg	4-43
4-24	Desensitization Test Setup	4-45
4-25	Ferrite Isolator Test Setup	4-47

## LIST OF TABLES

Table		Page
2-1	Controls, Indicators, and Connectors	2-2
3-1	Modulation/Function Availability	3-3 & 3-4
3-2	RF Output Level At Antenna Port	3-4
3-3	Special Function Control Codes	3-7
3-4	Audio Filter Characteristics	3-9
3-5	Valid PL Codes	3-12
3-6	Valid DPL Codes	3-13

Table		Page
3-7	Cap Codes	3-14
3-8	Select V Sequence Specification	3-14
3-9	IMTS Error Messages	3-16
3-10	Tone B Functions	3-17
3-11	Valid Input Frequency Versus Display Resolution	3-18
3-12	External Wattmeter Elements	3-19

## LIST OF ABBREVIATIONS

A	Ampere	GEN	Generate
AC	Alternating Current	GHz	Gigahertz
AM	Amplitude Modulation		
ANT	Antenna	Horiz	Horizontal
AST	Analog Synthesizer Tuning	HPFL	High Pass Filter
ATTEN	Attenuation	HS	High Stability
AUTO	Automatic	Hz	Hertz
BALUN	Balanced-to-unbalanced	IC	Integrated Circuit
BAT or Batt	Battery	ID	Identification Number
BFO	Beat Frequency Oscillator	IDC	Instantaneous Deviation Control
BNC	Bayonet Type Connector	IEEE	Institute of Electrical and Electronics Engineers
B.O.	Base Originated	IF	Intermediate Frequency
B.O.S.	Behorden Organisationen mit Sicherheit-saufgaben, (a German Standards Association)	IM	Intermodulation
		IMTS	Improved Mobile Telephone System
BW	Bandwidth	in.	Inches
		I/O	Input/Output
C	Celsius	Kohm	Kilohm
Cal	Calibrate	kg	Kilograms
CCIR	International Radio Consultative Committee	KHz	Kilohertz
C&E	Communications and Electronics (part of Motorola)	LED	Light-Emitting Diode
cm	Centimeters	LPFL	Low Pass Filter
CMOS	Complementary Metal Oxide Semiconductor	Lvl	Level
CONN	Connect	MAX	Maximum
Cont	Continuous	MHz	Megahertz
CRT	Cathode Ray Tube	MIC or mic	Microphone
CW	Continuous Wave	MIN	Minimum
		M.O.	Mobile Originated
		MOD	Modulation
		MOD.	Modified
		MON or Mon	Monitor
		us	Microsecond
		ms	Millisecond
		MSEC	Millisecond
		Mtr	Metering
		MTS	Mobile Telephone System
		MV or mV	Millivolts
		uV	Microvolts
		mW	Milliwatt
		NA or N/A	Not Applicable
		NB	Narrow Bandwidth
		NEG	Negative
		No.	Number
		#	Number
		ORIG	Originated
		PCT	Percent
		PL	Private Line, a Motorola registered trademark
		PN	Part Number
		POS	Position
E/D	Encode/Decode		
EEA	Electronic Engineering Association		
EIA	Electronics Industry Association		
Ext	External		
FM	Frequency Modulation		
FREQ	Frequency		
FWD	Forward		

pos	Positive	TCXO	Temperature Compensated Crystal Oscillator
+/-	Plus or minus	TEL	Telephone
R	Resistor	Temp	Temperature
REF	Reference	TN	Tone
REV	Reverse	Trig	Trigger
RF	Radio Frequency	TX	Transmitter
RMS or rms	Root-Mean-Square	UHF	Ultra High Frequency
Rptr	Repeater	UUT	Unit Under Test
RS	Receiver Specification	V	Volts
SEC or sec	Second	VAC	Volts Alternating Current
SEL	Select	VCE	Voice
SENS	Sensitivity	VDC	Volts Direct Current
SEQ or seq	Sequence	Vert	Vertical
Sig	Signal	VRMS	Volts (root-mean-square)
SINAD	Ratio of $\frac{\text{Signal} + \text{Noise} + \text{Distortion}}{\text{Noise} + \text{Distortion}}$	VSWR	Voltage Standing Wave Ratio
SSB	Single Sideband	W	Watts
STD	Standard	WB	Wide Bandwidth
SW	Switch	XY	(Select Any Valid Number)
SWP	Sweep	ZVEI	Zentral-Verband der Elektro-Industrie, (a German Electronics Industry Association)
syncs	Synchronizes		



# SECTION 1 INTRODUCTION

## 1.1 SCOPE OF MANUAL

This manual contains information for using the portable Communications System Analyzer R-2001D shown in figure 1-1. The Analyzer incorporates many devices and functions for the technician to completely monitor and service radio communications equipment in the shop and in the field.

## 1.2 SERVICE

Motorola Test Equipment Service Centers service all test equipment supplied by the Motorola Communications Sector. The Center maintains a stock of original equipment replacement parts and a complete library of service information. The Center performs most in-warranty repairs. For some equipment, not manufactured by Motorola, the original supplier performs repairs under the Center's direction. The Center performs out-of-warranty repairs on a time and materials basis at competitive rates. Contact the Motorola Test Equipment Service Center, toll free at (800) 323-6967 or at (312) 576-7025 in Illinois. Frequently, under the direction of the Center via telephone, a technician troubleshoots equipment to isolate a defective module. The Center then ships an exchange module immediately.

## MOTOROLA TEST EQUIPMENT SERVICE CENTERS

**MOTOROLA C & E PARTS**  
Test Equipment Service Center  
1313 E. Algonquin Rd.  
Schaumburg, IL 60196  
Phone: 800-323-6967  
Phone: 312-576-7025 (Illinois)  
MAMS: NAGOU  
TTY: 910-693-0869

**MOTOROLA WEST COAST**  
Test Equipment Service Center  
2333 B. Utah Ave.  
El Segundo, CA 90245  
Phone: 213-536-0784

**MOTOROLA C & E, INC.**  
Hawaii Service Center  
99-1180 Iwaena St.  
Aiea, HI 96701  
Phone: 800-487-0033  
TTY: 63212

*Handwritten notes:*  
Karey (box)  
Cable 575-  
Max repair 1375  
incl. cables  
Est. 55- (1/2 hr)  
need ROM

*Handwritten notes:*  
West Coast Control  
# 18-80346A13  
147

*Handwritten notes:*  
Parts  
1-800-422-4210  
Serv. West.  
RLN 4073A  
250



**FIGURE 1-1.**  
**COMMUNICATIONS SYSTEM ANALYZER R-2001D**

## MOTOROLA TEST EQUIPMENT SERVICE CENTERS

MOTOROLA AUSTRALIA PTY. LTD.  
Test Equipment Service Center  
666 Wellington Rd.  
Mulgrave, VIC 3170  
Melbourne  
Phone: 3-561-3555  
Telex: 32516 MOTOCOMA AA  
Cable: MOTOCOM MELBOURNE  
MAMS: FEMEL

MOTOROLA CANADA, LTD.  
Test Equipment Service Center  
3420 Pharmacy Ave.  
Unit 11  
Scarborough, Ontario MIW 2P7  
Phone: 416-499-1441  
TTY: 610-492-2713  
MAMS: NAWIL

MOTOROLA FRANCE S.A.  
Test Equipment Service Center  
Zone Industrielle de la Petite  
Montagne Sud  
14 Allee du Cantal CE 1455  
F-91020 Evry Cedex  
Phone: (6) 07779025  
Telex: 600434F MOTEV  
MAMS: FAFEV

MOTOROLA GmbH  
F and V. ABT. Frachtzentrum FZF  
6000 Frankfurt Main/Flughafen  
West Germany  
Attn: METEC  
Phone: (0) 6128-702130  
Telex: (0) 4182761 MOT D

MOTOROLA SOUTH AFRICA (PTY.) LTD.  
Motorola House  
5th St.  
P.O. Box 39586  
Wynberg  
Phone: 011-786-6165  
Telex: 422-070-SA  
Cable: MOTOROLA JOHANNESBURG  
MAMS: FESAF

### 1.3 REPLACEMENT PARTS ORDERS

Send orders for replacement parts to the nearest Motorola Area Parts Office or Test Equipment Service Center. Be sure to include the complete identification number located on the equipment. Direct inquiries to the Area Parts Office including requests for part number identification and test equipment calibration or repair.

## MOTOROLA AREA PARTS OFFICES

MOTOROLA C & E PARTS  
1313 E. Algonquin Rd.  
Schaumburg, IL 60196  
Phone: 800-323-6967  
312-576-3900

## MOTOROLA AREA PARTS OFFICES

EASTERN AREA PARTS  
85 Harristown Rd.  
Glenrock, NJ 07452  
Phone: 201-444-9662  
TWX: 710-988-5602

EAST CENTRAL AREA PARTS  
12995 Snow Rd.  
Parma, OH 44130  
Phone: 216-433-1560  
TWX: 810-421-8845

GULF STATES AREA PARTS  
1140 Cypress Station  
P.O. Box 73115  
Houston, TX 77090  
Phone: 713-537-3636  
TWX: 910-881-6392

MID-ATLANTIC AREA PARTS  
7230 Parkway Drive  
Hanover, Maryland 20176  
Phone: 301-796-8763  
TWX: 710-862-1941

MIDWEST AREA PARTS  
1313 E. Algonquin Rd.  
Schaumburg, IL 60196  
Phone: 312-576-7430  
TWX: 910-693-0869

PACIFIC SOUTHWESTERN AREA PARTS  
P.O. Box 85036  
San Diego, CA 92138  
Phone: 714-578-8030  
TWX: 910-335-1516

SOUTHEASTERN AREA PARTS  
P.O. Box 368  
Decatur, GA 30031  
Phone: 504-987-2232  
TWX: 810-766-0876

SOUTHWESTERN AREA PARTS  
P.O. Box 34290  
3320 Belt Line Rd.  
Dallas, TX 75234  
Phone: 214-620-8511  
TWX: 910-860-5505

WESTERN AREA PARTS  
1170 Chess Drive, Foster City  
San Mateo, CA 94404  
Phone: 415-349-8621  
TWX: 910-375-3877

MOTOROLA CANADA LTD.  
National Parts Department  
3125 Steeles Ave., East  
Willowdale, Ontario M2H 2H6  
Phone: 416-499-1441  
TWX: 610-491-1032  
Telex: 06-526258

## ALL OTHER COUNTRIES:

MOTOROLA INC.  
International Parts Dept.  
Schaumburg, IL 60196 U.S.A.  
Phone: 312-576-6482  
TWX: 910-693-0869  
Telex: 722443  
Cable: MOTOL PARTS

## 1.4 INSTALLATION

### • PACKING

Foam pieces protect the Communications System Analyzer packed inside a fiberboard carton. As shown in figure 1-2, the unit is then packed in a larger container for additional protection. Save the packing containers and materials for future use.

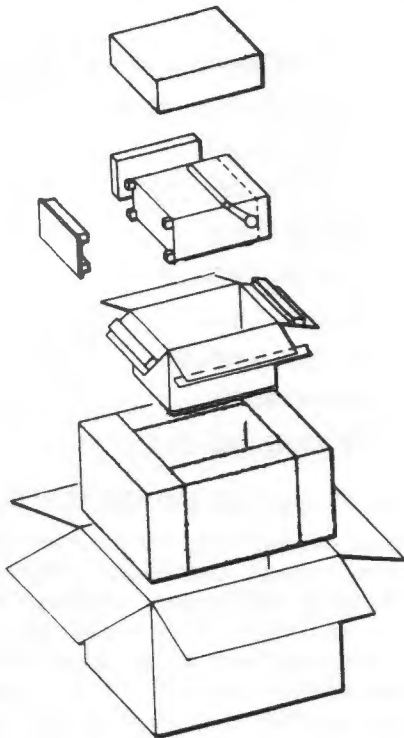

**FIGURE 1-2. TYPICAL PACKAGING-COMMUNICATIONS SYSTEM ANALYZER**

### • INITIAL SET-UP

Place the Analyzer on a workbench in the shop or mobile repair unit. Lower the bail underneath to raise the Analyzer for easier viewing. Open the two latches on the bottom of the cover, lift and slide the cover to the side to separate the hinges. Remove the front cover. Take the power cord (AC or DC) that is stored in the cover. Attach the cord's female connector to the ap-

propriate connector on the Analyzer's rear panel. Connect the cord's other end to the power source. For AC, use a grounded 3-wire 100-130 VAC or 200-260 VAC power source. On the back panel's two-position LINE switch, select either 110 or 220 position. The factory sets the LINE switch, as ordered. Units ordered as R-2001D/220 or R-2002D/220 will be pre-set for 220 VAC and will have a 3.0A fuse installed. Install a 3A fuse for 110 VAC operation and a 10A fuse for DC operation.

<u>OPERATION</u>	<u>FUSE</u>	<u>PART NUMBER</u>
110/220 VAC	3 A	65-20404
12 VDC	10 A	65-10266

Remove accessories from the cover as needed. Insert the whip antenna into the Antenna port located in the Duplex Generator section of the front panel. Pull the Antenna control located in the RF SECTION. Turn POWER switch, located on the front panel, to the On position. When the Oven Ready indicator illuminates, the frequency standard stabilizes and the Analyzer is ready for use instantaneously (with standard TCXO). Before operating the Analyzer, carefully study the function and purpose of each control and feature. Become familiar with the operating procedures described in this manual.

### CAUTION

When installing the Analyzer in a vehicle, fuse the DC supply line close to the vehicle's battery. The DC-10A fuse, located on the Analyzer's rear panel, protects it against overload but does not protect the vehicle.

### • BATTERY PACK

Attach the battery pack to the Analyzer's rear panel with 2 clips and 2 screws. Align and slide the pack's mounting clips into the slots on the mounting brackets on the left side. Align the captive screws with the mounting holes on the right side and tighten them. Connect the power plug to the connector at the top right of the rear panel.

### • TRACE ROTATION ADJUSTMENT

Set DISPLAY to Gen/Mon Mtr. Adjust intensity and focus control to obtain a comfortable viewing brightness. Remove the fine screws from the Analyzer's rear panel and remove the top panel. To re-align a tilting display screen, locate R-88 the third potentiometer located on the A-2 module behind the front panel. Insert the tuning tool in the resistor and slowly rotate it while observing the front of the screen. Rotate the tool until the bargraph line is parallel with the center horizontal graticule line. Replace the panels and tighten the screws.

## • ACCESSORIES SUPPLIED

**FRONT COVER** — The front cover protects the front panel and its components during transit or while the Analyzer is not in use. The front cover stores the power cord, antenna, cables, and other equipment needed for on-site servicing. PN #15-80335A70.

**ANTENNA** — The fused BNC connected antenna receives off-the-air signals. PN #TEKA-24A.

**BNC to Type N Adapter.** PN #58-84300A98.  
**DC POWER CONNECTOR KIT.** PN #RPX-4097A.  
**In-Line Wattmeter Adapter.** PN #RTL-4055B.

**MANUAL** — The Operator's Manual contains descriptions and instructions for properly using the Analyzer. PN #68P81069A66-0.

**Oscilloscope & Meter Probe** — A probe (x1), with attachments, provides general servicing needs. PN #RTL-4058A.

**POWER CORD** — The three-conductor cord powers the Analyzer by AC and charges the optional battery pack. Its right-angle design allows the Analyzer to stand on end. PN #30-80336A36.

**SUN SHADE** — Snap the Sun Shade over the CRT screen to observe displays even in bright sunlight. PN #15-80335A55.

**TEST MICROPHONE.** PN #RTM-4000B.

**12 VDC POWER CONNECTOR KIT.** PN #RPX-4097A.

## • OPTIONAL ACCESSORIES

**BATTERY PACK** — A 13.6 volt battery attaches directly to the back of the Analyzer to provide 50 minutes of continuous operation. Built-in circuitry charges the battery when the power switch is in Off or Standby position. If battery power falls below 11 volts, a warning appears on the CRT. The battery can be installed in the field but it cannot be used in conjunction with IEEE-448 Interface Bus or Blower. PN #RTP-1002A.

**DELUXE TELESCOPING ANTENNA.** PN #RTA-4000A.

**600 OHM LINE MATCHING TRANSFORMER** — Use for 600 ohm balanced lines. PN #RTL-1003A.

**PROTECTIVE CANVAS COVER** — A rugged, padded fabric cover protects the Analyzer from excessive field wear. PN #RTL-4056B.

**RF DETECTOR PROBE,** PN #RTL-4075A.

**TRANSIT CASE.** PN #RTL-4065A.

## • MODEL OPTIONS

• Cellular Test Functions — Model R-2008D provides capability in one test instrument for servicing traditional FM communications and, with the cellular option, the new cellular radio systems:

- CELL-TO-MOBILE SIGNALING ACCEPTANCE TESTS
- MOBILE-TO CELL SIGNALING ACCEPTANCE TESTS
- AUTOMATIC RF TESTS
- MANUALLY SELECTED RF TESTS.

• High Stability (HS) Oscillator — Use this oscillator to improve stability over the standard TCXO time base to  $\pm 5 \times 10^{-8}$  maximum error, over the temperature range of 0 to 55°C. A front panel LED (Oven Ready) indicates when the ovenized crystal has stabilized.

### MODELS (See Specifications)

R-2001D Basic Model

R-2001D/HS

R-2001D/HS/220

R-2002D/HS

R-2002D/HS/220

R-2008D/HS

R-2008D/HS/220

R-2009D/HS

R-2009D/HS/220

## • IEEE-488 STANDARD INTERFACE BUS

This option enables using the Analyzer as a programmable measurement instrument. For example, Analyzer Model R-2002D when combined with the suitable programmable controller and applications software becomes the heart of an automated RF test system. Control or monitor all of the Analyzer's functions via the IEEE Bus. Perform full sequential test routines, quickly and repetitively, with little operator interaction.

## • MODULE SERVICE KIT

The Extender Board Kit aids servicing the Analyzer's modules with printed circuit board edges. Use with A2, A3, A4, A5, A6, A7, A9, and A12 modules. PN #RPX-4379A.

# SECTION 2 DESCRIPTION

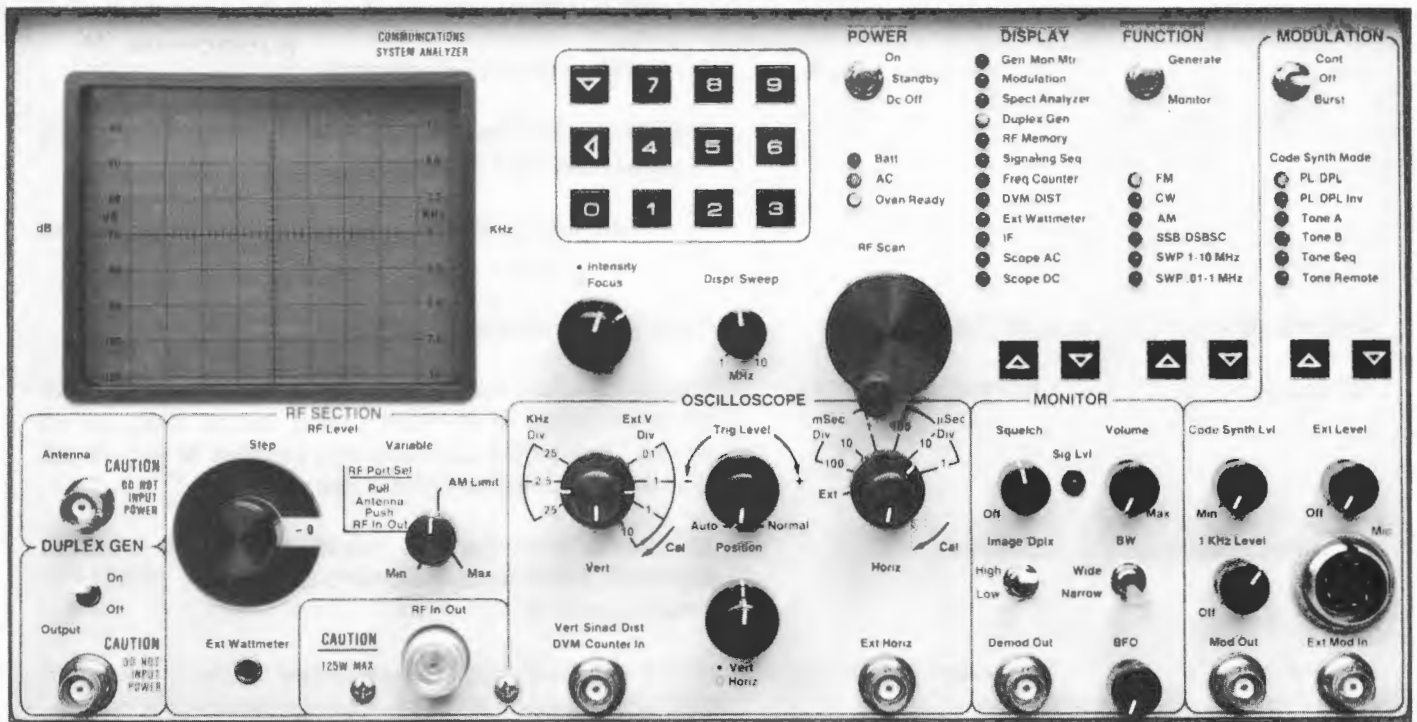



**FIGURE 2-1. FRONT PANEL CONTROLS, INDICATORS, AND CONNECTORS.**

## 2.0 DESCRIPTION

The R-2001D Communication System Analyzer shown in figure 2-1, is a portable test instrument designed to monitor and service radio communications equipment over the frequency range of 1 MHz to 1 GHz. Table 2-1 lists the Analyzer's controls, indicators, connectors and their functions. The Analyzer generates signals, measures modulation and frequency errors, and performs a variety of tests normally associated with the following devices:

- Spectrum analyzer
- Duplex offset generator
- Modulation oscilloscope
- Frequency counter
- AC/DC digital-analog voltmeter
- RF wattmeter
- General purpose oscilloscope
- Multimode code synthesizer
- Sweep generator
- Signaling encoder/decoder
- Signal strength meter
- Automatic scan latch counter.

**TABLE 2-1. CONTROLS, INDICATORS, AND CONNECTORS**

ITEM	DESCRIPTION	FUNCTION
FRONT PANEL (figure 2-1)		
Power	Three-position toggle switch	<p>On position energizes all circuitry.</p> <p>Standby position removes DC from all circuitry except the frequency standard and battery charger.</p> <p>At off, the battery charges if equipment is connected to an AC power source.</p>
Batt indicator	LED (red)	Illuminates when equipment uses DC power.
AC indicator	LED (red)	Illuminates when equipment is connected to an AC power source. Position of POWER switch has no effect on indicator. Equipment automatically switches to AC power source when connected to AC line voltage.
Oven Ready indicator	LED (red)	Illuminates when optional frequency standard oven has stabilized. Continuously illuminated with the TCXO frequency standard.
KEYPAD	Twelve-key pushbutton keypad	Enters variables into microprocessor memory and onto CRT screen, selects variables from the memory for display, changes previous entries.
	Line cursor key	Moves the cursor down only to the next available line on the screen, skips preset permanent entries, from the last line it returns to the top line.
	Horizontal cursor key	Moves the horizontal cursor left to the next available position that may be changed. From the last left position, the cursor moves to the far right with the next entry.
0 through 9	Numerical keys	Enter a value directly or select a value stored in the memory.
CRT	Cathode Ray Tube	8 cm x 10 cm screen displays all functions, generated or monitored, in both analog and digital form. Also displays all control settings and numerical values, entered or preset.
• Intensity	Stacked concentric potentiometers: Small center knob	Controls display intensity.
° Focus	Large outside knob	Controls display focus.
Dispr/Sweep Control	Potentiometer	Controls the frequency span (1-10 MHz) during Spectrum Analyzer DISPLAY. Provides sweep width control during SWP FUNCTION (0.01-1 MHz or 1-10 MHz).
RF Scan Control	Analog Synthesizer Tuning (AST)	Manually scan any displayed frequency by rotating this control clockwise or counterclockwise at the rate of 32 frequency steps per revolution. Position of display cursor determines step size.



**TABLE 2-1. CONTROLS, INDICATORS, AND CONNECTORS**

ITEM	DESCRIPTION	FUNCTION
FRONT PANEL (figure 2-1)		
DISPLAY indicators	Twelve LED's	<p data-bbox="813 300 1487 422">Illuminate one at a time to indicate the function or type of operation the equipment is performing and displaying on the CRT. Select by pressing one of the arrow keys under the DISPLAY section.</p> <ol data-bbox="854 457 1487 1843" style="list-style-type: none"> <li data-bbox="854 457 1487 611">1. Gen/Mon Mtr – In generate mode, the CRT displays center frequency, output power, and RF output modulation depth. In monitor mode, the CRT displays center frequency, input power, frequency error, and received carrier modulation depth.</li> <li data-bbox="854 646 1487 737">2. Modulation – The CRT displays modulation audio in generate mode or demodulated audio in monitor mode.</li> <li data-bbox="854 772 1487 957">3. Spectrum Analyzer – CRT displays the RF spectrum and operating center frequency. Use the Spectrum Analyzer to identify interference, trace RF and IF signals, measure transmitter harmonics, check spurious response and receiver local oscillator radiation.</li> <li data-bbox="854 993 1487 1304">4. Duplex Gen – CRT displays duplex generate frequency and modulation depth on the generator output or monitor frequency and modulation depth on the received carrier. FUNCTION switch position selects the reading. In this mode, the Analyzer simultaneously generates and receives signals for duplex radio servicing. The Duplex Generator provides enhanced capability to service equipment such as repeaters, car telephones and emergency medical telemetry portables.</li> <li data-bbox="854 1339 1487 1402">5. RF Memory – Stores and displays programmable frequencies and codes up to a total of 32 entries.</li> <li data-bbox="854 1438 1487 1591">6. Signaling Sequence – Simulates encode and decode tone sequence for all code synthesizer modes. Press an arrow key in the Modulation section to select one of the six modes. Encode in generate function and decode in monitor function.</li> <li data-bbox="854 1627 1487 1843">7. Frequency Counter – Measures 10 Hz to 35 MHz inputs in either generate or monitor function. In monitor function, measure transmitted carrier frequency and other signals less than 35 MHz. Use the frequency counter to measure and set offset oscillators, pager IF's, PL frequencies, and other external input signals.</li> </ol>

**TABLE 2-1. CONTROLS, INDICATORS, AND CONNECTORS**

ITEM	DESCRIPTION	FUNCTION
FRONT PANEL (figure 2-1)		
		<p>8. DVM/DIST</p> <p>a. DVM – The digital voltmeter displays AC/DC voltage readings (digital and analog) with the corresponding dBm value on the CRT screen, in either generate or monitor function. Select AC or DC with the display cursor and keypad. The screen displays battery voltage and a signal's true RMS at the front panel DVM jack. Use the meter to check and set power supply voltage, bias level, and audio level.</p> <p>b. DISTORTION – This mode automatically measures fixed frequency EIA Sinad/Distortion (signal to noise and distortion ratio). The Analyzer generates a 1 KHz tone of known quality. Measure distortion of AM or FM transmitter modulation. Use the distortion meter for a comprehensive check of a receiver's performance.</p> <p>9. Ext Wattmeter – Select the element and the screen displays the forward and reflected power passed through that element mounted in the RTL-4055 wattmeter adapter.</p> <p>10. IF – The screen displays the 700 KHz IF signal from the monitor receiver for AM and SSB receiver servicing.</p> <p>11. Scope AC – The screen displays the voltage waveform applied to the vertical input (AC coupled).</p> <p>12. Scope DC – The screen displays the voltage waveform applied to the vertical input (DC coupled).</p>
FUNCTION switch	Two-position toggle switch	<p>Select either generate or monitor function.</p> <p>1. Generate – The equipment generates and outputs an RF signal.</p> <p>2. Monitor – The equipment monitors input signals with the input terminated into the receive mixer. Use this position for off-the-air monitoring.</p>
FUNCTION indicators	Six LED's (red)	<p>Indicates the mode of signal the equipment is set up to generate or monitor. Select by pressing one of the arrow keys under the FUNCTION section.</p> <p>1. FM – Equipment generates or monitors frequency modulated signals.</p> <p>2. CW – Equipment generates an unmodulated RF signal (continuous wave). Monitor position provides only frequency error measurement.</p>

**TABLE 2-1. CONTROLS, INDICATORS, AND CONNECTORS**

ITEM	DESCRIPTION	FUNCTION
FRONT PANEL (figure 2-1)		
		<ol style="list-style-type: none"> <li>3. AM – Equipment generates or monitors amplitude modulated signals.</li> <li>4. SSB/DSBSC – Single Side Band/Double Side Band Suppressed Carrier signal. The level of the generated signal is not calibrated. Use it only for relative measurements. Monitor SSB mode receives SSB signals with the use of the BFO.</li> <li>5. SWP 1-10 MHz – Equipment generates a swept RF signal having a sweep width of 1 to 10 MHz, controlled by the Dispr/Sweep control. Monitor position has no effect, equipment remains in generate mode.</li> <li>6. SWP 0.01-1 MHz – Equipment performs as in 5. above except sweep width limits are 0.01 MHz to 1 MHz.</li> </ol>
MODULATION switch	Three-position toggle switch	<p>Controls the Code Synthesizer modulation source.</p> <ol style="list-style-type: none"> <li>1. Cont – Continuous modulation signal output, generates repetitive cycles.</li> <li>2. Off – No modulation generated. Terminates code sequences.</li> <li>3. Burst – Generates a single cycle, spring loaded, returns to Off.               <ol style="list-style-type: none"> <li>a. PL, Tone A, Tone B Output is present as long as switch is held in Burst.</li> <li>b. DPL, DPL Inv DPL turn-off code as long as switch is held down. DPL code output when switch is moved to Cont position. Burst of DPL turn-off code is output when switch is moved from Cont to Off.</li> <li>c. Tone Sequence Output is a single signaling sequence.</li> <li>d. Tone Remote Output is a tone remote access sequence; leaves Tone A at a low level for transmit-type commands until the switch is returned to Off.</li> </ol> </li> </ol>

**TABLE 2-1. CONTROLS, INDICATORS, AND CONNECTORS**

ITEM	DESCRIPTION	FUNCTION
FRONT PANEL (figure 2-1)		
Code Synth Mode indicators	Six LED's (red)	<p>When illuminated, it indicates the code synthesizer mode selected. Select by pressing one of the arrow keys under the MODULATION section. Enter the PL frequency or DPL code from the keypad on the Gen/Mon Mtr display or select from the RF Memory display.</p> <ol style="list-style-type: none"> <li>1. PL/DPL indicator           <ul style="list-style-type: none"> <li>PL – Selected Private Line frequency output to 1 KHz</li> <li>DPL – Selected Digital Private Line code output. Maximum code number is 777. No digit may exceed 7.</li> </ul> </li> <li>2. PL/DPL Inv indicator           <ul style="list-style-type: none"> <li>PL – same as above</li> <li>DPL – Inverted output of selected Digital Private Line code. Maximum code number is 777. No digit may exceed 7.</li> </ul> </li> <li>3. Tone A indicator illuminates when Tone A is selected for output. Enter Tone A &amp; B frequencies from the keypad on the Tone Memory display.</li> <li>4. Tone B indicator illuminates when Tone B is selected for output.</li> <li>5. Tone Sequence indicator illuminates when the output is a tone signaling sequence. Select the sequence on the Tone Memory display.</li> <li>6. Tone Remote indicator illuminates when the output is the sequence for a remote station. Set A for guard; set B for command tone on Tone memory display.</li> </ol>
DISPLAY select switches	Two-pushbutton switches	<p>Selects the function to be displayed by the equipment, as indicated by the DISPLAY LED's.</p> <ol style="list-style-type: none"> <li>1. - moves the selection up one step at a time.</li> <li>2. - moves the selection down one step at a time.</li> </ol>
		
FUNCTION select switches	Two-pushbutton switches	<p>Selects the type or mode of signal the equipment will generate or monitor as indicated by the FUNCTION LED's. Operates the same way as the DISPLAY select switches.</p>
Code Synth Mode select switches	Two-pushbutton switches	<p>Selects the Code Synthesizer output mode as indicated by the Code Synth Mode LED's. Operates the same way as the DISPLAY select switches.</p>
Code Synth Lvl control	Potentiometer	<p>Controls the level of Code Synthesizer for modulation or MOD Output.</p>

**TABLE 2-1. CONTROLS, INDICATORS, AND CONNECTORS**

ITEM	DESCRIPTION	FUNCTION
FRONT PANEL (figure 2-1)		
Ext Level control	Potentiometer/switch	Controls modulation level of external input (microphone and other external generators). Switch at full counterclockwise position disables external modulation inputs.
1 KHz Level control	Potentiometer/switch	Internal 1 KHz tone modulation level control. Switch at full counterclockwise position disables 1 KHz modulation tone.
Mic connector	4-pin connector Pre-emphasis and IDC are used	Microphone input. Provides microphone bias and PUSH TO TALK (GENERATE) connection to equipment. Uses RTM-4000 microphone or handset.
Ext Mod In connector	BNC connector	External modulation signal input.
Mod Out connector	BNC connector	Output connector for all modulation signals (all signals combined).
MONITOR section:		
Volume control	Potentiometer	Controls speaker output level.
BW switch	Two-position toggle switch	In monitor mode, selects IF bandwidth. Wide BW is $\pm 100$ KHz mod acceptance. Narrow BW is $\pm 5$ KHz mod acceptance. In Gen, FM mode selects modulation range: 0-100 KHz deviation in WB or 0-25 KHz in NB.
BFO control	Potentiometer/switch	BFO on/off and beat frequency control for sideband reception. To minimize interference, turn off the BFO when not in use.
Sig Lvl indicator	LED (red)	Squelch indicator.
Squelch control	Potentiometer	Adjusts squelch threshold level, full counterclockwise position disables squelch. NOTE: Monitor sensitivity is greatly decreased (for high-level use) as the control is increased clockwise beyond the quieting point.
Image/Dplx toggle switch	Two-position switch	In duplex generation mode, controls the duplex frequency output for above (High) or below (Low) the receive programmed frequency. In monitor mode it selects the frequency of the local oscillator injection above or below the programmed monitor frequency to remove image interference.
Demod Out connector	BNC connector	Receiver audio output.

**TABLE 2-1. CONTROLS, INDICATORS, AND CONNECTORS**

ITEM	DESCRIPTION	FUNCTION
FRONT PANEL (figure 2-1)		
OSCILLOSCOPE section:		
Horiz switch	Seven-position rotary switch	When in the oscilloscope mode, selects the horizontal sweep rate or external horizontal input.
Horiz vernier control	Potentiometer	Horizontal sweep rate vernier or external horizontal input gain vernier. Calibrated position is fully clockwise.
Ext Horiz	BNC connector	Allows external horizontal inputs for oscilloscope. High input impedance.
Trig Level	Stacked concentric potentiometer and switch	Selects oscilloscope trigger level and trigger mode. Center knob selects the level of trigger. Outside (largest) knob controls the trigger mode. In Auto position, continuous sweep with no vertical input signal, syncs on vertical input. Normal position, no sweep unless vertical input is present, syncs on vertical input.
<b><u>CAUTION</u></b>		
During Tone Sequence mode, entering a scope trigger delay prevents normal operation of scope triggering.		
Position controls	Concentric potentiometers	Controls the position of the CRT display, when in the oscilloscope mode.
• Vert	Center (small) control knob	Controls the vertical position of the CRT display
◦ Horiz	Outside (large) control knob	Controls the horizontal position of the CRT display
Vert switch	Four-position rotary switch	Oscilloscope operation uses values marked to the right of the switch, indicating volts per division on the CRT. Modulation display mode uses values marked to the left of the switch, indicating range for calibrated FM deviation. This switch also controls Frequency Counter sensitivity.
Vert Vernier control	Potentiometer	Vernier gain control for vertical inputs to the CRT when in the oscilloscope mode. Calibrated position is fully clockwise.
Vert/Sinad/Dist DVM/Counter In connector	BNC connector	Signal input to the equipment for the following operations (one megohm input impedance): <ol style="list-style-type: none"> <li data-bbox="842 1703 1370 1728">1. External vertical for oscilloscope operation</li> <li data-bbox="842 1766 1170 1791">2. SINAD/Distortion Meter</li> <li data-bbox="842 1829 1078 1854">3. Digital Voltmeter</li> <li data-bbox="842 1892 1097 1917">4. Frequency Counter</li> </ol>



**TABLE 2-1. CONTROLS, INDICATORS, AND CONNECTORS**

ITEM	DESCRIPTION	FUNCTION
FRONT PANEL (figure 2-1)		
<b>RF SECTION:</b>		
RF In/Out connector	Type N connector	RF input in monitor mode, RF output in generate mode.
RF Level Variable control	Potentiometer	Vernier control of RF output level. Pull for antenna port. Push for RF In/Out port. Exceeding the Am Limit marking in AM generate mode may result in distorted output.
RF Level Step attenuator	14-position ganged attenuator and switch	Ten dB per step control of RF output level in generate mode. Also serves as RF input level step attenuator in monitor and spectrum analyzer modes.
Ext Wattmeter	Connector	Allows input from Motorola ST-1200 series inline wattmeter elements for measurement and CRT display of forward and reflected transmitted power.
DUPLEX GEN switch	Two-position toggle switch	Select either On or Off. Duplex output from DUPLEX port is enabled with switch On.
Output connector	BNC connector	Output connector for duplex generator output.
Antenna Port	Fused BNC connector PN #09-80378A51	Connector for the whip antenna.

*Ant. Conn Kit:  
# 09-80378A51  
BNC w/ FUSE,  
CHASSIS MOUNT.*

**FUSE REPLACEMENT PROCEDURE:**

Place a male BNC connector on the antenna port. Use a pair of slip-joint pliers to grab onto the knurled portion of the male BNC connector. Turn counterclockwise to loosen. Unscrew the connector all the way, off the front panel. The fuse is plugged into the female center pin. Use a needle-nose pliers to remove the defective fuse and replace it with a 0.10 A mini-fuse, PN #65-80377A61.

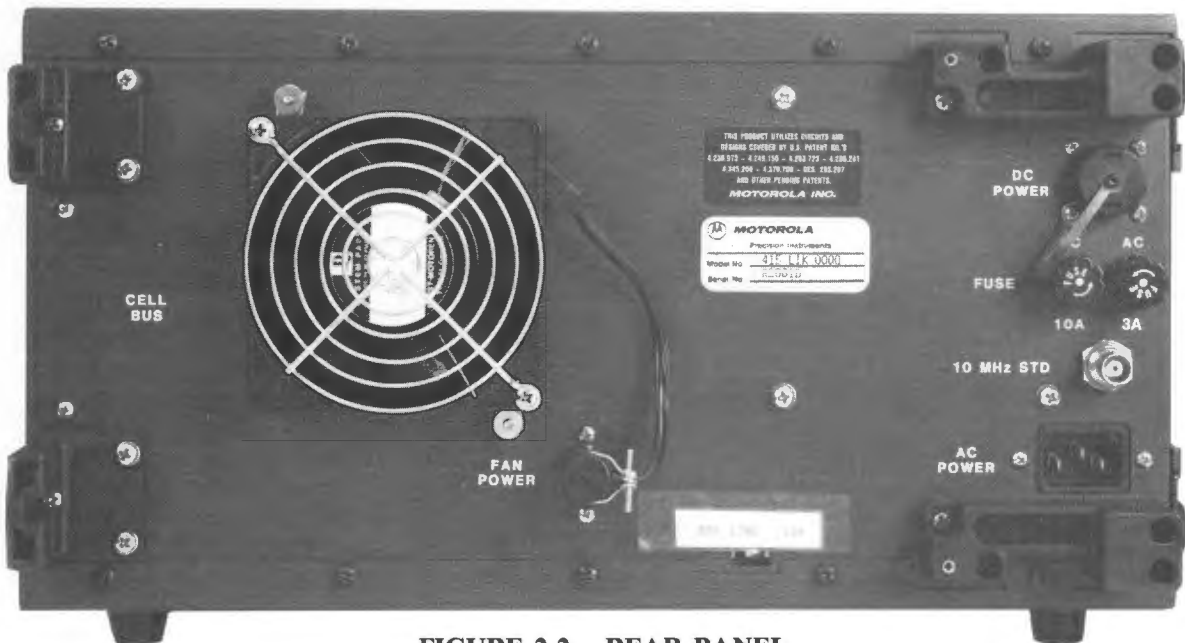

**FIGURE 2-2. REAR PANEL**

**TABLE 2-1. CONTROLS, INDICATORS, AND CONNECTORS**

<b>ITEM</b>	<b>DESCRIPTION</b>	<b>FUNCTION</b>									
<b>REAR PANEL (figure 2-2)</b>											
LINE power control	Recessed switch	Select primary AC voltage, either 110 V or 220 V line.									
AC POWER	Connector	Primary AC power input.									
DC POWER	Connector	Primary DC power input port and battery charger output.									
10 MHz STD	BNC Connector	Input/Output for 10 MHz reference frequency. See bottom panel.									
AC 3A DC 10A	Line fuseholders	AC and DC line fuses:									
		<table border="1"> <thead> <tr> <th><u>OPERATION</u></th> <th><u>FUSE</u></th> <th><u>PART NUMBER</u></th> </tr> </thead> <tbody> <tr> <td>110/220 VAC</td> <td>3 A</td> <td>65-20404</td> </tr> <tr> <td>12 VDC</td> <td>10 A</td> <td>65-10266</td> </tr> </tbody> </table>	<u>OPERATION</u>	<u>FUSE</u>	<u>PART NUMBER</u>	110/220 VAC	3 A	65-20404	12 VDC	10 A	65-10266
<u>OPERATION</u>	<u>FUSE</u>	<u>PART NUMBER</u>									
110/220 VAC	3 A	65-20404									
12 VDC	10 A	65-10266									
FAN POWER	Connector	Power connector for the cooling fan.									
CELL BUS	Bus connector	Placement of I/O connector when cellular service option is installed (R-2008D).									
<b>BOTTOM PANEL</b>											
Frequency Standard 10 MHz control	Recessed switch	Select either the internal 10 MHz frequency standard or an external 10 MHz source applied to the appropriate rear panel connector. This switch makes the rear panel 10 MHz port an output when operating from the internal standard or as an input otherwise.									

# SECTION 3 OPERATION

## 3.0 OPERATION

### • GENERAL

The Communications System Analyzer is easy to use. Connectors, controls, and indicators are conveniently and logically arranged in functional groups outlined in red on the front panel. The Analyzer incorporates many useful applications that are not evident by examining the front panel. The appropriate section of this manual clearly explains these applications and how to access them by manipulating the keypad. The CRT displays an organized presentation of measurement results. A non-volatile memory conveniently stores the data entered into the system by the operator. The system provides warning messages and audible alarms to ease operation and minimize errors.

### 3.1 POWER SECTION

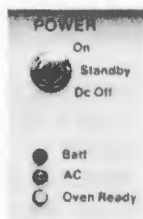

FIGURE 3-1. POWER CONTROLS

### • POWER

The Analyzer operates on AC or DC. AC can be either 100 to 130 VAC or 200 to 260 VAC, 47 Hz to 400 Hz capable of 115 Watts. Use the recessed LINE switch on the rear panel to select either 110 or 220 voltage. DC input from Motorola battery pack RTP-1002A or any convenient external battery source operates from +11 V to +16 V, 6.5 amps maximum, with not more than 90 Watts DC input. Refer to Section 1 of this manual for installation instructions for the Motorola battery pack that attaches to the rear panel and provides approximately 50 minutes continuous operation. Figure 3-1 shows a three-position toggle switch located to the right of the keypad on the front panel and used to control the Analyzer's power supply.

### • ON

The On, or full-up, position of the toggle switch energizes all circuitry except the battery charger.

### • SELF-TEST

When the power switch is first turned on, the Analyzer performs an internal check of its own circuits to detect possible trouble. If the system detects an error, during the course of this self-test, a message displays on the screen to indicate the nature of the trouble and provide some guidance for troubleshooting and/or continued operation.

### • SELF-TEST DISPLAY EXAMPLES:

REFER TO  
ADDENDUM  
AT THE END  
OF THIS SECTION  
PAGE 3-21

### • STANDBY

In Standby or center position, if the line cord is connected to AC power, the battery charger continues to operate and power is applied to the internal frequency standard.

### • DC OFF

In the full-down position DC Off, if the line cord is connected to AC power, only the battery charging circuit operates.

### • LED INDICATORS

AC LED indicator illuminates whenever AC power is connected to the three-pin power connector on the rear panel. Batt (battery) LED indicator illuminates whenever DC power is connected to the DC POWER connector on the rear panel. AC and DC indicators never illuminate together. The system switches automatically between AC and DC, with preference for AC if both are present. Oven Ready LED indicator illuminates automatically when the internal frequency standard has stabilized and the system is ready to operate accurately.

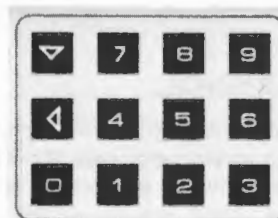

FIGURE 3-2. KEYPAD

### • KEYPAD

The keypad shown in figure 3-2 has a down arrow key to move the cursor vertically on the CRT, a left arrow key to move the cursor horizontally, and a key for each number 0 to 9. When moved down, the cursor will move to the first allowable position to the left on the next lower data entry area. If the cursor is at the lowest allowable line when the down key is pressed, the cursor will wrap around to the uppermost allowable line. Press the left key to move the cursor left to the next allowable position. If the cursor is at the most left position when the left key is pressed, the cursor will wrap around to the

most right position on the same line. Select and press a numbered key to enter numeric information into the system and onto the CRT display screen. When a numbered key is pressed the system replaces an existing number on the screen, over which the display cursor is set, with the number on the pressed key. The system correctly places the decimal point. Use the keypad to enter input frequency for RF and IF generators, private line frequencies, timing information for paging systems, etc.

```

MONITOR FM          - -) 553.9999 MHz
-77.3 DBM  INPUT LEVEL      30.2 uV
                ERROR KHZ      + 23.7
-----
-15          0              + 15
-99.9        DEV KHZ        + 99.9
-----
-100         0              + 100

DEV ALARM 07.0 KHZ
  
```

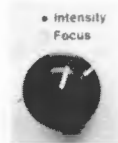

**FIGURE 3-3. CATHODE RAY TUBE DISPLAY SCREEN**

**CRT DISPLAY SCREEN**

The CRT screen (figure 3-3) displays fixed alphanumeric, a movable cursor, operator enterable numeric information, and system generated data outputs. The CRT continuously displays all functions, control settings, and measurements (generated or monitored) in both analog and digital forms. Bargraphs aid the autoranging digital readouts. Each bargraph has a base line, calibration markers, and intensified segment showing the measured value. When the Analyzer is switched into another mode, the CRT instantly displays all pertinent information. Use the dual control located at the lower right-hand corner of the CRT, to adjust the intensity and focus of the display. See Section 1 for Trace Rotation Adjustment procedure to re-align a tilting display screen.

**SYSTEM WARNINGS**

The Analyzer provides protection against accidental application of high level energy into the RF ports. A fused BNC connector provides protection for the high level generator output antenna port. At the transceiver port, where the system is automatically in power monitor mode, the application of RF energy in excess of 100 milliwatts switches the Analyzer from generate to monitor mode. When too much RF is applied to the transceiver, an audible alarm warns and a visual warning appears on the CRT. Displays also warn of low battery power, improper attenuator setting for particular measurements, or overheated RF load. A continuous audible alarm sounds when a preset deviation limit is exceeded in monitor mode. An RF overload warning displays on the CRT in place of the modulation metering for strong RF input levels which could introduce measurement error. The warning does not display for input levels below -40 dBm at the antenna port and below -10 dBm at the transceiver port with the RF Step

attenuator in the 0 dB position. Use the attenuator to reduce the input signal level and thus remove the overload warning.

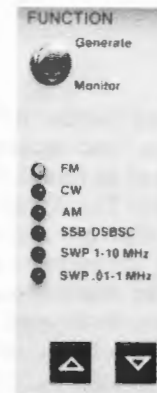

**FIGURE 3-4. FUNCTION SECTION**

**3.2 FUNCTION SECTION**

Figure 3-4 shows the front panel FUNCTION section with the toggle switch (Generate or Monitor), two arrow selection keys - up or down, and six modes with their LED's:

- FM                    FREQUENCY MODULATION
- CW                    CONTINUOUS WAVE
- AM                    AMPLITUDE MODULATION
- SSB/DSBSC           SINGLE SIDE BAND/DOUBLE
- SIDE BAND SUPPRESSED
- CARRIER
- SWP 1-10 MHz        SWEEP 1 MHz to 10 MHz
- SWP .01-1 MHz       SWEEP 0.01 MHz to 1MHz

```

MONITOR CW          - -) 101.1000 MHz
--.- DBM  INPUT LEVEL      ---.- W
                ERROR KHZ      -44.
-----
-15          0              + 15
  
```

**FIGURE 3-5. CW DISPLAY**

A typical Continuous Wave display screen (figure 3-5) shows set frequency, frequency error, and RF input level. Modulation data is not monitored.

```

MONITOR AM          - -) 101.1000 MHz
--.- DBM  INPUT LEVEL      ---.- W
                ERROR KHZ      -41
-----
-15          0              + 15
-60.5        PCT AM        + 70.4
-----
-100         0              + 100
  
```

**FIGURE 3-6. AM DISPLAY**

A typical Amplitude Modulation display screen (figure 3-6) shows set frequency, frequency error, percent AM modulation, and RF input level.

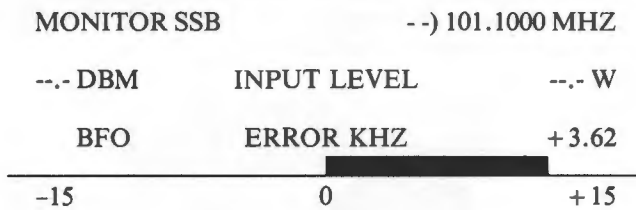

**FIGURE 3-7. SSB DISPLAY**

A typical Single Side Band display screen (figure 3-7) shows set frequency, RF input level, and BFO frequency error. Modulation data is not monitored.



**FIGURE 3-8. SWP DISPLAY**

A typical Sweep display screen (figure 3-9) shows only set frequency and RF output level. Modulation data is not monitored. In sweep function, select either 0.01-1 MHz or 1-10 MHz range. Use the Dispr/Sweep vernier to control the sweep width. The minimum position is fully counterclockwise and the maximum position is fully clockwise.



**FIGURE 3-9. MODULATION SECTION**

### 3.3 MODULATION SECTION

Figure 3-9 shows the connectors, controls, and indicators located in the front panel MODULATION section. The modulation generator provides the RF generator with the modulating signal internally connected to either frequency, amplitude, or sideband function. The modulating signal sums the inputs of three sources: Internal fixed 1 KHz test tone, multimode audio code synthesizer, and external inputs. Adjust the level of each source independently. The modulating signal is available at the Mod Out BNC connector.

- **FIXED 1 KHz TONE**

A 1 KHz test tone provides a convenient modulation source for general troubleshooting, SINAD and DISTORTION measurement, and distortion measurement. Adjust the level with the 1 KHz Level control. The Off position turns off the 1 KHz tone.

- **CODE SYNTHESIZER**

The code synthesizer generates either a single tone, a multitone sequence, or a DPL sequence in response to front panel and CRT display inputs. Press a MODULATION arrow key to select one of the six modes:

PL/DPL	Private Line/Digital Private Line
PL/DPL Inv	Private Line/Inverted Digital Private Line
Tone A	Tone A frequency only
Tone B	Tone B frequency only
Tone Seq	Signaling Sequence
Tone Remote	Remote Base Control Sequence.

Use the keypad to select frequencies in the 5 Hz to 1,000 Hz range for PL or DPL modes and in the 5 Hz to 20,000 Hz range for the other modes (0.1 Hz increments). The MODULATION toggle switch initiates the programmed tone sequence:

- Cont – Continuous position generates repetitive cycles
- Off – Position terminates modulation
- Burst – Position generates a single tone sequence.

Table 3-1, Modulation/Function, tabulates what works when.

<u>MODULATION</u> <u>Code Synth Mode</u>	<u>FUNCTION</u>
°PL/DPL	Available only in FM Generate or FM Duplex Gen.
°PL/DPL Inv	Available only in FM Generate or FM Duplex Gen.
°Tone A	Available as Modulation in FM, AM, or SSB FUNCTION only in Generate position. Available at Mod Out jack, at all times if selected, in both Generate and Monitor positions.
°Tone B	Same as Tone A.

°Tone Seq Available in FM, AM, or SSB FUNCTION only in Generate position.

°Tone Remote Same as Tone A.

Note: All modulation sources are available at Mod Out jack while in use as generator modulation. Code Synthesizer Level control simultaneously sets both the output level and the modulation level.

**TABLE 3-1. MODULATION/FUNCTION AVAILABILITY**

**EXTERNAL LEVEL**

External Modulation Inputs from a microphone (Motorola RTM-4000B) plugged into the front panel and a signal applied to the Ext Mod In sum together to provide a single external modulating signal. The microphone input provides standard mobile radio pre-emphasis, clipping, and frequency roll-off. The microphone push-to talk switch switches the system from monitor to generate mode. Adjust the external input sensitivity or impedance with the External Level control, for analyses with external instruments. The Off position turns off the composite external modulation signal path.

- The Mod Out connector provides external access to the composite modulation signals. Output impedance is 600 ohms.



**FIGURE 3-10. DISPLAY MODES**

**3.4 DISPLAY SECTION**

To select one of the twelve DISPLAY modes shown in figure 3-10, press an arrow key located under the DISPLAY list to activate up or down movement of the adjacent LED indicator. If a DISPLAY mode is located at the top or bottom of the list when a key is pressed, the DISPLAY mode will wrap around. Confirm the selected configuration by the appropriate display on the CRT.

- **GENERATE/MONITOR METERING**
- **GENERATE**

In Generate FUNCTION the Analyzer generates an RF signal at a controllable output level useful for receiver testing. Many forms of internal and external modulation can be simultaneously impressed on the carrier frequency to generate composite signals for servicing. Use

the keypad to select any frequency of the generator from 10 KHz to 1,000 MHz in 100 Hz increments. The output range at the antenna port and the transceiver port provides sufficient amplitude to get through misaligned tuners and receivers. It is especially effective to change a receiver's frequency.



**FIGURE 3-11. RF SECTION**

**RF LEVEL**

In the RF SECTION of the front panel (figure 3-11) a push-pull switch associated with the Variable level control selects either the antenna port or the transceiver port. The out-position (Pull) selects the antenna port. Control the output over a 16 dB range with the Variable RF Level control and the attenuation with the 14 Step attenuator at 10 dB per step. Use the attenuator to extend the range to the maximum antenna input level of +10 dBm.

FUNCTION	VOLTS RMS	DBM
FM and CW	0.1 uV to 1 V	-127 to +13
AM	0.1 uV to 0.4 V	-127 to +5

**TABLE 3-2. RF OUTPUT LEVEL AT ANTENNA PORT**

**RF OUTPUT LEVEL**

Table 3-2 shows RF output levels available at the antenna port. At the in-position (Push) transceiver port (RF In/Out) the output level is attenuated by a nominal 30 dB below the level at the antenna port.

GENERATE FM PL) 150.0	-- ) 154.1250 MHZ DPL) ---
<b>RF LEVEL</b>	
0.61 uV	-111.4 DBM
12.4 PCT	DIST SINAD -18.1 DB
-60	0
-4.74	DEV KHZ +4.75
-100	0 +100

**FIGURE 3-12. GENERATE MODE METERING DISPLAY**





When using the transceiver port (RF In/Out) disconnect the antenna from its port.

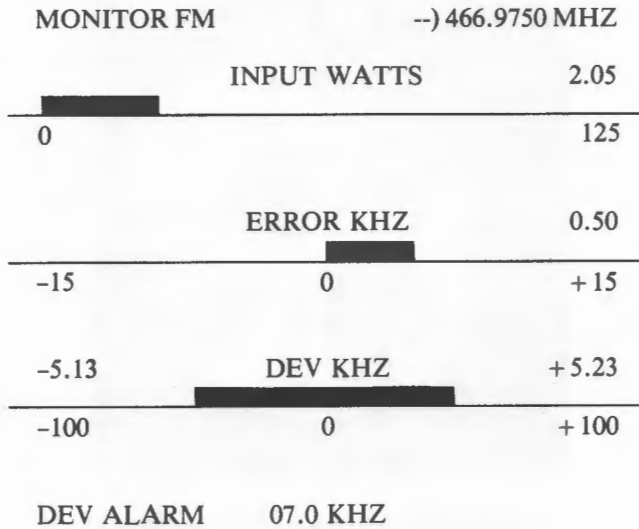

**FIGURE 3-14.**  
**MONITOR MODE METERING DISPLAY**

Figure 3-14 defines a monitor mode metering display. Set the toggle switch to Monitor, the FUNCTION to FM, and the DISPLAY to Gen/Mon Mtr. Here is a line-by-line description of this display:

1) MONITOR FM                      ..) 454.1252 MHZ

On line 1 the CRT displays MONITOR FM. When the operator uses the keypad and the display cursor to enter a preset channel number, between 01 and 32, the CRT displays the appropriate frequency from the RF Memory table and the system operating frequency changes as required. If the operator enters a new frequency, dashes replace the channel number and the frequency changes as required.

4) -62.4 DBM    INPUT LEVEL              170.0 uV

Line 4 displays the input signal level at the RF In/Out connector from -70 dBm to 3 dBm with indication in volts (use attenuator). Above 30 dBm, indication switches to watts. The three-digit watts reading autoranges between 10, 100, and 125 watts full scale. If front panel settings or input conditions do not allow accurate determination of dBm or volt readings, dashes replace the reading.

9)	ERROR KHZ		-1.05
10)	0		
11)	-15	0	+15

The zero centered bargraph reflects the frequency error. The graph originates at the center of the display, moves to the left to indicate increasing negative error, and to the right to indicate increasing positive error. The graph responds in a modified logarithmic manner that provides a smooth nonranging analog display on a full scale of ±15 KHz in narrow BW and ±15 KHz in wide BW. If the operator enables direct frequency readout mode, the CRT omits the graph.

A frequency error or actual frequency displays operates simultaneously with FM or AM to 80%. For the SSB mode, the display shows either the error frequency or the actual frequency of the MONITOR BFO. Monitor SSB mode receives SSB signals with the use of the BFO. Adjust the BFO frequency over the range of ±3 KHz from the monitor center frequency.

12)	-4.72	DEV KHZ	+4.75
13)	0		
14)	-100	0	+100

The display shows positive and negative modulation level of recovered FM in digital and analog readouts. The reading in peak KHz autoranges full scale between 10 KHz and 100 KHz. During overload conditions the CRT omits the bargraph and a warning message replaces the normal modulation display:

**INCREASE INPUT ATTENUATION**

The warning will not appear for inputs below -40 dBm at the antenna port or below -10 dBm at the transceiver port with the RF Step attenuator in the 0 dB position. Use the attenuator to reduce the input signal level and remove the overload warning.

A continuous audible alarm sounds when a preset deviation limit is exceeded. Depress both keypad cursor keys simultaneously to invoke the Special Function display. Use the keypad to enter code #78XYZ to program the deviation alarm from 0.1 KHz to 99.9 KHz with 100 Hz resolution. Enter special function code #78000 to disable the alarm.

15) ANT displays only when the antenna input on the front panel is enabled. ATTN) 0 displays whenever the RF Step attenuator is at a setting other than the 0 dB position and the monitor mode is in use.

• **SPECIAL FUNCTION MODE**

Use the special function mode to expand the Analyzer's capability into areas not required for general use. Use the keypad to enter control information into the system and to customize for user preference without the use of a specific CRT display. To enable a special function, at any time and during any mode:

**SIMULTANEOUSLY DEPRESS BOTH KEYPAD CURSOR KEYS**

and then release. The screen changes to show a special function command display. Two dashes appear on the screen under the words:

**SPECIAL FUNCTION ENTRY.**

Use the keypad to enter the two-digit special function code selected from table 3-3. Entering the code's last digit activates the selected function. If more data is required, more dashes appear on the screen. Enter the additional data. The system reverts to the previous normal screen either shortly after data is entered or after 10 to 15 seconds of no data entry. Repeat the sequence for each code to activate multiple special functions.

**• SPECIAL FUNCTION CONTROL CODES**

- The card supplied with the R-2001D and the applique inside the front-panel cover show the special function codes. Table 3-3 lists the special function control codes grouped according to the first digit of the code and then grouped by function type.
- A master reset code 0 (zero) causes all function types to revert to the default states listed in table 3-3.
- To obtain a CRT display of all activated special functions, simultaneously depress both keypad cursor keys twice. The screen will automatically return to standard operation after 10 to 15 seconds.

<u>CODE</u>	<u>MODE</u>	<u>ACTIVATES</u>
0	Master Reset	Clears all special functions (default state)
10	Encode/Decode	Clears all 1X E/D special functions (default state)
11	Encode/Decode	Baseband
12	Encode/Decode	Decode only
13	Encode/Decode	Encode Only
20	Monitor	Clears all 2X monitor special functions (default state)
21	Monitor	Enables 300 Hz LPFL
22	Monitor	Enables 3 KHz LPFL
23	Monitor	Enables 20 KHz LPFL
24	Monitor	Enables 5 Hz HPFL
25	Monitor	Enables 300 Hz HPFL
26	Monitor	Enables 3 KHz HPFL
30	Frequency	Clears all frequency 3X special functions (default state)
31	Frequency	Enables direct frequency readout (10 Hz resolution)
32	Frequency	Enables direct frequency readout (1 Hz resolution)
33XY	Frequency	Enables scan lock from X00 MHz to Y00 MHz
3300	Frequency	Enables full-band scan lock
34XY	Frequency	Enables scan latch from X00 MHz to Y00 MHz
3400	Frequency	Enables full-band scan latch

<u>CODE</u>	<u>MODE</u>	<u>ACTIVATES</u>
40	DVM	Enables automatic DVM ranging (default state)
41	DVM	Enables 1.0 V DVM range
42	DVM	Enables 10 V DVM range
43	DVM	Enables 100V DVM range
44	DVM	Enables 300V DVM range
50	Modulation Meter	Enables automatic modulation ranging (default state)
51	Modulation Meter	Enables 10 KHz range
52	Modulation Meter	Enables 100 KHz range
60	Counter	Auto counter resolution (default state)
61	Counter	0.1 Hz resolution
62	Counter	1 Hz resolution
63	Counter	10 Hz resolution
64	Counter	100 Hz resolution
65	Counter	1 KHz resolution
70	System Control	Sets factory control states (default state)
71	System Control	Sets the current state as the power-on state
72	System Control	Initiates a system self test
73	System Control	Disables the automatic switching to monitor mode if the input signal is over 0.1.W.
74	System Control	Mutes speaker during GEN
77XY	System Control	Sets the last XY in RF memory presets as duplex
7700	System Control	Resets from duplex to simplex (default state)
78XYZ 79050	System Control	Sets deviation audible alarm to XY.Z KHz
78000	System Control	Disables audible alarm (default state)
79	System Control	Resets nonvolatile memory
99	Software Version	Shows P/N of resident software version

**TABLE 3-3. SPECIAL FUNCTION CONTROL CODES**

- **AUTO TUNE MODE**

Enable full-band scan lock with special function control code #3300 (table 3-3). The monitor scans its specified frequency range to automatically acquire and tune a strong input signal within five seconds. For faster acquisition, use special function control code #33XY to limit the scan range to 100 MHz increments. The minimum input signal level for automatic frequency acquisition is -30 dBm at the antenna port and 0 dBm at the transceiver port. The word SCANNING replaces the programmed frequency display. Line 8 displays the actual input frequency  $\pm 1$  KHz as shown in the example in figure 3-10. When tuned, dashes replace the SCANNING display and a dash in the cursor replaces the channel number. When the input signal is removed, scanning resumes.

- **SCAN LATCH MODE**

Select this variation of the auto tune mode, using special function control code #3400 or 34XY to program and latch an auto tune frequency. In this mode, the input signal is acquired and tuned in the same manner as for auto tune. However, the programmed frequency display shows the word:

- LATCHED

and a dash under the cursor instead of the preset number.

The second line on the metering display reads

- PRESS 0 TO RESCAN

If the input signal is removed, the system remains programmed to the last frequency tuned. When the operator activates the 0 key, scanning resumes and the word SCANNING replaces the word LATCHED on the display. The preset number 0 appears under the cursor. Also, the CRT omits the second line on the display as scanning resumes.

The scan latch mode is useful for locating the transmit frequency of trunked radios.

- **VOLUME AND SQUELCH CONTROLS**

The Volume control adjusts the speaker output level. The Squelch control located to the left of the Volume control (figure 3-15) is continuously variable from Off position (disabled squelch) to a maximum squelch level of  $-25 \text{ dBm} \pm 10 \text{ dB}$  at the antenna port. When the Signal Level LED illuminates, it indicates an open position (unsquelched). When the LED is not illuminated, it indicates a closed position (from threshold to tight squelch).

- **OFF-THE-AIR MONITOR**

Use the Analyzer's antenna port for off-the-air monitoring. The Analyzer receiver's 1.5 uV sensitivity allows off-the-air monitoring to measure transmitter frequency error and deviation to 1000 MHz. Monitor weak signals with the variable squelch. But for accurate measurement, set them higher to ensure proper signal-to-noise ratio. More accurate measurements result from using a higher signal level. The off-the-air monitor function enables frequent parameter checks to spot system degradation early and reduce service costs. Set Wide bandwidth for off-channel signal location or wide band FM. Set Narrow bandwidth for maximum sensitivity and selectivity.

- **SIGNAL STRENGTH METER**

Place the FUNCTION switch in Monitor mode. The frequency selective signal strength indicator, operates simultaneously with other monitor functions over the full input frequency range of the monitor. It uses a maximum 30 KHz bandwidth around the monitor center frequency. At the antenna port, the signal strength indicator operates for input levels from  $-99.9 \text{ dBm}$  to  $-30 \text{ dBm}$  with the Step attenuator in the 0 dB position. For a non-zero attenuate both limits are increased by the amount of the attenuation. Measure higher level signals by inserting loss, using the rotary attenuator. The displayed measurement compensates for the attenuation.

- **FM DEMODULATION**

The monitor demodulates FM to 75 KHz peak deviation in the wide band position and to 5 KHz in the narrow band position. Selectable highpass and lowpass filter sections determine the monitor's frequency response with characteristics as shown in table 3-4. Select bandwidth via BW switch or special function control. The wide band position enables the 5 Hz highpass and 20 KHz lowpass filters. The narrow band position enables the 5 Hz highpass and 3 KHz lowpass filters. Special Function overrides the BW switch to enable selection of any combination of high and low pass filtering as defined in table 3-3.

### 3.6 MONITOR SECTION



FIGURE 3-15. MONITOR SECTION



• **AUDIO FILTERS**

Table 3-4 lists audio filter characteristics.

Filter Characteristic	Filter Mode	Frequency (Not More Than 0.5 dB)	Frequency (Not More Than 3 dB)	Frequency (At Least 20 dB)
Highpass:	5 Hz	5 Hz	—	—
	300 Hz	—	300 Hz	170 Hz
	3 KHz	—	3 KHz	1.7 KHz
Lowpass:	20 KHz	20 KHz	—	40 KHz
	3 KHz	—	3 KHz	5.4 KHz
	300 Hz	—	300 Hz	540 Hz

**TABLE 3-4. AUDIO FILTER CHARACTERISTICS**

• **AM DEMODULATION**

The monitor demodulates AM to a 100% modulation level. The frequency response is the same as for FM except that the lowest allowable highpass filter cutoff is 300 Hz.

• **SINGLE SIDEBAND DEMODULATION**

The monitor has a minimum dynamic range of 30 dB in the sideband mode. The frequency response is the same as for FM.

• **AUDIO MONITOR**

A speaker monitors the recovered signal in the monitor mode and the modulating signal in the generate mode. The speaker drive signal is also applied to the receive audio pin of the microphone/headset connector. Use special function control to disable the speaker while maintaining the headset audio signal with volume control. The audio signal frequency response ranges from 300 Hz to 20 KHz in the wide band and from 300 Hz to 3 KHz in the narrow band.

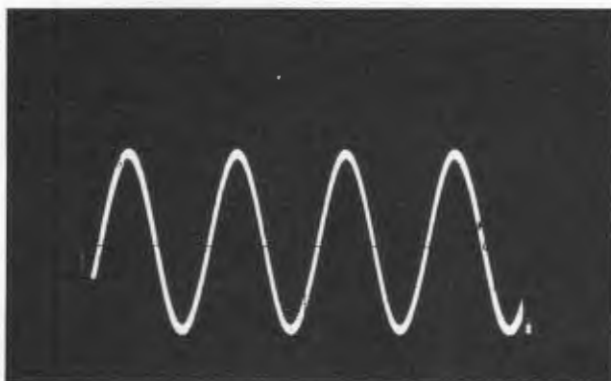
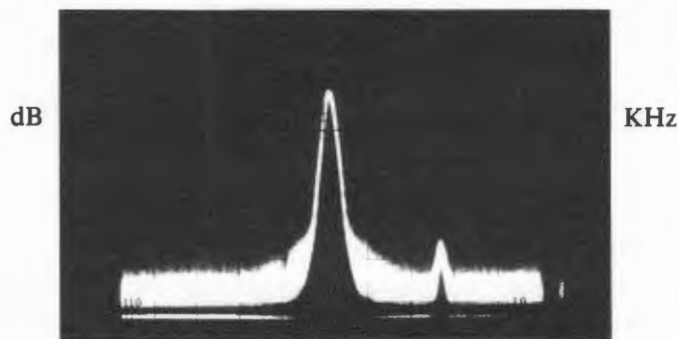

**FIGURE 3-16. MODULATION DISPLAY**

• **MODULATION**

In the frequency MODULATION DISPLAY (figure 3-16), view the composite modulation audio waveform in generate mode or the demodulated audio in monitor mode. Analyze waveforms on the scope to measure deviation graphically. Use the MONITOR BW switch to select wide or narrow bandwidth. In the wide position, adjust frequency modulation level from 0 to 75 KHz peak deviation. In the narrow position, adjust the range from 0 to 20 KHz. The display's vertical deflection is calibrated for FM, generate and monitor modes, in three ranges with 0.25 KHz, 2.5 KHz, and 25 KHz per graticule division. Use the OSCILLOSCOPE modulation controls shown in figure 3-41 to select deviation level, vertical and horizontal. To set the range, adjust the Vert control to the proper KHz/Div. The modulating signal is generated internally by the MODULATION SECTION. Refer to paragraph 3.3 in this manual.

CENTER FREQ 07) 156.2800 MHz



**FIGURE 3-17. SPECTRUM ANALYZER DISPLAY**

• **SPECTRUM ANALYZER**

The Spectrum Analyzer display, figure 3-17, shows center frequency, channel number, and operating frequency. Use the keypad to enter the channel number, from 01 to 32 or enter a center frequency directly. Use the Spectrum Analyzer to identify interference, trace RF and IF signals, measure transmitter harmonics, check spurious response and receiver local oscillator radiation. The CRT displays the appropriate frequency from the RF Memory table and changes the system operating frequency as required. Entering a new frequency changes the channel number to a dash and changes the system operating frequency as required. The CRT displays a window of the RF spectrum at either the antenna or transceiver port in a range selected from 1 MHz to 1,000 MHz programmable in 100 Hz increments. The observed window for the Analyzer can be controlled with the Dispr/Sweep and RF Scan controls. The Spectrum Analyzer has a dynamic range of at least 75 dB with the Step attenuator in the 0 dB position. With the attenuator, the usable range can be extended up to the maximum allowable input levels. When using the attenuator, add 10 dB per step attenuation to the actual dB reading on the scope. The usable sensitivity is at least -95 dBm at the antenna port and -65 dBm at the transceiver port.

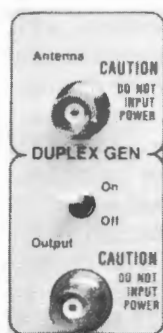

FIGURE 3-18. DUPLEX GENERATOR SECTION

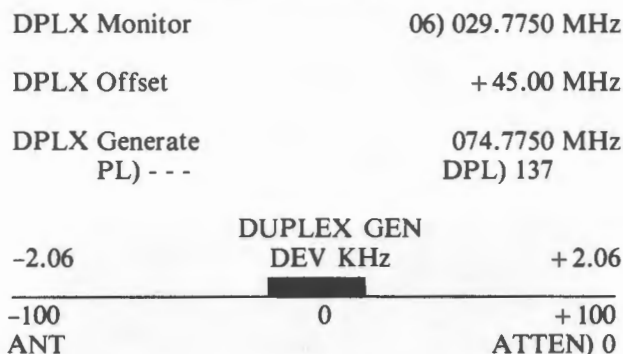

FIGURE 3-19. DUPLEX GENERATOR DISPLAY

• **DUPLEX GENERATOR**

The Analyzer provides an RF output that is offset in frequency from the Monitor center frequency and enhances capability to service duplex radio equipment such as repeaters, car telephones, and emergency medical telemetry portables. The DUPLEX GEN Output becomes the generate port for this mode while the transceiver or antenna port becomes the monitor port. Figure 3-18 shows the DUPLEX GENERATOR On/Off toggle switch, Antenna and Output connectors, located in the lower left-hand corner of the front panel. The duplex generator operates over the full monitor frequency range and provides frequency offsets from 0 MHz to  $\pm 10$  MHz programmable in 5 KHz steps and the single fixed offset of  $\pm 45$  MHz. The duplex generator has full internal and external FM modulation capability, including voice simultaneous with audible and subaudible tones. This modulation appears on the RF coming off the DUPLEX GEN Output port which is a separate -35 dBm (4 mV) RF output.

Figure 3-19 shows the DUPLEX (Monitor, Offset, Generate) display, channel number, and system monitor frequency. Enter the channel number. The CRT displays the appropriate frequency from the RF Memory table. The system operating frequency changes as required. If the channel number defines a duplex frequency pair, the generate frequency of that pair displays on line 5. Line 3 shows the corresponding calculated offset. If the offset exceeds  $\pm 45$  MHz or  $0 \pm 10$  MHz, the generate frequency changes to reflect the offset that was displayed before channel selection. For a new entry, the channel number changes to a dash and the system operating frequency changes as required. The generate frequency

also changes to maintain the displayed offset value whenever a new monitor frequency is entered. The programmable duplex offset equals the generate frequency  $\pm$  the monitor frequency.

The MONITOR Image/Duplex switch controls the positive or negative signal of the offset. As the offset changes, the generate frequency changes to reflect the new offset. On line 1, enter the channel number to select a frequency from the RF memory table. In DUPLEX GEN mode, the Image/Duplex two-position toggle switch controls the duplex frequency output for above (High) or below (Low) the receive programmed frequency. In monitor mode, this switch selects the frequency of the local oscillator injection above or below the programmed monitor frequency to remove image interference. Enter either the PL or DPL code of the duplex generate frequency. If an entry is made into the PL location, the DPL display changes to a dash. If an entry is made into the DPL location, the PL display changes to a dash. Line 11 indicates the position of the FUNCTION switch. Generate or Monitor mode determines the source of modulation available for system analysis. It is either applied to the duplex generator or recovered from the monitor receiver. Both positive and negative readings autorange in three digits with full scale from 10 KHz to 100 KHz. The bargraph represents modulation levels and provides a smooth nonranging analog display on a full scale of 20 KHz FM.

RF MEMORY			
PL) - - -		--)	267.5673 MHz
			DPL) 132
			PAGE SEL) 2
	RF (MHz)	PL (Hz)	DPL
09)	150.5200	---	131
11)	823.7320	---	226
12)	154.0000	063.0	---
13)	164.0000 TX	075.0	---
	145.0000 TX		
14)	164.5500 TX	003.2	---
	174.5500 TX		

FIGURE 3-20. RF MEMORY DISPLAY

• **RF MEMORY**

An internal nonvolatile memory stores and displays programmable RF frequencies and their corresponding PL or DPL codes. Use the keypad and display cursor to enter or change a frequency in the memory table. A frequency remains in the table until it is changed. Once programmed, the memory provides one button recall to set the operating frequency and code for the preset frequency. Figure 3-20 shows a typical RF Memory table page. The display allows page numbers from 1 to 4. When the page number is changed, the display changes to reflect the information stored on the new page. Enter all numeric values, except preset channel numbers, up to a total of 32 entries. Preset channels are either simplex or duplex. Select 0 to 16 duplex channels through special function control code 77XY (table 3-3). Duplex chan-

nels display a pair of frequencies for each channel number, one for generate and one for monitor. Identify generate or monitor frequencies by the letters RX or TX. The system changes automatically from transmit to receive frequencies with the Generate/Monitor switch or the MIC push-to-talk switch. Each simplex channel and each generate frequency of a duplex channel has either a PL or DPL code. A dash replaces an unused code. When a preset is selected, the appropriate PL or DPL code is also programmed into the signaling generator.

• **ENTRY WITH MEMORY TABLE**

To enter a frequency or code into the memory table, proceed as follows:

1. Select RF Memory DISPLAY position.
2. Use the keypad cursor keys to select the line and location to be changed.
3. Use the keypad numeric keys to enter the new frequency, PL, or DPL code.
4. Make other changes or corrections for each line of the memory table.
5. Turn the POWER switch to Standby for five seconds. Turn the switch On and check the memory table to verify that all information is correct.

• **ENTRY WITHOUT MEMORY TABLE**

To enter a frequency or code without using the memory table, proceed as follows:

1. Select Gen/Mon/Mtr DISPLAY position.
2. Use the keypad cursor keys to locate the cursor over the first digit in the frequency.
3. Use the numeric keys to enter a new frequency. The new frequency displays automatically when the power is turned on.
4. If a frequency is selected from the memory table, after a new frequency was entered directly, the frequency from the memory table takes precedence and it will appear when the Analyzer is turned off and on again.
5. To change or add PL or DPL codes in the generate mode, use the same procedure but move the cursor to the second line.

• **PRESET TURN-ON**

The Analyzer's normal internal configuration turns-on at Gen/Mon Mtr, FM, and PL/DPL. To program the system to turn-on at any other configuration, proceed as follows:

1. Press an arrow key to select the desired DISPLAY.
2. Press an arrow key to select the desired FUNCTION.
3. Press a MODULATION key to select the desired Code Synthesizer Mode.
4. Simultaneously depress both keypad cursor keys to obtain the special function display. Enter code number

71 to enter the new configuration into the nonvolatile memory.

5. Turn the POWER switch off and then on again. Check the display's accuracy.

6. To restore the system to normal turn-on configuration, follow steps 1 through 4 above.

• **SIGNALING SEQUENCE**

The complete signaling simulator in the system includes both encode and decode tone sequence synthesizer capability for the following MODULATION modes:

- Fixed 1 KHz tone
- Single tone variable
  - Private Line (PL)
  - Tone A or Tone B
- Digital Private Line (DPL) sub-audible squelch
- Two-tone sequential paging
- 5/6 tone paging
- Select V signaling
- General sequential, ten-tone
- Mobile telephone signaling
  - (IMTS) improved mobile telephone system
  - (MTS) mobile telephone system
  - 2805 Hz
- Tone Remote, base station

SIGNALING SEQUENCE MODE SEL) 0  
ENTER 0 FOR MENU

- 1) A/B ENCODE
- 2) 5/6 TN ENCODE/DECODE
- 3) SELECT V ENCODE/DECODE
- 4) PL DECODE
- 5) DPL DECODE
- 6) GENERAL SEQ ENCODE/DECODE
- 7) MOBILE TELEPHONE

MON/GEN SW FOR DECODE/ENCODE

**FIGURE 3-21.**  
**SIGNALING SEQUENCE MENU DISPLAY**

• **SIGNALING SEQUENCE MENU**

Figure 3-21 defines the Signaling Sequence menu for page 0 showing the set of seven sub-displays or pages, one for each family of encode and decode tone sequences. During the menu display no sequence output is possible. To select a page, place the cursor over 0 on line 1 and enter a number from 1 to 7. The system generates the selected family's sequence.

**NOTE:**

The sensitivity of the decode circuits is controlled by the OSCILLOSCOPE Vert switch and vernier. For best results, set the control for a 90% of full-screen deflection in the oscilloscope mode. Too little signal causes a NO INPUT SIGNAL indication on the screen; too high causes wandering or erroneous readings.



• **DECODE MODE SCREENS**

All decode screens have a "start" decode select. This will start the specified decode and put the software into a tight loop. This assures the best accuracy possible, but to do so, the analyzer ignores all switch selections and key entries except to go to the "menu" or to "end" the decode loop. During the decode loop, a "DECODE" message appears near the top of the screen. In general, a "0" entry on the 2nd line will return the screen to menu, a "1" entry starts a decode or will reset a decode in process, and a "2" will end the decode.

SIGNALING SEQUENCE MODE SEL) 4  
 0) MENU      1) START      2) END

**PL DECODE**

FREQ: 076.3  
 CODE: -

**FIGURE 3-22. PRIVATE LINE DECODE DISPLAY**

• **PL DECODE**

Select Signaling Sequence DISPLAY, Monitor FUNCTION, and PL Mode. Use special function control to select the signal source for the decoder. The decoder accepts signal inputs from either the internal monitor demodulator output or from the Ext Mod In port. The Analyzer decodes tone sequence, PL and DPL signals, to determine the generating code. Figure 3-22 shows a page 4 display of a decoded PL frequency and code. Frequencies readout to a maximum 300 Hz with 0.1 Hz resolution. The code of the nearest valid frequency will be displayed. Dashes display if the frequency exceeds the limit. Table 3-5 lists all valid PL codes and their frequencies.

<u>PL CODE</u>	<u>FREQ. HZ</u>	<u>PL CODE</u>	<u>FREQ. HZ</u>
XZ	67.0	4Z	136.5
WZ	69.3	4A	141.3
XA	71.9	4B	146.2
WA	74.4	5Z	151.4
XB	77.0	5A	156.7
WB	79.7	5B	162.2
YZ	82.5	6Z	167.9
YA	85.4	6A	173.8
YB	88.5	6B	179.9
ZZ	91.5	7Z	186.2
ZA	94.8	7A	192.8
ZB	97.4	M1	203.5
1Z	100.0	8Z	206.5
1A	103.5	M2	210.7
1B	107.2	M3	218.1
2Z	110.9	M4	225.7
2A	114.8	9Z	229.1
2B	118.8	M5	233.6
3Z	123.0	M6	241.8
3A	127.3	M7	250.3
3B	131.8		

**TABLE 3-5. VALID PL CODES**

023	071	134	223	306	411	503	631	734
025	072	143	226	311	412	506	632	743
026	073	152	243	315	413	516	654	754
031	074	155	244	331	423	532	662	
032	114	156	245	343	431	546	664	
043	115	162	251	346	432	565	703	
047	116	165	261	351	445	606	712	
051	125	172	263	364	464	612	723	
054	131	174	265	365	465	624	731	
065	132	205	271	371	466	627	732	

**TABLE 3-6. VALID DPL CODES**

SIGNALING SEQUENCE MODE SEL) 5  
 0) MENU      1) START      2) END

DPL DECODE

DPL CODE: 321

- NO INPUT SIGNAL -

**FIGURE 3-23. DPL DECODE DISPLAY**

• **DPL DECODE**

Figure 3-23 shows a display of a detected valid code on page 5. If the system detects an invalid code, dashes replace the code number. Table 3-6 lists the valid DPL codes.

SIGNALING SEQUENCE MODE SEL) 1  
 ENTER 0 FOR MENU

A/B ENCODE  
 A) 01200.0 Hz

SEQ SEL) 1  
 B) 00300.0 Hz

	A	DLY	B	DLY	(SEC)
1)	0.40	0.00	0.20	1.00	TONE
2)	1.00	0.00	3.00	1.30	TN&VCE
3)	0.10	0.10	0.10	0.10	
4)	0.20	0.20	0.20	0.20	

SCOPE TRIG DLY) 0.000 SEC

**FIGURE 3-24. TWO TONE (A/B) ENCODE DISPLAY**

• **A/B ENCODE**

Figure 3-24 shows a display for page 1 of the menu. To select sequence input, enter a number from 1 to 4. Enter Tone A and Tone B frequencies. Each frequency has a maximum value of 20,000 Hz with a resolution of 0.1 Hz. The system responds to changes in the tone frequency to allow the next complete signaling sequence to be executed with the new tone frequency. The majority of two-tone pagers use the first two fixed sequences listed in the tone sequence table. The operator cannot change the first two sequences but he can change the last two. Each delay entry has a maximum value of 10 seconds. The system responds to new entries during an active sequence to allow the next complete signaling sequence to be executed with the new timing information. For triggered sweep on the oscilloscope program the scope trigger delay to a maximum 10 seconds (0.001 second resolution). If time entered exceeds Tone Sequence time, the oscilloscope will not trigger. Enter 000.0 to disable trigger delay.

• **TWO-TONE SEQUENTIAL PAGING**

Program a two-tone pager access sequence with Tone A and Tone B frequencies, tone durations, and time between tones as defined in figure 3-24. Select Tone Sequence mode for the code synthesizer, A/B sequence on the Signaling Sequence DISPLAY, and Generate FUNCTION. The timing format for this mode consists of Tone A for the programmed time, followed by the programmed delay, followed by Tone B for the programmed time, followed by the second programmed delay. This sequence will repeat in continuous position but generate only a single sequence in burst position.

SIGNALING SEQUENCE MODE SEL) 2  
 ENTER 0 FOR MENU

5/6 TONE ENCODE  
 1) 5-TONE SEQ

SEQ SEL) 2  
 2) 6-TONE SEQ

CAP CODE) 2-13340X

SCOPE TRIG DLY) 0.000 SEC

**FIGURE 3-25. 5/6 TONE ENCODE DISPLAY**

• **5/6 TONE ENCODE**

Figure 3-25 shows an encode display for page 2 of the menu. Select either 5-tone or 6-tone paging. Table 3-7 lists the cap code digits and their frequencies. Enter the cap code digit for the desired output sequence. The code has a preamble tone number followed by a 5-digit sequence number. An X automatically appears at the end of the cap code. The system responds to changes in the cap code to allow the next complete signaling sequence to be executed with the new code information. The sixth or X tone may not be transmitted by selecting the 5-tone sequence. If the tone is not transmitted, a delay equal to the normal tone X time is inserted. With the MODULATION switch in continuous position, the output consists of the preamble tone followed by a continuous cycling 5 or 6 tone sequence. Cycling terminates only when the switch is moved to the off position or the mode is

changed. Burst position generates a single cycle preamble tone followed by the 5 or 6 tone sequence after which the output terminates.

DIGIT	FREQUENCY HZ	DIGIT	FREQUENCY HZ
0	600	6	1446
1	741	7	1587
2	882	8	1728
3	1023	9	1869
4	1164	R	459
5	1305	X	2010

TABLE 3-7. CAP CODES

SIGNALING SEQUENCE MODE SEL) 2  
0) MENU 1) START 2) END

5/6 TONE DECODE

CODE: 2 - 4 5 3 1 1 X				
FREQ:	0082	1305	0741	1446
Hz	1164	1023	0429	
TIME:	.035	.035	.035	.035
SEC	.035	.035	.035	

- NO INPUT SIGNAL -

FIGURE 3-26. 5/6 TONE DECODE DISPLAY

• 5/6 TONE DECODE

Figure 3-26 shows the decode display on page 2. If the reset is activated by entering a "1" for "START", all decode information is replaced by dashes and the decoder sequence resumes. If the decode sequence detects the presence of the sixth or X tone, the X appears at the end of the code. Otherwise, that space remains blank. If the sequence detects an invalid frequency, a dash replaces that digit. The display shows the detected frequency for each digit of the cap code. The format staggers a line with the appropriate frequency directly below the code digit. Frequencies readout to a maximum value of 10,000 Hz with 1 Hz resolution. If the decode sequence cannot detect an input signal, a warning message displays. The display retains the last decoded sequence information, regardless of signal input condition, until the operator initiates another decode or changes the display.

SIGNALING SEQUENCE MODE SEL) 3  
ENTER 0 FOR MENU

SELECT V ENCODE SEQ SEL) 1  
1) ZVEI 2) MODIFIED ZVEI  
3) CCIR (70MS) 4) CCIR (100MS)  
5) EEA

ACCESS CODE) 12345

SCOPE TRIG DLY) 0.000 SEC

FIGURE 3-27. SELECT V ENCODE DISPLAY

• SELECT V ENCODE

Figure 3-27 shows an encode display on page 3. Select one of the five sequences to display the five-digit access code for Select V. The processor responds to the entry of a new access code to execute the next complete sequence. Table 3-8 lists tone frequencies and time duration in milliseconds for each digit of the five sequences. A sequence consists of a single series of five tones in response to the five-digit access code. Each tone lasts for the specified duration. Select single or repetitive cycles, using the burst or continuous switch position.

TONE NUMBER	ZVEI/B.O.S. HZ	MOD. ZVEI HZ	CCIR HZ	EEA HZ	CCIR HZ
1	1060	970	1124	1124	1124
2	1160	1060	1197	1197	1197
3	1270	1160	1275	1275	1275
4	1400	1270	1358	1358	1358
5	1530	1400	1446	1446	1446
6	1670	1530	1540	1540	1540
7	1830	1670	1640	1640	1640
8	2000	1830	1747	1747	1747
9	2200	2000	1860	1860	1860
0	2400	2200	1981	1981	1981
R*	2600	2400	2110	2110	2110
<b>TONE LENGTH</b>					
ms	70	70	100	40	70

\*R is the repeat tone which is inserted wherever there is a repeat of the same tone in adjacent time slots (Example: Encode 13334 as 13R34).

TABLE 3-8. SELECT V SEQUENCE SPECIFICATION

SIGNALING SEQUENCE MODE SEL) 3  
 0) MENU 1) START 2) END

SELECT V DECODE SEQ SEL) 1  
 1) ZVEI 2) MODIFIED ZVEI  
 3) CCIR (70MS) 4) CCIR (100MS)  
 5) EEA

CODE:	1	2	2	5	3
FREQ: HZ	1080	1160	2600	1530	1270
TIME: SEC	.070	.070	.070	.070	.070

FIGURE 3-28. SELECT V DECODE DISPLAY

• SELECT V DECODE

Figure 3-28 shows a decode display on page 3. Select one of the five sequences to display the decoded access code for Select V. If an invalid frequency is detected within the sequence, a dash replaces that digit. The display shows decoded tone frequencies for each code digit, to a maximum 10,000 Hz with 1 Hz resolution. The display shows the time duration that the tone for each digit was present, to a 1 second maximum with 1 millisecond resolution.

SIGNALING SEQUENCE MODE SEL) 6  
 ENTER 0 FOR MENU

GENERAL SEQ ENCODE

FREQ HZ	TIME MSEC	FREQ HZ	TIME MSEC
1) 10531.0	0030	2) 02000.0	0030
3) 03561.0	0030	4) 01876.0	0030
5) 11532.0	0030	6) 08471.0	0030
7) 00000.0	0000	8) 00000.0	0000
9) 00000.0	0000	10) 00000.0	0000

SCOPE TRIG DLY) 0.000 SEC

FIGURE 3-29. GENERAL ENCODE DISPLAY

• GENERAL ENCODE

Figure 3-29 shows the general encode display on page 6. Select one of the ten possible sequences. Enter the programmable tone frequency from 0 to 20,000 Hz and the time duration from 0 to 10,000 milliseconds. Press a code synthesizer key to select Tone Sequence Mode. Place the MODULATION switch in burst or continuous position to initiate the sequence. Each of the ten-tone frequencies will be generated in sequence for its duration before the generator proceeds to the next tone.

SIGNALING SEQUENCE MODE SEL) 6  
 0) MENU 1) START 2) END

GENERAL SEQ DECODE

FREQ HZ	TIME MSEC	FREQ HZ	TIME MSEC
1) - - - -	- - - -	2) - - - -	- - - -
3) - - - -	- - - -	4) - - - -	- - - -
5) - - - -	- - - -	6) - - - -	- - - -
7) - - - -	- - - -	8) - - - -	- - - -
9) - - - -	- - - -	10) - - - -	- - - -

- NO INPUT SIGNAL -

FIGURE 3-30. GENERAL DECODE DISPLAY

• GENERAL DECODE

Figure 3-30 shows a display for the general ten-tone sequence decode table on page 6. Frequencies and time durations are derived from the input signal. Frequency is displayed up to a maximum value of 9999 Hz (1 Hz resolution). No display in a FREQ field with a time duration in the TIME field indicates that a space occurred between the preceding tone burst and the following tone burst. Time is displayed up to a maximum value of 9999 milliseconds (1 ms resolution).

• MOBILE TELEPHONE SIGNALING

The Analyzer simulates base to mobile and mobile to base sequences. It generates the appropriate signaling sequence, verifies mobile radiotelephone response, decodes and displays tone frequencies and telephone numbers. An error message during a sequence indicates radio failure. To reset the mobile telephone decoder and initiate a new sequence, press "1" for "START" again.

SIGNALING SEQUENCE MODE SEL) 7  
 0) MENU 1) START 2) END

MOBILE TEL SEQ SEL)1  
 1) IMTS 2) MTS 3) 2805

TEST SEQ SEL) 1  
 2) BASE ORIG  
 TONE 1) 2000 Hz TONE 2) 1800 Hz

MOBILE ID -----  
 DIALED NO -----  
 GUARD FREQ ---- Hz  
 CONN FREQ ---- Hz  
 DISC FREQ ---- Hz

**FIGURE 3-31.  
 IMTS MOBILE ORIGINATED DISPLAY**

• **IMTS MOBILE ORIGINATED**

Figure 3-31 shows a page 7 display. Select one of the three phone systems, by Sequence Select and either mobile or base originated, by Test Sequence Select. Here the display shows a test sequence menu for IMTS with the information decoded from the mobile radio for a mobile originated sequence. The mobile ID and dialed number vary up to a maximum number of seven and ten digits, respectively. The maximum decoded frequency is 10,000 Hz with 1 Hz resolution. Error messages display under DISC FREQ (refer to the tone sequence diagrams in your IMTS Manual).

<u>ERROR</u>	<u>MESSAGE</u>
	B.O. means base originated; M.O. means mobile originated.
01	Incorrect IMTS tone. M.O. tone was not one of the three possible receive tones: Connect Guard Disconnect. This error can happen only after the guard tone has been received.
02	Too many digits decoded (IMTS - M.O.). The mobile ID or phone number had too many pulses (more than ten).
03	Time-out error (IMTS - M.O. or B.O.). Tone lasted longer than spec, in specified state.
04	Improper sequence (M.O.). Sent mobile ID before seize tone.
05	No guard tone (B.O.). Mobile doesn't respond to seize tone.

<u>ERROR</u>	<u>MESSAGE</u>
06	Illegal tone transition (M.O.). Mobile ID or phone number sequence is incorrect. For example, guard tone space, guard tone, or connect tone-space-connect tone would generate an error.

**TABLE 3-9. IMTS ERROR MESSAGES**

SIGNALING SEQUENCE MODE SEL) 7  
 0) MENU 1) START 2) END

MOBILE TEL SEQ SEL) 1  
 1) IMTS 2) MTS 3) 2805

IMTS TEST SEQ SEL) 2  
 1) MOBILE ORIG 2) BASE ORIG

MOBILE ID 7635412  
 GUARD FREQ ---- Hz  
 CONN FREQ ---- Hz  
 DISC FREQ ---- Hz

SCOPE TRIG DLY) 0.000 SEC

**FIGURE 3-32.  
 IMTS BASE ORIGINATED DISPLAY**

• **IMTS BASE ORIGINATED**

Figure 3-32 shows a page 7 display allowing the operator to enter a 1 to 7 digit ID for the mobile being tested. Enter a number in the most significant location. Dashes replace the desired number of digits. Enter the desired number of digits. The other digit locations remain as dashes. The processor responds to changes in the telephone number to allow the next complete dialing sequence to be executed with the new number. The display shows decoded signaling tone frequencies for an IMTS base originated sequence, with 10,000 Hz maximum frequency and 1 Hz resolution. Error messages display on the line above SCOPE. The Analyzer encodes and decodes the information defined by figures 3-31 and 3-32.

SIGNALING SEQUENCE MODE SEL) 7  
 ENTER 0 FOR MENU  
 BURST TO START

MOBILE TEL SEQ SEL) 2  
 1) IMTS 2) MTS 3) 2805

MTS  
 TONE 1) 2000 Hz TONE 2) 1800 Hz  
 MOBILE ID 7635412

SCOPE TRIG DLY) 0.000 SEC

**FIGURE 3-33. MTS MOBILE TELEPHONE DISPLAY**

• **MTS MOBILE TELEPHONE**

Figure 3-33 shows a page 7 display of tone 1 & tone 2 frequencies used in generating mobile telephone MTS

and 2805 sequences. Enter frequencies up to a maximum 10,000 Hz with 1 Hz resolutions. The processor responds to changes in tone frequencies to allow the next complete sequence to be executed with the new tone frequencies. The MTS sequence requires no test sequence select and has no mobile to base system.

SIGNALING SEQUENCE MODE SEL)7  
 ENTER 0 FOR MENU  
 BURST TO START

MOBILE  
 TEL  
 1) IMTS 2) MTS 3) 2805  
 2805  
 TONE 1) 0000 Hz  
 MOBILE ID - - - - -  
 TONE 2) 2805 Hz

FIGURE 3-34. 2805 BASE ORIGINATED DISPLAY

• 2805 BASE ORIGINATED

Figure 3-34 shows a page 7 display for the mobile telephone 2805 sequence, base originated. Figure 3-34 defines the encode information for 2805 sequences. The 2805 sequence requires no test sequence select and has no mobile to base system.

• TONE SEQUENCE

Select Tone Sequence Mode (memory display) for the code synthesizer. Encode in generate function, decode in monitor function, or use special function control to encode or decode in either generate or monitor function. The tone memory table displays details for all signaling systems. Program frequency, time duration, and time interval.

• TONE REMOTE (ENCODE)

The System can be used to simulate a tone remote control console, or to troubleshoot tone control decoding circuitry in remote base station. These useful tone bursts are available at the MOD OUT jack on the front panel so that they can be coupled onto phone lines or any other place they may be needed. Activate the tone bursts by selecting TONE REMOTE mode in the MODULATION section of the front panel. Select the two appropriate frequencies of the tone bursts by programming Tone A and Tone B frequencies in the Two-Tone paging sequence. Typical guard tone frequency (Tone A) is 2175 Hz. Function tones (Tone B) vary by system. Select Tone B from table 3-10. Refer to your Tone Remote Instruction Manual for detailed information.

Control & Function	1 Freq. Systems	2 Freq. Systems	Paging Systems
F1 Transmit	1950 Hz	1950 Hz	1950 Hz
F2 Transmit	N/A	1850 Hz	N/A
F1 Transmit w/o PL	N/A	N/A	1850 Hz
PL Monitor	2050 Hz	2050 Hz	2050 Hz
R2 Off/R2 On	N/A	1750/1650 Hz	N/A
Rptr Off/Rptr On	1550/1450 Hz	N/A	1550/1450 Hz
PL On/PL Off	1550/1450 Hz	1550/1450 Hz	1550/1450 Hz
Wild Card I	1350/1250 Hz	1350/1250 Hz	1350/1250 Hz
Wild Card II	1150/1050 Hz	1150/1050 Hz	1150/1050 Hz

TABLE 3-10. TONE B FUNCTIONS

Unlike the other signaling sequences, this special mode provides no repetitive sequences. Institute the TONE REMOTE sequence by moving the MODULATION switch to BURST or CONTINUOUS. The sequence issues TONE A for 115 ms followed by TONE B for 40 ms at a level 10 dB below that of Tone A. Tone A follows at a level 30 dB below that of the initial Tone A for as long as the MODULATION Switch is held in either the BURST or CONTINUOUS position. The level of these bursts is adjustable with the MOD LEVEL control, and may be observed with the MODULATION DISPLAY similar to any signaling sequence.

• TONE REMOTE (DECODE)

Connect the Analyzer's Vert/Sinad/Dist input to the Tone Remote unit's output. Select Signaling Sequence DISPLAY and Monitor FUNCTION. Select General Sequence Decode Mode, as shown in figure 3-30, and enter Special Function control code #11. The screen displays frequency and time duration for both high level guard tone (A) and function tone (B). After obtaining the information for F-1, press either keypad cursor key once to reset. Obtain information for F-2 and reset, etc.

GENERATE FM  
 PL) 936.0  
 04) 285.7750 MHz  
 DPL) - - -  
 COUNT MODE SEL) 2  
 1) FREQUENCY  
 2) PERIOD  
 RESOLUTION SEL) 6  
 1) 0.1 Hz  
 2) 1.0 Hz  
 3) 10 Hz  
 4) 100 Hz  
 5) 1 KHz  
 6) AUTO

INPUT FREQUENCY \* 10.723 MHz

- RANGE SW NOT AT MAX SENS POS -

FIGURE 3-35. FREQUENCY COUNTER DISPLAY



• **FREQUENCY COUNTER**

Figure 3-35 shows a Frequency Counter display. The internal Frequency Counter measures input from 10 Hz to 35 MHz. To measure signals higher than 35 MHz, use the frequency error readout in the monitor mode. The CRT displays an autoranging output allowing the operator to measure precisely and set offset oscillators, IF's, PL frequencies, and other external input signals. Frequency counter operates in either generate or monitor function. Use PL/DPL decode modes for measuring these codes off the air. Enter number 1 or 2 to select either frequency counting or period counting. In the counting mode, select one of the five display resolutions or automatic ranging. Frequency counting is preferred above 1 KHz. Period counting is preferred below 1 KHz. Adjust sensitivity with the OSCILLOSCOPE Vert switch and vernier. For best results, set the control for a 90% of full-screen deflection. Too little signal causes a NO INPUT SIGNAL indication on the screen; too high causes wandering or erroneous readings. The display shows the calculated input frequency, the five digit frequency readout with operator selected resolution, the acronym for the multiplier (Hz, KHz, MHz) and position of the decimal point as identified in table 1. The system automatically ranges to display the best resolution of the input frequency consistent with table 1. If the operator selects a resolution inconsistent with table 1, an appropriate warning message: INCREASE RESOLUTION or DECREASE RESOLUTION replaces this entire line. The processor programs for a new resolution and attempts a new frequency reading. When the processor updates a frequency, the asterisk on line 12 blanks for 0.1 second. The warning message displays on line 14, whenever the input range attenuator is not in its most sensitive position. Table 3-11 lists the relationships between frequency and resolution.

Counting Multiplier	Resolution Hz				
	0.1	1	10	100	1000
<b>Frequency</b>					
Hz	0.0-6000.0	NA	NA	NA	NA
KHz	NA	0.0-6000.0	0.0-600.0	0.0-6000.0	NA
MHz	NA	NA	NA	NA	0.0-35.0
<b>Period</b>					
Hz	2.0-999.9	10-2999	NA	NA	NA
KHz	NA	NA	0.0-9.99	0.0-29.9	0.0-99.9
MHz	NA	NA	NA	NA	NA

TABLE 3-11. VALID INPUT FREQUENCY VERSUS DISPLAY RESOLUTION

• **(DVM/DIST) DIGITAL VOLTMETER/ DISTORTION MODE**

The Analyzer provides an AC-DC voltmeter. The voltage automatically ranges between full scale values of 1, 10, 100, and 300 volts. The CRT displays the voltage

and the corresponding dBm value. Use the voltmeter to check audio level, bias level, and power supply voltage. The voltmeter operates in generate or monitor function. Connect the probe RTL-4011A to the Vert/Sinad/Dist connector. Move the cursor to the mode select position. Select AC, DC, or DISTORTION mode, as required. Implement fixed ranges with special function control techniques.

**WARNING**

THE METER'S COMMON LEAD IS CONNECTED TO THE ANALYZER'S CHASSIS GROUND. DO NOT ATTEMPT TO MEASURE FLOATING CIRCUITS WITH THE ANALYZER, BECAUSE THAT WOULD CONNECT THE FLOATING CIRCUIT TO GROUND! FOR EXAMPLE, DO NOT MEASURE AC POWER MAINS WITH THE ANALYZER. SERIOUS SHOCK HAZARD COULD RESULT.

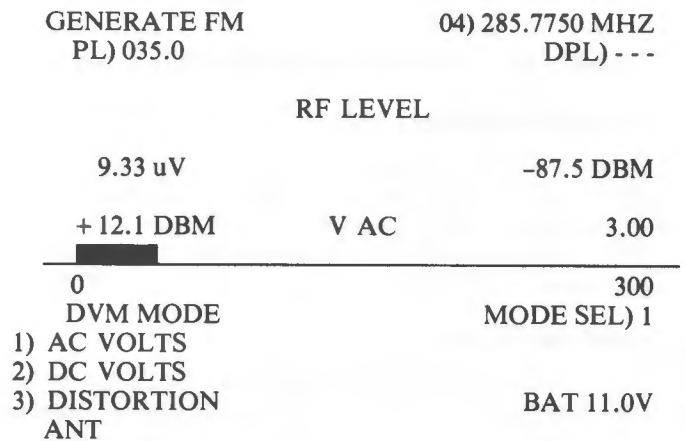

FIGURE 3-36. AC DVM DISPLAY

Figure 3-36 shows an AC DVM display of the center frequency and the PL or DPL code in the generate mode. The bargraph responds to the magnitude of the voltage in a modified logarithmic manner to provide a smooth nonranging analog display. Line 14 displays the voltage of the primary DC power source.

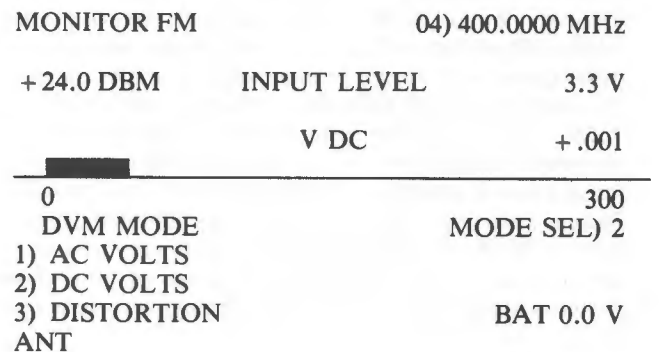

FIGURE 3-37. DC DVM DISPLAY



Figure 3-37 shows a DC DVM display of the + or - input voltage. In the DC mode, the voltage response to frequencies above 50 Hz attenuates at least 20 dB.

MONITOR FM	04) 285.7750 MHz
-30 DBM	INPUT LEVEL 2.94 mV
03.0 PCT	DIST/SINAD 30.5 DB
DVM MODE	MODE SEL) 3
1) AC VOLTS	
2) DC VOLTS	
3) DISTORTION	BAT 11.0 V
ANT	ATTEN) 0

FIGURE 3-38. DISTORTION ANALYZER DISPLAY

Figures 3-38 and 3-12 show displays for the DISTORTION mode which automatically measures fixed frequency (1 KHz) EIA Sinad/Distortion in the generate or monitor function. Select mode 3 to obtain measurements.

EXT WATTMETER	ELEMENT NO. 5	
1) 2.5	2) 5	3) 10
4) 25	5) 50	6) 100
7) 250	8) 500	9) 1000
	FWD WATTS	1.25
		2.5
	REV WATTS	0.25
		2.5
ANT	ATTEN) 0	

FIGURE 3-39. EXTERNAL WATTMETER DISPLAY

• EXTERNAL WATTMETER

To measure forward and reflected antenna power, connect Motorola's wattmeter (series ST-1200) with the front panel phone jack input. The accessories include a wattmeter adapter (RTL-4055B) to accept the external elements. Figure 3-39 shows the External Wattmeter DISPLAY. Select an entry from one to nine to obtain the appropriate element power range. The CRT displays the nonranging digital reading for the detected power flowing in the forward direction. The bargraph responds logarithmically in proportion to the forward wattmeter reading on a full scale equal to the wattage range of the selected element. The detected power flowing in the reverse direction displays similarly. The Analyzer contributes not more than  $\pm 2.5\%$  of reading to the readout error for power levels greater than 10% of full scale. Table 3-12 describes the external wattmeter elements.

Frequency (MHZ)	Maximum Power (Watts)	"N" Type Connector Model	"UHF" Type Connector Model
2-30	250	-	ST-1296
2-30	2500**	-	ST-1299
25-60	5	ST-1280B	ST-1281B
25-60	10	ST-1285B	ST-1284B
50-125	5	ST-1283B	ST-1282B
50-125	10	ST-1286B	ST-1287B
25-100	25	ST-1204B	ST-1244B
25-100	50	ST-1205B	ST-1245B
25-100	100	ST-1206B	ST-1246B
25-100	250	ST-1207B	ST-1247B
25-100	500****	ST-1208B	ST-1248B
100-250	5	ST-1212B	ST-1252B
100-250	10	ST-1213B	ST-1253B
100-250	25	ST-1214B	ST-1254B
100-250	50	ST-1215B	ST-1255B
100-250	100	ST-1216B	ST-1256B
100-250	250	ST-1217B	ST-1257B
100-250	500****	ST-1218B	ST-1258B
200-250	2.5	ST-1221B	ST-1261B
200-550	5	ST-1222B	ST-1262B
200-550	10	ST-1223B	ST-1263B
200-550	25	ST-1224B	ST-1264B
200-550	50	ST-1225B	ST-1265B
200-550	100	ST-1226B	ST-1266B
200-550	250	ST-1227B	ST-1267B
200-550	500****	ST-1228B	ST-1268B
500-1000	2.5	ST-1231B*	ST-1271B
500-1000	5	ST-1232B*	ST-1272B
500-1000	10	ST-1233B*	ST-1273B
500-1000	25	ST-1234B*	ST-1274B
500-1000	50	ST-1235B*	ST-1275B
500-1000	100	ST-1236B*	ST-1276B
500-1000	250***	ST-1237B*	ST-1277B
500-1000	500***	ST-1238B*	ST-1278B

\* The N type connector is recommended for best accuracy in the 500-1000 MHz frequency range.

\*\* Calibrated at 1000 W, but useable to 2500 W.

\*\*\* Calibrated at 125 W, useable to full scale.

\*\*\*\* Calibrated at 250 W, useable to full scale.

TABLE 3-12. EXTERNAL WATTMETER ELEMENTS

• INTERMEDIATE FREQUENCY (IF) MODE

The Analyzer's IF envelope displays on the CRT when the IF mode is selected. Use the IF mode to qualitatively and quantitatively assess a transmitter's amplitude modulation envelope.

### 3.7 OSCILLOSCOPE SECTION



FIGURE 3-40. OSCILLOSCOPE SECTION

#### • SCOPE AC OR SCOPE DC

The Analyzer provides a general purpose 500 KHz oscilloscope with calibrated vertical input sensitivities and automatic or triggered horizontal sweep rates (figure 3-40). Both vertical and horizontal inputs may be switched between internal and external sources. Use the scope to analyze waveforms, view modulation signals (generated internally or externally), detect asymmetric modulation or audio distortion, trace signals, and troubleshoot. The vertical input is combined with the BNC port that also serves as the input for DVM, Sinad/Dist meter, and Frequency Counter. The Cover's accessories include probe #RTL-4011A for vertical and horizontal inputs.

The horizontal time base generator provides a linear horizontal sweep from a minimum rate of 100 ms per division to a maximum rate of 1 us per division in six decade ranges selectable with the Horizontal control. Use the oscillator Trigger Level switch in automatic or normal position to synchronize the horizontal time base to the vertical input signal. In automatic mode, the scope will trigger continuously. In normal mode, the scope will trigger when the vertical signal exceeds the level set by the control. The smaller trigger level control adjusts the level at which a positive going signal triggers the time base. A separate front panel BNC port provides for the External Horizontal input enabled by a seventh position on the time base control switch. The input sen-

sitivity varies continuously over the minimum range from 0.1 volt per division to 10 volts per division. Adjust sensitivity with the Vert switch and control.

The time base is calibrated with the vernier control fully clockwise. Normal operation does not include a character display in either Scope AC or Scope DC mode. However, if the operator also selects a SWEEP FUNCTION, then the first character line on the CRT identifies the operating center frequency. The synchronized scope displays the swept response symmetrically about the selected carrier center frequency. When Scope AC or Scope DC DISPLAY is selected in conjunction with sweep function, the oscilloscope horizontal input is coupled to the sweep signal. When the scope trace is at the center of the screen ( $\pm 1$  minor division) the instantaneous RF output frequency will be equal to the programmed frequency.

#### NOTE

In all cases the bargraph aids the autoranging digital scale. The bargraph responds in a modified logarithmic manner that provides a smooth nonranging analog display. In other words, the analog display will change the same amount for a 1 volt change at 10 volts as for a 25 volt change at 250 volts.

Function	Analog Bargraph Full Scale Range
Power Monitor (above 1w)	0-125w
Frequency Error	0-15KHz
FM Modulation	0-100KHz
AM Modulation	0-100%
DVM (AC or DC)	0-300V
DIST/SINAD	0 to 100% (Dist) -60db to 0db (SINAD)
Ext Wattmeter	Wattmeter Element dependent 0-2.5w to 1000w

#### SPECTRUM ANALYZER USAGE

The indicated rf signal level in the spectrum analyzer mode is 30db less than actual input at the RF In/Out port.

When using the spectrum analyzer for measuring harmonics of the rf carrier, it is necessary to limit the level of the rf carrier to less than -20dbm (RF In/Out port) or less than -50 dbm (Antenna port) with an external attenuator in order to maintain the correct harmonic relationship to the rf carrier.

# ADDENDUM

## • SELF-TEST DISPLAYS

The self-test check may be executed at anytime during system operation by executing special function 72.

The screens for the different self tests are outlined below. If the self test is initiated by a power up, the destructive RAM test is performed first. It erases volatile memory, then stores sequential numbers into RAM to check for any addressing problems in the RAM. If an error is detected, the following screen is displayed, see Figure 3-41. The operator may enter a "0" if he wishes to proceed even if an error exists. If the operator does not respond in a minute, the testing will proceed even without an entry.

The Test Equipment Service Center should be consulted to remedy the error.

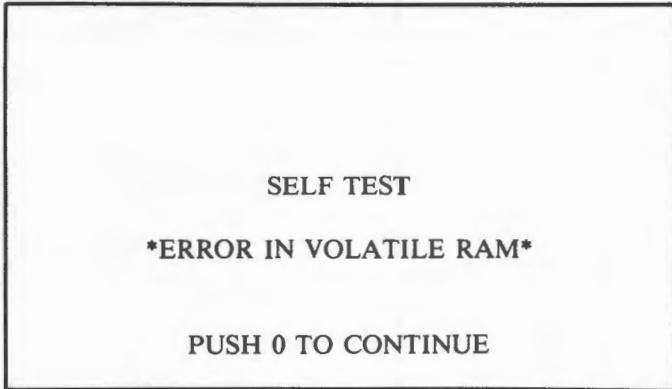

**FIGURE 3-41.**  
**DESTRUCTIVE RAM TEST ERROR SCREEN**

After the destructive RAM test is performed on volatile memory, then a non-volatile memory check is performed to check to see that a bit pattern stored there has not been corrupted. If it has, the following screen is displayed, see Figure 3-42. If the operator wants to reinitialize the non-volatile RAM, a "1" is entered. If the existing non-volatile memory is desired, even though an error has been detected, a "0" is entered. If the error persists, the battery on the microprocessor board should be checked. After a minute, the test will proceed as if a "0" had been entered.

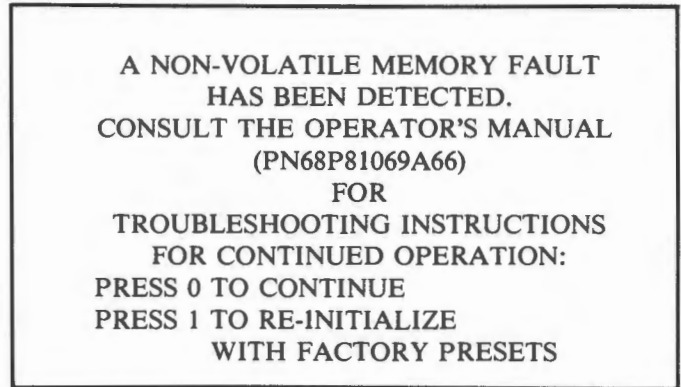

**FIGURE 3-42.**  
**NON-VOLATILE RAM ERROR SCREEN**

After the non-volatile RAM test on power up, or if the operator initiates a self test with a special function 72, a checkerboard pattern is displayed on the screen, see Fig. 3-43. This serves as a visual check of the display to verify proper alignment of the CRT.

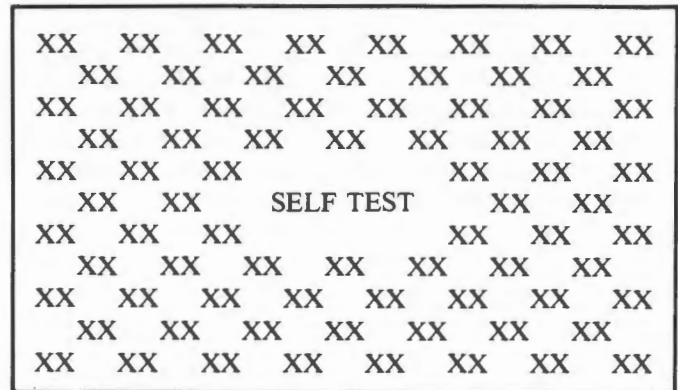

**FIGURE 3-43. CHECKERBOARD PATTERN**

A non destructive RAM test is performed that stores known characters to each RAM location. The value is read back and verified. The original value is finally replaced. If an error is detected, the following display is shown; see Fig. 3-44. The operator may enter a "0" to continue the self test. Otherwise, the test resumes automatically after about a minute.

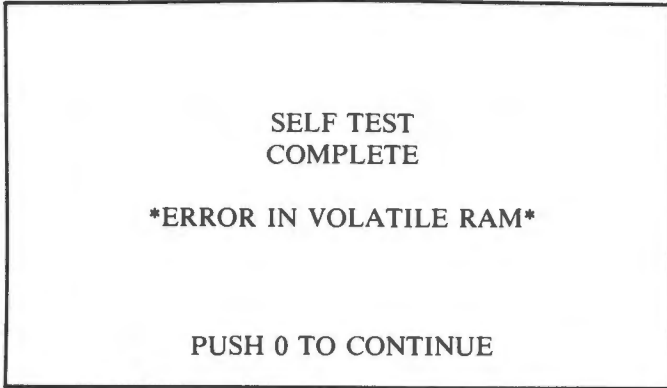

**FIGURE 3-44.**  
**NON-DESTRUCTIVE RAM TEST ERROR**

Next, a checksum check is performed to verify that the PROM program has not changed. The error screen for this type of error is shown in Fig. 3-45. If a checksum error is detected in an PROM device, then an alphanumeric specifier identifies the socket it is in. M1 identifies the PROM device in the leftmost socket on the microprocessor board, M2 the 2nd from the left, M3 the 3rd from the left, and so on. The operator can enter a "0" to allow testing to proceed. If no entry is made in a minute, the test will proceed automatically.

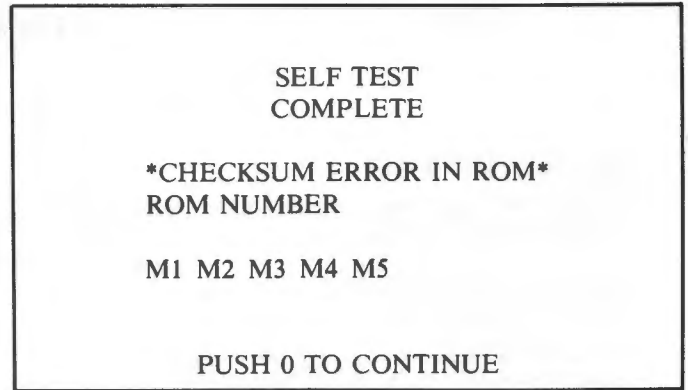

**FIGURE 3-45. CHECKSUM ERROR SCREEN**

**NOTE**

If a non-destructive RAM error and checksum error are both detected, then they appear on the same screen.

The testing is completed with a final checkerboard pattern with a "SELF TEST COMPLETED" message.

# SECTION 4 APPLICATIONS

## 4.0 SERVICE SHOP SETUPS

This section of the manual guides troubleshooting, diagnosing, and adjusting communications equipment ranging from pocket pagers to repeaters. It contains information on how to connect equipment under test to the R-2001D Analyzer and how to set controls and indicators to obtain the anticipated CRT display. Maintain a permanent written log of all measurements and information important to your operation.

### CAUTION

These are typical applications and are not all-inclusive. Not every test works with every transceiver. Motorola takes no responsibility for their accuracy, applicability, or safety. Always refer to your own transceiver's service manual for recommended test methods and specifications.

The Analyzer's DVM input is unbalanced (ground referenced). Use an appropriate interface to measure balanced circuits, such as certain receiver audio outputs or telephone lines.

# RECEIVER SENSITIVITY TEST 12 DB SINAD AUDIO DISTORTION

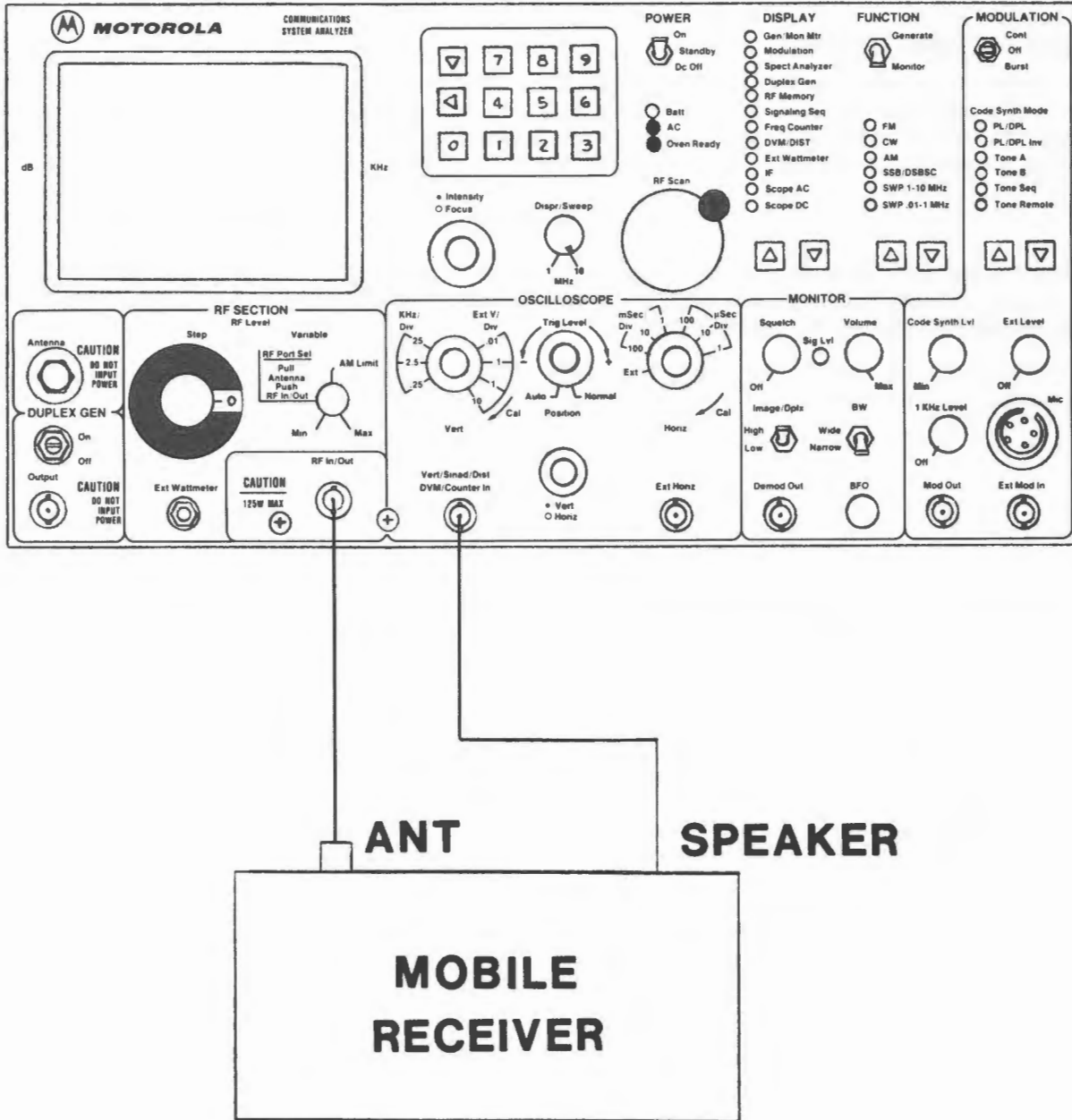

FUNCTION	GENERATE FM . . )	50000 MHZ	FREQUENCY
	PL) 100.0	DPL) . . .	DPL CODE
DIGITAL DIST READING	RF LEVEL		RF OUTPUT LEVEL
ANALOG SINAD INDICATOR	1000uV	-47.0 DBM	DIGITAL SINAD OR DISTORTION READING
	5.0 PCT DIST/SINAD	26.0 DB	
NEG DEVIATION	-3.0	DEV KHZ	POS DEVIATION
			ANALOG DEVIATION INDICATOR

FIGURE 4-1. 12 DB SINAD TEST SETUP AND DISPLAY

**RECEIVER SENSITIVITY TEST  
12 DB SINAD  
AUDIO DISTORTION**

Use the R-2001D signal generator and SINAD meter to measure a receiver's performance by the following procedure:

1. As shown in figure 4-1, connect the Analyzer's RF In/Out to the antenna connector of the receiver under test. Connect the Analyzer's Vert/Sinad/Dist to the receiver's audio output. Disable all PL's and open the Squelch.
2. Set DISPLAY to Gen/Mon Mtr mode. Select a FUNCTION and set the FUNCTION switch to Generate.
3. Select the RF carrier frequency from an RF Memory table channel number or enter directly from the keypad.
4. Adjust 1KHz Level control for 60% of rated deviation as indicated on the CRT. To prevent spurious noise modulation, set MODULATION switch to Off and Ext Level control to Off.
  - a. With a 1000uV RF input level, adjust the volume control to rated audio power output. EIA RS-204-C specifies that the receiver be set to produce rated audio power before measuring 12dB SINAD.
  - b. Read % distortion directly from the DIST/SINAD scale.
5. Set RF Step attenuator to -110dB and the variable control to mid-range. The display's RF LEVEL should indicate about 2uV. Adjust the attenuator (10dB steps) and the variable RF control until a 12dB SINAD reading appears on the display.
6. From the RF LEVEL on the display, read the receiver's 12dB SINAD sensitivity in uV and dBm.





**RECEIVER SENSITIVITY TEST  
20 DB QUIETING**

1. Connect the Analyzer to the receiver under test, as shown in Figure 4-2. Set DISPLAY to DVM/DIST, FUNCTION switch to Monitor and select FM or CW FUNCTION.
2. Turn on the receiver (unscelched) and turn up the receiver audio gain to feed audio noise to the Analyzer (at least 1/4 rated audio power). Read the audio noise voltage fed to the Analyzer. Note the noise reading (REF) in dBm.
3. Set FUNCTION switch to Generate. With all modulation off, adjust RF LEVEL until display reads 20 dB less than REF above (0.10X the REF Voltage).
4. Read the RF LEVEL reading required to produce 20 dB quieting in uV (left side) and dBm (right side) on the CRT screen.

# SQUELCH SENSITIVITY TEST

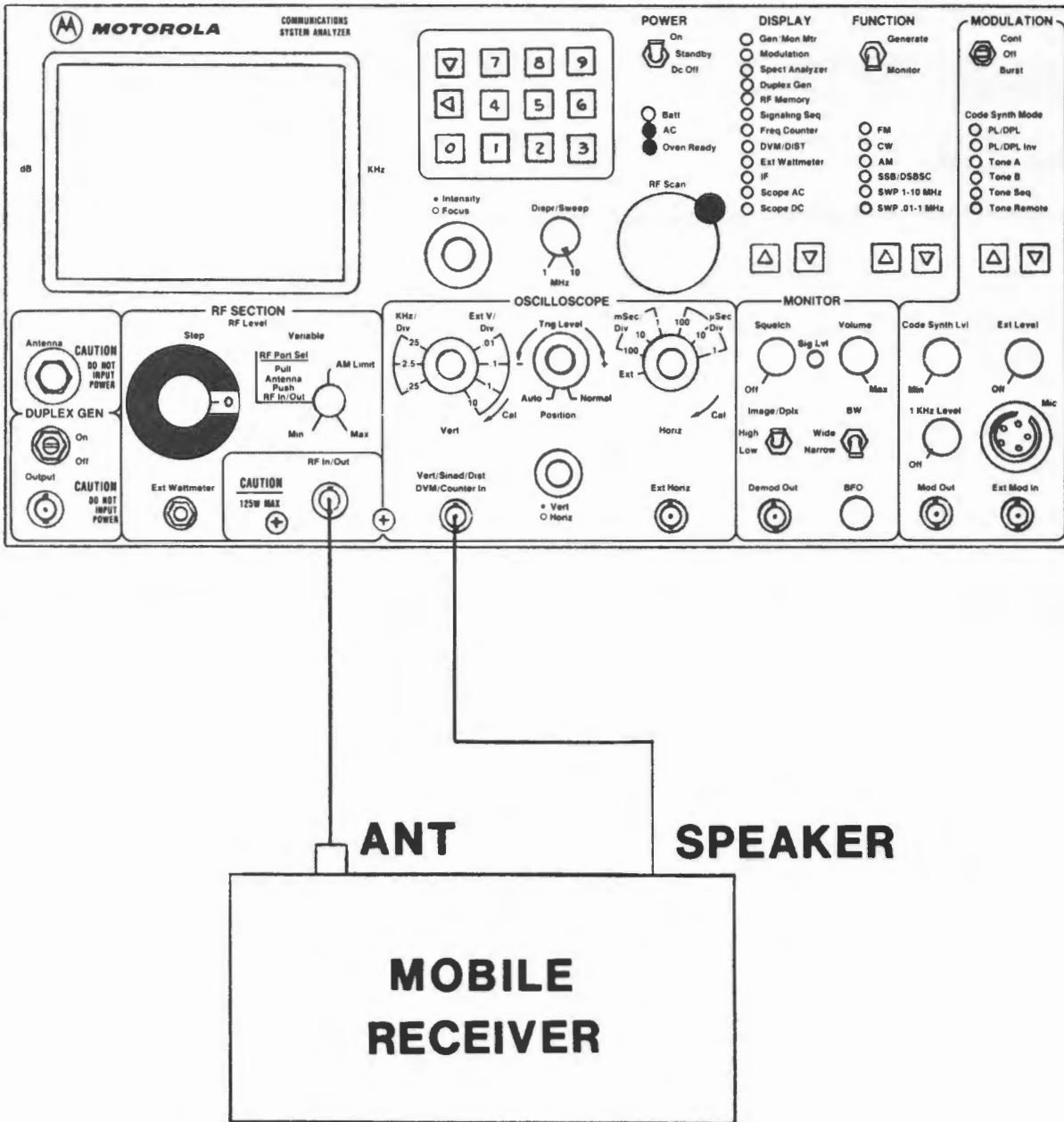

FIGURE 4-3. SQUELCH SENSITIVITY TEST SETUP

### SQUELCH SENSITIVITY TEST

1. Connect the Analyzer to the receiver under test, as shown in figure 4-3. Set DISPLAY to Gen/Mon Mtr, FUNCTION switch to Generate FM, and enter the frequency of the receiver under test.
2. To check PL/DPL squelch sensitivity, enter the proper PL/DPL code from the keypad. Set MODULATION switch to Cont in the PL/DPL Mode.
3. Adjust the Code Synth Level control to provide a nominal 750 Hz (500 Hz - 1 KHz) deviation of the PL/DPL code. To check carrier squelch, turn off all modulation.
4. Place FUNCTION switch to monitor to remove the RF output from the receiver. Set the receiver's squelch control to the point where the receiver just barely quiets.
5. Return FUNCTION switch to Generate. Increase the RF LEVEL by adjusting the attenuator and Variable controls until the receiver just unquietes.
  - a. On the display, read minimum squelch sensitivity as uV or dBm. This is the threshold squelch sensitivity of the receiver.
  - b. Determine the tight squelch sensitivity of the receiver by repeating steps 4 and 5 with the receiver's squelch control set to maximum tightness.
6. Enable the receiver's PL/DPL squelch circuit. Fully open the carrier squelch control. Increase the RF LEVEL from minimum, as in step 5, until the receiver's squelch just opens. On the display, read the coded squelch sensitivity in uV or dBm.

### AUDIO POWER OUTPUT TEST

1. Set DISPLAY to Gen/Mon Mtr and FUNCTION switch to Generate FM. Enter the RF frequency and PL code.
2. Adjust attenuator and Variable controls to 1000 uV (-47 dBm). Adjust the 1 KHz Level control to 60% of the rated deviation on the DEV KHz scale. Push the Variable control in to select the RF In/Out connector.
3. Change DISPLAY to DVM/Dist and use the keypad to select DVM AC function.
4. Connect a suitable resistive load, that can dissipate the receiver's rated audio output, in place of the speaker. (If the receiver uses a "floating" or "bridge" output amplifier, connect a 1:1 isolation transformer across the load resistor.)
5. Connect a scope probe to the Analyzer's Vert/Sinad/Dist input connector and clip the probe across the load resistor or to the isolation transformer.
6. Connect the RF In/Out to the receiver's antenna port. Adjust the receiver's volume control for the highest voltage reading on the DVM AC scale which does not have clipping or other distortion in excess of radio specs.
7. Calculate the audio power output by the following formula:

$$\text{Power Out (Watts)} = \frac{(\text{AC Volts})^2}{\text{Load Resistance (Ohms)}}$$

8. If the receiver does not produce rated audio power output, use the Analyzer's OSCILLOSCOPE and a scope probe to trace through the audio stages and locate the problem.

# AUDIO FREQUENCY RESPONSE

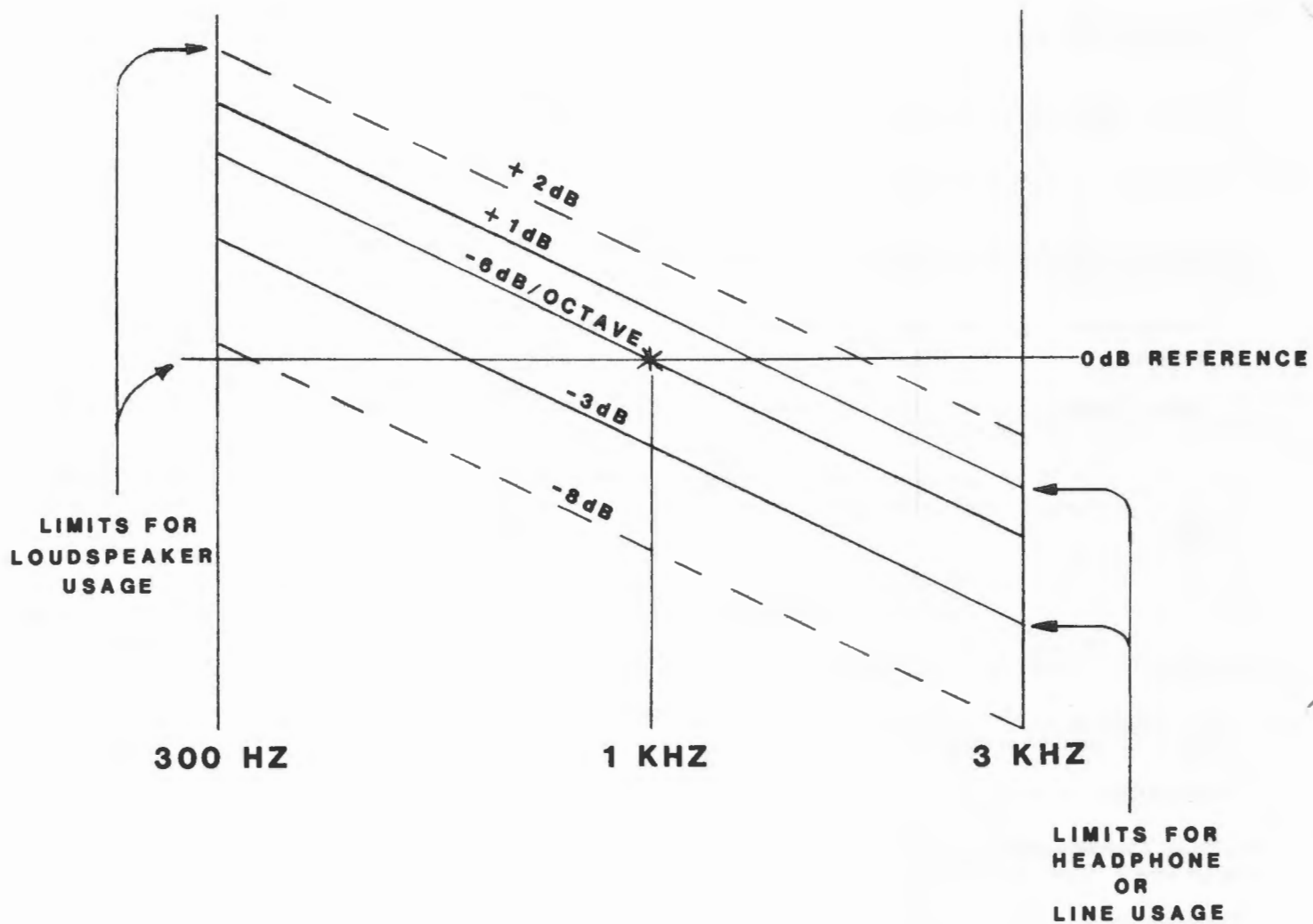

FIGURE 4-4. AUDIO FREQUENCY RESPONSE; EIA STANDARD RS-204C

## AUDIO FREQUENCY RESPONSE

1. Use the keypad to enter the frequency and PL/DPL code (if any) of the receiver under test.
2. Set FUNCTION to Generate FM, attenuator and Variable level controls to 1000 uV (-47 dBm).
3. Select tone memory display and set Tone A to 1000 Hz. Set MODULATION switch to Cont, Code Synthesizer Mode to Tone A, and change DISPLAY to Gen/Mon Mtr.
4. Adjust the Code Synth Level control for 20% of rated deviation on the DEV KHZ scale, for example: 1 KHz in a 5KHz system. Change DISPLAY to DVM/Dist and select DVM AC function.
5. Connect the Analyzer's RF In/Out out to the receiver's antenna port. Push the Variable control in to select the RF In/Out connector. Connect the Vert/Sinad/Dist input connector to the receiver's speaker output, using a scope probe. If the speaker is "floating", use an isolation transformer to avoid shorting the output stage.
6. Adjust the receiver's volume control to obtain a reference level reading on the AC volts scale which is free of clipping at any frequency within the 300 to 3,000 Hz band. Note this reading in dBm as the reference value.
7. Refer to the audio response curve in the receiver's Service Manual. Change the Tone A frequency on the tone memory screen to the value for each point on the curve to be measured.
8. Maintain FM deviation at 20% of the rated deviation, as set in step 4. Change DISPLAY to DVM AC and read the audio level at this frequency. Note this audio level. Repeat this step for each frequency tested.
9. EIA RS-204C specifies the frequency response for NBFM receivers over the range of 300 to 3000 Hz as follows:
  - a. Audio response for receivers using loud-speakers shall not vary more than +2 dB or -8 dB from a standard 6 dB per octave curve, with reference taken as 1000 Hz.
  - b. Audio response for receivers using either headphones or telephones lines shall not vary more than +1 dB or -3 dB from a standard 6 dB per octave curve, with reference taken at 1000 Hz.
10. Add or subtract the 1 KHz reference value from each reading taken in step 7. Plot the resulting values on a curve and compare them with the 6 dB per octave curve in your receiver's Service Manual or with the standard EIA specification RS-204C, as shown in figure 4-4.

## MODULATION ACCEPTANCE BANDWIDTH

1. Perform the 12 dB SINAD Sensitivity Test with the Analyzer in the same setup as shown in figure 4-1. **Note:** It is necessary to perform this test with the volume control set to 10% of rated audio output.
2. Increase the RF output level 6 dB above the 12 dB SINAD level, to double the voltage. For example, 0.35 uV increased 6 dB = 0.7 uV.
3. Turn the 1 KHz Level control clockwise to increase the deviation until the SINAD level returns to 12 dB. Read the amount of deviation on the display as the modulation acceptance bandwidth of the receiver.
4. A typical modulation acceptance value for a receiver is 7 KHz. Refer to the specification for the specific receiver under test. Any loss of modulation acceptance bandwidth indicates improper alignment or a component failure in a receiver's IF circuit.

# RF PRESELECTOR SHAPE & BANDWIDTH

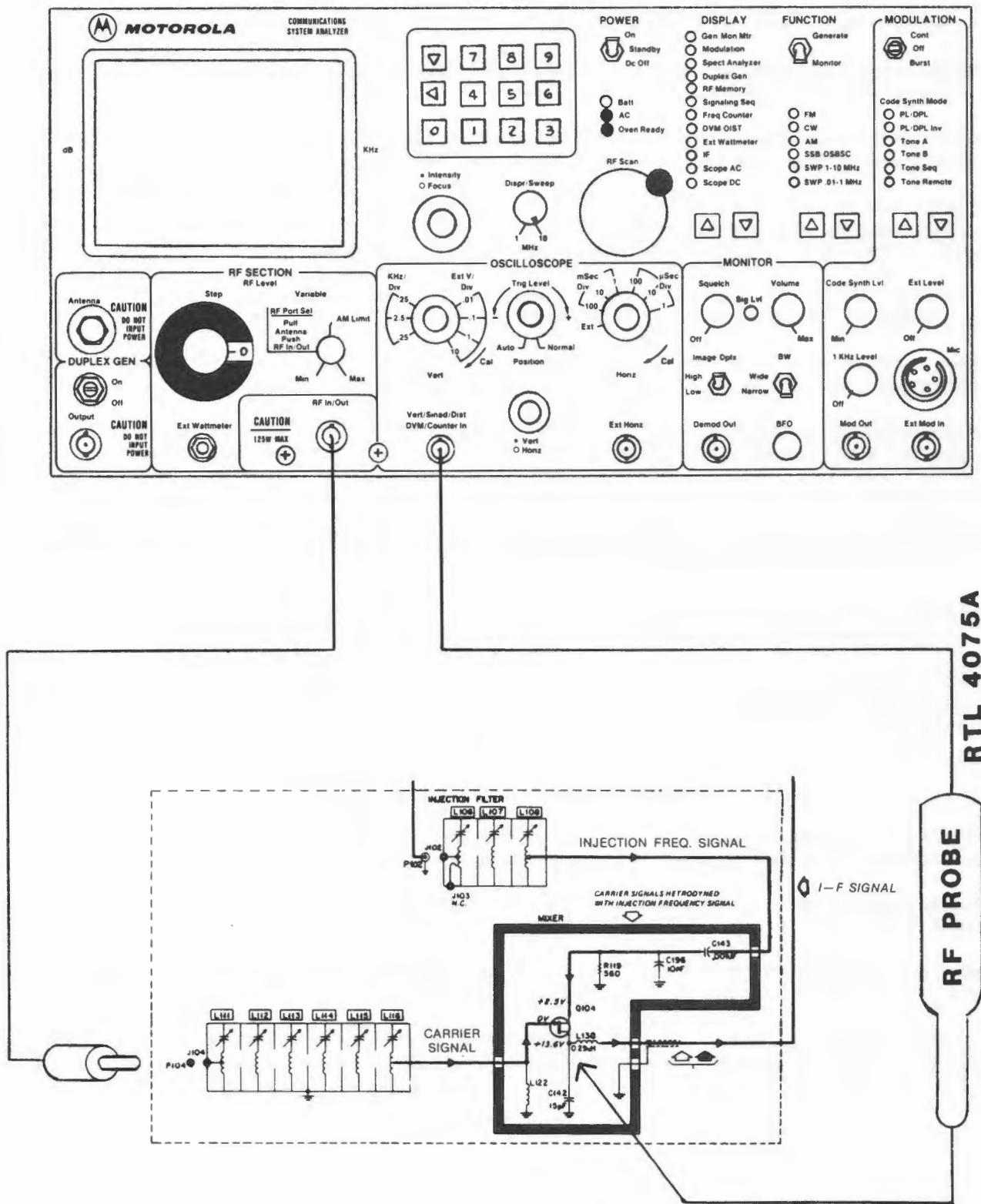

FIGURE 4-5. PROBE SETUP



## RF PRESELECTOR SHAPE & BANDWIDTH

Use this test to insure proper preselector alignment for multi-frequency receivers. Tune the preselector for greater rejection of an interfering frequency from nearby transmitters.

1. Connect the Analyzer's RF In/Out to the antenna connector of the receiver under test. Connect the Analyzer's Vert/Sinad/Dist to the RF probe. Connect the probe to the first available low impedance point following the preselector, as shown in figure 4-5.
2. Disable the receiver's mixer injection.
3. Set DISPLAY to Scope DC, FUNCTION to SWP 1-10 MHz with switch in Generate, and Dispr/Sweep control fully clockwise to 10 MHz.
4. Enter the proper receiver frequency.
5. Set RF Step attenuator to 0dB and RF Variable control to mid-range.
6. Use the OSCILLOSCOPE Vertical control to move the horizontal sweep line to the bottom of the graticule. Set the Ext V/Div control to 0.01 and its inner knob fully clockwise to Cal position.
7. Adjust the RF output level to produce a CRT display at the lowest readable level to minimize the possibility of overloading the circuits being tested.
8. The 3db (.707 of peak) and 6db (.50 of peak) bandwidth points can be checked. Each major horizontal division corresponds to 1 MHz with dispersion control fully clockwise and to .1 MHz with dispersion control fully counterclockwise. The response should be checked for uniformity and symmetry. Tuning adjustments can be made accordingly.

# RECEIVER FREQUENCY ADJUSTMENT

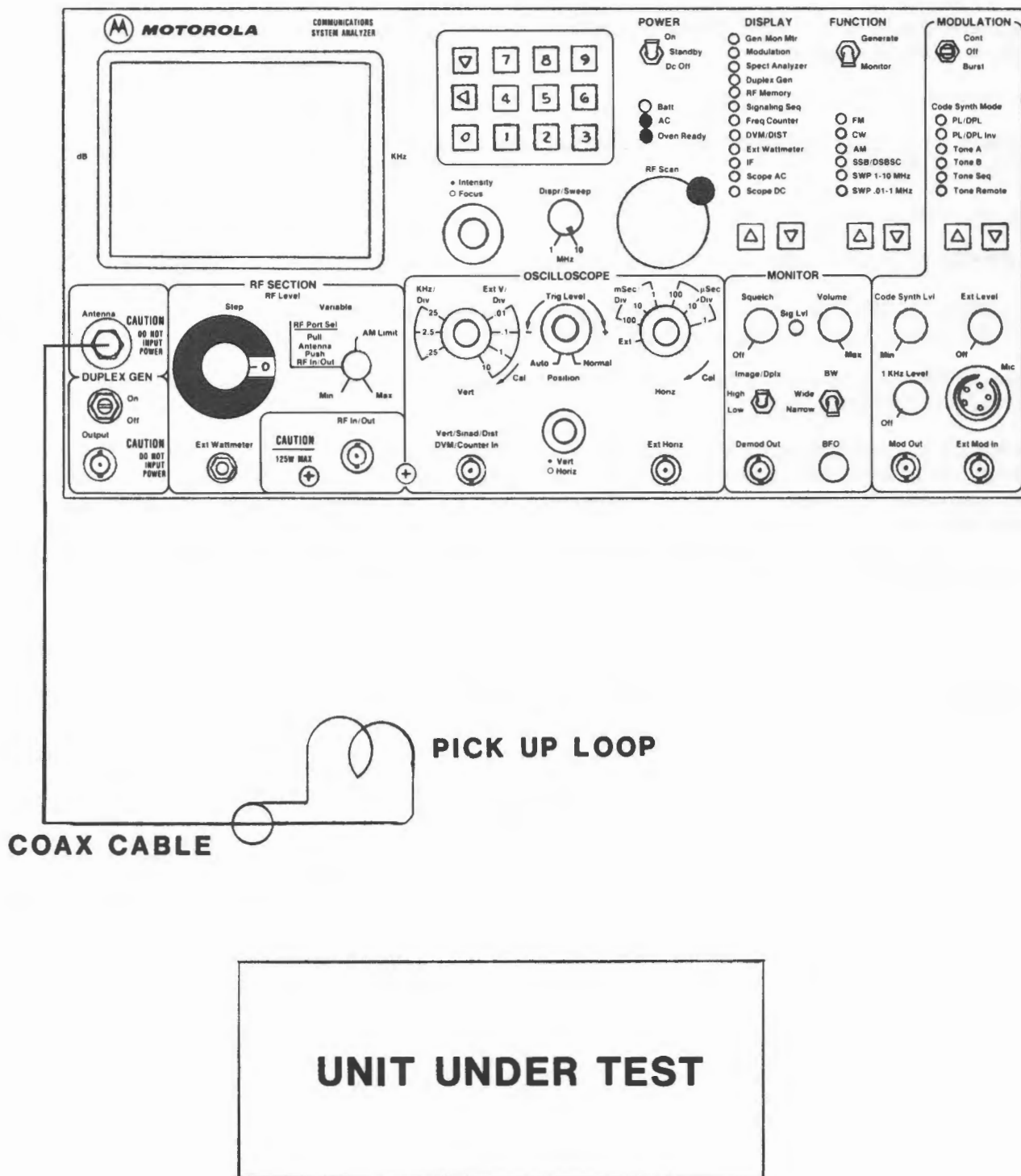

FIGURE 4-6. FREQUENCY ADJUSTMENT SETUP

## RECEIVER FREQUENCY ADJUSTMENT

1. Connect the Analyzer to the receiver under test, as shown in figure 4-6.
2. Set DISPLAY to Spectrum Analyzer (1.5 uV sensitivity). Enter the proper local oscillator frequency. Check the receiver's local oscillator for approximate frequency and spectral purity.
3. Change DISPLAY to Gen/Mon Mtr and FUNCTION to Monitor. Place pick up loop in close proximity to the receiver so that the local oscillator signal is coupled to the Monitor input.
4. Change FUNCTION to Generate and enter the proper carrier frequency. Introduce sufficient signal level into the RF input to fully quiet the receiver and adjust discriminator to zero volts DC for receivers requiring such an adjustment. For receivers with quadrature or more critical detectors, adjust detector tuning control or local oscillator injection frequency for minimum distortion or best SINAD performance.
5. For pagers with the battery saver feature, check the local oscillator for pulse operation without removing the unit from its housing.

# BASIC FM TRANSMITTER TESTS POWER, FREQUENCY, AND DEVIATION

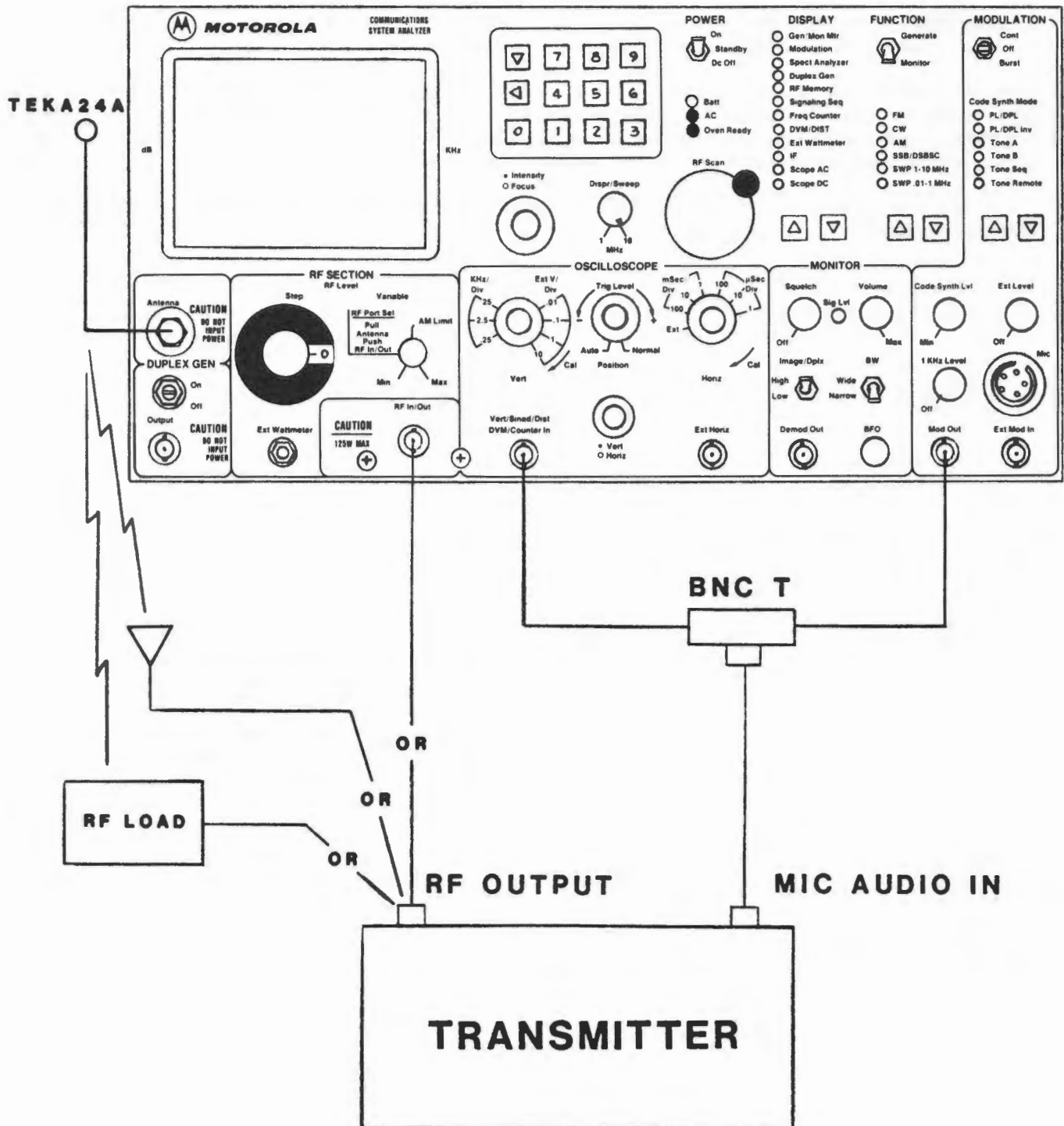

FIGURE 4-7. TRANSMITTER TESTS SETUP

## BASIC FM TRANSMITTER TESTS POWER, FREQUENCY, AND DEVIATION

### A. Basic Terminated Measurements

1. Connect the Analyzer's RF In/Out to the RF output of the unit under test and make the other connections as shown in figure 4-7.

#### CAUTION

For power output measurements, connect a transmitter only to the Analyzer's RF In/Out. Do **not** connect it to the Analyzer's antenna port.

The built-in RF load dissipates up to 50 W for three minutes and up to 125 W for one minute. If a technician keys a high-power transmitter into the Analyzer for a time long enough to threaten overheating the power-measuring circuitry, the system's audible alarm sounds and the display changes to read the RF LOAD OVER-TEMP warning to un-key.

2. Set DISPLAY to Gen/Mon Mtr, FUNCTION switch to Monitor FM, and MONITOR Squelch control to threshold. Enter the correct transmitter carrier frequency via the keypad or RF Memory table.
3. Set the attenuator to -30 dB. For low-power transmitters, it may be necessary to reduce the attenuator setting to un-squelch the monitor. Too high an attenuator setting or too tight a squelch setting inhibits the frequency error display. Accurate measurements require sufficient signal level from the radio to fully quiet the Analyzer's Monitor receiver.
4. Use good quality cables of minimum length because cable-loss can be a significant factor in RF power measurement, especially at UHF and above. Key the transmitter and read the power indicated on the display.
5. Read any transmitter frequency error indicated on the display.
6. Refer to the radio's service manual to determine if POWER and FREQUENCY are within spec limits and determine if any adjustments are required.
7. Proceed to check MODULATION as follows:
  - a. Turn off all modulation sources at the Mod Out of the Analyzer in order to check the level of PL or DPL deviation from the transmitter.
  - b. Key up transmitter with appropriate PL or DPL enabled and read DEVIATION from the GEN/MON MTR DISPLAY. Refer to radio service manual to determine if adjustment is necessary.
  - c. With PL or DPL modulation properly set, introduce 1 KHz modulation to transmitter audio input by adjusting the 1 KHz LEVEL control. Check service manual to determine the minimum level required for proper MIC sensitivity as well as the maximum level required to insure proper IDC function. Read MOD OUT levels on the DVM by temporarily switching the DISPLAY to DVM/DIST, ACVM.
  - d. At the maximum audio input level, read DEVIATION on the display and verify that it falls within the maximum rated system deviation specified in the radio's service manual. Make adjustments as required.
  - e. Verify proper MIC sensitivity by setting Mod Out Level to the minimum threshold level per the service manual and reading corresponding DEVIATION on the display.

### B. Off-The-Air Measurements.

1. Connect the TEKA-24A pick up antenna to the Analyzer's antenna connector. Pull the Variable control out to enable the antenna port.
2. Operate the transmitter under test either into its own antenna or into a dummy RF load, as shown in figure 4-7.
3. Set DISPLAY to Gen/Mon Mtr, FUNCTION SWITCH to Monitor FM, MONITOR Squelch control to threshold, and enter the correct carrier frequency.

**BASIC FM TRANSMITTER TESTS  
POWER, FREQUENCY, AND DEVIATION**

4. Adjust the attenuator as in step A-3 above, to produce an adequate signal level to the Analyzer's Monitor receiver.
5. Adjust the transmitter and follow the same procedure outlined in steps A-5 through A-7 above, to measure frequency and deviation.
6. This same method may be used to verify frequency and deviation of a remotely located transmitter by reducing the attenuator setting to fully realize the 1.5 $\mu$ V for 10db SINAD sensitivity of the Analyzer's "of-the-air" monitor function. To insure sufficient measurement accuracy however, make sure the Monitor receiver is fully quieted as in step A-3 above.

**C. "In-Line" Power Measurements**

1. Referring to figure 4-8, connect the RTL-4055B in-line wattmeter adapter with the appropriate ST-1200 series element in the 50 ohm antenna line with the arrow pointing towards the antenna. Plug the adapter's cable into the Analyzer's Ext Wattmeter jack. Refer to table 3-12 in this Manual for further description of elements.
2. Set DISPLAY to Ext Wattmeter, FUNCTION switch to Monitor FM, and the attenuator to -30 dB. In this step, FUNCTION switch and attenuator do not function but should be set in case RF power is inadvertently applied to the RF In/Out connector.
3. Use the keypad to select the scale that corresponds to the ST-1200 element in use.
4. Key the transmitter. Read forward and reflected power on the display.

## BASIC FM TRANSMITTER TESTS POWER, FREQUENCY, AND DEVIATION

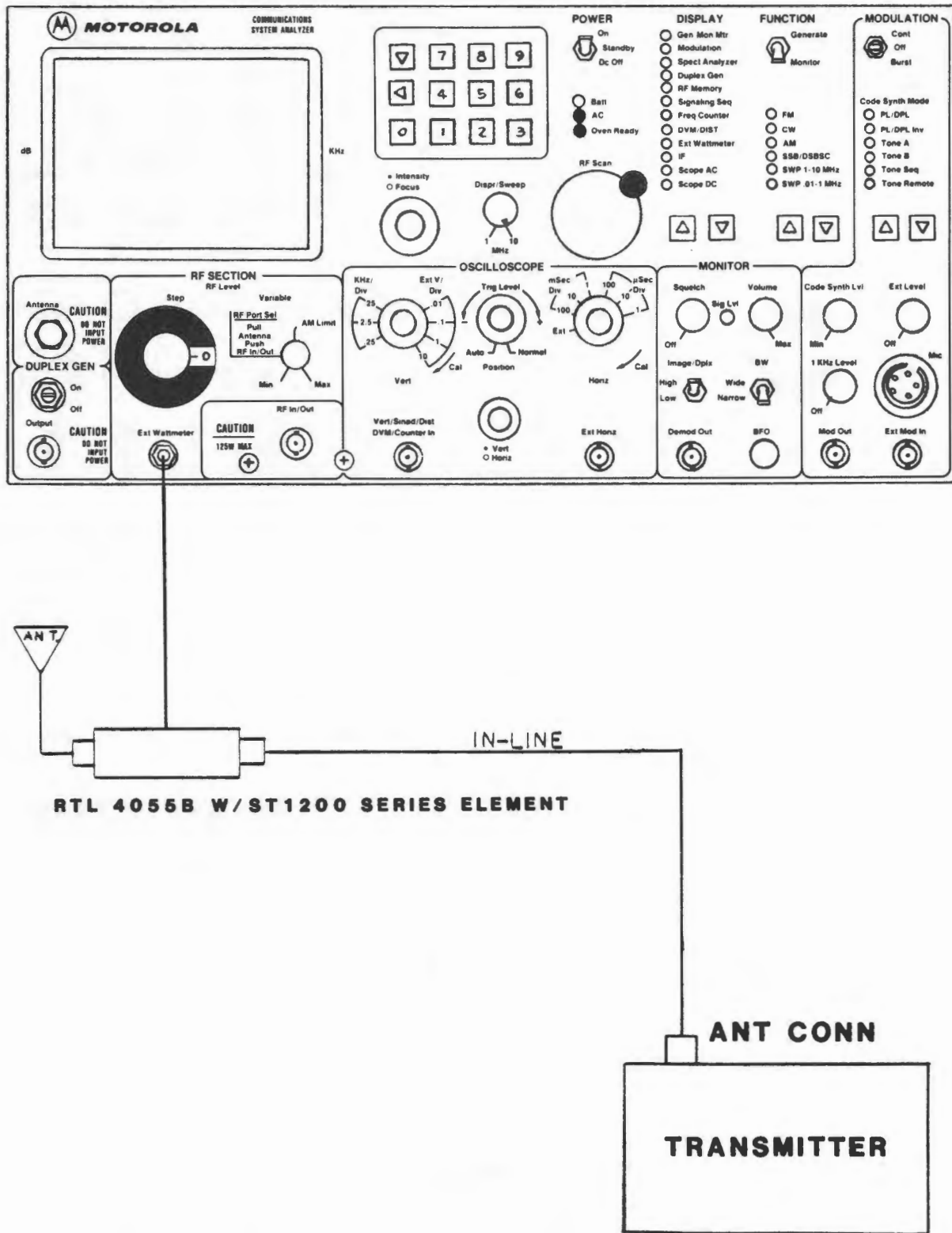

FIGURE 4-8. TRANSMITTER TEST SETUP; POWER MEASUREMENTS



# AUDIO DISTORTION

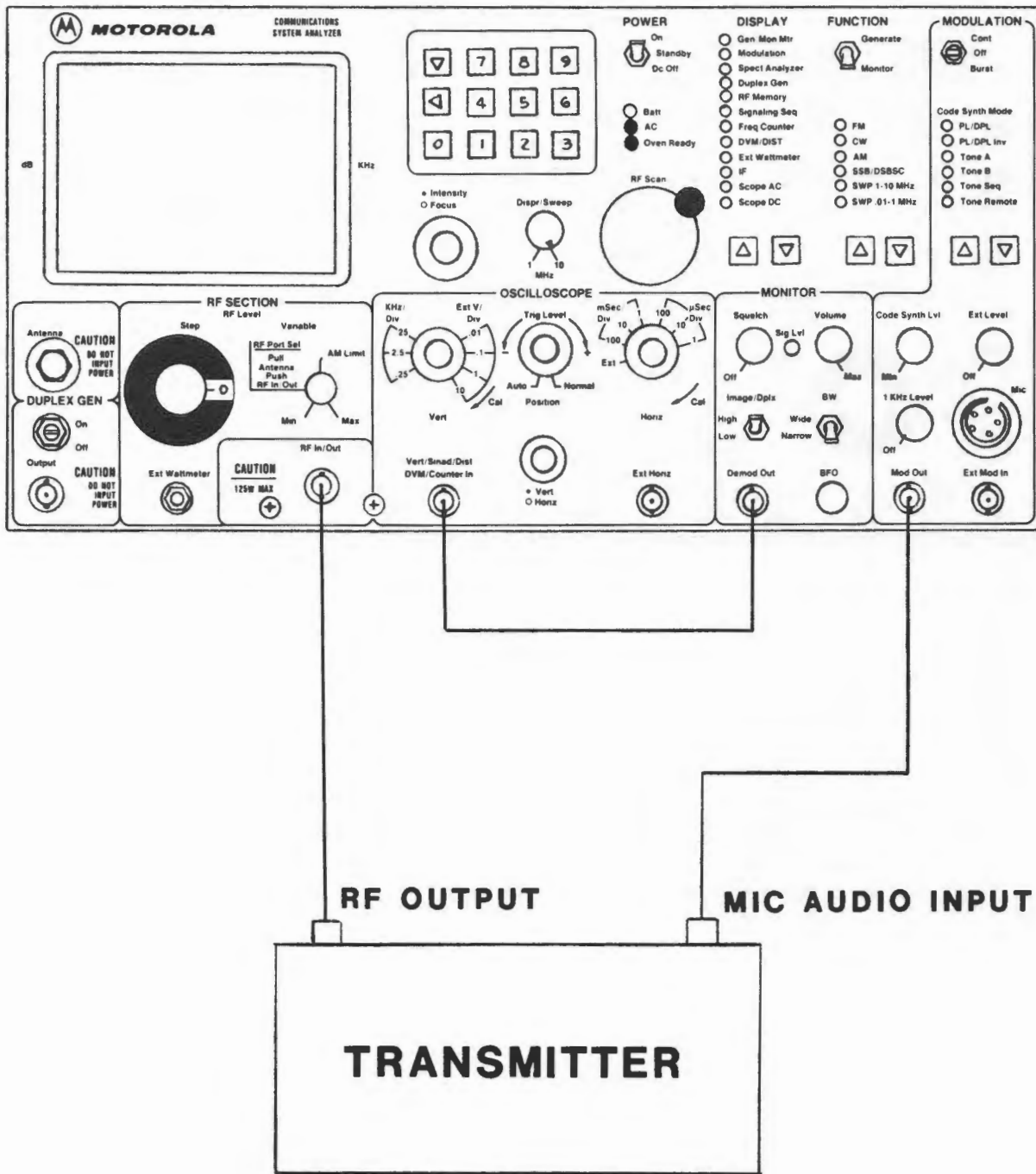

FIGURE 4-9. AUDIO DISTORTION SETUP

## AUDIO DISTORTION

1. Before starting this test, adjust the transmitter's IDC to specification.
2. Connect the Analyzer to the transmitter, as shown in figure 4-9.
3. Turn off the MODULATION switch. Disable PL or DPL.
4. Key the transmitter and adjust the 1 KHz MOD Level control for 60% of full-rated transmitter deviation on the Gen/Mon Mtr DISPLAY.
5. Select DVM/Dist DISPLAY and mode 3, DIST/SINAD. Read transmitter % DISTORTION from the display. Unkey the transmitter.

# AUDIO FREQUENCY RESPONSE

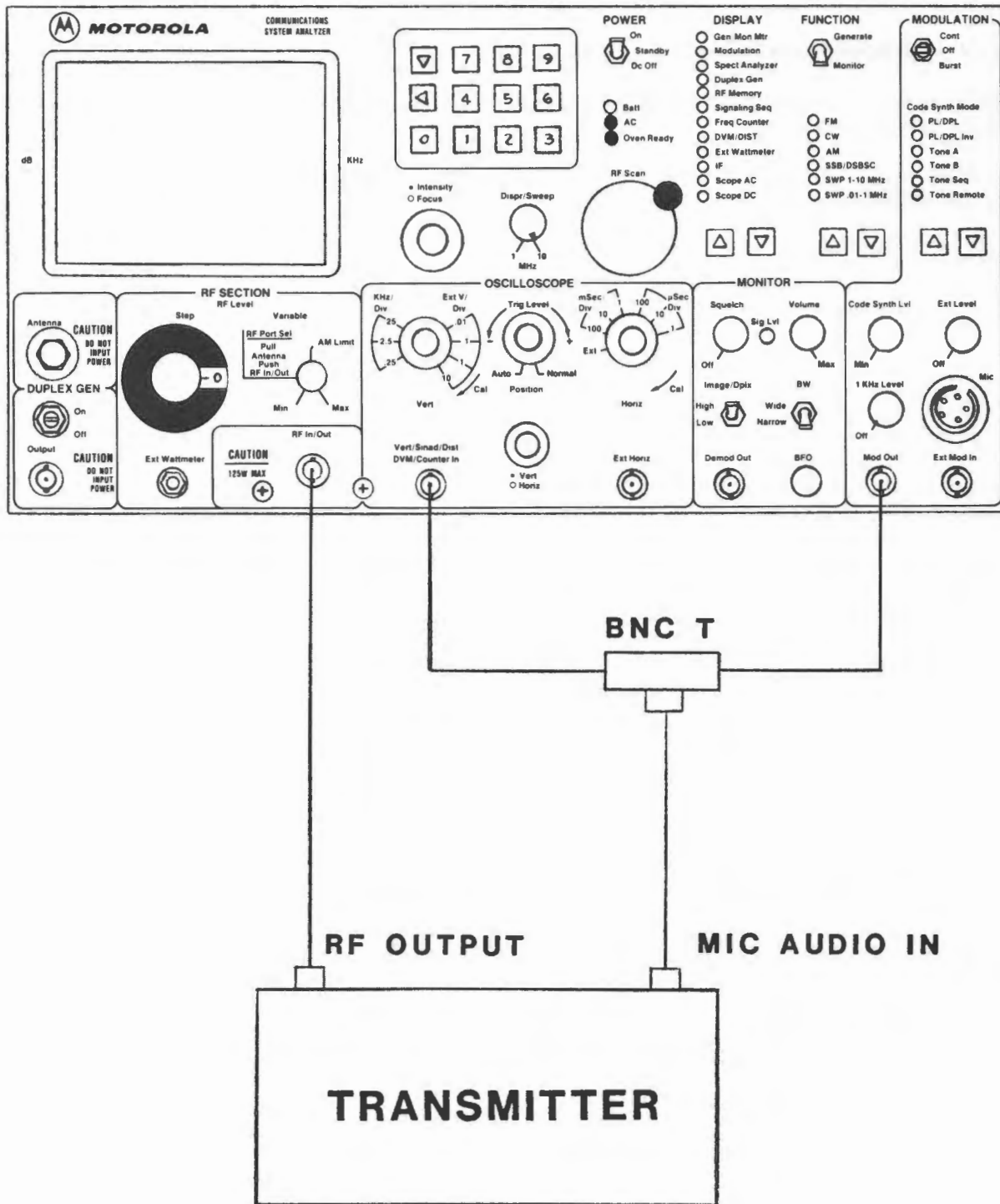

FIGURE 4-10. AUDIO FREQUENCY RESPONSE SETUP

## AUDIO FREQUENCY RESPONSE

1. As shown in figure 4-10, connect the Analyzer's RF In/Out port to the transmitter's RF output and the Vert/Sinad/Dist input jack to the Mod Out jack through a BNC tee fitting connected to the transmitter's microphone audio input. Disable PL and DPL.
2. Select DVM/Dist DISPLAY and set it to mode 1, AC DVM. Set FUNCTION to Monitor FM, attenuator to  $-40$  dB, MODULATION to Cont and Tone A. Use the keypad to enter the transmitter frequency. Turn off the 1 KHz and Ext Mod controls.
3. Set DISPLAY to Signaling Sequence. Use the keypad to enter mode 1, A/B encode, Tone A and enter the frequency to be tested.
4. Set DISPLAY to Gen/Mon Mtr, key the transmitter, and adjust Code Synth Level control to provide 30% of rated transmitter deviation.
5. Change DISPLAY to DVM/Dist. Note both the transmitter MIC Audio input level in dBm and the test frequency, for later use.
6. Repeat the above procedure, adjusting Code Synth Level to maintain 30% of rated deviation, for each frequency to be tested.
7. Plot the data points obtained above in db relative to the 1 KHz Level and compare with the transmitter's specifications. EIA RS-152B specifies that a transmitter's frequency response be within  $+1$  or  $-3$  dB of a  $+6$  dB per octave pre-emphasis from 300 to 3000 Hz (6 dB per octave roll-off allowed between 2500 and 3000 Hz). Refer to figure 4-11 below, Frequency Response diagram.

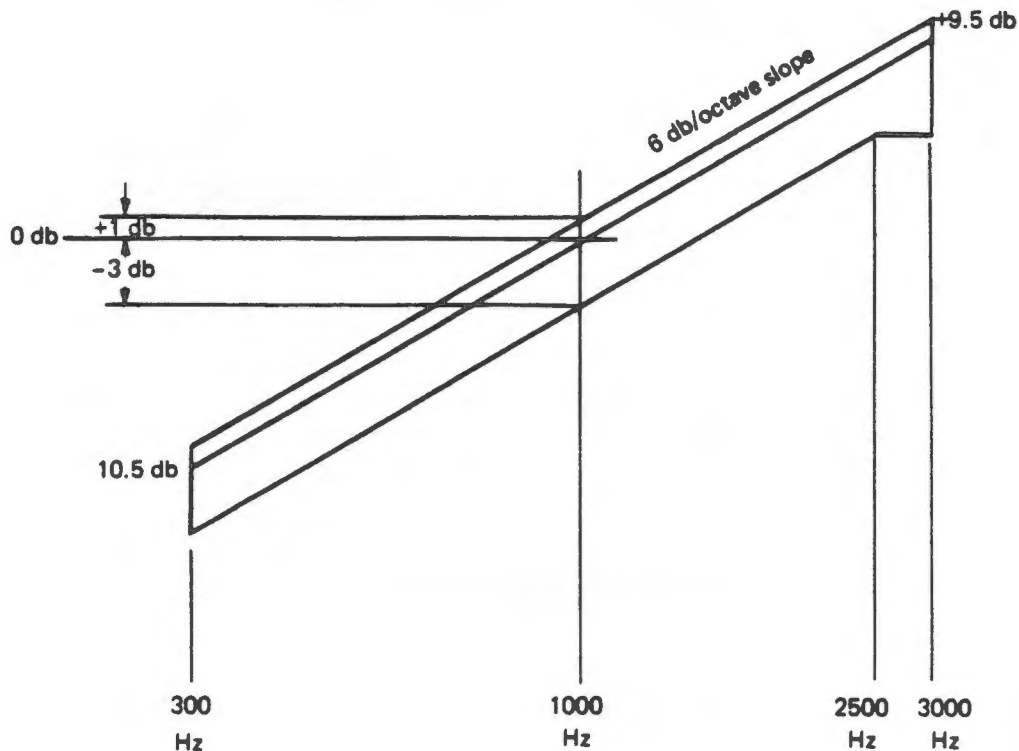

FIGURE 4-11. AUDIO FREQUENCY RESPONSE; EIA STANDARD RS-152B



## AM MODULATION TEST

1. Connect the Analyzer's RF In/Out to the output connector of the transmitter under test, as shown in figure 4-12. Set FUNCTION to Monitor AM.
2. Connect the Analyzer's Mod Out connector to its Vert/Sinad/Dist input connector and to the transmitter's microphone input using a BNC tee connector.
3. Set DISPLAY to DVM/Dist and the AC voltmeter function.
4. Adjust the 1 KHz Level control to provide the proper input signal level to the transmitter. Refer to the transmitter's service manual to obtain the value for this level.
5. Key the transmitter. Read % AM on the display. Change to IF DISPLAY to observe the RF envelope's distortion.
6. To check the transmitter's distortion, connect the Analyzer's Demod Out connector to the Vert/Sinad/Dist input jack. Set DISPLAY to DVM/Dist and Distortion. Read % distortion on the display.

## AM MODULATION LINEARITY TEST

1. Connect the Analyzer's RF In/Out to the output of the Transmitter under test, as shown in figure 4-13.
2. Connect the OSCILLOSCOPE Ext Horiz input connector to the scope probe. Set Horiz control to Ext, DISPLAY to Gen/Mon Mtr, and set to correct transmitter frequency.
3. Change DISPLAY to IF and set FUNCTION switch to Monitor. Connect the Analyzer's Mod Out jack to the transmitter's microphone audio input.
4. Connect the scope probe to the secondary of the transmitter modulator stage output transformer.

### CAUTION

Do not exceed 300 volts maximum to the Analyzer's DVM input.

5. Key the transmitter. Adjust the 1 KHz Level control to cause the displayed trapezoid figure to come to a point at one end. This corresponds to 100% AM modulation. If necessary, adjust the horizontal vernier control to make the display just fill the screen.
6. Observe the resulting trapezoid figure. The top and bottom sides of the trapezoid should be straight. Any curvature indicates non-linearity in the transmitter final amplifier stages.

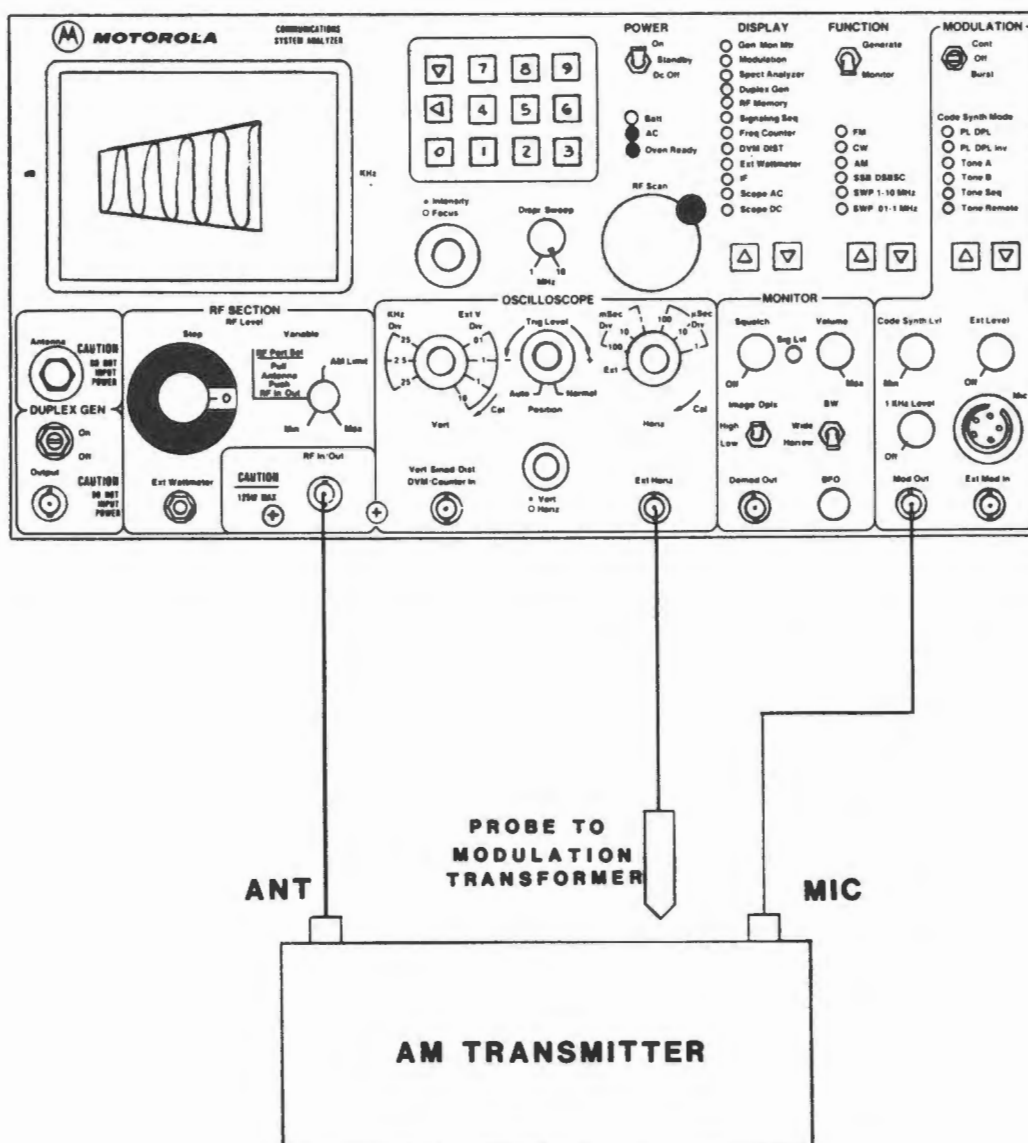

FIGURE 4-13. AM MODULATION LINEARITY TEST SETUP



## ANALYZER IF DISPLAY

### INCIDENTAL AM



UNMODULATED FM CARRIER

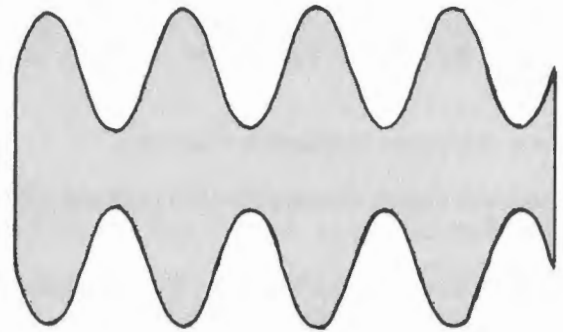

MODULATED FM CARRIER  
WITH INCIDENTAL AM

### AM MODULATION

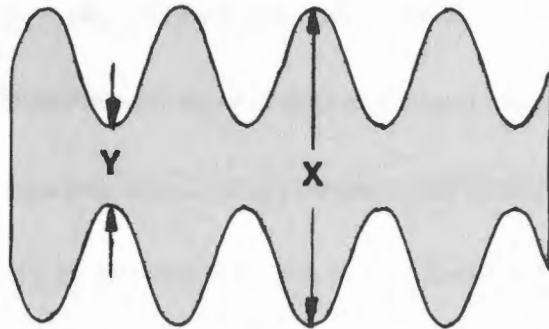

X = PEAK AMPLITUDE

Y = VALLEY AMPLITUDE

$$\% \text{ AM} = \frac{X-Y}{X+Y} \times 100$$

FIGURE 4-14. ANALYZER IF DISPLAY

Figure 4-14 shows a typical IF DISPLAY, its modulated FM carrier with incidental AM, and a formula for calculating % AM. Use the IF mode to view the modulation envelope of the RF signal, to detect and examine incidental AM (in FM modes), and to check AM depth of modulation. Because the IF DISPLAY provides only a qualitative indication, use the Monitor DISPLAY with AM Monitor FUNCTION to determine precise AM measurements.

## COMMUNITY REPEATER MODULATION

1. Connect the Analyzer to the repeater under test as shown in figure 4-15. The diagram illustrates a MICOR Community Repeater. Disable the receiver PL and set the squelch to threshold.
2. Set DISPLAY to DVM, FUNCTION switch to Monitor FM, and MODULATION switch in off position. Set MONITOR BW switch to narrow, Squelch control to threshold, and Duplex Gen switch to off.
3. Set the attenuator to -30 dB. For low-power transmitters, it may be necessary to reduce the attenuator setting to un-squelch the monitor. Too high an attenuator setting or too tight a squelch setting inhibits the modulation deviation display.
4. Enter the proper transmitter frequency.
5. Move the display cursor down to DVM and enter 1 for AC mode. Adjust the 1 KHz Level control for 1 VAC, indicated on the display, to put 1 volt of 1 KHz test tone into the transmitter modulation limiter.
6. Set DISPLAY to Gen/Mon Mtr. Key the transmitter. Adjust the transmitter IDC control for 4 KHz DEV indicated on the display. Un-key the transmitter.
7. Disconnect the cable from the Duplex Gen output to the receiver antenna to prevent the transmitter from keying up on repeat.
8. Disconnect the cable from the Mod Out connector, leaving SINAD IN connected to test point at the repeater level.
9. Set DISPLAY to Duplex Gen, FUNCTION switch to Generate FM, and Duplex Gen switch to On. Set the MONITOR Image/Duplex switch to High or Low as required. Enter the proper offset frequency.
10. Move the display cursor down to PL or DPL and enter a PL/DPL code used in the repeater.
11. Turn off the 1 KHz Level control. Set MODULATION switch in the Cont position and adjust Code Synth Level control for 0.75 KHz DEV indicated on the display.
12. Set FUNCTION switch to Monitor. Reconnect the cable from the Duplex Gen Output to the receiver antenna connector. The transmitter should now key-up.
13. Adjust the PL deviation control in the repeater controller for 0.75 KHz repeated PL/DPL code indicated on the display.
14. Set FUNCTION switch to Generate and adjust the 1 KHz Level control for 4.75 KHz DEV indicated on the display (0.75 KHz PL/DPL + 4 KHz test tone = 4.75 KHz).
15. Set DISPLAY to DVM, FUNCTION switch to monitor, and turn the repeat level to minimum. Slowly increase the repeat level control until the proper voltage is indicated on the display.
16. Change DISPLAY to Gen/Mon Mtr. Confirm that the repeated modulation is 4.75 KHz.
17. Disconnect the cable from the Duplex Gen Output to the receiver antenna. The repeater should un-key.
18. Radiate a weak signal from the Duplex Gen Output to simulate the weakest signal that will be repeated. Adjust squelch key control on the squelch gate module to the point that the transmitter just keys-up.

# COMMUNITY REPEATER MODULATION

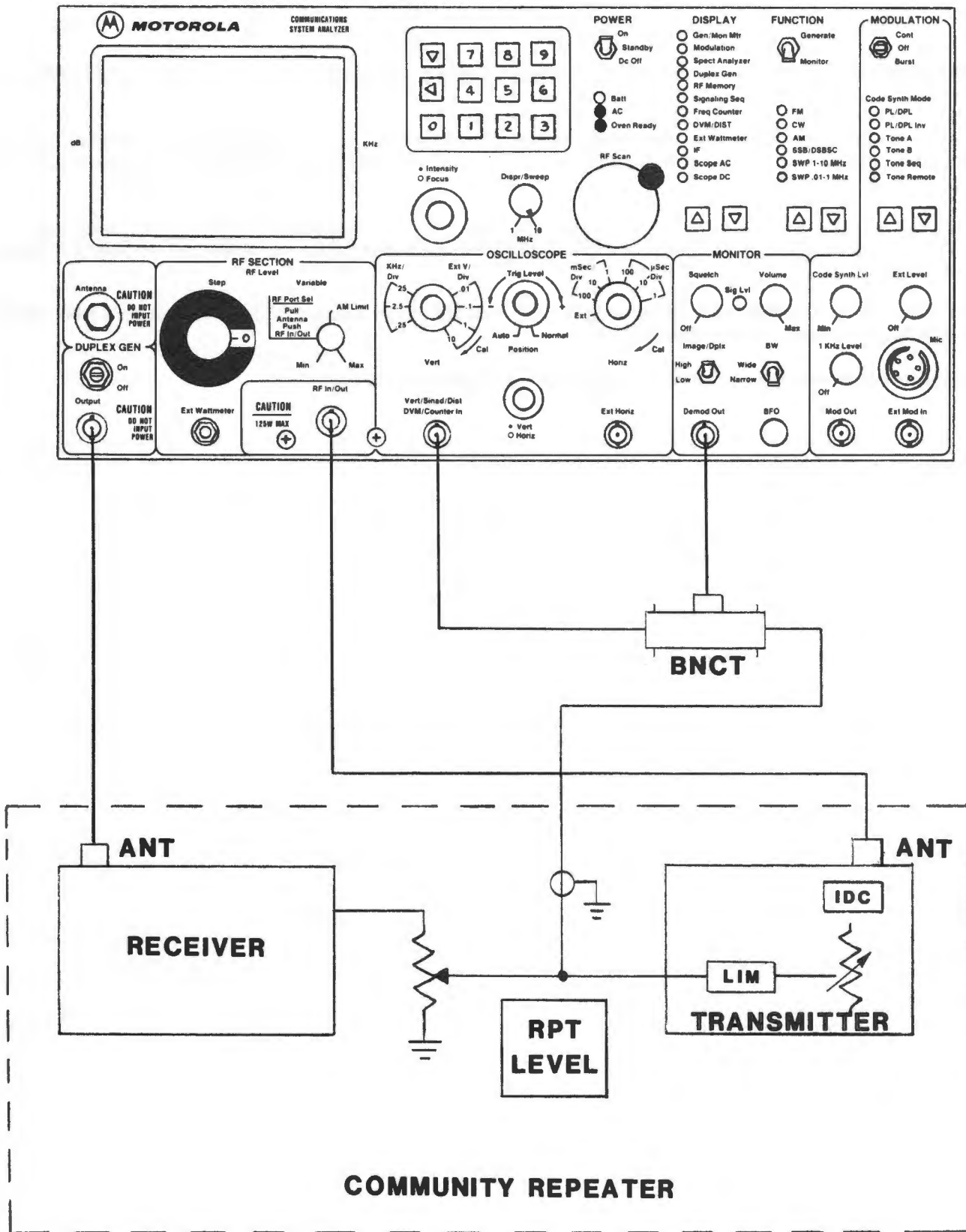

FIGURE 4-15. COMMUNITY REPEATER MODULATION SETUP

## WIRE LINE REMOTE BASE MODULATION

1. Set-up this station in two steps: Transmitter modulation and phone line levels.
2. Connect the Analyzer to the transmitter under test as shown in figure 4-16.
3. Set DISPLAY to DVM, FUNCTION switch to Monitor, and MODULATION switch to off. Set MONITOR BW switch to narrow and squelch control to threshold.
4. Set the attenuator to -30 dB. For low-power transmitters, it may be necessary to reduce the attenuator setting to un-squelch the monitor. Too high an attenuator setting or too tight a squelch setting inhibits the modulation deviation display.
5. Enter the proper transmitter frequency. Move the display cursor down to DVM and enter 1 for AC mode. Adjust the 1 KHz Level control for 1 VAC indicated on the display, to put 1 volt of 1 KHz test tone into the transmitter modulation limiter.
6. Set DISPLAY to Gen/Mon Mtr. Key the transmitter and adjust the transmitter. IDC control for 5 KHz DEV indicated on the display. Un-key the transmitter.
7. Follow the base station phone level setting outlined in the next procedure.

# WIRE LINE REMOTE BASE MODULATION

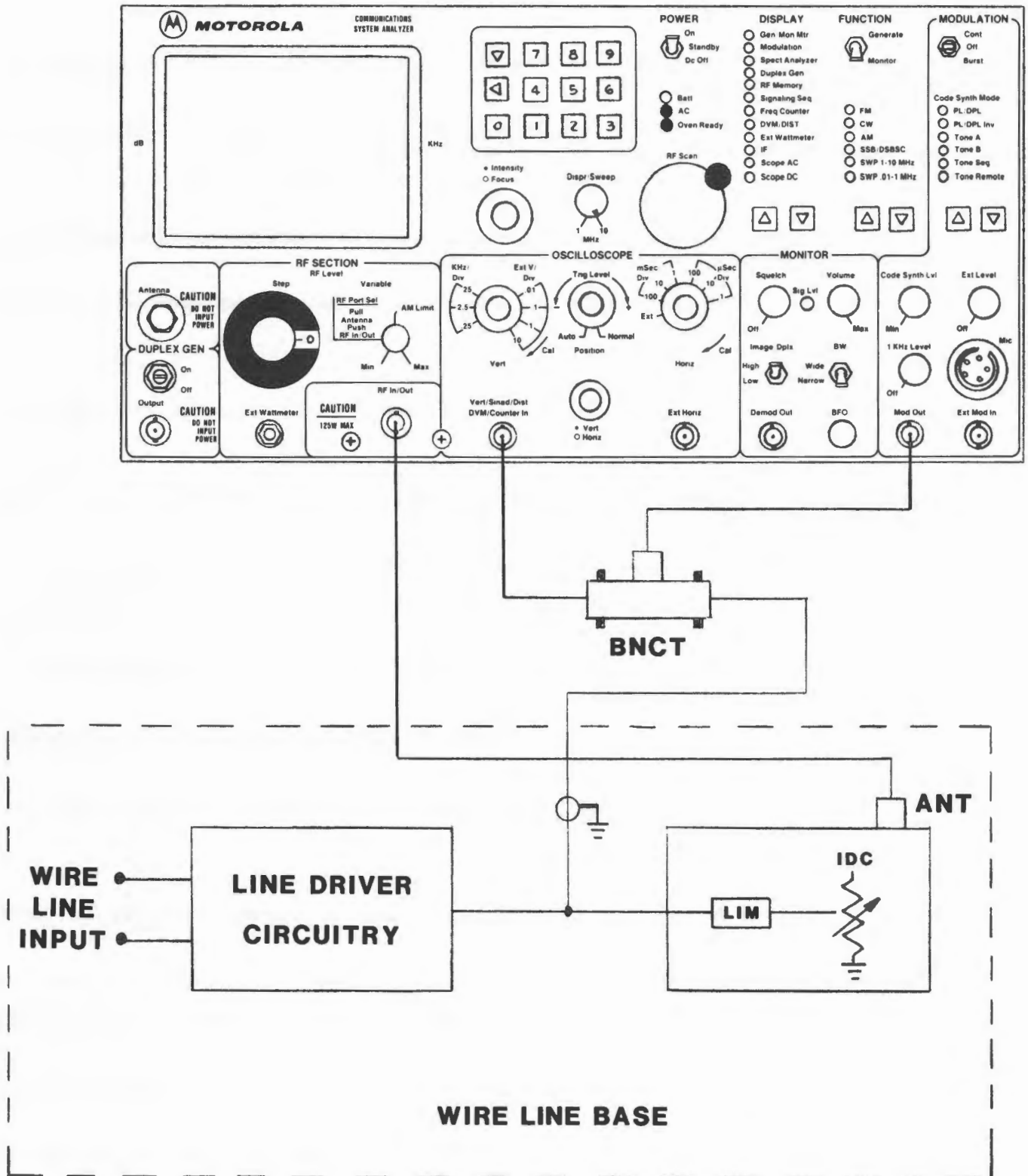

FIGURE 4-16. MODULATION SETUP; REMOTE BASE

## WIRE LINE REMOTE BASE PHONE LINE LEVELS

### A. Phone Line Levels

1. Perform the Transmitter Modulation procedure, outlined in the previous method, before proceeding with the phone line level adjustments.
2. Connect the Analyzer to the base station under test as shown in figure 4-17. Connect RF In/Out to the antenna connector and Mod Out - DVM/Counter In connector to the station phone line input.

### CAUTION

Disconnect the telephone line from the base station and connect a 600 ohm load across the input. Failure to do so will introduce hum and noise that will cause erroneous readings.

3. To measure levels across a balanced phone line, refer to paragraph D. To generate signals across a balanced phone line, refer to paragraph E.

### B. TRANSMIT Line Input

1. Set DISPLAY to DVM, FUNCTION switch to Monitor FM, and MODULATION switch to off. Set MONITOR BW switch to narrow and squelch control to threshold.
2. Set attenuator to -30 dB. For low-power transmitters, it may be necessary to reduce the attenuator setting to un-squelch the monitor. Too high an attenuator setting or too tight a squelch setting inhibits the modulation deviation display.
3. Enter the proper transmitter frequency. Move the display cursor down to DVM and enter 1 for AC mode.
4. Adjust the 1 KHz Level control for the DBM level expected from the remote control console. The typical value of -16 dBm will be +/-4 dB of most actual levels.
5. Remove the cable from the DVM/Counter In connector coming from Mod Out. Connect the cable coming from the line driver output to DVM/Counter In.
6. Adjust the exciter level control on the station control module for the value stamped on the exciter, as indicated on the display.
7. Set DISPLAY to Gen/Mon Mtr. Make a line push-to-talk by applying the proper control signal to the input line. Verify that modulation is 5 KHz.

### C. RECEIVE Line Output

1. Disconnect the cable from the Mod Out and DVM/Counter In connectors. Connect the cable from the receiver line driver output to the DVM/Counter In.
2. Set DISPLAY to Gen/Mon Mtr, FUNCTION switch to Generate FM, and MODULATION switch to off.
3. Adjust the 1 KHz Level control for 5 KHz DEV indicated on the display. Set the attenuator to -30 dB and the Variable control to mid-range.
4. Set DISPLAY to DVM. Enter the proper receiver frequency. Move the display cursor down to DVM and enter 1 for AC mode.
5. Adjust the line level control on the line driver module for the desired level on the phone line. A typical value for carrier - type lines is 0 dBm.

# WIRE LINE REMOTE BASE PHONE LINE LEVELS

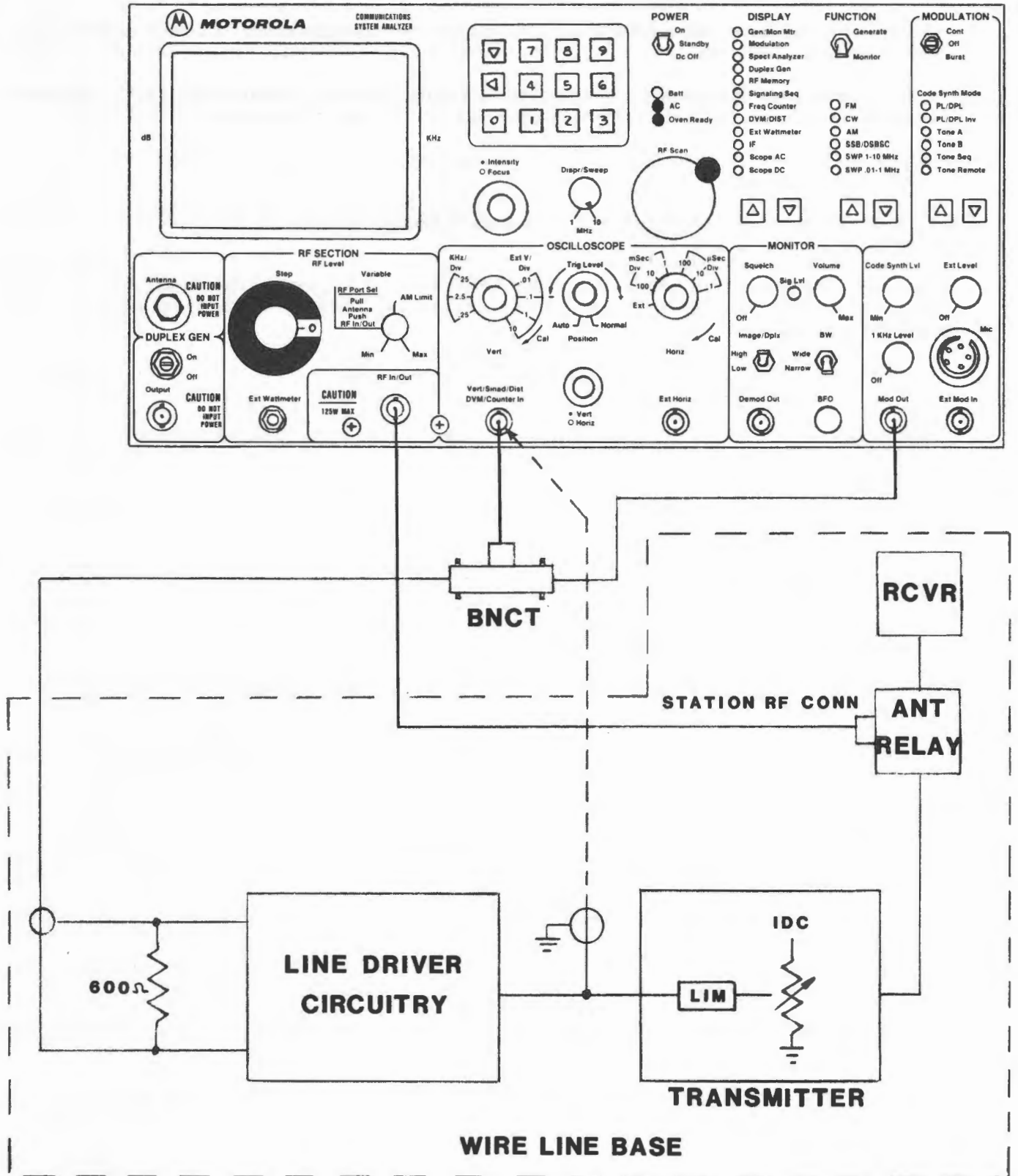

FIGURE 4-17. PHONE LINE LEVELS SETUP



**WIRE LINE REMOTE BASE  
PHONE LINE LEVELS**

**D. MEASURING LEVELS ACROSS A BALANCED LINE**

1. Use a BALUN (**balanced-to-unbalanced**) device because of the unbalanced nature of the DVM/Counter In jack. The BALUN must be high impedance (6K ohm or more) to make bridging measurements without upsetting levels.
2. Connect the BALUN's balanced side (high impedance) across the phone line. Connect the BALUN's unbalanced side to the DVM/Counter In jack, as shown in figure 4-18. Set the BALUN switch in the OPEN position.
3. Set DISPLAY to DVM AC mode. Measure the test tone level on the phone line by interpolating the AC VOLTS-DBM scale on the display.
4. Set DISPLAY to Scope AC. Analyze waveform and measure AC volts peak-to-peak by interpolating the volts per division.
5. With the BALUN switch in the OPEN position, the BALUN represents a nominal 10db insertion loss from the balanced side to the unbalanced side. For example, an actual line level of 0dbm will indicate -10 dbm at the DVM input. Characterize your unit before use.

# WIRE LINE REMOTE BASE PHONE LINE LEVELS

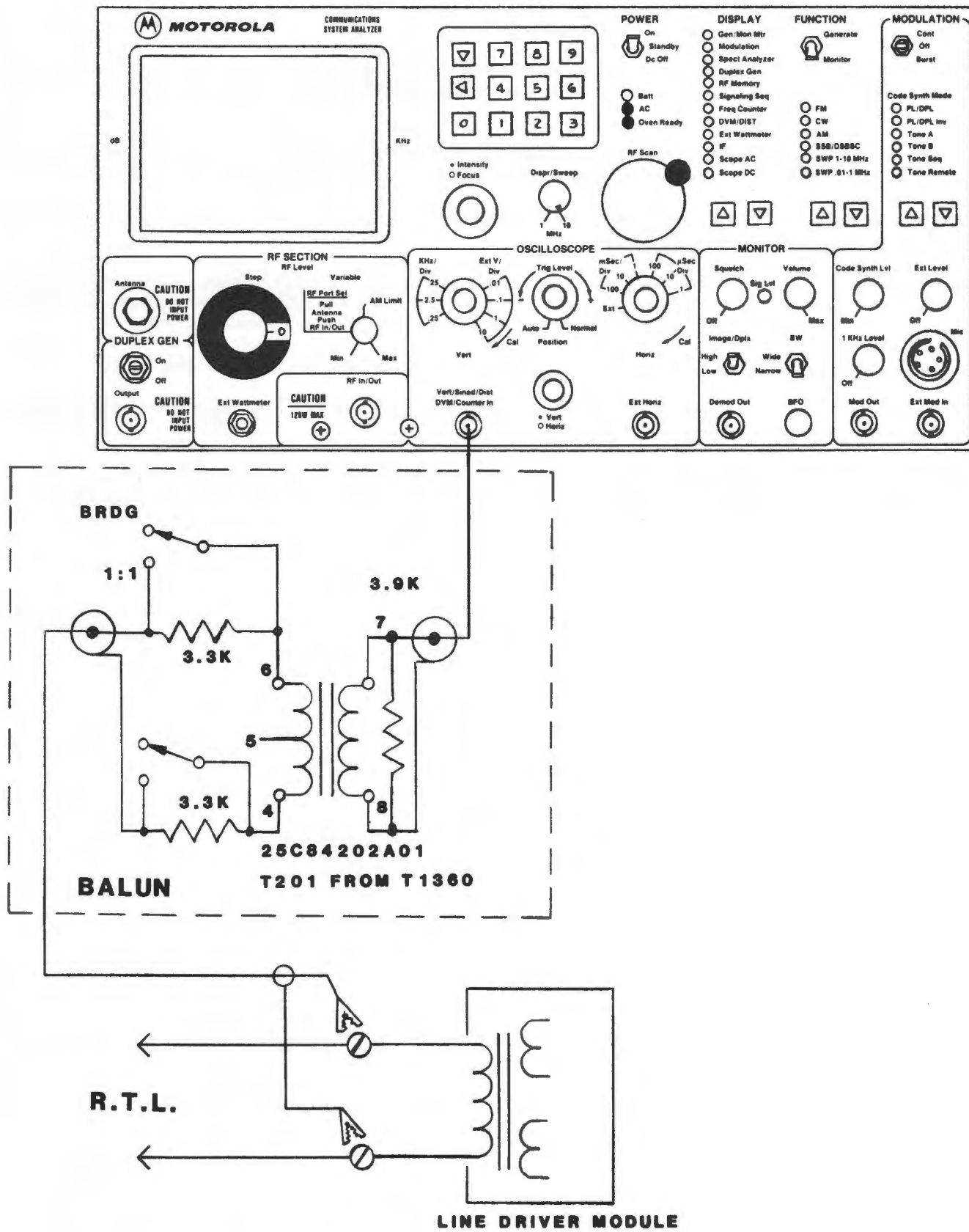

**FIGURE 4-18. BALUN SETUP; MEASURING LEVELS**

**WIRE LINE REMOTE BASE  
PHONE LINE LEVELS**

**E. GENERATING SIGNALS ACROSS A BALANCED LINE**

1. Connect the BALUN's balanced side (600 ohm) to the phone line, as shown in figure 4-19. Disconnect any other equipment (consoles, etc.) connected to the line. Connect the BALUN's unbalanced side to the Mod Out - DVM/Counter In jack.
2. Set DISPLAY to DVM AC mode and FUNCTION switch to Generate. Adjust the 1 KHz Level control to the level desired on the line, as interpolated from the DBM scale. A typical value for carrier-type lines is 0 dBm.
3. Set DISPLAY to DVM AC mode, FUNCTION switch to Generate, and 1KHz Level control to off position to generate tone remote control commands.
4. Set MODULATION switch to Cont Tone Remote. High-level guard tone, function tone, and then the continuous low-level guard tone will go out. Adjust Code Synth Level control for -30 dBm level of low-level guard tone on the phone line, as interpolated from the DBM scale. This is equivalent to 0 dBm speech test tone level.
5. Switch to Burst position each time that a tone remote control command sequence is desired.
6. Connect the service microphone into the Analyzer's MIC jack. Adjust the Ext. Level control for voice peaks about 6 dB higher than the desired test tone level.
7. With the BALUN switch in the CLOSED position, the BALUN represents a nominal 0db insertion loss from the unbalanced side to the balanced side. For example, a modulation output of 0dbm will be a 0dbm input into the 600 ohm line. Characterize your unit before use.

## WIRE LINE REMOTE BASE PHONE LINE LEVELS

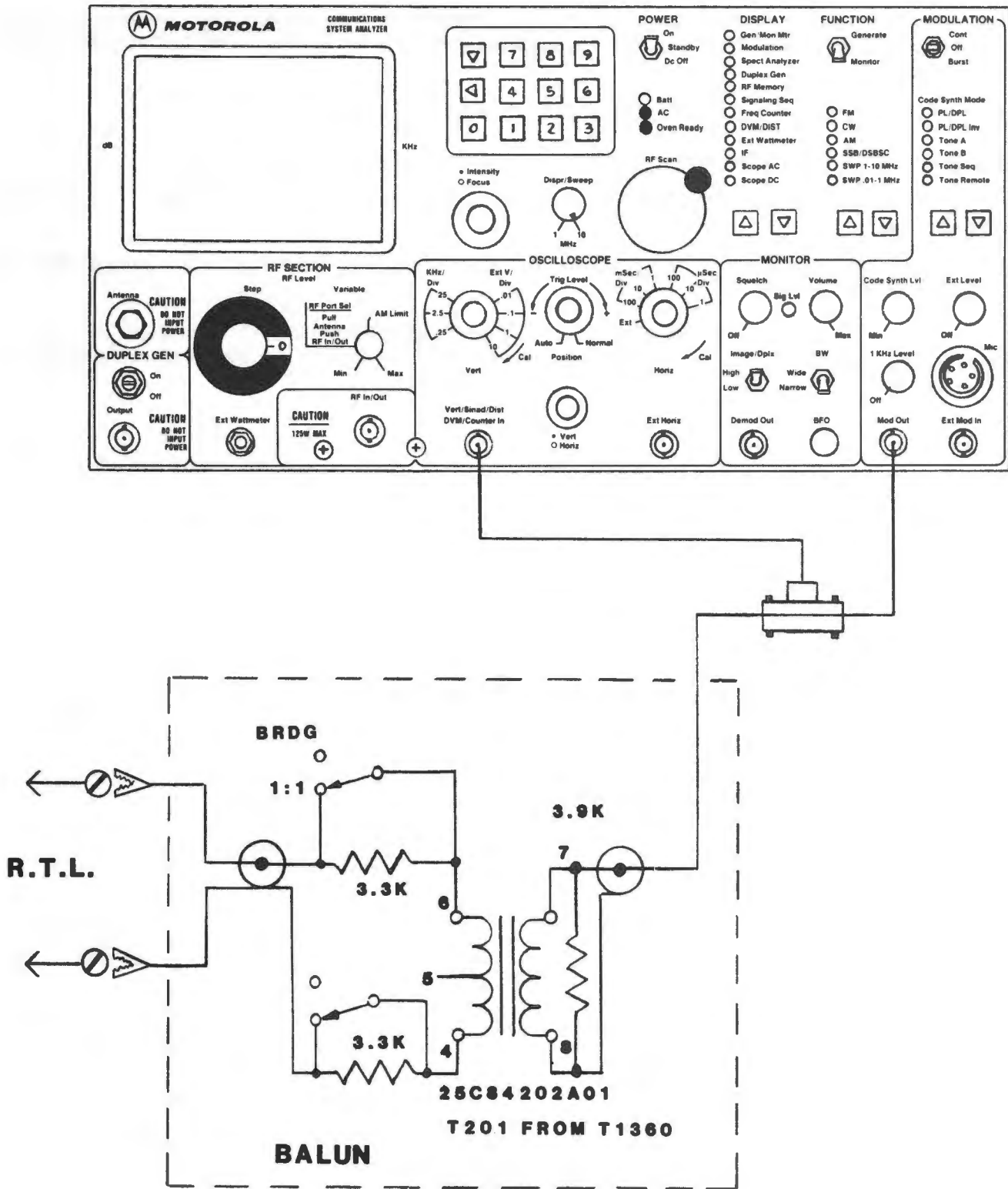

FIGURE 4-19. BALUN SETUP; GENERATING SIGNALS

## BANDPASS CAVITY TUNING

Use this procedure to peak-tune bandpass cavities, duplexers, crystal filters and other bandpass devices. Tune the bandpass to center frequency. After tuning, use normal gain or loss measuring techniques to measure insertion loss.

1. Connect the Analyzer to the device under test, as shown in figure 4-20. When tuning a single cavity, connect the RF In/Out to the cavity's output connector. When tuning a bandpass duplexer, connect the RF In/Out to the duplexer's antenna port.
2. Set DISPLAY to Duplex Gen, FUNCTION switch to Generate, and attenuator to -10db.
3. Change the FUNCTION switch to Monitor. Enter pass frequency on the display. Set the offset to 0 MHz.
4. Change DISPLAY to Spectrum Analyzer. Set Dispr/Sweep control fully clockwise to 10 MHz. Turn the Duplex Generator on.
5. Tune the cavity, or both cavities in the duplexer leg, to a peak indication on the display's center graticule. The single cavity is ready for service.
6. For duplexer tuning, move the output cable from the Duplex Gen Output connector to the duplexer's other end. Repeat steps 2 through 4. Put the duplexer into service. Check the duplexer for insertion loss according to its specifications.

# BANDPASS CAVITY & DUPLEXER TUNING

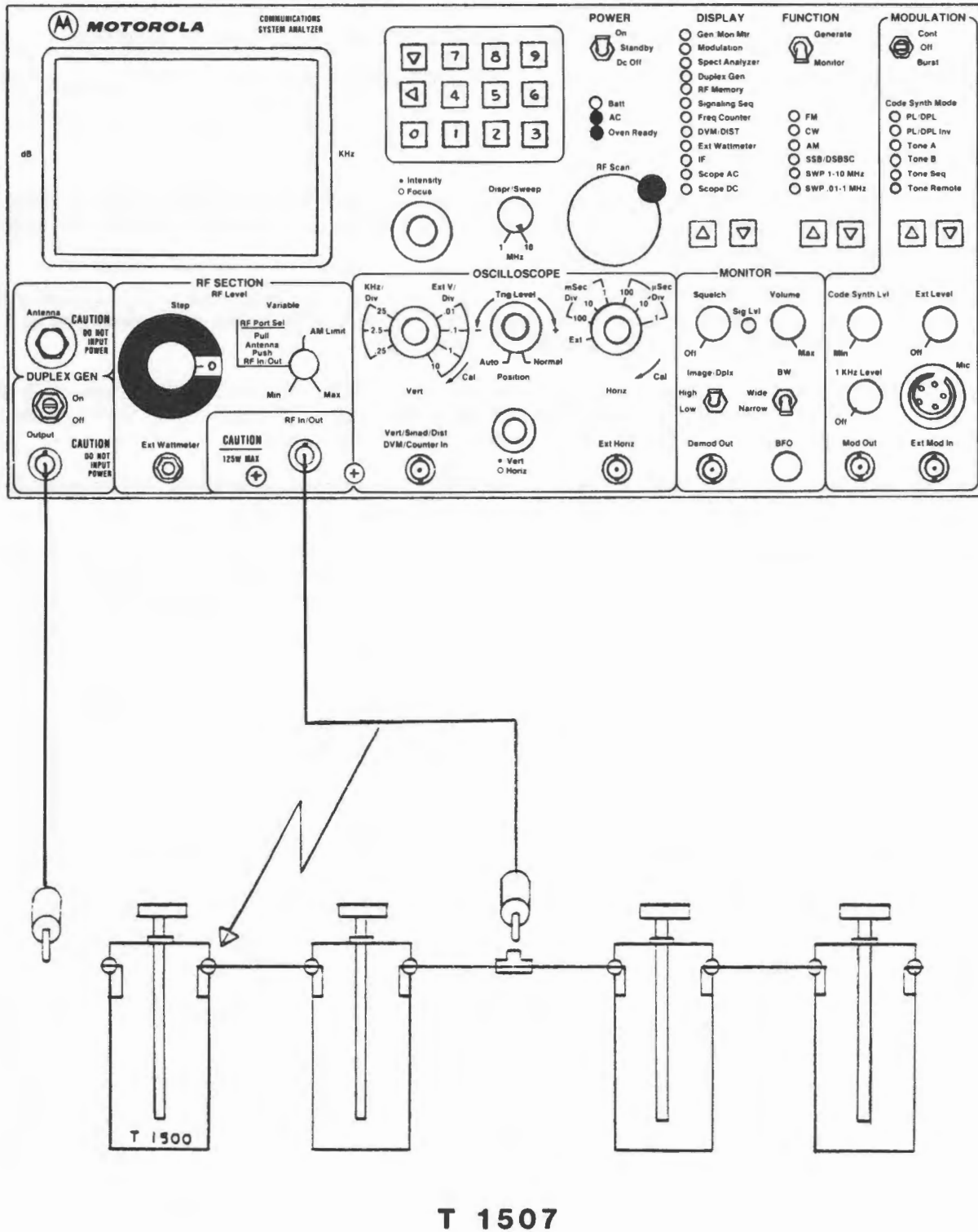

**FIGURE 4-20. BANDPASS CAVITIES SETUP**

## CAVITY & DUPLEXER TUNING BANDPASS ADJUSTMENT

### A. Passband Adjustment

1. Connect the Analyzer's RF In/Out to the in-service duplexer antenna port as shown in figure 4-21.
2. Set DISPLAY to Gen/Mon Mtr, FUNCTION switch to Generate FM, and MODULATION switch to off position.
3. Enter the receiver frequency.
4. Set the RF Step attenuator to -30 dB and the Variable control to mid-range, to allow adequate signal to get through a mistuned duplexer and quiet the receiver. Reduce the signal generator output, as necessary, to keep the receiver limiter meter reading below saturation.
5. Tune the pass-band knobs of the cavities in the duplexer receive leg, for a peak reading on the receiver limiter meter. Reduce the signal generator output, as necessary, to keep the receiver limiter meter reading below saturation. This completes the pass-band adjustment for the receiver leg.
6. Set the FUNCTION switch to Monitor FM and the attenuator to -30 dB. For low-power transmitters, it may be necessary to reduce the attenuator setting to unsquelch the monitor. Too high an attenuator setting or too tight a squelch setting will inhibit the display of frequency and deviation information.
7. Enter the transmitter frequency. Key the transmitter and tune the pass-band knobs of the cavities in the duplexer transmit leg for maximum power output. This completes pass-band adjustments.



# CAVITY & DUPLEXER TUNING BANDPASS WITH REJECT NOTCH

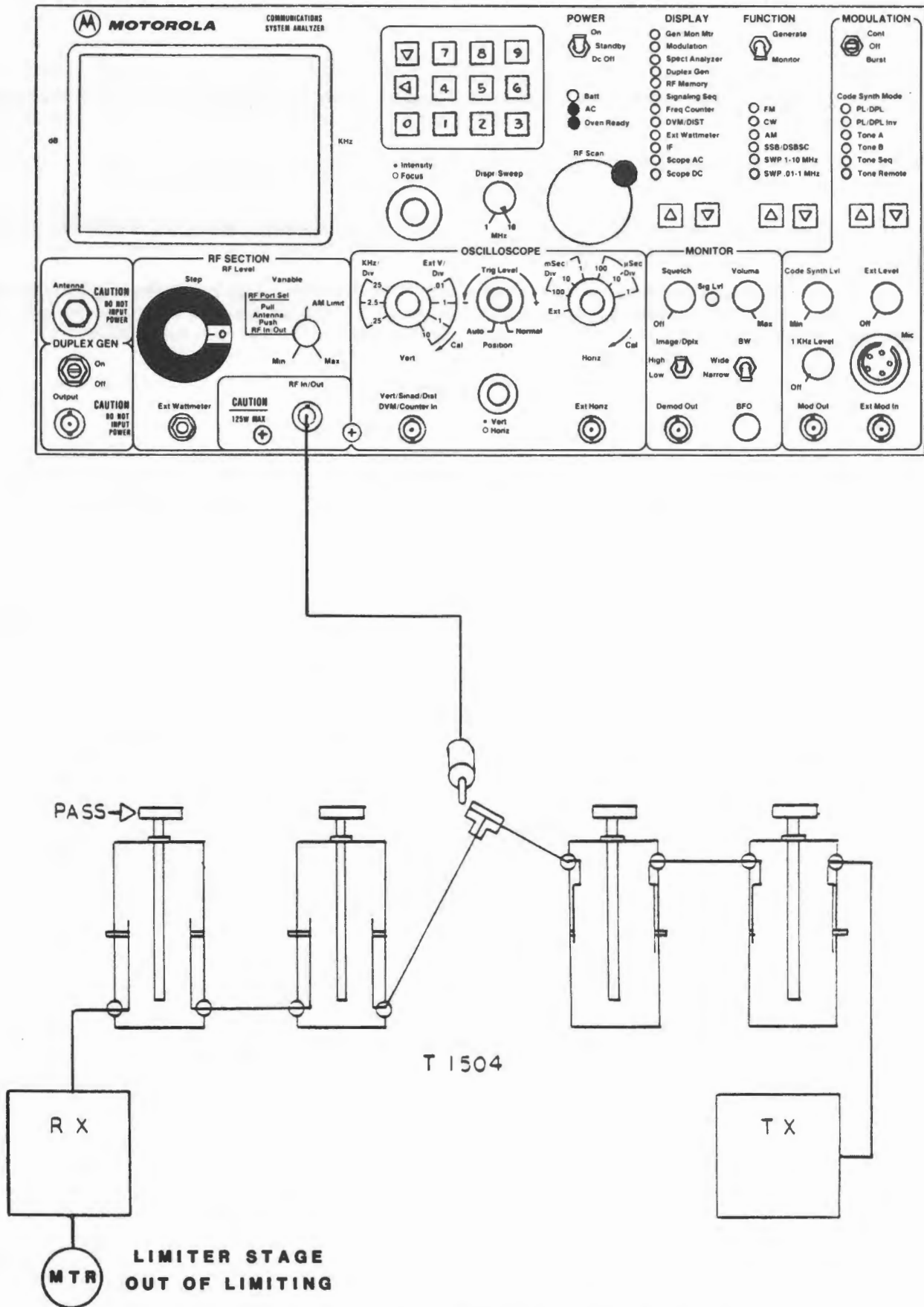

FIGURE 4-21. DUPLEXER PASSBAND ADJUSTMENT SETUP

**CAVITY & DUPLEXER TUNING  
BANDPASS WITH REJECT NOTCH**

**B. Adjustment of Reject Notch on Receive Leg**

1. Connect the Analyzer's RF In/Out to the in-service duplexer as shown in figure 4-22. Disconnect the cable at the duplexer receiver port that comes from the receiver. Move the Analyzer's RF In/Out cable from the duplexer antenna port to the duplexer receiver port. Connect a power-rated dummy load to the duplexer antenna port.
2. Set DISPLAY to Spectrum Analyzer, FUNCTION switch to Monitor, and attenuator to -30 dB. Verify that the display's center frequency reads the same as the transmit frequency in step A-7 above.
3. Key the transmitter and adjust the reject notch adjustments on the duplexer receive leg cavities for minimum signal on the display. Change the attenuator, as necessary, to keep the signal on the display.
4. Loosen the cavity reject adjustment nut and slide it within its slot while watching the display. Tighten the adjustment nut. Be careful not to mistune the rejection adjustment. Fine-tune the rejection adjustment by turning the bandpass knob a maximum  $\pm 15^\circ$ . This completes the duplexer receiver leg reject notch adjustment.

## CAVITY & DUPLEXER TUNING BANDPASS WITH REJECT NOTCH

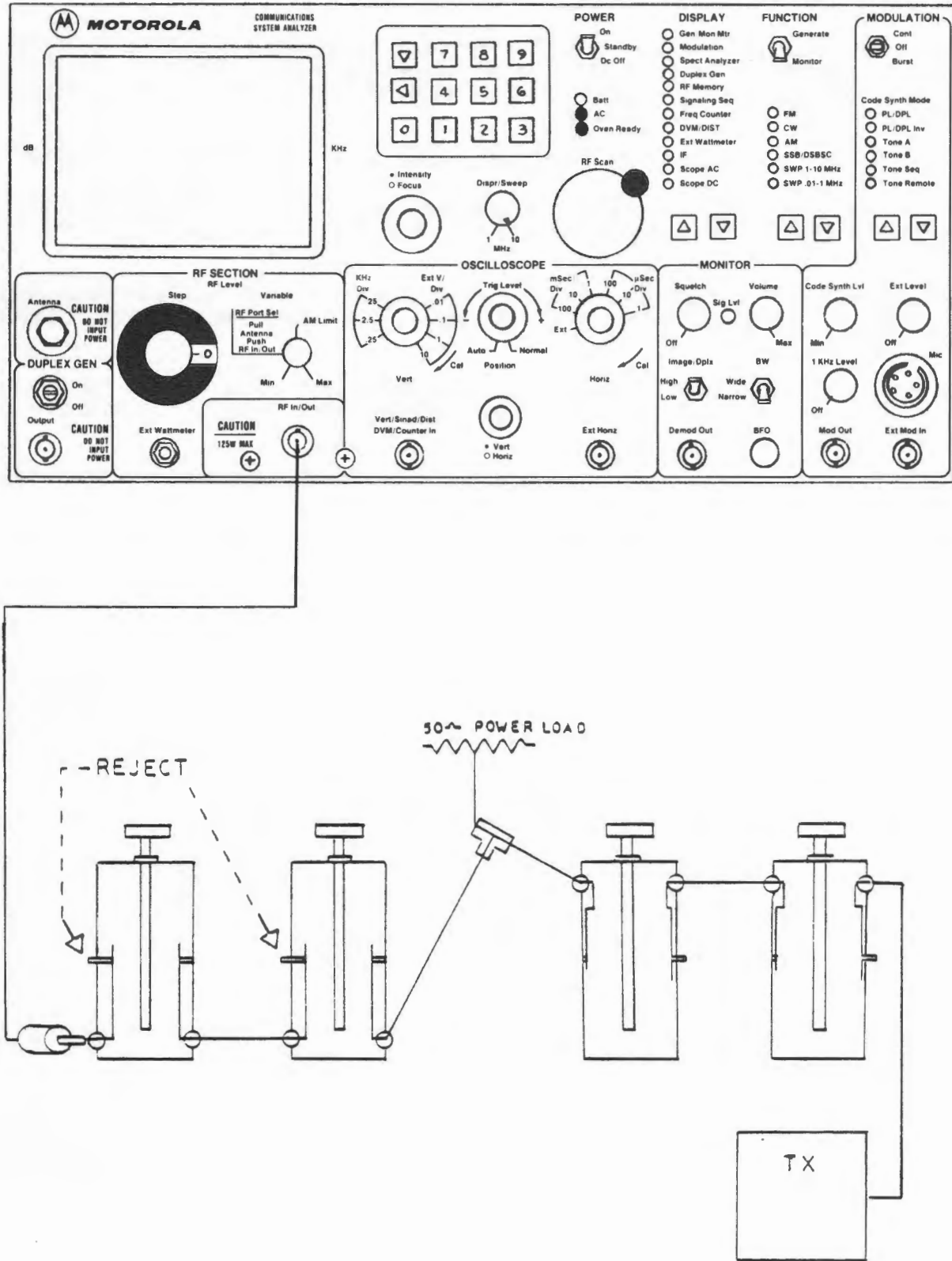

**FIGURE 4-22. DUPLEXER ADJUSTMENT SETUP;  
REJECT NOTCH ON RECEIVE LEG**

## **CAVITY & DUPLEXER TUNING BANDPASS WITH REJECT NOTCH**

### **C. Adjustment of Reject Notch on Transmit Leg**

1. Connect the Analyzer's RF In/Out to the in-service duplexer as shown in figure 4-23. Disconnect the cable at the duplexer transmitter port that comes from the transmitter. Move the Analyzer's RF In/Out cable from the duplexer receiver port to the duplexer transmission port. Reconnect the cable coming from the receiver to the duplexer receiver port. Disable the receiver PL.
2. Set DISPLAY to Gen/Mon Mtr, FUNCTION switch to Generate FM, and enter the receiver frequency.
3. Set the attenuator to -30 dB and the Variable control to mid-range, to allow adequate signal to get through the duplexer and quiet the receiver. Reduce the signal generator output, as necessary, to keep the receiver limiter meter below saturation.
4. Adjust the reject notch adjustments on the duplexer transmit leg cavities for minimum signal level on the receiver limiter meter. Change the signal generator output, as necessary, to keep the received signal up out of the noise and below saturation.
5. Loosen the cavity reject adjustment nut and slide it within its slot while watching the meter. Tighten the adjustment nut. Be careful not to mistune the rejection adjustment. Fine-tune the reject notch adjustment by turning the bandpass knob a maximum of  $\pm 15^\circ$ .
6. Remove the test equipment and connect the duplexer back to the repeater. Check the duplexer for insertion loss according to its specifications.

## CAVITY & DUPLEXER TUNING BANDPASS WITH REJECT NOTCH

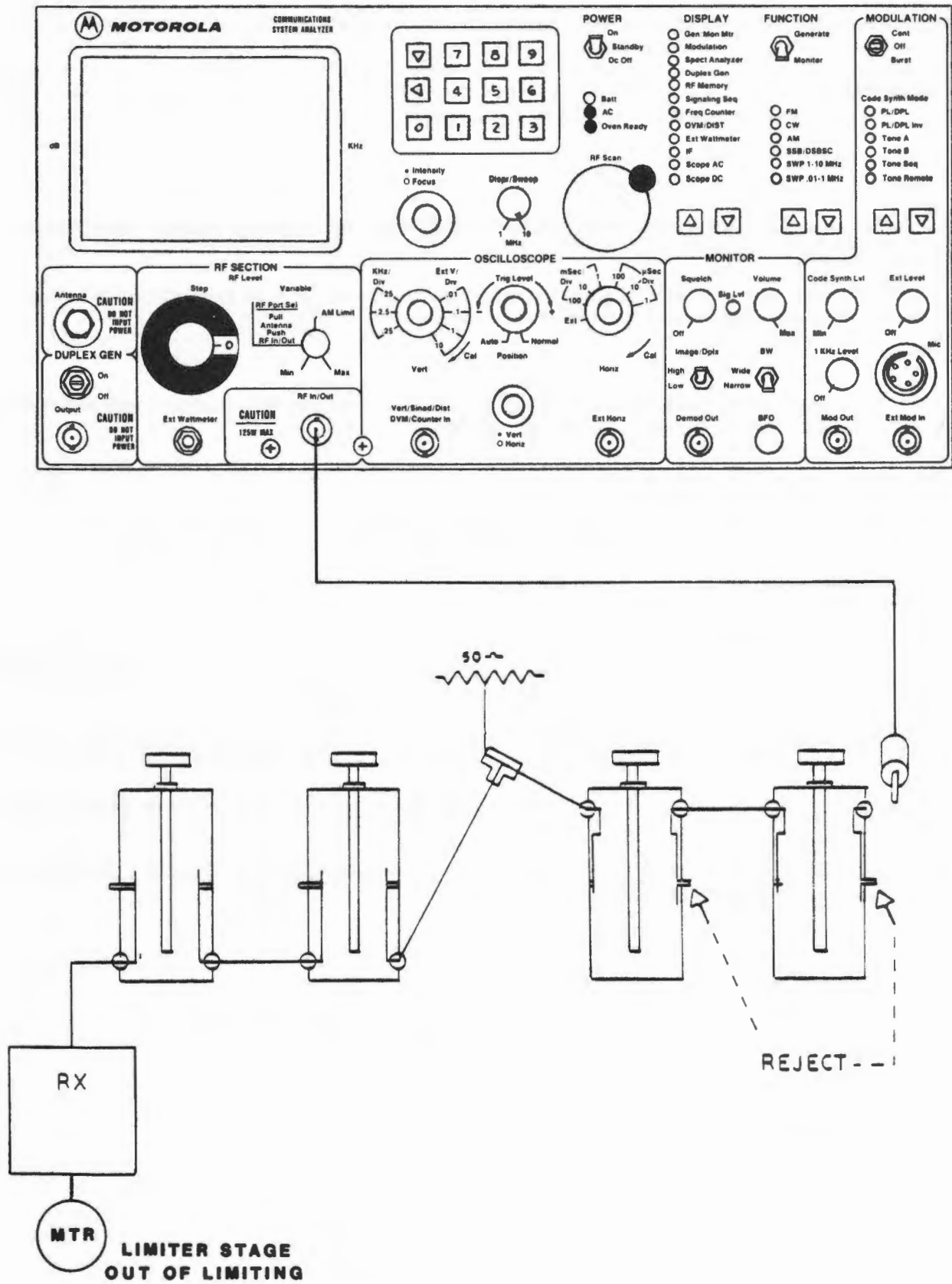

**FIGURE 4-23. DUPLEXER ADJUSTMENT SETUP;  
REJECT NOTCH ON TRANSMIT LEG**

## DESENSITIZATION TEST IN-SERVICE DUPLEXER

Perform this test after retuning a duplexer or after detecting inadequate isolation between transmitter and receiver. The following conditions may make a duplexer appear mistuned:

- High VSWR antenna
- IM between the repeater's transmitter and an external signal
- Faulty cables or connectors
- Improper cable length or configuration

Normally, repairing or replacing cables solves the problem without retuning. Check the duplexer manufacturer's data sheets to determine proper installation.

1. Connect the Analyzer to the repeater/duplexer under test, as shown in figure 4-24. Connect the RF In/Out to the duplexer's antenna port through an RF tap-off isolating device.

### CAUTION

To prevent RF overload into the generate, provide sufficient isolation between the tap-off and the straight-through feed. For example a 1000 W transmitter requires 50 dB isolation.

2. Connect the DVM input to the receiver speaker connection. Disconnect the cable from the RF In/Out to prevent the transmitter from keying up on repeat.
3. Set DISPLAY to Gen/Mon Mtr, FUNCTION to Generate FM, and enter the receiver frequency.
4. Set the attenuator to -60 dB and the Variable control to mid-range.
5. Adjust the 1 KHz Level control for 3.0 KHz DEV on the screen.
6. Reconnect the cable from RF In/Out to the RF tap-off and enable the transmitter to key-up. For example, it may be necessary to provide 0.75 KHz PL/DPL deviation for a PL/DPL accessed repeater.
7. With this generated signal introduced to the RF tap-off, adjust the signal generator level Step attenuator and the Variable control to the 12 dB SINAD level as indicated on the display. Note the generator RF LEVEL.
8. Disable the transmitter from key-up. Readjust the signal generator to obtain 12 dB SINAD again. Note the generator RF LEVEL.
9. The difference between the RF LEVEL for 12 dB SINAD with the transmitter off (step 8) and with the transmitter on (step 7), is the amount of system desensitization.
10. More than 2 dB desensitization may indicate:
  - defective antenna system
  - loose shields
  - transmitter spurs
  - improper or defective duplexer cable.

Check them all, before attempting to retune the duplexer.

# DESENSITIZATION TEST IN-SERVICE DUPLEXER

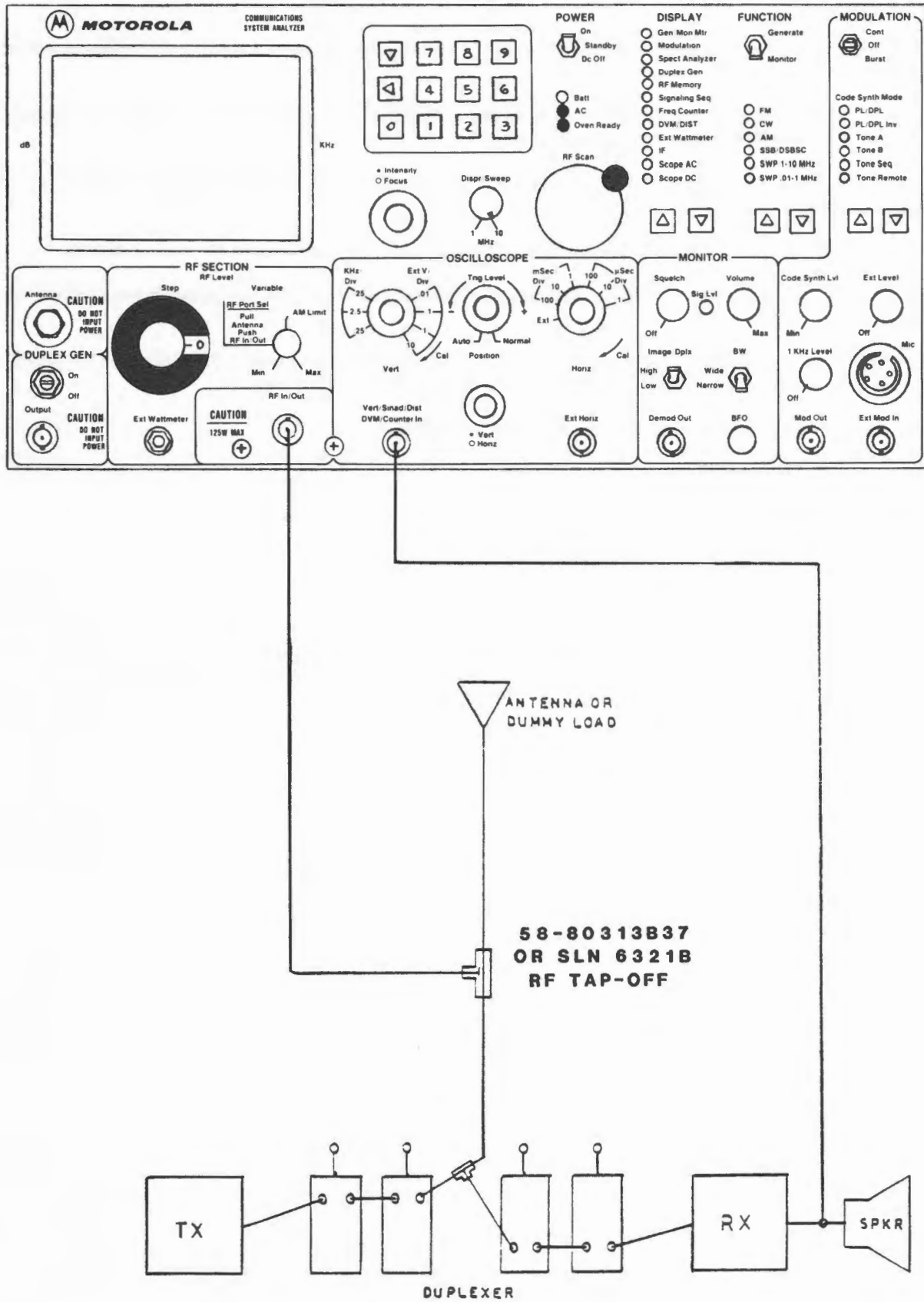

**FIGURE 4-24. DESENSITIZATION TEST SETUP**



## FERRITE ISOLATOR TEST

1. Use the Analyzer to test isolators for insertion loss and isolation. Connect the Analyzer to the isolator under test, as shown in figure 4-25.
2. Set DISPLAY to Duplex Gen and FUNCTION switch to Monitor FM. Enter the transmitter frequency and an offset of 0 MHz.
3. Use an RF adapter (bullet) to temporarily connect together the cables to the isolator. Turn on the Duplex Gen switch. Set DISPLAY to Gen/Mon Mtr and attenuator to 0 dB.
4. Note the RF LEVEL input value in dB, on the display. Use this value as the reference level to determine insertion loss and isolation values.
5. Reconnect the cables to the isolator; Duplex Gen to isolator input and RF In/Out to isolator output.
6. Note the RF LEVEL input value in dB, on the display. Subtract this value from the value found in step 4, to obtain the insertion loss in dB.
7. Reverse the connections to the isolator and again note the RF LEVEL input value in dB. Subtract this value from the value found in step 4, to obtain the isolation value in dB for the isolator under test.
8. Test dual isolators (connected in series) by the same procedure.

# FERRITE ISOLATOR TEST

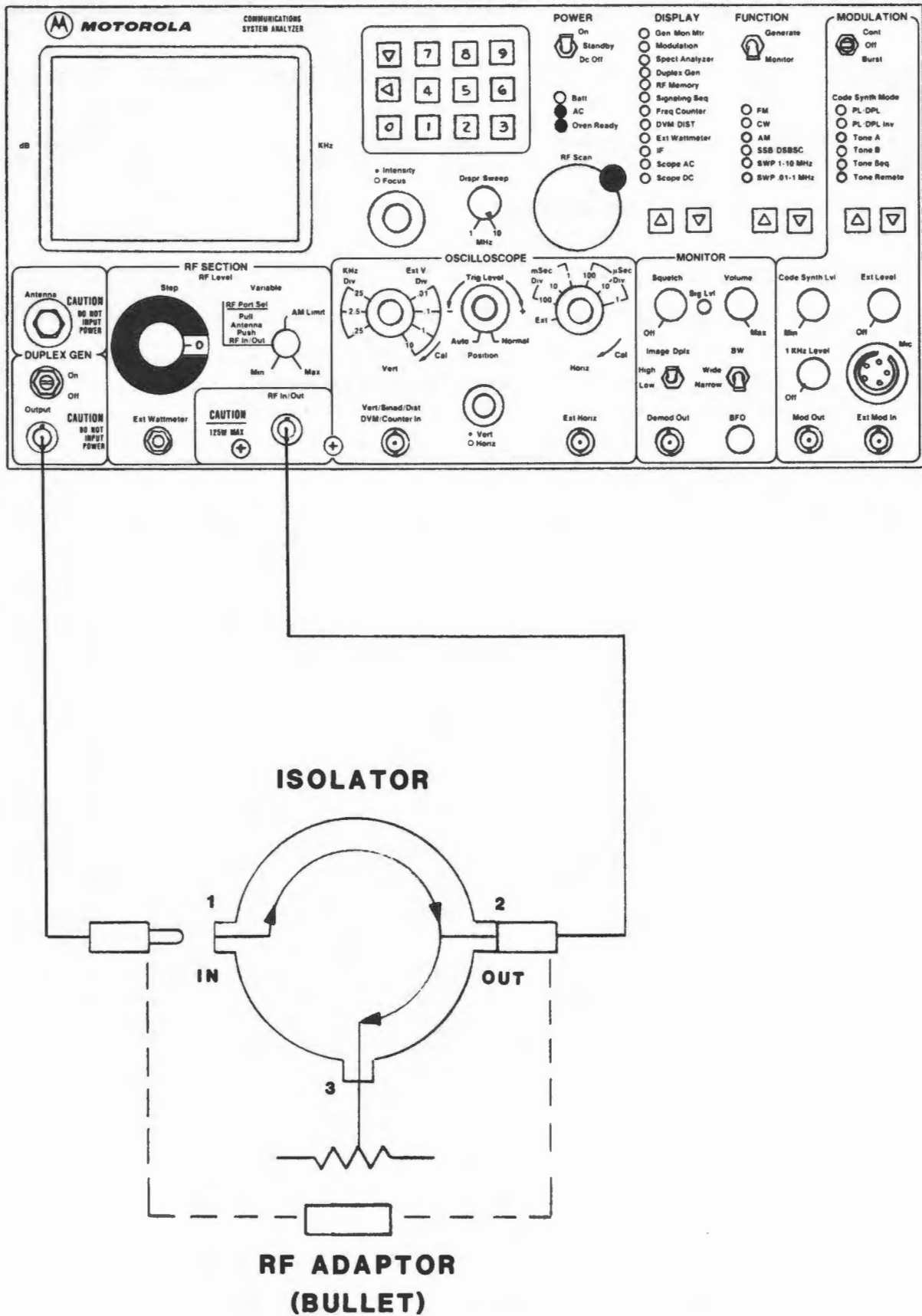

FIGURE 4-25. FERRITE ISOLATOR TEST SETUP



NOTATION



REVISIONS

APPROVED BY: \_\_\_\_\_

MOTOROLA, INC.  
 COMMUNICATIONS SECTOR  
 TEST EQUIPMENT SERVICE DEPOT  
 1308 PLUM GROVE ROAD  
 SCHAUMBURG, ILLINOIS 60173

MOTOROLA, INC.  
 COMMUNICATIONS SECTOR  
 TEST EQUIPMENT SERVICE CENTER  
 2333 B. UTAH AVENUE EL SEGUNDO, CA

**TEST EQUIPMENT SERVICE REQUEST FORM**

This completed form must accompany equipment returned for service.

CUSTOMER'S PURCHASE ORDER NO.		DATE	
MODEL NUMBER		SERIAL NUMBER	
DESCRIPTION OF PROBLEM:			
REQUESTED SERVICE:			
SHIP TO ADDRESS:			
SHIP VIA:			

Providing the information below will reduce the turnaround time on your Test Equipment Service.

MOTOROLA CUSTOMER NUMBER	BILL TAG	SHIP TAG	INTERNAL MOTOROLA ACCOUNT NO.

SIGNED: \_\_\_\_\_

C

THE UNIVERSITY OF CHICAGO LIBRARY

1215 EAST 58TH STREET, CHICAGO, ILL. 60637

TEL: (773) 707-3000 FAX: (773) 707-3001

WWW.CHICAGO.LIBRARY.EDU

CHICAGO LIBRARY

CHICAGO LIBRARY

CHICAGO LIBRARY

CHICAGO LIBRARY

CHICAGO LIBRARY

CHICAGO LIBRARY

CHICAGO LIBRARY

CHICAGO LIBRARY

CHICAGO LIBRARY

CHICAGO LIBRARY

CHICAGO LIBRARY

CHICAGO LIBRARY

CHICAGO LIBRARY

CHICAGO LIBRARY

CHICAGO LIBRARY

CHICAGO LIBRARY

CHICAGO LIBRARY

C

parts

**OPERATOR'S MANUAL  
COMMUNICATIONS SYSTEM ANALYZER**

**R-2001D  
68P81069A66-B**



GENERAL

This revision outlines changes that have occurred since the printing of your instruction manual. Use this information to correct your manual.

INSTRUCTION MANUAL AFFECTED:

68P81069A66-B R-2001D Communications System Analyzer  
OPERATOR'S MANUAL

REVISION DETAILS:

**New Address**

The Motorola Test Equipment Service Center, serving customers in the eastern and midwestern regions of the U.S., has moved to a new location. Please make the following address changes to your manual on the inside front cover, page 1-1, and the tear-out *Test Equipment Service Request Form* on page 4-49. The telephone number remains the same.

Address all future correspondence and direct returned equipment to:

Motorola Test Equipment Service Depot  
1308 Plum Grove Road  
Schaumburg, IL 60173

**Corrections to Published Performance Specifications**

Please note the following corrections to specifications tabulated on pages vii and viii.

**Signal Generator Mode**

FREQUENCY / Stabilization Time : 2 Sec

OUTPUT / Accuracy :  $\pm 4$  dB maximum. Unspecified for 0 dB attenuation.

AMPLITUDE MODULATION / Range : 0 to 70% from 1 to 500 MHz

DOUBLE SIDEBAND SUPPRESSED CARRIER / Carrier Suppression : -15 dB for 1 kHz audio  
@ 0 dBm

**General**

DUPLEX GENERATOR / Frequency Accuracy :  $\pm .002\%$  within 8 seconds after turn-on

FREQUENCY COUNTER / Normal / Range : 10 Hz to 30 MHz

FREQUENCY COUNTER / Auto Tune (SCAN LOCK) / Accuracy :  $\pm 1$  Hz of actual frequency  
 $\pm$  timebase accuracy

SIGNALLING SIMULATOR / Frequency Range : 5 Hz to 19,999.9 Hz encode, 5.0 Hz to 9999.9 Hz  
decode

The following specification has been added, which is applicable to units shipped after January 1, 1987.

**SERIAL PRINTER  
INTERFACE PORT**

<b>Data Format:</b>	Serial per EIA Standard RS-232-C
<b>Connector Type:</b>	5-pin DIN
<b>Signals:</b>	Printer Data, Data Set Ready, Ground
<b>Baud Rate:</b>	Selectable; 75, 150, 300, 600, 1200, 2400, 4800, or 9600
<b>Parity:</b>	Selectable; odd, even, or no parity
<b>Stop Bits:</b>	Selectable; 1 or 2 per character
<b>Transmit Bits:</b>	Selectable; 7 or 8 per character
<b>Auto Line Feed:</b>	Selectable on or off

**New Product Features (on units shipped after  
January 1, 1987)**

All of the following changes are with respect to software revisions which included the following enhancements and new features:

- added Print Screen utility and serial printer port as a standard feature;
- added DTMF encode and decode capability as a standard feature;
- simplified system part number screen, Special Function "99", to show only system version numbers and not file version numbers.

Page 2-7. The **Ext Level** control is also used to set the output level for DTMF encode signals, in addition to controlling the modulation level produced by external inputs.

A low impedance signal generator, connected to the **Ext Mod In** BNC-type connector, will disable the DTMF encoder.

Page 2-8. In addition to setting the vertical input gain for the oscilloscope and the sensitivity for the frequency counter, the **Vert** coarse (outside) and vernier (center) control knobs also set the sensitivity of the DTMF decoder. This applies to decoding signals off-the-air as well as from the front panel vertical input (baseband mode).



Page 3-7. For Special Function "99", the system part number screen will be displayed for 7 to 8 seconds, before normal operation is resumed. Only one screen is necessary for the Main system and all possible options, where previously there was one screen for each. In addition to showing the software version numbers, this screen also shows a true checksum value for the softwares, as well as the card cage slot position in which any options are installed. An example of this screen is shown.

#### SPECIAL FUNCTION 99

SYSTEM	VERS	CHKSUM	SLOT
-----	-----	-----	-----
MAIN	02AB3	(C8C)	A14
SECOM	02AB2	(BB6)	A12

Special Functions "75" and "15", "16", and "17" are described in the following sections.

## Screen Print Operating Instructions

Special Function "75" allows you to select a specific RS-232-C configuration. The default values are given in the following example.

PRINTER INIT (SPFC 75) SEL)-  
0) EXIT

BAUD RATE SEL 5) 1200 BAUD

STOP BITS SEL 1) 1 STOP BIT

PARITY SEL 1) NO PARITY

AUTO LINE FEED 1) YES

TRANSMIT BITS/CHAR 2) 8 BITS

### Printer Port Configuration

Using Special Function "75", you can set up the System Analyzer for a specific RS-232 configuration. When you select this Special Function, the Printer Init screen is displayed, as shown above. This screen shows the default values in the System Analyzer that occur when Special Function "79" (default reset) is performed. To change any of these values, move the cursor to the line you want to change and enter the number.

The options for each of the selections are as follows:

**Baud Rate**

- 1 75 baud
- 2 150 baud
- 3 300 baud
- 4 600 baud
- 5 1200 baud
- 6 2400 baud
- 7 4800 baud
- 8 9600 baud

**Stop Bits**

- 1 1 stop bit/character
- 2 2 stop bits/character

**Parity**

- 1 no parity
- 2 even parity
- 3 odd parity

**Auto Line Feed**

- 1 on
- 2 off

**Transmit Bits**

- 1 7 bits/character
- 2 8 bits/character

If you change any of these values, the changes are retained in nonvolatile memory until Special Function "79" is selected.

**Printer Connection**

On the right side of the System Analyzer, at the rear, is a 5-pin DIN type printer output connector. This connection can be used to generate and receive RS-232-C signals similar to those in a personal computer. When the System Analyzer is properly connected to a printer and correctly configured (see above), you can print the data displayed on the screen.

Many types of printers can be used with the System Analyzer, including the following printers from Motorola:

RT-RX80/8143

RT-RX80/8143/220 (220 Volt version)

The printer cable accessory is a Motorola RTK-4081A. You can also use a serial printer cable for an Apple IIC<sup>®</sup>.

<sup>®</sup> Apple IIC is a registered trademark of Apple Computer Corp.

## Printing the Screen

To print a screen, simultaneously press the 0 key and the < (left cursor) key. Any characters displayed on the screen are printed directly. If a bar graph is displayed, the # character is printed to show the length of the bar. **Wave forms cannot be printed.**

If you try to print the screen when the printer is off line, a "PRINTER BUSY" message is displayed for 3 seconds (unless a waveform screen is displayed). If the System Analyzer's character buffer is full, a "WAIT" message will appear for about 3 seconds. If the printer accepts the output, you'll hear a beep from the System Analyzer's speaker.

### Page 3-11 • SIGNALING SEQUENCE

Dual Tone Multiple Frequency (DTMF) encode and decode capability has been added to the System Analyzer.

#### • SIGNALING SEQUENCE MENU

With the addition of the DTMF functions, the signaling sequence menu shown in Figure 3-21 is changed to the following:

SIGNALING SEQUENCE MODE SEL) 0 -

- 1] A/B ENCODE
- 2] 5/6 TN ENCODE/DECODE
- 3] SELECT V ENCODE/DECODE
- 4] PL DECODE
- 5] DPL DECODE
- 6] GENERAL SEQ ENCODE/DECODE
- 7] MOBILE TELEPHONE
- 8] DTMF ENCODE/DECODE

# DTMF Encoder/Decoder Operating Instructions

## • DTMF ENCODE

DTMF encode mode may be entered from either the Signaling Sequence screen, by entering **8** from the keypad, or by initiating Special Function "15" or "16".

The following figure shows the DTMF screen, which is used for both encode and decode mode. The lower half of the screen is for DTMF encode.

SIGNALING SEQUENCE MODE SEL) -

1) RESET DECODE

DTMF DECODE

DTMF ENCODE SEL)-

*PRESS KEY FOR DTMF TONE*

*PRESS LEFT CURSOR FOR BURST*

BURST ENCODE NUMBER

*123456789\*0#ABCD*

TONE) 0100 MS      DELAY) 0050 MS

### Manual Keypad Entry

When you move the cursor to the SEL area (opposite DTMF ENCODE), a help message, shown in italics above, automatically appears. If you press and hold a DTMF key at this time, the tone is generated and remains on until you release the key.

The active DTMF keys are digits 1 through 9 and 0, and the 6 front panel up/down selector keys immediately below the DISPLAY, FUNCTION, and MODULATION LED indicators. The normal function of these keys is disabled in the DTMF mode, so be sure to preselect the desired function and code synthesizer mode before entering the DTMF screen. (See **Setting Modulation Level** below for more information on this subject.) The DTMF symbols are screened on the front panel above these keys on current production units. For users who retrofit this feature, the symbols are assigned left to right as follows: A, B, C, D, \*, and #.

## Sequence Encoder

DTMF tone sequences are entered and generated by moving the cursor to the area under BURST ENCODED NUMBER. If a number is already displayed, as shown in italics in the example above, it will be erased when you enter the first digit of the new sequence. If you want to alter (rather than erase) the displayed number, use the left cursor key to position the cursor over the digit you want to change.

You can enter the length of the automatic tones at the bottom of the screen, by TONE. The delay between tones can also be set on this line, to the right of DELAY. The length and delay are set independently, from 1 millisecond to 9.999 seconds in 1 millisecond steps. To function properly, most systems require at least a 40 millisecond tone and delay. To start the DTMF tone sequence, move the cursor to the mid-screen position (SEL) -) and press the < (left cursor) key.

## To Exit

To exit the DTMF screen, move the cursor to the top of the screen and press 0. If a DTMF sequence is in progress when you exit the DTMF screen, the sequence will be continued until completed.

## Setting Modulation Level

Multiple modulations are possible with DTMF. Any P-L, DPL, Tone A, Tone B, or tone sequence can be activated before entering the DTMF screen, and will continue during DTMF generation. The level for DTMF is controlled by the **Ext Level** knob on the front panel. The level of the other tones can be set separately by the **Code Synth Lvl** knob. For example, you can set the P-L tone to its standard low deviation to access a phone interconnect system, and set the voice and DTMF to a higher level to actually use the system.

Normal speech in the microphone supplied with the System Analyzer will result in a modulation level close to that of the DTMF signal.

### NOTE

A low impedance signal generator connected to the BNC **Ext Mod In** connector will disconnect DTMF.

## Generator Deviation Setup

Setting the deviation level for DTMF modulation requires the use of a Special Function, to activate the DTMF encoder without being in the signaling sequence screen. The procedure is as follows:

1. Select the **Gen/Mon Mtr** display and switch to the **Generate** function.
2. Enable Special Function "16" by pressing both cursor control keys simultaneously and entering **16**.
3. Press and hold any DTMF key and adjust the **Ext Level** pot to the desired deviation level - typically 3 kHz peak deviation.
4. Disable Special Function "16" by entering Special Function "17".
5. Operate the manual or sequence encoder as described in the paragraphs above.

### • **DTMF DECODE**

DTMF decode mode may be entered from either the Signaling Sequence screen, by entering **8** from the keypad, or by initiating Special Function "15".

The upper half of the DTMF screen shown in the previous section applies to DTMF decode. When you have selected this screen, DTMF decode is automatic. The decoded DTMF digits are displayed sequentially under DTMF DECODE. Up to 30 digits can be displayed. To decode correctly, the length of the tones must be at least 40 milliseconds and there must be at least a 40 millisecond delay between tones. To clear the DTMF decode line, enter **1** at the top of the screen.

### DTMF Decoder Sensitivity

The DTMF decoder receives its signal from the oscilloscope's CRT input. To decode reliably, the signal amplitude must be adjusted for a peak-to-peak level of 20% to 80% of the total screen height when displayed on the oscilloscope. Use the **Vert** sensitivity controls to adjust the amplitude of the input signal. *Do this before entering the DTMF screen.*

The procedure for setting sensitivity depends upon the input source you select. The default condition is to decode the signal from the monitor receiver (off-the-air). To decode from the front panel's **Vert Input**, you need to select Special Function "11", baseband. You can cancel baseband operation by entering Special Function "10".

### Setting DTMF Decoder Sensitivity

1. Select the input port - RF or baseband, as described above - and switch to the **Monitor** function.
2. Apply the external signal to the selected port.
3. Select the **Scope AC** display (for baseband) or the **Modulation** display (for RF).
4. Calibrate the input signal by adjusting the scope **Vert** coarse (outside) and verier (center) control knobs until the trace covers between 20% and 80% of the screen.
5. Re-enter the DTMF mode.

MOTOROLA, INC.  
 COMMUNICATIONS SECTOR  
 TEST EQUIPMENT SERVICE DEPOT  
 1308 PLUM GROVE ROAD  
 SCHAUMBURG, ILLINOIS 60173

MOTOROLA, INC.  
 COMMUNICATIONS SECTOR  
 TEST EQUIPMENT SERVICE CENTER  
 2333 B. UTAH AVENUE EL SEGUNDO, CA

**TEST EQUIPMENT SERVICE REQUEST FORM**

This completed form must accompany equipment returned for service.

CUSTOMER'S PURCHASE ORDER NO.		DATE	
MODEL NUMBER		SERIAL NUMBER	
DESCRIPTION OF PROBLEM:			
REQUESTED SERVICE:			
SHIP TO ADDRESS:			
SHIP VIA:			

Providing the information below will reduce the turnaround time on your Test Equipment Service.

MOTOROLA CUSTOMER NUMBER	BILL TAG	SHIP TAG	INTERNAL MOTOROLA ACCOUNT NO.

SIGNED: \_\_\_\_\_