ADVANTEST[®]
ADVANTEST CORPORATION

R6551

Digital Multimeter

Operation Manual

MANUAL NUMBER FOE-8311246D01

Applicable models

- ***R6551***
- ***R6551EMC***

Safety Summary

To ensure thorough understanding of all functions and to ensure efficient use of this instrument, please read the manual carefully before using. Note that Advantest bears absolutely no responsibility for the result of operations caused due to incorrect or inappropriate use of this instrument.

If the equipment is used in a manner not specified by Advantest, the protection provided by the equipment may be impaired.

- **Warning Labels**

Warning labels are applied to Advantest products in locations where specific dangers exist. Pay careful attention to these labels during handling. Do not remove or tear these labels. If you have any questions regarding warning labels, please ask your nearest Advantest dealer. Our address and phone number are listed at the end of this manual.

Symbols of those warning labels are shown below together with their meaning.

DANGER: Indicates an imminently hazardous situation which will result in death or serious personal injury.

WARNING: Indicates a potentially hazardous situation which will result in death or serious personal injury.

CAUTION: Indicates a potentially hazardous situation which will result in personal injury or a damage to property including the product.

- **Basic Precautions**

Please observe the following precautions to prevent fire, burn, electric shock, and personal injury.

- Use a power cable rated for the voltage in question. Be sure however to use a power cable conforming to safety standards of your nation when using a product overseas.
- When inserting the plug into the electrical outlet, first turn the power switch OFF and then insert the plug as far as it will go.
- When removing the plug from the electrical outlet, first turn the power switch OFF and then pull it out by gripping the plug. Do not pull on the power cable itself. Make sure your hands are dry at this time.
- Before turning on the power, be sure to check that the supply voltage matches the voltage requirements of the instrument.
- Be sure to plug the power cable into an electrical outlet which has a safety ground terminal. Grounding will be defeated if you use an extension cord which does not include a safety ground terminal.
- Be sure to use fuses rated for the voltage in question.
- Do not use this instrument with the case open.

Safety Summary

- Do not place objects on top of this product. Also, do not place flower pots or other containers containing liquid such as chemicals near this product.
- When the product has ventilation outlets, do not stick or drop metal or easily flammable objects into the ventilation outlets.
- When using the product on a cart, fix it with belts to avoid its drop.
- When connecting the product to peripheral equipment, turn the power off.

- **Caution Symbols Used Within this Manual**

Symbols indicating items requiring caution which are used in this manual are shown below together with their meaning.

DANGER: Indicates an item where there is a danger of serious personal injury (death or serious injury).

WARNING: Indicates an item relating to personal safety or health.

CAUTION: Indicates an item relating to possible damage to the product or instrument or relating to a restriction on operation.

- **Safety Marks on the Product**

The following safety marks can be found on Advantest products.



: ATTENTION - Refer to manual.



: Protective ground (earth) terminal.



: DANGER - High voltage.



: CAUTION - Risk of electric shock.

- **Replacing Parts with Limited Life**

The following parts used in the instrument are main parts with limited life.

Replace the parts listed below after their expected lifespan has expired.

Note that the estimated lifespan for the parts listed below may be shortened by factors such as the environment where the instrument is stored or used, and how often the instrument is used.

There is a possibility that each product uses different parts with limited life. For more information, refer to Chapter 1.

Main Parts with Limited Life

Part name	Life
Unit power supply	5 years
Fan motor	5 years
Electrolytic capacitor	5 years
LCD panel	6 years
LCD backlight	2.5 years
Floppy disk drive	5 years

- **Precautions when Disposing of this Instrument**

When disposing of harmful substances, be sure dispose of them properly with abiding by the state-provided law.

Harmful substances: (1) PCB (polycarbon biphenyl)
 (2) Mercury
 (3) Ni-Cd (nickel cadmium)
 (4) Other

Items possessing cyan, organic phosphorous and hexadic chromium and items which may leak cadmium or arsenic (excluding lead in solder).

Example: fluorescent tubes, batteries

Environmental Conditions

This instrument should only be used in an area which satisfies the following conditions:

- An area free from corrosive gas
- An area away from direct sunlight
- A dust-free area
- An area free from vibrations

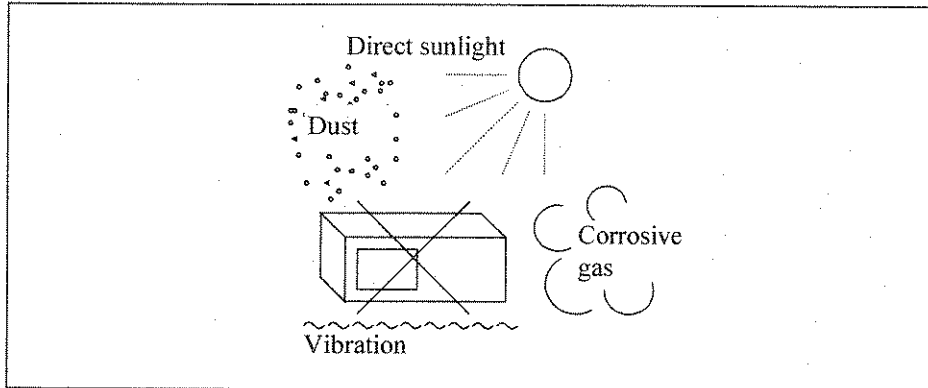

Figure-1 Environmental Conditions

- Instrument Placement

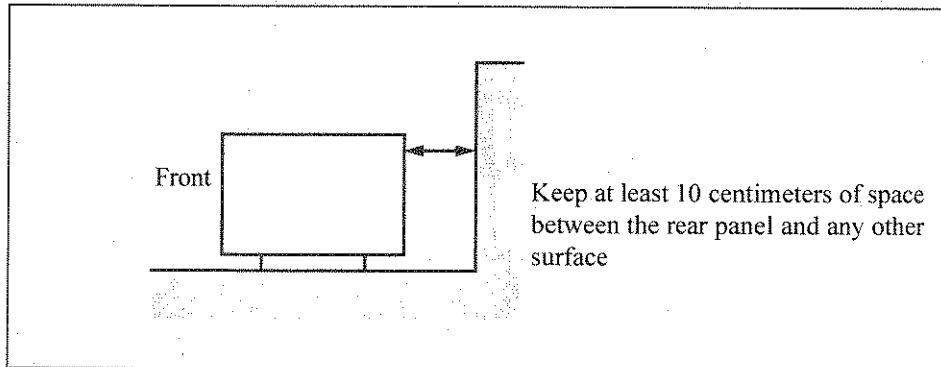

Figure-2 Instrument Placement



This instrument can be used safely under the following conditions:

- Altitude of up to 2000 m
- Installation Categories II
- Pollution Degree 2

Table of Power Cable Options

There are six power cable options (refer to following table).

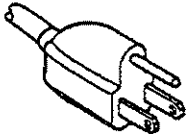
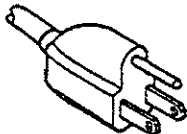
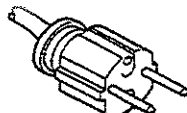
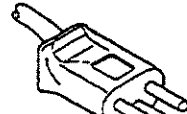
Order power cable options by Model number.

	Plug configuration	Standards	Rating, color and length	Model number (Option number)
1		JIS: Japan Law on Electrical Appliances	125 V at 7 A Black 2 m (6 ft)	Straight: A01402 Angled: A01412
2		UL: United States of America CSA: Canada	125 V at 7 A Black 2 m (6 ft)	Straight: A01403 (Option 95) Angled: A01413
3		CEE: Europe DEMKO: Denmark NEMKO: Norway VDE: Germany KEMA: The Netherlands CEBEC: Belgium OVE: Austria FIMKO: Finland SEMKO: Sweden	250 V at 6 A Gray 2 m (6 ft)	Straight: A01404 (Option 96) Angled: A01414
4		SEV: Switzerland	250 V at 6 A Gray 2 m (6 ft)	Straight: A01405 (Option 97) Angled: A01415
5		SAA: Australia, New Zealand	250 V at 6 A Gray 2 m (6 ft)	Straight: A01406 (Option 98) Angled: -----
6		BS: United Kingdom	250 V at 6 A Black 2 m (6 ft)	Straight: A01407 (Option 99) Angled: A01417

R6551
DIGITAL MULTIMETER
INSTRUCTION MANUAL

Preface

PREFACE

- ① This manual covers operations of the R6551 and R6551EMC.
- ② In this manual, the panel diagrams use the R6551.
- ③ All information contained in this manual that refers to the R6551/R6551EMC or this equipment is common to each of the R6551 and R6551EMC.

R6551
DIGITAL MULTIMETER
INSTRUCTION MANUAL

Table of Contents

TABLE OF CONTENTS

1. GENERAL INFORMATION	1 - 1
1.1 Manual Overview	1 - 1
1.2 General	1 - 2
1.3 Before Using Equipment	1 - 4
1.3.1 Checking Appearance and Accessories Supplied	1 - 4
1.3.2 Precautions	1 - 4
1.4 Notes On Use of Power Cable	1 - 6
1.5 Input Cable Structure	1 - 7
1.6 Fuses	1 - 8
2. IDENTIFICATION OF EACH PART	2 - 1
2.1 Front Panel	2 - 1
2.2 Rear Panel	2 - 9
3. SAMPLE KEY OPERATIONS	3 - 1
4. STARTING OPERATION	4 - 1
4.1 Setting Up Equipment	4 - 1
4.2 NULL Operation	4 - 5
4.3 SCALE Operation	4 - 6
4.4 Selection of Measuring Functions	4 - 7
5. GPIB INTERFACE	5 - 1
5.1 Introduction	5 - 1
5.2 Specifications	5 - 2
5.3 Interconnecting GPIB System Components	5 - 4
5.4 Address Setting and Header ON/OFF Selection	5 - 5
5.5 Talker Specification	5 - 7
5.5.1 Data Format	5 - 7
5.5.2 Output Format	5 - 10
5.5.3 Binary Output Format	5 - 10
5.6 Listener Specification	5 - 11
5.7 Service Request (SRQ)	5 - 14
5.8 Command Codes	5 - 17
5.9 Sample Programs	5 - 20
5.10 Outline Operation Flowchart	5 - 26
5.10.1 Notes on Operations	5 - 27
6. BCD OUTPUT (OPT01) (R6551 only)	6 - 1
6.1 Introduction	6 - 1
6.2 Data Output Code and Data Output Connector	6 - 2
6.3 Operating Procedures	6 - 5
6.3.1 Connection to Digital Recorder	6 - 5
6.3.2 Connection to Equipment Other than Digital Recorder	6 - 5
6.3.3 Measuring Timing	6 - 6
6.4 Specifications	6 - 8

R6551
DIGITAL MULTIMETER
INSTRUCTION MANUAL

Table of Contents

7. SPECIFICATION, OPTIONS, AND ACCESSORIES	7 - 1
7.1 Specification	7 - 1
7.2 Option	7 - 9
7.3 Accessories (Purchased)	7 - 9
8. CHECKING AND CALIBRATION	8 - 1
8.1 Troubleshooting by User	8 - 1
8.2 Calibration	8 - 2
8.2.1 Preparation	8 - 2
8.2.2 Calibration Method	8 - 4
8.2.3 Sample Calibrations	8 - 7
9. DESCRIPTION OF R6551/R6551EMC OPERATION	9 - 1
9.1 Outline of R6551/R6551EMC Operation	9 - 1
9.2 AD Converter	9 - 3
INDEX	I - 1

EXTERNAL VIEW

R6551
DIGITAL MULTIMETER
INSTRUCTION MANUAL

List of Figures

LIST OF FIGURES

No.	Title	Page
1 - 1	Power Cable Plug and Adapter	1 - 6
1 - 2	Input Cable Structure	1 - 7
2 - 1	Input cable connection for measuring four-wire resistance.....	2 - 7
2 - 2	Front Panel	2 - 12
2 - 3	Rear Panel	2 - 12
4 - 1	Line Frequency Setting	4 - 1
5 - 1	GPIB Connector Pin Assignment	5 - 2
5 - 2	GPIB Operation Flowchart	5 - 26
6 - 1	BCD Output Connector	6 - 3
6 - 2	Output Circuit of BCD Output Unit	6 - 6
6 - 3	External Start Input Circuit	6 - 8
9 - 1	R6551/R6551EMC Block Diagram	9 - 2
9 - 2	Outline of AD Converter Operation	9 - 3

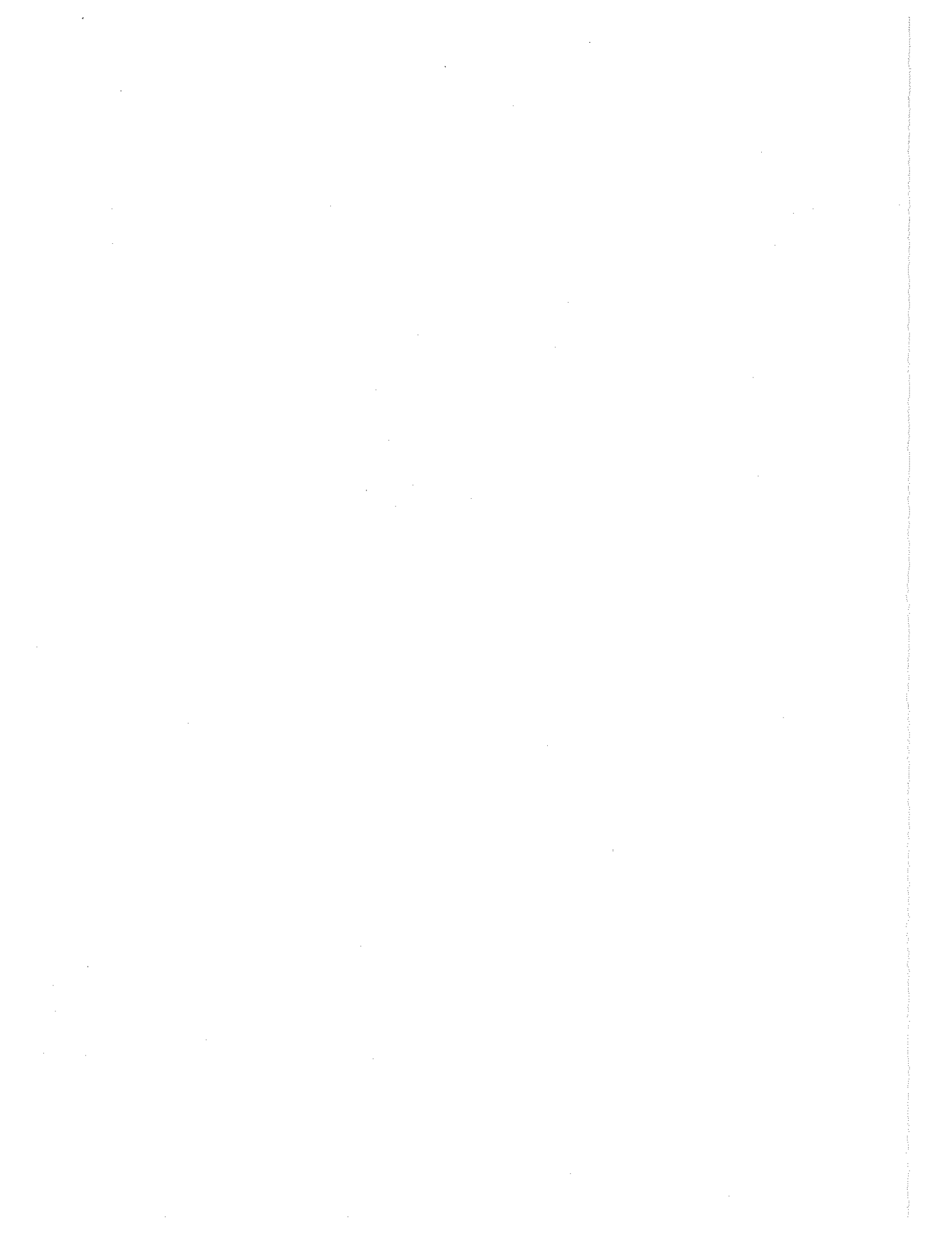

R6551
DIGITAL MULTIMETER
INSTRUCTION MANUAL

List of Tables

LIST OF TABLES

No.	Title	Page
1 - 1	List of Accessories Supplied	1 - 4
1 - 2	Specifications of Fuses	1 - 8
5 - 1	Interface Functions	5 - 3
5 - 2	Standard Bus Cables	5 - 4
5 - 3	Address Codes	5 - 5
5 - 4	Data in Mantissa and Exponent Parts (in 5 1/2-digit Display)	5 - 9
5 - 5	Program Codes	5 - 11
5 - 6	State Changes Caused by Commands	5 - 16
5 - 7	Command Codes	5 - 17
6 - 1	BCD Data Output Codes	6 - 2
6 - 2	Data Output Connector (57-40500 Manufactured by Dai-ichi Denshi Kogyo)	6 - 3
8 - 1	Check Items	8 - 1
8 - 2	Equipments for Calibration	8 - 3
8 - 3	Calibration Items and Recommended Input Values	8 - 4

1. GENERAL INFORMATION

1.1 Manual Overview

This instruction manual consists of the following chapters:

1. GENERAL INFORMATION	Outlines this equipment for the user who uses it for the first time.
2. IDENTIFICATION OF EACH PART 3. SAMPLE KEY OPERATIONS 4. STARTING OPERATION	Describes the function of each part of the panels and how to use it. Chapter 3 examples simple key operations to help the user learn how to use this equipment.
5. GPIB INTERFACE (5.9 Sample Programs)	Explains how to fully remote control this equipment using a personal or system computer.
6. BCD OUTPUT (OPT01) (R6551 only)	Describes option 01. Option 01 is effective on R6551 only.
7. SPECIFICATION, OPTIONS, AND ACCESSORIES	
8. CHECKING AND CALIBRATION	Helps the user to troubleshoot with this equipment and make calibration.
9. DESCRIPTION OF R6551/ R6551EMC OPERATION	Summarizes the operation of this equipment.

R6551
DIGITAL MULTIMETER
INSTRUCTION MANUAL

1.2 General

1.2 General

R6551/R6551EMC (=this equipment) is a high-performance digital multimeter which measures DC voltage, AC voltage (true root-mean-square (rms) value), resistance (using two-wire and four-wire conductors), DC current, and AC current (true rms value). This equipment displays measured values in up to 5 1/2 digits of 319999.

In addition to the above measuring functions, this equipment has the functions of NULL operation to correct the off-set and measure relative values, and SCALE operation to display the relative ratios. It also has the external trigger function and a measurement end signal output connector. This equipment sets the integration time selected depending on the necessary measurement accuracy, and allows high-speed measurement (resulting in 4 1/4 digits) for 100 times per second.

In R6551EMC, measurement with few generation of the radiation noise can be done by reinforcing the shield of the front panel and the frame.

This equipment is provided with a digital interface for programmable instrumentation called general-purpose interface bus (GPIB) as a standard attachment.

The GPIB allows this equipment to set measurement parameters, output data, and make up an automatic instrumentation system using a personal or system computer.

R6551 is provided with the OPT01 for BCD parallel data output as an option.

Features:

- Displays measured values in up to 5 1/2 digits of 319999 with 3ppm resolution.
- Allows highly sensitive measurement to be done with DC voltage resolution of 1 μ V and resistance resolution of 1M Ω .
- Makes stable measurement through integral AD conversion for integration time selection and setting.
- Performs high-speed sampling for 100 times per second and displays it in up to 4 1/2 digits.
- Measures resistance using a four-wire measuring system not affected by the resistance of the measurement cable
- Measures AC voltage and current by a true rms value measuring method.
- Measures AC voltages within the wide frequency band range from 20Hz to 300kHz.

R6551
DIGITAL MULTIMETER
INSTRUCTION MANUAL

1.2 General

- Displays output data, units, and functions with clear green LEDs.
- Optimizes a measuring range at high speed using a high-speed auto-range.
- Provides the NULL function to correct the off-set promptly.
- Provides the SCALE function to set and calculate 100% values promptly.
- Optimized to be integrated into a full-remote automatic instrumentation system using the GPIB interface provided as a standard attachment.
- Has external trigger input and measurement end signal output terminals.
- Provided with BCD parallel data output as an option. (R6551 only)
- Has the setting storage function to store panel setting states in the built-in non-volatile memory.
- Can be calibrated by the program via the GPIB without opening the case, and has the storage for calibration data protected by the dedicated switch.
- Allows high-precision measurement using the high-precision reference voltage and a thin film resistor.
- Can be connected with a cable-lock type input cable (to the front panel) to prevent danger.
- Uses input terminals with screw-type binding posts for sensors and general-purpose input lines on the rear panel, allowing one of the input terminals on the front and rear panels to be set selectively by the panel switch.
- Even when DUT receives the effect easily from electromagnetic surroundings environments to suppress the generation of the radiation noise small in R6551EMC, steady measurement is possible.

R6551
DIGITAL MULTIMETER
INSTRUCTION MANUAL

1.3 Before Using Equipment

1.3 Before Using Equipment

1.3.1 Checking Appearance and Accessories Supplied

Upon delivery check this equipment for external damage caused during transportation. Then check the quantity and specification of each accessory supplied according to Table 1-1.

If any damage is found or if any accessory is missing, contact your local ADVANTEST office or agent.

Note: When ordering supplied accessory, specify its model or stock No.

Table 1 - 1 List of Accessories Supplied

Accessory name	Model	Stock No.	Qty	Remarks
Power cable	A01402	-	1	Two-pin adapter provided
Input cable	A01001	-	1	Case provided
Power fuses	Slow-blow fuse 0.16A (EAWK 0.16A)	DFT-AAR16A	2*	For 100/120VAC
	Slow-blow fuse 0.063A (EAWK 0.063A)	DFT-AAR063A		For 220/240VAC
Protective fuse	Normal pre-arcing fuse 3.15A (TMF51NR3.15A)	DFN-AA3R15A	2	
Instruction manual	-	JR6551	1	Japanese version
	-	ER6551		English version

*: One of two power fuses is stored in the fuse holder of the power connector.

1.3.2 Precautions

- (1) When using this equipment with a commercial power supply, be sure to use the attached power cable. The power supply must provide 90V to 110V (or 103V to 132V, 198V to 242V, or 207V to 250V depending on the country) and line frequency of 48Hz to 66Hz.
- (2) Be sure to check that the POWER switch of this equipment is off before connecting the power cable to it or incorporating an accessory unit into it.

R6551
DIGITAL MULTIMETER
INSTRUCTION MANUAL

1.3 Before Using Equipment

(3) Warming Up this Equipment

Warm up this equipment for an hour or more before starting measurement to ensure the specified measurement accuracy.

(4) Ambient Operating Environment

Operate this equipment at an ambient temperature between 0 and 50°C and humidity of 85% RH or less. Use this equipment in a well-ventilated place not exposed to direct sunlight. Be careful in handling this equipment so as not to give it any severe vibration or mechanical shock.

(5) Notes on Storage

When this equipment will not be used for a long period of time, put it in a corrugated cardboard box after wrapping it in vinyl, for example, and store it in a dry place away from direct sunlight. When storing this equipment, keep the ambient temperature within the -25 to +70°C.

R6551
DIGITAL MULTIMETER
INSTRUCTION MANUAL

1.4 Notes On Use of Power Cable

1.4 Notes On Use of Power Cable

Before using this equipment on commercial power, be sure to ground this equipment to prevent electric shock. Connect the concave end of the attached power cable (A01402) to the AC LINE connector. The power cable has a three-prong plug whose round prong is to be grounded.

When using a two-prong adapter to plug the power cable to a receptacle, connect the ground lead of the adapter to ground. The attached adapter A09034 (KPR-18) conforms to the Electric Appliance Regulations. As shown in Figure 1-1, prongs A and B of A09034 are different in width, so make sure which is which when plugging this adapter into a receptacle. Note that if the ground lead touches an AC line such as a power-supply terminal, this equipment may be damaged. Pay special attention when the ground lead comes close to other plugs.

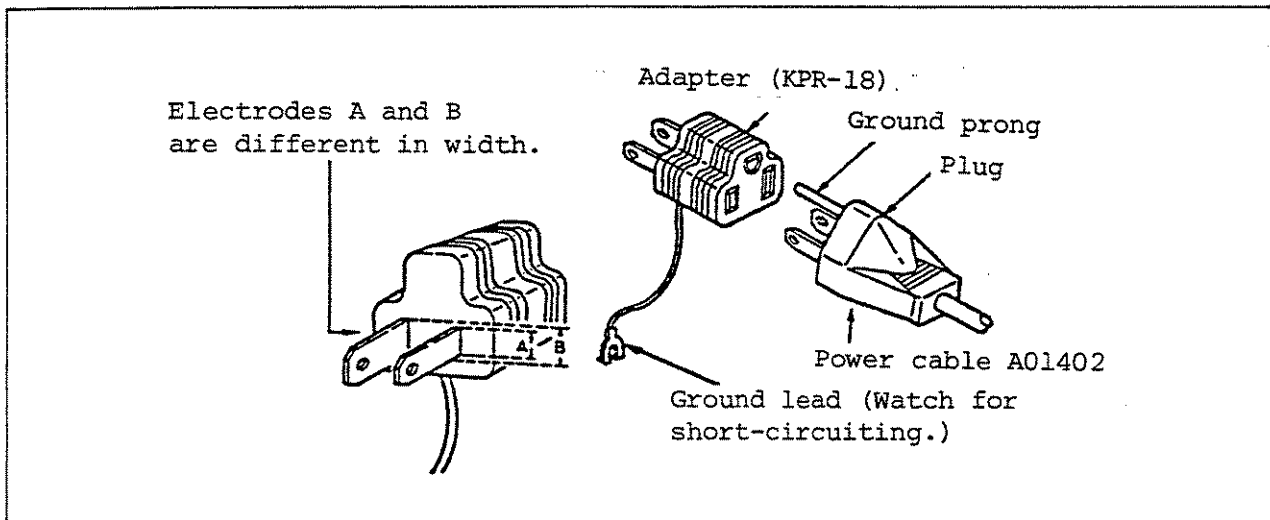

Figure 1 - 1 Power Cable Plug and Adapter

R6551
DIGITAL MULTIMETER
INSTRUCTION MANUAL

1.5 Input Cable Structure

1.5 Input Cable Structure

Use the attached A01001 as the input cable for this equipment. Connect the red clip to the INPUT terminal HI and the black one to the LO.

NOTE

Do not cut the red line carelessly because it is a shielding wire.

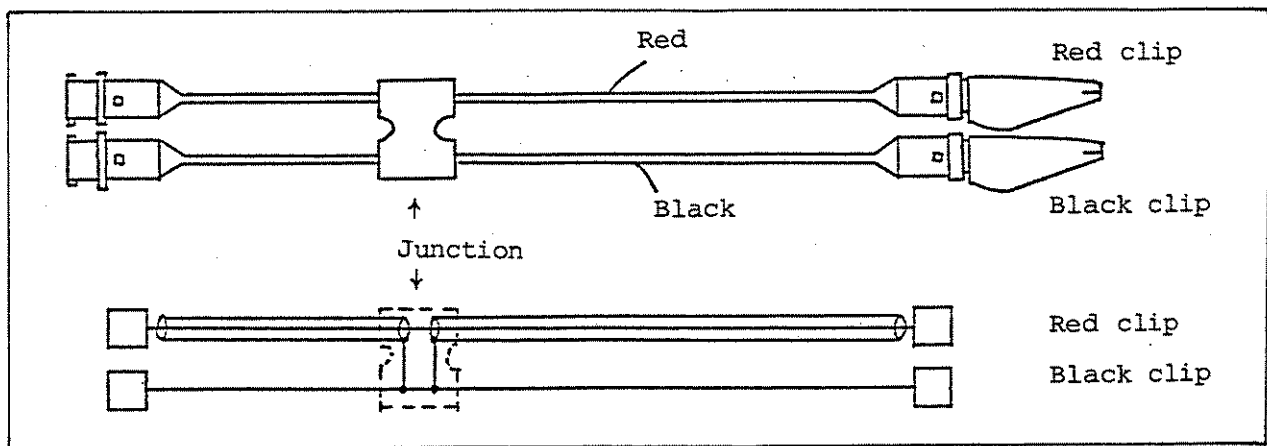

Figure 1 - 2 Input Cable Structure

R6551
DIGITAL MULTIMETER
INSTRUCTION MANUAL

1.6 Fuses

1.6 Fuses

This equipment has a power fuse and a protective fuse near the current measurement input terminal, which protects internal circuits. Before replacing the power fuse, turn the POWER switch off and remove the power cable. When replacing it, be sure to use only the fuse having the same specification as the replaced one according to Table 1-2.

NOTE

When replacing a fuse, be sure to use the same type with the same rating to prevent fire.

Table 1 - 2 Specifications of Fuses

Fuse	Type	Power fuses	Remarks
Power fuses	Slow-blow fuse 0.16A (EAWK0.16A)	DFT-AAR16A	For VAC 100/120
	Slow-blow fuse 0.063A (EAWK0.063A)	DFT-AAR063A	For VAC 220/240
Protective fuse	Normal pre-arcing fuse 3.15A (TMF51NR3.15A)	DFN-AA3R15A	

Note: When checking each fuse, inspect it visually and measure the resistance. The resistance of a non-defective fuse must not exceed 15Ω.

R6551
DIGITAL MULTIMETER
INSTRUCTION MANUAL

2.1 Front Panel

2. IDENTIFICATION OF EACH PART

2.1 Front Panel

(1) Display Block

① Sampling Indicator

Indicates that this equipment is executing measurement through AD conversion.

② REMOTE Indicator

Indicates that this equipment is operating under remote control.

③ MA (My Address) Indicator

Indicates reception of MLA (My listen Address) or MTA (My Talk Address).

④ Digital Display

Displays measured values in up to 5 1/2 or 4 1/2 digits, up to ± 319999 . The polarity is displayed only when the measured value is negative.

⑤ Unit Display

Indicates the unit specified by the indicator "●".

(2) Key Switches

⑥ POWER Switch

Turning this switch on by pressing it in causes all circuits to be powered. Turning the switch off by pressing it again causes the power to be cut off.

⑦ Measuring Function Selector Keys

The LED in the key pressed to select the corresponding function lights. The measuring range which has been set is held.

V DC

 : Selects the DC voltage measuring function.

V AC

 : Selects the AC voltage measuring function (to obtain true rms values).

2W Ω

 : Selects the two-wire resistance measuring function.

R6551
DIGITAL MULTIMETER
INSTRUCTION MANUAL



2.1 Front Panel

$4W \Omega$
 : Selects the four-wire resistance measuring function.



A DC
 : Selects the DC current measuring function.

A AC
 : Selects AC current measuring function (to obtain true rms values).



⑧ AUTO/A ZERO Key

- Selects either AUTO or manual ranges. (LED lit: AUTO)
- Allows Auto Zero on or off to be set in the shift mode.
- To turn Auto Zero on or off, press  or  in the shift mode and then press  again.
- Moves changeable digits in calibration and GPIB setting.



⑨ Range DOWN/4DGT Key

- If this key is pressed when the auto range has been selected, the key shifts the range down by one range into the manual range.
 - If this key is pressed when the manual range has been selected, the key shifts the range down by one range.
 - If this key is pressed in the shift mode, it causes display in up to 4 1/2 digits.
 - Changes 50 or 60Hz, GPIB header setting, or address pointed by blinking when  or  has been pressed in the shift mode.
 - Pressing this key in the shift mode causes "AO on" (Auto Zero ON) to change to "AO off" (Auto Zero OFF).
 - Changes the numeric value in calibration.
- * When  is pressed lastly in the shift mode, the contents of changed settings are established.



⑩ Range UP/5DGT Key

- If this key is pressed when the auto range has been selected, the key shifts the range up by one range into the manual range.
- If this key is pressed when the manual range has been selected, the key shifts the range up by one range.
- If this key is pressed in the shift mode, it causes display in up to 5 1/2 digits.
- Changes 50 or 60Hz, GPIB header setting, or address pointed by blinking when  or  has been pressed in the shift mode.
LINE F GP-IB
- Changes the numeric value indicated by blinking in calibration.
- * When  is pressed lastly in the shift mode, the contents of changed settings are established.

⑪ HOLD/CLEAR Key

- Sets and cancels the sampling hold state. (LED lit: Hold state)
- Sets the mode to clear the contents of set conditions to initial values when  is pressed in the shift mode.
SHIFT CLEAR
- * When  is pressed lastly in the shift mode, the contents of changed settings are established.

⑫ TRIG/GP-IB Key

- Instructs this equipment to start measurement in the HOLD state.
- Sets the mode to turn the GPIB header on or off and set the address when  is pressed in the shift mode. (To change header on/off and address settings, use the UP or DOWN key.)
SHIFT
- * When  is pressed lastly in the shift mode, the contents of changed settings are established.

⑬ RATE/LINE Key

- Sets the sampling rate. The sampling rate changes as follows in turn every time this key is pressed:



At the sampling rate of FAST, the maximum number of displayed digits is 4 1/2.

Example:DCV function

Set rate	Sampling rate (Auto Zero ON)
FAST	50 times/s (4 1/2 digits)
MID	10 times/s (5 1/2 or 4 1/2 digits)
SLOW	3 times/s (5 1/2 or 4 1/2 digits)

- Set the mode to select a line frequency of 50Hz or 60Hz when pressed in the shift mode. (See (1) in Section 4.1 for the setting method.) (When the sampling rate is set to MID, be sure to set the frequency to the line frequency in use for efficient integration.)

⑭ SRQ Key

Issues the SRQ signal onto the GPIB even under remote control when

^{SRQ}
 is pressed.

⑮ SHIFT/LOCAL Key

In the SHIFT mode

- Sets the SHIFT mode, displaying

- When CLEAR is pressed, the mode to set CLEAR (initial values of set conditions) is established.

R6551
DIGITAL MULTIMETER
INSTRUCTION MANUAL

2.1 Front Panel

- When  is pressed, the mode to set the GPIB code format header ON/OFF, Addressable-Only, and Address is established.

Code format: 105 digits





 indicates command group 0.

 indicates command group 1.

 indicates command group 2.

- When  is pressed, the mode to set a line frequency is established.

When  is pressed again, this equipment returns to the mode for measurement in the set conditions.

- The key  turns Auto Zero on or off. To change the setting of Auto Zero on or off, press  or .
- Keys  and  cause display in up to 4 1/2 and 5 1/2 digits to be set respectively.

NOTE

1. The following six switches are workable in the shift mode:

2. The measuring function and unit displayed in the shift mode are the same as those that have been set.

- In the REMOTE control mode:

- Interrupts remote control to allow entering from the panel when  is pressed.

When this equipment regains local control in the mode which is not displayed by the DSO command, the display ON mode is established.

R6551
DIGITAL MULTIMETER
INSTRUCTION MANUAL

2.1 Front Panel

⑩ NULL Key

Resets the currently displayed value to 0 for relative display.

Pressing this key again cancels the ^{NULL}  setting.

NOTE

When using ^{NULL} , press it for one second or more. The moment after this key is pressed, the preceding status appears in the display. When it is pressed for one second or more, however, the status changes

to **nl on** or **nl off**, which is displayed for about a second to indicate that the NULL key entry has been recognized.

To prevent malfunction, this key does not work if it is only hit momentarily.

⑪ SCALE Key

Corrects zero to full-scale values to 0 to 100% values.

Calculates and outputs the ratio of each measured value (M_{IN}) to the value (M_{SCALE}) measured in SCALE setting as 100%.

Allows SCALE operation to be executed based on NULL operation.

Pressing ^{SCALE}  again cancels the SCALE setting.

When ^{SCALE}  is pressed, **SC** appears in the display. If it is pressed for one second or more, the LED in the key goes on or off while

SC on or **SC off** appears, indicating scale setting or canceling the setting, respectively.

(3) Input Terminal Block

⑫ INPUT Terminal 

Input terminal for measuring DC and AC voltages and two/four-wire resistance measurement

Connect the HI (red clip) side, of the input cable to this terminal.

⑲ INPUT Terminal LO

Input terminal for all measuring functions. Connect the LO (black clip) side of the input cable to this terminal.

⑳ 4W Ω HI (Ω SENSE HI) Terminal

Input HI terminal for four-wire resistance measurement.

When using the cable for four-wire resistance measurement (A01006), connect its HI (red clip) side to this terminal.

㉑ 4W Ω LO (Ω SENSE LO) Terminal

Input LO terminal for four-wire resistance measurement.

When using the cable for four-wire resistance measurement (A01006), connect its LO side (blue clip) to this terminal.

㉒ A HI (INPUT HI) Terminal

Input terminal for DC and AC current measurement.

Connect the HI side having a red clip of the input cable to this terminal. (Connect the LO (black clip) side to the input LO terminal 19 .)

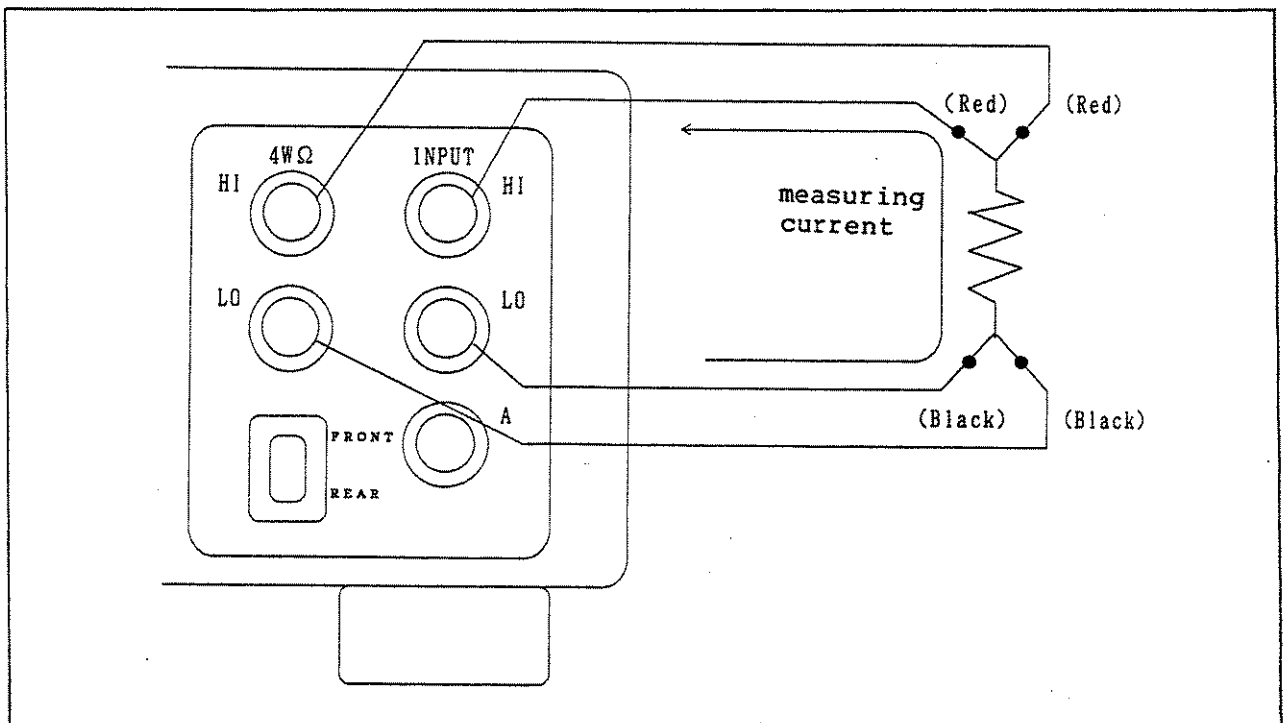

Figure 2 - 1 Input cable connection for measuring four-wire resistance

②③ FRONT/REAR Selector Switch

Pushbutton switch to select input terminals on the front or rear panel.

- When the switch is depressed as "⏏", input terminals on the rear side are selected. At this time, DC and AC voltage measurement and two-and four-wire resistance measurement are possible from the rear side.
- When the switch is projecting as "⏏", input terminals on the front side are selected.

NOTE

1. FRONT/REAR selection cannot be remote-controlled.
2. Never operate the FRONT/REAR selector switch with any input terminal applied with high voltage.

2.2 Rear Panel

②④ INPUT Terminal HI

Input terminal for DC and AC voltage measurement and two- and four-wire resistance measurement.

Connect the HI (red clip) side of the input cable to this terminal.

②⑤ INPUT Terminal LO

Input LO terminal for DC and AC voltage measurement and two- and four-wire resistance measurement.

Connect the LO (black clip) side of the input cable to this terminal.

②⑥ 4WΩ HI (Ω SENSE HI) Terminal

Input HI terminal for four-wire resistance measurement.

When using the cable for four-wire resistance measurement (A01006), connect its HI (red clip) side to this terminal.

②⑦ 4WΩ LO (Ω SENSE LO) Terminal

Input LO terminal for four-wire resistance measurement.

When using the cable for four-wire resistance measurement (A01006), connect its LO side (blue clip) to this terminal.

②⑧ TRIGGER Connector

This connector is used to give a measurement start instruction in the HOLD state.

External start signal (TTL level negative pulse)

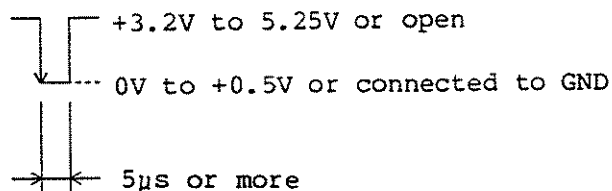

②⑨ COMPLETE Connector

This connector is used to output the strobe signal to terminate output of measurement data or processing data.

Complete signal (TTL level negative pulse)

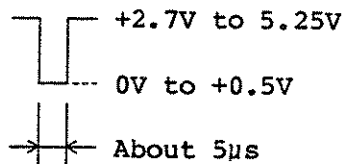

③⑩ GPIB Connector

This 24-pin piggyback connector is used for the bus cable complying with the IEEE-488 standard.

* The GPIB allows this equipment to be incorporated into an automatic instrumentation system which can set the measuring functions and parameters of this equipment and read measurement data via the GPIB.

③⑪ Power Connector

AC power supply connector.

Connect the attached power cable (A01402) to this connector.

③⑫ Fuse Holder

Houses a 0.16A (for 100/120VAC) or 0.063A (for 220/240VAC) slow-blow fuse and a spare fuse. (See Section 1.6 for details about fuses.)

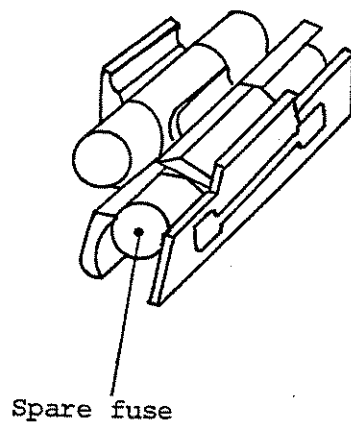

③ CAL Switch

When this calibration switch is pressed, this equipment enters the calibration mode and the display starts flashing.

When it is pressed again, this equipment returns to the normal measurement mode from the calibration mode.

2.2 Rear Panel

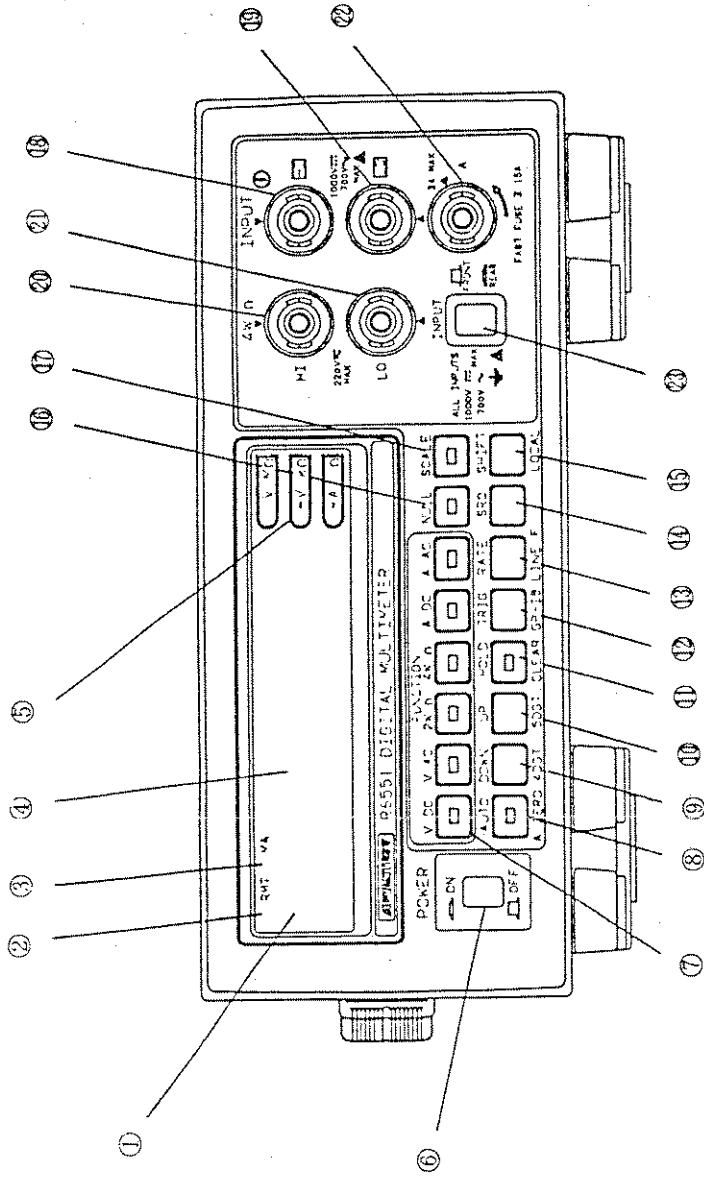

Figure 2 - 2 Front Panel

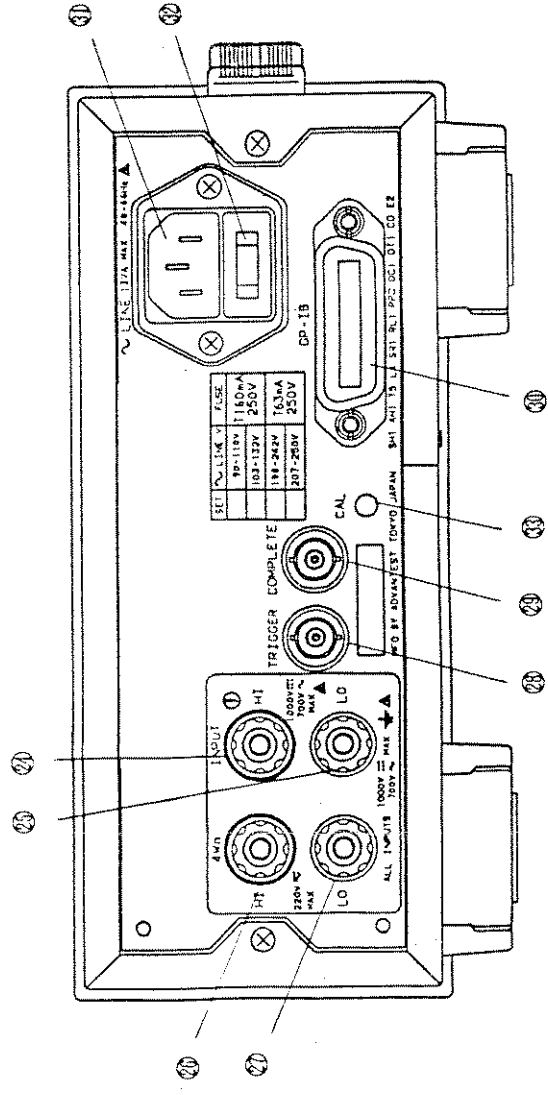

Figure 2 - 3 Rear Panel



3. SAMPLE KEY OPERATIONS

3. SAMPLE KEY OPERATIONS

This section provides four examples of setting on the panel for the user who uses this equipment for the first time to help him/her learn how to use this equipment quickly. Try to operate keys and switches according to each operating procedure.

Example 3-1: Set the number of digits to be displayed to 4 1/2.

Operating procedure:

- ①  : Causes a series of "_" to appear on the digital display.
- ②  : Selects display of values in 4 1/2 digits and returns to the previous measurement mode.

Display

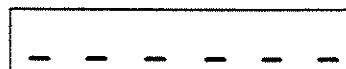

--- To cancel the setting halfway the procedure ---

After ① : Press  again.

NOTE

Sampling rates and digit ranges to be set:

	4 1/2 digits	5 1/2 digits
FAST*	o	x
MID	o	o
SLOW	o	o

* Even though display in 5 1/2 digits is specified at the FAST rate, display in 4 1/2 digits is set. When the sampling rate is changed to either MID or SLOW from this state, display in 5 1/2 digits is set.

When the rate is changed to either MID or SLOW after display in 4 1/2 digits is set at the FAST rate, the setting of display in 4 1/2 digits remains the same.

R6551
DIGITAL MULTIMETER
INSTRUCTION MANUAL

3. SAMPLE KEY OPERATIONS

Example 3-2: Set the contents of settings to their initial values.

Operating procedure:

Display

① Press $\overset{\text{SHIFT}}{\square}$.
Causes a series of "_" to appear on the digital display.

② Press $\overset{\text{CLEAR}}{\square}$.
Causes "Clear" to appear on the digital display.

③ Press $\overset{\text{SHIFT}}{\square}$.
Initializes the contents of settings.

- Function : VDC
- Range : AUTO
- Rate : SLOW
- Null : OFF
- Number of displayed digits: 5 1/2 digits
- Sampling : Free run
- Auto Zero : ON
- Delimiter mode : DL0
- SRQ mode : S1
- Talker format : Header ON

--- To cancel the setting halfway through the procedure ---

After ①: Press $\overset{\text{SHIFT}}{\square}$ again.

After ②: Press $\overset{\text{SHIFT}}{\square}$ again after pressing $\square_{\text{GP-IB}}$, $\square_{\text{LINE F}}$, or $\square_{\text{A ZERO}}$.

NOTE

The above procedure does not initialize the GPIB address, command group, and the set line frequency.

3. SAMPLE KEY OPERATIONS

Example 3-3: Set the GP-IB header to ON and the address to 21.

Operating procedure:

- ① Press ^{SHIFT} .
Causes a series of "-" to appear on the digital display.
- ② Press _{GP-IB} .
Displays the currently set parameters.
Set parameters:
- Mode operating with command group 0
- Header: OFF
- Addressable
- Address: 05
- ③ Press ^{UP} ^{UP} .
Changes the digit at the flashing point to 2.
- ④ Press ^{AUTO} .
Shifts the flashing position to the right.
- ⑤ Press ^{DOWN} ^{DOWN} ^{DOWN} ^{DOWN} .
Changes the digit at the flashing point
4→3→2→1.
- ⑥ Press ^{AUTO} ^{AUTO} .
Shifts the flashing position to the digit of 10⁴.
- ⑦ Press ^{UP} or ^{DOWN} .
Changes " " to "H" (header ON).
- ⑧ Press ^{SHIFT} .
Turns the header on, sets the address to 21, and returns to the preceding measurement mode.

Display

— — — — —

0 _ A 05

↑
Flashing

0 _ A 25

↑
Flashing

0 _ A 25

↑
Flashing

0 _ A 21

↑
Flashing

0 _ A 21

↑
Flashing

0 H A 21

↑
Flashing

* To specify the only mode, change **A** at the digit of 10³ to **0** .
(**0** : Only mode)

R6551
DIGITAL MULTIMETER
INSTRUCTION MANUAL

3. SAMPLE KEY OPERATIONS

--- To cancel the setting halfway through the procedure ---

After ①: Press \square ^{SHIFT} again.

Between ② and ⑦: Press \square _{LINE F} after \square .

Example 3-4: Set a line frequency.

Operating procedure:

Display

① Press \square ^{SHIFT}.
Causes a series of "-" to appear on the digital display.

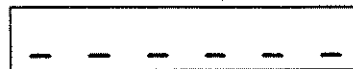

② Press \square _{LINE F}.
Causes the current setting of a line frequency to appear on the digital display.



Flashing

③ Press \square ^{DOWN} or \square .
Changes the flashing points to \square .



Flashing

④ Press \square ^{SHIFT}.
Sets the entered line frequency.

--- To cancel the setting halfway through the procedure ---

After ① or ②: Press \square ^{SHIFT} again.

After ③: Return the set value and press \square ^{SHIFT}, or press \square and press \square ^{SHIFT} again.

R6551
DIGITAL MULTIMETER
INSTRUCTION MANUAL

4.1 Setting Up Equipment

4. STARTING OPERATION

4.1 Setting Up Equipment

(1) Setting a Line Frequency

Be sure to set the line frequency of this equipment to the line frequency to be used as follows:

Operating procedure:

- ① Connect the power cable to this equipment and turn the POWER switch on.
- ② Press \square and then \square . The display block displays the current setting as shown in Figure 4-1. This example indicates that the line frequency is set to 50Hz.
- ③ When \square or \square is pressed, the display changes from LF50 to LF60 and the line frequency is set to 60Hz from 50Hz.
- ④ When \square is pressed again, this equipment enters the measurement mode.

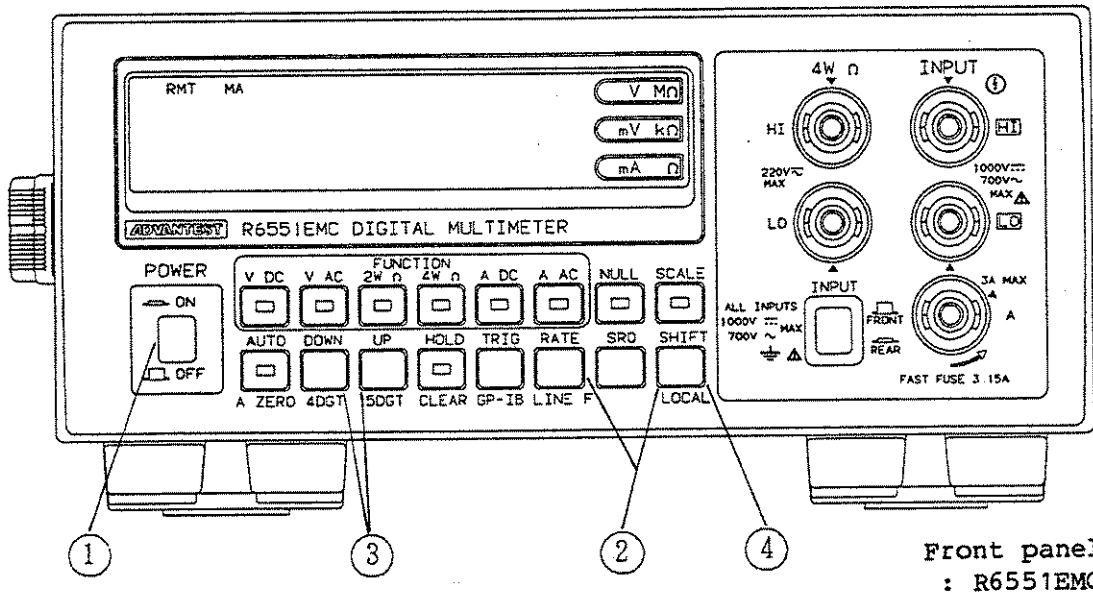

Figure 4 - 1 Line Frequency Setting

R6551
DIGITAL MULTIMETER
INSTRUCTION MANUAL

4.1 Setting Up Equipment

(2) Turning the Power on and Initialization

When the POWER switch is turned on, the display presents



for about 0.4 second. Then the following

messages appear in succession:

Message No. 1 (example) (for about one second):

Indicates the type number of this equipment.



Message No. 2 (for about one second):

Indicates that the line frequency in use is 50Hz or 60Hz. The line frequency of this equipment must be set to this value.



or

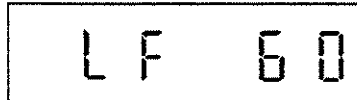

Message No. 3 (example) (for about one second):

Indicates the address, command group, and header setting of the GPIB of this equipment.





Message No. 4 (for about one second):

Indicates the program revision number of internal software of this equipment. This example shows revision 1.00.



Initialization of parameters

Set parameters of this equipment are retained by the built-in battery even though the power is turned off. When the keys , , and  are operated continuously, this equipment initializes all the settings except the GPIB address, command group, and line frequency.

(3) Messages

This equipment displays the following messages in response to, for example, erroneous entering during operation.

① Over Range Message

The full scale covered by this equipment is 319999, excluding 100V range for DC voltage measurement, 700V range for AC voltage measurement, and 3A range for AC/DC current measurement. If input exceeding the full scale is applied to this equipment in the manual range setting, the following display appears to indicate excessive input:

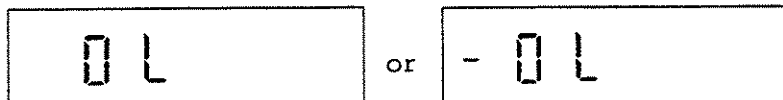

Indicates overload (>319999) or Indicates overload (<-319999)

If the above message appears, raise the measurement range. This message may appear when the input terminal is released in range change or resistance measurement.

② Error Messages

Error code	Explanation
Err 1	- Error in the Ext Cal mode - Calibration data falling out of the specified range - This message is displayed for about one second.
Err 3	- Error set via GPIB - This message is displayed for about one second.
Err 6	- Hardware fault
Err 30	- Error in ROM (checksum error)
Err 40	- RAM read/write error
Err CA	- Calibration data error in backup RAM (checksum error)

* If Err6, Err30, Err40, or ErrCA occurs, contact your local ADVANTEST office or agent.

4.2 NULL Operation

NULL operation is the digital offset function to subtract a predetermined value from a measured value. This operation is executed for relative voltage or current measurement from a certain value or correction of the resistance of a lead wire in resistance measurement.

For a null constant, the first measured value after ^{NULL}  is pressed is set as an offset constant. When the value is 0.02mV, for example, 0000.00mV appears on the display. The subsequent measured values are displayed after being subtracted by 0.02mV each.

The overload message in NULL operation is displayed not only in the result of measurement but also when the operation results in overrange. Note that while the auto range is used, the optimum range is selected depending on the result of measurement (data before NULL operation).

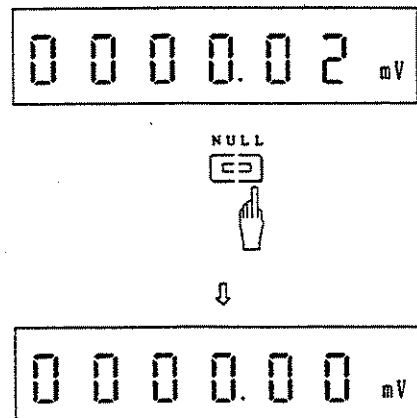

When using ^{NULL} , be sure to press the key for one second or more. To prevent malfunction, this key does not work when pressed only momentarily.

When NULL key operation ends, the equipment displays n L 0 n (or n L 0 F F) and turns the NULL lamp on (or off).

4.3 SCALE Operation

SCALE operation is the function to obtain the percentage between certain set values (M_{SCALE}) and (M_{IN}).

For the scale set value, the first measured value after $\overset{SCALE}{\boxed{\text{E3}}}$ is pressed is set as the 100% value.

When the value measured after scaling is 2700.00 Ω , for example, 100.000 is displayed. Subsequently, the measured value to 2700.00 Ω is displayed in percentage.

$$R = M_{IN} / M_{SCALE} \times 100\%$$

R : Displayed value

M_{IN} : Measure value

M_{SCALE} : Scale set value



SCALE



When using $\overset{SCALE}{\boxed{\text{E3}}}$, be sure to press the key for one second or more. To prevent malfunction, this key does not work when pressed only momentarily.

The LED of the unit of a set value under scaling lights.

4.4 Selection of Measuring Functions

(1) Selecting an Ordinary Measuring Function

The following keys select their respective measuring functions:

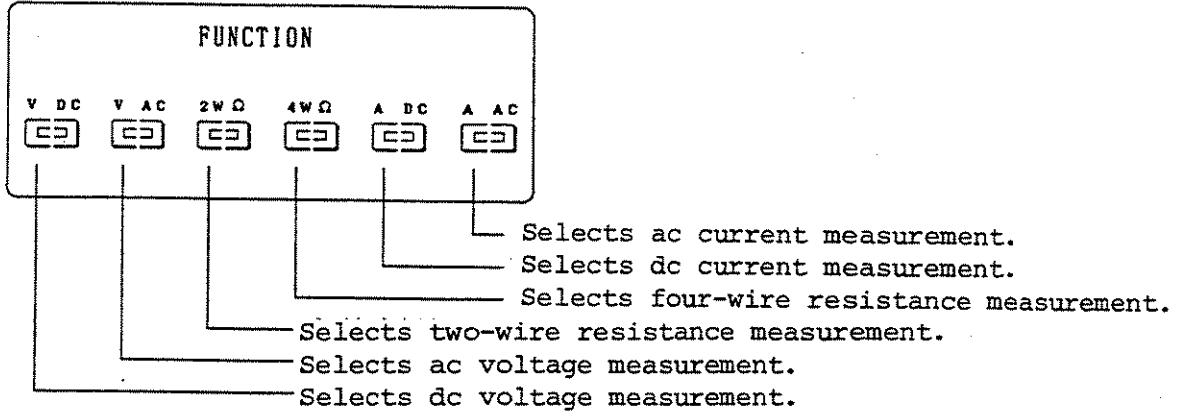

(2) Inhibiting Unnecessary Measuring Functions

While a measuring function is selected by entering the corresponding key, this inhibition disables the other keys to be entered even though they are pressed. The following procedure selects the required measuring function using this inhibition:

- ① Press the power switch with ^{SHIFT} depressed, then this equipment displays SELECTION to enter the measuring function selection mode. S E L
- ② The function specified by the key whose LED is lit is available. Press one of the measuring function selection keys to select the function that you want to execute, then the LED in the pressed key goes on. When the key is pressed again, the LED goes out.
- ③ When ^{SHIFT} is pressed again, this equipment enters the normal operation mode, allowing only the function selected in ② to be changed.

NOTE

If six LEDs indicating measuring functions are all turned off in ②, this equipment will not enter the normal operation mode even though

^{SHIFT} is pressed.

R6551
DIGITAL MULTIMETER
INSTRUCTION MANUAL

4.4 Selection of Measuring Functions

- ④ To cancel the inhibition to enable every measuring function to be selected, turn all the LEDs on or execute initialization (by pressing

SHIFT , , and).
CLEAR

Note that the initialization of parameters causes all the setting except the GPIB address, command group, and the line frequency to be initialized.

5. GPIB INTERFACE

5.1 Introduction

The general-purpose interface bus (GPIB) is the interface connection this equipment to the measuring bus complying with the IEEE-488 standard.

This equipment is provided with the GPIB interface as a standard attachment. It allows this equipment to make up a GPIB integrated instrumentation system together with a personal computer.

The system will perform measurement automatically and process data easily. Since the GPIB allows remote programs to control most setting items of the panel switches of this equipment, it can meet wide ranges of applications.

R6551
DIGITAL MULTIMETER
INSTRUCTION MANUAL

5.2 Specifications

5.2 Specifications

Governing specification : IEEE standard 488-1978
 Available code : ASCII code
 Connector pin assignment:

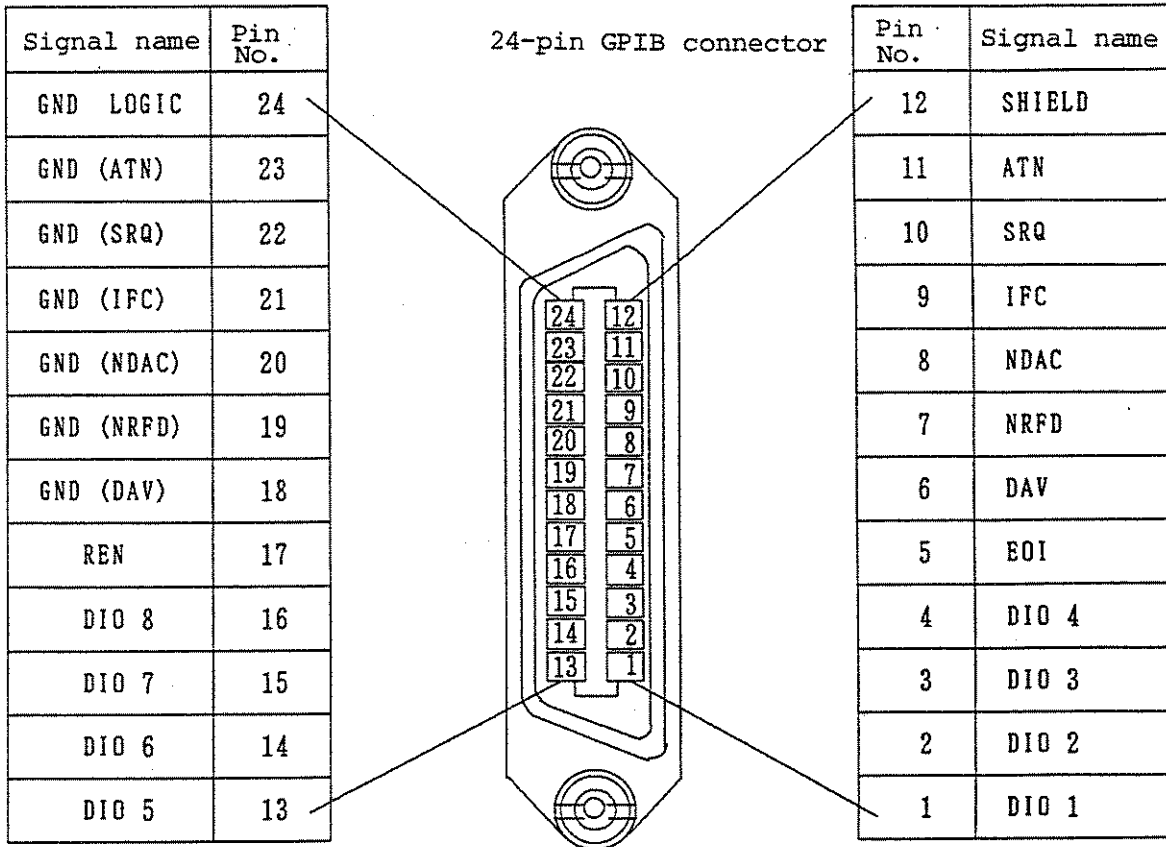
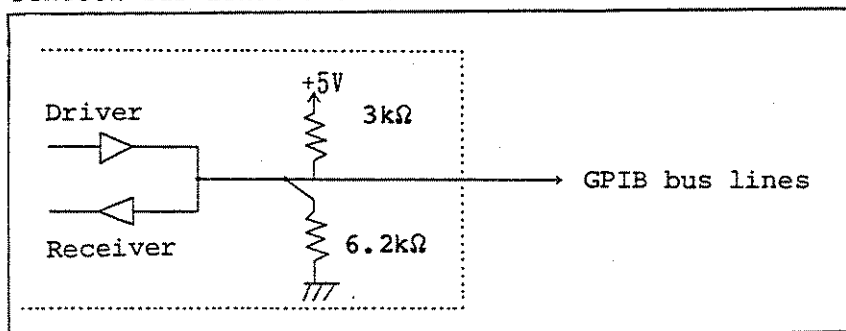

Figure 5 - 1 GPIB Connector Pin Assignment

Logical level: Logic 0 (high state); +2.4V or more
 Logic 1 (low level); +0.4V or less

Termination of signal conductors:

Sixteen bus lines are terminated as follows:



R6551
DIGITAL MULTIMETER
INSTRUCTION MANUAL

5.2 Specifications

Driver : Tristate system
 Low-state output voltage ; +0.4V or less, 48mA
 High-state output voltage; +2.4V or more, -5.2mA

Receiver : Low state at +0.6V or less
 High state at +2.0V or more

Bus cable length:
 The length of each bus cable must not exceed: (the number of devices connected to the bus) x 2m. The total length of all bus cables must be less than 20m.

Addressing : GPIB address assignment on the front panel allows 31 different talker and listener addresses to be selected.

Interface function:
 See Table 5-1.

Table 5 - 1 Interface Functions

Code	Description
SH1	Source handshake function
AH1	Acceptor handshake function
T5	Basic talker function, Talk-only mode, Serial poll function, Listener-specified talker cancel function
L4	Basic listener function, Talker-specified listener cancel function
SR1	Service request function
RL1	Remote/local control select function
PP0	No parallel poll function
DC1	Device clear function (SDC and DCL commands are available.)
DT1	Device trigger function (GET command is available.)
C0	No controller function
E2	Tristate output

5.3 Interconnecting GPIB System Components

5.3 Interconnecting GPIB System Components

The GPIB system consists of two or more components. Connect the components, paying attention to the following points:

- (1) Check the states (preparatory settings) and operations of the system components according to the operation manuals of this equipment, controller, and peripheral devices.
- (2) Minimize the length of the cable connecting the device and the bus cables connecting the controller and other components. The total cable length must not exceed 20m. ADVANTEST is ready to supply the following bus cables:

Table 5 - 2 Standard Bus Cables

Length	Name
0.5m	408JE-1P5
1m	408JE-101
2m	408JE-102
4m	408JE-104

- (3) The bus cable connector is a piggyback type, and allow two bus cable connectors to be connected in parallel, on top of each other. Do not use three or more piled connectors together.

Fasten connectors securely with connector screws.

- (4) Check power requirements, grounding conditions, and, if required, setting conditions of the system components. Then, turn on these components. All the components connected to the bus must be powered; otherwise, the entire system operation is not guaranteed.

R6551
DIGITAL MULTIMETER
INSTRUCTION MANUAL

5.4 Address Setting and Header ON/OFF Selection

5.4 Address Setting and Header ON/OFF Selection

Keys on the front panel allow GPIB talker and listener addresses to be set and the header ON or OFF to be selected. Any of 31 different addresses in Table 5-3 can be set using the corresponding decimal code from the panel. The header ON/OFF can be selected via the external controller.

Table 5 - 3 Address Codes

Address		
Lowest two digits (Decimal code)	ASCII code	
	Listen- er	Talker
0	SP	@
1	!	A
2	"	B
3	#	C
4	\$	D
5	%	E
6	&	F
7	'	G
8	(H
9)	I
10	*	J
11	+	K
12	,	L
13	-	M
14	.	N
15	/	O
16	0	P
17	1	Q
18	2	R
19	3	S
20	4	T
21	5	U
22	6	V
23	7	W
24	8	X
25	9	Y
26	:	Z
27	;	[
28	<	\
29	=]
30	>	~

R6551
DIGITAL MULTIMETER
INSTRUCTION MANUAL

5.4 Address Setting and Header ON/OFF Selection

- ① Press ^{SHIFT} and _{GP-IB}. Then the initial setting appears as below, and the address setting digits of 10¹ flash.



These digits specify the address.

This digit sets or resets the talk-only mode.

A: Addressable
o: Talk-only mode

This digit turns the header on or off.

H: Header on
_: Header off (Underbar)

This digit specifies a command group.

0: Command group 0 (Original commands of ADVANTEST)
1: Command group 1 (Commands referenced to 8840A
by John Fluke)
2: Command group 2 (Commands referenced to 3478A
by HP)

(See figure 5-7.)

- ② Pressing ^{AUTO} changes the flashing digit.

When _{DOWN} or _{UP} are pressed, the setting of the current digit changes. To set the address, use the lowest two digits.

- Setting the address to 31 or more results in an error.
- The talk-only mode allows data to be output directly to listeners such as the printer without the controller. In this case, set the listener into the only mode and suppress the controller from operating concurrently.

5.5 Talker Specification

5.5.1 Data Format

○○○±○○○○○○○○ E±OCR LF
└─H─┘ └───D──┘ └─E─┘ └─L─┘

- H: Header (three-character ASCII code)
- D: Mantissa part (polarity + decimal point + 4 to 6 digit number)
- E: Exponent part (E + polarity + 1 digit number)
- L: Delimiter

(1) Header Types

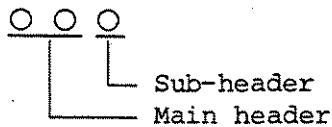

NOTE

When the header is off, it is not displayed.

① Main Header

- DV: DC voltage measurement
- AV: AC voltage measurement
- DI: DC current measurement
- AI: AC current measurement
- R_—: Two-wire/four-wire resistance measurement

② Sub-header

- O: Overscale data
- N: Null operation
- S: Scaling operation
- : Data other than above

R6551
DIGITAL MULTIMETER
INSTRUCTION MANUAL

5.5 Talker Specification

(2) Mantissa and Exponent Parts

The mantissa part of measured data has a variable length of eight, seven, or six bytes selectively when the data is displayed in 5 1/2, 4 1/2, or 3 1/2 digits including the polarity and decimal point. The mantissa part is displayed with the decimal point placed at the same position in the same number of digits as displayed on this equipment. For the data polarity, is output when the NULL function is off in AC voltage or current measurement, otherwise, either + or - is output.

The exponent part of measured data consists of three bytes, which is determined by the current measuring function and range so that all items of measured data are represented in basic unit (V, A, or Ω).

Table 5-4 shows data in mantissa and exponent parts in each measurement conditions in 1/2 digit display.

R6551
DIGITAL MULTIMETER
INSTRUCTION MANUAL

5.5 Talker Specification

Table 5 - 4 Data in Mantissa and Exponent Parts (in 5 1/2-digit Display)

Function	Range	Mantissa part	Exponent part
DC voltage	300mV	±ddd.ddd	E - 3
	3000mV	±dddd.dd	E - 3
	30 V	±dd.dddd	E + 0
	300 V	±ddd.ddd	E + 0
	1000 V	±dddd.dd	E + 0
AC voltage	300mV	ddd.ddd	E - 3
	3000mV	dddd.dd	E - 3
	30 V	dd.dddd	E + 0
	300 V	ddd.ddd	E + 0
	700 V	dddd.dd	E + 0
DC current	300mA	±ddd.ddd	E - 3
	3000mA	±dddd.dd	E - 3
AC current	300mA	ddd.ddd	E - 3
	3000mA	dddd.dd	E - 3
Two-wire/four-wire resistance	300 Ω	±ddd.ddd	E + 0
	3000 Ω	±dddd.dd	E + 0
	30kΩ	±dd.dddd	E + 3
	300kΩ	±ddd.ddd	E + 3
	3000kΩ	±dddd.dd	E + 3
	30MΩ	±dd.dddd	E + 6
	300MΩ	±ddd.dd	E + 6
Overscale or computation error		±9999.99	E + 9

d: Digit between 0 to 9

Note: Data in the mantissa part is data during measurement in 5 1/2 digits. The lowest one digit is not output during measurement in 4 1/2 digits. The lowest two digits are not output during measurement in 3 1/2 digits.

(3) Delimiter

A delimiter is output to indicate the end of a single data item.

Any one of the following three different delimiters can be selected using program codes. The delimiter in ① is set by initialization.

- ① Two-byte data of CR (15g) and LF (12g). When LF is output, a single line message EOI is also output.
- ② One-byte data of LF
- ③ EOI which is output together with the last byte of data

5.5.2 Output Format

The output format is given below:

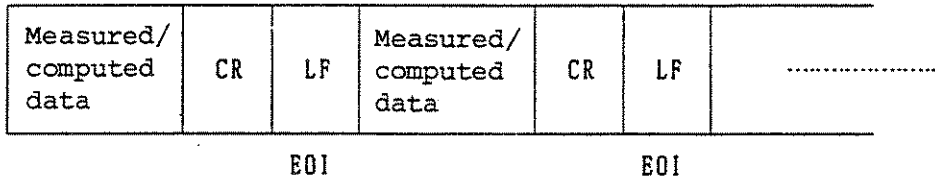

5.5.3 Binary Output Format

The GPIB command H2 enables binary output.

Binary data format (in three bytes):

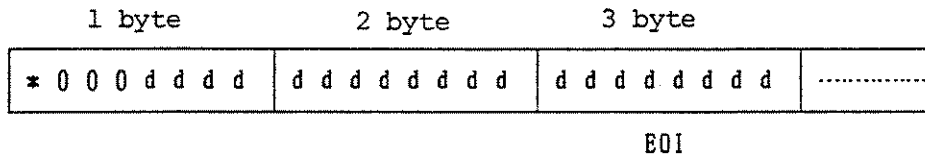

*: Sign (0: +, 1: -)
0 = 0
d: Data (0 or 1)

NOTE

In H2 setting with display off, the delimiter is only EOI, and BCD parallel output is not executed.

R6551
DIGITAL MULTIMETER
INSTRUCTION MANUAL

5.6 Listener Specification

5.6 Listener Specification

This equipment allows the external controller to set the measuring conditions. Table 5-5 lists program codes (in command group 0).

To detect a delimiter, use "LF" (12s) or "EOI".

Table 5 - 5 Program Codes (1 of 3)

Item	Code	Function					Initial value
Measuring function	F1	DC voltage measurement					o
	F2	AC voltage measurement					
	F3	Two-wire resistance measurement					
	F4	Four-wire resistance measurement					
	F5	DC current measurement					
	F6	AC current measurement					
Measuring range		DC voltage	AC voltage	Resistance	DC current	AC current	
	R0	AUTO	AUTO	AUTO	AUTO	AUTO	o
	R3	300mV	300mV	300Ω			
	R4	3000mV	3000mV	3000Ω			
	R5	30V	30V	30kΩ			
	R6	300V	300V	300kΩ	300mA	300mA	
	R7	1000V	700V	3000kΩ	3000mA	3000mA	
	R8			30MΩ			
	R9			300MΩ			
	RX	Changes measuring range from auto range to manual range.					
Sampling mode	M0	Free run					o
	M1	Hold					
Trigger	E	Measurement start instruction (having the function equivalent to the TRIG switch on the panel) Equivalent to the GET command					
Sampling rate	PR1	FAST					
	PR2	MID					
	PR3	SLOW					o

R6551
DIGITAL MULTIMETER
INSTRUCTION MANUAL

5.6 Listener Specification

Table 5 - 5 Program Codes (2 of 3)

Item	Code	Function	Initial value
Number of displayed digits	RE3	Display in 3 1/2 digits	
	RE4	Display in 4 1/2 digits	
	RE5	Display in 5 1/2 digits	o
NULL	NL0	OFF	o
	NL1	ON	
Scaling	SC0	OFF	o
	SC1	ON	
Filter	FL0	Turns the filter on at ACV FAST. (Measuring frequency range: 300Hz to 300kHz)	o
	FL1	Turns the filter off at ACV FAST. (Measuring frequency range: 50Hz to 300kHz)	
Auto zero calibration	AZ0	OFF	
	AZ1	ON	o
	AZ2	Turns off auto-zero calibration after executing it once.	
Header ON/OFF	H0	Turns the header off and selects the ASCII format.	
	H1	Turns the header on and selects the ASCII format.	o
	H2	Turns the header off and selects the binary format.	
Delimiter mode	DL0	Outputs CR/LF as a delimiter and EOI.	o
	DL1	Outputs LF as a delimiter.	
	DL2	Outputs EOI as a delimiter.	
SRQ transmission mode	S0	Enables SRQ to be transmitted.	
	S1	Disables SRQ to be transmitted.	o
Display ON/OFF	DS0	Turns display off (not to display measured data).	
	DS1	Turns display on (to display measured data).	o
Calibration value input	PCdddddd	dddddd: Number of up to six digits including no decimal point or polarity (Available only when the CAL ON key is on)	

R6551
DIGITAL MULTIMETER
INSTRUCTION MANUAL

5.6 Listener Specification

Table 5 - 5 Program Codes (3 of 3)

Item	Code	Function	Initial value
Initiali- zation	C	Initializes all the settings as if the power supply is turned on. Equivalent to DCL and SDC commands	
	Z	Initializes each parameter. (Has the function equivalent to initialization C L E A R from the panel.) Includes the processing of code C.	
Reading of settings	OO?	Specify the code to be read out, which is indicated in OO.	

Notes on setting commands:

- (1) Up to 40 characters (excluding block delimiters) can be set at a time.
- (2) A syntax error occurs if an undefined code is specified.
- (3) Ignore spaces before numeric values.

5.7 Service Request (SRQ)

On reception of a measurement end signal or undefined code, this equipment when set in the SO mode issues a service request (SRQ) to the controller. On reception of the SPE command serial-polled from the controller after issuing the service request, this equipment sends the following status byte. In the S1 mode, it does not send the service request but the status byte.

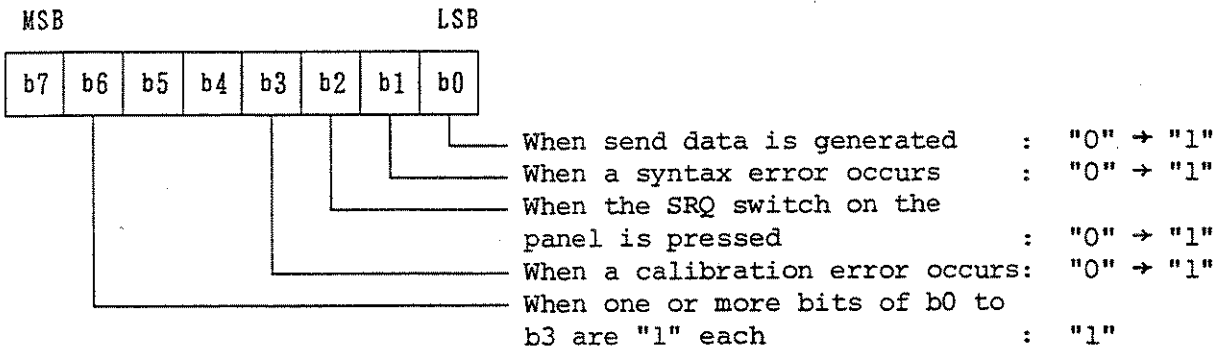

(1) Service Request Mode on Completion of Measurement

If this equipment is not addressed to talk when measurement ends, it issues a service request. When this equipment is serially polled, it sends the status byte shown below. The status byte is held until this equipment is addressed to talk, to transmit measured data.

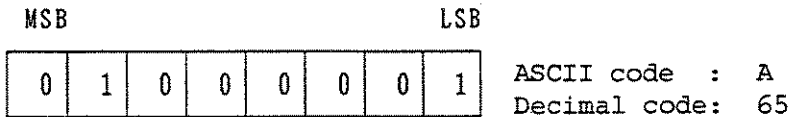

(2) Service Request Resulting from a Syntax Error

When receiving an undefined program code during remote programming, this equipment issues a service request. The status byte shown below is held until this equipment is addressed to listen, to enable remote setting.

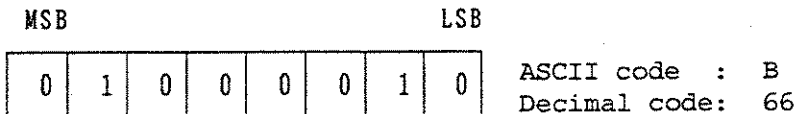

R6551
DIGITAL MULTIMETER
INSTRUCTION MANUAL

5.7 Service Request (SRQ)

- (3) When the SRQ key is pressed on the front panel, this equipment issues a service request. The following status byte is held until this equipment is serially polled.

MSB								LSB	
0	1	0	0	0	1	0	0		

ASCII code : D
Decimal code: 68

- (4) If data under calibration by the command PC dddddd or HF dddddd is outside the specified range, this equipment issues a service request.

MSB								LSB	
0	1	0	0	1	0	0	1		

ASCII code : I
Decimal code: 73

- (5) This equipment changes its state when turned on and receiving each command as follows:

- ① When turned on or receiving commands, this equipment enters the states shown in Table 5-6.
- ② If the ATN request interrupts message transfer between devices, this equipment clears the current state to give priority to the ATN.

R6551
DIGITAL MULTIMETER
INSTRUCTION MANUAL

5.7 Service Request (SRQ)

Table 5 - 6 State Changes Caused by Commands

Command	Talker (MA)	Listener (MA)	SRQ	Status	Transmit data
POWER ON	Cleared	Cleared	Cleared	Cleared	Cleared
IFC	Cleared	Cleared	—	—	—
DCL, SDC, or C	—	—	Cleared	Cleared	Cleared
GET or E	—	—	—	Transmit data indicator bit is cleared.	Cleared
R6551/R6551EMC addressed to talk	Set	Cleared	—	—	—
Talker unaddressing instruction	Cleared	—	—	—	—
R6551/R6551EMC addressed to listen	Cleared	Set	—	—	—
Listener unaddressing instruction	—	Cleared	—	—	—
Serial polling	—	—	Cleared	Bit of SRQ switch calibration error is cleared.	—

Note: A hyphen (-) indicates that the current state is retained.

DCL: Device Clear
SDC: Selected Device Clear
GET: Group Execute Trigger

R6551
DIGITAL MULTIMETER
INSTRUCTION MANUAL

5.8 Command Codes

5.8 Command Codes

Table 5-7 lists command codes. (See ① in Section 5.4.)

Table 5 - 7 Command Codes (1 of 3)

Function	Range	Command group 0		Command group 1		Command group 2	
DC current	AUTO	F1	R0	F1	R0	F1	RA
	300mV	↓	R3	↓	R1	↓	R-1
	3000mV		R4		R2		R0
	30 V		R5		R3		R1
	300 V		R6		R4		R2
	1000 V	↓	R7	↓	R5	↓	R3
AC current	AUTO	F2	R0	F2	R0	F2	RA
	300mV	↓	R3	↓	R1	↓	R-1
	3000mV		R4		R2		R0
	30 V		R5		R3		R1
	300 V		R6		R4		R2
	700 V	↓	R7	↓	R5	↓	R3
Two-wire resistance	AUTO	F3	R0	F3	R0	F3	RA
	300 Ω	↓	R3	↓	R1	↓	R2
	3000 Ω		R4		R2		R3
	30kΩ		R5		R3		R4
	300kΩ		R6		R4		R5
	3000kΩ		R7		R5		R6
	30MΩ		R8		R6		R7
	300MΩ	↓	R9	↓	R7	↓	R8
Four-wire resistance	AUTO	F4	R0	F4	R0	F4	RA
	300 Ω	↓	R3	↓	R1	↓	R2
	3000 Ω		R4		R2		R3
	30kΩ		R5		R3		R4
	300kΩ		R6		R4		R5
	3000kΩ		R7		R5		R6
	30MΩ		R8		R6		R7
	300MΩ	↓	R9	↓	R7	↓	R8
DC current	AUTO	F5	R0	F5	R0	F5	RA
	300mA	↓	R6	↓	R1	↓	R-1
	3000mA		R7		R2		R0
AC current	AUTO	F6	R0	F6	R0	F6	RA
	300mA	↓	R6	↓	R1	↓	R-1
	3000mA		R7		R2		R0

R6551
DIGITAL MULTIMETER
INSTRUCTION MANUAL

5.8 Command Codes

Table 5 - 7 Command Codes (2 of 3)

Function	Range	Command group 0	Command group 1	Command group 2
Sampling mode	Free run Hold	M0 M1	T0 T3	T1 T2
Trigger		E, "GET"	?, "GET"	T3, "GET"
Sampling rate	FAST MID SLOW	PR1 PR2 PR3	S2 S1 S0	PR1 PR2 PR3
Number of displayed digits	3 1/2 digits 4 1/2 digits 5 1/2 digits	RE3 RE4 RE5	RE3 RE4 RE5	N3 N4 N5
Range setting	Change to manual range from auto range	RX	RX	RX
Null	OFF ON	NL0 NL1	B0 B1	NL0 NL1
Scaling	OFF ON	SC0 SC1	SC0 SC1	SC0 SC1
Filter at ACV FAST	OFF ON	FL0 FL1	FL0 FL1	FL0 FL1
Auto zero calibration	OFF ON Truns auto zero calibration after executing it once.	AZ0 AZ1 AZ2	AZ0 AZ1 AZ2	Z0 Z1 Z2
Header ON/OFF (data format)	OFF (ASCII) ON (ASCII) OFF (BINARY)	H0 H1 H2	H0 H1 H2	H0 H1 H2
Delimiter mode	CR/LF, EOI LF EOI	DL0 DL1 DL2	W0 W5 W6	DL0 DL1 DL2
SRQ transmit mode	Enables transmission. Disables transmission.	S0 S1	SR0 SR1	S0 S1
Display ON/OFF	OFF ON	DS0 DS1	D1 D0	D2, D3 D1
Calibration value input		PCdddddd	PCdddddd	PCdddddd

R6551
DIGITAL MULTIMETER
INSTRUCTION MANUAL

5.8 Command Codes

Table 5 - 7 Command Codes (3 of 3)

Function	Range	Command group 0	Command group 1	Command group 2
Initialization	Power-on operation	C	X0	C
	Parameter initialization	Z	*	*
Reading of settings	When this equipment is addressed to talk after sending a command code added with ?, this equipment generates the set state as data.	OO?	OO?	OO?

R6551
DIGITAL MULTIMETER
INSTRUCTION MANUAL

5.9 Sample Programs

5.9 Sample Programs

This section provides sample programs using HP200 manufactured by Hewlett-Packard Co. and PC9801 manufactured by NEC.

Example 5-1: This program externally starts DC voltage measurement in the measuring range 30V in the sampling mode HOLD.

(a) Sample Program Using HP200

		Description
10	!	
20	!	
30	!	
40	DIM AS (20)	40 Defines the area of data.
50	R6551=701	50 Assigns the address of R6551 to variable R6551.
60	!	
70	CLEAR R6551	70 Initializes the GPIB interfaced device.
80	OUTPUT R6551;"F1,R5,M1"	80 Sets parameters for R6551.
90	OUTPUT R6551;"PR2,DL0,S1"	to F1 -- Measuring function: VDC
100	TRIGGER R6551	90 R5 -- Measuring range: 30V
110	ENTER R6551;A\$	M1 -- Sampling mode: HOLD
120	PRINT A\$	PR2 -- Sampling rate: MID
130	GOTO 100	DL0 -- Block delimiter: CR LF EOI
140	!	S1 -- Disables SRQ transmission.
150	END	100 Starts R6551 externally.
		110 Receives data.
		120 Causes this equipment to display information.
		130 Branches to line number 100.
		150 Terminates the program.

R6551
DIGITAL MULTIMETER
INSTRUCTION MANUAL

5.9 Sample Programs

(b) Sample Program Using PC9801

```

10  '
20  '
30  '
40  ISET IFC
50  ISET REN
60  CMD DELIM=0
70  WBYTE &H3F,&H5E,&H21,&H4;
80  PRINT @1;"F1,R5,M1"
90  PRINT @1;"PR2,DLO,S1"
100 WBYTE &H3F,&H5E,&H21,&H8;
110 INPUT @1;A$
120 PRINT A$
130 GOTO 100
140 END

```

Description	
40	Clears the interface.
50	Enables remote control.
60	Sets a delimiter CR+LF
70	Clears R6551.
80	Sets parameters for R6551.
to	F1 -- Measuring function: VDC
90	R5 -- Measuring range: 30V
	M1 -- Sampling mode: HOLD
	PR2 -- Sampling rate; MID
	DLO -- Block delimiter: CR LF EOI
	S1 -- Disables SRQ transmission.
100	Starts R6551 externally.
110	Receives data.
120	Causes this equipment to display information.
130	Branches to line number 100.
140	Terminates the program.

Example 5-2: This program externally sets parameters for measurement, causes this equipment to start the measurement, and reads data using SRQ.

(a) Sample Program Using HP200

		Description	
10	!	40	Defines the area of data.
20	!	50	Sets the address of R6551 to variable R6551.
30	!	60	Defines an interrupt processing routine.
40	DIM A\$(20)	80	Initializes the GPIB interfaced device.
50	R6551=701	90	Sets parameters for R6551. F3 -- Measuring function: OHM R5 -- Measuring range: 30kΩ M1 -- Sampling mode: HOLD
60	ON INTR 7 GOSUB Srq	100	PR2 -- Sampling rate: MID DL0 -- Block delimiter: CR LF EOI
70	!	110	SO -- Enables SRQ transmission. Enables interruptions using SRQ
80	CLEAR R6551	120	Starts R6551 externally.
90	OUTPUT R6551;"F3,R5,M1"	130	Loop of interruptions and an interrupt wait routine
100	OUTPUT R6551;"PR2,DL0,SO"	150	
110	ENABLE INTR 7;2	170	Pools the interrupt processing routine names R6551 to read the status.
120	TRIGGER R6551	180	
130	Wait_f=0	190	Branches to line number 230 if interruption occurs from non-R6551.
140	IF Wait_f=1 THEN 120	200	Receives data.
150	GOTO 140	210	Causes this equipment to display information.
160	!	220	Set the interrupt processing terminate flag (Wait_f).
170	Srq:STATUS 7,1;X	230	Enables interruptions using SRQ
180	S=SPOLL (R6551)	240	RETURN to the main routine.
190	IF S<>65 THEN 230	260	Terminates the program.
200	ENTER R6551;A\$		
210	PRINT A\$		
220	Wait_f=1		
230	ENABLE INTR 7;2		
240	RETURN		
250	!		
260	END		

R6551
DIGITAL MULTIMETER
INSTRUCTION MANUAL

5.9 Sample Programs

(b) Sample Program Using PC9801

		Description
10	.	
20	.	
30	.	
40	ISSET IFC	40 Clears the interface.
50	ISSET REN	50 Enables remote control.
60	CMD DELIM=0	60 Sets a delimiter CR+LF
70	DEF SEG=&H60	70 Clears the SRQ signal inside the GPIB of PC9801. (70-100) Declares a segment base address.
80	A%=PEEK(&H9F3)	80 Reads the contents of addresses.
90	A%=A% AND &HBF	90 Makes ANDing (to clear the interrupt bit).
100	POKE &H9F3,A%	
110	ON SRQ GOSUB 210	100 Writes data to the specified address on the memory.
120	SRQ ON	
130	WBYTE &H3F,&H5E,&H21,&H4;	110 Specifies the head address of the SRQ subroutine.
140	PRINT @1;"F3,R5,M1"	120 Enables SRQ reception.
150	PRINT @1;"PR2,DLO,SO"	130 Clears R6551.
160	SRQ ON	140 Sets parameters for R6551.
170	WBYTE &H3F,&H5E,&H21,&H8;	F3 -- Measuring function: OHM
180	WAIT.F=0	R5 -- Measuring range: 300kΩ
190	IF WAIT.F=1 THEN 170	M1 -- Sampling mode: HOLD
200	GOTO 190	150 PR2 -- Sampling rate: MID
210	POLL 1,S	DLO -- Block delimiter: CR LF EOI
220	IF S<>65 THEN 260	SO -- Enables SRQ transmission.
230	INPUT @1;A\$	160 Enables SRQ reception.
240	PRINT ;A\$	170 Starts R6551 externally.
250	WAIT.F=1	180 Assigns 0 to flag (WAIT.F).
260	SRQ ON	190 Branches to line number 170 if flag (WAIT.F) is 1.
270	RETURN	200 Branches to line number 190.
280	END	210 Executes serial polling.
		220 Branches to line number 260 when interruption occurs from non-R6551.
		230 Receives data.
		240 Causes this equipment to display information.
		250 Assigns 1 to flag (WAIT.F).
		260 Enables SRQ reception.
		270 RETURN
		280 Terminates the program.

R6551
DIGITAL MULTIMETER
INSTRUCTION MANUAL

5.9 Sample Programs

Example 5-3: This program receives measured values in the binary format.

(a) Sample Program Using HP200

```

10  !
20  R6551=701
30  !
40  CLEAR R6551
50  OUTPUT R6551;"F1, R4, M1, PR1, H2"
60  !
70  TRIGGER R6551
80  ENTER R6551 USING "B,W"; Data1,
    Data2
90  !
100 Sign=0
110 IF Data1>=128 THEN
120     Sign=1
130     Data1=Data1-128
140 END IF
150 IF Data2<0 THEN Data2=Data2+65536
160 Data3=Data1*65536+Data2
170 IF Sing=1 THEN Data3=(-Data3)
180 Data3=Data3*10(-5)
190 PRINT Data3
200 GOTO 70
210 !
220 END

```

Description	
10	
20	Assigns the address of R6551 to variable R6551.
30	
40	Initializes the GPIB interfaced device.
50	Sets parameters for R6551. F1 -- Measuring function: VDC R4 -- Measuring range: 3V M1 -- Sampling mode: HOLD PR1 -- Sampling rate: FAST H2 -- Measured data output format: BINARY
60	
70	Starts R6551 externally.
80	Receives the first byte of measured data to Data1 and the second and third bytes to Data2. (1 data = three bytes)
90	
100	Initializes the sign flag Sing (to 0).
110	Executes lines 120 and 130 if the first byte (data1) is 128 or more. Branches to line number 150 if the first byte (Data1) is less than 128.
120	Assigns 1 to the sign flag Sing.
130	Sets the sign bit in the first byte (Data1) to 0.
140	Ends the IF statement.
150	Converts the value of the second and third bytes (Data2) to a positive value, if that value is negative (MSB=1).
160	Combines the first byte (Data1) with the second and third bytes (Data2) and assigns the combined value to Data3.
170	Converts measured data (Data3) to a negative value if the sign flag Sign is 1.
180	Converts the unit of measured data.
190	Causes this equipment to display measured data.
200	Branches to line number 70.
210	
220	Terminates the program.

R6551
DIGITAL MULTIMETER
INSTRUCTION MANUAL

5.9 Sample Programs

(b) Sample Program Using PC9801

```

10 '
20 R6551=5
30 '
40 ISET IFC
50 ISET REN
60 CMD DELIM=0
70 WBYTE &H3F, &H5E, &H25, &H4;
80 PRINT @R6551;"F1, R4, M1, PR1, H2"
90 '
100 WBYTE &H3F, &H5E, &H25, &H8;
110 WBYTE &H45, &H3E;
120 RBYTE ;DATA1
130 RBYTE ;DATA2
140 RBYTE ;DATA3
150 '
160 SIGN=0
170 IF DATA1<128 THEN GOTO 200
180     SIGN=0
190     DATA1=DATA1-128
200 DATA4=DATA1*65536+DATA2*256
    +DATA3
210 IF SIGN=1 THEN DATA4=(-DATA4)
220 DATA4=DATA4*10 ^ (-5)
230 PRINT DATA4
240 GOTO 100
250 '
260 END

```

Description	
10	
20	Assigns the address of R6551 to variable R6551.
30	
40	Clears the interface.
50	Enables remote control.
60	Sets the delimiter CR+LF.
70	Sends a select device clear signal to R6551.
80	Sets parameters for R6551. "F1" -- Measuring function: VDC "R4" -- Measuring range: 3V range "M1" -- Sampling mode : HOLD "PR1" -- Sampling rate : FAST "H2" -- Measured data output format : BINARY
90	
100	Starts R6551 externally.
110	Addresses R6551 to talk and the controller to listen.
120	Enters the first byte of measured data to DATA1, the second byte to DATA2, and the third to DATA3.
130	
140	
150	
160	Initializes the sign flag sign (to 0).
170	Branches to line number 200 if the first byte (DATA1) is less than 128 (where the sign bit is 0). Executes lines 180 and 190 if the first byte (DATA1) is 128 or more (where the sign bit is 1).
180	Assigns 1 to the sign flag SIGN.
190	Sets the sign bit in the first byte (DATA1) to 0.
200	Combines the first byte (DATA1), second byte (DATA2), and third byte (DATA3), and assigns the combined value to DATA4.
210	Converts measured data (DATA4) to a negative value if the sign flag SIGN is 1.
220	Converts the unit of measured data.
230	Causes this equipment to display measured data.
240	Branches to line number 100.
250	
260	Terminates the program.

5.10 Outline Operation Flowchart

Figure 5-2 below is a flowchart of outlined GPIB operations:

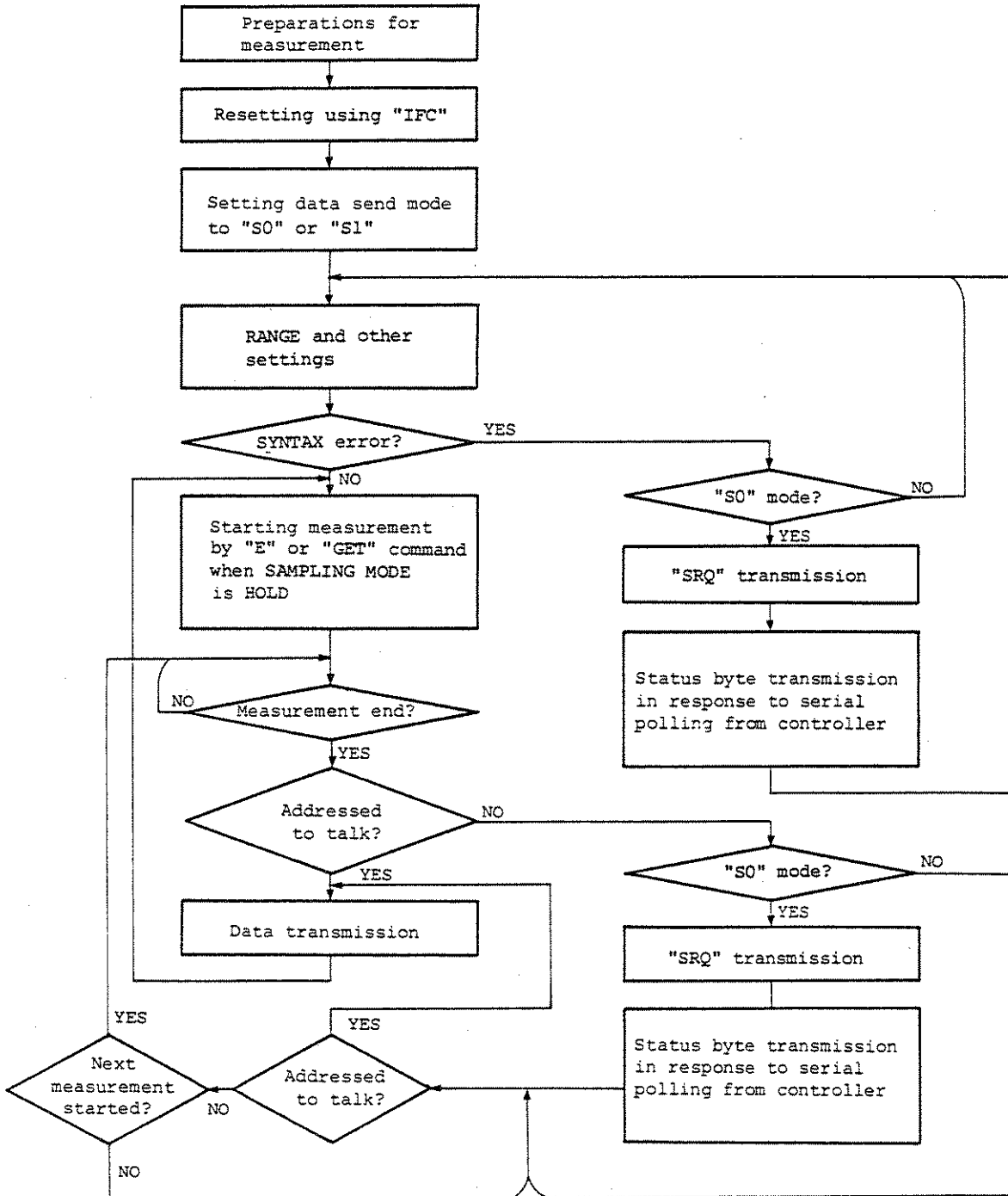

Figure 5 - 2 GPIB Operation Flowchart

5.10.1 Notes on Operations

(1) Operation on Occurrence of Service Request

When a service request occurs (in the S0 mode) on completion of measurement or occurrence of a syntax error, this equipment operates as below. Consider the following operation in each case in programming:

① Using Serial Polling

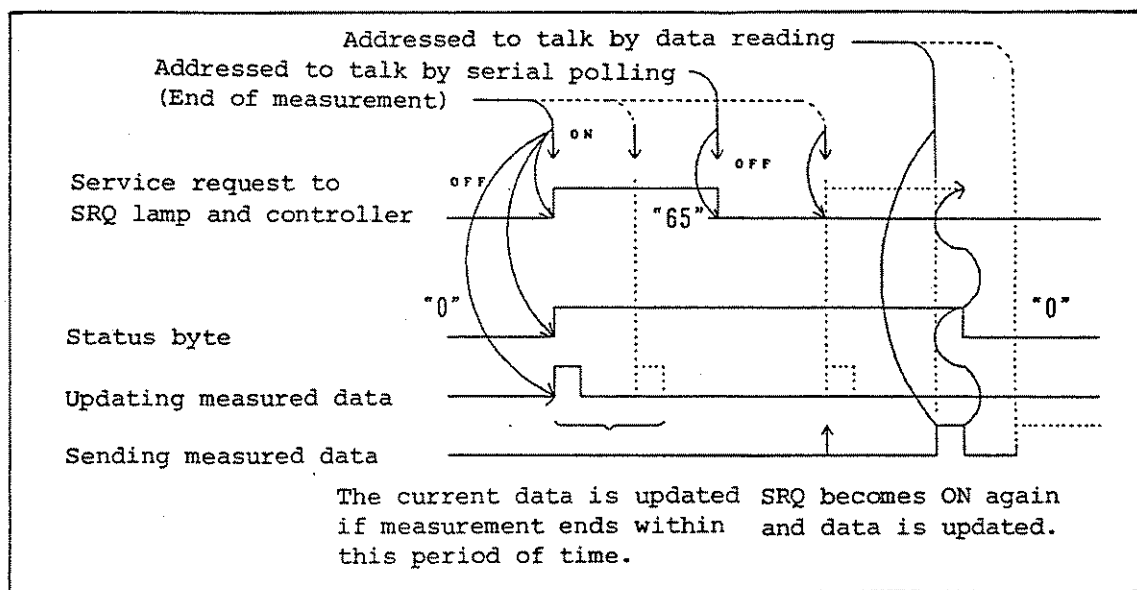

② Not Using Serial Polling

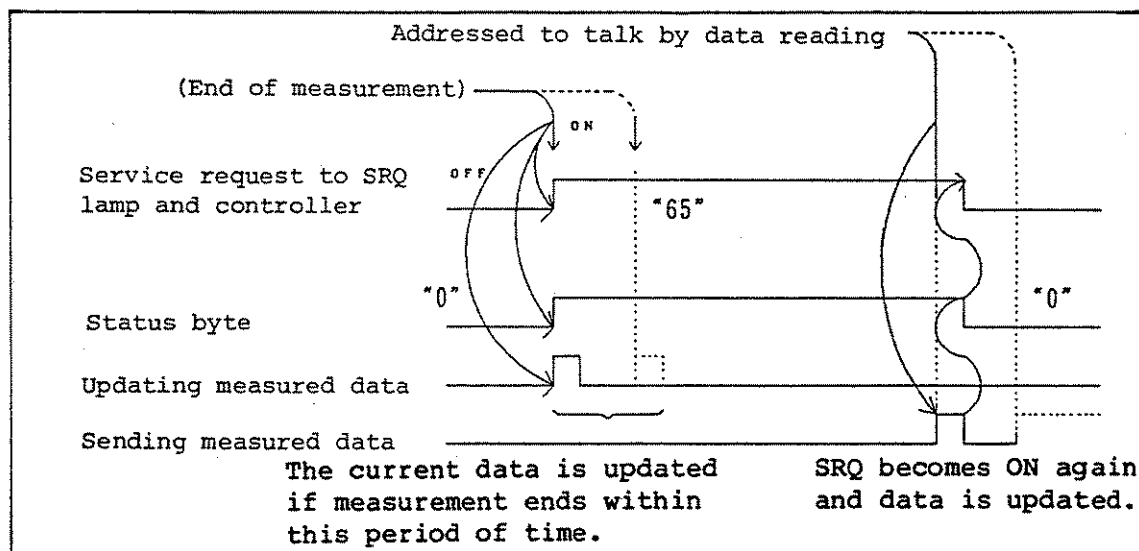

5.10 Outline Operation Flowchart

③ On Occurrence of Syntax Error

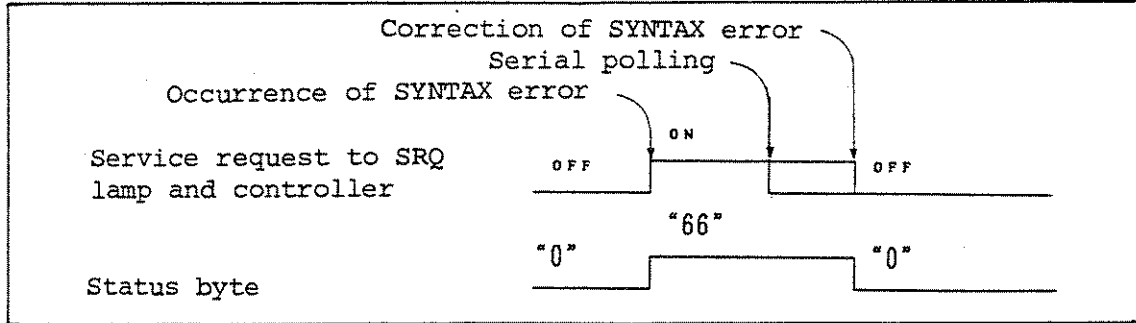

NOTE

After a syntax error occurs, SRQ is cleared when this equipment is addressed to listen.

(2) Difference in sending data depending on the talker addressing timing

① Starting Measurement by a Program

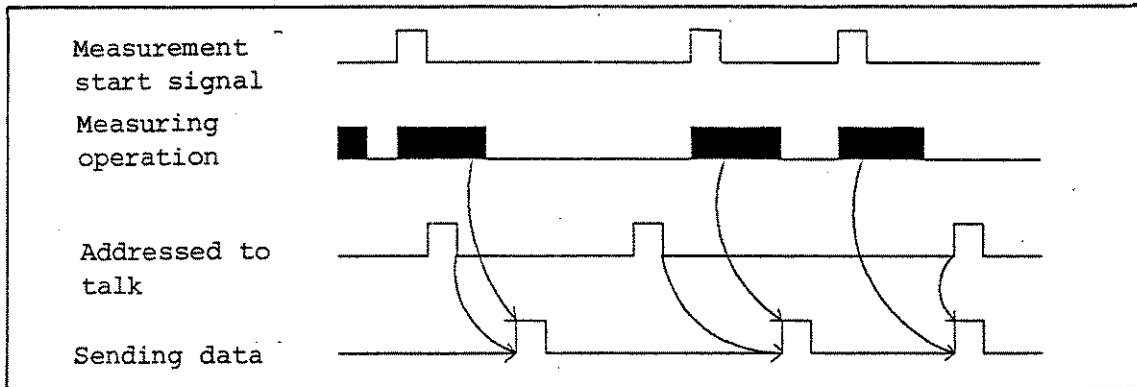

② Free-run Measurement

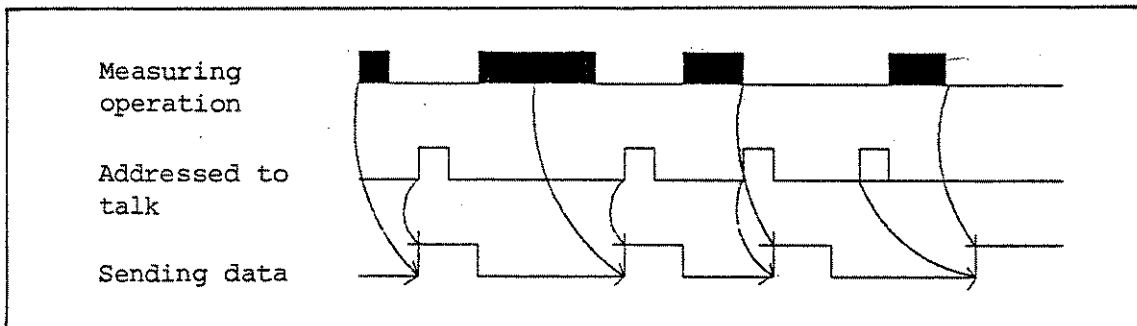

R6551
DIGITAL MULTIMETER
INSTRUCTION MANUAL

6.1 Introduction

6. BCD OUTPUT (OPT01) (R6551 ONLY)

6.1 Introduction

The BCD (binary-coded decimal) data output unit, OPT01, is an option which can be installed in R6551. The output unit outputs the results of measurement to an external digital equipment like a digital recorder after converting them into parallel BCD codes. It also has the external measurement start function. Since the input/output signal system is isolated electrically from the measurement signal system of R6551, measured values are not affected by external equipments.

R6551
DIGITAL MULTIMETER
INSTRUCTION MANUAL

6.2 Data Output Code and Data Output Connector

6.2 Data Output Code and Data Output Connector

Table 6 - 1 BCD Data Output Codes

Output name	Output signal	Code			
		8	4	2	1
Data	0	0	0	0	0
	1	0	0	0	1
	2	0	0	1	0
	3	0	0	1	1
	4	0	1	0	0
	5	0	1	0	1
	6	0	1	1	0
	7	0	1	1	1
	8	1	0	0	0
	9	1	0	0	1
	Space	1	1	1	1
Decimal point	10 ⁰	0	0	0	0
	10 ¹	0	0	0	1
	10 ²	0	1	0	0
	10 ³	0	1	1	0
	10 ⁴	1	0	0	0
	10 ⁵	1	0	1	0
Function	* (OVER)	0	0	0	0
	+	0	0	1	1
	-	0	0	0	1
	Space (AC)	0	0	1	0
Unit	mV	0	0	0	0
	V	0	0	1	0
	Ω	0	1	0	0
	kΩ	0	1	0	1
	MΩ	1	0	1	1
	mA	1	0	1	0
	Space	1	1	1	1

- The polarity of AC is represented by a space. In NULL or SCALE operation, however, + or - is output to represent the polarity.
- In the FAST mode (for 4 1/2 digit display), the 10⁰th digit is assigned a space.

6.2 Data Output Code and Data Output Connector

Table 6 - 2 Data Output Connector
(57-40500 Manufactured by Dai-ichi
Denshi Kogyo)

Pin arrangement	
Pin	Pin
1	SIG. GND
2	2 ⁰
3	2 ¹
4	2 ²
5	2 ³
6	2 ⁰
7	2 ¹
8	2 ²
9	2 ³
10	2 ⁰
11	2 ¹
12	2 ²
13	2 ³
14	2 ⁰
15	2 ¹
16	2 ²
17	2 ³
18	2 ⁰
19	2 ¹
20	2 ²
21	2 ³
22	2 ⁰
23	2 ¹
24	2 ²
25	2 ³
26	2 ⁰
27	2 ¹
28	2 ²
29	2 ³
30	2 ⁰
31	2 ¹
32	2 ²
33	2 ³
34	2 ⁰
35	2 ¹
36	NC
37	NC
38	2 ²
39	2 ³
40	2 ⁰
41	2 ¹
42	2 ²
43	2 ³
44	2 ⁰
45	2 ¹
46	2 ²
47	PRINT CMD
48	EXT ST. A
49	NC*1
50	SIG. GND

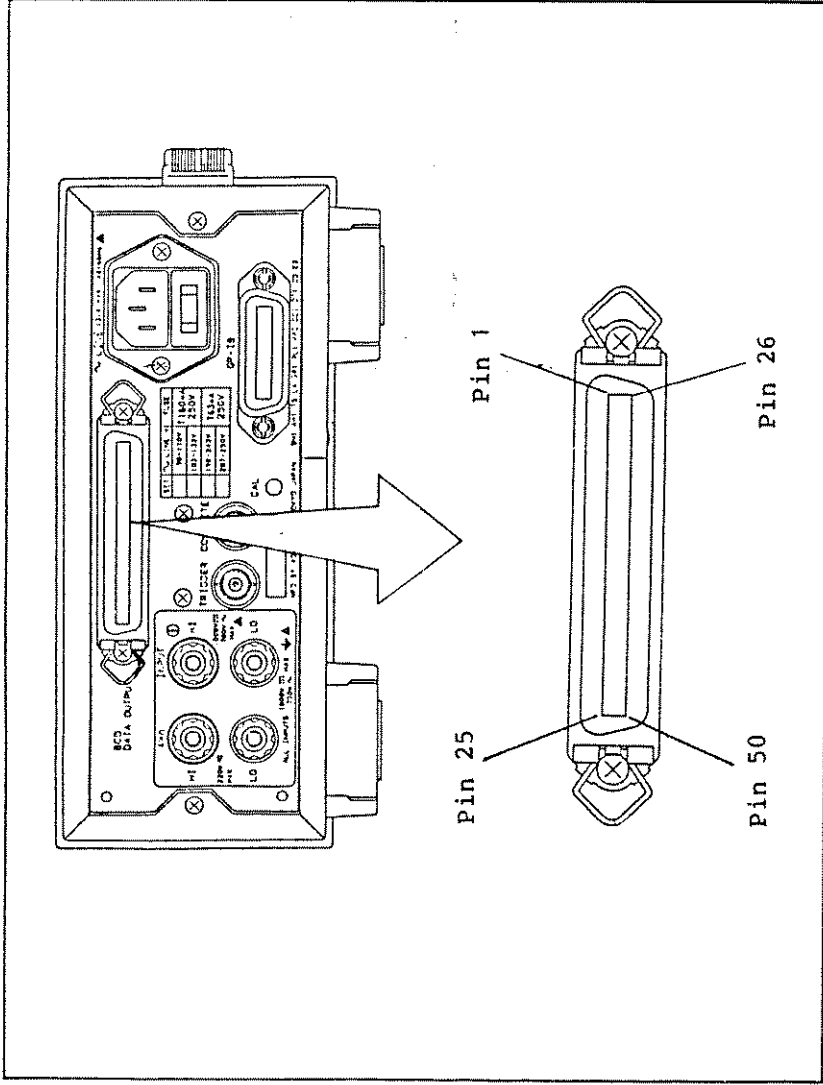

Figure 6 - 1 BCD Output Connector

*1: The terminal NC of pin No. 49 is an empty terminal; however, never use it as a relay terminal.

*2: Decimal point codes are used as follows: 10⁰, 10¹, 10², 10³, 10⁴, 10⁵, 10⁶, 10⁷, 10⁸, 10⁹.

*3: Pins No. 26 to 33, 36, and 37 are pulled up at 10 kΩ.

6.3 Operating Procedures

6.3.1 Connection to Digital Recorder

- ① Use a digital recorder TR6198.
- ② Connect the connection cable attached to TR6198 to the DATA OUTPUT connector. (Before connecting the cable, turn both R6551 and TR6198 off.)
- ③ Operate the digital recorder according to the operating procedure of TR6198.

6.3.2 Connection to Equipment Other than Digital Recorder

Pay attention to the following points in data transfer to equipment other than TR6198.

- ① Check the input level of the device to which the data output unit is connected. R6551 has the following output circuit. (See Figure 6-2.)
 - Data, function, decimal point, print instruction signal
 - Unit output (Pins No. 40 to 43)
 - HI level pins except for the above
- ② Output data is output at the same timing as a print instruction signal. For sending data to external equipments, use the print instruction signal as a strobe signal.

R6551
 DIGITAL MULTIMETER
 INSTRUCTION MANUAL

6.3 Operating Procedures

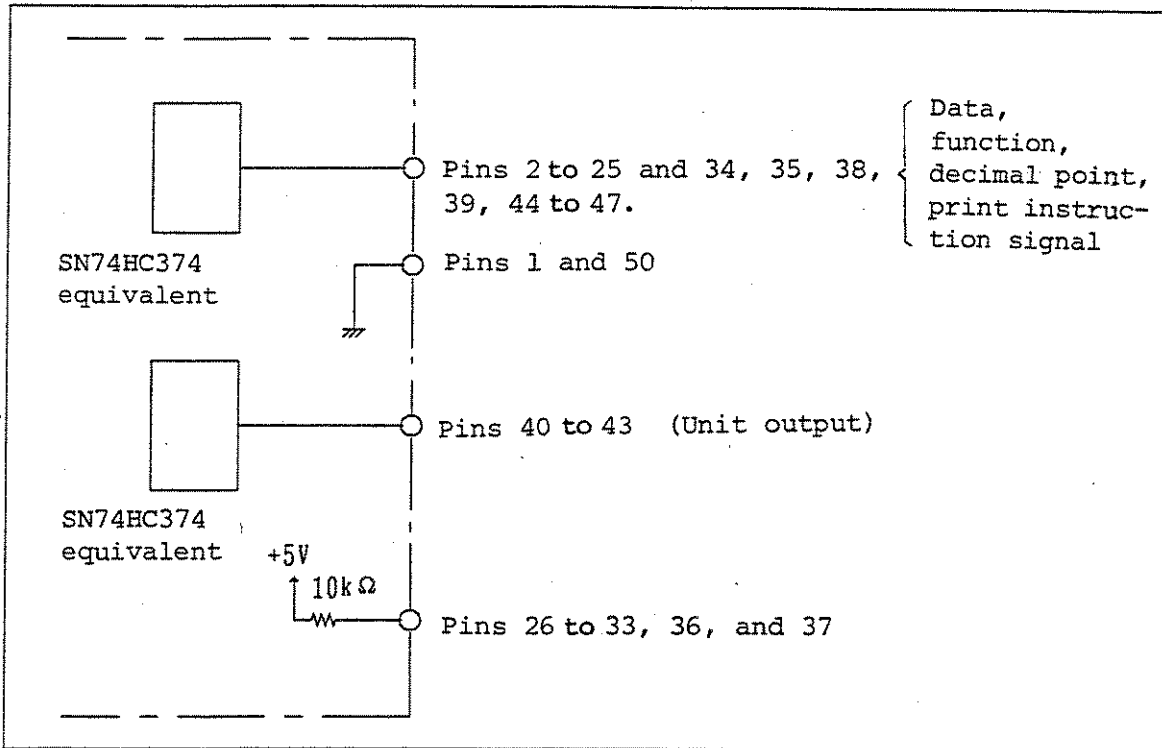
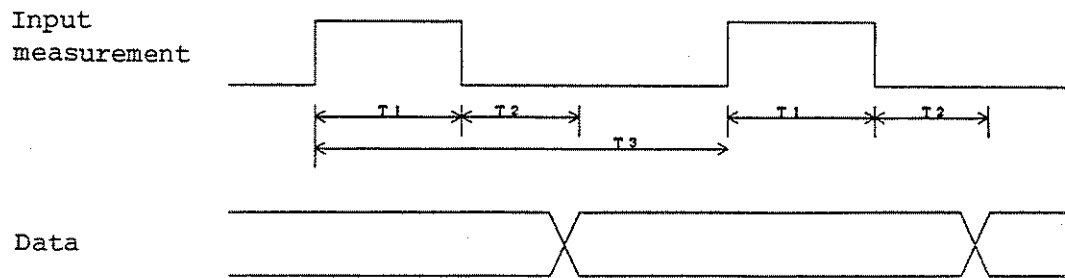

Figure 6 - 2 Output Circuit of BCD Output Unit

6.3.3 Measuring Timing

This section shows the measuring timing when R6551 is used as an instrumentation system using the BCD data output unit OPT01.

(1) In the Free-run Sampling Mode



R6551
DIGITAL MULTIMETER
INSTRUCTION MANUAL

6.3 Operating Procedures

Rate		T1	A ZERO OFF		A ZERO ON	
			T2	T3	T2	T3
Low speed S		100ms	6 to 8ms	167ms	173ms to 175ms	333ms
Middle speed M	50Hz	20ms	6 to 8ms	50ms	56ms to 58ms	100ms
	60Hz	16.667ms				
High speed F		2ms	5 to 7ms	10ms	15ms to 17ms	20ms

T1: Input signal integration time
T2: Time from the end of integration to data occurrence
T3: Sampling frequency

- The sampling rate for AC voltage and current measurement is not set to High speed F.
- Setting of A ZERO (auto zero) OFF for four-wire resistance measurement is treated as A ZERO ON.

(2) In the Sampling Hold Mode

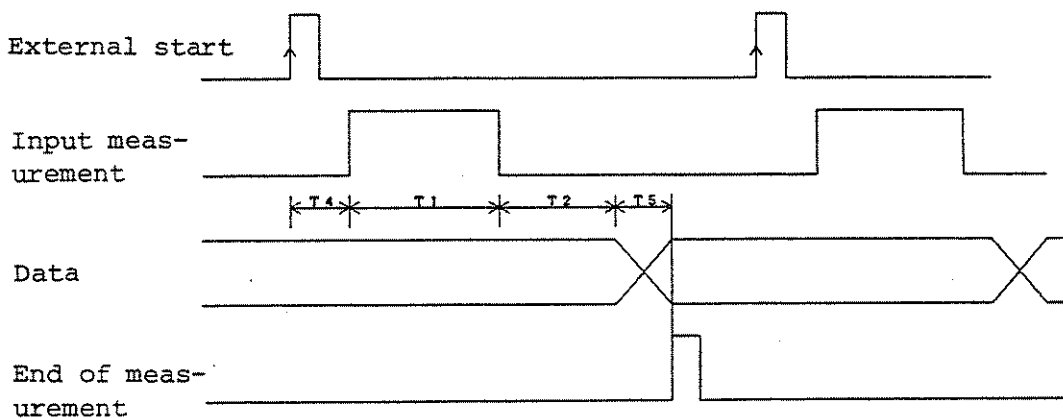

- Time T4 from external start to the end of measurement is within 800 μ s to 1100 μ s.
- T1 and T2 are the same as in the free-run mode.
- External start during measuring operations (from external start to data output) is possible only once.
- T5 is about 30 μ s.

R6551
DIGITAL MULTIMETER
INSTRUCTION MANUAL

6.4 Specifications

6.4 Specifications

Data output

Output code : BCD (binary-coded decimal) code
Data types : Measured data, decimal pint, polarity, and unit
Signal level: TTL level positive logic 1 -- +2.7V to +5.25V
0 -- 0V to +0.5V

Print instruction signal

PRINT CMD: TTL level positive pulse

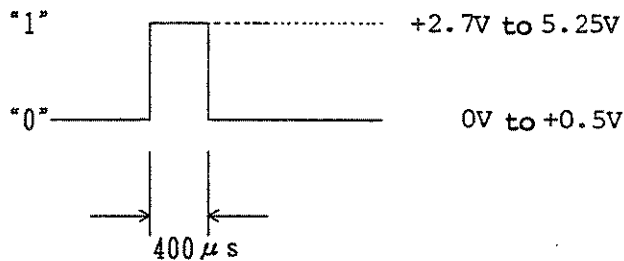

External start signal (input signal)

EXT ST.: TTL level positive pulse
Comes on at leading edge.

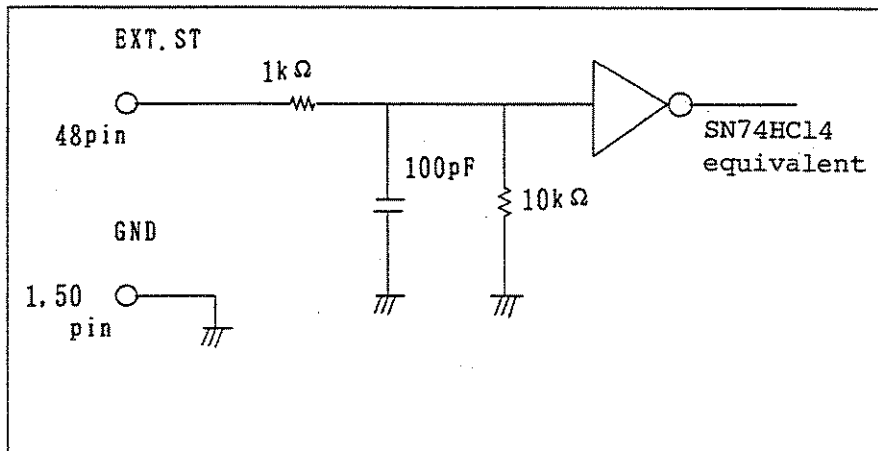
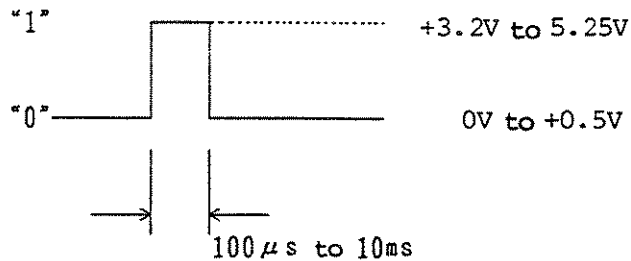

Figure 6 - 3 External Start Input Circuit

R6551
DIGITAL MULTIMETER
INSTRUCTION MANUAL

7.1 Specification

7. SPECIFICATION, OPTIONS, AND ACCESSORIES

7.1 Specification

(1) DC Voltage Measurement

Range, maximum indicatable value, resolution, and input impedance

Range	Max. indicatable value	Resolution		Input impedance
		5 1/2 digits	4 1/2 digits	
300mV	319.999mV	1μV	10μV	1000 MΩ or more
3000mV	3199.99 mV	10μV	100μV	
30mV	31.9999V	100μV	1mV	10 MΩ ±1%
300 V	319.999 V	1mV	10mV	
1000 V	1099.99 V	10mV	100mV	

Measurement accuracy (5 1/2 digits, Auto zero ON)

± (of reading + digits)

Range	24 hours (23°C±1°C)**	90 days (23°C±5°C)	1 year (23°C±5°C)
300mV*	0.002% +5	0.006% +7	0.014% +7
3000mV	0.002% +2	0.006% +3	0.012% +3
30 V	0.002% +3	0.007% +6	0.015% +6
300 V	0.002% +2	0.006% +3	0.014% +3
1000 V	0.002% +2	0.006% +3	0.014% +3

* When NULL function is used:

- Sampling rate MID: Add 2 to item "digits".
- Sampling rate FAST: Add 2 to item "digits" for 4 1/2-digit display.

** Relative value to the calibration standard

R6551
DIGITAL MULTIMETER
INSTRUCTION MANUAL

7.1 Specification

Temperature coefficient

\pm (of reading + digits) / °C

Range	Auto zero ON	Auto zero OFF
300mV	0.0005% +1.6	0.0005% +13
3000mV	0.0005% +0.2	0.0005% +1.3
30 V	0.0006% +1.0	0.0006% +13
300 V	0.0005% +0.1	0.0005% +4
1000 V	0.0005% +0.1	0.0005% +1.2

At a working temperature within 0°C to +10°C, add 0.0005% of reading/°C.

Maximum applicable voltage

Between HI and LO: 300mV, 3000mV range
 400V (DC or AC peak) continuous
 1100V (DC or AC peak) for 10 seconds
 30V, 300V, 1000V range
 1100V (DC or AC peak) continuous

Between input LO terminal and chassis:

1000V (DC or AC peak) 700V rms AC continuous

Noise elimination ratio

Sampling rate	Effective CMR (At unbalanced impedance of 1 kΩ)		NMR 50Hz/60Hz \pm 0.09%
	50Hz/60Hz \pm 0.09%	DC	
S, M	120dB	130dB	60dB
F	60dB	130dB	0dB

(2) AC voltage measurement (True rms value)

Range	Max. indicatable value	Resolution		Input impedance
		5 1/2 digits	4 1/2 digits	
300mV	319.999mV	1μV	10μV	1MΩ \pm 2% 100 PF or less
3000mV	3199.99mV	10μV	100μV	
30 V	31.9999 V	100μV	1mV	
300 V	319.999 V	1mV	10mV	
700 V	709.99 V	10mV	100mV	

R6551
DIGITAL MULTIMETER
INSTRUCTION MANUAL

7.1 Specification

Measurement accuracy (5 1/2 digits for 1 year at 23°C ±5°C)

±(of reading+digits)

Frequency range	Range				
	300mV	3000mV	30V	300V	700V
20Hz to 45Hz	0.8% +160	0.8% +120	0.8% +120	1.1% +160	1.1% +160
45Hz to 100Hz	0.4% +160	0.4% +120	0.4% +120	0.4% +160	0.4% +160
100Hz to 50kHz	0.28% +160	0.28% +160	0.28% +160	0.5% +160	0.5% +160
50kHz to 100kHz	0.5% +660	0.5% +660	0.5% +660	1% +660	Less than 1kHz
100kHz to 300kHz	3% +1200	3% +1200	5% +1200		

- Guaranteed at input of 15000 indication or more
- Guaranteed at 300Hz or more at the sampling rate M or F

Measuring method : True rms measurement, AC coupling
 Temperature coefficient : (1/10 of measurement accuracy)/°C for each voltage range, within each frequency range
 Response time : Within 3 (at S) or 0.5 (at M and F) sec to reach measurement accuracy in a fixed range
 Crest factor : 3:1 in full scale measurement
 Maximum applicable voltage: Between HI and LO 300mV to 700V range;
 710V (DC or AC rms) continuous
 1000V (AC peak), 10⁷V·Hz or less

(3) Resistance Measurement

Measurement method: Using a four-wire or two-wire conductor Range, maximum indicatable value, resolution, and input measured current.

Range	Max. indica- table value	Resolution		Measured current
		5 1/2 digits	4 1/2 digits	
300 Ω	319.999 Ω	1mΩ	10mΩ	1mA
3000 Ω	3199.99 Ω	10mΩ	100mΩ	1mA
30kΩ	31.9999kΩ	100mΩ	1 Ω	100μA
300kΩ	319.999kΩ	1 Ω	10 Ω	10μA
3000kΩ	3199.99kΩ	10 Ω	100 Ω	1μA
30MΩ	31.9999MΩ	100 Ω	1kΩ	100nA
300MΩ	319.99 MΩ	(10kΩ)	10kΩ	10nA

R6551
DIGITAL MULTIMETER
INSTRUCTION MANUAL

7.1 Specification

Measurement accuracy (5 1/2 digits, Auto zero ON *)
±(of reading + digits)

Range	24 hours** (23°C±1°C)	90 days (23°C±5°C)	1 year (23°C±5°C)
300 Ω	0.002% +5	0.008% +11	0.015% +11
3000 Ω	0.002% +3	0.007% +3	0.012% +3
30kΩ	0.002% +3	0.007% +3	0.013% +3
300kΩ	0.002% +3	0.009% +3	0.014% +3
3000kΩ	0.007% +14	0.03% +19	0.03% +19
30MΩ	0.06% +14	0.18% +19	0.2% +19
300MΩ	0.6% +14	1.7% +19	2% +19

* When NULL function is used:

- Sampling rate MID : Add 2 to item "digits".
- Sampling rate FAST: Add 2 to item "digits" for 4 1/2-digit display.
- For measurement accuracy for two-wire measurement, add the resistance for the measuring cable and the offset of up to 200 mΩ.

** Relative value to the calibration standard

Temperature coefficient

±(of reading+digits)/°C

Range	Auto zero ON	Auto zero OFF
300 Ω	0.0007% +1.6	0.0007% +1.3
3000 Ω	0.0007% +0.2	0.0007% +1.4
30kΩ	0.0007% +0.2	0.0007% +1.4
300kΩ	0.0009% +0.2	0.0009% +1.4
3000kΩ	0.003% +1.3	0.003% +1.4
30MΩ	0.03% +1.3	0.03% +1.4
300MΩ	0.3% +1.3	0.3% +1.4

For temperature coefficient for two-wire measurement, add the resistance for the measuring cable and the offset of up to 20 mΩ/°C. At a working temperature within 0°C to +10°C, add 0.0005% of reading/°C.

R6551
DIGITAL MULTIMETER
INSTRUCTION MANUAL

7.1 Specification

Voltage between open pins : Maximum 6 V
 Maximum applicable voltage (Between HI and LO):
 220VDC, 310VAC (at the peak) continuous
 Response time : Within 0.5 second to reach measurement accuracy in a 3000k Ω , 30M Ω , or fixed range
 Within 5 seconds to reach measurement accuracy in a 300M Ω or fixed range

(4) DC Current Measurement

Range, maximum indicatable value, resolution, and inter-terminal resistance

Range	Max. indicatable value	Resolution		Inter-terminal resistance
		5 1/2 digits	4 1/2 digits	
300mA	319.999mA	1 μ A	10 μ A	0.3 Ω or less
3000mA	3009.99mA	10 μ A	100 μ A	0.3 Ω or less

Measurement accuracy (5 1/2 digits, Auto zero ON)
 ±(of reading + digits)

Range	90 days (23 $^{\circ}$ C \pm 5 $^{\circ}$ C)	1 year (23 $^{\circ}$ C \pm 5 $^{\circ}$ C)
300 mA	0.06% +40	0.13% +40
3000 mA	0.06% +6	0.13% +6

- Sampling rate MID : Add 2 to item "digits".
- Sampling rate FAST: Add 2 to item "digits" for 4 1/2-digit display.

Temperature coefficient : In each range (1/10 of accuracy of measurement at 23 $^{\circ}$ C \pm 5 $^{\circ}$ C for 90 days)/ $^{\circ}$ C with auto zero function on, add 1 μ A/ $^{\circ}$ C.

Maximum applicable current: 3.15A (DC or AC rms) continuous between current HI and LO terminals
 Internal protection by a fast-blow fuse

(5) AC Current Measurement (True rms measurement)

Range, maximum indicatable value, resolution, and inter-terminal resistance

Range	Max. indicatable value	Resolution		Inter-terminal resistance
		5 1/2 digits	4 1/2 digits	
300mA	319.999mA	1 μ A	10 μ A	0.3 Ω or less
3000mA	3009.99mA	10 μ A	100 μ A	0.3 Ω or less

R6551
DIGITAL MULTIMETER
INSTRUCTION MANUAL

7.1 Specification

Measurement accuracy (5 1/2 digits, at 23°C±5°C for 1 year)
±(of reading+digits)

Frequency range	Range	
	300mA	3000mA
20Hz to 45Hz	2% +200	2% +200
45Hz to 100Hz	0.5% +200	0.5% +200
100Hz to 1kHz	0.4% +200	0.4% +200

- Guaranteed at input of 15000 indication or more
- Guaranteed at 300Hz or more at the sampling rate MID or FAST

Measuring method : True rms measurement, AC coupling
 Temperature coefficient : (1/10 of measurement accuracy for each voltage range within each frequency range
 Response time : Within 3 (at SLOW) or 0.5 (at MID and FAST) sec to reach measurement accuracy in a fixed range
 Crest factor : 3:1 in full scale measurement
 Maximum applicable current (Between HI and LO) :
 3.15A (DC or AC rms) continuous between current HI and LO terminals
 Internal protection by a fast-blow fuse (replaceable on the front panel)

R6551
DIGITAL MULTIMETER
INSTRUCTION MANUAL

7.1 Specification

(6) Number of measurable digits, measuring speed, and measuring time.

Function	Sampling rate (number of measurable digits)	Measuring speed		Input integration time
		A ZERO ON*	A ZERO OFF*	
DC voltage current measurement, two-wire resistance measurement	SLOW, low speed (5 1/2 digits)	3 times/ sec	6 times/ sec	100ms
	MID, middle speed (5 1/2 digits)	10 times/ sec	20 times/ sec	20ms (50Hz) 16.667ms (60Hz)
	FAST, high speed (4 1/2 digit)	50 times/ sec	100 times/ sec	2ms
Four-wire resistance measurement	SLOW, low speed (5 1/2 digits)	3 times/ sec	3 times/ sec	100ms
	MID, middle speed (5 1/2 digits)	10 times/ sec	10 times/ sec	20ms (50Hz) 16.667ms (60Hz)
	FAST, high speed (4 1/2 digits)	50 times/ sec	50 times/ sec	2ms
AC voltage current measurement	SLOW, low speed (5 1/2 digits)	3 times/ sec	6 times/ sec	100ms
	MID, middle speed (5 1/2 digits) FAST, high speed (4 1/2 digits)	10 times/ sec	20 times sec	20ms (50Hz) 16.667ms (60Hz)

* A zero (auto zero): This function to eliminate offset errors in the analog circuit block of this equipment is turned on or off.

- At the 300 MΩ range for two-wire/four-wire resistance measurement, the measuring speed is 3 times/second and the input integration time is 100ms.

(7) Arithmetic Functions

Null operation : Subtracts the null set value (M_{NULL}) which is the value measured when this function is set from each subsequent measured value (M_{IN}) and outputs the numeric value.

$$R = M_{IN} - M_{NULL}$$

Scale operation: Computes and outputs the ratio of each measured value (M_{IN}) to the scale set value (M_{SCALE} : 100%) which is the value measured when this function is set.

$$R = M_{IN}/M_{SCALE} \times 100$$

(8) Input/output Functions

Trigger signal input : Starts measurement via the BNC connector on the rear panel. TTL level, negative pulse, trailing edge, pulse width of 5 μ s or more

Complete signal output: Outputs a pulse signal on completion of sampling measurement to the BNC connector on the rear panel. TTL level, negative pulse, pulse width of about 5 μ s

GPIB interface

Governing standard : IEEE-488

Interface functions: SH1, AH2, T5, L4, SR1, RL1, PP0, DC1, DT1, C0, and E2

Output data format : ASCII

Remote control : Turns the power on and off, selects one of the input terminals (on front and rear panels), turns CAL (rear panel) on and off, and sets and resets parameters excluding the GPIB address, address mode, and command group.

SRQ signal : Maskable signal issued when measurement ends, an error occurs, or the SRQ key on the front panel is pressed.

(9) General Specifications

Measuring system: Integration type

Input system : Floating method

Range switching : Automatic or manual selection

Automatic range Up level : 320000

Down level: 29999

Data indication : 7-segment green LED to display up to six decimal digits. Polarity to be displayed is only "-".

Overload input indication: OL is displayed to indicate input exceeding the measuring range.

Unit and function indication: Green LED

Warm-up time : About one hour

Operating environment:

Temperature: 0 $^{\circ}$ C to +50 $^{\circ}$ C

Humidity : 85% RH max.

In the 30M Ω or 300M Ω resistance measuring range, an ambient temperature must be within 0 $^{\circ}$ C to 35 $^{\circ}$ C and humidity must not exceed 75% RH.

Storage environment:

Temperature: -25 $^{\circ}$ C to +70 $^{\circ}$ C

Humidity : 85% RH max.

(Note that data in memory such as measurement parameters and calibration data can be retained for about 10 years if the temperature is kept within the range from -25 $^{\circ}$ C to +60 $^{\circ}$ C.)

Power requirements:90 to 110VAC, 48Hz to 66Hz

R6551
DIGITAL MULTIMETER
INSTRUCTION MANUAL

7.1 Specification

Power consumption: 13VA or less
Voltage change : The power-supply voltage specified when this equipment was ordered is set.

Option No.	Standard	32	42	44
Power-supply voltage	90V to 110V	103V to 132V	198V to 242V	207V to 250V

Major dimensions: About 210 (width) x 86 (height) x 350 (depth) mm
Weight : 3.0kg or less

7.2 Option

OPT01 BCD output unit (R6551 only)

Details of output data (in parallel BCD):

Measured data, decimal point, polarity, unit, and OVER

Print instruction signal output:

TTL level, positive logic, pulse width of about 400 μ s

External start signal input:

TTL level, positive logic, pulse width of about 100 μ s to 10ms

Connector: Equivalent to 57-40500 manufactured by Anphenol

7.3 Accessories (Purchased)

A01006 : Input cable (Four-wire type for resistance measurement)

TR1111 : Terminal adapter

A02237 : Rack mount kit (JIS)

A02238 : Rack mount kit (JIS, double-type)

A02435 : Rack mount kit (EIA)

A02436 : Rack mount kit (EIA, double-type))

A02028 : Panel mount kit

A02029 : Panel mount kit (double-type)

R6551
DIGITAL MULTIMETER
INSTRUCTION MANUAL

8.1 Troubleshooting by User

8. CHECKING AND CALIBRATION

8.1 Troubleshooting by User

If your R6551/R6551EMC causes any trouble during operation, contact your local ADVANTEST office or agent after checking it with Table 8-1. Be sure to carefully check this equipment referring to the table and other sections of this instruction manual before requesting repair. You will be charged for any repairs including those covered by Table 8-1 below made by ADVANTEST or its representatives even if they are minor.

Table 8 - 1 Check Items

Condition	Possible cause	Corrective action
Display block does not go on.	Power fuse is blown.	Replace it with the attached spare.
Measurement is unstable, or abnormal values appear.	<ul style="list-style-type: none">- Function or range setting error- Line frequency 50/60Hz setting error	<ul style="list-style-type: none">- Check the function and range settings.- Set the value to the AC line frequency in use. (See ⑬ in Section 2.1.)
Applied input signal is not measured.	<ul style="list-style-type: none">- Input cable is connected to incorrect input terminal.- Erroneous key setting to input terminal	<ul style="list-style-type: none">- Connect the input cable to the correct input terminal.- Set keys correctly.

8.2 Calibration

This section describes how to calibrate your R6551/R6551EMC. To maintain the measurement accuracy, calibrate this equipment at least once in the guarantee period (one year).

This equipment can be calibrated for measurement of DC and AC voltage and current in each range using keys on the front panel and GPIB programs.

8.2.1 Preparation

(1) Power Supply

The power supply of this equipment must fall within the range (90V to 110V, 103V to 132V, 198V to 242V, 207V to 250V) specified on the front panel. The line frequency must be 50 or 60Hz.

(2) Environment

Calibrate this equipment in the following environment in a place without dust, vibration, and noise:

Temperature: +23°C ±3°C
Humidity : 85% or less

(3) Warm-up

Warm up this equipment for an hour or more before starting calibration. Warm up each standard equipment for calibration for the specified period of time, too.

R6551
DIGITAL MULTIMETER
INSTRUCTION MANUAL

8.2 Calibration

(4) Equipments for Calibration

Equipment to be used in calibration is listed in Table 8-2.

Table 8 - 2 Equipments for Calibration

Standard equipment	Working range	Accuracy
Standard DC voltage generator	300mV to 1000V	±0.001%
Standard AC voltage generator	30mVrms to 700Vrms, 1kHz	±0.02%
Standard DC current generator	300mA to 3000mA	±0.03%
Standard AC current generator	30mArms to 3000mArms, 1kHz	±0.03%
Standard resistor	300Ω to 3000 kΩ	±0.001%
	30 MΩ	±0.003%
	300 MΩ	±0.01%

R6551
DIGITAL MULTIMETER
INSTRUCTION MANUAL

8.2 Calibration

8.2.2 Calibration Method

This instrument must be calibrated in every range for each measuring function. Calibrate it at the zero and full-scale points for DC voltage/current and resistance measurement, 1/10 full-scale, full-scale, and high frequency measurement points for AC voltage measurement, and 1/10 full-scale and full-scale points for AC current measurement. See Table 8-3 for calibration items and their respective recommended input values.

Table 8 - 3 Calibration Items and Recommended Input Values

Measurement item	Range	Recommended input value		
		Zero	Full-scale	1/10 full-scale
DC voltage (VDC)	300mV	0 (Short-circuited)	300mV	-
	3000mV		±3000mV	-
	30V		30V	-
	300V		300V	-
	1000V		1000V	-
DC current (ADC)	300mA	0 (Open)	300mA	-
	3000mA		3000mA	-
AC voltage (VAC)	300mV	-	300mV 1kHz	30mV 1kHz
	3000mV	-	3000mV 1kHz	300mV 1kHz
	30 V	-	30 V 1kHz	3000mV 1kHz
	300 V	-	300 V 1kHz	30 V 1kHz
	700 V	-	700 V 1kHz	70 V 1kHz
AC current (AAC)	300mA	-	300mA 1kHz	30mA 1kHz
	3000mA	-	3000mA 1kHz	300mA 1kHz
2W resistance (2WΩ)	300Ω	0 (Short-circuited)	300Ω	-
	3000Ω		3000Ω	-
	30kΩ		30kΩ	-
	300kΩ		300kΩ	-
	3000kΩ		3000kΩ	-
	30MΩ		30MΩ	-
4W resistance (4WΩ)	300Ω	0 (Short-circuited)	300Ω	-
	3000Ω		3000Ω	-
	30kΩ		30kΩ	-
	300kΩ		300kΩ	-
	3000kΩ		3000kΩ	-
	30MΩ		30MΩ	-

Note: The bar "-" indicates that no calibration is necessary for the corresponding item.

R6551
DIGITAL MULTIMETER
INSTRUCTION MANUAL

8.2 Calibration

The following procedure shows how to perform calibration. Calibration for only a particular range of a particular function is effective. Start calibration from the 3000mV range for DC voltage measurement. See Table 8-3 for calibration for other functions.

(1) Setting a Calibration Mode

Press the CAL switch on the rear panel. Then the display flashes to indicate that this equipment has entered the calibration mode.

In this mode, display in up to 5 1/2 digits is set, the NULL operation function is off, and the sampling rate is set to SLOW.

(2) Setting a Calibration Function

Press one of keys $\overset{\text{V DC}}{\boxed{\text{=}}}$ $\overset{\text{V AC}}{\boxed{\text{=}}}$ $\overset{\text{2W } \Omega}{\boxed{\text{=}}}$ $\overset{\text{4W } \Omega}{\boxed{\text{=}}}$ $\overset{\text{A DC}}{\boxed{\text{=}}}$ and $\overset{\text{A AC}}{\boxed{\text{=}}}$ to select the corresponding calibration function.

(3) Setting a Calibration Range

Set the range in which calibration is made using $\overset{\text{DOWN}}{\boxed{\text{=}}}$ and $\overset{\text{UP}}{\boxed{\text{=}}}$.

(4) Calibration for Each Range

① Input where setting for function and range are completed.

② Press $\overset{\text{SHIFT}}{\square}$. Then the changeable digits stop flashing.

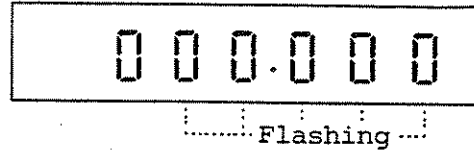

③ Pressing $\overset{\text{AUTO}}{\square}$ causes the changeable digit moves to the right cyclically.

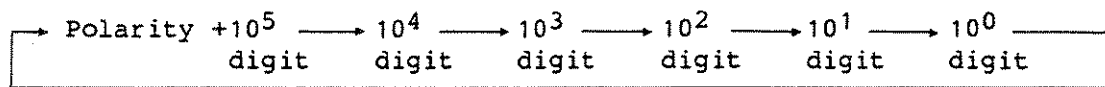

④ Pressing $\overset{\text{UP}}{\square}$ causes numeric characters to change as below.

Pressing $\overset{\text{DOWN}}{\square}$ causes them to change in reverse.

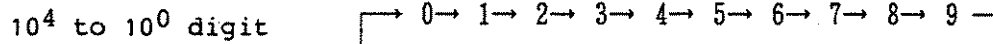
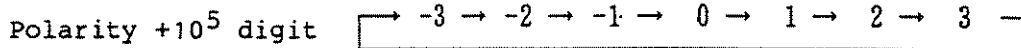

⑤ Steps ③ and ④ sets input values on the display.

⑥ Press $\overset{\text{SHIFT}}{\square}$ to execute calibration with the display on the right to indicate that this equipment is under calibration.

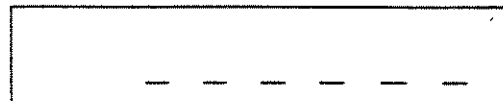

⑦ On completion of calibration, the display restarts flashing.

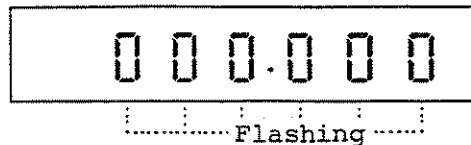

(5) Canceling the Calibration Mode

Press the CAL switch on the rear panel to turn it off. Then this equipment returns to the ordinary measurement state in the last calibrated function range.

(6) Canceling the Shift Mode During Calibration for Each range

To cancel the shift mode (with digits other than changeable ones flashing) when the calibration is on, press ^{NULL} . Then all the digits start flashing.

(7) Calibration Via GPIB

Start this calibration after turning the CAL switch on.

① Zero and Scale Calibration in Each Range

Command PC dddddd (dddddd consisting of up to six digits without decimal point and polarity) causes calibration to the value represented by dddddd. (For example, PC300000 causes 3V input to be calibrated to 3000.00mV.)



8.2.3 Sample Calibrations

Example 8-1: Calibration in 3000mV range for VDC function

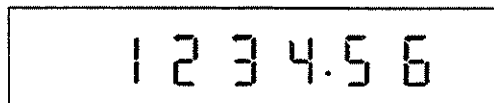
① Press the CAL switch to set the calibration mode.







All digits flashing

② Press ^{V DC}  to select the VDC function and press ^{DOWN}  and ^{UP}  to set the 3000mV range.

③ Short-circuit input and press ^{SHIFT} .



Flashing

④ Make sure that the display is cleared to zero, and press ^{SHIFT}  again. If it is not zero, set the display to zero using ^{AUTO}  ^{DOWN}  and ^{UP}  before pressing ^{SHIFT} .

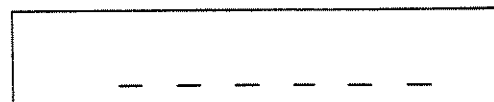

Indication during calibration

The display returns to the all-digit flashing state a few seconds later.

R6551
DIGITAL MULTIMETER
INSTRUCTION MANUAL

8.2 Calibration

- ⑤ Enter VDC and +30000mV and press
SHIFT
[] .

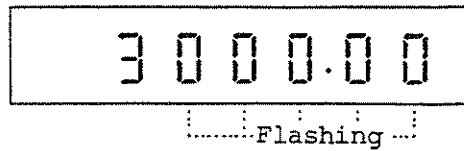

3 0 0 0 . 0 0
Flashing

- ⑥ Set the display to the calibration
value (e.g., 3000.05mV) of the
standard DC voltage generator using
AUTO DOWN UP
[] [] and [] .

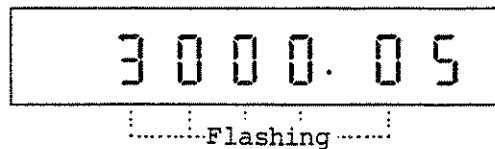

3 0 0 0 . 0 5
Flashing

- ⑦ Press SHIFT
[] . The display tells
that calibration is being executed
and returns to the all-digit
flashing state a few seconds later.

- ⑧ Enter VDC and -3000mV, then press
SHIFT
[] .

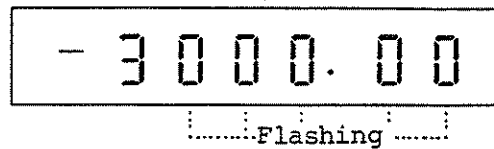

- 3 0 0 0 . 0 0
Flashing

- ⑨ Set the display to the calibration
value (e.g., -3000.03mV) of the
standard DC voltage generator using
AUTO DOWN UP
[] [] and [] .

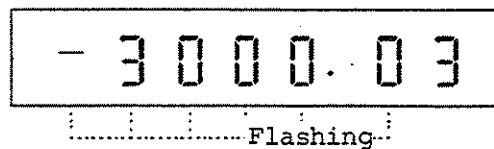

- 3 0 0 0 . 0 3
Flashing

- ⑩ Press SHIFT
[] . The display tells
that calibration is being executed
and returns to the all-digit
flashing state a few seconds later.

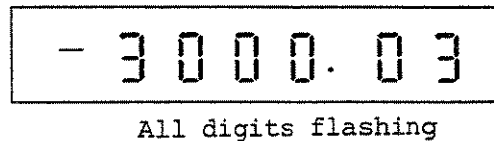

- 3 0 0 0 . 0 3
All digits flashing

- ⑪ Press the CAL switch to cancel
the calibration mode and end the
calibration.

Example 8-2: Calibration for ACV function

- ① Press $\overline{\text{E3}}$ ^{V AC}, and set the range (e.g., 3000mV range) to be calibrated using $\overline{\text{DOWN}}$ and $\overline{\text{UP}}$.
- ② Press the CAL switch to set the calibration mode.

0 0 0 0 . 0 0

All digits flashing

- ③ Calibration of 1/10FS
- Enter VAC 300mV, 1kHz.

0 3 0 0 . 0 5

All digits flashing

- Press $\overline{\text{SHIFT}}$.

0 3 0 0 . 0 0

Flashing

- Set the display to the calibration value (e.g., 300.02mV) of the standard AC voltage generator using

$\overline{\text{E3}}$ $\overline{\text{DOWN}}$ and $\overline{\text{UP}}$.

0 3 0 0 . 0 2

Flashing

- Press $\overline{\text{SHIFT}}$.

Executing → calibration

— — — — —

The display indicates that calibration is being executed and it returns to the all-digit flashing state on completion of the calibration.

0 3 0 0 . 0 2

All digits flashing

- ④ Calibration of F.S.
- Enter VAC 3000mV, 1kHz.

3 0 0 0 . 0 8

All digits flashing

- Press $\overline{\text{SHIFT}}$.

3 0 0 0 . 0 0

Flashing

- Set the display to the calibration value (e.g., 3000.10mV) of the standard AC voltage generator using

$\overline{\text{E3}}$ $\overline{\text{DOWN}}$ and $\overline{\text{UP}}$.

3 0 0 0 . 1 0

Flashing

R6551
DIGITAL MULTIMETER
INSTRUCTION MANUAL

8.2 Calibration

- Press ^{SHIFT} .

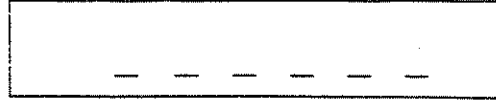

The display indicates that calibration is being executed and it returns to the all-digit flashing state on completion of the calibration.



All digits flashing

- ⑤ Press the CAL switch to cancel the calibration mode. Then this equipment returns to the ordinary measurement mode.

R6551
DIGITAL MULTIMETER
INSTRUCTION MANUAL

9.1 Outline of R6551/R6551EMC Operation

9. DESCRIPTION OF R6551/R6551EMC OPERATION

This chapter summarizes the principle of operation of the R6551/R6551EMC.

9.1 Outline of R6551/R6551EMC Operation

This equipment digital multimeter incorporates a 5 1/2-digit AD converter under microcomputer control. To keep high measurement accuracy, R6551 uses thin film resistors developed by ADVANTEST to provide stable amplification of the input attenuator and ranging amplifier.

This equipment consists of the following blocks:

- Attenuator which divides DC and AC voltage into 1/1, 1/100, and 1/1000
- Switch to select input depending on voltage, resistance, and current measurement
- Ranging amplifier which regulates input to the AD converter to 3000mV (full scale)
- AC/DC converter which converts AC to DC voltage
- AD converter which digitizes analog voltage
- OHM/DC converter which passes reference current to a measured resistor in resistance measurement
- Current/voltage converter which converts measured current into voltage using shunt resistance in current measurement
- Function/range control for ranges of each function
- LED display block to indicate the results of measurement
- Standard voltage generator
- Optical isolator which communicates data between the analog system and microcomputer
- Microcomputer which manages the entire equipment
- Power supply

A DC voltage to be measured enters the attenuator from the input terminal (between V and COM). The input voltage is divided at the attenuation ratio set by the function and range controller unit.

The ranging amplifier outputs input voltage and zero voltage alternately to the AD converter. This output method is generally called auto zero method, which corrects the offset voltage of amplifiers (ranging amplifier and the one used for the AD converter). The amplifier degree of not only the attenuator but also the ranging amplifier is set at the range controller unit.

The AD converter converts analog output from the ranging amplifier into digital form by integration. Converted data is transferred to the CPU for controlling the system and displayed on the LED display block. At the same time, the data is output to the range control unit to check for range setting. If an improper range has been set, the function and range controller unit shifts the range up or down until a proper range is selected.

R6551
DIGITAL MULTIMETER
INSTRUCTION MANUAL

9.1 Outline of R6551/R6551EMC Operation

Resistance, AC voltage, and AC or DC current are measured respectively by the OHM/DC converter, AC/DC converter, and AD converter in the same way as for the above DC voltage measurement.

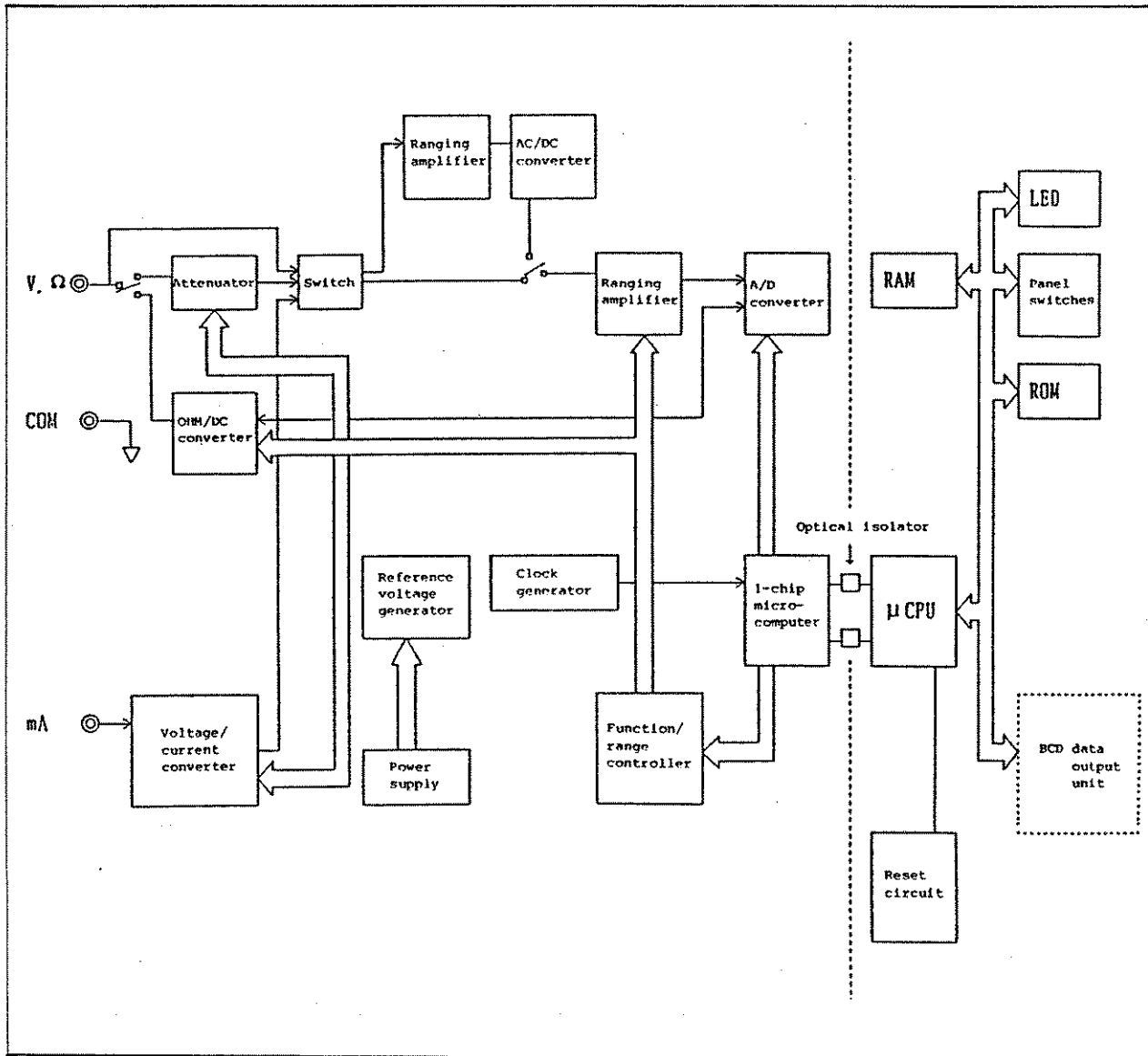

Figure 9 - 1 R6551/R6551EMC Block Diagram

9.2 AD Converter

This equipment incorporates an AD converter of a variable input integration type. The AD converter can select input integration time 100ms, 20ms (at commercial line frequency of 50Hz), or 2ms. Thereby, the AD converter allows stable measurement and high-speed sampling at a high noise elimination ratio to be set to meet the measurement purpose. Figure 9-2 outlines the operation of the AD converter.

When S1 comes on and input voltage V_{in} is integrated, the converter turns S2 on after a certain period of time if the output value from the integrator is negative. At the same time, it applies reference voltage V_{ref} to the integrator until the output value from the integrator is inverted to be positive. The converter measures the time taken for this inversion. It repeats the above operation for the selected input integration time, and it turns S1 off when the integrator turns positive, after integration is finished. The polarity of the integrator is checked by output of the comparator U2 connected to the output of the integrator.

Calculation of the total time while S2 is left on results in AD converted data. This AD converted data allows display values and computed data to be digitally output based on calibration data for zero and full-scale input set at calibration time as the reference value.

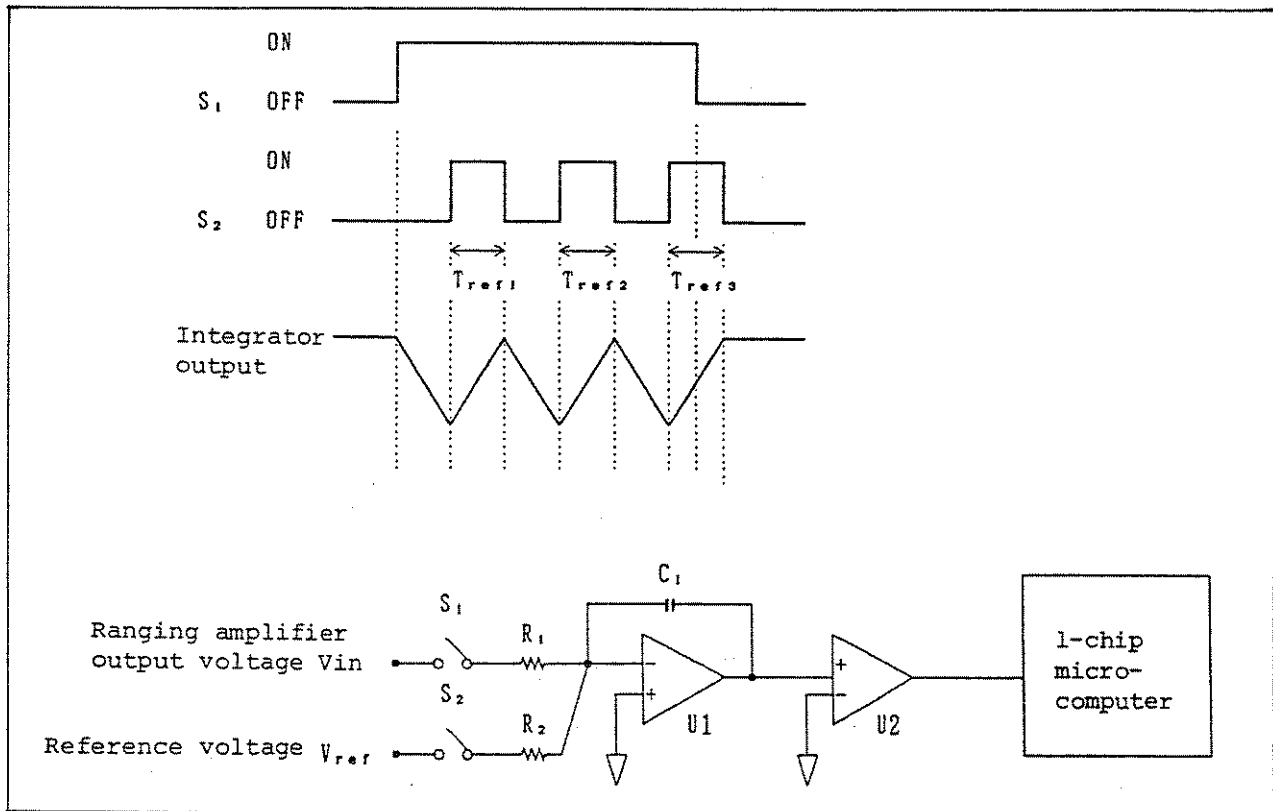
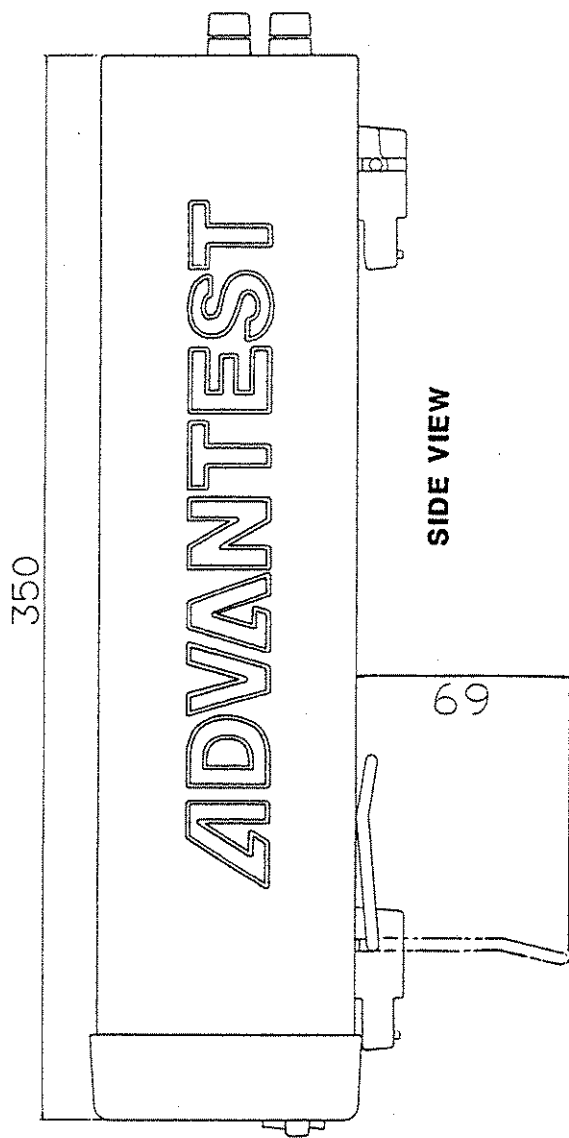
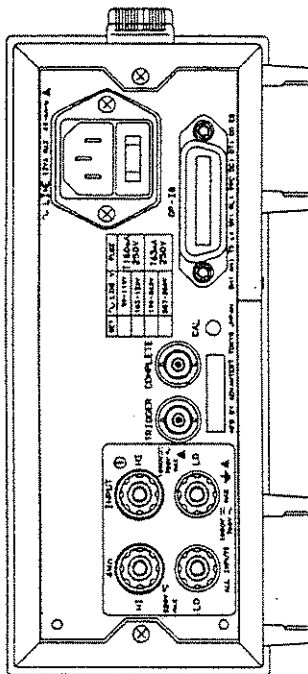
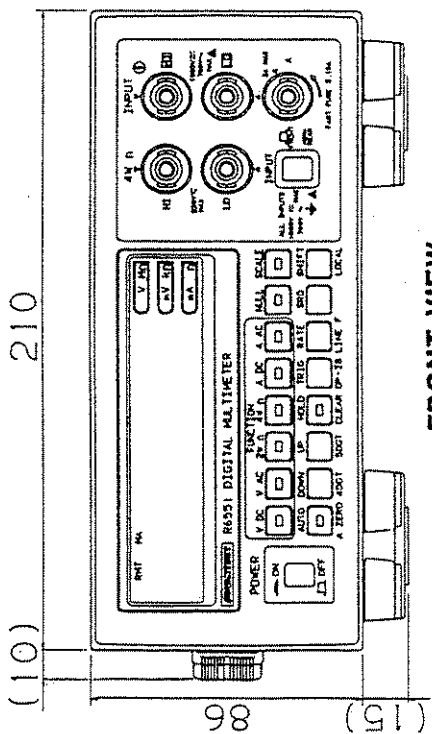

Figure 9 - 2 Outline of AD Converter Operation



Unit : mm



**R6551
EXTERNAL VIEW**

R6551EXT1-9008-B

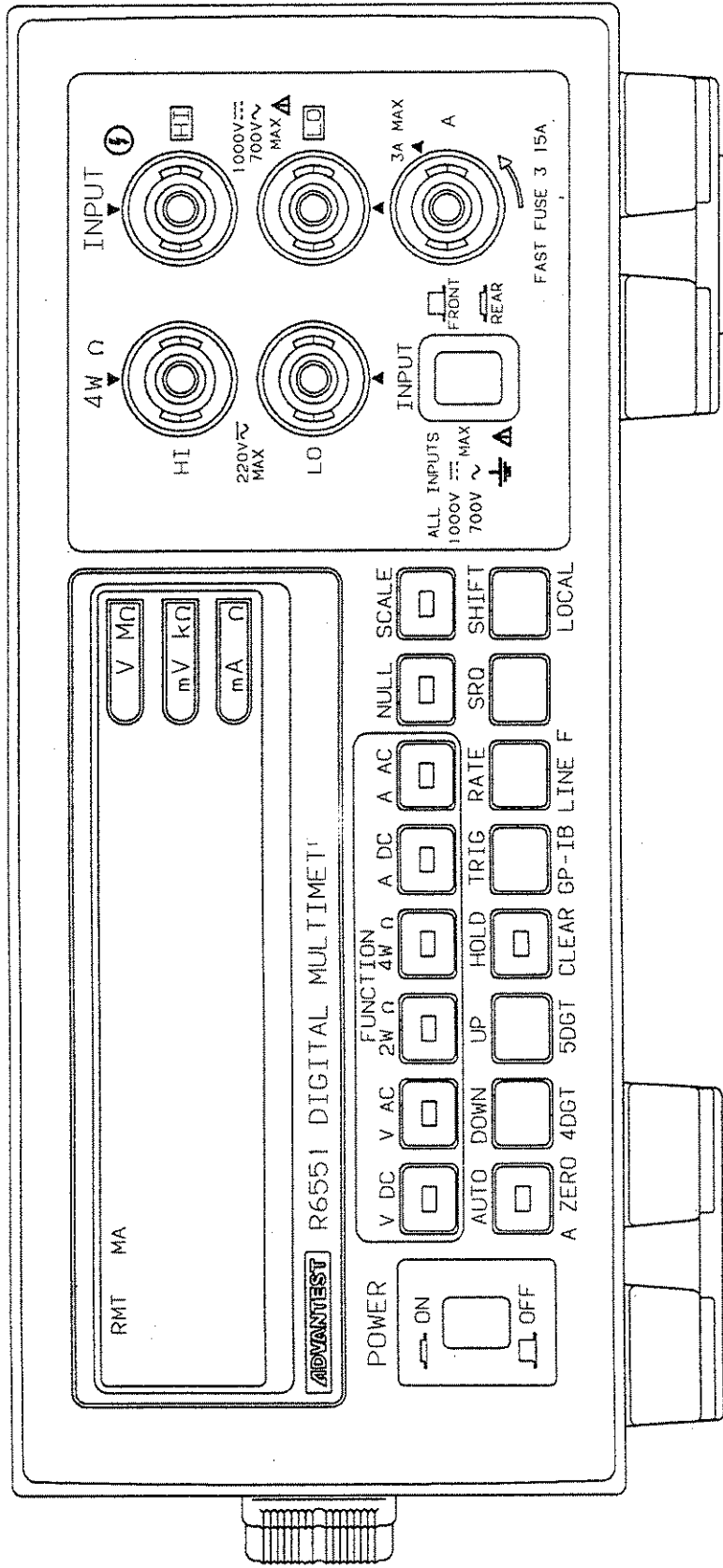

R6551 FRONT VIEW

R6551EXT2-8806-A

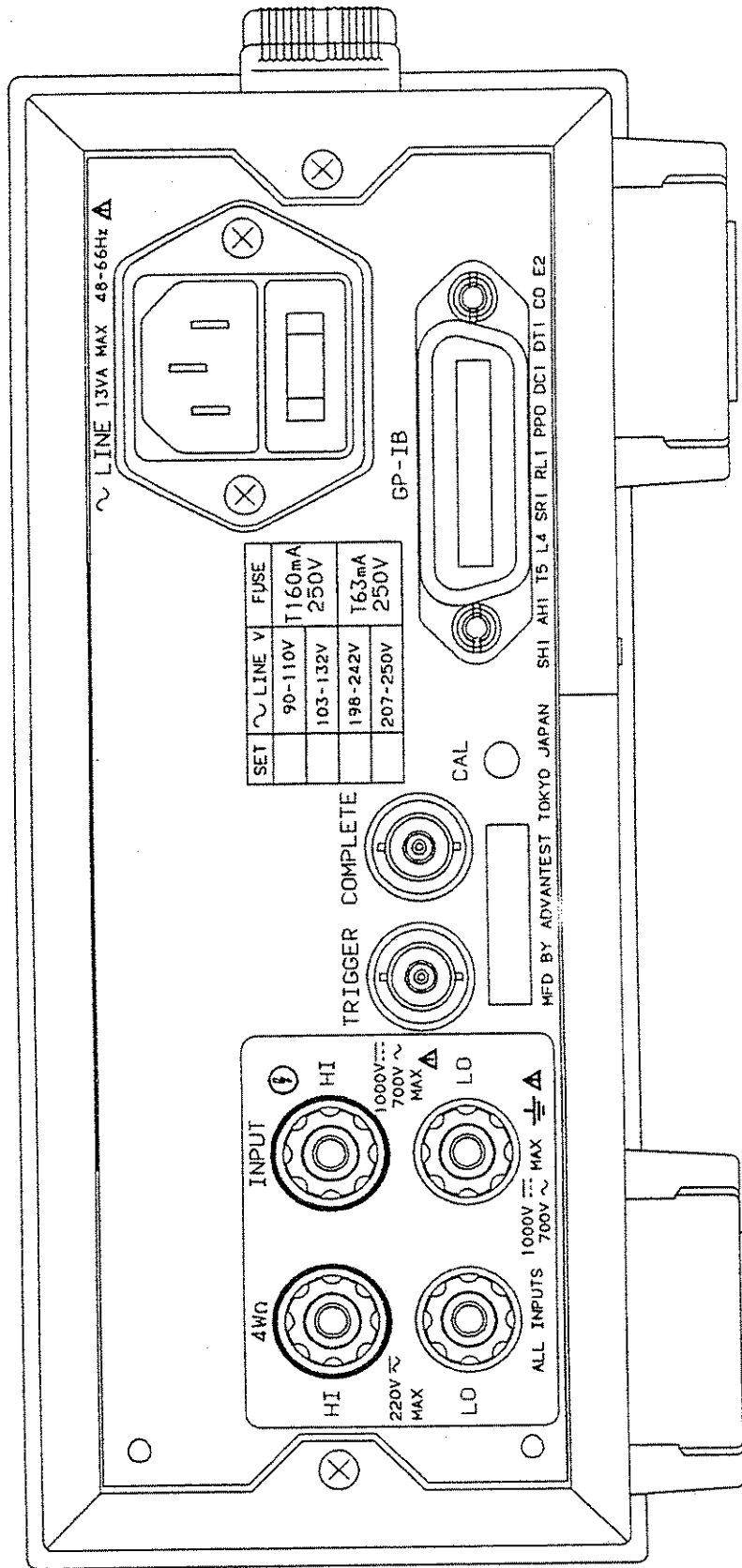

R6551 REAR VIEW

R6551EXT3-9008-B

(10)

210

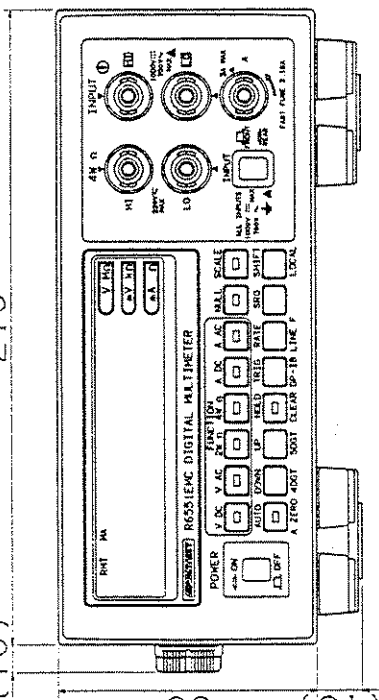

350

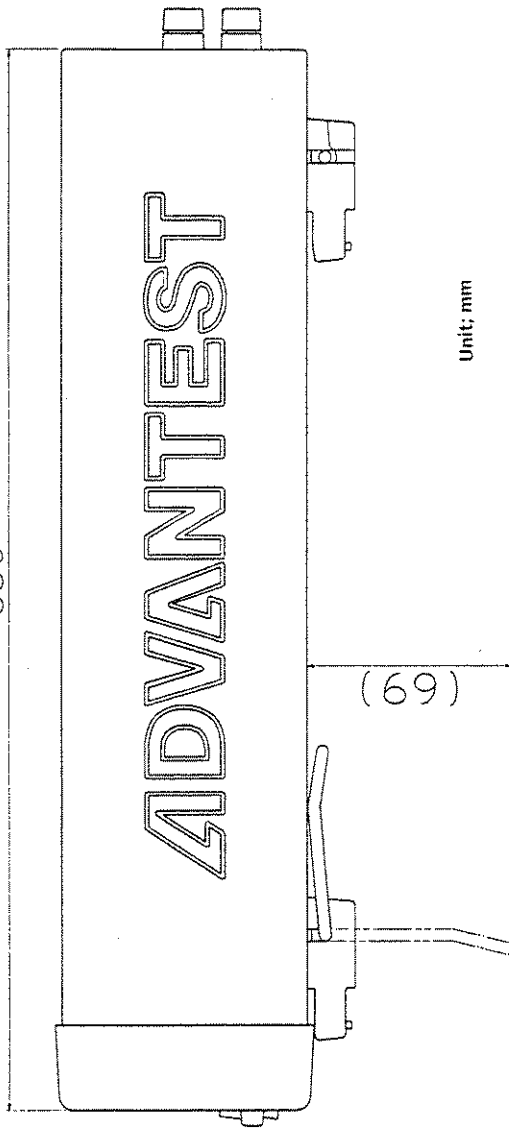

Unit: mm

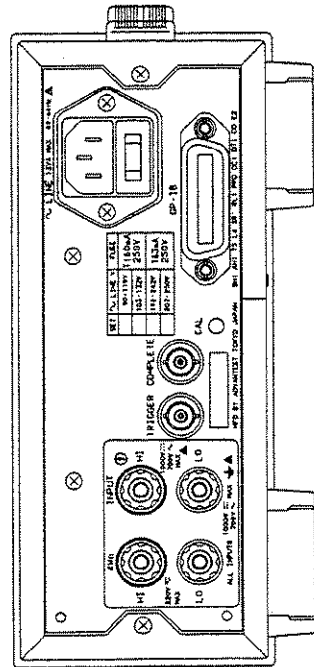

R6551EMC
EXTERNAL VIEW

R6551EMCXT4-9203-A

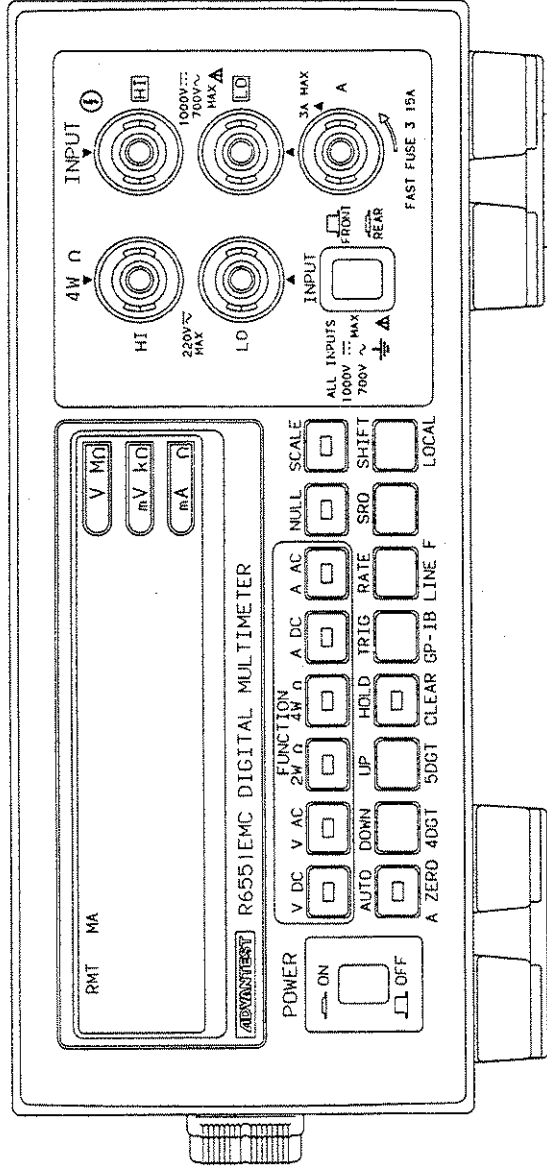

R6551EMC FRONT VIEW

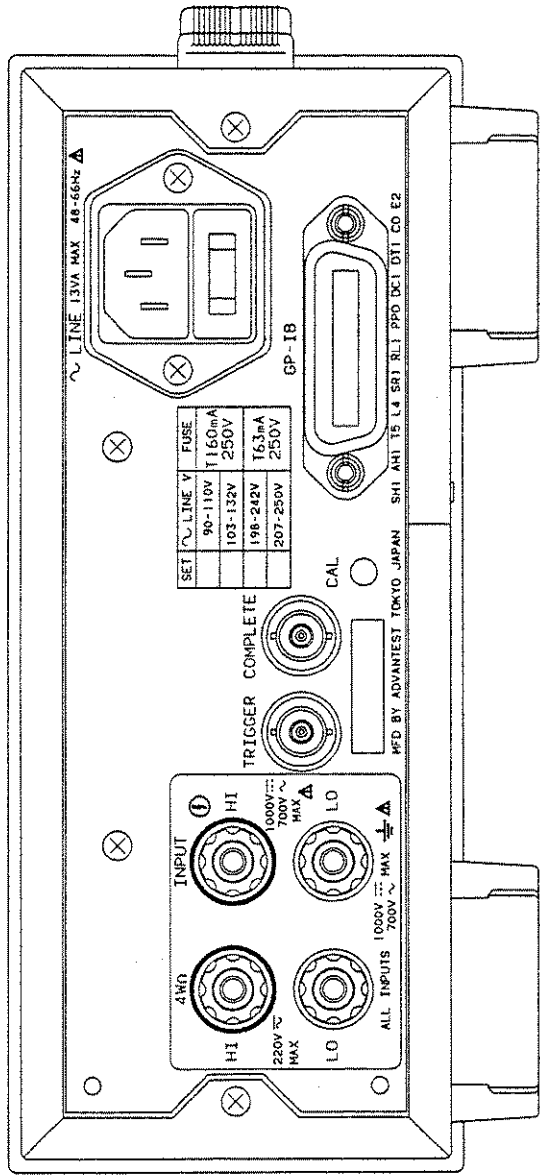

**R6551EMC
REAR VIEW**

R6551
DIGITAL MULTIMETER
INSTRUCTION MANUAL

Index

INDEX

<p style="text-align: center;">[2]</p> <p>2WΩ key 2 - 1</p> <p style="text-align: center;">[4]</p> <p>4WΩ key 2 - 2</p> <p>4WΩ HI Terminal 2 - 7</p> <p>4WΩ HI Terminal 2 - 9</p> <p>4WΩ LO Terminal 2 - 7</p> <p>4WΩ LO Terminal 2 - 9</p> <p style="text-align: center;">[A]</p> <p>A AC key 2 - 2</p> <p>A DC key 2 - 2</p> <p>A HI Terminal 2 - 7</p> <p>Accessories Supplied 1 - 4</p> <p>Accessories 7 - 9</p> <p>AD Converter 9 - 3</p> <p>Address Codes 5 - 5</p> <p>Address Setting 5 - 5</p> <p>Ambient Operating Environment 1 - 5</p> <p>AUTO/A ZERO Key 2 - 2</p> <p style="text-align: center;">[B]</p> <p>BCD Data Output Codes 6 - 2</p> <p>BCD Output Connector 6 - 3</p> <p>BCD OUTPUT 6 - 1</p> <p>Binary Output Format 5 - 10</p> <p>Block Diagram 9 - 2</p> <p style="text-align: center;">[C]</p> <p>CAL Switch 2 - 11</p> <p>Calibration Method 8 - 4</p> <p>Calibration 8 - 2</p> <p>Check Items 8 - 1</p> <p>Command Codes 5 - 17</p> <p>COMPLETE Connector 2 - 10</p> <p>Connection to Digital Recorder 6 - 5</p> <p>Connection 6 - 5</p>	<p style="text-align: center;">[D]</p> <p>Data Format 5 - 7</p> <p>Data Output Code 6 - 2</p> <p>Data Output Connector 6 - 2</p> <p>Delimiter 5 - 10</p> <p>DESCRIPTION OF R6551 OPERATION 9 - 1</p> <p>Digital Display 2 - 1</p> <p style="text-align: center;">[E]</p> <p>Error Messages 4 - 4</p> <p>Exponent Parts 5 - 8</p> <p style="text-align: center;">[F]</p> <p>Front Panel 2 - 1</p> <p>FRONT/REAR Selector Switch 2 - 8</p> <p>Fuse Holder 2 - 10</p> <p>Fuses 1 - 8</p> <p style="text-align: center;">[G]</p> <p>General 1 - 2</p> <p>GPiB Connector Pin Assignment 5 - 2</p> <p>GPiB Connector 2 - 10</p> <p>GPiB INTERFACE 5 - 1</p> <p>GPiB Specifications 5 - 2</p> <p style="text-align: center;">[H]</p> <p>Header ON/OFF Selection 5 - 5</p> <p>Header Types 5 - 7</p> <p>HOLD/CLEAR Key 2 - 3</p> <p style="text-align: center;">[I]</p> <p>Inhibiting Unnecessary Measuring Functions 4 - 7</p> <p>Input Cable 1 - 7</p> <p>INPUT Terminal HI 2 - 6</p> <p>INPUT Terminal HI 2 - 9</p> <p>INPUT Terminal LO 2 - 7</p> <p>INPUT Terminal LO 2 - 9</p> <p>Interconnecting GPiB System Components 5 - 4</p> <p>Interface Functions 5 - 3</p>
---	---

R6551
DIGITAL MULTIMETER
INSTRUCTION MANUAL

Index

[L]		Service Request	5 - 14
Listener Specification	5 - 11	Set a line frequency	3 - 4
[M]		Set the address	3 - 3
MA Indicator	2 - 1	Set the header	3 - 3
Main Header	5 - 7	Set the number of digits to be displayed	3 - 1
Mantissa	5 - 8	Set to initial values	3 - 2
Measuring Timing	6 - 6	Setting a Line Frequency	4 - 1
Messages	4 - 3	SHIFT/LOCAL Key	2 - 4
[N]		Specification	7 - 1
NULL Key	2 - 6	SRQ	5 - 14
NULL Operation	4 - 5	SRQ Key	2 - 4
[O]		Storage	1 - 5
Operation Flowchart	5 - 26	Sub-header	5 - 7
Option	7 - 9	[T]	
Option01	6 - 1	Talker Specification	5 - 7
Outline of AD Converter Operation ..	9 - 3	TR6198	6 - 5
Output Format	5 - 10	TRIG/GP-IB Key	2 - 3
Over Range Message	4 - 3	TRIGGER Connector	2 - 9
[P]		Troubleshooting	8 - 1
Power Cable	1 - 6	Turning the Power on and Initialization	4 - 2
Power Connector	2 - 10	[U]	
POWER Switch	2 - 1	Unit Display	2 - 1
Program Codes	5 - 11	[V]	
[R]		V AC key	2 - 1
Range DOWN/4DGT Key	2 - 2	V DC key	2 - 1
Range UP/5DGT Key	2 - 3	[W]	
RATE/LINE Key	2 - 4	Warm-up	8 - 2
Rear Panel	2 - 9	Warming Up	1 - 5
REMOTE Indicator	2 - 1		
[S]			
Sample Programs	5 - 20		
Sampling Indicator	2 - 1		
SCALE Key	2 - 6		
SCALE Operation	4 - 6		
Selection of Mesuring Functions	4 - 7		

WARRANTY

ADVANTEST product is warranted against defects in material and workmanship for a period of one year from the date of delivery to original buyer.

LIMITATION OF WARRANTY

The foregoing warranty shall not apply to defects resulting from improper or inadequate maintenance by buyer, unauthorized modification or misuse, accident or abnormal conditions of operations.

No other warranty is expressed or implied. ADVANTEST specifically disclaims the implied warranties of merchantability and fitness for a particular purpose.

ADVANTEST shall not be liable for any special incidental or consequential damages, whether in contract, tort or otherwise.

Any and all warranties are revoked if the product is removed from the country in which it was originally purchased.

SERVICE

During the warranty period, ADVANTEST will, at its option, either repair or replace products which prove to be defective.

When trouble occurs, buyer should contact his local supplier or ADVANTEST giving full details of the problem and the model name and serial number.

For the products returned to ADVANTEST for warranty service, buyer shall prepay shipping and transportation charges to ADVANTEST and ADVANTEST shall pay shipping and transportation charges to return the product to buyer. However, buyer shall pay all charges, duties, and taxes incurred in his country for products returned from ADVANTEST.

CLAIM FOR DAMAGE IN SHIPMENT TO ORIGINAL BUYER

The product should be thoroughly inspected immediately upon original delivery to buyer. All material in the container should be checked against the enclosed packing list or the instruction manual alternatively. ADVANTEST will not be responsible for shortage unless notified immediately.

If the product is damaged in any way, a claim should be filed by the buyer with carrier immediately. (To obtain a quotation to repair shipment damage, contact ADVANTEST or the local supplier.) Final claim and negotiations with the carrier must be completed by buyer.

SALES & SUPPORT OFFICES

Advantest(Singapore)Pte.Ltd.

438A Alexandra Road

#08-03/06 Alexandra Technopark Singapore 119967

Phone : 65-274-3100 Facsimile : 65-274-4055

ROHDE & SCHWARZ Engineering and Sales GmbH

Mühdorfstr. 15 (P.O.B. 80 1429, D-81614 München)

D-81671 München, Germany

Phone : 49-89-4129-13711 Facsimile : 49-89-4129-13723

TEKTRONIX INC.

P.O. Box 500, M/S 39-520, Beaverton, Oregon 97077-0001

or

Howard Vollum Industrial Park, M/S 58-743, Beaverton, OR, 97077, U.S.A.

Inside the U.S. 1-800-426-2200

Outside the U.S. 1-503-627-1933

— Technology Support on the Leading Edge —

ADVANTEST[®]

ADVANTEST CORPORATION

Shinjuku-NS Building, 4-1, Nishi-Shinjuku 2-chome, Shinjuku-ku, Tokyo 163-0880, Japan
Phone:+81-3-3342-7500 Facsimile:+81-3-5322-7270 Telex:232-4914 ADVAN J

