

2706

Instructions and Applications

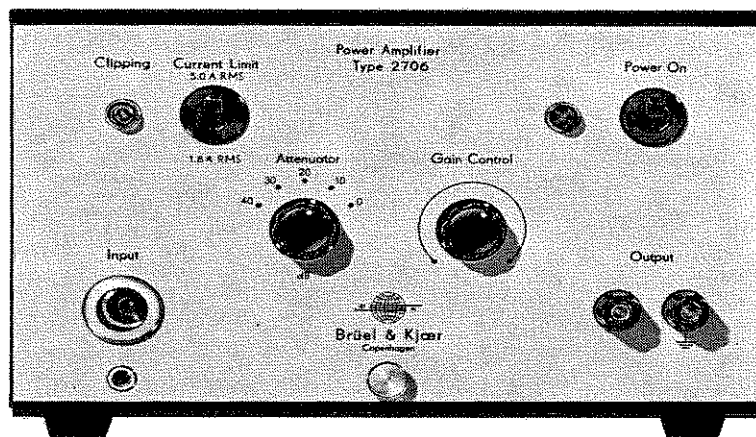

Power Amplifier Type 2706

A low distortion power amplifier for driving small vibration exciters and for general purpose power amplification.

It features protection against short circuited output and excessive temperature. Clipping of the output signal is indicated.

POWER AMPLIFIER TYPE 2706

May 1972

CONTENTS

| | | |
|-----------|---|-----------|
| 1. | INTRODUCTION | 3 |
| 2. | CONTROLS | 4 |
| | 2.1. Front Panel | 4 |
| | 2.2. Rear Panel | 5 |
| 3. | OPERATION | 7 |
| 4. | DESCRIPTION | 8 |
| | 4.1. Attenuators and Preamplifier | 8 |
| | 4.2. Differential amplifier and power amplifier | 9 |
| | 4.3. Current limiters and clipping detector | 9 |
| | 4.4. Temperature protection | 9 |
| | 4.5. Characteristics | 10 |
| | Power output capacity | 10 |
| | Distortion | 12 |
| | Noise and Hum | 12 |
| 5. | APPLICATIONS | 14 |
| | 5.1. Generals | 14 |
| | 5.2. Use with the B & K Vibration Exciters | 14 |
| | Accelerometer calibration | 15 |
| | Vibration testing | 16 |
| | 5.3. Use with the Reverberation Processor Type 4422 | 16 |
| | 5.4. General use in Acoustics | 17 |
| 6. | SPECIFICATIONS | 19 |

1. INTRODUCTION

The Power Amplifier Type 2706 has been designed to drive small vibration exciters, particularly the B & K Vibration Exciter Type 4809. By switching to the 1.8 Amp. RMS output current limit, it is possible to drive the Mini Shaker Type 4810 safely at full rating.

Power capacity of Type 2706 is 75 VA into a $3\ \Omega$ load. The overall voltage gain is 40 dB, and input attenuators allow to adjust the level at a desired value when no level adjustment is available on the signal source, which makes it ideal for use with the Reverberation Processor Type 4422.

Its very low harmonic distortion and low noise level make it suitable for a wide range of applications in vibration and acoustics.

Type 2706 is fully protected against short circuited output and excessive heat sink temperature. When clipping of the output level occurs, a warning lamp is lit.

2. CONTROLS

2.1. FRONT PANEL

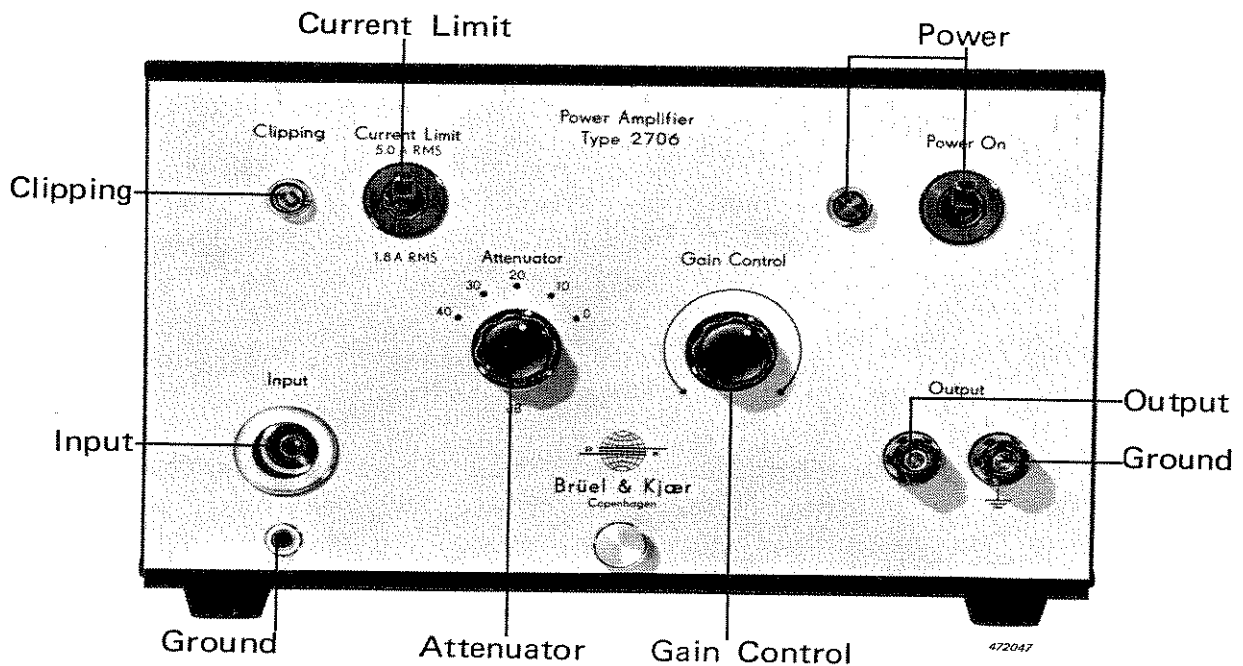

Fig.2.1. Front Panel of 2706

POWER ON:

On/off switch for mains supply. When the instrument is powered, the white lamp to the left of the switch is lit.

INPUT:

Coaxial socket input accepting standard B & K coaxial plug JP 0101. Input impedance is 15 k Ω .

ATTENUATOR:

For attenuation of input signal in 10 dB steps, from 0 to 40 dB.

GAIN CONTROL: A logarithmic potentiometer allowing continuous attenuation of the signal down to 0 V. Gives 0 dB attenuation when turned fully clockwise.

CURRENT LIMIT: A two position switch for presetting output current limit to either "5.0 A RMS" or "1.8 A RMS". These two values are the current ratings of the B & K Vibration Exciter Type 4809 and Mini Shaker Type 4810 respectively.

CLIPPING: An amber warning lamp which indicates that output current exceeds the limit set by the CURRENT LIMIT switch or that output voltage exceeds 15 V RMS, and that output signal is clipped. The amplifier will continue to operate. However, input level must be reduced or attenuated to resume operation with a good waveform.

OUTPUT: Output terminals for connection to the load. The right-hand terminal is ground. Output impedance is less than 0.04 Ω between 10 Hz and 5 kHz and less than 0.08 Ω from 5 kHz to 20 kHz.

2.2. REAR PANEL

VOLTAGE SELECTOR

For selection of correct mains supply voltage, unscrew the central fuse, remove the black selector bush, insert the pin associated to the window on the bush in the socket corresponding to the desired mains voltage and plug it fully in. The correct mains voltage should now appear in the window. The fuse is 250 V, 1 A rated.

POWER SOCKET:

Socket for connection of AC mains supply. For connections see Fig.2.3.

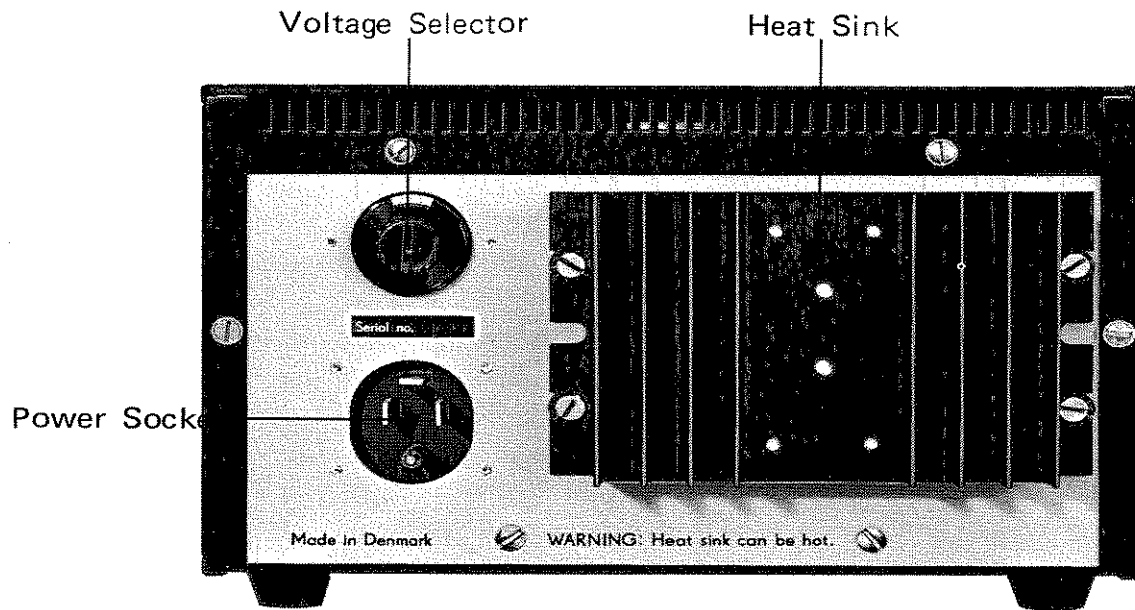

Fig.2.2. Rear Panel of 2706

472048

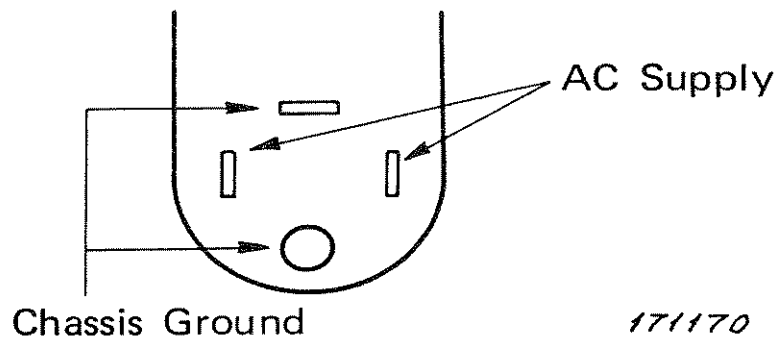

Fig.2.3. AC Power Socket

171170

3. OPERATION

Before the instrument is switched on, ensure the voltage selector is set to the correct line voltage. If not, unscrew the central fuse, remove the black selector bush, insert the pin in the socket corresponding to the desired mains voltage and push it fully in. The correct mains voltage should now appear in the window.

Ensure that air can circulate normally around the heat sink. The Power Amplifier should not be placed in a closed volume such as a box, etc. The heat sink can be warm (typically 80°C). Care should be taken not to leave temperature sensitive objects (e.g. cables) in contact with it.

Connect the signal source to the INPUT of the Power Amplifier, and connect the load to the OUTPUT terminals. Feed the signal to be amplified to the 2706, and adjust the ATTENUATOR and the GAIN CONTROL, and/or the controls on the generator so that the desired output level is obtained. If the CLIPPING lamp is lit, reduce the input level or attenuate further.

If a frequency sweep is to be made, ensure that no clipping occurs throughout the frequency range, especially when the Power Amplifier is to be used in a regulated system.

Care should be taken to avoid ground loops. It is recommended to isolate accelerometers from ground, using an isolated stud and a mica washer, when ground loops are likely to occur.

4. DESCRIPTION

A block diagram of the Power Amplifier Type 2706 is shown in Fig.4.1.

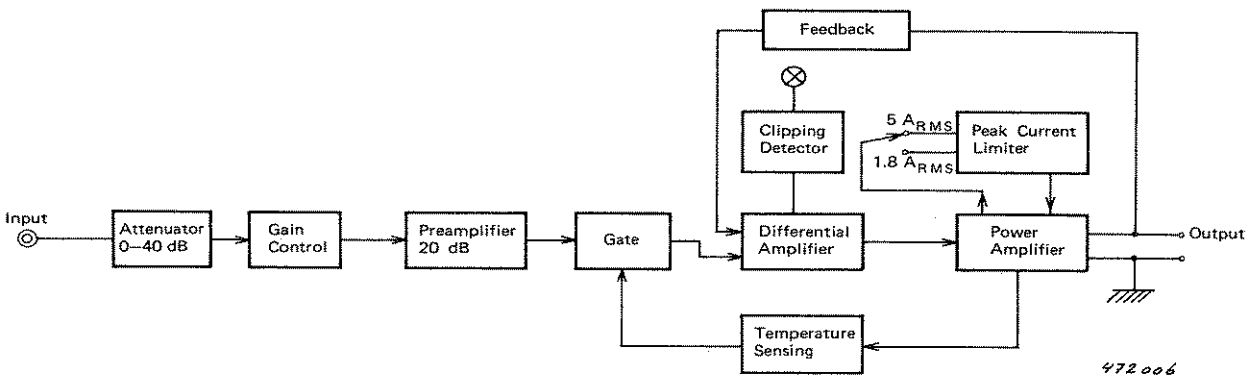

Fig.4.1. Block Diagram of 2706

4.1. ATTENUATORS AND PREAMPLIFIER

The signal is fed to the Power Amplifier via the INPUT socket which accepts the standard B & K coaxial plug JP 0101. The input section itself, including the preamplifier, is DC coupled, but any DC voltage present at the input will not appear in the output voltage as the gate following the input section is AC coupled. The amplifier input impedance is 15 k Ω .

The input leads to the ATTENUATOR which steps down the signal in 10 dB steps to a maximum attenuation of 40 dB. It is followed by the GAIN CONTROL potentiometer which allows continuous adjustment of the voltage down to zero. This is a high resistance logarithmic potentiometer and has no loading effect on the previous attenuator. This means that the amplifier input impedance is independent of the ATTENUATOR and GAIN CONTROL setting. The preamplifier is an operational amplifier with resistive feedback. It has a fixed 20 dB voltage gain.

The signal passes then through a gate which will ground the signal when excessive temperature is reached on the heat sink. See Temperature Protection, section 4.4.

4.2. DIFFERENTIAL AMPLIFIER AND POWER AMPLIFIER

The differential amplifier is of the constant-current source type, which provides high common mode rejection. On one input is applied the signal from the input section, while the other receives feedback from the power section.

The main power amplifier components are two pairs of complementary transistors (MJE 2955 and MJE 3055) working in class AB. The standing current is small, ensuring very low cross-over distortion. The power transistors are placed on a heat sink situated at the back of the instrument (see Fig.2.2). Care should be taken to allow air circulation around the sink. A fifth transistor is placed on the sink for stabilizing purpose. When temperature rises, this transistor will limit the standing current in the power transistors which otherwise would increase too much. On the sink is also placed a thermistor used to trigger the gating circuit (see section 4.4).

At low frequencies, temperature on the sink and in the transistors will follow the current variations, possibly introducing distortion. Two transistors are provided to compensate for this effect. The output of the 2706 is directly coupled in order to avoid the need for a bulky transformer. The gain of the power amplifier together with the differential amplifier is 20 dB, giving an overall voltage gain of 40 dB.

4.3. CURRENT LIMITERS AND CLIPPING DETECTOR

The current limiting circuitry will limit the output current to the selected value of either 1.8 A RMS or 5.0 A RMS. Current limiting is indicated by the CLIPPING lamp. The clipping detector is triggered by excessive instantaneous voltage across either of the DC biased diodes connected to each branch of the differential amplifier. The amber CLIPPING lamp will then be lit. The amplifier will continue to operate, but the input signal must be reduced or further attenuated to resume operation with a good waveform, as clipped signals introduce considerable distortion.

4.4. TEMPERATURE PROTECTION

Abnormal load conditions, high ambient temperatures or short-circuited output could result in output transistor temperatures in excess of design limits and subsequent transistor failure. To prevent such damage, an NTC thermistor is placed on the heat sink together with the power transistors. Its

resistance is $47\text{ k}\Omega$ at 25°C , falling down to $1.2\text{ k}\Omega$ at 125°C . It is part of the base biasing network of the gating transistor. The circuit is shown in Fig.4.2.

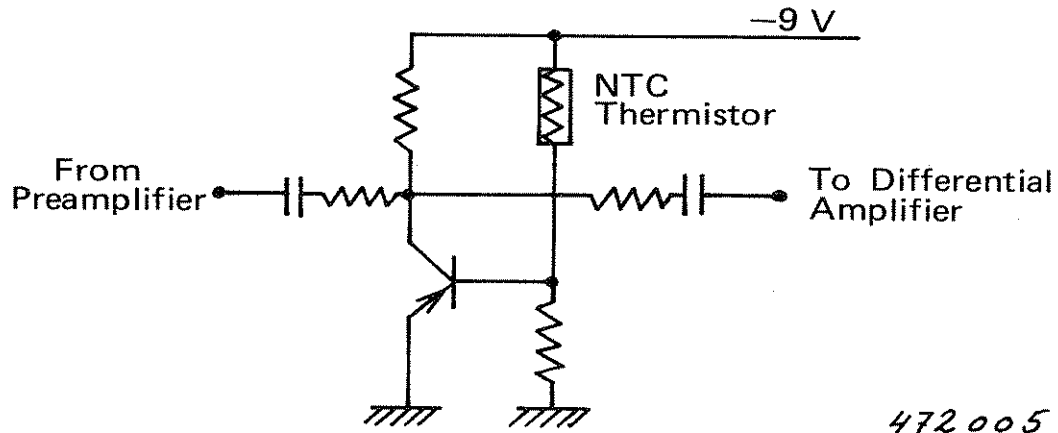

Fig.4.2. Temperature sensitive gating circuit of 2706

For normal working temperatures (around 80°C on the heat sink) the DC collector-emitter voltage is kept to a value allowing AC signals to be passed to the gate output. If temperature rises, the thermistor resistance reduces, causing the base-emitter voltage to increase and therefore the collector-emitter voltage is reduced. This introduces a limitation on the voltage allowed to go pass the gate without clipping (the peak voltage being limited to the collector-emitter voltage). Clipping will be indicated by the CLIPPING lamp. If temperature on the heat sink is increased further up to 125°C , the collector-emitter voltage is reduced to zero and the signal is grounded and therefore does not reach the power section.

When the heat sink temperature reduces, the Power Amplifier will automatically become operative again.

4.5 CHARACTERISTICS

4.5.1. Power output capacity

The overall voltage gain of the Power Amplifier is $40\text{ dB} \pm 1\text{ dB}$ at 1 kHz . Output voltage is limited to 5 Amps RMS or 1.8 Amps RMS . Power output capacity is 75 VA into a $3\ \Omega$ load. For loads above $3\ \Omega$ power is limited by the maximum voltage available (15 Volts RMS). Below $3\ \Omega$, it is limited by

the 5 Amps RMS current limit. It is not recommended to use loads below 2Ω as power dissipation on the heat sink will rise considerably.

When the 1.8 Amps RMS current limit is selected, it does not affect the voltage limit which remains 15 Volts RMS. Maximum power will therefore be available with a load of about 8Ω . The 1.8 Amps RMS limit can be used to drive the Mini-Shaker Type 4810 safely at full rating. Fig.4.3 shows the maximum power available as a function of load resistance for the two current limits.

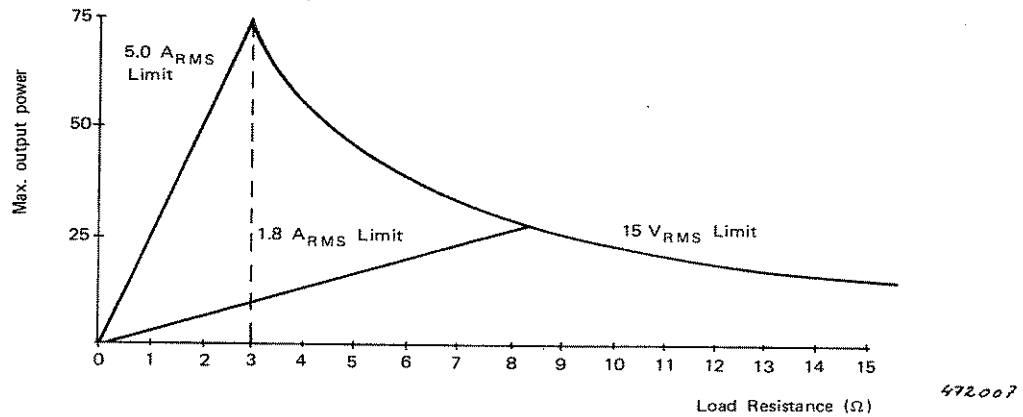

Fig.4.3. Maximum Output Power for both current limits

A typical frequency response curve is shown in Fig.4.4. The specified frequency range of Type 2706 is 10 Hz to 20 kHz (± 0.5 dB).

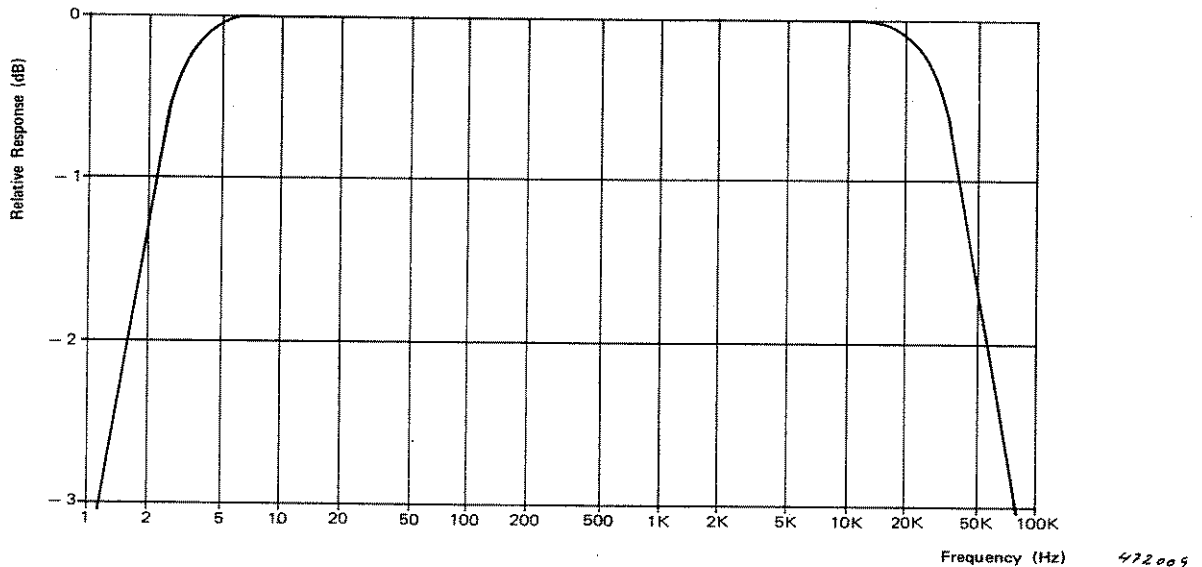

Fig.4.4. Amplifier Frequency Response (10 A RMS into a 2Ω load)

Due to the generous feedback in the power section, output impedance is very low. Fig.4.5 shows the variation of the output impedance with frequency.

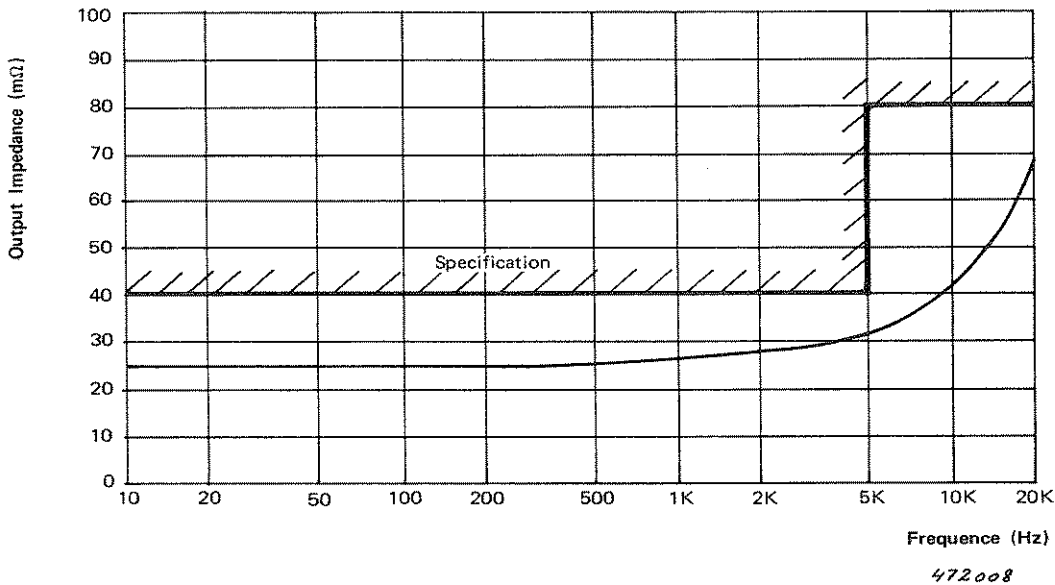

Fig.4.5. Output Impedance

4.5.2. Distortion

Heavy feedback in the power section and use of complementary power transistors working in class AB have resulted in very low harmonic distortion. At full capacity, it will be less than 0.5% over the frequency range 20 Hz to 20 kHz and will be less than 0.2% between 20 Hz and 10 kHz. Typical values at 500 Hz are -66 dB referred to the fundamental for both the second and third harmonics.

4.5.3. Noise and Hum

Careful design has resulted in low noise and hum levels, which should be at least 70 dB below full output (i.e. < 4.75 mV).

A typical frequency analysis of noise and hum with short-circuited input on the 2706 is given in Fig.4.6.

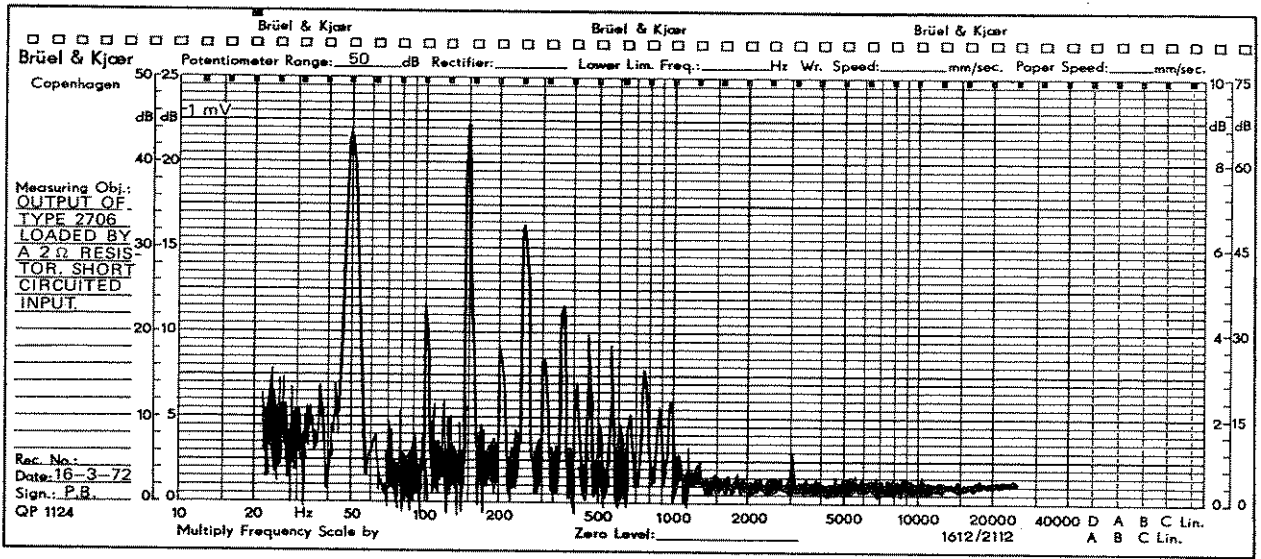

Fig.4.6. Narrow band Frequency analysis of noise and hum. Short circuited input

5. APPLICATIONS

5.1. GENERAL

The Power Amplifier Type 2706 has been designed to drive small vibration exciters, particularly the B & K Vibration Exciter 4809. When switched to the 1.8 A RMS output current limit, it will safely drive the Mini Shaker Type 4810 at full rating. However, the 2706 can be used for general purpose amplification in vibration and acoustics applications.

Some of the devices to be driven by the Power Amplifier could, for many applications, be directly driven by a signal generator (for example the B & K Beat Frequency Oscillator Type 1022), but the low impedance of a shaker or a loudspeaker will cause considerable distortion of the generator output, which may be a problem when measuring a frequency response curve. Also, it may be difficult to get sufficient power. These problems can be solved easily by using the 2706. It will provide the desired power and reduce distortion, as its input impedance ($15\text{ k}\Omega$) will have no loading effect on the generator. Distortion from the generator will therefore be reduced. Since the Power Amplifier Type 2706 itself introduces very little distortion, the output signal will exhibit less distortion than when taken directly from the oscillator.

Measurements on the Mini Shaker Type 4810 directly driven from a generator have shown that the third harmonic level could be only 15 dB below the fundamental. For the same vibration level on the Mini Shaker, use of the Power Amplifier reduces the level of harmonics by at least 20 dB.

5.2. USE WITH THE B & K VIBRATION EXCITERS

The Vibration Exciters Type 4809 and the Mini Shaker Type 4810 are small vibration exciters having a wide range of applications, with force ratings of 10 lbf (45 N) and 1.5 lbf (7 N) respectively. The useable frequency range of Type 4809 is 10 Hz to 20 kHz and the maximum input current is 5 A RMS. The useable frequency range of Type 4810 is 20 Hz to 18 kHz and the maximum input current is 1.8 A RMS.

Both can be used for calibration of accelerometers, vibration of small objects, mechanical impedance measurements. For more details on their construction and performance, reference should be made to their instruction manuals.

When the Power Amplifier Type 2706 is used to drive one of the vibration exciters, the CURRENT LIMIT should be set to "5.0 A RMS" for Type 4809 and to "1.8 A RMS" for Type 4810.

5.2.1. Accelerometer calibration

A calibration set-up using the Mini Shaker Type 4810 is shown in Fig.5.1.

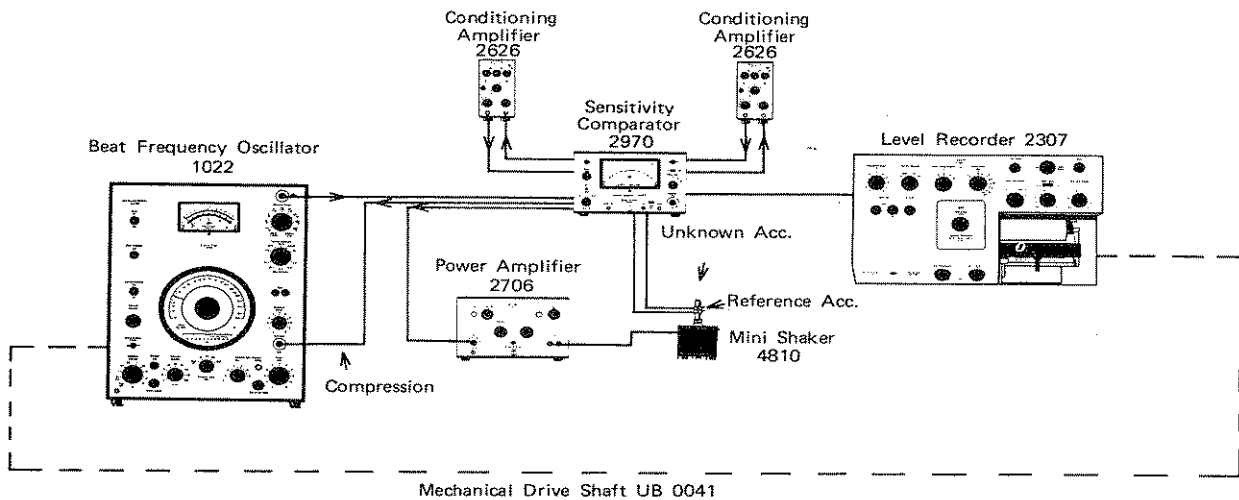

472 a 11

Fig.5.1. Example of Calibration set-up

Sensitivity of the unknown accelerometer is measured by comparison using the Sensitivity Comparator Type 2970 together with two Conditioning Amplifiers Type 2626.

Calibration is performed at a fixed frequency (e.g. 160 Hz) and a relative frequency response curve can be recorded on a Level Recorder Type 2305 or 2307. Full details on the calibration procedure are given in the instructions manual for Type 2970.

5.2.2. Vibration testing

Fig.5.2 shows an example of set-up for vibration testing using the Vibration Exciter Type 4809. Filtering of both compression and measured signals allows response measurements at very low levels or in the presence of high ambient noise.

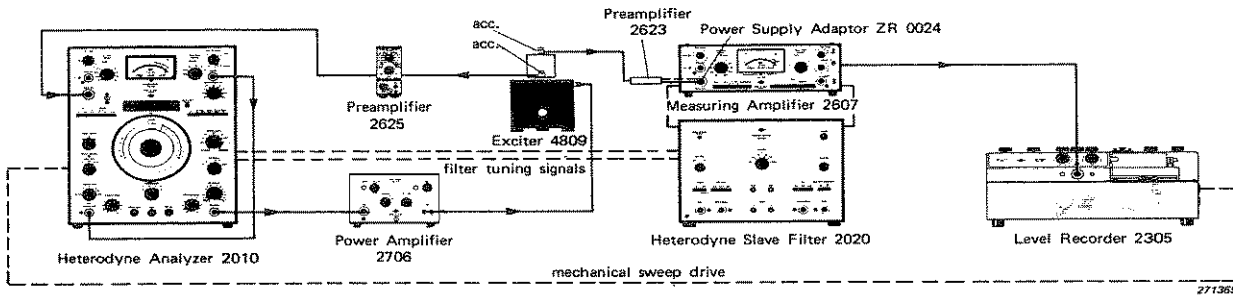

Fig.5.2. Example of Vibration Testing set-up

5.3. USE WITH THE REVERBERATION PROCESSOR TYPE 4422

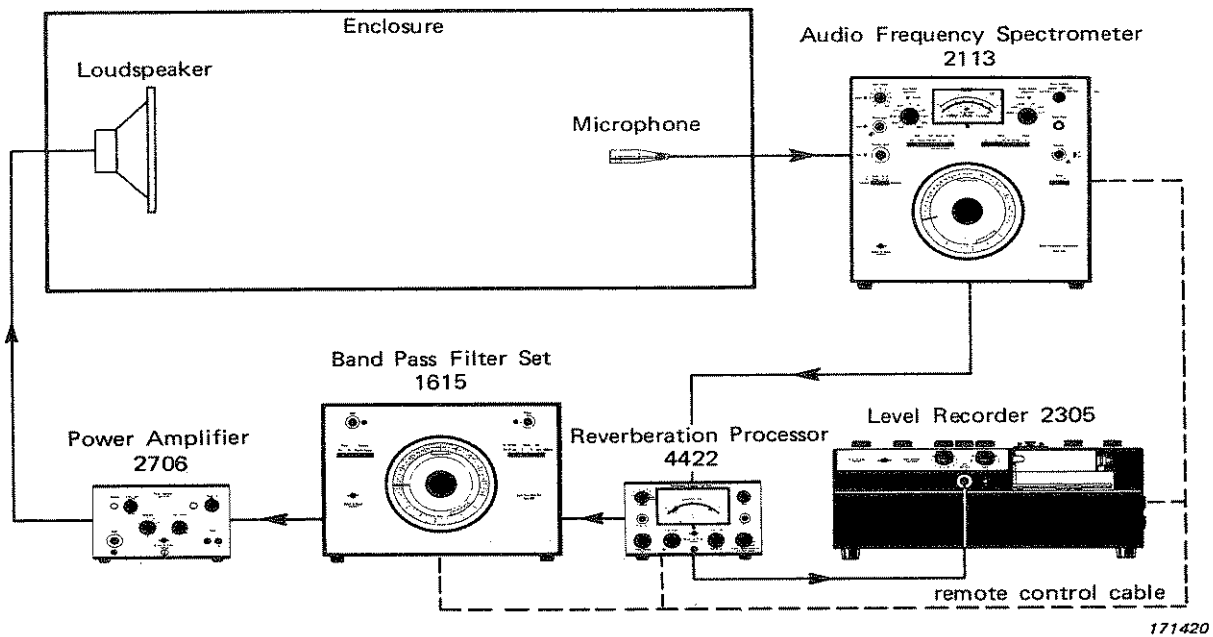

Fig.5.3. Measurement of Reverberation Time by the Kuttruff Method

The design of the Reverberation Processor is based on the "Method of Integrated Tone Burst" suggested by M.R. Schroeder and modified by H. Kuttruff. The use of this method results in very smooth decay curves, giving a very accurate determination of the initial slope of the curve. The "Early Decay Time" (the reverberation time extrapolated from the upper part of the decay curve) can be directly read from the meter of Type 4422.

A set-up for measuring reverberation times is shown in Fig.5.3. Type 2796 is used to amplify the output signal from the Band Pass Filter Set Type 1615. When calibrating the excitation pulse, the ATTENUATOR and the GAIN CONTROL of the Power Amplifier are set so that the output signal level is just below the clipping limit.

Reverberation curves measured using the set-up are shown in Fig.5.4.

For more details on the "Method of Integrated Tone Burst" and on the Reverberation Processor, reference should be made to the instruction manual for Type 4422.

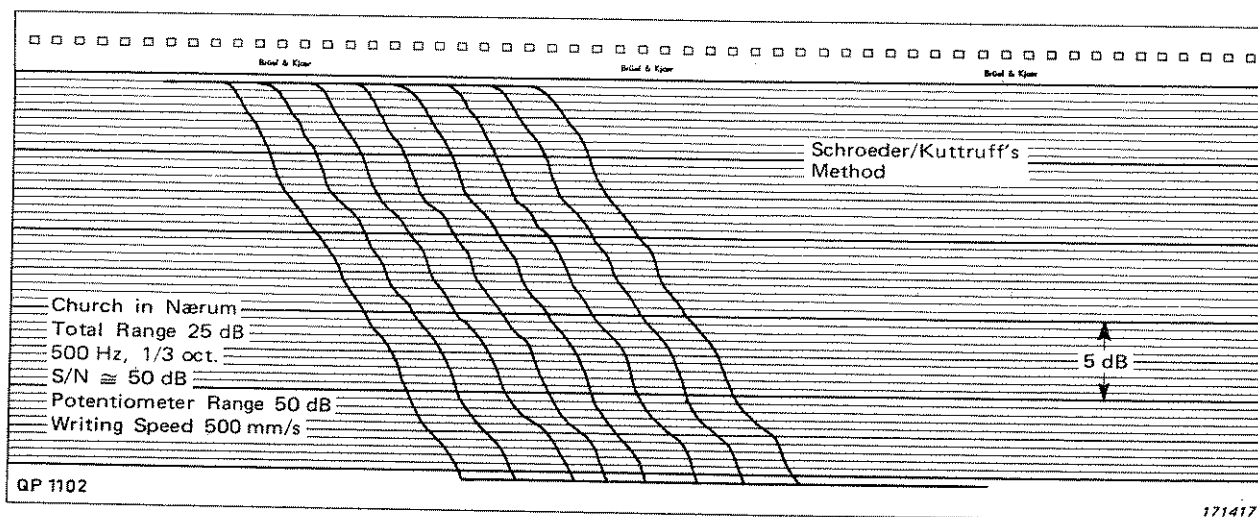
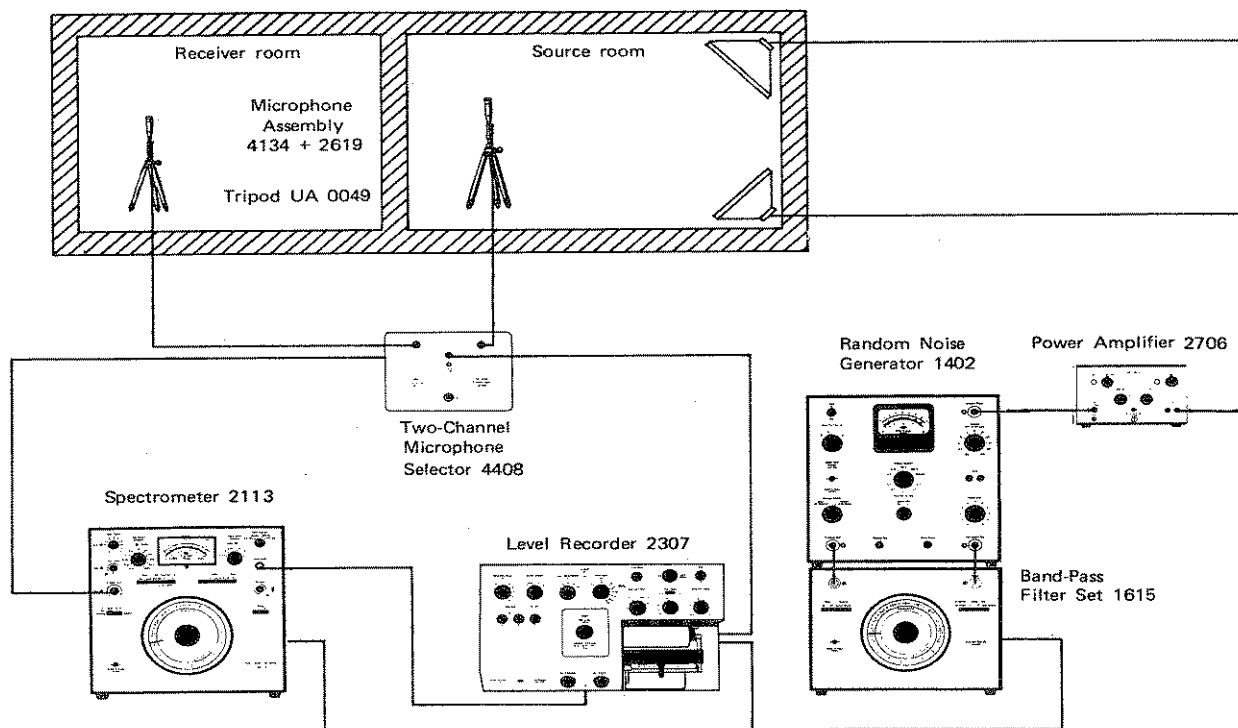

Fig.5.4. Reverberation Decay Curves, repetitive recordings

5.4. GENERAL USE IN ACOUSTICS

The Power Amplifier Type 2706 will be found very useful in acoustics measurements to supply a loudspeaker at a suitable level for reverberation, sound insulation, microphone and loudspeaker measurements.

An example of set-up for sound insulation measurements is shown in Fig.5.5.



472 of 4

Fig.5.5. Sound Insulation measurements

6. SPECIFICATIONS

| | |
|-------------------------------|---|
| Power Output Capacity: | 75 VA into a 3 Ω resistive load |
| Gain at 1 kHz: | 40 dB \pm 1 dB |
| Input Impedance: | 15 k Ω |
| Output Impedance: | 0.04 Ω 10 Hz to 5 kHz 0.08 Ω 5 kHz to 20 kHz |
| Harmonic Distortion: | <0.2% 20 Hz to 10 kHz <0.5% 20 Hz to 20 kHz |
| Noise and Hum: | At least 70 dB below full output |
| Max. Output Current: | 5.0 A RMS or 1.8 A RMS according to selected value |
| Max. Output Voltage: | 15 V RMS |
| Protection: | Short circuit of input or output Heat sink temperature Front panel indicator lights for output signal clipping |
| DC Stability: | Less than 25 mV drift for \pm 10% variation of mains supply from nominal, and for 10 to 40 $^{\circ}$ C (50 to 104 $^{\circ}$ F) variation in ambient temperature |
| Temperature Range: | 5 to 40 $^{\circ}$ C (41 to 104 $^{\circ}$ F) |
| Power Requirements: | 110, 115, 127, 150, 220, and 240 V AC, 50 to 60 Hz Approximately 140 W Operates within stated tolerances for a voltage deviation of up to \pm 5% |

Dimensions:

Height: 13.3 cm (5.2 in)
Width: 21.0 cm (8.3 in)
Depth: 20.0 cm (7.9 in)

Weight: 4.9 kg (10.8 lb)

Accessories included:

AN 0005 Mains cable (European)
or AN 0006 Mains cable (American)
Various spare fuses and lamps

