



MCS 2000™ Radios
Radio Service Software
User's Guide
Software Part Number: RVN-4113F

Computer Software Copyrights

The Motorola[®] equipment described in this manual may include copyrighted Motorola computer programs stored in semiconductor memories or other media. Laws in the United States and other countries preserve for Motorola certain exclusive rights for copyrighted computer programs, including the exclusive right to copy or reproduce in any form the copyrighted computer program. Accordingly, any copyrighted Motorola computer programs contained in the Motorola equipment described in this manual may not be copied or reproduced in any manner without the express permission of Motorola. Furthermore, the purchase of Motorola equipment shall not be deemed to grant either directly or by implication, estoppel or otherwise, any license under the copyrights, patents or patent applications of Motorola, except for the normal non-exclusive, royalty-free license to use that arises by operation of law in the sales of a product.

Licensing Restrictions

The installation program used to install MCS 2000™ Radio Service Software, INSTALL, is licensed software provided by Knowledge Dynamics Corp., P.O. Box 1558, Canyon Lake, Texas 78130-1558 (USA). INSTALL is Copyright (c) 1987-1992 by Knowledge Dynamics Corp. which reserves all copyright protection worldwide. INSTALL is provided to you for the exclusive purpose of installing MCS 2000 Radio Service Software. Motorola is exclusively responsible for the support of MCS 2000 Radio Service Software, including support during the installation phase. In no event will Knowledge Dynamics Corp. provide any technical support for MCS 2000 Radio Service Software.

Trademarks

, Motorola and PAC•RT are registered trademarks of Motorola, Inc.

MCS 2000, Call Alert, Channel Scan, Digital Private-Line, DVI-XL, DVP, DVP-XL, FLASHport, HearClear, Modat, Private-Line, Quik-Call, Quik-Call II, Sel Cal, Single Tone, SmartZone, Stat-Alert, OmniLink, and VRM-500 are trademarks of Motorola, Inc.

PC XT and Personal Computer AT are trademarks of IBM Corp.

MS-DOS and Windows are trademarks of Microsoft Corp.

Computer Software Copyrights

Copyright© Motorola 1990-1997. Printed in USA. All rights reserved.

Table of Contents

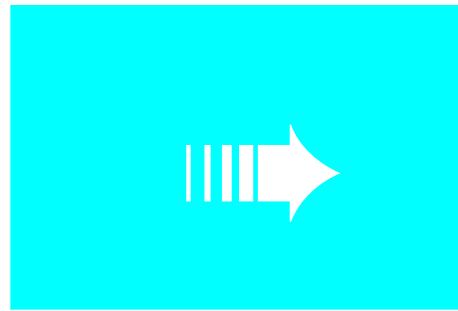

1 - Introduction	1
Prerequisites	2
Using This Manual	3
Assembling The Hardware	4
Steps to Connect the Hardware	4
What's On The RSS Diskettes	6
Organizing Your Hard Disk	7
Starting The RSS	8
The Banner Screen	10
Anatomy of a Menu	11
Navigating Through The RSS	12
Anatomy of a Screen	13
Changing A Field Value	14
Complete Menu Mapping at a Glance	15
Configuring RSS Computer Defaults	17
Main Menu	19
How to Read the Codeplug	21
Service Software Configuration	22
Configuring Paths and Port	23
Setting Screen Colors	26
2 - Basic Radio Programming Tutorial	29
Programming a Basic MCS 2000 Radio	29
Desired Features	29
Major Decisions Involved	29
High-Level Programming Flow	30
Step-by-Step Programming Instructions	30
Cloning Radios	35
3 - Service Menu Functions	37
Servicing the Radio Using the RSS	37
Menu Map	37
Service Menu	38
Transmitter Alignment Menu	40
Reference Oscillator Alignment	42
Transmit Power Alignment	43
Transmit Deviation Balance Alignment	45
Transmit Deviation Limit Alignment	47
Transmit Deviation Limit Alignment: Reference Softpot	49
SECURE Transmit Deviation	51
Transmit Current Limit	52
Receive Alignment Menu	54
Front-End Filter Alignment	55
Rated Audio Alignment	56
Squelch Attenuator (12.5 kHz) Alignment	57
Squelch Attenuator (20 kHz) Alignment	58
Squelch Attenuator (25/30 kHz) Alignment	59
RSSI Alignment	60
SECURE Receive Discriminator Level	61

VRM500 Receive Discriminator Level	62
Signalling Alignment Menu	63
DTMF Transmit Deviation	64
Transmit Signalling: High Speed	65
Transmit Signalling: MDC-1200.	66
Controller Board Initialization.	68
4 - Get/Save/Program Menu Functions	71
Menu Map	71
Get/Save/Program Menu	72
Reading Codeplug Data From Radio (Requires RIB)	74
Get Codeplug Data From Archive File	75
Get TCMS Codeplug Update Disk File	76
Clone Radio	77
Save Codeplug Data to an Archive File	80
Program the Radio's Codeplug (Requires RIB)	82
Programming History	83
5 - Change/View Menu Functions.	85
Menu Map	85
Change/View Menu	87
Radio Wide Configuration Menu.	89
Radio Wide Options	90
VRM100 Options	96
Radio Wide SECURE Options.	98
Radio Wide Emergency Options	100
More Radio Wide Options	102
Radio Wide Features Configuration Menu.	105
Radio Wide Button Configuration	106
Radio Wide Switch Configuration	111
Radio Wide Menu Item Configuration	112
DEK Configuration.	117
Phone Configuration	118
DTMF Access/Deaccess Codes	120
Dialing Options	122
Radio Wide Scan Lists and Options	124
Radio Wide Scan Options.	128
Radio Wide Display Options	131
Radio Wide Display More Options.	134
Alarm Options	135
Trunking Menu.	137
Trunking Radio Wide Options.	138
SmartZone Environment	140
Voice-On-Control (VOC) Options	145
Trunking Systems	147
Channel Assignment Data (UHF/VHF models only)	153
Control Channels.	155
Trunking System Options.	157
Trunking One-Touch Button Options	162
Trunking Status Alias	164
Trunking Message Alias	165
Trunking Site Alias	166
Trunking Personality	167
WAC AMSS Failsoft.	175
Trunking Subfleets	177
Trunking Emergency Data Configuration	179
Trunking Personality Options	186

SmartZone Preferred Sites	189
OmniLink Preferred Sites	190
VRM100 Trunk Options	192
VRM500 Trunk Options	195
Trunking Call List Table	197
Conventional Menu	198
Conventional Radio Wide Options	199
MPL List Configuration	201
Conventional Personality	203
SECURE Options	209
Personality MDC Options	212
Conventional Personality Phone Options	215
More Conventional Personality Options	217
Conventional Personality RAC Options	221
MDC Configuration Menu	224
MDC Systems	225
More Emergency Options	229
MDC System Options	230
MDC System Remote Options	234
MDC Call List Table	236
MDC Repeater ID	238
Auxiliary Menu	239
Single Tone Systems	240
Single Tone List	242
Quik-Call II System	243
Quik-Call II System Options	246
GE STAR System	248
Conventional Message Alias List	251
Conventional Status Alias List	252
Zone/Talkgroup Assignment	253
6 - Print Menu Functions	255
Menu Map	255
Print Menu	256
Print	
Radio Wide Features Configuration Menu	257
Trunking Print Menu	258
Conventional Print Menu	259
7 - File Maintenance Menu Functions	261
Menu Map	261
File Maintenance Menu	262
Create Directory Path	263
Delete Archive File	264
8 - FLASHport Upgrade	265
Menu Map	265
FLASHport Upgrade	266
View Radio Configuration	267
Enhancement Options	268
View FLASHkey Configuration	269
View Features	270
More Features	271
Upgrade Radio	272
Appendix A - Computer-to-Radio Communication Error Codes	273

Appendix B - TPL Frequencies and Codes	275
Appendix C - DPL Codes	277
Appendix D - MCS 2000 Features	279
Appendix E - Field/Menu Navigation Key Sequences	287
Appendix F - Trunked Radio Personality Chart	295
Appendix G - Conventional Radio Personality Chart	297
Glossary	299
Index	307

Introduction

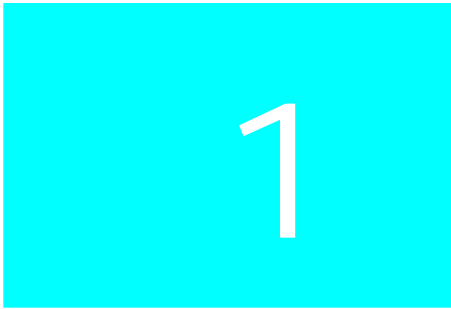

Welcome to the world of two-way radio programming. This Radio Service Software (RSS) manual is your guide to customizing and programming a variety of features into the MCS 2000 radio.

The MCS 2000 series of Mobile radios has a unique set of features, including unique PL/DPL codes for each channel, a variety of signalling abilities with channel scan, and the convenience of maintenance-free tuning due to the wide-band capability. This feature set makes these radios ideal for commercial businesses and police and fire protection services that typically utilize radios in their vehicles.

Modern microprocessor chip technology used to manufacture this radio and the MCS 2000 RSS (a computer program, which when interfaced with a radio, electronically programs a radio) make it possible for you to personalize a radio with a unique set of features for each individual customer. No tools are needed.

The RSS computer program resides on the diskettes you received in the package with this manual. The radio's customization and servicing is accomplished using an IBM[®] Personal System/2[®] Model 30 or higher computer.

Note: The alignment and troubleshooting sections of this manual are intended for use by qualified communications technicians and maintenance personnel ONLY.

Listed below are some of the major features and functions of the MCS 2000 RSS:

Programmable Features	Service Functions
Transmit (TX) frequencies	Reference oscillator alignment
Receive (RX) frequencies	Transmit deviation alignment
PL/DPL codes	Transmit power alignment
Signalling system parameters	Replaced power amplifier calibration
Phone operation	Replaced logic board calibration
FLASHport upgrade (<i>requires FLASHport upgrade package</i>)	Replaced RF board calibration

Prerequisites

To program radios using the RSS, we recommend a basic working knowledge of the following:

- Microcomputers
- The radio's available features (Refer to the appropriate Radio Operator's Manual.)
- Your customers' needs
- MS-DOS operating system, version 5.0 or later

This RSS requires a minimum of 510 kilobytes of free RAM to run. The DOS MEM command can be used to determine the amount of free memory available on your computer (that is, type `c:\dos\mem` and hit **Return**). The location of MEM.EXE may vary from computer to computer. *DOS 5.0 is required*. It is also strongly recommended that this RSS be run on a computer with the following minimum configuration:

- 80386 CPU or higher
- DOS 5.0 or later
- 4 MB of RAM (1MB lower + 3MB or more extended) or greater

For complex radio configurations, it is recommended that the RSS be executed from a RAM disk. This will reduce execution time significantly.

Note: This application is compatible with DOS 6.0, but cannot be run as a Double Space file.

To configure your computer with a RAM disk, you need to modify your CONFIG.SYS file with the following statements:

```
DEVICE=C:\DOS\HIMEM.SYS  
DEVICE=C:\DOS\MEM386.EXE OFF  
FILES=30
```

In order to run the RSS from the RAM disk, a .BAT (batch) file should be used to copy the necessary files from the hard drive to the RAM disk. Archive files are not affected and must be saved on the hard drive or floppy drive as usual.

Note: If you are a computer beginner, refer to the DOS manual that came with your computer for a detailed description of DOS procedures and commands.

Using This Manual

The MCS 2000 RSS Manual is designed to teach basic radio feature programming and speed up access to technical reference information. It is intended for both beginners and advanced RSS users. This manual contains information on all of the following:

- How to complete the hardware installation
- How to install the RSS
- How the RSS operates and how the screens are organized
- How to navigate through the menus and screens and use special keyboard commands
- What the purpose of each menu and screen is, along with detailed descriptions of the functions and data fields relevant to each menu/screen
- How to program a radio as well as how to service the radio
- How to organize your file directories and specify directory paths for codeplug files
- How to print out radio programming information
- How to clone (or program identical information into) a radio

To locate the information you need, use the Table of Contents and/or the Index. Explanations of technical terms used in this manual can be found in the Glossary.

The availability of some menus, screens or fields in the RSS are dependent upon the model of the radio/codeplug loaded into memory or on the values that have been assigned to certain fields in the RSS. Conditional statements which provide this kind of information and other important instructions are italicized throughout this manual.

Under each menu or screen title in this manual, you will find a sequence of F-keys (or function keys) such as **F4** **F3** **F5**. This sequence represents the path from the MAIN MENU to that specific menu or screen. To access the desired menu or screen, simply press these keys one by one from the MAIN MENU. Paths from the MAIN MENU to specific menus, screens and fields in the RSS can be found in Appendix E.

Watch for WARNINGS, CAUTIONS and NOTES which can be found throughout this manual, the definitions of which are provided below:

	An operational procedure, practice, or condition, etc., which may result in injury or death if not carefully observed.
WARNING	

	An operational procedure, practice, or condition, etc., which may result in damage to the equipment if not carefully observed.
Caution	

Note: An operational procedure, practice, or condition, etc., which is important to emphasize.

Assembling The Hardware

The figure below shows how to assemble the required (and optional) equipment used to program the MCS 2000 radio.

RIB Power Supply

60-82728J01 (9Vac) Power Supply

01-80357A57 (110 Vac) Power Supply

or **01-80358A56 (220 Vac) Power Supply.**

It is more reliable to use the power supply than to use a weak battery.

Smart RIB Power Supply

01-80302E27 or later (120 Vac) Power Supply (Required for FLASHport operation only.)

Portable Products Test Set - P/N RTX4005B or RTX-4005A Test Set (with rework kit RPX-4665A)

Provides the capability for testing many transmitter and receiver functions.

Transmitter modulation and keying can be simulated and receiver parameters can be tested without opening up the radio. The Test Set is used in conjunction with the programming/test cable.

RIB-to-Radio Cable

58-80385B31 Cable RKN4062A

Smart RIB-to-Radio Cable

RKN4047A Cable (required for FLASHport on Mobile radios only)

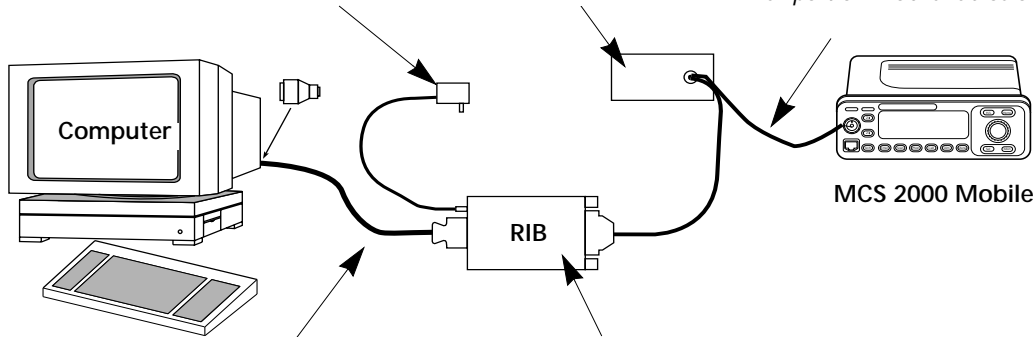

Radio Interface Box (RIB)-to-Computer Cable

30-80369B72 Cable for IBM Personal Computer AT or compatible computer (9-pin end and a 15-pin end).

or **30-80369B71** Cable for computers requiring a 25-pin serial port connection (25-pin end and a 15-pin end).

or Smart Radio Interface Box (SRIB) to Computer Cable **30-80390B48 or later** cable (Required for FLASHport operation only.)

Radio Interface Box (RIB)

RLN4008B RIB

or Smart Radio Interface Box (RIB) **RLN1015B or later RIB** (Required for FLASHport operation only.)

For laptop computer and on-the-road use only; use a 9V battery (not included).



Caution

Use a fresh, 9V battery. The LED will remain lit with a weak battery and this may cause certain errors on the screen.

Steps to Connect the Hardware

1. Connect the RIB-to-computer cable to the communications port of the computer (9/25-pin end).
2. Connect the other end (15-pin end) to the Radio Interface Box (RIB).

Note: If your computer has a 25-pin connections port connector, you will need the cable **30-80369B71** to insert between the computer and the RIB-to-computer cable.

3. Connect the 25-pin end of the RIB-to-radio cable to the RIB, and the 9-pin end to the connector on the front side of the radio as

shown.

4. Plug one end of the RIB power supply into the RIB and the other end into a wall outlet.

After you connect the hardware, switch on the radio by turning the volume control clockwise. You will hear one of the following types of tones.

High-pitched, short tone	Hardware is connected correctly and the radio's internal firmware is operating properly. Note: This tone may be disabled in the codeplug and may not be heard.
Continuous low tone	Critical failure or radio's internal software malfunction.

You can install, start or explore the RSS using just the diskettes and your computer if you do not have all the necessary hardware. You can even update existing radio archive files stored on disk. What you cannot do without the required hardware is read from or save codeplug data to an actual radio and perform service functions.

 Caution	When programming or calibrating a radio, DO NOT disconnect the radio from the RIB when the computer is communicating with the radio. If you do so, the radio may become inoperable. The only recommended time to disconnect the radio is while you are at the MAIN MENU or at any of the GET/SAVE/PROGRAM screens.
--	--

Note: If you are using a laptop computer and you plan to use the RSS while the computer is in battery mode, you may need to set the serial/parallel adapter to run on battery power. This can be accomplished using the application diskette supplied by the computer manufacturer. *If this action is not performed, you are likely to receive serial bus errors.*

Note: If your RIB has a switch and LED, be sure to turn the switch on before each programming session.

What's On The RSS Diskettes

Below are the files located on the diskette you received with this manual.

File Name	File Type	Description
INSTALL.EXE	Installation file	Used to install the RSS.
INSTALL.DAT	Installation file	Contains installation data.
MCSINS.001	Compressed executable file	File that the installation program uncompresses when it installs the RSS on your hard disk.
MCSINS.002	Compressed executable file	Second part of the executable files.
DISK.ID	Installation file	Floppy Disk ID.
README.TXT	Text file	Contains information about the current RSS release.

The INSTALL program creates a file named MCS.BAT. This file is located under the root directory of the hard drive, enabling the RSS to start up from the root directory.

Experienced RSS users and computer pros can skip the "Organizing Your Hard Disk" section and proceed to the "Starting The RSS" section. New RSS users should read all sections.

Organizing Your Hard Disk

It is important to spend some time early on deciding which types or groups of files should be located together in the same file directory. File directories can be created using the DOS **MD** or **MKDIR** command.

You may want to organize your directories first by customer area, then by customer name and finally by radio model type, or perhaps in the reverse order. Consider the different ways in which you operate your business. Do you separate radio files by customer location, by sales revenue, by fiscal year, or perhaps by date of purchase? When deciding how to organize your files and directories, we suggest the following:

- Put as few directories as possible near the top (or root) of your directory tree. The next level of directories would be the customer names within each of those areas.
- Keep the RSS diskette contents in one directory and your archive files in a different directory.
- Storing archive files for different radio models in the same directory can cause a lot of confusion. Use a separate directory name for each radio model and then store the archive files for that specific model within the appropriate model directory.

Below is a sample directory tree for storing radio archive files on the hard disk. Though your hard disk directory tree may vary depending on your way of doing business, this setup may be a good starting point. The installation program will automatically create the MRSS and MCS directories for you if they do not already exist.

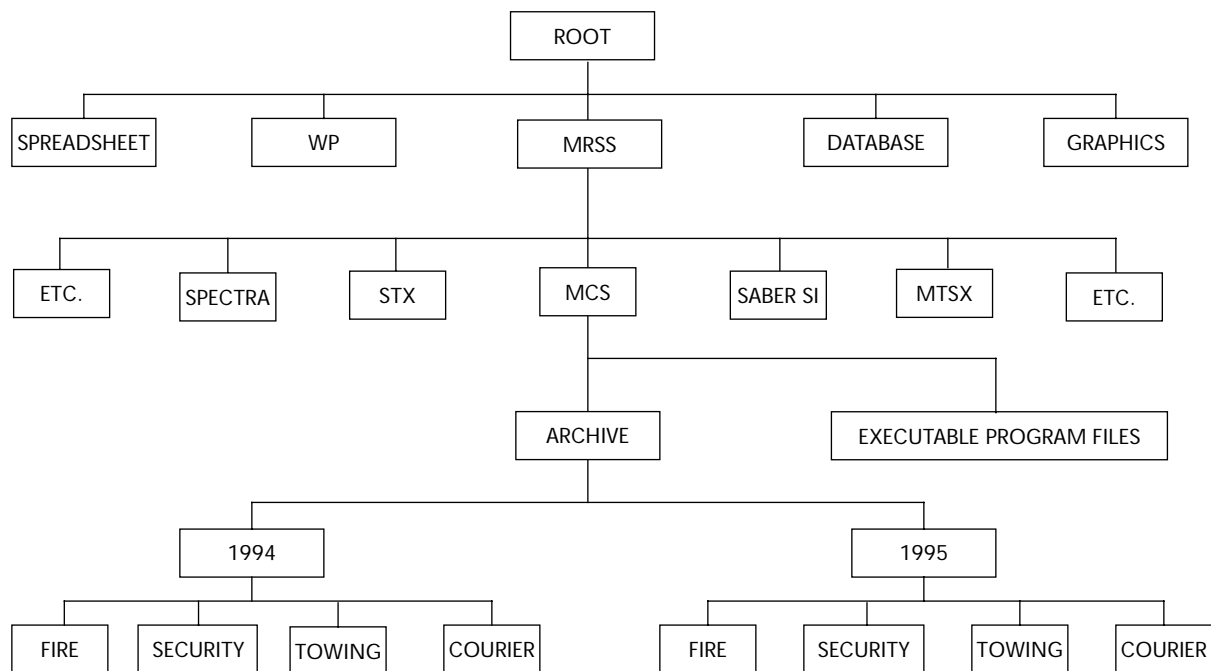

Starting The RSS

Create a Back-up Copy of RSS Diskette(s)

We recommend that you make a back-up copy of the RSS. To make a back-up copy, follow these steps:

1. Insert the RSS diskette you received with this manual into drive A.
2. Type **DISKCOPY A: A:**



Caution

Accidentally reversing the insertion order of the diskettes will erase the contents of the RSS diskette. You will be prompted to insert the source diskette (the original RSS diskette) and the target diskette (a newly formatted one) respectively. When the disk copy command has been executed, use the target diskette as the new working copy.

3. Keep the original RSS diskettes in a safe place away from magnets, moisture and heat.

What To Do with Previous Versions of RSS Diskettes

It is recommended that you discard previous versions of the RSS so that the RSS version you have is the very latest. This will also ensure that you do not mistakenly program a radio with outdated data.

Note: The latest RSS version usually has updated codeplug structures which cannot be read by old versions of RSS.

Installing the RSS on your Hard Disk

Install the latest RSS version as soon as you receive it. The software installation will take approximately three minutes, but this duration may vary based on the processing power of your computer.

The INSTALL program will:

- Create the MRSS, MCS and ARCHIVE directories if they do not already exist.
- Create OFP, SYSKEY, SRIB and UPGRADE directories.
- Write over the old version's program files with the same name, if they exist.

The INSTALL program will NOT write over your archive files.

You may install the RSS on several personal computers and laptop computers at a single site *depending on the terms of your license*. If you have additional sites (such as a second shop), you should purchase additional subscriptions.

Note: The RSS is NOT a Windows program. *If you have Windows loaded, the RSS program will not operate properly.*

To install the RSS, follow the steps below:

1. Insert the RSS diskette into drive A.
2. Type **A:** (press Return).
3. At the **A:** prompt, type **INSTALL**.

Note: After installing the RSS on a hard disk, you may notice new files with CFG or ODB extensions on your hard drive. These are configuration files used by the system and the RSS. *Do NOT delete or move these files from the C:\MRSS\MCS directory.*

RSS Start-Up Procedure

After installing the RSS on your hard disk, follow the start-up procedure below:

1. Log on to the hard drive by typing **C:** and pressing **Return**.
2. At the **C:** prompt, type **MCS**.

This command starts up the RSS. If the software does not start up correctly, you may hear a tone or see an error message or error code printed on the display. If this happens, verify that the file MCS.BAT appears under the root directory of Drive C.

The Banner Screen

When the RSS has been successfully loaded in your computer, you will see a BANNER screen similar to the one below.

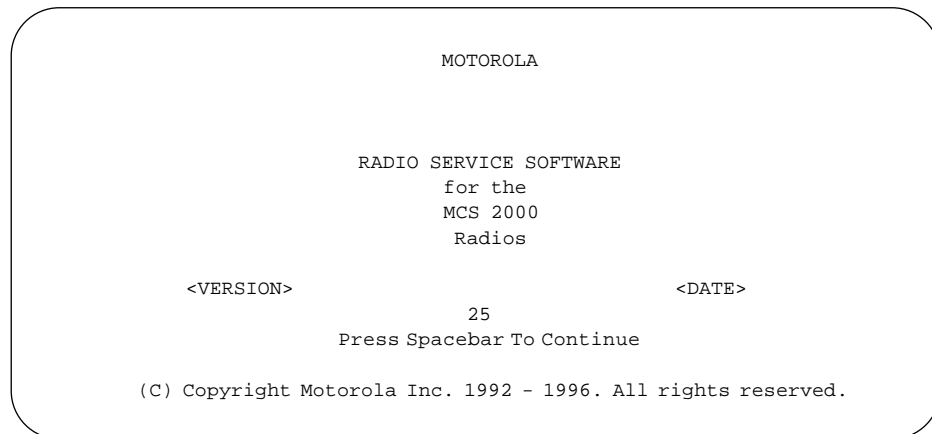

The *Version* and *Date* on the BANNER screen above are not shown here. However, your RSS will show the actual version and date on the screen.

Press any key at the BANNER screen to access the MAIN MENU.

Anatomy of a Menu

Within the RSS, there are menus that will take you to other menus and/or to screens where you can change the choice or value of a field. The only difference between a menu and a screen is the nature of the information that appears in the *working area*, marked by the letter C in the figure below. A menu or screen has four areas labelled below as A, B, C and D respectively.

MOTOROLA Radio Service Software MCS Model: MAIN	Select Function F1 - F10. No System Keys Found.							
MAIN MENU ----- F1 - HELP F2 - SERVICE: Alignment (Requires RIB) F3 - GET/SAVE/PROGRAM/CLONE Codeplug Data from/to Disk/Radio F4 - CHANGE/VIEW Radio Codeplug Data F5 - PRINT Radio Codeplug Data F6 - FILE Maintenance F7 - F8 - FLASHport Upgrade F9 - SETUP Computer Configuration F10 - Exit Radio Service Software, Return to DOS								
F1 HELP	F2 SERVICE MENU	F3 GET SAVE	F4 CHANGE VIEW	F5 PRINT DATA	F6 FILE MAINT	F7 F8 FLASHport UPGRADE	F9 SETUP MENU	F10 EXIT TO DOS

A RSS Location ID Area

In this area, you will find the words “MOTOROLA Radio Service Software” and a menu or screen path name for the current menu or screen shown on the display.

B Instruction Area

As the name indicates, this area asks you to perform specific actions such as “Select Function, F1-F10”, “Use UP/DOWN arrows to scroll value” and so on.

C Working Area

This area of the menu (not a screen) displays a list of functions (menu choices) that you can execute from the current menu. Each menu item is preceded by a function key. Pressing a function key from among the available choices advances you to another menu or screen as the case may be.

D F-Key (Function Key) ID Area

This area displays the function keys and their corresponding names for the current menu or screen.

Note: All functions (supported and unsupported) will be displayed in the menu’s working area. The unsupported functions (based on the radio’s model or options) will, however, NOT be displayed in the F-key area.

Navigating Through The RSS

Every action of the RSS is controlled by you through the use of formatted displays and function keys.

Under each menu or screen title in this manual, you will find a sequence of F-keys (or function keys) such as **F4** **F3** **F5**. This sequence represents the path from the MAIN MENU to that specific menu or screen. To access the desired menu or screen, simply press these keys one by one from the MAIN MENU.

The F-keys and other special keys that you can use to communicate with the RSS are listed below along with their various functions.

- F1** Used to display on-help information on *every* RSS screen and menu. On-line help provides information on how to use the currently displayed menu, screen, line or field. You may also find system setup information in a HELP screen. In many cases, help information provided is for the specific line of the screen that is currently highlighted.
- F2 through F9** The **F2** through **F9** keys perform special functions and actions which can vary from menu to menu and from screen to screen. For instance, *on some screens*, **F5** will print out the current screen to your printer, **F8** will save the data and options currently displayed, and so on.
- F10** This key is used to exit to the previous menu or screen. The **F10** key performs this function on *every* menu and screen. The only exceptions are as follows:
- At the MAIN MENU, the **F10** key is used to exit the RSS.
 - In sub-menus of the PRINT MENU, the **F10** key is used to cancel printing if printing is in progress.
- Esc** Used to exit to the MAIN MENU. The **Esc** key performs this function on *every* menu and screen.

Anatomy of a Screen

The only difference between a menu and a screen lies in the contents of the working area.

MOTOROLA Radio Service Software MCS Model:		Use UP/DOWN Arrows to Select Type.																							
MAIN:CHANGE/VIEW:CONV:PERS																									
Personality.....1 CONVENTIONAL PERSONALITY ----- Receive Only.....Disabled Signalling..... MDC Direct / Talkaround.....Enabled MDC System #.....1 Time Out Timer.....3- 60 PTT ID.....Disabled Scan List.....None Hot Keypad.....Disabled Phone Operation.....Unlimited <table> <tr> <td>Frequency (MHz)</td> <td>Receive</td> <td>Transmit</td> <td>Direct</td> </tr> <tr> <td>Squelch Type</td> <td>136.06250</td> <td>136.01250</td> <td>136.06250</td> </tr> <tr> <td>Code</td> <td>CSQ</td> <td>Disabled</td> <td>Disabled</td> </tr> <tr> <td>DPL Invert</td> <td></td> <td></td> <td></td> </tr> </table>										Frequency (MHz)	Receive	Transmit	Direct	Squelch Type	136.06250	136.01250	136.06250	Code	CSQ	Disabled	Disabled	DPL Invert			
Frequency (MHz)	Receive	Transmit	Direct																						
Squelch Type	136.06250	136.01250	136.06250																						
Code	CSQ	Disabled	Disabled																						
DPL Invert																									
F1	F2	F3	F4	F5	F6	F7	F8	F9	F10																
HELP	ADD	PREV	NEXT	DELETE		MDC	PHONE	MORE	EXIT																
	PERS	PERS	PERS	PERS		OPTIONS	OPTIONS	OPTIONS																	

The working area of a screen contains a list of programmable features called “fields” the values in which can be selected or changed using the arrow, **Tab** or **Return** keys. On some screens, there are features that can be selected for each *individual* channel or mode; these features are selected on a mode-by-mode basis. On other screens, there are features that can be selected for *all* modes of the radio (referred to as “radio-wide” features). And still other screens list those features that perform specific RSS functions such as servicing the radio or printing personality data.

Changing A Field Value

The keys commonly used in the RSS to change a field value and their respective functions are listed below.

Tab or Enter

Used to accept data currently in the field and move the prompt forward one field. If the entry is not accepted (that is, it is probably not a valid value), an error beep will sound.

Del

Used to erase the current character in a field.

PgUp

Used to display the previous page of information on the screen.

PgDn

Used to display the next page of information on the screen.

Screen fields come in three basic types:

Information fields

Non-editable fields which cannot be altered or changed.

Scrollable fields

Contain a range of values or several options from which you can select the desired value/option. To edit or change a choice, use the UP/DOWN arrow keys.

Direct-entry fields

The desired value must be typed in. To edit or change a choice, type in an acceptable value.

Changing a field's value is typically done either by scrolling through a list of options (in scrollable fields) or by typing in a correct or acceptable value (in direct-entry fields). Scrolling is accomplished using the arrow keys.

Complete Menu Mapping at a Glance

The menu map below is a guide through the entire RSS.

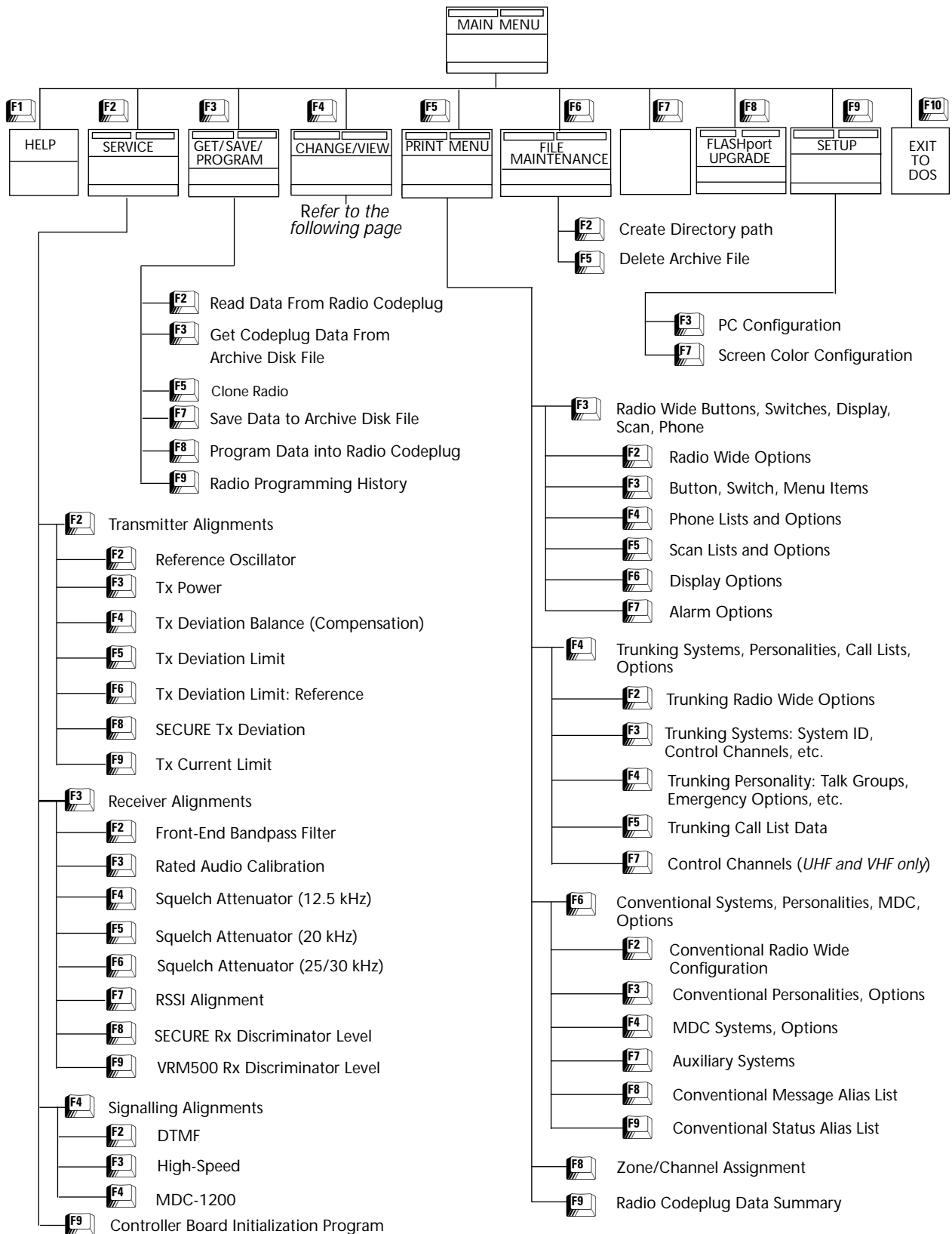

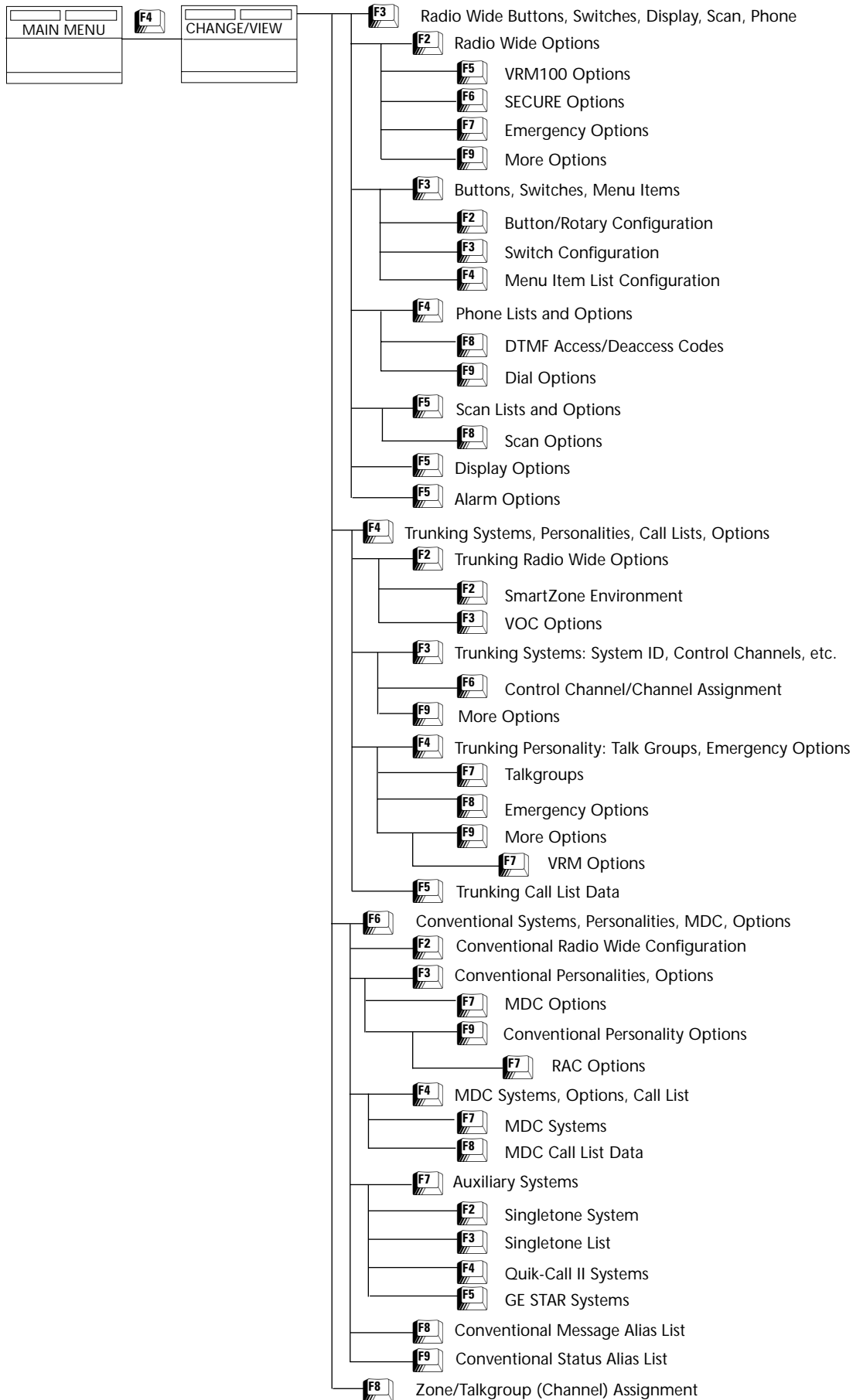

Configuring RSS Computer Defaults

Setting computer defaults eliminates the need to specify them every time you enter the RSS or program a radio.

Read this section if you wish to do any of the following:

- Set a default file path name
- Set or change the default port used to interface with the radio and RIB
- Set the default colors you see on your RSS screen

To begin configuring RSS defaults, return to the MAIN MENU by pressing the **Esc** button.

From the MAIN MENU, press **F9** to access the SERVICE SOFTWARE CONFIGURATION MENU. From the SERVICE SOFTWARE CONFIGURATION MENU, you can read on-line help (**F1**), set some default computer values, or exit (**F10**).

Press **F3** on the SERVICE SOFTWARE CONFIGURATION MENU to bring up the CONFIGURE PATHS AND PORT screen, where you can specify the default drive and path names for future archive files, as also select the COM port that will be used to communicate with the radio.

Press **F7** on the SERVICE SOFTWARE CONFIGURATION MENU to display the SCREEN COLORS screen. Here, you can specify the colors for your screen's text, lines, background, and highlighted fields.

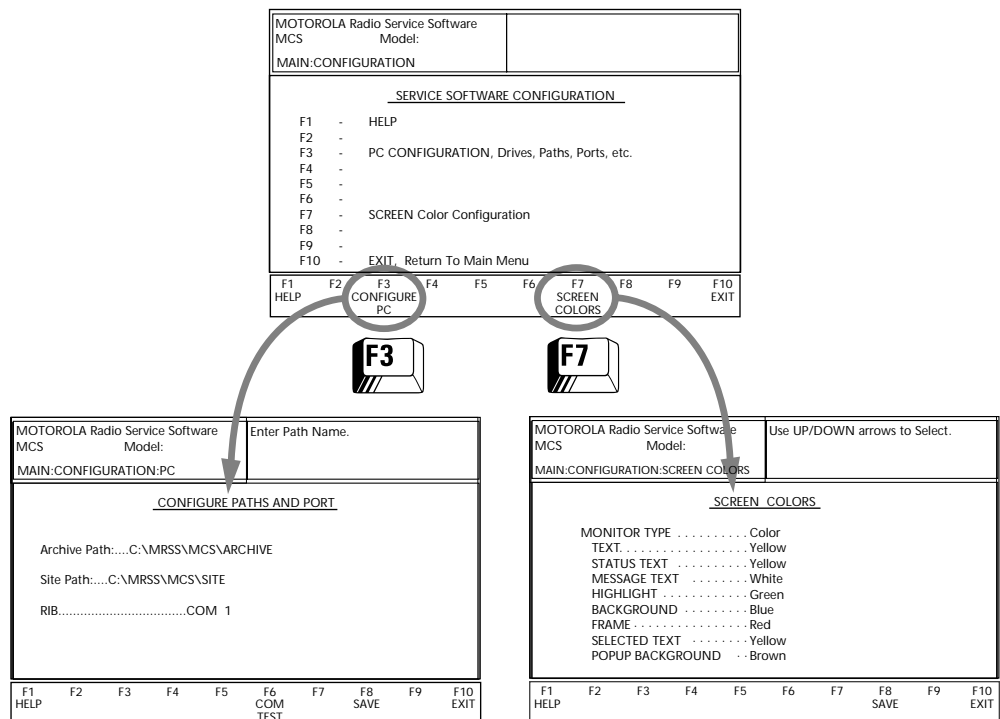

Setting Default Archive and Back-up Paths

You can set the drive name and path names for archive files you will create later. Here's how to set the default archive and back-up file paths:

1. Press **F9** and then **F3** at the MAIN MENU to bring up the CONFIGURE PATHS AND PORT screen.
2. At the CONFIGURE PATHS AND PORT screen, press **Tab** as many times as necessary until the Archive Path field is highlighted. Now specify the archive file path as follows:

C:\MRSS\MCS\ARCHIVE

3. Type **F8** to save the field options displayed on the screen.

Setting a Default COM Port

Use the following steps to specify the serial port to interface with the radio and RIB. The default port is COM 1.

1. Press **F9** and then **F3** at the MAIN MENU to bring up the CONFIGURE PATHS AND PORT screen.
2. Go to the serial port RIB field by pressing **Tab** five times.
3. Use the arrow keys to scroll through the available field options and select the appropriate port. Options are COM 1, COM 2, COM 3 or COM 4.
4. Test the port by pressing **F6** COMTEST. If the connections are okay, you will hear a beep and the words "Communication With the Radio Was Successful" will appear in the instruction area.
5. Press **F8** to save this configuration. The message "Configuration File Written Successfully" will appear in instruction area of the screen.
6. Press **Esc** to exit this screen and go to the MAIN MENU.

Exiting The RSS

Before you exit the RSS, always ask yourself these questions:

- Did you apply the changes to the radio (that is, save the changes to the radio)?
- Did you apply the changes to a computer file (that is, save programming to an archive file)?

If you are not at the MAIN MENU, press the **Esc** key to return to this menu, and then press **F10** followed by **F2** to exit to the DOS prompt.

Main Menu

The MAIN MENU is the top level of the program from which all function selections start. All selections are made using the function keys which are labeled **F1** through **F10** on the keyboard. All other menus allow you to press the **Esc** key to return to the MAIN MENU.

For any problems not covered by this manual or the Radio Service Manual, contact your local Motorola field technical representative.

MOTOROLA Radio Service Software MCS Model: MAIN	Select Function F1 - F10. No System Keys Found.								
MAIN MENU ----- F1 - HELP F2 - SERVICE: Alignment (Requires RIB) F3 - GET/SAVE/PROGRAM/CLONE Codeplug Data from/to Disk/Radio F4 - CHANGE/VIEW Radio Codeplug Data F5 - PRINT Radio Codeplug Data F6 - FILE Maintenance F7 - F8 - FLASHport Upgrade F9 - SETUP Computer Configuration F10 - Exit Radio Service Software, Return to DOS									
F1 HELP MENU	F2 SERVICE	F3 GET SAVE	F4 CHANGE VIEW	F5 PRINT DATA	F6 FILE MAINT	F7	F8 FLASHport UPGRADE	F9 SETUP MENU	F10 EXIT TO DOS

Function Key Descriptions

F1 - HELP

Provides additional information on this screen. Generic help is available within any help screen in the form of the MORE HELP function.

F2 - SERVICE

A radio must be connected to your computer using a RIB and cables and the radio turned on before you will be permitted to access the service screens. Brings up a multi-level menu that enables access to screens from which radio service alignments are performed.

Note: If the radio attached to the computer via the RIB is a CBI-initialized radio, you will have to initialize the controller board and specify the serial number from the CONTROLLER BOARD INITIALIZATION screen (**F2/F9**). This process must be completed if the new CBI controller board is to function properly.

F3 - GET/SAVE

Brings up a menu through the sub-menus of which you can read codeplug data from a radio and/or retrieve archived codeplug data from a diskette/hard disk. GET/SAVE functions are also used to program edited codeplug data back into the radio and create archive files on disk.

F4 - CHANGE/VIEW

A codeplug must be loaded into the computer's memory using GET/SAVE functions before CHANGE/VIEW functions can be accessed. Brings up a multi-level menu that is used to change or view codeplug features and option configurations.

Note: An archive file can be accessed without a radio being connected.

- F5 - PRINT MENU Prints selected codeplug data.
- F6 - FILE MAINTENANCE Brings up a menu which allows you to easily create directories and delete files without exiting the RSS.
- F8 - FLASHport UPGRADE *You must have FLASHport software installed on your computer in order to access this menu.* Brings up a menu from which you can view the radio's configuration, its FLASHkey contents, upgrade the codeplug, and FLASH the radio.
- F9 - SETUP Brings up a menu which is used to configure the RSS according to specific user requirements. Default disk drives, communication ports and even screen colors may be customized to suit your needs.
- F10 - EXIT Used to quit the program and return to DOS. You will have to press this key and then **F2** to actually exit the program.

Note: Make sure that all desired codeplug changes have been programmed back to the radio and that an archive copy has been made. *If this is not done, all changes will be lost since DOS erases this data from the computer's memory when you exit the program.*

How to Read the Codeplug

Follow the procedure below to read the codeplug:

1. Start up the RSS. If you are not already at the MAIN MENU, press any key at the BANNER screen to access the MAIN MENU.
2. From the MAIN MENU, press **F3**; the GET/SAVE/PROGRAM MENU will be displayed.

You may read the codeplug from the radio or from the archive disk.

Reading Codeplug Data from the Radio

Turn on the radio and press **F2**. A series of status messages will appear in the upper right corner of the screen. The read process will take approximately one minute, but may vary depending on the processing power of your computer. After the codeplug is read, the GET/SAVE/PROGRAM MENU will be displayed.

Note: If a communication error occurs, a pop-up window will be displayed. If no errors occur, the center of the screen will display the progress of the codeplug read activity.

Reading Disk Codeplug Files

Press **F3** at the GET/SAVE/PROGRAM MENU. The ARCHIVE FILE screen will be displayed. An archive path and the list of files in that path will be displayed. By default, the archive path will be the corresponding path specified on the CONFIGURE PATHS AND PORT screen. If you want to retrieve a file from another path, press **F2**, type in the path name and press **Enter**. The names of the files in the new path will be displayed.

1. Use the **Enter**, **Tab**, **Shift** or arrow keys to highlight a desired file name.
2. To retrieve the highlighted file, press **F8**. The selected file will be retrieved, validated and placed in computer memory. The progress of the read process will be displayed on the screen.

Service Software Configuration



The SERVICE SOFTWARE CONFIGURATION screen can be accessed by pressing **F9** at the MAIN MENU.

MOTOROLA Radio Service Software MCS Model: MAIN:CONFIGURATION	Select Function F1 - F10.								
SERVICE SOFTWARE CONFIGURATION -----									
F1 - HELP F2 - F3 - PC CONFIGURATION: Drives, Paths, Ports, etc. F4 - F5 - F6 - F7 - SCREEN Color Configuration F8 - F9 - F10 - Exit, Return to Main Menu									
F1 HELP	F2	F3 CONFIGURE PC	F4	F5	F6	F7 SCREEN COLORS	F8	F9	F10 EXIT

From this screen, you may set up the paths for archive files. You may also set up the serial port (COM 1, COM 2, COM 3 or COM 4) that will be used to communicate with the radio.

Function Key Descriptions

F3 - CONFIGURE PC

Brings up a screen where you may set default disk drive paths for archive and back-up files. It is also used to select the asynchronous communications port (COM 1, COM 2, COM 3 or COM 4) to which the RIB will be connected. The RSS will automatically determine at what clock speed the computer is operating. No user-selectable parameters are required.

Note: Refer to the owner's manual that came with your computer for a complete description of path names and asynchronous communication ports.

F7 - SCREEN COLORS

Brings up a screen where you may enable or disable the color display option and specify colors for different parts of the RSS screen (if color display is enabled). If the computer is capable of color display, viewing quality is greatly enhanced. The standard default configuration for the RSS is for a monochrome display.

Configuring Paths and Port



From the MAIN MENU, press **F9** and then **F3** to access this screen.

MOTOROLA Radio Service Software MCS Model:		Enter Path.							
MAIN:CONFIGURATION:PC									
CONFIGURE PATHS AND PORT -----									
Archive Path:....									
FLASH Software Path:..C:\MRSS\MCS\UPGRADE									
Bootstrap Code Path & FileName:..C:\MRSS\MCS\UPGRADE\MCSBOOT.ENC									
SRIB Software Path & FileName:..C:\MRSS\MCS\SRIB\SMARTRIB.ENC									
System Key:.....									
Speed Optimization.....Enabled									
Memory Optimization.....Disabled									
TCMS Path:.....									
RIB.....COM 1									
F1 HELP	F2	F3	F4	F5	F6 COM TEST	F7	F8 SAVE	F9	F10 EXIT

This screen is used to set default disk drive paths for archive and back-up files. It is also used to select the asynchronous communications port (COM 1, COM 2, COM 3 or COM 4) to which the RIB (radio interface box) will be connected.

Note: Refer to the owner's manual that came with your computer for a complete description of directory path names and asynchronous communications ports.

Function Key Descriptions

F6 - COM TEST
(Communications Test)

Verifies if the computer is set up correctly and is able to read and program the radio codeplug properly. After your computer and RIB are connected according to instructions on page 4 and you have selected the appropriate communication port, turn on your radio and perform a COM TEST by pressing **F6**.

COM TEST will verify if your system is functioning properly by sending commands to the radio and checking for the proper response. An OK response will be displayed in the Status Window if the system checks okay. Otherwise, error messages will be displayed. Make sure that all cables and power supplies are connected according to instructions provided in this manual.

Note: No codeplug changes will result from these commands.

F8 - SAVE

Used to save configuration information to a file on your program disk. Every time you use the RSS, the configuration that you saved last will be used. The configuration file will be named MCS.CFG. This configuration may be altered and saved at any time.

Field Definitions

Archive Path	<p>Enter the default directory path where archive files are to be located. The GET/SAVE – SAVE FILE function will default to this path.</p> <p>Note: Refer to the owner’s manual that came with your computer for a complete description of directories and path names.</p>
FLASH Software Path	<p>Enter the default directory path where FLASHport Upgrade files are located. The default path established by the MRSS installation program is C:\MRSS\MCS\UPGRADE. <i>In order to ensure a successful FLASHport Upgrade, it is strongly recommended that none of the files installed by the MRSS installation program be moved, overwritten by the user, or renamed.</i></p> <p>Prior to performing a FLASHport upgrade, MRSS displays the list of files that exist in the path entered here. You will then be asked to select the desired FLASHport Upgrade Software Kit and press F8 to start the upgrade process. Errors such as “UNABLE TO OPEN THE SELECTED UPGRADE FILE”, “FILE CHECKSUM ERROR, UNABLE TO OPEN THE SELECTED UPGRADE FILE”, or “INCORRECT UPGRADE SOFTWARE KIT” mean that the selected file can not be accessed, the selected file has an invalid format (the file is not MRSS compatible), or the software kit number in the file does not match the one on your FLASHKEY respectively. In case of such errors, make sure the selected file is the one that was shipped to you with your upgrade kit.</p>
Bootstrap Code Path & File Name	<p>Enter the default directory path and the default name for this file. The default path established for this file by the RSS is C:\MRSS\MCS\UPGRADE\MCSBOOT.ENC.</p>
SRIB Software Path & File Name	<p>Enter the default directory path and the default name for the SRIB software file. The default path established by the MRSS installation program is C:\MRSS\MCS\SRIB, and the default file name is SMARTRIB.ENC. <i>In order to ensure a successful FLASHport Upgrade, it is strongly recommended that none of the files installed by the MRSS installation program be moved, overwritten by the user, or renamed.</i> Errors such as “UNABLE TO OPEN THE SRIB SOFTWARE FILE” or “SRIB SOFTWARE CHECKSUM ERROR, UNABLE TO CONTINUE” mean that the SRIB Software file can not be accessed, or that the file has an invalid format (the file is not MRSS compatible). In case of such errors, make sure that the file entered in this field is the one that was shipped to you with your upgrade kit.</p>
System Key	<p>Enter the default DOS directory path where trunking system keys are to be located.</p>
Speed Optimization	<p>This field is used to control Speed Optimization for the RSS. When enabled, Speed Optimization allows the RSS to navigate through screen/fields and to save codeplugs in less time. There should be no adverse side effects in the codeplug output. However, if any undesired values arise from changing this field, disable this feature and resave the codeplug.</p> <p>The factory default is Enabled.</p>

Memory Optimization

This field is used to control Memory Optimization for the RSS. When enabled, Memory Optimization performs a memory cleanup for successive codeplug reads. This allows computers with a limited amount of available Random Access Memory (RAM) to perform a greater number of codeplug reads before experiencing possible system problems. However, this feature will cause system delays in successive reads while the RSS performs the optimization. If your computer has greater than 8MB of total RAM memory, it is recommended that you leave this feature disabled.

The factory default is Disabled.

TCMS Path

Enter the DEFAULT directory path from where TCMS Update files will be retrieved. The GET/SAVE GET TCMS file function will default to this path. Please refer to your computer owner's manual for a complete description of directories and path names.

RIB

Use the UP/DOWN arrow keys to select the asynchronous communications port (COM 1, COM 2, COM 3 or COM4) to which the RIB (radio interface box) is connected. If you are not sure how your computer is configured or if you have two asynchronous communications ports, first select COM 1 and use the COM TEST (**F6**) function to communicate with a radio. If the test fails, select COM 2 and repeat COM TEST. Repeat the same procedure for COM 3 and COM 4. Make sure that all cables and power supplies are connected according to instructions provided in this manual.

Setting Screen Colors



From the MAIN MENU, press **F9** and then **F7** to access this screen.

MOTOROLA Radio Service Software MCS Model:	Use UP/DOWN Arrows to Select Choice.								
MAIN:CONFIGURATION:SCREEN COLORS									
SCREEN COLORS -----									
MONITOR TYPE.....Color									
TEXT.....Black									
STATUS TEXT.....Black									
MESSAGE TEXT.....Black									
HIGHLIGHT.....Red									
BACKGROUND.....Light Gray									
FRAME.....Black									
SELECTED TEXT.....Black									
POPUP BACKGROUND.....Cyan									
F1 HELP	F2	F3	F4	F5	F6	F7	F8 SAVE	F9	F10 EXIT

This screen is used to select the type of display monitor that you are using with your computer – Monochrome or Color. For proper color operation, you must have a color monitor and the appropriate color display interface card must be installed in your computer.

Note: Refer to the owner's manual that came with your computer and/or contact your computer dealer if you have questions regarding the color capability of your system.

You may also further customize your screen by selecting colors for the screen's text, status line, message line, highlighted text, background, frame, selected text and pop-up background.

Note: Screen configuration changes must be saved (**F8**) before you exit this screen.

Function Key Description

F8 - SAVE

Used to save the configuration information to a file on your program disk. Every time you use the RSS, the configuration that you saved last will be used. This configuration may be altered and saved at any time.

Field Definitions

Monitor Type	<p>Use the UP/DOWN arrow keys to select either monochrome or color display depending on the display capability of your monitor.</p> <p>The default is Monochrome.</p>
Text	<p>Use the UP/DOWN arrow keys to select the desired color for screen text.</p> <p>The default is Light Gray.</p>
Status Text	<p>Use the UP/DOWN arrow keys to select the desired color for status text which appears in the lower portion of the top right-side window.</p> <p>The default is Light Gray.</p>
Message Text	<p>Use the UP/DOWN arrow keys to select the desired color for message text which appears in the upper portion of the top right-side window.</p> <p>The default is Light Gray.</p>
Highlight	<p>Use the UP/DOWN arrow keys to select the desired color for highlighted screen text.</p> <p>The default is Yellow.</p>
Background	<p>Use the UP/DOWN arrow keys to select the desired color for the screen background.</p> <p>The default is Black.</p>
Frame	<p>Use the UP/DOWN arrow keys to select the desired color for the screen outline.</p> <p>The default is Light Gray.</p>
Selected Text	<p>Use the UP/DOWN arrow keys to select the desired color for selected text.</p> <p>The default is Light Gray.</p>
Pop-up Background	<p>Use the UP/DOWN arrow keys to select the desired color for the pop-up background.</p> <p>The default is Black.</p>

Notes

Basic Radio Programming Tutorial

2

Now that the hardware and software installation is complete, the RSS is up and running, and you are familiar with the RSS user interface, you are ready to personalize a radio. This section will walk you through the procedure of programming specific features into an MCS 2000 radio.

Programming a Basic MCS 2000 Radio

The tutorial assumes that the RSS is up and running and that you are at the MAIN MENU. (Refer to Section 1 for the RSS installation procedure.) Remember that **F1** displays help information about the currently highlighted field or the current screen. Press **F10** to back out of the RSS one menu level at a time.

Desired Features

Assume that the following features are desired:

- Transmit/Receive frequencies
- Tone Private-Line/Digital Private-Line (TPL/DPL) codes
- Two scan lists
- Telephone Operation enabled (*for full keypad models only*)

Note: For the purpose of this tutorial, we will assume that factory defaults are suitable for most parameter values.

Major Decisions Involved

To program the above features into the radio, the major decisions to be made are:

1. Determine the desired number of personalities (channels).
2. Determine the feature systems you wish to use (basic, scan, signalling, etc.).
3. Determine the desired features to program radio-wide (that is, for all channels).
4. Determine the desired features to program for each personality (*individual channels only*).

High-Level Programming Flow

The overview of the flow of programming in this example is as follows:

1. Read the radio.
2. Assign button/switch functions that differ from factory defaults.
3. Create a second scan list. (*List members must not be filled in at this time.*)
4. Set up the phone number list.
5. Create/configure conventional personalities.
6. Assign personalities to switch positions on the ZONE/CHANNEL ASSIGNMENT screen (**F4/F8**).
7. Fill in scan lists with the desired zone/channel entries.
8. Program the radio.

This programming flow was chosen because it minimizes navigation between screens.

Step-by-Step Programming Instructions

The directions in the rest of this chapter are designed to give you an overview of the radio programming procedure. Use the sample charts in this chapter to record the features that you wish to program into your radio. Refer to Appendix G for a blank form you can use in future when programming conventional radios.

Read Current Radio's Personality (Codeplug)

Before you can program the MCS 2000 radio, you must first read and access the current radio's personality (codeplug data). Follow these steps to read the codeplug:

1. At the MAIN MENU, press **F3** to bring up the GET/SAVE MENU.
2. Press **F2** to retrieve the radio's codeplug data. *A radio must be connected to your computer when you press F2.* A status bar will keep you updated as to how much of the codeplug has been read.

Program Radio-Wide Features

After the radio's codeplug data has been read, you will be able to access the CHANGE/VIEW MENU by pressing **F4** at the MAIN MENU. You can now program the features you want on a specific channel and the ones you want to be common to all channels. First, program the common (radio-wide) features as follows:

1. From the MAIN MENU, press **F4**, **F3** twice and then **F2** to bring up the BUTTON/ROTARY CONFIGURATION screen. The two-position concentric switch (Conventional Feature) will be highlighted.
2. Press enter to select the button which you want to put Scan on. Press "s" or use the UP/DOWN arrows keys until "Scan" appears.
3. Press **F10** twice to bring up the RADIO WIDE CONFIGURATION MENU.
4. Press **F5** to access the SCAN LIST screen. Scan List will be highlighted.
5. Press **F2** to add a second scan list. Scan List members can be added after zone/channel assignments have been made.

When you are done, press **F10** to return to the RADIO WIDE CONFIGURATION MENU.

Program the Phone List

Here's how to program the phone list:

1. Press **F4** at the RADIO WIDE CONFIGURATION MENU to bring up the PHONE LIST AND OPTIONS screen.
2. Press **Tab** to advance the prompt to the Phone Num Display Format field.
3. Use the UP/DOWN arrow keys to select USA.
4. Press **Tab** to advance to the Phone Number field, type in the desired phone number, and press **Enter**.
5. Press Enter to access the Phone Text field and type in the desired name.

Repeat steps 2 through 5 to add as many phone numbers and names as necessary.

When you're done, press **Esc** to return to the MAIN MENU.

Program Conventional Personalities

Follow these steps to program conventional personalities:

1. From the MAIN MENU, press **F4**, **F6** and then **F3** to bring up the CONVENTIONAL PERSONALITY screen.
2. Press **F2** and then **F3** as many times as necessary to add the desired number of personalities. When you are done, press **F4** to return to Personality 1.
3. Press **Tab** to advance to the Scan List field. Use the UP/DOWN arrow keys to select "1".
4. Press **Tab** to access the Phone Operation field. Use the UP/DOWN arrow keys to scroll for choices and select None, Unlimited or List Only.
5. Press **Tab** as many times as necessary until the Rx Frequency field is highlighted. Enter frequency data directly or use the UP/DOWN arrow keys to scroll through available choices.
6. Press **Tab** to go to the Rx Squelch Type field. Use the UP/DOWN arrow keys to select PL, DPL or CSQ.
7. Press **Tab** to advance the prompt to the Code field. Use the UP/DOWN arrow keys to scroll for choices, or enter the code directly.
8. Press **Tab** to advance the prompt to the Tx Frequency field. Enter frequency data directly or use the UP/DOWN arrow keys to select the desired frequency.
9. Press **Tab** to advance the prompt to the Tx Squelch Type field. Use the UP/DOWN arrow keys to select PL or DPL.
10. Press **F4** to advance to the next personality.

Repeat steps 3 through 10 for additional personalities as necessary.

11. Press **F10** twice to return to the CHANGE/VIEW MENU.

Program Zone/Channel Features

Now that the personalities are programmed, assign them to switch positions on the ZONE/TALKGROUP (CHANNEL) ASSIGNMENT screen.

1. From the CHANGE/VIEW MENU, press **F8** to access the ZONE/TALKGROUP (CHANNEL) ASSIGNMENT screen.
2. Press **F6** and then **F3** as many times as necessary to add the desired number of channels.
3. Press the **Pg Dn** key to return to page 1 if necessary.
4. Press **Tab** twice to go to the Channel Name field. Enter the desired name. *The name may be up to 11 characters in length but will vary depending on the radio model.*
5. Press **Enter** or **Tab** to advance to the Personality field. Use the UP/DOWN arrow keys to assign the desired Personality Type.
6. Press **Tab** to go to the Personality Number field. Enter the desired Personality number directly or use the UP/DOWN arrow keys to scroll through the available choices.

Repeat steps 5 and 6 for the remaining channels.

Note: *A maximum of 48 modes (channels) are allowed for model I MCS 2000 radios and 160 for HHCH models and models II and III. More may be ordered through an option upgrade.*

7. When you are done, press **F10** to return to the CHANGE/VIEW MENU.

Zones can be added on the ZONE/TALKGROUP (CHANNEL) ASSIGNMENT screen by pressing **F2**. The channels in a particular zone should be grouped in some logical way, based for instance on geographical area or work group.

Note: Each zone must contain at least one channel.

Fill in the Scan List

Here's how to fill in the scan list:

1. At the CHANGE/VIEW MENU, press **F3** and then **F5** to access the SCAN LIST screen. If "1" is not already displayed for Scan List number, press **F3** to see the previous list. If "1" is displayed, proceed.
2. Press **Tab** to advance the prompt to the Member Zone field. Type in the zone number of the channel to be scanned. For the purposes of this tutorial, type "1". Press **Enter** to select this zone number. The cursor will now be in the Channel field. Enter the channel number to be scanned.

Repeat step 2 until all desired channels are entered.

3. If you have created more than one scan list, repeat this list for each scan list.

When you are done, press **Esc** to return to the MAIN MENU.

Program Personality Into Radio Codeplug

Now that you have set values for all the features you want, it is time to actually program them into the radio. *Program data into the radio's codeplug only **after** creating or editing the radio 's codeplug data. Otherwise, the changes will be lost.*

From the MAIN MENU, press **F3** and then **F8** to bring up the PROGRAM RADIO screen. *Make sure that the radio is connected to the RIB and that both the RIB and the radio are powered up before pressing **F8**.*



Caution

When programming or tuning a radio DO NOT disconnect the radio from the RIB when the computer is communicating with the radio. This action may leave the radio in an inoperable state. Disconnect the radio **only** when you are in the MAIN MENU or GET/SAVE screens.

Program Personality Into Archive and Back-up Files

You have just saved the personality to the radio, but it is important to save it on disk too. Below are the steps to save the radio's personality to archive and back-up files.

1. Press **F3** and then **F7** from the MAIN MENU to bring up the SAVE CODEPLUG DATA TO ARCHIVE FILE screen. This screen displays the archive disk drive and path name, current model number, current radio serial number and programming information.
2. You will be prompted for an archive file path name. Change the path name if necessary.
3. Press **F8** at the SAVE ARCHIVE FILE screen to save the data in the archive file specified above.

Cloning Radios

Cloning is a process by which codeplug information is copied from one radio to another or to multiple others. In order for one radio to be cloned with information from another, they must be of the same model type and version.

Radio codeplugs consist of both personality and tuning data. Cloning allows you to “merge” two codeplugs. The result of the cloning process will be an “image” that can be programmed into a radio and/or saved to an archive file. This image will have the personality of the “source” codeplug. However, the tuning data of the target codeplug will remain unchanged.

The archive file or radio with the personality chosen for cloning purposes is referred to as the “source file” or “source radio”. The other radio is referred to as the “target radio”.

Cloning applies predominantly to conventional-only radios. *In order to clone trunked radios, you must have a system key for each of the trunked systems programmed into the source radio on file.* Most organizations that program trunked radios will not have access to these keys. The process for cloning conventional and trunked radios, however, is the same.

To clone a radio, you will have to:

- Read into the RSS the specific archive file you have chosen as the “source” for cloning purposes
- Clone that source file into the current (target) radio's codeplug
- Clone the remaining radios in the same manner

Follow the procedure below to clone a radio:

1. Press **F3** twice from the MAIN MENU to bring up the ARCHIVE FILES screen. A list of file names will be displayed. These file names reflect the serial numbers that the RSS found in the archive path specified. The name of the file that you saved in the first tutorial should appear in this list. If not, type in the correct archive path name in the Archive field.
2. Press **Tab** until the desired file is highlighted.
3. Press **F8** to retrieve the highlighted file.
4. Press **F10** to return to the GET/SAVE/PROGRAM MENU.
5. Assemble the hardware and connect the radio that you wish to clone.
6. Press **F5** at the GET/SAVE/PROGRAM MENU to bring up the CLONE MENU.
7. Press **F2** to read the serial number from the target radio.
8. Press **F8** to program the current codeplug data into the target radio. The cloning process will automatically check for compatibility of the two radios.

Note: You will receive an error message if cloning cannot be performed for any reason. Check all connections or refer to Appendix A for error codes and their explanations.

9. Once cloning is completed, make sure you are at the GET/SAVE/PROGRAM MENU or MAIN MENU and then disconnect the radio.



Caution

When programming or tuning a radio DO NOT disconnect the radio from the RIB when the computer is communicating with the radio. This action may leave the radio in an inoperable state. Disconnect the radio **only** when you are in the MAIN MENU or GET/SAVE screens.

Repeat steps 6 through 10 to clone additional radios as necessary.

Note: The IDs for MDC-1200, DTMF, etc. must be changed manually if you want to have unique IDs. You may do this from CHANGE/VIEW sub-menus immediately after cloning each radio.

Exit the RSS

Press **Esc** to back up to the MAIN MENU. At the MAIN MENU, press **F10** and then **F2** to exit to DOS.

Service Menu Functions

Servicing the Radio Using the RSS

Now that the hardware and software installation is complete and the RSS is up and running, you are ready to personalize the radio(s). The following pages are constructed in such a manner that a qualified service technician can keep a radio at full capability throughout its design life by means of correct alignments and configurations.

Note: All functions (supported and unsupported) will be displayed in the menu's working area. The unsupported functions (based on the radio's model or options) will NOT be displayed in the F-key ID area.

Menu Map

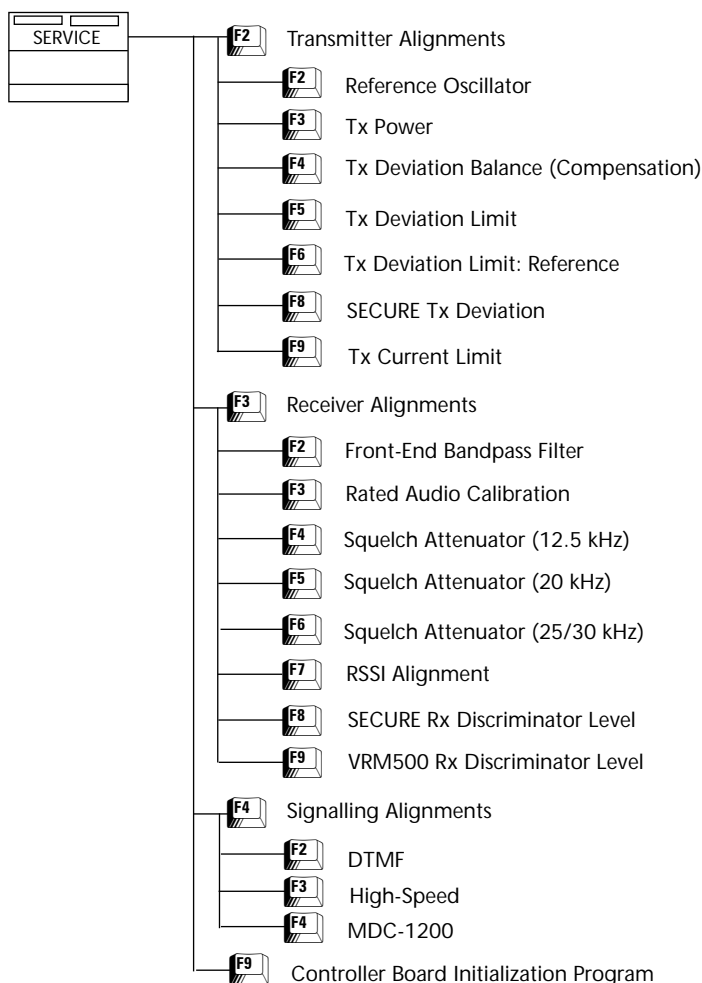

Service Menu



Press **F2** at the MAIN MENU to access the SERVICE MENU.

MOTOROLA Radio Service Software MCS Model: MAIN:SERVICE	Select Function F1 - F10. Read Radio Completed Successfully.								
SERVICE MENU -----									
F1 - HELP F2 - Transmitter Alignments F3 - Receiver Alignments F4 - Signalling Alignments F5 - F6 - F7 - F8 - F9 - Controller Board Initialization Program F10 - Exit, Return to Main Menu									
F1 HELP	F2 TX ALIGN	F3 RX ALIGN	F4 SIGNAL ALIGN	F5	F6	F7	F8	F9 BOARD INITIALIZE	F10 EXIT

All radio alignment and board replacement procedures are accessed from this menu. A radio must be connected to your computer using a RIB and cables and the radio turned on before you will be permitted to access the service screens.



Caution

Do NOT switch radios in the middle of any SERVICE procedure. Always use the EXIT function key (F10) to return to the MAIN MENU before disconnecting the radio. Improper exits from service screens may leave the radio in an improperly configured state, resulting in seriously degraded radio or system performance.

Refer to your Radio Service Manual for detailed service procedures.

Note: If the radio connected to the RIB is a CBI-initialized radio and you press **F2**, **F3** or **F4** in the SERVICE MENU, the RSS will display the following pop-up message: “!!!Warning!!! You cannot read, program, or tune a CBI radio until you initialize it.” Press **F9** to initialize the radio.

Note: If the radio connected to the RIB is NOT a CBI-initialized radio and you press **F9** from the SERVICE MENU, the RSS will display the following pop-up message: “!!!Warning!!! The radio attached to the RIB is not a CBI-initialized radio.”

Function Key Descriptions

F2 - Tx ALIGN
(Transmitter Alignment)

Used to perform standard radio transmitter alignment procedures. Standard periodic alignment procedures are performed from this menu.

Note: *Radio compensation/deviation adjustments must be made prior to performing the signalling deviation adjustment.* No adjustments are required for DPL, PL or Trunking Connect Tone deviation.

The following alignment procedures must be performed whenever any of the modulation circuitry is replaced:

- Modulation Balance
- Modulation Limit: VCO Attenuator
- Modulation Limit: Reference Attenuator

In addition, all signalling modulation limit alignments (DTMF, MDC, Single Tone, SECURE and High Speed Trunking Data) should be checked.

F3 - Rx ALIGN
(Receive Alignment)

Brings up a menu through the sub-menus of which you can perform standard radio receive alignment procedures.

F4 - SIGNAL ALIGN
(Signalling Alignment)

Brings up a menu through the sub-menus of which you can perform deviation alignment for DTMF, Trunking and MDC signalling.

F9 - BOARD INITIALIZE
(Controller Board Initialization Program)

This screen can be accessed only when a CBI-programmed radio is connected to the computer via the RIB. Brings up the CONTROLLER BOARD INITIALIZATION screen where you can transfer codeplug information from the computer to the radio codeplug.

Note: A CBI radio and RIB must be properly connected to the computer and the power turned on before you press **F9**.

Note: If the radio connected to the RIB is NOT a CBI-initialized radio and you press **F9** from the SERVICE MENU, the RSS will display the following pop-up message: “!!!Warning!!! The radio attached to the RIB is not a CBI-initialized radio.”



Caution

Transmitter, Receiver and Signalling Alignment AND CBI Initialization procedures should be attempted only by qualified service personnel. Failure to perform alignment procedures properly may result in a seriously degraded radio or system performance. Refer to your Radio Service Manual for detailed service procedures.

Transmitter Alignment Menu



From the MAIN MENU, press **F2** twice to access the TRANSMITTER ALIGNMENT MENU.

MOTOROLA Radio Service Software MCS Model: ...SERVICE:TRANSMITTER ALIGNMENT MENU	Select Function F1 - F10.																														
TRANSMITTER ALIGNMENT MENU ----- F1 - HELP F2 - Reference Oscillator F3 - Tx Power F4 - Tx Deviation Balance (Compensation) F5 - Tx Deviation Limit F6 - Tx Deviation Limit: Reference F7 - F8 - Secure Tx Deviation F9 - Tx Current Limit F10 - Exit, Return to Service Menu																															
<table style="width: 100%; border-collapse: collapse;"> <tr> <td style="text-align: center;">F1</td> <td style="text-align: center;">F2</td> <td style="text-align: center;">F3</td> <td style="text-align: center;">F4</td> <td style="text-align: center;">F5</td> <td style="text-align: center;">F6</td> <td style="text-align: center;">F7</td> <td style="text-align: center;">F8</td> <td style="text-align: center;">F9</td> <td style="text-align: center;">F10</td> </tr> <tr> <td style="text-align: center;">HELP</td> <td style="text-align: center;">REF</td> <td style="text-align: center;">TX</td> <td style="text-align: center;">DEV</td> <td style="text-align: center;">DEV</td> <td style="text-align: center;">REF</td> <td></td> <td style="text-align: center;">SECURE</td> <td style="text-align: center;">CUR</td> <td style="text-align: center;">EXIT</td> </tr> <tr> <td></td> <td style="text-align: center;">OSC</td> <td style="text-align: center;">PWR</td> <td style="text-align: center;">BAL</td> <td style="text-align: center;">LIMIT</td> <td style="text-align: center;">ATTEN</td> <td></td> <td style="text-align: center;">DEV</td> <td style="text-align: center;">LIMIT</td> <td></td> </tr> </table>		F1	F2	F3	F4	F5	F6	F7	F8	F9	F10	HELP	REF	TX	DEV	DEV	REF		SECURE	CUR	EXIT		OSC	PWR	BAL	LIMIT	ATTEN		DEV	LIMIT	
F1	F2	F3	F4	F5	F6	F7	F8	F9	F10																						
HELP	REF	TX	DEV	DEV	REF		SECURE	CUR	EXIT																						
	OSC	PWR	BAL	LIMIT	ATTEN		DEV	LIMIT																							

Standard periodic alignment procedures are performed from this menu. Refer to your Radio Service Manual for alignment procedures.

The following alignment procedures must be performed every time the modulation circuitry is replaced:

- Modulation Balance
- Modulation Limit: VCO Attenuator
- Modulation Limit: Reference Attenuator

In addition, signalling deviation for DTMF, MDC, Single Tone, SECURE and High-Speed Trunking Data should be checked every time the radio is serviced. Prior to adjusting signalling deviation, radio compensation/deviation adjustments must be made. No adjustments are required for DPL, PL or Trunking Connect Tone Deviation.

 Caution	These procedures should be attempted only by qualified service personnel. Failure to perform alignment procedures properly may result in seriously degraded radio or system performance.
--	--

Function Key Descriptions

F2 - REF OSC
(Reference Oscillator Alignment)

Refer to your Radio Service Manual for the Reference Oscillator Alignment procedure. *This procedure should be attempted only by qualified service personnel.*

F3 - Tx PWR
(Transmit Power Alignment)

Refer to your Radio Service Manual for the Transmitter Power Alignment procedure. *This procedure should be attempted only by qualified service personnel.*

F4 - DEV BAL
(Transmit Deviation Balance
[Compensation] Alignment)

Refer to your Radio Service Manual for the Transmit Deviation Balance (Compensation) Alignment procedure. *This procedure should be attempted only by qualified service personnel.*

F5 - DEV LIMIT
(Transmit Deviation Limit
Alignment)

Refer to your Radio Service Manual for the Transmit Deviation Limit Alignment procedure. *This procedure should be attempted only by qualified service personnel.*

F6 - REF ATTEN
(Reference Softpot)

Refer to your Radio Service Manual for the Transmitter Deviation Limit Alignment Reference Softpot procedure. *This procedure should be attempted only by qualified service personnel.*

F8 - SECURE DEV
(SECURE Transmit Deviation)

Refer to your Radio Service Manual for the SECURE Transmit Deviation Alignment procedure. *This procedure should be attempted only by qualified service personnel.*

F9 - CUR LIMIT
(Transmit Current Limit)

This screen can be accessed only for VHF and UHF frequency band models. Refer to your Radio Service Manual for the Transmit Current Limit procedure. *This procedure should be attempted only by qualified service personnel.*

Function Key Descriptions

F6 - TOGGLE PTT Alternately keys and de-keys the radio being serviced.

F8 - PROGRAM VALUE Programs the selected value into the radio.

Field Definitions

New Softpot Value High Pwr This is the high power attenuation (softpot) for this frequency. The status bar shows this setting in relation to the minimum and maximum settings. *This value determines the amount of attenuation, not the actual level of transmitted power.*

New Softpot Value Low Pwr This is the low power attenuation (softpot) for this frequency. The status bar shows this setting in relation to the minimum and maximum settings. *This value determines the amount of attenuation, not the actual level of transmitted power.*

Transmit Deviation Balance Alignment



From the MAIN MENU, press **F2** twice and then **F4** to access this screen.

MOTOROLA Radio Service Software MCS Model:		Use UP/DOWN Arrows To Adjust Softpot.
.TRANSMIT DEVIATION BALANCE (COMPENS)		
TRANSMIT DEVIATION BALANCE (COMPENSATION)		

	Current	
Frequency	Value	New Softpot Value

136.0125	32	32
144.0125	32	32
154.0125	32	32
160.0125	32	32
167.5125	31	31
173.9875	29	29
177.9875	30	30
	Transmitter..Off	30
0		63
MIN	-----+-----+-----+-----X-----+-----+-----+-----	MAX
F1 HELP	F2	F3
F4	F5	F6 TOGGLE PTT
F7	F8 PROGRAM VALUE	F9
F10 EXIT		

Balanced Attenuator Alignment is required after replacing (or servicing) the Controller Board or the RF Board. Balanced attenuator alignment balances the modulation contributions of the low and high frequency portions of a baseband signal.

 Caution	<p>This procedure should be attempted only by qualified service personnel. Failure to perform alignment procedures properly may result in seriously degraded radio or system performance.</p> <p>Proper compensation alignment is critical to the operation of signalling schemes that have very low frequency components (DPL for instance) and could result in distorted waveforms if improperly adjusted.</p>
--------------------	--

Refer to your Radio Service Manual for the Transmit Deviation Balance Alignment (Compensation) procedure. This procedure needs to be performed at multiple frequencies to allow for proper alignment across the entire RF band. The transmit and receive bands are divided into frequency zones with a calibration point (value) in each zone. Compensation alignment will be automatically calculated when you perform this procedure.

Programming Procedure

1. Press **F6** to key up the radio. (The radio's RF output must be terminated into a 50 ohm load.)
2. Apply the appropriate signal according to instructions in your Radio Service Manual.
3. While transmitting, modify the Balance Attenuator setting using the UP/DOWN arrow keys. To increase the adjustment speed, use the Shift-UP/DOWN arrow keys.
4. A relative Tx power value will be displayed, but you must determine the actual transmitter power output from the service monitor.
5. Press **F6** to de-key the radio and **Tab** to move between frequency points.
6. Press **F8** to save the new value.

Function Key Descriptions

F6 - TOGGLE PTT

Alternately keys and de-keys the radio being serviced.

F8 - PROGRAM VALUE

Programs the selected value into the radio.

Field Definition

New Softpot Value

This is the balance value for this frequency. The status bar shows the relationship between this setting and the minimum and maximum settings.

Function Key Descriptions

F6 - TOGGLE PTT Alternately keys and de-keys the radio being serviced.

F8 - PROGRAM VALUE Programs the selected value into the radio.

Field Definitions

New Softpot Value This is the VCO softpot value for this frequency. The status bar shows the relationship between this setting and the minimum and maximum settings.

Function Key Descriptions

F6 - TOGGLE PTT Alternately keys and de-keys the radio being serviced.

F8 - PROGRAM VALUE Programs the selected value into the radio.

Field Definitions

New Softpot Value This is the softpot value for this frequency. The status bar shows the relationship between this setting and the minimum and maximum settings.

20 kHz This is the working Reference Attenuator value. The status bar shows the relationship between this setting and the minimum and maximum settings.

12.5 kHz This is the working Reference Attenuator value. The status bar shows the relationship between this setting and the minimum and maximum settings.

Transmit Current Limit



From the MAIN MENU, press **F2** twice and then **F9** to access the TRANSMIT CURRENT LIMIT screen.

MOTOROLA Radio Service Software MCS Model:					Use UP/DOWN Arrows To Adjust Softpot.				
...CURRENT LIMIT									
CURRENT LIMIT -----									
Frequency		Current Value			New Softpot Value				
-----		-----			-----				
177.9875		27 0			27 (> 14.5V) (11.9-14.5V) (< 11.9V)				
Transmitter..Off									
0					63				
MIN		-----+-----+-----+-----+-----+-----+-----+-----+-----+-----			MAX				
F1 HELP	F2	F3	F4	F5	F6 TOGGLE PTT	F7	F8 PROGRAM VALUE	F9	F10 EXIT

800/900 MHz Models Only

MOTOROLA Radio Service Software MCS Model:					Use UP/DOWN Arrows To Adjust Softpot.				
...CURRENT LIMIT									
CURRENT LIMIT -----									
Frequency		Current Value			New Softpot Value				
-----		-----			-----				
136.0125		38			38				
144.0125		38			38				
154.0125		38			38				
160.0125		38			38				
167.5125		38			38				
173.9875		38			38				
177.9875		38			38				
Transmitter..Off									
0					63				
MIN		-----+-----+-----+-----+-----+-----+-----+-----+-----+-----			MAX				
F1 HELP	F2	F3	F4	F5	F6 TOGGLE PTT	F7	F8 PROGRAM VALUE	F9	F10 EXIT

UHF/VHF Models Only

Transmit Current Limit should be checked every time the RF Board is replaced. This alignment procedure limits the transmitter current drain of the radio.

 Caution	<p>This procedure should be attempted only by qualified service personnel. Failure to perform alignment procedures properly may result in seriously degraded radio or system performance.</p>
--------------------	---

Refer to your Radio Service Manual for the Transmit Current Limit Alignment procedure.

Programming Procedure

1. Press **F6** to key up the radio. (The radio's RF output must be terminated into a 50 ohm load.)
2. While transmitting, measure the current drain on the first test frequency.
3. Press **F6** to de-key the radio.
4. Use the **Tab** key to move to the next frequency point and measure the current again.

Repeat the above steps for each frequency.

5. Select the frequency which has the highest current reading using the **Tab** key.
6. While transmitting, use the UP/DOWN arrow keys to adjust the Transmit Current Limit according to instructions in the Radio Service Manual. *This procedure needs to be performed only on a single frequency since all other frequencies will be adjusted automatically.*
7. Press **F8** to save the new values.

Function Key Descriptions

F6 - TOGGLE PTT

Alternately keys and de-keys the radio being serviced.

Note: All new softpot values will be updated with values programmed into the radio.

F8 - PROGRAM VALUE

Programs the selected value into the radio.

Field Definitions

New Softpot Value

This is the current limit softpot which limits the amount of transmit current drain at any frequency across the band. It should be tuned at the test frequency resulting in the highest current at rated output power for optimal performance. Therefore, output power should be tuned first. The status bar shows the current setting in relation to the minimum and maximum settings.

Receive Alignment Menu



From the MAIN MENU, press **F2** and then **F3** to access this screen.

MOTOROLA Radio Service Software MCS Model:	Select Function F1 - F10.								
MAIN:SERVICE:RECEIVER ALIGNMENT MENU									
RECEIVER ALIGNMENT MENU ----- F1 - HELP F2 - Front End Bandpass Filter F3 - Rated Audio Calibration F4 - Squelch Attenuator (12.5kHz) F5 - Squelch Attenuator (20kHz) F6 - Squelch Attenuator (25/30kHz) F7 - RSSI Alignment F8 - Secure Rx Discriminator Level F9 - VRM500 Rx Discriminator Level F10 - Exit, Return to Service Menu									
F1	F2	F3	F4	F5	F6	F7	F8	F9	F10
HELP	FRONT END	AUDIO	SQUELCH	SQUELCH	SQUELCH	RSSI	SECURE	VRM500	EXIT
	FILT	ALGN	12.5kHz	20kHz	25/30kHz	ALGN	DISCR		

Standard periodic receiver alignment procedures are performed from this menu. Refer to your Radio Service Manual for Receive Alignment procedures.



Caution

This procedure should be attempted only by qualified service personnel. Failure to perform alignment procedures properly may result in seriously degraded radio or system performance.

Function Key Descriptions

F2 - F9

Refer to your Radio Service Manual for these alignment procedures. *Do NOT attempt these procedures unless you are a qualified service person.*

Note: *The VRM500 Rx DISCRIMINATOR LEVEL screen can be accessed only if the current radio model is VRM500-capable.*

Front-End Filter Alignment



From the MAIN MENU, press **F2**, **F3** and then **F2** to access this screen.

MOTOROLA Radio Service Software MCS Model:		Use UP/DOWN Arrows To Adjust Softpot.
...FRONT END FILTER (VHF & UHF ONLY)		
FRONT END FILTER (VHF & UHF ONLY)		
Frequency	Current Value	New Softpot Value
-----	-----	-----
136.0625	20	20
144.0625	25	25
154.0625	33	33
160.0625	38	38
167.5625	47	47
173.9375	56	56
177.9375	60	60
0		63
MIN	-----X+-----	-----
F1	F2	F3
F4	F5	F6
F7	F8	F9
F10	PROGRAM	F10
HELP	VALUE	EXIT

This alignment procedure is required every time the RF Board is replaced or serviced. This alignment adjusts the corner frequencies of an RF front-end bandpass filter. It needs to be performed at multiple frequencies to allow for proper alignment across the entire RF band. The RF band is divided into frequency zones with a calibration point (value) in each zone.



Caution This procedure should be attempted only by qualified service personnel. Failure to perform alignment procedures properly may result in seriously degraded radio or system performance.

Refer to your Radio Service Manual for the Front-End Filter Alignment procedure.

Programming Procedure

1. Apply the appropriate RF signal to the radio.
2. Modify the Rx Front End Filter Softpot setting using the UP/DOWN arrow keys.
3. Use the **Tab** key to move between frequency points.
4. Press **F8** to save the new values.

Function Key Descriptions

F8 - PROGRAM VALUE

Programs the selected value into the radio.

Field Definition

New Softpot Value

This is the softpot value for this frequency. The status bar shows the relationship between this setting and the minimum and maximum settings.

Rated Audio Alignment



From the MAIN MENU, press **F2**, **F3** and then **F3** to access this screen.

MOTOROLA Radio Service Software MCS Model:		Use UP/DOWN Arrows To Adjust Softpot.
..RECEIVER ALIGNMENT MENU:RATED AUDIO		
RATED AUDIO -----		
Frequency -----	Current Value -----	New Softpot Value -----
167.5625	Std. Audio.....230	Std. Audio.....230
0 MIN -----+-----X+----- MAX		
F1 HELP	F2	F3
F4	F5	F6
F7	F8 PROGRAM VALUE	F9
F10 EXIT		

This alignment is required every time the Controller Board or the RF Board is replaced or serviced. This procedure adjusts for rated audio power across the radio speaker.

 Caution	This procedure should be attempted only by qualified service personnel. Failure to perform alignment procedures properly may result in seriously degraded radio or system performance.
-------------	--

Refer to your Radio Service Manual for the Rated Audio Calibration procedure.

Programming Procedure

1. Apply the appropriate RF signal to the radio.
2. Modify the Rated Audio Volume Softpot setting using the UP/DOWN arrow keys.
3. Press **F8** to save the new values.

Function Key Descriptions

F8 - PROGRAM VALUE

Programs the selected value into the radio.

Field Definition

New Softpot Value

This is the softpot value for this frequency. The status bar shows the relationship between this setting and the minimum and maximum settings.

Std. Audio

This is the working rated volume softpot value. The status bar shows the relationship between this setting and the minimum and maximum settings.

Signalling Alignment Menu



From the MAIN MENU, press **F2** and then **F4** to access this screen.

MOTOROLA Radio Service Software MCS Model: ...SERVICE:SIGNALLING ALIGNMENT MENU	Select Function F1 - F10.								
SIGNALLING ALIGNMENT MENU -----									
F1 - HELP F2 - DTMF F3 - High Speed F4 - MDC 1200 F5 - F6 - F7 - F8 - F9 - F10 - Exit, Return to Service Menu									
F1 HELP	F2 DTMF ALIGN	F3 HIGH SPEED	F4 MDC 1200	F5	F6	F7	F8	F9	F10 EXIT

Standard periodic receiver alignment procedures are performed from this menu. *Signalling deviation should be checked any time the radio is serviced and must be adjusted whenever any of the modulation circuitry has been replaced.*

Note: All radio compensation/deviation adjustments must be made before adjusting signalling deviation.



Caution

This procedure should be attempted only by qualified service personnel. Failure to perform alignment procedures properly may result in seriously degraded radio or system performance.

Function Key Descriptions

F2 - F4

Refer to your Radio Service Manual for these alignment procedures.

DTMF Transmit Deviation



From the MAIN MENU, press **F2**, **F4** and then **F2** to access the DTMF TRANSMIT DEVIATION screen.

MOTOROLA Radio Service Software MCS Model:					Use UP/DOWN Arrows To Adjust Softpot.				
...DTMF TRANSMIT DEVIATION									
DTMF TRANSMIT DEVIATION -----									
Frequency	Current Value							New Softpot Value.....	
136.01250	21							21	
Transmitter..Off									
0									31
MIN	-----+-----+-----+-----+-----+-----+-----+-----+-----+-----								MAX
F1	F2	F3	F4	F5	F6	F7	F8	F9	F10
HELP					TOGGLE PTT		PROGRAM VALUE		EXIT

DTMF deviation should be checked every time the radio is serviced and must be adjusted whenever the Controller Board or RF Board is replaced. It is also required following Modulation balance and Modulation Limit (VCO or Reference) alignments.

Note: All radio compensation/deviation adjustments must be made before adjusting DTMF deviation.



Caution

This procedure should be attempted only by qualified service personnel. Failure to perform alignment procedures properly may result in seriously degraded radio or system performance.

Refer to your Radio Service Manual for the DTMF Transmit Deviation Alignment procedure.

Programming Procedure

1. Press **F6** to key up the radio. (The radio's RF output must be terminated into a 50 ohm load.)
2. While transmitting, modify the DTMF Attenuator setting using the UP/DOWN arrow keys.
3. Press **F6** to de-key the radio.
4. Press **F8** to save the new values.

Function Key Descriptions

F6 - TOGGLE PTT

Alternately keys and de-keys the radio being serviced.

F8 - PROGRAM VALUE

Programs the selected value into the radio.

Field Definitions

New Softpot Value

This is the working DTMF Attenuator value. The status bar shows the relationship between this setting and the minimum and maximum settings.

Field Definitions

New Softpot Value

This is the working MDC-1200 Attenuator value. The status bar shows the relationship between this setting and the minimum and maximum settings.

Controller Board Initialization



From the MAIN MENU, press **F2** and then **F9** to access the CONTROLLER BOARD INITIALIZATION screen.

MOTOROLA Radio Service Software MCS Model: MAIN:SERVICE:CBI									
CONTROLLER BOARD INITIALIZATION ----- Serial Number.....###ABC?### Model Number.....XXXXXXXXXXXX FLASHcode.....XXXXX-XXXXX-X									
F1 HELP	F2	F3	F4	F5	F6	F7	F8 PROGRAM RADIO	F9	F10 EXIT

*This screen can be accessed from the SERVICE MENU only when a CBI-programmed radio is connected to the computer via the RIB. If not, the RSS will display an error message. This screen allows you to transfer codeplug information from the computer to the radio codeplug. Enter a valid serial number and press **F8** to proceed.*

Note: A CBI radio and RIB must be properly connected to the computer and the power turned on before you press **F8**.

Note: If the radio connected to the RIB is NOT a CBI-initialized radio and you press **F9** from the SERVICE MENU, the RSS will display the following pop-up message: “!!!Warning!!! The radio attached to the RIB is not a CBI-initialized radio.”



Caution

DO NOT turn off the radio or disconnect the radio from the computer while it is attempting to program the codeplug. Interrupting the programming process will destroy codeplug contents and completely disable the radio.

Function Key Descriptions

F8 - PROGRAM RADIO

Programs the selected value into the radio. The RSS will display the following message: “!!!Warning!!! Continue to program the following serial number into the CBI radio: <Serial Number>.” Press **F2** to proceed with the initialization and **F10** to cancel.

Note: If communication with the radio fails, the RSS will display a pop-up error message. Check you cable connections and try again.



Caution

Once the radio is programmed with the serial number you provided, you will NOT be able to reprogram the radio with a different one.

Field Definitions

Serial Number

Enter the serial number of the radio you wish to initialize. This number can be found on the outside casing of the radio.

Note: You will NOT be able to initialize the CBI radio unless you enter a valid serial number.



Caution

Once the radio is programmed with the serial number you provided, you will NOT be able to reprogram the radio with a different one.

Model Number

This is a read-only field. It displays the model number of the radio currently attached to the computer using the RIB. The model number is retrieved from the radio's controller board and is displayed for verification purposes only.

FLASHcode

This is a read-only field. It displays the FLASHcode of the radio currently attached to the computer using the RIB. The FLASHcode is retrieved from the radio's controller board and is displayed for verification purposes only.

Notes

Get/Save/Program Menu Functions

4

This section describes all the functions available from the GET/SAVE/PROGRAM MENU. To guide you through these functions, GET/SAVE/PROGRAM-related menus and screens are shown with their respective programming procedures from the MAIN MENU, function key descriptions and field definitions.

Note: All functions (supported and unsupported) will be displayed in the menu's working area. The unsupported functions (based on the radio's model or options) will NOT be displayed in the F-key ID area.

Menu Map

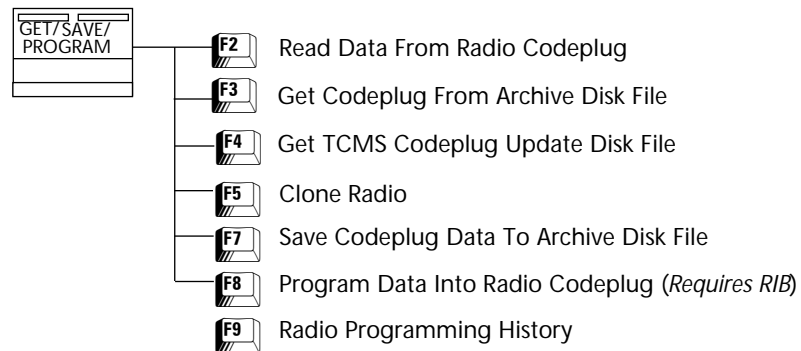

Get/Save/Program Menu

At the MAIN MENU, press **F3** to bring up this screen.



MOTOROLA Radio Service Software MCS Model:	Select Function F1 - F10.								
MAIN:GET/SAVE/PROG									
<p>GET/SAVE/PROGRAM MENU -----</p> <p>F1 - HELP F2 - Read Data from Radio Codeplug (Requires RIB) F3 - Get Codeplug Data from Archive Disk File F4 - Get TCMS Codeplug Update Disk File F5 - Clone Radio F6 - F7 - Save Codeplug Data to Archive Disk File F8 - Program Data into Radio Codeplug (Requires RIB) F9 - Radio Programming History F10 - Exit</p>									
F1 HELP	F2 READ RADIO	F3 GET ARCHIVE	F4	F5 CLONE RADIO	F6	F7 SAVE ARCHIVE	F8 PROGRAM RADIO	F9 VIEW HISTORY	F10 EXIT

GET/SAVE/PROGRAM functions are used to transfer codeplug data from your radio or an archive file into your computer so that you can change, view or print the data. These functions also permit you to program modified data back into your radio and save a copy of the codeplug data in an archive file.

 Caution	<p>Do NOT turn off the radio or disconnect it from the computer while attempting to program the codeplug. Interrupting the programming process will destroy the codeplug contents and completely DISABLE the radio!</p>
--	---

Note: You CANNOT read, clone or program a CBI-initialized radio from this menu. If you try to do so, you will receive a message informing you that you must initialize the controller board first. Bring up the CONTROLLER BOARD INITIALIZATION screen (**F2/F9**) to initialize the radio.

Function Key Descriptions

F2 - READ RADIO (Read Radio Codeplug)

Reads the information (data) stored in the radio codeplug (EEPROM) and transfers it to computer memory. *A radio and RIB must be properly connected to the computer and power turned on before you press this key.* The status of the READ operation will be displayed at the bottom of the screen.

Note: The time required to read a codeplug will depend directly on your computer type and the size of the codeplug you are reading.

F3 - GET ARCHIVE

Retrieves an archive file from a disk and loads the data into computer memory. Once it is retrieved, the file may be modified using CHANGE/VIEW functions or programmed into a radio.

F4 - MERGE TCMS

This function is used to update the codeplug information with trunking information from the TCMS (Trunking Code Management System). The required changes must first be entered into the TCMS database through a TCMS terminal, and then downloaded using a modem and the TCMS On-Line Field Programming (OFP) software package.

F5 - CLONE RADIO

Copies codeplug information from one radio to another. *Only radios with the same model number may be cloned.* The screen summarizes the individual ID information for both MDC and Trunking so that both can be changed easily from the same screen. *Trunked radios cannot be cloned unless System Keys have been loaded for each Trunking system ID.*

F7 - SAVE ARCHIVE

Creates (or updates) an archive copy of the codeplug information on a disk. It is strongly recommended that you retain an archive copy of every radio installed or serviced. You will then be able to quickly restore customer information in case of a codeplug failure.

F8 - PROGRAM RADIO

Transfers codeplug information from the computer to the radio codeplug. *A radio and RIB must be properly connected to the computer and power turned on before you attempt this function.* The status of the programming operation is displayed at the bottom of the screen.

Note: The time required to program a codeplug will depend directly on your computer type and the size of the codeplug you are programming.

F9 - VIEW HISTORY

Provides all the information about the last time the radio was programmed. This includes data on when and how the radio was programmed.



Caution

If software versions of the radio and the current data are not compatible, read the radio codeplug and enter the data again. Conventional data can be entered from the RSS screens or cloned from another radio.

Get Codeplug Data From Archive File



From the MAIN MENU, press **F3** twice to access this screen.

MOTOROLA Radio Service Software MCS Model:		Press Enter to Select File Name. Press F8 to Load Codeplug File.							
MAIN:GET/SAVE/PROG:GET FILE									
Archive:C:\MRSS\MCS\ARCHIVE									
<p style="text-align: center;">ARCHIVE FILES -----</p> <p>A466ASNO.331 A467ASNO.361 A469ASNO.431</p>									
F1 HELP	F2 CHANGE ARCHIVE	F3	F4	F5 DELETE SELECTED	F6 CHDIR UP	F7 CHDIR DOWN	F8 GET ARCHIVE	F9	F10 EXIT

The GET ARCHIVE function is used to retrieve an archive file from a disk. Once retrieved, the file may be modified using the CHANGE/VIEW functions or programmed into a radio.

Note: Upper case names represent sub-directories and lower case names represent file names.

Programming Procedure

1. Press **Tab** to select the serial number of the radio to be retrieved.
2. Press the **F8** function key to retrieve the selected file.

Function Key Descriptions

F2 - CHANGE ARCHIVE

Used to specify the directory path where the archive file will be located. The default archive path will always be the default path specified in the CONFIGURE PATHS AND PORT screen (**F9/F3**).

F5 - DELETE SELECTED

Allows you to delete the selected archive file. You will be prompted before the file is deleted.

F6 - CHDIR UP

Used to move one level up the directory structure.

F7 - CHDIR DOWN

Used to move one level down the directory structure. Press **Tab** to select a directory. The contents of the directory will be displayed.

F8 - GET ARCHIVE

Retrieves the highlighted archive file. The computer will read the radio serial number and search the specified directory path for an archive file corresponding to that serial number. Only the specified path will be searched. Once the file is located, the computer will retrieve the file and return you to the GET/SAVE/PROGRAM MENU.

Get TCMS Codeplug Update Disk File



From the MAIN MENU, press **F3** then **F4** to access this screen.

MOTOROLA Radio Service Software MCS Model:	Enter Path								
MAIN:GET/SAVE/PROG:MERGE									
TCMS Path	<input type="text"/>								
S/N:	MERGE FORM -----								
F1 HELP	F2	F3	F4	F5	F6	F7	F8 Update Data	F9	F10 EXIT

This screen is used to update the codeplug information with trunking information from the TCMS (Trunking Code Management System). The required changes must first be entered into the TCMS database through a TCMS terminal, and then downloaded using a modem and the TCMS On-Line Field Programming (OFP) software package.

Field Definition

TCMS Path

Enter the directory path for the directory which contains the TCMS Merge files.

The default archive path will always be the specified default path from the SETUP Menu (See MAIN MENU, **F9**).

TCMS Merge Procedure:

1. Enter the changes into the TCMS database.
2. Download a DOS file with this new trunking information. [Refer to the TCMS On-Line Field Programming (OFP) software manual].
3. Use the GET/SAVE functions to either Read the radio codeplug or Get the archive file for the radio to be updated.
4. Access the MERGE TCMS screen and press **F8** to update the codeplug information.

Clone Radio



From the MAIN MENU, press **F3** and then **F5** to access the TRUNKED CLONING screen.

MOTOROLA Radio Service Software MCS Model:		Select Function F1 - F10.																															
MAIN:GET/SAVE/PROG:CLONE RADIO																																	
NEW TRUNKING IDS																																	
Serial Number.....		-----																															
Pers #	System Key	Type	System # ID Flt/ATG Type I II/III Indv ID Indv ID																														
-----	-----	-----	-----																														
01	Disabled	II	01 0001 None ----- 0001																														
<table border="0" style="width: 100%; text-align: center;"> <tr> <td>F1</td><td>F2</td><td>F3</td><td>F4</td><td>F5</td><td>F6</td><td>F7</td><td>F8</td><td>F9</td><td>F10</td> </tr> <tr> <td>HELP</td><td>READ</td><td>CONV</td><td>LIMITED</td><td></td><td>DUPLICATE</td><td>SAVE</td><td>PROGRAM</td><td></td><td>EXIT</td> </tr> <tr> <td></td><td>SER NUM</td><td>ID</td><td>CLONE</td><td></td><td>II/III ID</td><td>FILE</td><td>RADIO</td><td></td><td></td> </tr> </table>				F1	F2	F3	F4	F5	F6	F7	F8	F9	F10	HELP	READ	CONV	LIMITED		DUPLICATE	SAVE	PROGRAM		EXIT		SER NUM	ID	CLONE		II/III ID	FILE	RADIO		
F1	F2	F3	F4	F5	F6	F7	F8	F9	F10																								
HELP	READ	CONV	LIMITED		DUPLICATE	SAVE	PROGRAM		EXIT																								
	SER NUM	ID	CLONE		II/III ID	FILE	RADIO																										

The CLONE radio function is used to copy codeplug information from one radio to another. *Only radios with the same model number may be cloned.*

Function Key Descriptions

F2 - READ SER NUM
(Read serial number)

Allows you to read the serial number of the “target” radio.

F3 - CONV ID
(Conventional ID)

Brings up a screen where you can assign MDC IDs. *This function will be active only when a Trunking-capable radio is being cloned.*

F4 - LIMITED CLONE

Clones the Conventional and radio wide sections of the codeplug. This deletes the Trunking data and reads the serial number from the radio. In order to perform Limited Clone:

- Trunking system keys (or an FTR Key) are required to clone Trunking System data.*
- The target radio must be connected to the computer so that its serial number can be determined.*

F6 - DUPLICATE II/III ID

Duplicates the selected Type II/III ID (the one under the cursor) into all other Type II/III personalities for which system keys are present.

F7 - SAVE FILE

Creates or updates an archive copy of the codeplug information on a disk or hard disk.

Note: An archive copy of every radio installed or serviced is strongly recommended. You will then be able to quickly restore customer information in case of a codeplug failure.

F8 - PROGRAM RADIO

Programs the “target” radio using saved codeplug data.

Full Cloning

System keys for all Trunked Systems in the radio are required to perform a full clone. Follow the steps below for Full Cloning:

1. Press **F2** at the GET/SAVE/PROGRAM MENU to read the radio codeplug to be cloned. That is the “source” codeplug. An archive file may also be used as the “source”. *A radio and RIB must be properly connected to the computer and power turned on before you attempt the READ function.*
2. Enter the serial number of the radio to be cloned on the TRUNKED CLONING screen, or press **F2** to read the serial number from the connected radio. *System keys are required to change the serial number.*
3. Change the Trunking individual IDs to those required by the new radio on this screen. If MDC IDs are also used, they can be changed on the MDC ID screen by pressing **F3**.
4. Connect the “target” radio to the computer and press **F8** to program the “source” codeplug into the “target” radio. *A radio and a RIB must be properly connected to the computer and the power turned on before you press F8.*

Limited Cloning

A limited clone may be performed when all the system keys required to perform a full clone are not available.



Caution

When a limited clone is performed, all Trunking information which existed in the “source” radio will be deleted or modified to default data. Re-entry of Trunking information will be required.

Follow the steps below to perform a limited clone:

1. Press **F2** at the GET/SAVE/PROGRAM MENU to read the radio codeplug to be cloned. That is the “source” codeplug. An archive file may also be used as the “source”. *A radio and RIB must be properly connected to the computer and power turned on before you attempt the READ function.*

Note: The time required to read a codeplug will vary based on the processing power of your computer and the size of the codeplug being read.

2. Press the Limited Clone function key (**F4**) on the TRUNKED CLONING screen. *At this point all the Trunking data in the “source” codeplug will be deleted or defaulted.* This includes all Trunking system and Trunking personality data. Zone/Channel, Conventional, Phone List, Call list and Scan List data will however be preserved.



Caution

Do NOT program this image into the original radio unless you want all the Trunking data to be deleted.

3. Enter the serial number of the radio to be cloned or press **F2** to read the serial number from the connected radio. At this point, you will have a codeplug image for the “target” radio which contains Conventional data and Radio wide data from the “source” radio and no Trunking data. Like any other codeplug file, this codeplug image may be archived, edited or programmed into the “target” radio. Normally you will proceed to step 4.

Note: *The serial number cannot be read prior to step 2 unless system keys are present.*

4. Program the target radio by pressing **F8** from the PROGRAM RADIO CODEPLUG screen (**F3/F8**) or the TRUNKED CLONING screen (**F3/F5**). *A radio and a RIB must be properly connected to the computer and the power turned on before you attempt this function.*
5. Archive the “target” codeplug image.

Save Codeplug Data to an Archive File



From the MAIN MENU, press **F3** and then **F7** to access this screen.

MOTOROLA Radio Service Software MCS Model: ..GET/SAVE/PROG:CLONE RADIO:SAVE FILE	Enter Archive Path.								
Archive: SAVE CODEPLUG DATA TO ARCHIVE FILE ----- Archive Filename.....A466ASNO.331 Model Number.....M01KHH9PW5AN Serial Number..... Last Programmed.....9510021641 Program Source.....RSS									
F1 HELP	F2 CHANGE ARCHIVE	F3	F4	F5	F6	F7	F8 SAVE ARCHIVE	F9	F10 EXIT

The SAVE ARCHIVE function is used to create (or update) an archive copy of the codeplug information on a disk.

Note: You are strongly encouraged to make an archive copy of every radio installed or serviced. You will then be able to quickly restore customer information in case of codeplug failure.

Function Key Descriptions

F2 - CHANGE ARCHIVE

Used to specify the directory path where the archive file is to be located. The default archive path will always be the default path specified in the CONFIGURE PATHS AND PORT screen (**F9/F3**).

F8 - SAVE ARCHIVE

Saves the archive file to the path specified (or to the default path if no path is specified). *Do NOT press F8 until you have entered the archive file name and customer identification information.*

Field Definitions

Archive File Name	This is the DOS name of the archive file which defaults to the serial number of the radio. The standard DOS file naming convention must be used, that is, the file name must be a one- to eight-character alphanumeric name with a one- to three-character alphanumeric extension (xxxxxxx.yyy).
Model Number	The radio model number stored in the codeplug. This number should correspond to the model number printed on the label under the radio's battery.
Serial Number	The radio serial number stored in the codeplug. This number should correspond to the serial number printed on the label under the radio's battery.
Last Programmed	This is the time and date the radio was last programmed. The format is YYMMDDHHMM (where Y refers to year, M to month, D to day, H to hour and M to minute). Time is in military format (for instance, 1:30 PM is referred to as 1330).
Program Source	This field describes the source of the most recent codeplug programming:

RSS	Programmed by a standard RSS.
Factory	Programmed in the factory.
Labtool	Programmed using a special development RSS.
FTR Key	Programmed using a FTR (Field Technical Representative) hardware key.

Programming History

From the MAIN MENU, press **F3** and then **F9** to access this screen.



MOTOROLA Radio Service Software MCS Model: MAIN:GET/SAVE/PROG:HISTORY	Information Only. These Fields Cannot be Changed.								
PROGRAMMING HISTORY ----- Model Number.....M01KHH9PW5AN Software Option.....H38 Serial Number..... Radio Software Version..... Radio Codeplug Version.....000B Programmed Date.....9510021641 Program Source.....RSS									
F1 HELP	F2	F3	F4	F5	F6	F7	F8	F9	F10 EXIT

This screen shows the historical statistics of the radio and the RSS such as serial number, model number, last programmed date, programming source, etc. *All the fields in this screen are view-only fields.*

Field Definitions

Model Number

This is a view-only field. Displays the radio model number stored in the codeplug. This number should correspond to the model number printed on the label under the radio's battery.

Software Option

This is a view-only field. Displays any software options programmed, but applies to Private System model numbers only.

Serial Number

This is a view-only field. Displays the radio serial number stored in the codeplug. This number should correspond to the serial number printed on the label under the radio's battery.

Radio Software Version

This is a view-only field. Displays the version of operator software running in the radio.

Radio Codeplug Version

This is a view-only field. Displays the codeplug description version number. It determines which versions of RSS the codeplug is compatible with.

Programmed Date

This is a view-only field. Displays the time and date the radio was last programmed. The format is YYMMDDHHMM (where Y refers to year, M to month, D to day, H to hour and M to minute). Time is in military format (that is, 1:30 PM will be denoted by 1330).

Program Source

This is a view-only field. Displays the source of the most recent internal codeplug programming:

RSS	Programmed by a standard RSS.
Factory	Programmed in the factory.
Labtool	Programmed using a special development RSS.
FTR Key	Programmed using a FTR (Field Technical Representative) hardware key.

Change/View Menu Functions

5

This section describes all the functions available from the CHANGE/VIEW MENU. To guide you through these functions, CHANGE/VIEW-related menus and screens are shown with their respective RSS locations from the MAIN MENU, function key descriptions and field definitions.

Note: All functions (supported and unsupported) will be displayed in the menu's working area. The unsupported functions (based on the radio's model or options) will NOT be displayed in the F-key ID area.

Menu Map

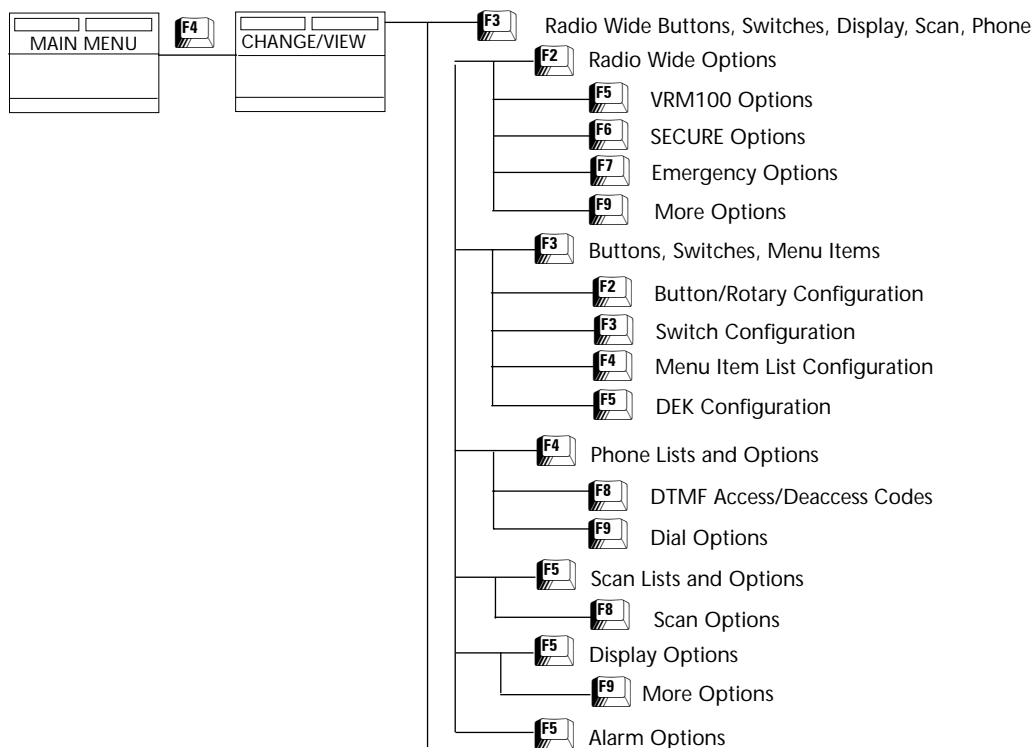

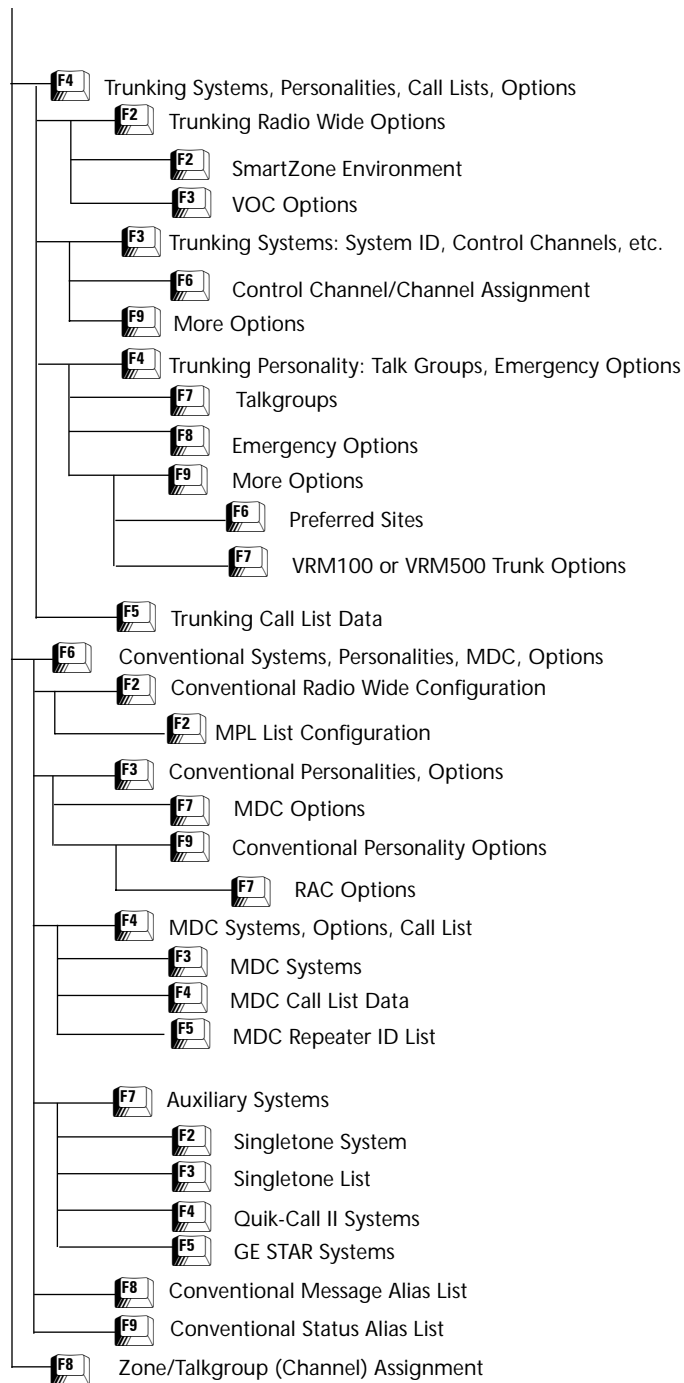

Change/View Menu

Press **F4** at the MAIN MENU to access the CHANGE/VIEW MENU.



MOTOROLA Radio Service Software MCS Model:	Select Function F1 - F10.								
MAIN:CHANGE/VIEW									
CHANGE/VIEW MENU -----									
F1 - HELP									
F2 -									
F3 - Radio Wide Buttons, Switches, Display, Scan, Phone									
F4 - Trunking Systems, Personalities, Call Lists, Options									
F5 -									
F6 - Conventional Systems, Personalities, MDC, Options									
F7 -									
F8 - Zone/Channel Assignment									
F9 -									
F10 - EXIT, Return to Main Menu									
F1 HELP	F2	F3 RADIO CONFIG	F4 TRUNK DATA	F5	F6 CONV DATA	F7	F8 ZONE/CHN ASSIGN	F9	F10 EXIT

The CHANGE/VIEW MENU is a multi-level menu. Its sub-menus are used to change or view codeplug features and option configurations. All codeplug parameters are classified as either Radio Configuration, Conventional or Trunking. The CHANGE/VIEW MENU functions permit access to each category.

A codeplug must be loaded into your computer's memory (using GET/SAVE/PROGRAM MENU functions) before you can access the CHANGE/VIEW screens. You may change or view an archive file without having a radio connected.

Note: If your radio model does not contain a specific feature, you will not be permitted to access the corresponding data field or screen for that feature. Refer to your Radio Catalog Sheets or Radio Service Manual for radio model descriptions and features.

The CHANGE/VIEW MENU does NOT actually modify the radio's codeplug data. Instead, it modifies a copy of the data retrieved from the codeplug or archive file using GET/SAVE/PROGRAM MENU functions.

After all change/view modifications are completed, you MUST return to the GET/SAVE/PROGRAM MENU and program the changes back into the radio or save them to a new archive file. *Otherwise, the modifications will be lost when you turn off your computer or load another codeplug into memory.*

Function Key Descriptions

F3 - RADIO CONFIG
(Radio Wide Configuration)

Used to change or view radio parameters and options that affect overall radio operation (including Conventional and Trunking) such as button and volume default settings. Typically, when you begin to edit a codeplug, you should come to this menu and configure Radio wide options first by working your way through the screens below this menu. This will allow the options on other screens to reflect Radio wide options. *Some fields will not be visible if the radio does not support that option.*

F4 - TRUNK DATA
(Trunking Data Configuration)

A multi-level menu used to change or view Trunking personalities, systems, etc. All lists (call, scan, phone) may be modified. *This function key will NOT be visible for radio models that support Conventional operation only.*

F6 - CONV DATA
(Conventional Data Configuration)

Used to change or view Conventional parameters such as personalities, buttons, and MDC signalling. *This function key will NOT be visible for Trunking-only radio models.*

F8 - ZONE/CHN ASSIGN
(Zone/Channel Assignment)

Used to assign a group of channels (or talkgroups) to a particular zone based on some common characteristic such as geographic location, job function, signalling type, etc.

Radio Wide Configuration Menu



From the MAIN MENU, press **F4** and then **F3** to access this menu.

MOTOROLA Radio Service Software MCS Model:	Select Function F1 - F10.								
MAIN:CHANGE/VIEW:CONFIG									
<p>RADIO WIDE CONFIGURATION MENU</p> <p>-----</p> <p>F1 - HELP</p> <p>F2 - Radio Wide Options</p> <p>F3 - Buttons, Switches, Menu Items</p> <p>F4 - Phone Lists and Options</p> <p>F5 - Scan Lists and Options</p> <p>F6 - Display Options</p> <p>F7 - Alarm Options</p> <p>F8 -</p> <p>F9 -</p> <p>F10 - EXIT, Return to Change/View Menu</p>									
F1 HELP	F2 RADIO OPTIONS	F3 FEATURE OPTIONS	F4 PHON.TX OPTIONS	F5 SCAN OPTIONS	F6 DISPLAY OPTIONS	F7 ALARM OPTIONS	F8	F9	F10 EXIT

The RADIO WIDE CONFIGURATION MENU may be used to change or view features, parameters and options that affect both Trunking and Conventional operation. Typically, when you start editing a codeplug, you should access this menu and configure the Radio wide configuration options first by working your way through the sub-menus of this menu. This will allow the options on other screens to reflect Radio wide options. *Some fields will not be visible if the radio does not support the options that they pertain to.*

Function Key Descriptions

F2 - RADIO OPTIONS

Brings up a menu through the sub-menus of which you can edit general options that affect operation of the radio as a whole such as alert tones, keypad parameters, etc. *The options on this screen should be correctly edited and verified before you proceed to edit personality data.*

F3 - FEATURE OPTIONS

Brings up a screen where you can define the functions that each button, switch, and menu item performs.

F4 - PHON. Tx OPTIONS

Brings up a screen where you can edit phone interconnect configuration for the radio, including stored phone numbers and aliases. These parameters are radio wide and affect both Conventional and Trunking operation. *This screen will be visible only if the radio supports this option.*

F5 - SCAN OPTIONS

Brings up a screen where you can configure the Channel Scan and enter the Scan List. If a given scan list number is chosen on the appropriate personality screens, it may be used for either Conventional or Trunking operation as the case may be.

F6 - DISPLAY OPTIONS

Brings up a screen where you can edit display information for the radio to customize it for specific user applications. The features and options displayed here are applicable to all systems and personalities.

F7 - ALARM OPTIONS

Used to enable or disable the radio's Horn & Lights Alarm option.

Radio Wide Options

From the MAIN MENU, press **F4**, **F3** and then **F2** to access this screen.



MOTOROLA Radio Service Software MCS Model:		Use UP/DOWN Arrows to Select Choice.	
MAIN:CHANGE/VIEW:CONFIG:RADIO OPTIONS			
RADIO WIDE OPTIONS -----			
Alert Tones.....Enabled	Control Station Equipped.Disabled	VRM100 Capable.....Enabled	VRM500 Capable.....Disabled
Min Alert Tone Volume.....128	Block Pending CA/PC.....Disabled	Selectable Keypad Mute....Enabled	
Alert Tone Vol Offset (dB).-12.0	Auto Power-Off (hrs).....14	Long Press/Emer Duration (ms).250	Maximum Channels (Talkgroups).160
Self Test Alert Tone....Disabled	Out Of Range.....No Indication	Home Mode Selection.....Enabled	Zone....1 Chan....1
		Secure Equipped.....Yes	
F1 HELP	F2	F3	F4
	F5 VRM100 OPTIONS	F6 SECURE OPTIONS	F7 EMERG OPTIONS
		F8	F9 MORE OPTIONS
			F10 EXIT

This screen allows you to set up various options that affect Radio wide operation. *The options on this screen should be correctly edited and verified before you proceed to edit personality data.*

Press **Tab** to select the desired field, or press the desired function key (**F1 - F10**). If a field is highlighted, press the UP/DOWN arrow keys to select the desired choice or value.

Note: *The Control Station Equipped, VRM100 Capable, and VRM500 Capable features are mutually exclusive. If you want to enable one of these options, the other two MUST be disabled.*

Function Key Descriptions

F5 - VRM OPTIONS

This option will be active only when the VRM100 Capable field on this screen is set to Enabled. Brings up a screen where you can define and modify VRM100 radio options.

F6 - SECURE OPTIONS

This option will be active only when the SECURE Equipped field is set to Yes. Brings up a screen where you can modify Radio Wide SECURE option settings.

F7 - EMER OPTIONS (Emergency Options)

This option will be visible only if the radio supports Emergency features. Brings up a screen where you can edit Radio wide Emergency feature parameters.

F9 - MORE OPTIONS

Brings up a screen where you can view and modify additional Radio wide data.

Field Definitions

Alert Tones Enables or disables the radio's Alert Tones.

The default is Enabled.

Min Alert Tone Volume

This field will be visible only if the Alert Tones field is set to Enabled. Enter or scroll to select the desired volume level. This is the minimum alert tone volume level the radio will use. If the volume setting is above the level you specify, the actual volume setting will be used to sound an alarm. Otherwise, the Minimum Alert Tone Volume specification will be used. Valid entries range from 0 (zero) to 255.

The default is 128.

Alert Tone Vol Offset (dB)

This field will be visible only if the Alert Tones field is set to Enabled. Use the UP/DOWN arrow keys to select the Alert Tone Volume Offset that the radio will use. The Alert Tone Volume Offset is the value by which the alert tone volume will be raised or lowered with reference to the current user-selected volume. This offset can range from -24 dB to +24 dB in increments of 1.5 dB.

The default is -12 dB.

Auto Power-Off

This feature allows the radio to be automatically turned off after a pre-determined time period of inactivity from the user. Any keypress or user input will reset the timer. During the last two minutes before the timer expires, the radio shall generate audible and visual warnings until the timer expires or resets.

The Automatic Power-Off feature can be disabled or set from 2 to 14 hours in 2 hour increments.

The factory default is Disabled.

Self Test Alert Tone

This field will be visible only if the Alert Tones field on this screen is set to Enabled. Use the UP/DOWN arrow keys to enable/disable the Power-Up Self Test Alert Tone. If this feature is enabled, an alert tone beep will sound each time the radio is turned on and self-test is completed.

The default is Disabled.

Rotary Alert (*not shown*)

Use the UP/DOWN arrow keys to select the type of Rotary Alert for Continuous Rotary control models. The type of Continuous Rotary Alerts are:

Rollover Alert	Turning the Rotary control past all programmed channels in either direction will result in an alert tone (beep) and the display will indicate "UNPROG."
Elec. Stop	Turning the Rotary control past the first channel position in either direction will result in an alert tone.
None	Turning the Rotary control will cause no alert tone.

Out of Range

Use the UP/DOWN arrow keys to select the desired type of indication. This field determines how the radio will indicate an Out of Range

condition on a Trunked system. When the radio can no longer communicate with the base station, the radio can be programmed to give an out-of-range alert tone, display an out-of-range message, or both. This feature can be disabled by setting the field to No Indication.

The default is No Indication.

Control Station Equipped

This option will be accessible only for radios equipped with Control Station hardware. It is not compatible with the VRM100 and VRM500 features. The VRM100 Capable and VRM500 Capable fields on this screen must be set to Disabled if the Control Station Operation is to be used.

Use the UP/DOWN arrow keys to enable/disable Control Station Operation for radios equipped with control station hardware. This option re-configures some of the I/Os on the radio options connector to allow the radio to be used as a control station. It allows for connection to desk sets, interconnects, etc.

The default is Disabled.

IMPORTANT NOTE: *This feature is planned for a future RSS release. As of the date of this release, enabling or disabling the Control Station Equipped feature will have no effect whatsoever on the operation of the radio.*

VRM100 Capable

This option is not compatible with the VRM500 Capable and Control Station Equipped features. The VRM500 Capable and Control Station Equipped fields must be set to Disabled if the VRM100 feature is to be enabled. Similarly, if this field is set to Enabled, you will not be able to set the VRM500 and Control Station Equipped fields to Enabled.

Use the UP/DOWN arrow keys to enable/disable VRM100 capabilities. When the VRM100 modem is connected to the MCS 2000 radio, it can be used to transfer data between remote units and a single central unit by utilizing the Trunking network. The data transfer is completed on voice channels using standard Trunking/Conventional signalling, which includes Call Alert, Channel Request, and Channel Grant. The radio supports both voice and data users. The interface between the radio and the modem is implemented by pin assignment on the accessory connector.

Note that:

- To enable VRM100 modem capabilities, you must enable the VRM100 option in the RADIO WIDE OPTIONS screen (F4/F3/F2).*
- To enable the VRM100 feature in Trunking mode, you must enable the VRM100 option in the TRUNKING PERSONALITY OPTIONS screen (F4/F4/F4/F9).*
- To enable the VRM100 feature in Conventional mode, you must enable the VRM100 option in the CONVENTIONAL PERSONALITY OPTIONS screen (F4/F6/F3/F9).*

The default is Disabled.

VRM500 Capable

This option is not compatible with the VRM100 Capable and Control Station Equipped features. The VRM100 Capable and Control Station Equipped fields must be set to Disabled if the VRM500 feature is to be

enabled. Similarly, if this field is set to Enabled, you will not be able to set the VRM100 and Control Station Equipped fields to Enabled.

Use the UP/DOWN arrow keys to enable/disable the radio's VRM500 capabilities. If the VRM500 Capable feature is enabled, the radio can be connected to the VRM500 modem which operates in 'data near trunking' mode on RD-LAP, MDC and MMP data systems.

Block Pending CA/PC

Use the UP/DOWN arrow keys to enable/disable blocking of Pending Call Alerts or Private Calls. When this feature is enabled, the radio will ignore all successive Call Alerts (or Private Calls) after receiving a Call Alert (or Private Call) with a different ID than the one originating the pending call.

The default is Disabled.

Selectable Keypad Mute

Use the UP/DOWN arrow keys to enable/disable blocking of Selectable Keypad Muting. When this field is enabled, the user may mute the keypad chirps from the radio menu. A mute selection must also be selected on the MENU ITEM LIST CONFIGURATION screen (**F4/F3/F3/F4**).

The default is Enabled.

Long Press/Emer Duration (ms)

Use the UP/DOWN arrow keys to change the timing duration for a Long Keypad Keypress. A long keypress involves pressing and holding a key for a period of time to enable a specific radio function or feature. This means that the user must press and hold the key down for the time specified by this field.

Long press buttons can be programmed for SCAN list, PHONE list programming, PAGE, CALL, MONITOR (*for Conventional channels only*), FORCED SITE SEARCH (*for AMSS/SmartZone only*), and SECURE (*Secure menu - key load, key erase*) Valid entries range from 250 to 3750 ms in 250-ms increments.

The default is 250 ms.

The setting in this field also influences the length of button press required to activate the radio's Emergency feature. Emergency button press time is one-half times the value you specify in this field for Long Keypress Duration. This setting will affect both the control head button, or external emergency (i.e. foot switch or push-button) activation time. For instance, if the Long Press/Emer Duration is set to two seconds, it will take a one-second button press to activate the Emergency feature. Therefore, if you want the emergency feature to be activated after the user has depressed the emergency button for 250 ms (for example), you should set this field to 500 ms.



Warning

Programming of Silent Emergency provides the user NO indication visible or audible indication that the emergency has been sent.

If you program silent emergency in conjunction with the Long Press Emergency feature users should be trained to LONG PRESS the emergency press button for an extended duration to ensure that the emergency will be sent.

Note: If this field is set to less than one second, the other Long Press buttons will still take one second to activate.

RSS Setting for Long Press Button Duration Field	Long Press Button Timer	Emergency Activation Timer
250 ms	1000 ms	125 ms
500 ms	1000 ms	250 ms
750 ms	1000 ms	375 ms
1000 ms	1000 ms	500 ms
1250 ms	1250 ms	625 ms
1500 ms	1500 ms	750 ms
1750 ms	1750 ms	875 ms
2000 ms	2000 ms	1000 ms
2250 ms	2250 ms	1125 ms
2500 ms	2500 ms	1250 ms
2750 ms	2750 ms	1375 ms
3000 ms	3000 ms	1500 ms
3250 ms	3250 ms	1625 ms
3500 ms	3500 ms	1750 ms
3750 ms	3750 ms	1875 ms

Maximum Channels
(Talkgroups)

This is a view-only field. It indicates the maximum number of channels/talkgroups that a radio can access. *This value varies according to the model number and options purchased.*

Radio Cloning (*not shown*)

This field is visible only for radio models that permit direct radio cloning with a special cloning cable. If this feature is not desired, use the UP/DOWN arrow keys to select Disabled.

Home Mode Selection

Use the UP/DOWN arrow keys to enable/disable Home Mode Selection. If this field is Enabled, the Zone/Channel specified here will be selected when the HOME button is pressed.

The default is Disabled.

Zone

This field will be visible only when Home Mode Selection is enabled. Use the UP/DOWN arrow keys to make your selection or enter the desired value directly. This option allows the specification of a particular zone to which the radio “homes” when the Home key is pressed. The valid range of values is 1 to 50.

The default is 1.

Channel

This field will be visible only when Home Mode Selection is enabled. Use the UP/DOWN arrow keys to make your selection or enter the desired value directly. This option allows for the specification of a particular channel to which the radio “homes” when the Home key is pressed. The valid range of values is 1 to 255. The default is 1.

SECURE Equipped

This field will not be visible unless a SECURE-capable radio has been read. This field is used to enable SECURE operation for radios equipped with the SECURE hardware option. Setting this field to Yes will allow you to access the SECURE OPTIONS screen.



Caution

The user must make sure that SECURE hardware is installed in the radio when setting this field to "Yes ". If not, this field setting will lead to improper operation of the radio.

VRM100 Options



From the MAIN MENU, press **F4**, **F3**, **F2** and then **F5** to access this screen.

MOTOROLA Radio Service Software MCS Model: ...CONFIG:RADIO OPTIONS:VRM OPTIONS	Use UP/DOWN Arrows to Select Choice.
<p>VRM100 OPTIONS -----</p> <p>Disconnect On Data.....Disabled Data On Failsoft.....Enabled Speaker Unmute On Data.....Disabled Transmit Enable Polarity.....Active High Channel Grant Polarity.....Active High Data Mode Request Polarity.....Active Low MLU Operation.....Disabled Data Overrides Voice.....Disabled Ignore Data Display.....Disabled</p>	
F1 HELP	F2 F3 F4 F5 F6 F7 F8 F9 F10 EXIT

*This screen can be accessed only when the VRM100 capable field is set to Enabled on the RADIO WIDE OPTIONS screen (F4/F3/F2). This screen allows you to define and modify VRM100 radio options. Press **Tab** to select the desired field, or press the desired function key (F1 - F10). If a field is highlighted, use the UP/DOWN arrow keys to select the desired choice or value.*

Field Definitions

Disconnect On Data

Use the UP/DOWN arrow keys to enable/disable this option. If this field is enabled, the radio will send a disconnect tone at the end of data transmission.

The default is Disabled.

Data On Failsoft

Use the UP/DOWN arrow keys to enable/disable this option. If this field is enabled, the radio will permit data transmit/receive on Failsoft.

The default is Enabled.

Speaker Unmute On Data

Use the UP/DOWN arrow keys to enable/disable this option. If this feature is enabled, the speaker will unmute while data is being received.

The default is Disabled.

Transmit Enable Polarity

Use the UP/DOWN arrow keys to select Active High or Active Low. This value in this field determines the polarity of the output signal TXE.

The default is Active High.

Channel Grant Polarity	<p>Use the UP/DOWN arrow keys to select Active High or Active Low. The value in this field determines the polarity of output signal CG.</p> <p>The default is Active High.</p>
Data Mode Request Polarity	<p>Use the UP/DOWN arrow keys to select Active High or Active Low. The value in this field determines the polarity of the input signal DMR.</p> <p>The default is Active Low.</p>
MLU Operation	<p>If this field is enabled, the radio will allow conventional channels to be used for both voice and data operation. If disabled, conventional channels are used for either voice or data operation (voice and data are mutually exclusive).</p>
Data Overrides Voice	<p>Use the UP/DOWN arrow keys to enable the VRM100 Data Overrides Voice feature.</p> <p>When enabled, VRM100 data transmissions will have priority over all voice transmissions (data messages will interrupt voice calls) except Emergency Voice transmissions.</p> <p>When disabled, data messages will NOT interrupt voice calls.</p> <p>The factory default is Disabled.</p>
Ignore Data Display	<p>This field is used to enable/disable the Ignore Data Display feature.</p> <p>When the Ignore Data Display feature is enabled, the radio will not display 'DATA TRANSFER' when in data mode; instead, the normal mode alias is displayed.</p> <p>The factory default is Disabled.</p>

Radio Wide SECURE Options

From the MAIN MENU, press **F4**, **F3**, **F2** and **F6** to access this screen.



MOTOROLA Radio Service Software MCS Model:	Enter or Scroll to Select Value.								
..CONFIG:RADIO OPTIONS:SECURE OPTIONS									
<p>RADIO WIDE SECURE OPTIONS -----</p> <p>XL IC Present.....Yes Tx Clear Alert Tones.....Enabled Periodic Keyfail Alert Tone.....Enabled Non-XL Scan Unsquelch Duration (ms)..275 XL Scan Unsquelch Duration (ms).....875 Secure Punch Thru..... Disabled</p>									
F1 HELP	F2	F3	F4	F5	F6	F7	F8	F9	F10 EXIT

This screen can be accessed only when the SECURE Equipped field is set to Yes on the RADIO WIDE OPTIONS screen (F4/F3/F2). This screen allows you to set up various SECURE options that affect Radio wide operation.

Press **Tab** to select the desired field, or press the desired function key (**F1 - F10**). If a field is highlighted, press the UP/DOWN arrow keys to select the desired choice or value.

Field Definitions

XL IC Present

Use the UP/DOWN arrow keys to specify whether or not an XL chip is present. This field should be set to Yes if the radio is equipped with an XL chip.

The default is No.

Tx Clear Alert Tones

Use the UP/DOWN arrow keys to enable/disable Tx Clear Alert Tones for the radio. When this field is set to Enabled, an alert tone will be generated every time the user keys up the radio in the Clear mode.

The default is Enabled.

Periodic Keyfail Alert Tone

Use the UP/DOWN arrow keys to enable/disable Periodic Keyfail Alert Tones for the radio. When this field is set to Enabled, a periodic alert tone will be generated whenever the radio has lost key and one of the following conditions is met:

- SECURE/Clear Strapping is set to SECURE
- SECURE/Clear Strapping is set to Select and the user has selected SECURE position

The default is Enabled.

Non-XL Scan Unsquelch Duration (ms)	<p>Use the UP/DOWN arrow keys to select the Non-XL Scan Unsquelch Duration. When scanning for coded transmissions, this field determines the period of time that the radio will wait for a Non-XL (Cipher Feedback) encrypted signal to be detected following a Carrier Detect. The valid range is 0 (zero) to 6375 ms in 25-ms increments.</p> <p>The default is 275 ms.</p>
XL Scan Unsquelch Duration (ms)	<p>Use the UP/DOWN arrow keys to select the XL Scan Unsquelch Duration. When scanning for coded transmissions, this field determines the period of time the radio will wait for a Non-XL (Cipher Feedback) or XL encrypted signal to be detected following a carrier detect. The range is 0 (zero) to 6375 in 25-ms increments.</p> <p>The default is 875 ms.</p>
Secure Punch Thru	<p>Use UP/DOWN arrow keys to scroll or directly enter the desired value. The RSS allows the user to set the Secure Punch Thru feature to one of the following settings: Disabled, Always On, or Variable Volume Position (that is, the feature will become active when the volume knob is set to a level greater than this programmed volume position).</p> <p>The valid range of the variable volume position is 1 to 254. (The latter figure corresponds to the absolute position of the radio volume knob.)</p> <p>SECURE Punch Thru is a feature intended to reduce high volume distortion in the SECURE receive mode by removing much of the distortion-producing low frequency content (from amplifier clipping and speaker/housing overload), and improve intelligibility in high background noise environments (when the radio is at high volume), by boosting the high frequency content that tends to get washed out in such conditions.</p> <p>The SECURE Punch Thru feature is activated when the radio is receiving in the SECURE mode and the volume knob is beyond an RSS programmable position. The feature turns off the de-emphasis filter in the receive SECURE audio path, leaving the audio pre-emphasized from the transmitter (that is, the lower frequencies are reduced and the higher frequencies are increased).</p> <p>Note that this feature requires the transmitting radios to use pre-emphasis, which is normally the case. Also, the Secure Punch Thru feature activation point can be anywhere from the volume knob's lowest position (turned on all the time when receiving SECURE) to its highest position (turned off all the time when receiving SECURE).</p> <p>The default is Disabled.</p>

Radio Wide Emergency Options



From the MAIN MENU, press **F4**, **F3**, **F2** and then **F7** to access this screen.

MOTOROLA Radio Service Software MCS Model: ...CONFIG:RADIO OPTIONS:EMERG OPT	Use UP/DOWN Arrows to Select Choice.								
<p>RADIO WIDE EMERGENCY OPTIONS</p> <p>-----</p> <p>Silent Alarm.....Enabled</p> <p>Unmute Option.....Enabled</p> <p>Channel Delay (sec).....2</p> <p>Emergency Power Up.....Disabled</p>									
F1 HELP	F2	F3	F4	F5	F6	F7	F8	F9	F10 EXIT

This screen can be accessed only if the radio supports this option. Emergency operation must be enabled on the CONVENTIONAL PERSONALITY screen (**F4/F6/F3**) and/or the TRUNKING PERSONALITY screen (**F4/F4/F4**). In addition, the Emergency button must be configured from the RADIO WIDE BUTTON screen (**F4/F3/F3/F2**). The Emergency parameters listed on this screen apply to both Conventional and Trunking signalling.

Press **Tab** to select the desired field, or press the desired function key (**F1 - F10**). If a field is selected, press the UP/DOWN arrow keys to select the desired choice or value.

Field Definitions

Silent Alarm

*This feature is not compatible with Emergency Receive. To enable Silent Alarm, make sure Emergency Receive is disabled on the RADIO WIDE DISPLAY OPTIONS screen (**F4/F3/F6**). Use the UP/DOWN arrow keys to enable/disable this feature. If this feature is enabled, the radio will operate silently when transmitting an emergency signal. No audible or visual indication of the transmission will occur.*

The default is Disabled.

Emergency operation must be enabled on the CONVENTIONAL MDC SYSTEMS screen (**F4/F6/F4/F3**) and/or the TRUNKING PERSONALITY EMERGENCY OPTIONS screen (**F4/F4/F4/F8**). In addition, the Emergency button must be configured from the RADIO WIDE BUTTON screen (**F4/F3/F3/F2**).

Unmute Option

This feature is an optional ADDITION to the Emergency Silent Alarm feature. Enabling this feature will cause the radio to UNMUTE on the emergency talkgroup (for trunking) or frequency (for conventional) for voice traffic when the radio is in SILENT ALARM EMERGENCY mode. The Unmute Option will allow the dispatcher to provide

feedback to the person initiating the emergency state via code words, without drawing undesirable attention.

The factory default is Disabled.

Channel Delay (sec)

Use the UP/DOWN arrow keys to select the Emergency Channel Delay or enter a value directly. The radio must be on a channel for the time specified here before it can transmit an emergency signal. For Emergency operation, this delay is sometimes desired to prevent the radio from sending an emergency signal on an undesired channel (which may occur while the user is changing channels and pressing the emergency button). The valid range is 0 (zero) to 7 seconds.

The default is 2 seconds.

Emergency Power Up

Use the UP/DOWN arrow keys to enable the Emergency Power Up feature.

If this feature is enabled, and the user presses the emergency button/switch when the radio is off, the unit will power up and send an emergency signal. After sending the emergency signal the radio remains powered up.

Note: This feature cannot be assigned to control head buttons. It is only available for the external emergency button or footswitch.

The factory default is Disabled.

More Radio Wide Options



From the MAIN MENU, press **F4**, **F3**, **F2** and then **F9** to access this screen.

MOTOROLA Radio Service Software MCS Model: ...CONFIG:RADIO OPTIONS:OPTIONS	Use UP/DOWN Arrows to Select Choice.												
<p>RADIO WIDE OPTIONS -----</p> <p>Mic AGC.....Disabled Car Radio Mute.....Enabled Car Radio Mute Timer (sec)....10 Direct Mode...Operator Selectable</p> <table> <thead> <tr> <th>Num</th> <th>Time Out Timer Table (sec)</th> </tr> <tr> <th>---</th> <th>-----</th> </tr> </thead> <tbody> <tr> <td>1</td> <td>Infinite</td> </tr> <tr> <td>2</td> <td>30</td> </tr> <tr> <td>3</td> <td>60</td> </tr> <tr> <td>4</td> <td>120</td> </tr> </tbody> </table>		Num	Time Out Timer Table (sec)	---	-----	1	Infinite	2	30	3	60	4	120
Num	Time Out Timer Table (sec)												
---	-----												
1	Infinite												
2	30												
3	60												
4	120												
F1 HELP	F2	F3	F4	F5	F6	F7	F8	F9	F10 EXIT				

The option parameters listed on this screen apply both to Conventional and Trunking operation. Press **Tab** to select the desired field, or press the desired function key (**F1 - F10**). If a field is highlighted, use the UP/DOWN arrow keys to select the desired choice or value.

Field Definitions

Mic AGC

Use the UP/DOWN arrow keys to select which microphones will use Automatic Gain Control. The Automatic Gain Control (AGC) feature will automatically raise or lower the gain of the microphone to keep the audio level near a pre-determined level. The choices are Internal, External, Internal and External, and Disabled.

The default is Internal and External.

Car Radio Mute

Use the UP/DOWN arrow keys to enable/disable the Car Radio Mute operation. If this field is enabled, the Car Radio Mute feature allows the mobile radio to be used in conjunction with a car radio/cassette to mute the car radio/cassette when the mobile radio user initiates or receives a voice call (that is, Dispatch Call, Private Call, Selective Call, or Phone) while the car radio/cassette is on.

The default is Disabled.

IMPORTANT NOTE: *This feature is planned for a future RSS release. As of the date of this release, enabling or disabling the Car Radio Mute feature will have no effect whatsoever on the operation of the radio.*

Car Radio Mute Timer (sec)

This field is visible only if the Car Radio Mute field is set to Enabled. Use the UP/DOWN arrow keys or directly enter a value for the Car Radio Mute Timer. When this feature is enabled, the car radio/cassette remains muted after a voice transmit or receive is completed for the period of time specified in this field in order to avoid unmuting in the middle of a conversation. Valid values range from 1 to 60 seconds in one-second increments.

The default is 10 seconds.

IMPORTANT NOTE: *This feature is planned for a future RSS release. As of the date of this release, specifying a value for the Car Radio Mute Timer will have no effect whatsoever on the operation of the radio.*

Time-Out Timer Table (sec)

Use the UP/DOWN arrow keys select the four Time-Out Timer (TOT) values available to each personality. Each Conventional or Trunking personality may reference one of the four values that are defined on this screen. TOT values range from 15 to 465 seconds in 15-second increments. A value of Infinite is also available.

If the radio is transmitting and the TOT time expires, the radio is automatically de-keyed and a continuous alert tone is generated as long as the PTT button is pressed. To continue transmitting, the PTT button must be released and the radio re-keyed.

The default values are Infinite, 30, 60 and 120 seconds respectively.

Direct Mode

Use the UP/DOWN arrow keys to select the settings of Direct Mode.

Operator Selectable - Setting this field to Operator Selectable will allow radio users to program any buttons set to DM (Direct Mode) to the currently selected mode via a long press of the button. Once the button is programmed with a mode, a short press of the button will switch the radio to the programmed mode.

Fixed - If this field is set to Fixed, the user can use the DM buttons to change to the mode these buttons were previously programmed to. However, the user will not be able to re-assign the buttons to a different mode. These buttons will NOT be end-user programmable.

IMPORTANT NOTE

If this field is set to Fixed, the user of the radio will not be able to reprogram any buttons set to DM (Direct Mode). Before setting this field to Fixed, be sure to follow the steps below.

1. Select Operator Selectable for this field and program the radio.
2. Go to the desired mode.
3. Long press the DM button to which you want this mode programmed until a good key tone is heard.
4. Repeat steps 2 and 3 for all DM buttons.
5. Verify programming of the buttons by short pressing each DM button on the control head.

6. Read the radio using the RSS.
7. Set this field to Fixed.
8. Reprogram the radio using the RSS.
9. Save the codeplug as an archive file.
10. You may now clone the codeplug to all radios in your fleet.

The factory default is Operator Selectable.

Radio Wide Features Configuration Menu



At the MAIN MENU, press **F4**, and then **F3** twice to access this screen.

MOTOROLA Radio Service Software MCS Model:	Select Function F1 - F10.								
MAIN:CHANGE/VIEW:CONFIG:FEATURES									
<p>RADIO WIDE FEATURES CONFIGURATION MENU</p> <p>-----</p> <p>F1 - HELP F2 - Button/Rotary Configuration F3 - Switch Configuration F4 - Menu Item List Configuration F5 - DEK Configuration F6 - F7 - F8 - F9 - F10 - EXIT, Return to Radio Wide Configuration Menu</p>									
F1 HELP	F2 BUTTON CONFIG	F3 SWITCH CONFIG	F4 MENU ITEM	F5 DEK CONFIG	F6	F7	F8	F9	F10 EXIT

This screen is a multi-level menu that is used to change, view, or modify codeplug features and option configurations that affect both Conventional and Trunking operation. Typically, when you begin to edit a codeplug, you must access this menu and configure Radio wide options first by working your way through the screens located below this menu. This will allow the options on other screens to reflect Radio wide options. *Some fields will not be visible if the radio does not support the options that they relate to.*

The radio is shipped from the factory with a preset feature and option configuration, including the configuration of the control buttons, switches, and menu (display models). The function (and location) of most of these operator controls may be modified if necessary to provide more user flexibility and/or permit access to other user-defined features and options.

Note: Do NOT duplicate a function on multiple controls (on a button and a switch, or a button and a menu, or a switch and a menu for instance). This may cause the radio to malfunction and may confuse the operator.

F2 - BUTTON CONFIG
(Button Configuration)

Brings up a screen where you can edit button assignments for the radio.

F3 - SWITCH CONFIG
(Switch Configuration)

Brings up a screen where you can edit switch assignments for the radio.

F4 - MENU ITEM
(Menu Item Configuration)

Brings up a screen where you can configure menus that appear on the radio's display. *Menu items are supported only on front-display models.*

F5 - DEK Config
(DEK Configuration)

Brings up a screen where you can edit DEK (Direct Entry Keypad) button assignments for the radio.

Radio Wide Button Configuration



At the MAIN MENU, press **F4**, **F3** twice, and then **F2** to access this screen.

MOTOROLA Radio Service Software MCS Model: M01KHH9PW5AN		Use UP/DOWN Arrows to Select Choice.							
..CHANGE/VIEW:CONFIG:FEATURES:BUTTONS									
HAND HELD CONTROL HEAD	PTT	PWR [Unpr] [Unpr] Ctrl Head Display [Unpr] [Unpr] [Unpr] [Unpr] [Unpr] [Unpr] <MIC> VolUp [ChUp] VolDn [ChDn]	TOP BUTTONS [Unpr] SIDE [Unpr] BUTTONS [Unpr]						
		1 [Unpr] 2 [Unpr] 3 [Unpr] 4 [Unpr] 5 [Unpr] 6 [Unpr] 7 [Unpr] 8 [Unpr] 9 [Unpr] * 0 #							
F1 HELP	F2	F3	F4	F5	F6	F7	F8	F9	F10 EXIT

Hand-Held Control Head Button Configuration Screen

There are four screens in the RSS which pertain to Radio Wide button configuration. *You may or may not be able to access some or all these screens based on the model of the current radio (or codeplug) and the options ordered with it.*

MOTOROLA Radio Service Software MCS Model: M01KHL9PW4AN		Use UP/DOWN Arrows to Select Choice.							
..CHANGE/VIEW:CONFIG:FEATURES:BUTTONS									
CONTROL HEAD - C									
PWR		CONTROL HEAD BUTTONS	[ChUp] [ChDn]						
		[Unpr] [Unpr] [Unpr] [Menu]	[Sel]						
MICROPHONE BUTTONS	UP [Unpr]	MIDDLE [Unpr]	DOWN [Unpr]						
F1 HELP	F2	F3	F4	F5	F6	F7	F8	F9	F10 EXIT

Control Head C Button Configuration Screen

This screen is used to assign the features to specific buttons. Use the UP/DOWN arrow keys to select the desired function for this button and then use the **Enter** (Carriage Return) or **Tab** key to advance to the next button position. Use **Shift-Tab** to back up to the previous button position.

MOTOROLA Radio Service Software MCS Model: M01KHM9PW5AN		Use UP/DOWN Arrows to Select Choice.	
..CHANGE/VIEW:CONFIG:FEATURES:BUTTONS			
CONTROL HEAD - E			
PWR	[ZnUp]	CONTROL HEAD BUTTONS	[ChDn] [ChUp]
	[ZnDn]		CHAN
		[Unpr] [Unpr] [Unpr] [Unpr] [Unpr] [Unpr] [Unpr]	[Sel] [Menu]
MICROPHONE BUTTONS			
	1 [Unpr]	2 [Unpr]	3 [Unpr] UP [Unpr]
	4 [Unpr]	5 [Unpr]	6 [Unpr] MIDDLE [Unpr]
	7 [Unpr]	8 [Unpr]	9 [Unpr] DOWN [Unpr]
	* 0		#
F1 HELP	F2	F3	F4
	F5	F6	F7
	F8	F9	F10 EXIT

Control Head E Button Configuration Screen

MOTOROLA Radio Service Software MCS Model: M01KHN9PW5AN		Use UP/DOWN Arrows to Select Choice.	
..CHANGE/VIEW:CONFIG:FEATURES:BUTTONS			
CONTROL HEAD - J			
PWR	[ZnUp]	CONTROL HEAD BUTTONS	1 2 3 [Sel]
	[ZnDn]		[Unpr] [Unpr] [Unpr]
			4 5 6 [Menu]
			[Unpr] [Unpr] [Unpr]
			7 8 9 [ChDn]
			[Unpr] [Unpr] [Unpr]
			* 0 # [ChUp]
		[Unpr][Unpr][Unpr][Unpr][Unpr][Unpr][Unpr]	
MICROPHONE BUTTONS		UP [Unpr]	MIDDLE [Unpr]
			DOWN [Unpr]
F1 HELP	F2	F3	F4
	F5	F6	F7
	F8	F9	F10 EXIT

Control Head J Button Configuration Screen

The availability of certain button functions described below depends on your radio model and the options you have selected for this radio. You may therefore not be able to select some of these functions/choices for the radio currently being configured.

For digit keys (1-9), the zero key serves as a function key. To activate a feature programmed on a digit key, first press the zero key, then the digit key (1-9) on which the desired feature is programmed.

Button Function	Description
Blank	This button is not assigned to any feature of the radio.
CA	The Direct Call Alert (CA1, CA2, ...) buttons allow instant access to the radio's Call Alert feature. When the user presses a button programmed to CA #, the radio will enter the Call Alert feature and transmit the list member corresponding to the button's Index field. The Call List used will be the MDC Call List for MDC Personalities, or the Call List assigned to the current Trunking Personality. [1]
Call	Used to program the Call button for use with Trunking Private Call and/or Conventional MDC Call.
Chan	The channel button allows the user to select a channel in the radio with the keypad. The button becomes a shortcut to the 'Chan' menu item.
ChUp	Used to advance upward through the channels in the radio.
ChDn	Used to proceed downward through the channels in the radio.
Del	Used to delete the digits or, in Conventional or Trunking Scan, used as Scan Nuisance Delete.
Dim	Used to change the display brightness to one of four levels: from off to high, high to medium, medium to low, or low to off.
Dir	Used on a Conventional mode to choose a Repeater or Direct Transmit Frequency and Coded Squelch.
DM	<p>The Direct Mode buttons (DM1, DM2, ...) allow instant access to a specific mode. A short press of a Direct Mode button takes the radio to the mode assigned to that button. A long press of a Direct Mode button assigns the currently selected mode to that button.</p> <p>Note: If the Direct Mode field on the RadioWide More Options Screen (MAIN MENU-F4-F3-F2-F9) is set to Fixed, the user will be able to use the DM buttons to change to the mode that these buttons were previously programmed to. However, the user will not be able to reassign the buttons to a different mode. The mode selection for each Direct Mode button will, in essence, be fixed. The default mode for a Direct Mode button is Zone 1, Channel 1. [1]</p>
Dyn	Used for dynamic Priority Scan assignment.
Emer	Used with the Conventional and/or Trunking Emergency option to initiate Emergency operation.
FScn	<p>The Spectrum Scan button is used with SmartZone to initiate/continue a Full Spectrum CC Scan. When pressed, the radio will scan the spectrum for a control channel with a system ID that matches the system that the radio is currently using. If the radio finds a control channel, it will stop. If the button is pressed again, the radio will pick up where it left off in the spectrum and continue scanning. The radio automatically stops scanning if it does not locate a control channel before the Full Spectrum CC Scan Timer expires. The Timer duration can be set in the SmartZone Environment screen (MAIN-F4-F4-F2-F2). The radio operator can manually stop the scanning by changing the radio's mode.</p> <p style="text-align: center;">IMPORTANT</p> <p>Full Spectrum CC Scan must be enabled on the SmartZone Environment screen for this feature to function properly.</p>
H/L (Horn & Lights)	Used with the Conventional and/or Trunking External Alarm option to turn the external alarms ON/OFF and to configure the alarms. These alarms are activated when individual calls (Private Call, Call Alert Page, Phone, etc.) are received.
Home	Used to exit a feature such as Scan.

LPwr	Toggles the transmitting power from low to high.
Menu	Used to pick functionalities which are not programmed into a designated button.
MG	The Direct Message (MG1, MG2, ...) buttons allow instant access to the radio's Message feature. When a button programmed to MG # is pressed, the radio will check to see if it is currently in a personality which has Message enabled. If so, it will transmit the Message number which is specified in the button's Index field. If the current mode is Conventional, the Message List used will be the Conventional Message Alias List. Otherwise, the Message Alias List assigned to the current Trunking Personality will be used. If the personality does not have Message enabled, no Message will be sent. [1]
Mon/Srch	<p><i>The monitor button is valid only for conventional modes.</i> Used to monitor channel traffic; either take the microphone off-hook or press the MON button momentarily. MON ON display indicates that the radio is monitoring.</p> <p>On Coded Squelch modes, this turns off Receive-Coded Squelch operation and allows monitoring of all the activity on the channel. The busy indicator will also be illuminated when channel activity is present or the radio is unscelched.</p> <p><i>The search button is valid only on AMSS or SmartZone trunked modes.</i> A momentary press of the SRCH button will display the current site and its RSSI (Received Signal Strength Indication) value. A long press of the search button will cause the radio to attempt to change sites.</p>
MPL	Used with the User-Selectable PL feature, also known as Multiple PL (MPL). A short press displays the name of the currently selected MPL. A long press will allow the currently selected MPL to be changed via the mode selector. After the radio is programmed by the RSS, the radio's currently selected MPL will be reset to the first entry in the MPL List.
Msg	Used with the Conventional MDC-1200 Message option and/or the Trunking Message option to enter or exit the Message function.
Mute	Enable/disable keypad beeps.
MS1, MS2, MS3, MS4	The Mode Select features (MS1, MS2,...) allow instant access to a specific mode. A long press of a button programmed for a Mode Select feature, assigns the currently selected mode to the button. A short press, however, causes the radio to switch from the currently selected mode to the zone/channel assigned to the Mode Select Button. The default mode for the Mode Select feature is Zone 1, Channel 1.
One-Touch Buttons (1T1, 1T2, 1T3, and 1T4)	<p>A control head or mic/handset button programmed for one-touch button allows Trunking features such as Status, Message, Private Call, Call Alert and Phone to operate with the touch of a single button.</p> <ul style="list-style-type: none"> <input type="checkbox"/> When a button is programmed for one-touch Call Alert, Message, and Status, pressing the control head button will cause the radio to automatically enter the selected feature and transmit the list member corresponding to one-touch button index. <input type="checkbox"/> When a button is programmed for one-touch Phone, pressing the button will cause the radio to send a phone request and transmit a pre-programmed phone list number. The index field indicates which phone list number to transmit. <input type="checkbox"/> When a button is programmed for one-touch Selective Call, pressing the button will cause the radio to enter the Selective Call feature at the list member corresponding to the one-touch button index. <p>Note: Pressing a one-touch button while the radio is already in the feature corresponding to the one-touch button will cause the radio to abort the feature.</p>
Page	Used with the Conventional MDC-1200 Page option and/or the Trunking Page (Call Alert) option to select a Page ID and to send a page.

PC	The Private Call (PC1, PC2, ...) buttons allow instant access to the radio's Private Call feature. Pressing a button programmed to PC # will cause the radio to enter the Private Call feature at the list member corresponding to the button's Index field. The PTT must be pressed to initiate the private call. The Call List used will be the MDC Call List for MDC Personalities, or the Call List assigned to the current Trunking Personality. [1]
PH	The Direct Phone (PH1, PH2, ...) buttons allow instant access to the radio's Phone feature. Pressing a button programmed to PH # will cause the radio to send a phone request and transmit a pre-programmed number from the Radio Wide Phone List (F4->F3->F4). The button's Index field indicates which phone list number to transmit. [1]
Phon	Used with the Conventional Phone option and/or the Trunking Phone option to select phone numbers and place a phone call.
Pwr	Used to turn on the radio.
Rab1	Repeater Access Button One. Used to send a repeater access code word.
Rab2	Repeater Access Button Two. Used to send a repeater access code word.
RCL	To recall the last mode visited for more than 3 seconds.
Resp	Call Response to the Phone Receive or Call Receive.
Rpgm	The Re-program Request button is used on Trunking modes with the Dynamic Regrouping option to show the current dynamic regrouping state and to send in a Re-program Request.
Scan	Used with the Conventional Scan option and/or the Trunking Scan option to select scan lists and turn scan ON/OFF.
Sec	The SECURENET button is used with the SECURENET option to switch between Clear (Off) and Coded (On) operation.
Sel	Select.
Site	Used with the Automatic Multiple Site Switching (AMSS) option or the SmartZone option to display the lock status and toggle between lock and unlock status.
ST	The Direct Status (ST1, ST2, ...) buttons allow instant access to the radio's Status feature. When a button with ST # is pressed, the radio will check to see if it is currently in a personality that has Status enabled. If so, it will transmit the Status number which is specified in the button's Index field. If the current mode is Conventional, the Status List used will be the Conventional Status Alias List. Otherwise, the Status Alias List assigned to the current Trunking Personality will be used. If the personality does not have Status enabled, no Status will be sent. [1]
Sts	Used with the Conventional MDC-1200 Status option and/or the Trunking Status option to enter or exit the status function.
Unpr	This button is not assigned to any feature of the radio.
ZnDn	Used to scroll downward through the zones in the radio, <i>if Zone operation is enabled.</i>
ZnUp	Used to advance upward through the zones in the radio, <i>if Zone operation is enabled.</i>
Zone	Used to select a Zone in the radio, if zone is selectable.

Note

[1] Only one button can be programmed with a given list member. For example, you can have a button programmed with ST1, another button programmed with MG1, and another button programmed with ST2, but cannot have two buttons both programmed with ST1.

Radio Wide Switch Configuration



At the MAIN MENU, press **F4** and then **F3** three times to access this screen.

MOTOROLA Radio Service Software MCS Model:	Use UP/DOWN Arrows to Select Choice.								
...CONFIG:FEATURES:SWITCHES									
RADIO WIDE SWITCH CONFIGURATION ----- <table style="width: 100%; border-collapse: collapse;"> <thead> <tr> <th style="text-align: left; border-bottom: 1px dashed black;">Switch Labels</th> <th style="text-align: left; border-bottom: 1px dashed black;">Feature</th> </tr> </thead> <tbody> <tr> <td style="padding-left: 40px;">Ignition Switch</td> <td style="padding-left: 40px;">Blank</td> </tr> </tbody> </table>		Switch Labels	Feature	Ignition Switch	Blank				
Switch Labels	Feature								
Ignition Switch	Blank								
F1 HELP	F2	F3	F4	F5	F6	F7	F8	F9	F10 EXIT

This screen allows you to assign features to specific switches. Press **Tab** to select the desired field, or press the desired function key (**F1 - F10**). If a field is highlighted, use the UP/DOWN arrow keys to scroll through all the ignition switch options.

Field Definitions

Ignition Switch

The valid options for Ignition Switch are:

PTT Tx Inhibit	PTT transmission will be inhibited when the ignition is off.
Tx Inhibit	All transmission will be inhibited when the ignition is off. This includes emergency alarms.
Soft Power Off	The radio will power down when the ignition is turned off.
Blank	Transmissions will not be inhibited when the ignition is off.

The default is Blank.

Radio Wide Menu Item Configuration



At the MAIN MENU, press **F4**, **F3** twice, and then **F4** to access this screen.

MOTOROLA Radio Service Software MCS Model:					Use UP/DOWN Arrows to Select Choice.				
...CHANGE/VIEW:CONFIG:FEATURES:MENUS									
RADIO WIDE MENU ITEM CONFIGURATION -----									
#	Conv Item				#	Trunk Item			
-	-----				-	-----			
1	ZONE				1	ZONE			
F1	F2	F3	F4	F5	F6	F7	F8	F9	F10
HELP	ADD		DELETE			ADD		DELETE	EXIT
	CNV ITM		CNV ITM			TRK ITM		TRK ITM	

Radio models with the front display utilize a menu which appears on the radio display to simplify radio operation. By pressing the appropriate radio button to choose this menu, the sub-options or features for this menu item will appear on the menu. From here the features can be accessed easily. For example, pressing View might display Phon, Call or Scan.

This RSS screen is used to customize the radio for the required feature set. Depending on your radio version and model number, you will be able to choose from all or some of the functions listed below. Features listed here but that are disabled in the personality will not be shown on the RADIO WIDE CONFIGURATION MENU. The menu items are displayed in the order in which they are placed in the list.

Press **Tab** to select the desired field, or press the desired function key (**F1 - F10**). If a field is highlighted, use the UP/DOWN arrow keys to select the desired function.

Function Key Definitions

F2 - ADD CNV ITM

Adds a Conventional item.

F4 - DELETE CNV ITM

Deletes a Conventional item. You will be prompted before the item is actually deleted.

F7 - ADD TRK ITM

Adds a Trunked item.

F9 - DELETE TRK ITM

Deletes a Trunked item. You will be prompted before the item is actually deleted.

Field Definitions

Conv Item

Use the UP/DOWN arrow keys to select the desired menu function. Press **F2** to add and **F4** to delete the highlighted Conventional item. *Depending on your radio version and model number, you will be able to choose from some or all of the functions listed below.*

CALL	Select Private Call ID and send Private Call. <i>For the radio to function properly, the Selective Call feature must be enabled on the PERSONALITY MDC OPTIONS screen (F4/F6/F3/F7) and the Signalling Type must be set to MDC.</i>
CHAN	Select/change Channels.
DIM	Change the display brightness to one of four levels: from off to high, high to medium, medium to low, or low to off.
DIR	Enable/disable Talkaround. <i>For the radio to function properly, this feature must also be enabled on the CONVENTIONAL PERSONALITY screen (F4/F6/F3).</i>
H/L	Enable/disable Horn and Lights. <i>This feature must also be enabled on the ALARM OPTIONS screen (F4/F3/F7).</i>
HAND	Toggle between Handset and Microphone operation. In Handset operation, the audio is re-routed to the Handset speaker for a private conversation when the handset is removed from its hang-up clip. In Microphone operation, the audio is always routed through the speaker. <i>This feature is not compatible with the Hand Held Control Head (HHCH) feature.</i>
MSG	Display the last acknowledged message to be transmitted and send a message.
MUTE	Enable/disable keypad beeps.
PAGE	Select Call Alert ID and send a Call Alert. <i>For the radio to function properly, this feature must also be enabled on the PERSONALITY MDC OPTIONS screen (F4/F6/F3/F7).</i>
PHON	Select DTMF Phone Number to be transmitted. <i>For the radio to function properly, this feature must also be enabled on the CONVENTIONAL PERSONALITY screen (F4/F6/F3).</i>
PROG	Change Phone/Scan lists. <i>For the radio to function properly, the Phone and/or the Scan feature must also be enabled on the CONVENTIONAL PERSONALITY screen (F4/F6/F3).</i>
PSWD	Change Radio Lock Password. For PSWD to show on the RADIO WIDE MENU ITEM CONFIGURATION screen. RADIO LOCK must be enabled on the RADIO WIDE DISPLAY OPTIONS screen (F4/F3/F6).
PWR	Enable/disable Tx Low Power.
SCAN	Enable/disable Channel Scan. <i>For the radio to function properly, a scan list must be specified on the CONVENTIONAL PERSONALITY screen (F4/F6/F3).</i>
STS	Display the last acknowledged status to be transmitted and send status.
TX IN	Enable/disable Tx Inhibit.
VIEW	View Phone/Scan/Call lists. <i>For the radio to function properly, the Phone, Scan or Call List features must also be enabled on the CONVENTIONAL PERSONALITY screen (F4/F6/F3).</i>
ZONE	Select/change Zones.

Note: Do NOT duplicate a function on multiple controls (on a button and a switch, or a button and a menu for instance). This may cause the radio to malfunction and confuse the operator.

Trunk Item

Use the UP/DOWN arrow keys to select the desired menu function. Use **F7** to add, and **F9** to delete, Trunking Menu functions. *Depending on your radio version and model number, you will be able to choose from all or some of the functions listed below.*

CALL	Select Private Call ID. <i>For the radio to function properly, this feature must also be enabled on the TRUNKING PERSONALITY screen (F4/F4/F4).</i>
CHAN	Select/change Channels.
DIM	Change the display brightness to one of four levels: from off to high, high to medium, medium to low, or low to off.
FScn	The Spectrum Scan menu item is used with SmartZone to initiate/continue a Full Spectrum CC Scan. When selected, the radio will scan the spectrum for a control channel with a system ID that matches the system that the radio is currently using. If the radio finds a control channel, it will stop. If the menu item is selected again, the radio will pick up where it left off in the spectrum and continue scanning. The radio automatically stops scanning if it does not locate a control channel before the Full Spectrum CC Scan Timer expires. The Timer duration can be set in the SmartZone Environment screen (MAIN-F4-F4-F2-F2). The radio operator can manually stop the scanning by changing the radio's mode. IMPORTANT Full Spectrum CC Scan must be enabled on the SmartZone Environment screen for this feature to function properly.
H/L	Enable/disable Horn and Lights. <i>This feature must also be enabled on the ALARM OPTIONS screen (F4/F3/F7).</i>
HAND	Toggle between Handset and Microphone operation. In Handset operation, the audio is re-routed to the Handset speaker for a private conversation when the handset is removed from its hang-up clip. In Microphone operation, the audio is always routed through the speaker. <i>This feature is not compatible with the Hand Held Control Head (HHCH) feature.</i>
MSG	Display the last acknowledged message to be transmitted and send a message.
MUTE	Enable/disable keypad beeps.
PAGE	Select Call Alert ID. <i>For the radio to function properly, this feature must also be enabled on the TRUNKING PERSONALITY screen (F4/F4/F4).</i>
PHON	Select DTMF Phone Number to be transmitted. <i>For the radio to function properly, the Phone Interconnect feature must also be enabled on the TRUNKING PERSONALITY screen (F4/F4/F4).</i>
PROG	Change Phone/Scan lists. <i>For the radio to function properly, the Phone and/or the Scan feature must also be enabled on the TRUNKING PERSONALITY screen (F4/F4/F4).</i>
PSWD	Change Radio Lock Password. For PSWD to show on the RADIO WIDE MENU ITEM CONFIGURATION screen. RADIO LOCK must be enabled on the RADIO WIDE DISPLAY OPTIONS screen (F4/F3/F6).
PWR	Enable/disable Tx Low Power.
RPGM	Request Dynamic Regrouping.
SCAN	Enable/disable Channel Scan. <i>For the radio to function properly, this feature must also be enabled on the TRUNKING PERSONALITY screen (F4/F4/F4).</i>

SITE	Change AMSS or SmartZone Site. <i>For the radio to function properly, this feature must also be enabled on the TRUNKING SYSTEM screen (F4/F4/F3).</i>
STS	Display the last acknowledged status to be transmitted and send status.
TX IN	Enable/disable Tx Inhibit.
VIEW	View Phone/Scan lists. <i>For the radio to function properly, the Phone and/or Scan features must also be enabled on the TRUNKING PERSONALITY screen (F4/F4/F4).</i>
ZONE	Select/change Zones.

Note: Do NOT duplicate a function on multiple controls (on a button and a switch, a button and a menu, or a switch and a menu for instance). This may cause the radio to malfunction and confuse the operator.

DEK Configuration



At the MAIN MENU, press **F4**, **F3** twice, and then **F5** to access this screen.

MOTOROLA Radio Service Software MCS Model:		Use UP/DOWN Arrows to Select Choice.	
MAIN:CHANGE/VIEW:CONFIG:FEATURES:DEK			
Number of DEK boxes...3		DEK BUTTON CONFIGURATION	
DEK C	[Blnk] [Blnk] [Blnk] [Blnk] [Blnk] [Blnk] [Blnk] [Blnk]		
DEK B	[Blnk] [Blnk] [Blnk] [Blnk] [Blnk] [Blnk] [Blnk] [Blnk]		
DEK A	[Blnk] [Blnk] [Blnk] [Blnk] [Blnk] [Blnk] [Blnk] [Blnk]		
F1 HELP	F2 ADD DEK BOX	F3	F4 DELETE TOP DEK BOX
F5	F6	F7	F8
F9	F10 EXIT		

DEK Configuration Screen

The Direct Entry Keypad (DEK) screen is used to specify the number of DEK boxes that are connected to the radio and to program each DEK button to have a specific function.

DEK boxes allow the radio to effectively have more programmable features and to access these features with a single button press.

Function Key Definitions

F2 - ADD DEK BOX

ADD DEK BOX allows you to add a DEK Box with 8 buttons. A maximum of three DEK boxes may be added.

F5 - DELETE TOP DEK BOX

Delete Top Dek Box deletes the top DEK Box. In other words, if there are two DEK Boxes, pressing **F5** will delete DEK B, regardless of where the cursor is currently positioned.

Field Definitions

Number of DEK Boxes

Number of DEK Boxes is a view-only field that displays the number of DEK boxes connected to the radio. Each DEK box represents a group of eight DEK buttons. This field will change as DEK boxes are added or deleted by using the **F2** and **F5** function keys. The minimum number of DEK boxes is 0. The maximum number of DEK boxes is 3.

The factory default is 0.

DEK Buttons

Use the UP/DOWN arrow keys to select the desired function for this button and then use the Enter (Carriage Return) or Tab key to advance to the next button position. Use the Shift Tab to backup to the previous button position. The features available on the DEK buttons are the same as those available on the Control Head Buttons (see the Radio Wide Button Configuration Screen).

Phone Configuration



At the MAIN MENU, press **F4**, **F3** and then **F4** to access this screen.

MOTOROLA Radio Service Software MCS Model:		Use UP/DOWN Arrows to Select Choice.	
MAIN: CHANGE / VIEW : CONFIG : PHONE			
PHONE CONFIGURATION			

Man Acc Live Dialing.....Disabled		Phone Num Display Format.....None	
	Num	Phone Number	Phone Text
	-----		-----
	1		PHONE 1
	2		PHONE 2
	3		PHONE 3
	4		PHONE 4
	5		PHONE 5
	6		PHONE 6
	7		PHONE 7
	8		PHONE 8
F1	F2	F3	F4
HELP	ADD		DELETE
	NUMBER		NUMBER
		F5	F6
		DEACCESS	DIAL
		OPTIONS	EXIT
		F7	F8
			DEACCESS
		F9	F10
		DIAL	EXIT

This menu allows you to edit telephone interconnect configurations for a radio including stored telephone numbers and aliases. These parameters are radio wide and apply to both Trunking and Conventional signalling.

Press **Tab** to select the desired field, or press the desired function key (**F1 - F10**). If the field is highlighted, use the UP/DOWN arrow keys to select the desired choice or value. Enter the phone number directly. Use the **PgUp** and **PgDn** keys to view additional pages of phone lists.

Function Key Definitions

F2 - ADD NUMBER

Adds a new phone number entry.

F5 - DELETE NUMBER

Deletes an existing phone number. You will be prompted before the number is actually deleted.

F8 - ACCESS/DEACCESS

Takes you to a screen where you can modify DTMF access codes.

F9 - DIAL OPTIONS

Takes you to a screen where you can modify DTMF timing parameters.

Field Definitions

Man Acc Live Dialing

Manual Access Live Dialing will function only on personalities with unlimited phone access. Use the UP/DOWN arrow keys to enable/disable this feature. If this feature is enabled, the user will be able to dial phone numbers and access codes directly from the keypad during transmission.

Note: When enabled, this selection will override the phone dialing selection on the DIAL OPTIONS screen (**F4/F3/F4/F9**).

The default is Disabled.

Phone Num Display Format

Use the UP/DOWN arrow keys to select the format for displaying telephone numbers. Valid choices are USA and None. If set to USA, the phone numbers will be assumed to be in the format (area) code/number.

The default is None which means no special formatting is required.

Phone Number

Enter a phone number of up to 16 characters. The digits 0 through 9 are all valid, and so are the special characters "P", "*" and "#". The "P" entry causes the radio to pause momentarily during dialing. The length of the pause is programmable from the DIAL OPTIONS screen (F9 from the PHONE CONFIGURATION screen).

Numbers can be added and deleted using the F2 and F5 keys respectively. New numbers will be added at the end of the list. *A total of 19 numbers are allowed for HHCH models and models II and III and 10 numbers for all other models.*

Phone Text

Enter the alphanumeric name that will appear on the radio display for this phone number. *The maximum number of characters will be determined by the radio model.*

DTMF Access/ Deaccess Codes



At the MAIN MENU, press **F4**, **F3**, **F4** and then **F8** to access this screen.

MOTOROLA Radio Service Software MCS Model:		Enter Code.
MAIN: CHANGE / VIEW : CONFIG : PHONE : CODES		
DTMF ACCESS/DEACCESS CODES -----		
Num	Access Code	Deaccess Code
---	-----	-----
1	*1P#	*1P#

F1 HELP	F2 ADD CODE	F3
F4	F5 DELETE CODE	F6
F7	F8	F9
F10 EXIT		

This screen allows the user to define Access/Deaccess Code pairs used for DTMF phone option. The Access Code is used to keep unauthorized users from using the interconnect system on the repeater. The Deaccess Code is used to inform the system about the end of a call and thus minimize wasted air time. The valid symbols are 0 (zero) through 9, “*”, “#” and “P” (for pause).

Note: These codes can be selected in the Auto Access Code field on the PHONE OPTIONS screen (**F4/F3/F4/F9**). *Up to 19 code pairs may be defined.*

Press **Tab** to select the desired field, or press the desired function key (**F1 - F10**). If a field is highlighted, enter the Access or Deaccess Code directly.

Function Key Definitions

F2 - ADD CODE

Adds another Access/Deaccess Code pair.

F5 - DELETE CODE

Deletes the highlighted Access/Deaccess Code pair from the list. You will be prompted before the code pair is actually deleted.

Field Definitions

Access Code

Enter the code that will be used to access the phone line. Some Conventional interconnect systems require a "*" to access the telephone line. Other systems require a multi-digit Access Code which consists of 1 to 4 digits and may or may not contain a "*". Multi-digit Access Codes are used to prevent unauthorized subscriber units from accessing the interconnect system.

Note: To enter pause (P) from the keypad, press "*" and then "#".

Codes can be added and deleted using the **F2** and **F5** keys respectively. New codes will be added at the end of the list.

Note: A total of 19 unique Access pairs are allowed.

Deaccess Code

Enter a one- to four-digit release code to deaccess the phone line. Some Conventional interconnect systems require a "#" to release (disconnect) the telephone line when the user has finished using it.

Release codes are used for system management purposes to improve system loading by eliminating dead air time after interconnect calls are completed.

Note: To enter pause (P) from the keypad, press "*" and then "#".

Codes can be added and deleted using the **F2** and **F5** function keys. New codes will be added to the end of the list.

Note: A total of 19 unique Deaccess pairs are allowed.

Dialing Options



At the MAIN MENU, press **F4**, **F3**, **F4** and then **F9** to access this screen.

MOTOROLA Radio Service Software MCS Model:					Use UP/DOWN Arrows to Select Choice.				
MAIN: CHANGE / VIEW : CONFIG : PHONE : DTMF									
DIALING OPTIONS -----									
Phone Dialing. Delayed Buffered					DTMF Pause Time (ms).....1000				
DTMF Digit Hangtime (ms)....1000									
	Num	Initial Delay (ms)	Digit (ms)	Duration (ms)	Interdigit Delay (ms)				
	---	-----	-----	-----	-----				
	1	1000		125	75				
	2	250		150	100				
	3	350		125	75				
	4	350		125	75				
F1	F2	F3	F4	F5	F6	F7	F8	F9	F10
HELP									EXIT

This screen allows you to modify DTMF phone-wide parameters such as timing and phone dial operation. Each Conventional system uses one of these parameter sets which are selected in the Auto Access Code field on the CONVENTIONAL PERSONALITY screen (**F4/F6/F3**).

Press **Tab** to select the desired field, or press the desired function key (**F1 - F10**). If a field is highlighted, press the UP/DOWN arrow keys to select the desired choice or value.

Field Definitions

Phone Dialing

Use the UP/DOWN arrow keys to select the type of Dialing operation from among the following:

Immediate Live	Automatically connects the radio to the system when entering phone mode (live dial).
Immediate Buffered	Automatically connects the radio to the system when entering phone mode (buffered dial).
Delayed Buffered	Automatically connects the radio to the system when PTT is pressed (buffered dial). Allows the user to enter the phone number in the radio and then transmit the phone number after pressing PTT.

DTMF Digit Hangtime (ms)

Use the UP/DOWN arrows to specify the amount of time the radio continues transmitting after completion of a DTMF digit transmission. Valid selections are 25 to 6375 ms in 25-ms increments.

The default is 1 second (1000 ms).

DTMF Pause Time (ms)

Use the UP/DOWN arrows to select the length of time that the carrier is transmitted before the radio begins to transmit DTMF digits. Valid selections are 500 to 4000 ms in 500-ms increments.

The default is 1000 ms (1 second).

Initial Delay (ms)	<p>Use the UP/DOWN arrows to select the pre-time for DTMF signalling or the length of time that carrier is transmitted before the DTMF digit is transmitted. Valid selections are 0 (zero) to 6375 ms in 25-ms increments.</p> <p>The default is 250 ms.</p>
Digit Duration (ms)	<p>Use the UP/DOWN arrows to select the length of time that the DTMF digit will be transmitted. Valid selections are 25 to 6375 ms in 25-ms increments.</p> <p>The default is 150 ms.</p>
Interdigit Delay (ms)	<p>Use the UP/DOWN arrows to select the time delay between transmission of digits in a DTMF digit transmission sequence. Valid selections are 0 (zero) to 250 ms in 25-ms increments.</p> <p>The default is 100 ms.</p>

Radio Wide Scan Lists and Options



From the MAIN MENU, press **F4**, **F3** and then **F5** to access this screen.

MOTOROLA Radio Service Software MCS Model: Page 1 of 2 MAIN:CHANGE/VIEW:CONFIG:SCAN		Use UP/DOWN Arrows to Select Choice.							
<pre> Scan List.....1 SCAN LIST ----- Mem Zn Chn Zone Channel Scan Type.....Conventional --- -- --- ---- - 1 2 Dynamic Priority.....Disabled 3 Priority 1 Type.....Fixed 4 Priority 1 Member.....None 5 Priority 2 Type.....Fixed 6 Priority 2 Member.....None 7 NonPriority Members.....Fixed 8 Designated Tx Mem.... Talkback </pre>									
F1	F2	F3	F4	F5	F6	F7	F8	F9	F10
HELP	ADD LIST	PREV LIST	NEXT LIST	DELETE LIST	DELETE MEMBER		SCAN OPTIONS		EXIT

This screen is used to configure the Channel Scan feature and to enter the scan list. Each personality selects a scan list by choosing the scan list number. Both Conventional and Trunking personalities may use these scan lists by choosing the appropriate scan list number on the CONVENTIONAL AND TRUNKING PERSONALITY screens. *However, the scan list type must be compatible with the capability of the personality; for instance, a Conventional personality cannot choose a Trunking Type II list.*

Note: All systems, personalities and zone/channel assignments must be completed before you attempt to create a scan list.

Press **Tab** to select the desired field, or press the desired function key (**F1 - F10**). If a field is highlighted, Use the UP/DOWN arrow keys to select the desired choice or value. Use the **PgUp/PgDn** keys to view additional pages of the scan list if any.

Function Key Descriptions

- | | |
|--------------------|---|
| F2 - ADD LIST | Adds a scan list. You may have up to 20 scan lists. |
| F3 - PREV LIST | Displays information for the previous scan list. |
| F4 - NEXT LIST | Displays information for the next scan list. |
| F5 - DELETE LIST | Delete the current scan list. |
| F6 - DELETE MEMBER | Deletes the currently highlighted member from the scan list. |
| F8 - SCAN OPTIONS | Brings up the SCAN OPTIONS screen where you will be able to customize the Channel Scan feature for specific applications. |

Field Definitions

Scan List

Use the UP/DOWN arrow keys to select a specific scan list, or use the **F3/F4** function keys to scroll through the lists. Each mode has a unique scan list. Each Conventional and Trunking personality may have a unique scan list. The scan lists defined on this screen are assigned on the CONVENTIONAL and TRUNKING PERSONALITY screens. Lists may be added by pressing the **F2** key and the currently highlighted list can be deleted using the **F5** key.

The default is 1.

Scan Type

Use the UP/DOWN arrow keys to select the type of scan list. The choices are:

Conventional	May contain only Conventional personalities (up to 15 members).
Talkgroup	May contain both Conventional and Trunked personalities from different systems (up to 10 members).
Priority Mon(itor)	May contain only Trunking personalities from the same Type II system (up to 10 members). <i>If the SMARTNET Type I feature has been purchased, this type may contain Trunking personalities from the same Type I system (up to 10 members).</i>
Subfleet	May contain only Trunking personalities from the same Type I system (up to 10 members).

The default is Conventional.

Dynamic Priority

This field will be visible only if Scan Type is set to Conventional. When this feature is enabled, the Priority 2 Type field will not be visible. Use the UP/DOWN arrow keys to enable/disable Dynamic Priority. The last channel transmitted on will become (and remain) the Second Priority Channel until a new channel is transmitted on or scan is disabled. The priority of the First Priority channel is not affected.

The default is Disabled.

Priority 1 Type & Priority 2 Type

This field is visible only if the Scan Type field is set to Conventional or Priority Monitor. Use the UP/DOWN arrow keys to select the type of Priority Scan the radio will use from among the following:

Selected Chan	The radio will use the last selected channel as the Priority Member. First priority and second priority may not both refer to the selected channel.
Fixed	The radio uses a selected member of the scan list, set from the RSS, as the Priority Channel. <i>This member is fixed and cannot be programmed from the radio.</i>
OP/SEL (Operator Selectable)	The radio uses a selected member of the scan list as the Priority Channel. The user must select the member of the scan list to be used as the priority member. <i>This member can be programmed both from the RSS and the radio.</i>
Disabled	No Priority Channel will be allowed.

The default is Disabled.

Priority 1 Member

This field is visible only when the Priority 1 Type field is set to Fixed or OP/SEL. Use the UP/DOWN arrow keys to select the Scan member which has First Priority in scan selection. The channel number may also be entered directly. When assigned, the Priority 1 Member is typically Member 1 in the Scan List. Select None for no First Priority channel.

The default is None.

Priority 2 Member

This field is visible only when the Priority 2 Type field is set to Fixed or OP/SEL. Use the UP/DOWN arrow keys to select the Scan Member which has Second Priority in scan selection. Select None for no Second Priority channel.

Note: The member selections for Priority 1 Member and Priority 2 Member must be different.

The default is None.

Non-Priority Members

Use the UP/DOWN arrow keys to select the non-priority scan type from among the following:

Fixed	The radio uses a selected member of the scan list configured from the RSS as the Priority Channel. <i>This member is fixed and cannot be programmed from the radio.</i>
OP/SEL (Operator Selectable)	The radio uses a selected member of the scan list as the Priority Channel. The user must select the member of the scan list to be used as the priority member. <i>This member can be programmed both from the RSS and the radio.</i>

The default is Fixed.

Designated Tx Mem

Use the UP/DOWN arrow keys to select the Designated Transmit Talkback channel. For Conventional scan lists, this may be the number of the scan member which will serve as designated transmit channel during scan operation. Enter the number of the scan member to have a fixed channel. *This channel may not be a receive-only channel.* The other options are:

Selected Chan	Transmission will occur on the last user-selected channel.
Talkback	Transmission will occur on the same channel that the scanner stopped on.

Note: If the channel is a receive-only channel, the radio will issue a warning to inform you that transmission is not possible.

The default is Talkback.

Zn

Use the UP/DOWN arrow keys to select the Zone (or System) for this member of the scan list. The Zone (System) name from the ZONE/CHANNEL ASSIGNMENT screen (**F4/F8**) will be shown to the right.

Chn

Use the UP/DOWN arrow keys to select the Channel (or Subfleet) for this member of the scan list. The Zone (System) name from the ZONE/CHANNEL ASSIGNMENT screen (**F4/F8**) will be shown to the right.

Note: If the field displays “???”, an invalid channel condition exists.

Trunking System ID (*not shown*)

This field is visible only if the Scan Type field is set to Priority Monitor or Subfleet. Use the UP/DOWN arrow keys to select the Trunking System this personality is to use. (The System ID is shown according to system number.)

Note: The Trunking System should be set up in the TRUNKING SYSTEM screen (**F4/F4/F3**) before personality information is entered since some fields in this screen depend on system information.

The default is 1-0001.

Trunking System Type (*not shown*)

*This field is read-only and is visible only if the Scan Type field is set to Priority Monitor or Subfleet. The value in this field is derived from settings in the TRUNKING SYSTEM screen (**F4/F4/F3**).*

Radio Wide Scan Options



From the MAIN MENU, press **F4**, **F3**, **F5** and then **F8** to access this screen.

MOTOROLA Radio Service Software MCS Model:		Use UP/DOWN Arrows to Select Choice.	
MAIN:CHANGE/VIEW:CONFIG:SCAN:OPTIONS			
SCAN OPTIONS -----			
RADIO WIDE -----		CONVENTIONAL -----	
Nuisance Mode Delete.....	Disabled	Carrier Detect Required....	Disabled
Priority Scan Alert.....	Disabled	Priority Chan Marking.....	Disabled
Rx Hold Time (sec).....	3	Monitor Hold Time (sec).....	6
HUB Suspends Scan.....	Enabled	Voting Scan.....	Disabled
Suspend All Scan.....	Disabled		
TRUNKING -----			
		Failsoft Hold Time (sec).....	6
		System Search Time (sec).....	1
F1	F2	F3	F4
F5	F6	F7	F8
F9	F10		
HELP			EXIT

This screen is used to customize the Channel Scan feature for specific applications. Options and parameters that affect Radio wide, Conventional and Trunking operations are available. Press **Tab** to select the desired field, or press the desired function key (**F1 - F10**). If a field is highlighted, press the UP/DOWN arrow keys to select the desired choice or value.

Field Definitions

Nuisance Mode Delete

Use the UP/DOWN arrow keys to enable/disable this feature. The Nuisance Mode Delete setting allows the user to temporarily delete from the scan list non-priority channels that are constantly busy. Such activity may cause the radio to be constantly locked onto a channel. *A channel deleted using this option will remain deleted until scan is turned off. When scan is turned on, all channels that were previously deleted will be replaced.*

The default is Enabled.

Priority Scan Alert

Use the UP/DOWN arrow keys to enable/disable this feature. If this option is enabled, the radio will audibly alert you in one of two ways described below when it unmutes on a priority channel while scanning:

- One beep is generated for the priority talkgroup/subfleet in a Trunked scan list or for the first priority channel in a Conventional scan list.
- Two beeps are generated for the second priority channel in a Conventional scan list.

The default is Disabled.

Rx Hold Time (sec)	<p>Use the UP/DOWN arrow keys to select the amount of time the radio remains on a channel after a message has been received before scanning resumes. Valid entries range from 0 (zero) to 255 seconds in one-second increments.</p> <p>The default is 3 seconds.</p>
HUB Suspends Scan	<p>This field is used to enable/disable the HUB (Hang Up Box) Suspends Scan feature.</p> <p>When enabled, this feature operates as follows:</p> <ul style="list-style-type: none"> - If using either a Conventional channel in non-Talkback scan mode or a Trunking channel in non-Talkback scan mode, scan operation is suspended while the microphone is removed from the hang up box. This allows the user to complete a conversation during this time. - If using a Conventional channel in Talkback scan mode or a Trunking Priority Monitor channel in Talkback Scan mode, standard scan operation is suspended while the microphone is removed from the hang up box. However, scan will continue to look at priority members for activity. If activity occurs on priority members, the radio will scan to the active member and unmute. - The Suspend All Scan field will become available to the user. When enabled, Suspend All Scan enhances the HUB Suspends Scan operation by suspending ALL scan operation (including scan to priority members in Conventional or Priority Monitor Talkback Scan mode). <p>The factory default is Disabled.</p>
Suspend All Scan	<p>This field is used to enable/disable the HUB (Hang Up Box) Suspend All Scan feature. When enabled, this feature enhances the HUB Suspends Scan operation. If using a Conventional channel in Talkback scan mode or Trunking Priority Monitor channel in Talkback scan mode, ALL scan operation, including scan to priority members, is suspended while the microphone is removed from the hang up box. This allows the user to complete a conversation during this time without the possibility of interruption by scanning to a priority channel.</p> <p>Note: The setting of HUB Suspend All Scan does not affect the way the HUB Suspends Scan feature operates for Talkgroup or Sub-Fleet scan.</p> <p>The factory default is Disabled.</p>
Carrier Detect Required	<p>Use the UP/DOWN arrow keys to enable/disable this feature. When this option is enabled, the radio will stop scanning and operate on the priority channels based on carrier squelch detect, but will only unmute on the standard signalling conditions programmed for that channel.</p> <p>The default is Disabled.</p>

Priority Chan Marking

Use the UP/DOWN arrow keys to enable/disable this feature. When this option is enabled and the radio is in Priority Scan mode, the radio checks the channel for activity and proper PL. If the channel has Carrier but the wrong PL or no PL, the channel is marked so that the radio will not check a second time for the proper PL. The radio will not unmute on this channel until carrier is dropped. This is done to eliminate time spent checking for proper PL and thus minimize audio holes.

Note: Care should be exercised in using this feature. It is possible for messages to be missed especially if long repeater hangtimes are used.

The default is Disabled.

Monitor Hold Time (sec)

Use the UP/DOWN arrow keys to select the length of time that the radio will remain on a Conventional channel during scan after the monitor button has been released. Valid entries range from 0 (zero) to 255 seconds in one-second increments.

The default is 6 seconds.

Voting Scan

Conventional Voting Scan is used to select the best repeater to use in a multi-frequency simulcast conventional system. Enabling this field will cause all conventional personalities using a conventional scan list with Auto Scan enabled (Main-/F4/F6/F3/F9) to perform conventional voting scan.

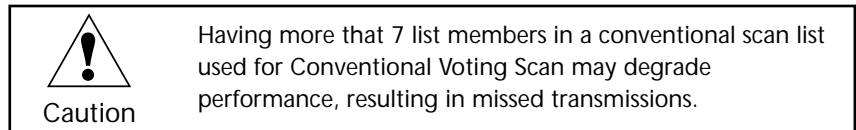

Before using Conventional Voting Scan, you must first create a conventional scan list which contains all repeaters in the Conventional Voting Scan wide area network. Each conventional personality in this list must have Auto Scan enabled.

The default is disabled.

Failsoft Hold Time (sec)

Use the UP/DOWN arrow keys to select Trunking Failsoft Activity Time. This value determines how long the radio will stay unmuted on a failsoft channel if failsoft is found while in talkgroup scan. Valid values range from 1 to 255 seconds in one-second increments. You may also select Disabled.

The default is 6 seconds.

System Search Time (sec)

This timer applies only to systems which do not employ the scan marker feature. Use the UP/DOWN arrow keys to select the desired Trunk Activity Search Time. This timer determines how long the radio will stay on the control channel searching for voice activity before scanning the next system. Valid entries range from 0 (zero) to 255 seconds in increments of one second each.

The default is 10 seconds for SMARTNET models and one second for Privacy Plus models.

Radio Wide Display Options



From the MAIN MENU, press **F4**, **F3** and then **F6** to access this screen.

MOTOROLA Radio Service Software MCS Model:		Use UP/DOWN Arrows to Select Choice.	
MAIN:CHANGE/VIEW:CONFIG:DISP DATA			
RADIO WIDE DISPLAY OPTIONS -----			
Text Justification..... Left	Alt Display Time (ms).....1000	Temp Msg Display Time (ms)....1000	
Channel Text Size.....14			
Zone Text Size.....14			
Slow Scroll Rate (ms)....1000		Emergency Receive.....Disabled	
Fast Scroll Rate (ms)....250			
Slow Scroll Count.....3		Radio Lock..... Enabled	
Save Dim State.....Disabled		Mandatory Password.....Disabled	
Native Language.....English		Max Password Length.....8	
		Password.....	
F1 HELP	F2	F3	F4
	F5	F6	F7
		F8	F9 MORE
			F10 EXIT
			OPTIONS

This screen permits modifications to display options to customize the radio to specific user applications. The features and options shown here apply to all systems and personalities. Press **Tab** to select the desired field, or press the desired function key (**F1 - F10**). If a field is highlighted, press the UP/DOWN arrow keys to select the desired choice or value.

Field Definitions

Text Justification

This is a read only field. This setting applies to Channel and Zone names, Phone aliases, Private Call List aliases, Call Alert aliases, Status aliases and Message aliases.

The default is Left.

Channel Text Size

Use the UP/DOWN arrow keys to select the Channel (Subfleet) Text Size. Valid entries range from 1 to 14 characters in length *depending on the radio model*. The Channel Text size will vary inversely with the Zone (System) Text size since both must be displayed at the same time.

For eight -character, one-line display models, the default is three. For 14-character, one-line display models, the default is 11. For two-line display models, the channel text size field will be a read-only field with a fixed value of 14.

Zone Text Size

This is a read-only field. The value in this field is automatically calculated based on the value you specified in the Channel Text field. This is because both must Channel and Zone Text must be displayed at the same time. Valid entries are 0 (zero) to 13 characters in length *depending on the radio model*.

For eight-character, one-line display models, the default is five. For 14-character, one-line display models, the default is three. For two-line display models, the zone text size field will be a read-only field with a fixed value of 14.

Slow Scroll Rate (ms)	<p>Use the UP/DOWN arrow keys to select the Slow Scroll Rate, the rate at which the display will slow scroll through a list. The radio will first slow scroll and then fast scroll after the slow scroll count expires. Valid entries are 250 to 6250 ms in 250-ms increments.</p> <p>Note: The Slow Scroll Rate should be greater than or equal to Fast Scroll Rate but less than or equal to 6250 (that is, $250 \leq \text{Fast Scroll Rate} \leq \text{Slow Scroll Rate} \leq 6250$).</p> <p>The default is 1000 ms.</p>
Fast Scroll Rate (ms)	<p>Use the UP/DOWN arrow keys to select the Fast Scroll Rate, the rate at which the display will fast scroll through a list. The radio will first slow scroll and then fast scroll after the slow scroll count expires. Valid entries range from 250 to 6250 ms in 250-ms increments.</p> <p>Note: The Fast Scroll Rate should be greater than or equal to 250 but less than or equal to Slow Scroll Rate (that is, $250 \leq \text{Fast Scroll Rate} \leq \text{Slow Scroll Rate} \leq 6250$).</p> <p>The default is 250 ms.</p>
Slow Scroll Count	<p>Use the UP/DOWN arrow keys to select the number of menus to be scrolled before the radio switches to the Fast Scroll Rate. Valid entries range from 0 (zero) to 255.</p> <p>The default is 3 menus.</p>
Save Dim State	<p>Use the UP/DOWN arrow keys to enable/disable this option. If this field is enabled, display brightness will to be saved to the EEPROM for use during power-up initialization.</p> <p>The default is Disabled.</p>
Native Language	<p>Use the UP/DOWN arrow keys to select the language for radio display. Valid entries are English, Spanish, French, German, Italian and Portuguese.</p> <p>The default is English.</p>
Alt Display Time (ms)	<p>Use the UP/DOWN arrow keys to select the length of time that an Alternate message will be displayed. Valid entries range from 250 to 6250 ms in 250-ms increments.</p> <p>The default is 1 second (1000 ms).</p>
Temp Msg Display Time (ms)	<p>This refers to the length of time that a Temporary message will be displayed. Valid entries range from 250 to 6250 ms in 250-ms increments.</p> <p>The default is 1 second (1000 ms).</p>
Emergency Receive	<p><i>This feature is not compatible with Silent Emergency. To enable this feature, Silent Alarm must be disabled (F4/F3/F2/F7).</i> Use the UP/DOWN arrow keys to enable/disable the Emergency Receive Display option. If this feature is enabled, the radio display will alternate between Emergency</p>

Receive and the current channel when it unmutes on an emergency call. For eight-character display models, "EMER RCV" will be displayed. *Emergency must be enabled on each Trunking personality on the EMERGENCY DATA CONFIGURATION screen (F4/F4/F4/F8) if your radio supports the emergency feature.*

The default is Disabled.

Radio Lock

WARNING

Do not enable this feature for radios without keypads. If you do so, the radio will become inoperable since you cannot unlock the radio by entering the password.

Use the UP/DOWN arrow keys to enable the Radio Lock feature.

When this field is enabled, the user will be required to enter the Radio Lock Password on power up before using the radio.

The factory default is Disabled.

Mandatory Password

Use the UP/DOWN arrow keys to enable the Mandatory Password option.

When this field is enabled, the user must enter a password each time the radio is turned on. If this option is disabled, the user may avoid entering a password by changing it to NULL. (See Radio Operator's Manual.)

The factory default is Disabled.

Max Password Length

Use the UP/DOWN arrow keys to select the Maximum Password Length. Valid entries are 1 to 8 characters.

This is the maximum length a password is allowed to be. The radio uses this value only when the password function is enabled on a menu. This field is only applicable when the Radio Lock feature is enabled.

The factory default is 8.

Password

Enter the numeric Password directly from the keyboard. The password is the numeric value which must be entered when the radio is turned on when the radio lock feature is enabled.

The factory default is NULL.

Radio Wide Display More Options



From the MAIN MENU, press **F4**, **F3**, **F6**, and then **F9** to access this screen.

MOTOROLA Radio Service Software MCS Model: ...CONFIG:DISP DATA:MORE OPTIONS	Use UP/DOWN Arrows to Select Choice.								
RADIO WIDE DISPLAY MORE OPTIONS ----- Caller ID..... Disabled									
F1 HELP	F2	F3	F4	F5	F6	F7	F8	F9	F10 EXIT

This screen permits modification of display options to customize the radio to specific user applications. The features and options shown here apply to all systems and personalities.

Field Definitions

Caller ID

The Caller ID feature displays ID information of the last radio to initiate a call that the radio unmuted upon. This information is automatically displayed.

- ID Only - The radio will display the ID of the last radio which initiated the current call
- Alias Text - The radio will attempt to match the Caller ID with a member of the current Cal List and display a name instead of a number.

The default is Disabled.

Alarm Options



From the MAIN MENU, press **F4**, **F3**, and then **F7** to access this screen.

MOTOROLA Radio Service Software MCS Model:	Use UP/DOWN Arrows to Select Choice.								
MAIN:CHANGE/VIEW:CONFIG:ALARM OPTIONS									
ALARM OPTIONS ----- Horn And Lights..... Enabled Permanent Horn & Lights...Disabled Alarm Rearm Option.....Disabled Ext Alarm Delay (Sec).....7 Horn & Light Duration.....4									
F1 HELP	F2	F3	F4	F5	F6	F7	F8	F9	F10 EXIT

The ALARM OPTIONS screen is used to program and enable Horn and Light features. Press **Tab** to select the desired field, or press the desired function key (**F1 - F10**). If a field is highlighted, use the UP/DOWN arrow keys to select the desired choice or value.

Field Definitions

Horn and Lights

This field is used to enable the radio's Horn and Lights Alarm option.

The default is Disabled.

Permanent Horn & Lights

This field will be visible only if the Horn and Lights option is enabled. If this feature is enabled, there will be no repetitive Horn and Lights display and the radio powers up with alarm armed.

The default is Disabled.

Alarm Rearm Option

This field will be visible only if the Horn and Lights option is enabled. If this option is enabled, Horn and Lights will remain armed even after the user responds to a call. In this case, the only way to disarm Horn and Lights is by pressing the H/L button. If this option is disabled, the alarm is disarmed on receipt of an incoming call.

The default is Disabled.

Ext Alarm Delay (sec)

This field will be visible only if the Horn and Lights Option is enabled. This value in this field represents the time delay before horn and lights are activated. The valid range is 0 (zero) to 15 seconds.

The default value is 7 seconds.

Horn & Light Duration

This field will be visible only if the Horn and Lights Option is enabled. This field represents the maximum length of time the horn will stay on before the user responds to a call. Valid values range from 1 to 255. A value of Infinite is also available.

The default is 4 seconds.

Notes

Trunking Menu



From the MAIN MENU, press **F4** twice to access this screen.

MOTOROLA Radio Service Software MCS Model: MAIN:CHANGE/VIEW:TRUNKING	Select Function F1 - F10.								
TRUNKING MENU -----									
F1 - HELP F2 - Trunking Radio Wide Options F3 - Trunking Systems: System ID, Control Channels, etc. F4 - Trunking Personality: Talk Groups, Emergency options, etc. F5 - Trunking Call List Data F6 - F7 - F8 - F9 - F10 - EXIT, Return to Change/View Menu									
F1 HELP	F2 TRUNK WIDE OPT	F3 TRUNK SYS	F4 TRUNK PERS	F5 TRUNK ID LIST	F6	F7	F8	F9	F10 EXIT

This screen allows you to navigate to the Trunking edit screens. *The options in these menus pertain only to Trunking radio features.*

Function Key Descriptions

F2 - TRUNK WIDE OPT
(Trunking Radio Wide Options)

Brings up a screen that permits access to options relating to Trunking operation.

F3 - TRUNK SYS
(Trunking Systems)

Brings up a screen used to change and view Trunked system parameters. A Trunking system refers to a specific repeater site, system ID, individual radio ID for that system, control channel frequencies and the connect tone required to operate on that system.

F4 - TRUNK PERS
(Trunking Personality)

Brings up a screen used to change and view the parameters for a Trunking personality. A Trunking personality refers to the type of features and options that are used on a Trunking channel or talkgroup. Multiple personalities may use the same system and multiple talkgroups may use the same personality.

F5 - TRUNK ID LIST
(Trunking Call List)

Brings up a screen used to edit the list of Trunking Call IDs and their corresponding names (or aliases).

Trunking Radio Wide Options



From the MAIN MENU, press **F4** twice and then **F2** to access this screen.

MOTOROLA Radio Service Software MCS Model: ...CHANGE/VIEW:TRUNKING:WIDE OPTIONS	Enter or Scroll to Select Value.								
<p>TRUNKING RADIO WIDE OPTIONS</p> <p>-----</p> <p>Telephone Interconnect.....Half Duplex ISW Window Adjust..... 9B Auto Dial Holdoff (ms).....2000 RF Modem.....Disabled</p>									
F1 HELP	F2 SMRTZN ENV	F3 VOC OPT	F4	F5	F6	F7	F8	F9	F10 EXIT

The options and parameters on this menu apply to all Trunking operation independent of system, personality or talkgroup. Other radio wide options that apply to both Conventional and Trunking operation are located on the RADIO WIDE OPTIONS screen (**F4/F3/F2**). Conventional options are located on the CONVENTIONAL RADIO WIDE OPTIONS screen (**F4/F6/F2**).

Press **Tab** to select the desired field, or press the desired function key (**F1 - F10**). If a field is highlighted, use the UP/DOWN arrow keys to select the desired choice or value.

Function Key Descriptions

F2 - SMRTZN ENV
(SmartZone Environment)

This function will be visible only when a radio with the SmartZone software option has been read. Displays the screen where SmartZone operating environment parameters are defined.

F3 - VOC OPT
(Voice-On-Control Options)

This function will be visible only when a radio with the Voice-On-Control option has been read. Displays the screen which allows you to specify Voice-On-Control option parameters.

Field Definitions

Telephone Interconnect

Mobile products supported by this RSS support half-duplex phone communication ONLY. This option allows the radio to initiate and receive land-to-mobile telephone calls and specifies the type of interconnect.

Half duplex	Implies that communication can take place in one direction at a time only.
Full duplex	Permits communication in both directions simultaneously.

ISW Window Adjust

Use the UP/DOWN arrow keys to choose a code or enter the code directly. The ISW Window Adjust value is a timing parameter that is used to fine-tune Trunking system performance. The valid range of values is 0 (zero) to FFFF in increments of 1.

The default varies according to radio bandsplit.

 Caution	Do NOT modify this field unless you are a Motorola Field Technical Representative or unless you understand Trunking system timing and are absolutely certain that your modification is correct. <i>Changing the ISW Window Adjust may actually degrade Trunking system performance.</i>
--	---

Auto Dial Holdoff (ms)

Use the UP/DOWN arrow keys to select the amount of time the radio will wait after gaining access to the phone channel before a pre-queued phone number will be dialed. It ensures that the fixed end is ready for dialing to commence. Valid entries range from 0 (zero) to 6375 in the increments of 25 ms.

The default is 2000 ms.

RF Modem

If RF Modem is enabled, the radio will be able to function only as an RF Modem (that is, for use with system watch). When RF Modem is disabled, the radio operates normally.

The default is Disabled.

SmartZone Environment



From the MAIN MENU, press **F4** twice and then **F2** twice to access this screen.

MOTOROLA Radio Service Software MCS Model:	Enter or Scroll to Select Value.
..WIDE OPTIONS:SMARTZONE ENVIRONMENT	
SMARTZONE ENVIRONMENT -----	
Failsoft Inactivity (sec).....120	Filter Constant K1.....7
Busy Override Delay (sec).....4	Filter Constant K2.....6
Aff. Hold Off (sec).....255	Filter Constant K3.....5
Busy Override Chirp Ack.....ON	Filter Threshold Constant T1...14
Display Site Trunking.....ON	Filter Threshold Constant T2...1A
Full Spectrum CC Scan.....ON	Filter Threshold Constant T3...20
Full Spectrum CC Scan Timer...10	
RSSI OSW Counter.....80	
RSSI Acceptable Threshold.....61	
RSSI Good Threshold.....66	
RSSI Excellent Threshold.....69	
VC RSSI Acctpt Threshold..Disabled	
F1 F2 F3 F4 F5 F6 F7 F8 F9 F10	
HELP	EXIT

This screen allows you to change and view parameters for the SmartZone environment. Press **Tab** to select the desired field, or press the desired function key (**F1 - F10**). If a field is highlighted, use the UP/DOWN arrow keys to select the desired choice or value.

Field Definitions

Failsoft Inactivity (sec)

Use the UP/DOWN arrows to make your selection or enter a value directly. If a radio remains inactive while operating in failsoft for this time specified in this field, the radio will momentarily leave failsoft and attempt to find a control channel. A value of zero in this field indicates that the radio will not leave failsoft. The valid range is 0 (zero) to 255 seconds in one-second increments.

The default is 120 seconds.

Busy Override Delay (sec)

Use the UP/DOWN arrows to make your selection or enter a value directly. This is the time interval (in seconds) during which the user must depress the PTT button in order for the radio to issue a busy override signal. The valid range is 2 to 6 seconds in one-second increments.

The default is 4 seconds.

Aff. Hold Off (sec)

Use the UP/DOWN arrows to make your selection or enter a value directly. This is the time that the radio should delay before affiliating to a new site when leaving a site which just incurred a failure. Valid entries are 1, 3, 7, 15, 31, 63, 127 and 255 seconds.

The default is 255 seconds.

Busy Override Chirp Ack Use the UP/DOWN arrows to make your selection. If this field is set to On, the radio will produce a chirping sound after a busy override has been issued.

The default is On.

Display Site Trunking Use the UP/DOWN arrows to make your selection. If this field is set to On, the radio will display the Site Trunking message when the user is locked onto a site that is in Site Trunking mode.

The default is On.

Full Spectrum CC Scan Use the UP/DOWN arrows to make your selection. If this field is set to On, the radio will perform a Full Spectrum Control Channel (CC) scan when the radio goes out of range of all its programmed control channel information.

The default is Off.

Full Spectrum CC Scan Timer (sec) *This field will be visible only if Full Spectrum CC Scan is set to On.* Use the UP/DOWN arrows to make your selection or enter a value directly. This is the amount of time that is available to the radio to perform a full spectrum CC scan before returning to the normal CC scan. The valid range of values is 5 to 31 seconds.

The default is 10 seconds.

RSSI (Received Signal Strength Indication) OSW Counter Use the UP/DOWN arrows to make your selection or enter a value directly. This is the number of OSWs (in 23-ms intervals) for which the radio must remain inactive on the control channel before a set of RSSI samples is taken. Domain: {n: 60 <= n <= 255}.

Note: RSSI or Received Signal Strength Indication refers to the strength of the current signal. *Although the MCS 2000 is a companion to the MTS 2000 portable, the RSSI threshold constants and site switching characteristics are not the same.*

RSSI Acceptable Threshold Use the UP/DOWN arrows to make your selection or enter a value directly. In the RSSI sampling scheme, RSSI values are separated into four levels -- poor, acceptable, good and excellent -- as shown (i.e.: all values below the acceptable constant fall into the POOR level, values between the acceptable and good constants fall into the ACCEPTABLE level, etc.). The value in this field specifies the POOR/ACCEPTABLE boundary. Domain {L: 00 <= L <= FF}.



RSSI Good Threshold Use the UP/DOWN arrows to make your selection or enter a value directly. In the RSSI sampling scheme, RSSI values are separated into four levels: poor, acceptable, good and excellent. This value specifies the acceptable/good boundary. Domain {L: 00 <= L <= FF}.

RSSI Excellent Threshold Use the UP/DOWN arrows to make your selection or enter a value directly. In the RSSI sampling scheme, RSSI values are separated into four levels: poor, acceptable, good and excellent. This value specifies the good/excellent boundary. Domain {L: 00 <= L <= FF}.

VC RSSI Accpt Threshold (Voice Channel RSSI Acceptable Threshold) While in a voice call, RSSI samples will be compared against the Voice Channel RSSI Acceptable Threshold. If samples fall below this threshold, the radio will initiate an attempt at site switching, causing an interruption in the voice call. Valid RSSI values range from 1 to FF. Selecting Disabled will set the threshold to 0, disabling voice channel RSSI site switching.

The factory default is Disabled.

Special Note On RSSI Threshold Constant Settings The default values for the RSSI (received signal strength indication) threshold constants programmed in your radio may not be optimal for your system. These values are critical for proper site switching. Please review the following information to set the RSSI threshold constants for your SmartZone system configuration and desired site switching performance.

RSSI ranking levels are as follows:

Acceptable Threshold

The acceptable Threshold sets the minimum audio quality level. A signal with an RSSI value lower than the acceptable threshold will switch to any site with a better audio quality rating.

Increase this level to always require a better signal. Decrease this threshold level to prevent switching back and forth between two weak sites. POOR designates unacceptable or unintelligible audio quality. ACCEPTABLE designates intelligible, but undesirable, audio quality. If the signal is above the acceptable threshold level, the radio will site switch if an excellent site is found. Otherwise, the radio will remain at the current site because allowing changes to sites with similar signal levels can cause the radio to switch back and forth, causing undesirable delays in speech.

Good Threshold

Sets the maximum signal level/audio quality that will site switch. Radios receiving stronger signals will not site switch. GOOD designates audio quality that is good enough that no site switching is necessary. This level of audio quality is also used as a buffer to prevent switching back and forth between two sites with similar signal level.

Excellent

Sets the desired Audio quality. The radio receiving an ACCEPTABLE signal will only switch to a site with excellent audio quality. EXCELLENT designates excellent audio quality or the desired audio

quality. All levels except GOOD will try to switch to a site of this audio quality.



Note: If preferred sites are programmed in your radio, the radio will always search for and switch to a preferred site with an ACCEPTABLE or higher RSSI. *Preferred sites override the site switching characteristics described in the table above*

For most systems with fairly good coverage overlap, the default values are the optimal threshold constants. These values should differ under the following conditions:

1. You are programming preferred sites that the radio should use until the signal is very weak. In this case, the acceptable constant should be lowered.
2. You desire radios to operate only on strong, clear signals. The constants should be higher, keeping the same difference between the thresholds.
3. If you desire a large signal quality difference, or are experiencing too many site switches, raise the Excellent Threshold and reduce the Acceptable Threshold.

Note: If you change the constants from those recommended, you should conduct a field test to verify and adjust the site switching performance of your test radios BEFORE programming and installing your radios.

Filter Constants K1, K2, and K3

Use the UP/DOWN arrows to make your selection or enter a value directly. The threshold constants K1, K2, and K3 are designed to reduce filter damage as time between sampling increases.

The RSSI filter has the following characteristic:

$$\text{Filter Val.} = (\text{Filter Val.} * K + \text{Current Reading} * (10 - K)) / 10$$

where the domain of K is {K: K = K1, K2, K3} and 0 (no filter) <= K3 <= K2 <= K1 <= 9 (heavily damped filter).

K1	Used when less than 8 seconds elapse between RSSI samples.
K2	Used when between 8 and 16 seconds elapse between RSSI samples.
K3	Used when more than 16 seconds elapse between RSSI samples.

Filter Threshold Constants T1, T2, and T3

Use the UP/DOWN arrows to make your selection or enter a value directly. The threshold constants T1, T2, and T3 create a window that RSSI samples must fall into in order to be considered valid. The window is centered around the current RSSI Filter Value. The window size is twice the value of the threshold constant.

The values (T1, T2, T3) are expressed as hexadecimal numbers ranging from 0 (zero) to FF and should only be modified in accordance with the following:

$$00 \leq T1 \leq T2 \leq T3 \leq FF$$

T1	Used when less than 8 seconds elapse between RSSI samples.
T2	Used when between 8 and 16 seconds elapse between RSSI samples.
T3	Used when more than 16 seconds elapse between RSSI samples.

Note: Modification of filter threshold constants should be performed only under the direction of a qualified radio engineer.

Voice-On-Control (VOC) Options



From the MAIN MENU, press **F4** twice, **F2** and then **F3** to access this screen.

MOTOROLA Radio Service Software MCS Model: ...TRUNKING:WIDE OPTIONS:VOC OPTIONS	Use UP/DOWN Arrows to Select Choice.								
<p>VOC OPTIONS -----</p> <p>VOC Capable.....Disabled RSSI Acceptable Threshold.....61 VOC Site Lock Time (sec).....60 VOC Pended Emer Time (ms).....500 VOC Activation Time (ms).....500</p>									
F1 HELP	F2	F3	F4	F5	F6	F7	F8	F9	F10 EXIT

This screen defines the necessary data fields for operation on a Voice-on-Control capable site. When a site enters VOC Mode, its control channel is surrendered for a voice call. All radios that are not VOC capable will go out of range at that time.

Press **Tab** to select the desired field, or press the desired function key (**F1 - F10**). If a field is highlighted, use the UP/DOWN arrow keys to select the desired choice or value.

Field Definitions

VOC Capable
(Voice-On-Control Capable)

Use the UP/DOWN arrow keys to enable/disable this feature. When a radio is VOC-capable, it is able to handle the transition of a site going into and out of VOC mode without entering an out-of-range state.

The default is Disabled.

RSSI Acceptable Threshold

Enter the desired value in hexadecimals or use the UP/DOWN arrow keys to scroll through the available choices. This field defines the minimum signal strength (RSSI value) for a radio to determine that it is in range of a valid Voice On Control channel. If a site enters Voice On Control, the radio will remain locked on to that site.

One of the possible conditions that would cause the radio to roam to another site (or possibly enter an out-of-range state) is when the radio determines there is about five seconds of low signal strength (that is, RSSI below this threshold) on the last active control channel. Valid entries range from 0 (zero) to \$FF.

The default is \$61.

VOC Site Lock Time (sec)	<p>Enter the desired value directly or use the UP/DOWN arrow keys to scroll through the available choices. This field defines the maximum time that a radio will remain locked onto a Voice-on-Control Site before it will attempt to lock on to another site (and possibly enter an out-of-range state). Valid entries range from 15 to 255 seconds in one-second increments.</p> <p>The default is 15 seconds.</p>
VOC Pended Emer Time (ms)	<p>Use the UP/DOWN arrow keys to select a value for this timer or enter a value directly. This is the maximum length of time that the radio will delay before a certain subset of ISWs will be sent while the radio is in VOC mode. Valid entries range from 500 to 6000 ms in 25-ms increments.</p> <p>Note: Most ISWs are not permitted to be sent in while the radio is in VOC mode (the exceptions being Emergency and Phone Reject requests).</p> <p>The default is 500 ms.</p>
VOC Activation Time (ms)	<p>Use the UP/DOWN arrow keys to select a value for this timer or enter a value directly. This field determines the maximum length of time that the radio will delay before sending in ISW requests upon receiving a system status OSW indicating the site is exiting VOC Mode. The valid range is 500 ms to 6000 ms in 25-ms increments.</p> <p>The default is 20.</p>

Trunking Systems



From the MAIN MENU, press **F4** twice and then **F3** to access these screen.

MOTOROLA Radio Service Software MCS Model: M01UGN6PW6AN		Enter or Scroll to Select Value.							
MAIN:CHANGE/VIEW:TRUNKING:SYSTEM									
System.....1 TRUNKING SYSTEM -----									
System Key	Disabled	UNIVERSAL ID.....	1						
System Type.....	I	Size Code.....	A						
System ID.....	0001	Fleet ID.....	001						
Connect Tone (Hz)#.....	0-105.88	Individual ID.....	000						
Coverage Type.....	Disabled	Access Type.....	Slow						
Site ID.....	0	Conversation Type.....	Message						
		Tx Defeat.....	Disabled						
Dynamic Regrouping.....	Disabled	This Call ID.....	000016						
Remote Monitor	Disabled								
F1	F2	F3	F4	F5	F6	F7	F8	F9	F10
HELP	ADD	PREV	NEXT	DELETE	CONTROL			MORE	EXIT
	SYSTEM	SYSTEM	SYSTEM	SYSTEM	CHANNEL			OPTIONS	

TRUNKING SYSTEM screen, Type I (800 MHz)

MOTOROLA Radio Service Software MCS Model: M01WGM4PW6AN		Use UP/DOWN Arrows to Select Choice.							
MAIN:CHANGE/VIEW:TRUNKING:SYSTEM									
System.....1 TRUNKING SYSTEM -----									
System Key.....	Disabled	OmniLink.....	Enabled						
System Type.....	II/III								
System ID.....	0001								
Alias.....	Disabled								
Individual ID.....	1-0001								
Connect Tone (Hz)#.....	0-105.88								
Coverage Type.....	SmartZone								
Affiliation Type.....	Automatic								
Dynamic Regrouping.....	Enabled								
Zone....	Blank	Chan....	Blank						
Remote Monitor.....	Enabled								
RM Base Time (sec).....	15								
F1	F2	F3	F4	F5	F6	F7	F8	F9	F10
HELP	ADD	PREV	NEXT	DELETE	CONTROL			MORE	EXIT
	SYSTEM	SYSTEM	SYSTEM	SYSTEM	CHANNEL			OPTIONS	

TRUNKING SYSTEM screen, Type II/III (900 MHz)

This screen is used to program the Trunking System configuration for your radio. *The fields on this screen will vary for Type I and Type II/III systems as shown in the screens above.* Press **Tab** to select the desired field, or press the desired function key (**F1 - F10**). If a field is highlighted, use the UP/DOWN arrow keys to select the desired choice or value.

A Trunking System refers to a specific repeater site, the system ID, the individual radio ID for that system, the control channel frequencies and the connect tone required to operate on that system. Each system that the radio is programmed to operate on is linked to one or more Trunking personalities. The personality defines the features available to the radio while operating on that system. Each radio is uniquely identified on each system by its individual ID.

Function Key Descriptions

F2 - ADD SYSTEM	Adds a Trunking system. <i>You cannot add a system unless a system key or a hardware key present.</i>
F3 - PREV SYSTEM	Accesses the previous system.
F4 - NEXT SYSTEM	Accesses the next system.
F5 - DELETE SYSTEM	Deletes the current system. You will be prompted before the system is actually deleted.
F6 - CHAN ASSIGN (for UHF/VHF) or CONTROL CHAN (for 800/900 MHz)	Brings up a screen where you can change and view the control channels for the system.
F9 - MORE OPTIONS	Brings up a screen where you can configure other options for Trunking system operation.

Field Definitions

System	Use the UP/DOWN arrow keys to scroll through the available systems. Alternatively, you can use the F3/F4 function keys to navigate through the available systems.
System Key	<i>An FTR or System Key is required to access this field.</i> It holds the system key status for the current Trunking system.
System Type	Use the UP/DOWN arrow keys to select the Trunking system type. <i>If the Trunking system is Type I</i> , the range of the ID changes for different size codes and the ID is a three-digit hexadecimal number. <i>If the Trunking System is Type II or III</i> , the individual ID is a four-digit hexadecimal number.

Type I	The original MOTOROLA Trunked signalling protocol.
Type II	An enhanced version of the original protocol that provides additional fleet management flexibility for a given system via an expanded signalling format.
Type III	A hybrid of Type I and II that permits a radio to operate as a Type II unit on a Type I system.

Each radio has a single individual ID per system, independent of the number of talkgroups, user groups, or personalities it is affiliated to on that system. *The fields on this screen will vary for Type I and Type II/III systems.*

Note: If you have more than one fleet on a system, you may want to use a Universal ID so that people calling the radio can use a single ID.

System ID	<i>A system key or FTR key is required to access this field.</i> This field contains the four-digit hexadecimal number which identifies the Trunked system.
-----------	---

Alias Use the UP/DOWN arrow keys to enable/disable the System Alias feature. If Alias is enabled, the upper eight bits of the System ID are ignored.

The default is Disabled.

Individual ID *This field will be accessible only for Type I radios.* Enter the three-digit ID for this system. Examples are 001, 02A, 1FF and 200. An actual ID must be entered, not a personality number.

The default is 1-0001.

Connect Tone (Hz) # *This field is not applicable to SmartZone systems.* Use the UP/DOWN arrow keys to make your selection or enter the desired value directly. The Connect Tone is a sub-audible tone required on the voice channel to access the Trunked repeater. The function is similar to the Conventional Repeater Access Tone.

0 - 105.88 Hz	4 - 97.3 Hz.
1 - 76.60 Hz	5 - 116.13 Hz
2 - 83.72 Hz	6 - 128.57 Hz
3 - 90.00 Hz	7 - 138.46 Hz

Coverage Type *A system key or FTR key is required to access this field.* The choices for this field are:

WAC AMSS	Wide Area Coverage Automatic Multiple Site Select.
Local AMSS	Local Automatic Multiple Site Select.
SmartZone	Motorola system for wide area roaming.
Disabled	Disable wide area coverage.

Up to four control channels are used for standard trunking operation and up to eight are used for WAC AMSS, regardless of the number listed on the Control Channel Screen (**F4/F4/F3/F6**).

In an AMSS system, multiple sites are linked together to form a larger Trunked system. Radios programmed for Wide Area AMSS can use the site that they are within range of, and when they move between sites, they can switch sites without interruption of communications that are in progress. *Up to eight control channels can be used for Wide Area Systems.*

If WAC AMSS is selected and WAC AMSS Failsoft is selected on the TRUNKING PERSONALITY screen (**F4/F4/F4**), the **F6** key on the TRUNKING PERSONALITY screen will be used to view and modify failsoft channel information. *Radios programmed for Local AMSS are allowed to use only one site.* This site is entered as the Site ID below the Coverage Type field.

The default is Disabled.

Site ID *This field will be visible only if the Coverage Type field is set to Local AMSS.* Enter the Site ID directly or use the UP/DOWN arrow keys to make your selection.

Affiliation Type (*Type II/III Only*)

Use the UP/DOWN arrow keys to select the desired Affiliation Type.

Automatic	The radio will immediately affiliate with the central controller as soon as it is turned on and will automatically re-affiliate each time the talkgroup is changed (that is, if the selected talkgroup does not match last affiliated talkgroup).
On PTT	The radio will affiliate only when PTT is pressed.

SmartZone radios MUST use Automatic Affiliation. These radios always affiliate on power-up and on site switches (in addition to affiliating on Talkgroup changes).

The default is On PTT.

Dynamic Regrouping

Use the UP/DOWN arrow keys to enable/disable this feature for the current system. A Dynamic Regrouping Talkgroup position (DYN) must be assigned on the ZONE/CHANNEL ASSIGNMENT screen (F4/F8). Enabling Dynamic Regrouping will automatically add DYN to the list of talkgroups on that screen. Dynamic Regrouping allows the dispatcher to temporarily reassign selected radios operating in separate fleets and/or talkgroups into a single group. The default is Disabled.

Note: *Only one DYN position may be assigned for each system.*

Zone

This field will be visible only if Dynamic Regrouping is enabled. Use the UP/DOWN arrow keys to make your selection or enter a number directly. This is the zone position used when a radio is dynamically regrouped. This is used in conjunction with the channel position to determine which zone/channel talkgroup will be used during Dynamic Regrouping.

Chan

This field will be visible only if Dynamic Regrouping is enabled. Use the UP/DOWN arrow keys to make your selection or enter a number directly. This is the channel position used when a radio is dynamically regrouped. This is used in conjunction with the zone position to determine which zone/channel talkgroup will be used during Dynamic Regrouping.

Remote Monitor

Use the UP/DOWN arrow keys to enable/disable Radio Trace (remote monitor) for this system.

The default is Disabled.

RM Base Time

This field will be visible only if Remote Monitor is enabled. Use the UP/DOWN arrow keys to select the base time in seconds or enter a value directly. The radio will transmit during a Radio Trace for this system. Valid options are 15, 30, 45 and 60 seconds.

The default is 15 seconds.

OmniLink

This field will be visible only if the Coverage Type is SmartZone. When an OmniLink feature is enabled, the radio will be allowed to roam from one SmartZone System within an OmniLink System to another SmartZone System within the same OmniLink System.

The factory default is Disabled.

Universal ID (*Type I Only*)

Enter the desired ID directly. When Trunking Type I is selected, a Universal ID is used. All individual calls (Phone, Private Call, and Call Alert) will be received if they are addressed to the Universal ID, even though the operator might have selected another personality in that system. This simplifies individual communications with the radio. In addition, the radio will initiate all Private and Phone Calls with the Universal ID. Therefore, only one ID must be enabled for each radio at the Central Site Controller. The radio will also respond to Dynamic Regrouping commands to the Universal ID, making it easier for a regrouping console to regroup a radio.

The default is 1.

Size Code

A system key or FTR key is required to access this field. Use the UP/DOWN arrow keys to choose the Size Code for this fleet. The Size Code determines the maximum number of fleets, subfleets and individual IDs allowed. Valid size codes are: A, B, C, D, E, F, G, H, I, J, K, M, O and Q.

Note: *The size code and fleet ID chosen must match the programming of the Central Controller.*

Size Code	Prefix	Fleet	Subfleet	Individual ID
A	0 - 7	00 - 7F	A - C	000 - 00F
B	0 - 7	00 - 0F	A - G	000 - 03F
C	0 - 7	00 - 07	A - G	000 - 07F
D	0 - 7	00 - 00	A - O	000 - 1FF
E	0 - 7	00 - 3F	A - C	000 - 01F
F	0 - 7	00 - 1F	A - G	000 - 01F
G	0 - 7	00 - 1F	A - C	000 - 03F
H	0 - 7	00 - 0F	A - C	000 - 07F
I	0 - 7	00 - 07	A - C	000 - 0FF
J	0 - 7	00 - 03	A - G	000 - 0FF
K	0 - 7	00 - 01	A - O	000 - 0FF
M	0 - 3	00 - 00	A - O	000 - 3FF
O	0 - 1	00 - 00	A - O	000 - 7FF
Q	0 - 0	00 - 00	A - O	000 - FFF

Fleet ID

A system key or FTR key is required to access this field. The Fleet ID is a three-digit hexadecimal number where the first digit is the prefix and the second two digits refer to the fleet. For any size code, the subfleets for Fleetwide and Dynamic Regrouping are always available.

The valid range for the Fleet I depends on the size code chosen. Examples of Fleet IDs are 300, 402, 001, and 703.

Individual ID

A system key or FTR key is required to access this field. Enter the Trunking Individual ID in hexadecimal. The Individual ID is a number that uniquely identifies an individual radio on a system (or personality for Type I). Type I systems have a unique ID for each personality.

For Type II/III radios, valid IDs range between 1 and FFFF. The decimal equivalent of the Individual ID is used for the radio's Private Conversation Call ID (7+ID#), interconnect land-to-portable unit calls (7+ID#) and interconnect land-to-portable talkgroup calls (7+ID#). Type II systems have a single Individual ID per radio, independent of the number of talkgroups, user groups or personalities that radio has on that system.

Access Type

Use the UP/DOWN arrow keys to select the Trunking Access type:

Slow	The original Trunking signalling protocol with acknowledgments (high speed) for all channel grants. (Rx = Slow, Tx = Slow)
Fast	An enhancement to the original protocol that eliminates the channel grant acknowledgments, thus improving the channel access time. (Rx = Fast, Tx = Fast)

Note: *This information must be coordinated with your system manager to ensure proper operation of the system.*

Conversation Type

Use the UP/DOWN arrow keys to select the Trunking Conversation type. The options are:

Message	After the initiator de-keys the radio, the voice channel stays active (hangtime) so that other members of the talkgroup can respond on the same channel. If a radio in the talkgroup transmits during another user's transmission, he or she will interrupt the ongoing transmission.
Transmission	No hangtime and no talk-over. When a radio is de-keyed, the channel is immediately de-allocated and reassigned. If the user tries to talk over an active channel, the radio will not respond until the channel is clear.

Tx Defeat

Use the UP/DOWN arrow keys to enable/disable this feature. When this feature is enabled, the radio will use the PFI instead of the Universal ID to initiate individual calls.

The default is Disabled.

This Call ID

A system key or FTR key is needed to access this field. This is the Type I call ID which is calculated from the Size Code, Fleet ID and Individual ID.

Channel Assignment Data (UHF/VHF models only)



From the MAIN MENU, press **F4** twice, **F3** and then **F6** to access this screen.

MOTOROLA Radio Service Software MCS Model:					Enter or Scroll to Select System.				
...TRUNKING:SYSTEM:CHAN ASSIGN									
System..... 1									
CHANNEL ASSIGNMENT DATA									

Rx Channel Ranges - MHz					Tx Channel Ranges - MHz				

#	Status	Spacing (kHz)	Start	End	Status	Spacing (kHz)	Start	End	

1	Enable	6.25	136.00000	136.00000	Enable	6.25	136.00000	136.00000	
2	Blank				Blank				
3	Blank				Blank				

F1	F2	F3	F4	F5	F6	F7	F8	F9	F10
HELP		PREV SYS	NEXT SYS		CONTROL CHANNEL				EXIT

This screen is used to enter the Channel Assignment Data used for Other Band Trunking or OBT. Three different frequency splits may be defined for each system. After the receive and transmit ranges are defined, press **F6** to enter Control Channel frequencies.

Note: This information must match the Central Controller exactly or the system will not work.

Press **Tab** to select the desired field, or press the desired function key (**F1 - F10**). If a field is highlighted, use the UP/DOWN arrow keys to select the desired choice or value.

Function Key Descriptions

F3 - PREV SYSTEM

Accesses the previous system.

F4 - NEXT SYSTEM

Accesses the next system.

F6 - CHAN ASSIGN (for UHF/VHF) or CONTROL CHANNEL MENU (for 800/900 MHz)

A system key or FTR key is required to access this field. Brings up a screen where you can enter the control channels for, or assign channels to, the system.

Field Definitions

System Use the UP/DOWN arrow keys to scroll through the available systems. Alternately the **F3/F4** function keys can be used to navigate through the available systems.

Status Use the UP/DOWN arrow keys to enable this frequency split. Three different frequency splits may be defined for each system.

Spacing (kHz) Use the UP/DOWN arrow keys to select the Channel Spacing for this frequency range. This field allows the user to select from a range of channel spacing values (expressed in kHz). The valid range of values is 5.00 to 50.00 kHz.

End Frequency minus Start Frequency must be evenly divisible by the channel spacing so the range can be divided into an integer value to assign the control channel number properly.

Start (Channel Range) *A system key or FTR key is required to access this field.* Enter the frequency range Start point directly in MHz. *Do NOT use the UP/DOWN arrow keys.*

Note: *This information must match the Central Controller exactly or the system will not work.*

The start frequency and end frequency must both be within the allowed frequency range of the radio. End Frequency minus Start Frequency must be evenly divisible by the channel spacing so the range can be divided into an integer value to assign the control channel number properly. The number of channels per range is calculated with the following formula:

$$\# = (\text{End Frequency} - \text{Start Frequency}) / \text{Channel Spacing} + 1$$

Note: A maximum of 380 receive channels can be assigned.

End (Channel Range) *A system key or FTR key is required to access this field.* Enter the frequency range End point directly in MHz. *Do not use the UP/DOWN arrow keys.* The End frequency must be larger than the Start Frequency and they must both be within the allowed frequency range of the radio.

Note: *This information must match the Central Controller exactly or the system will not work.*

Control Channels



From the MAIN MENU, press **F4** twice, **F3** and then **F6** twice to access this screen.

MOTOROLA Radio Service Software MCS Model: 1 ...SYSTEM:CHAN ASSIGN:CONTROL CHANNEL		Enter or Scroll to Select System.							
System..... 1									
		CONTROL CHANNELS							
Number		Frequency							
-----		-----							
1		136.00000							
F1	F2	F3	F4	F5	F6	F7	F8	F9	F10
HELP	ADD	PREV	NEXT	DELETE					EXIT
	CHAN	SYS	SYS	CHAN					

This screen allows you to specify the control channel frequencies for the current system. Press **Tab** to select the desired field, or press the desired function key (**F1 - F10**). If a field is highlighted, use the UP/DOWN arrow keys to select the desired choice or value.

Note: *It is beneficial to sort the control channel frequencies in ascending order in a SmartZone system. The advantage to doing this in a Failsoft situation (if Failsoft by Talkgroup is NOT used) is that the radio goes to its control channel list and uses the first channel as its Failsoft channel. If channels are sorted (or at least sorted in an order designed to facilitate Failsoft operations), potential problems such as having multiple radios on different Failsoft channels can be avoided.*

In the case of Failsoft by Talkgroup, if a radio goes to its Talkgroup Failsoft frequency and that particular repeater is down (perhaps the very condition which caused the Failsoft situation to occur), it will then go to the control channel list as before for Failsoft frequencies. Thus, it is beneficial to sort the control channels under Failsoft by Talkgroup usage as well.

Function Key Descriptions

F2 - ADD CHAN

Adds a channel.

F3 - PREV SYSTEM

Accesses the previous system.

F4 - NEXT SYSTEM

Accesses the next system.

F5 - DELETE CHAN

Deletes the current system. You will be prompted before the system is actually deleted.

Field Definitions

System	Use the UP/DOWN arrow keys or the F3/F4 keys to scroll through the available systems.
Tx Frequency	Enter the Control Channel Transmit frequency directly in MHz. Four Control Channel Frequencies are standard (<i>eight if Wide Area AMSS is enabled and one for Local AMSS</i>). <i>Control channels must be entered in ascending (increasing) order.</i>
Rx Frequency	Enter the Control Channel Receive frequency directly in MHz. Four Control Channel Frequencies are standard (<i>eight if Wide Area AMSS is enabled and one for Local AMSS</i>). <i>Control channels must be entered in ascending (increasing) order.</i>

Trunking System Options



From the MAIN MENU, press **F4** twice, **F3** and then **F9** to access this screen.

MOTOROLA Radio Service Software MCS Model: M01UGN6PW6AN		Enter or Scroll to Select System.							
..CHANGE/VIEW:TRUNKING:SYSTEM:OPTIONS									
System..... 1		TRUNKING SYSTEM OPTIONS							

Tx Power Select.....High	Trunk Repeater Offset.....45 MHz	Phone DTMF Timing.....1	Initial Delay (msec).....1000						
Channel Assgn. Type.....Domestic	Splinter Channel.....Disabled	Digit Duration (msec).....125	Inter Digit Delay (msec).....75						
Channel Bandwidth.....25.0 kHz		Hot DTMF Timing.....1	Initial Delay (msec).....1000						
		Digit Duration (msec).....125	Inter Digit Delay (msec).....75						
		Status Aliasing.....Enabled	Message Aliasing.....Enabled						
		Site Aliasing.....Enabled							
F1	F2	F3	F4	F5	F6	F7	F8	F9	F10
HELP		PREV	NEXT	ONE	STATUS	MSG	SITE		EXIT
		SYS	SYS	TOUCH	ALIAS	ALIAS	ALIAS		

Trunking System Options for System 1, Type I (800 MHz)

MOTOROLA Radio Service Software MCS Model: M01WGN4PW6AN		Enter or Scroll to Select System.							
..CHANGE/VIEW:TRUNKING:SYSTEM:OPTIONS									
System..... 1		TRUNKING SYSTEM OPTIONS							

Tx Power Select.....High	Trunk Repeater Offset.....39 MHz	Phone DTMF Timing.....1	Initial Delay (msec).....1000						
HearClear.....Enabled		Digit Duration (msec).....125	Inter Digit Delay (msec).....75						
Channel Bandwidth.....25.0 kHz		Hot DTMF Timing.....1	Initial Delay (msec).....1000						
		Digit Duration (msec).....125	Inter Digit Delay (msec).....75						
		Status Aliasing.....Enabled	Message Aliasing.....Enabled						
		Site Aliasing.....Enabled							
F1	F2	F3	F4	F5	F6	F7	F8	F9	F10
HELP		PREV	NEXT	ONE	STATUS	MSG			EXIT
		SYS	SYS	TOUCH	ALIAS	ALIAS			

Trunking System Options for System 1, Type II/III (900 MHz)

The TRUNKING SYSTEM OPTIONS screen lets you access additional features and options to further customize the radio configuration to a customer's communication needs.



Caution

Caution should be observed when changing parameters on this screen. System parameter changes can substantially degrade performance if they are not made system wide.

MOTOROLA Radio Service Software MCS Model: M01RFL9PW4AN		Enter or Scroll to Select System.
..CHANGE/VIEW:TRUNKING:SYSTEM:OPTIONS		
System..... 1 TRUNKING SYSTEM OPTIONS -----		
Tx Power Select.....High		Phone DTMF Timing.....1 Initial Delay (msec).....1000 Digit Duration (msec).....125 Inter Digit Delay (msec).....75 Hot DTMF Timing.....1 Initial Delay (msec).....1000 Digit Duration (msec).....125 Inter Digit Delay (msec).....75
Channel Bandwidth.....12.5		Status Aliasing.....Enabled Message Aliasing.....Enabled Site Aliasing.....Enabled
F1 HELP	F2	F3 PREV SYS
F4 NEXT SYS	F5 ONE TOUCH	F6 STATUS ALIAS
F7 MSG ALIAS	F8 SITE ALIAS	F9
F10 EXIT		

Trunking System Options for System 1, Type II/III (UHF/VHF)

Press **Tab** to select the desired field, or press the desired function key (**F1 - F10**). If a field is highlighted, use the UP/DOWN arrow keys to select the desired choice or value.

Function Key Descriptions

- F3 - PREV SYS Accesses the previous system.
- F4 - NEXT SYS Accesses the next system.
- F5 - ONE TOUCH *This function will be visible only when a radio ordered with the One-Touch feature has been read. Brings up a screen where you can assign functions to one-touch features.*
- F6 - STATUS ALIAS *This function will be visible only when a radio containing the SMARTNET or SmartZone software option has been read and the Status Aliasing field is set to enabled. Brings up a screen where you can change and view the parameters associated with Trunking system Status Alias.*
- F7 - MSG ALIAS
(Message Alias) *This function will be active only when a radio containing the SMARTNET or SmartZone software option has been read and the Message Aliasing field is set to enabled. Brings up a screen where you can assign a number and name alias to a particular message.*
- F8 - SITE ALIAS *This function will be active only when the Site Aliasing field is set to enabled. Brings up a screen where you can change and view the parameters associated with Trunking System Site Alias.*

Field Definitions

System Use the UP/DOWN arrow keys to select the desired Trunking system You may also enter the system number directly or select it using the **F3/F4** function keys.

Note: Refer to the Radio Catalog Sheets for the maximum number of systems allowed for this model.

Tx Power Select

Use the UP/DOWN arrow keys to select either High or Low transmit power operation for the radio on this system.

The transmit power may be reduced using this field.

The factory default for this feature is High.

Trunk Repeater Offset

Use the UP/DOWN arrow keys to select a value or enter the desired value directly. The value must be set to the frequency separation between the Tx and Rx frequencies used at the central repeater site.

The default is 45 MHz for 800 band and 39 MHz for 900 band models.

HearClear (900 MHz only)

This option allows HearClear during voice operation. HearClear is a feature used primarily in the 900 MHz band to reduce noise caused by the smaller bandwidth used in the 900 band.

The default is Enabled for 900 MHz models and Disabled for other models.

Channel Assgn. Type

Use the UP/DOWN arrow keys to select Domestic or International.

Domestic	25 kHz channel spacing used in the USA
International	12.5 kHz channel spacing used outside the USA

Splinter Channel
(800 MHz Only)

Use the UP/DOWN arrow keys to enable/disable this feature. The control channels will be shifted down 12.5 kHz and the radio will interpret the channel numbers received over the air as splinter channels as well. *Channels in the 821 band will not be affected.*

The default is Disabled.

Rx Modulation (not shown)

This field applies only to SECURE radios. The value in this field should be based on the expected receive data format for the personality. This field allows the user to configure the radio's personality for:

- Strictly binary (two-level) receive operation;
- Strictly multi-level (four-level) receive operation; or
- Both binary and multi-level receive operation (Auto Receive).

When operating in Auto Receive mode, the radio will automatically detect the received signal type and process the data accordingly. *Two-level sensitivity is reduced when operating in the Auto Receive mode and thus should not be used on channels or systems that are strictly binary (two-level).*

Channel Bandwidth

Use the UP/DOWN arrow keys to select the Channel Bandwidth. This value must be set to the Channel Bandwidth of the system the radio is to operate on. *Strapping fields for Announcement Group, Fleet ID, Talkgroup, etc. will be forced to "Clear" if 12.5 kHz is selected.*

The default is 25.0 kHz.

Phone DTMF Timing	<p>Use the UP/DOWN arrow keys to select the set of DTMF timing parameters for the current personality. Timing may be changed for Initial Delay, Digit Duration and Interdigit Delay. The radio contains a table with four sets of values of these parameters. <i>The actual parameters are entered on the RADIO WIDE PHONE CONFIGURATION screen (F4/F3/F4).</i></p> <p>The default is 1.</p>
Initial Delay (ms)	<p><i>This is a view-only field.</i> The value here can be adjusted by modifying the value in the Phone DTMF Timing or Hot DTMF Timing fields as the case may be.</p>
Digit Duration (ms)	<p><i>This is a view-only field.</i> The value here can be adjusted by modifying the value in the Phone DTMF Timing or Hot DTMF Timing fields as the case may be.</p>
Interdigit Delay (ms)	<p><i>This is a view-only field.</i> The value here can be adjusted by modifying the value in the Phone DTMF Timing or Hot DTMF Timing fields as the case may be.</p>
Hot DTMF Timing	<p>Use the UP/DOWN arrow keys to select the set of DTMF timing parameters for this personality. Timing may be changed for Initial Delay, Digit Duration and Interdigit Delay. The radio contains a table with four sets of values of these parameters. <i>The actual parameters are entered on the RADIO WIDE PHONE CONFIGURATION screen (F4/F3/F4).</i></p> <p>The default is 1.</p>
Status Aliasing	<p>Use the UP/DOWN arrow keys to enable/disable Status Aliasing. This option allows you to customize the Status number and assign an alias name to each message (F6). <i>The Status Alias feature must be enabled on the TRUNKING PERSONALITY screen (F4/F4/F4), and the status mnemonic (STS) must be assigned on the RADIO WIDE MENU CONFIGURATION screen (F4/F3/F3/F4).</i></p>
Message Aliasing	<p>Use the UP/DOWN arrow keys to enable/disable Message Aliasing for this system. This option allows you to customize the Message number and assign an alias name to each message (F7). <i>The message feature must be enabled on the TRUNKING PERSONALITY screen (F4/F4/F4), and the message mnemonic (MSG) must be assigned on the RADIO WIDE MENU CONFIGURATION screen (F4/F3/F3/F4).</i></p>
Site Aliasing	<p>Use the UP/DOWN arrow keys to enable/disable Site Aliasing. This option will permit you to customize the site number to assign an alias name to each site. <i>AMSS or SmartZone must be added on the TRUNKING SYSTEM screen (F4/F4/F3) and the SITE mnemonic must be assigned on the RADIO WIDE MENU CONFIGURATION screen (F4/F3/F3/F4) for this feature to operate properly.</i></p>
Zone Switch Debounce Timer (sec)	<p>This field will be displayed only if the OmiLink field is Enabled on the Trunking System screen (F4/F4/F3). This field defines the duration that the radio will be forced to remain at a SmartZone System within an OmniLink System before being allowed to switch to any other SmartZone system within the OmniLink System. Keeping subscribers from bouncing between Zones guarantees that the fixed end databases</p>

will keep up with the location of the roaming subscriber units. The factory default is 5 seconds.

Trunking One-Touch Button Options

From the MAIN MENU, press **F4** twice, **F3**, **F9** and then **F5** to access this screen.



MOTOROLA Radio Service Software MCS Model: ...TRUNKING:SYSTEM:OPTIONS:ONE TOUCH	Use UP/DOWN Arrows to Select Choice.								
<p>ONE TOUCH BUTTON OPTIONS</p> <p>-----</p> <p>Button 1 Feature.....Disabled Index.....1</p> <p>Button 2 Feature.....Disabled Index.....1</p> <p>Button 3 Feature.....Disabled Index.....1</p> <p>Button 4 Feature.....Disabled Index.....1</p>									
F1 HELP	F2	F3	F4	F5	F6	F7	F8	F9	F10 EXIT

This screen can be accessed from the TRUNKING SYSTEM OPTIONS screen (F4/F4/F3/F9) only when a radio ordered with the One-Touch feature (or a corresponding codeplug) has been read. The One-Touch Feature is activated by pressing a control head or handset button programmed for one-touch operation. These buttons are programmed on the RADIO WIDE BUTTON CONFIGURATION screen (F4/F3/F3/F2). When a button programmed for one-touch operation is pressed, the Phone, Private Call, Call Alert, Status, or Message corresponding to the One-Touch Index will be initiated. This facilitates quick access to frequently used functions.

For example, if One-Touch Button 1 feature is selected as Phone, One-Touch Index 1 is set to 2, and a control head or handset button is programmed as One Touch 1, then pressing the control head or handset button will cause the radio to transmit the second telephone number from the phone list.

Press **Tab** to select the desired field, or press the desired function key (**F1 - F10**). If a field is highlighted, use the UP/DOWN arrow keys to select the desired choice or value.

Field Definitions

Button (number)

Use the UP/DOWN arrow keys to select the feature that corresponds to this one-touch button. One-touch buttons 1 through 4 may be programmed as Trunking buttons on either the control head or the handset buttons on the RADIO WIDE BUTTON CONFIGURATION screen (**F4/F3/F3/F2**).

A control head or mic/handset button programmed for one-touch button allows Trunking features such as Status, Message, Private Call, Call Alert and Phone to operate with the touch of a single button.

Call Alert, Message, And Status	Pressing the button will cause the radio to automatically enter the selected feature and transmit the list member corresponding to the one-touch button index.
Phone	Pressing the button will cause the radio to send a phone request and transmit a pre-programmed phone list number. The index field indicates which phone list number to transmit.
Private Call	<p>Pressing the button will cause the radio to enter the Private Call feature at the Call ID in the Call List corresponding to the one-touch button index.</p> <ul style="list-style-type: none"> <input type="checkbox"/> If the Private Call Type is PC I, PC II or PC I/II, PTT must be pressed to initiate the Private Call. <input type="checkbox"/> If the Private Call Type is Enhanced PC, pressing PTT is not required to initiate the Private Call.

Pressing a one-touch button while the radio is already in the feature corresponding to the one-touch button will cause the radio to abort the feature.

Note: The availability of Phone, Private Call, Call Alert, Message, and Status on any one-touch button is determined by the radio wide model options purchased for your radio.

The default value for all one-touch buttons is Disabled.

Index

Enter the value for the index into the list pertaining to the feature (Phone, Private Call, Call Alert, Status, or Message) assigned to the one-touch button.

*The list size depends on both the radio model and the feature assigned to the one-touch button. Press **F1** while in this field and press **PgDn** to view the table showing the different list sizes for each radio model and feature.*

Trunking Status Alias

From the MAIN MENU, press **F4** twice, **F3**, **F9** and then **F6** to access this screen.



MOTOROLA Radio Service Software MCS Model: ...SYSTEM:OPTIONS:STATUS ALIAS	Enter or Scroll to Select Value.																		
<p>TRUNKING STATUS ALIAS</p> <p>-----</p> <table> <thead> <tr> <th style="text-align: center;">Num</th> <th style="text-align: center;">Status Alias Number</th> <th style="text-align: center;">Status Alias Text</th> </tr> <tr> <th colspan="3">-----</th> </tr> </thead> <tbody> <tr> <td style="text-align: center;">1</td> <td style="text-align: center;">1</td> <td style="text-align: center;">STATUS 1</td> </tr> <tr> <td style="text-align: center;">2</td> <td style="text-align: center;">2</td> <td style="text-align: center;">STATUS 2</td> </tr> <tr> <td style="text-align: center;">3</td> <td style="text-align: center;">3</td> <td style="text-align: center;">STATUS 3</td> </tr> <tr> <td style="text-align: center;">4</td> <td style="text-align: center;">4</td> <td style="text-align: center;">STATUS 4</td> </tr> </tbody> </table>		Num	Status Alias Number	Status Alias Text	-----			1	1	STATUS 1	2	2	STATUS 2	3	3	STATUS 3	4	4	STATUS 4
Num	Status Alias Number	Status Alias Text																	

1	1	STATUS 1																	
2	2	STATUS 2																	
3	3	STATUS 3																	
4	4	STATUS 4																	
F1 HELP	F2 ADD ITEM	F3	F4	F5 DELETE ITEM	F6	F7	F8	F9	F10 EXIT										

This screen can be accessed only if a radio containing the SMARTNET or SmartZone software option (or a corresponding codeplug) has been read and the Status Alias field on the TRUNKING SYSTEM OPTIONS screen (F4/F4/F3/F9) is set to Enabled. This screen pertains to the Trunking Status Alias List.

Press **Tab** to select the desired field, or press the desired function key (**F1 - F10**). If a field is highlighted, use the UP/DOWN arrow keys to select the desired choice or value.

Function Key Descriptions

F2 - ADD ITEM

Adds a Trunking Status Alias item.

F5 - DELETE ITEM

Deletes the current Trunking Status Alias item. You will be prompted before the item is actually deleted.

Field Definitions

Status Alias Number

Use the UP/DOWN arrows to make your selection. This field indicates the position number for the Status Alias Text field. The valid range of values is 1 to 8 for Trunking.

Status Alias Text

Enter the ASCII text that must be displayed when the corresponding status number is selected.

Trunking Message Alias

From the MAIN MENU, press **F4** twice, **F3**, **F9** and then **F7** to access this screen.



MOTOROLA Radio Service Software MCS Model:		Enter or Scroll to Select Value.							
...SYSTEM:OPTIONS:MESSAGE ALIAS									
TRUNKING MESSAGE ALIAS -----									
Num	Message Alias	Number	Message Alias Text						

1		1	MESSAGE 1						
2		2	MESSAGE 2						
3		3	MESSAGE 3						
4		4	MESSAGE 4						
5		5	MESSAGE 5						
6		6	MESSAGE 6						
7		7	MESSAGE 7						
8		8	MESSAGE 8						

F1	F2	F3	F4	F5	F6	F7	F8	F9	F10
HELP	ADD			DELETE					EXIT
	ITEM			ITEM					

*This screen can be accessed only if a radio containing the SMARTNET or SmartZone software option (or a corresponding codeplug) has been read and the Message Alias field on the TRUNKING SYSTEM OPTIONS screen (**F4/F4/F3/F9**) is set to Enabled. This screen pertains to the Trunking Message Alias List.*

Press **Tab** to select the desired field, or press the desired function key (**F1 - F10**). If a field is highlighted, use the UP/DOWN arrow keys to select the desired choice or value.

Function Key Descriptions

F2 - ADD ITEM

Adds a Trunking Message Alias item.

F5 - DELETE ITEM

Deletes a Trunking Message Alias item. You will be prompted before the item is actually deleted.

Field Definitions

Message Alias Number

Use the UP/DOWN arrows to make your selection. This field indicates the position number for the Message Alias Text Field. The valid range of values is 1 to 16.

Message Alias Text

Enter the ASCII text that must be displayed when the corresponding message number is selected.

Trunking Site Alias



From the MAIN MENU, press **F4** twice, **F3**, **F9** and then **F8** to access this screen.

MOTOROLA Radio Service Software MCS Model: ...SYSTEM:OPTIONS:SITE ALIAS	Enter or Scroll to Select Value.																														
<p>TRUNKING SITE ALIAS</p> <p>-----</p> <table> <thead> <tr> <th style="text-align: center;">Num</th> <th style="text-align: center;">Site Alias Number</th> <th style="text-align: center;">Site Alias Text</th> </tr> <tr> <th colspan="3" style="text-align: center;">-----</th> </tr> </thead> <tbody> <tr><td style="text-align: center;">1</td><td style="text-align: center;">1</td><td style="text-align: center;">SITE 1</td></tr> <tr><td style="text-align: center;">2</td><td style="text-align: center;">2</td><td style="text-align: center;">SITE 2</td></tr> <tr><td style="text-align: center;">3</td><td style="text-align: center;">3</td><td style="text-align: center;">SITE 3</td></tr> <tr><td style="text-align: center;">4</td><td style="text-align: center;">4</td><td style="text-align: center;">SITE 4</td></tr> <tr><td style="text-align: center;">5</td><td style="text-align: center;">5</td><td style="text-align: center;">SITE 5</td></tr> <tr><td style="text-align: center;">6</td><td style="text-align: center;">6</td><td style="text-align: center;">SITE 6</td></tr> <tr><td style="text-align: center;">7</td><td style="text-align: center;">7</td><td style="text-align: center;">SITE 7</td></tr> <tr><td style="text-align: center;">8</td><td style="text-align: center;">8</td><td style="text-align: center;">SITE 8</td></tr> </tbody> </table>		Num	Site Alias Number	Site Alias Text	-----			1	1	SITE 1	2	2	SITE 2	3	3	SITE 3	4	4	SITE 4	5	5	SITE 5	6	6	SITE 6	7	7	SITE 7	8	8	SITE 8
Num	Site Alias Number	Site Alias Text																													

1	1	SITE 1																													
2	2	SITE 2																													
3	3	SITE 3																													
4	4	SITE 4																													
5	5	SITE 5																													
6	6	SITE 6																													
7	7	SITE 7																													
8	8	SITE 8																													
F1 HELP	F2 ADD ITEM	F3	F4	F5 DELETE ITEM	F6	F7	F8	F9	F10 EXIT																						

*This screen can be accessed only if the Site Alias field on the TRUNKING SYSTEM OPTIONS screen (**F4/F4/F3/F9**) is set to Enabled. This screen pertains to the Trunking Site Alias List.*

Press **Tab** to select the desired field, or press the desired function key (**F1 - F10**). If a field is highlighted, use the UP/DOWN arrow keys to select the desired choice or value.

Function Key Descriptions

F2 - ADD ITEM

Adds a Trunking Site Alias item.

F5 - DELETE ITEM

Deletes a Trunking Site Alias item. You will be prompted before the item is actually deleted.

Field Definitions

Site Alias Number

This field indicates the position number for the Site Alias Text Field. The valid range of values is 1 to 64.

Site Alias Text

Enter the ASCII text that must be displayed when the corresponding site number is selected.

Trunking Personality



From the MAIN MENU, press **F4** three times to access this screen.

MOTOROLA Radio Service Software MCS Model: M01UGN6PW6AN		Enter or Scroll to Select Value.							
MAIN:CHANGE/VIEW:TRUNKING:PERS									
Personality.....1		TRUNKING PERSONALITY							

Protocol Type.....II	Private Call Type.....PC II								
System/ID.....1-0001	Operation.....Resp Only								
Type.....II/Iii	Call Alert Operation...Unlimited								
Size Code.....None	Phone Interconnect....Answer Only								
Fleet ID.....	Hot Keypad (DTMF).....Disabled								
Individual ID.....1-0001	Status.....Disabled								
Failsoft Type.....Talkgrp	Message.....Disabled								
Time Out Timer.....3- 60	Call ID List.....1								
	This Call ID (PCI).....								
	This Call ID (PCII).....								
	Scan List.....None								
F1	F2	F3	F4	F5	F6	F7	F8	F9	F10
HELP	ADD	PREV	NEXT	DELETE		TALK	EMER	MORE	EXIT
	PERS	PERS	PERS	PERS		GROUPS	OPTIONS	OPTIONS	

Trunking System for Type I (800 MHz)

MOTOROLA Radio Service Software MCS Model: M01WGM4PW6AN		Enter or Scroll to Select Value.							
MAIN:CHANGE/VIEW:TRUNKING:PERS									
Personality.....1		TRUNKING PERSONALITY							

Protocol Type.....II	Private Call Type....Enhanced PC								
System/ID.....1-0001	Operation.....Resp Only								
Type.....II/Iii	Call Alert Operation...Unlimited								
Announcement Group.....None	Phone Interconnect....Unlimited								
Individual ID.....1-0001	Hot Keypad (DTMF).....Disabled								
Failsoft Type.....Talkgrp	Status.....Enabled								
A/G Failsoft.....Enabled	Message.....Enabled								
A/G Failsoft Frequency..935.0125	Call ID List.....1								
Time Out Timer.....3- 60	Scan List.....None								
F1	F2	F3	F4	F5	F6	F7	F8	F9	F10
HELP	ADD	PREV	NEXT	DELETE		SUB	EMER	MORE	EXIT
	PERS	PERS	PERS	PERS		FLEETS	OPTIONS	OPTIONS	

Trunking System for Type II/Iii (900 MHz)

These screens are used to view and edit the main information for a Trunking personality, such as the system number and time-out timer to be used and other options. It also provides access to the other Trunking screens such as those which relate to talkgroups/subfleets.

Press **Tab** to select the desired field, or press the desired function key (**F1 - F10**). If a field is highlighted, use the UP/DOWN arrow keys to select the desired choice or value.

MOTOROLA Radio Service Software MCS Model: M01RFL9PW5AN					Enter or Scroll to Select Value.				
MAIN:CHANGE/VIEW:TRUNKING:PERS									
Personality.....1					TRUNKING PERSONALITY				
Protocol Type.....II					Private Call Type....Enhanced PC				
System/ID.....1-0001					Operation.....Resp Only				
Type.....II/Iii					Call Alert Operation...Unlimited				
Announcement Group.....None					Phone Interconnect.....Unlimited				
Individual ID.....1-0001					Hot Keypad (DTMF).....Disabled				
Failsoft Type.....Disabled					Status.....Disabled				
					Message.....Disabled				
					Call ID List.....1				
Time Out Timer.....3- 60					Scan List.....None				
F1	F2	F3	F4	F5	F6	F7	F8	F9	F10
HELP	ADD	PREV	NEXT	DELETE		TALK	EMER	MORE	EXIT
	PERS	PERS	PERS	PERS		GROUPS	OPTIONS	OPTIONS	

Trunking System for Type II/Iii (UHF)

Function Key Descriptions

- F2 - ADD PERS** Adds a personality. *This operation is NOT allowed without a system key or a hardware key present.* You will automatically be moved to the new personality.
- F3 - PREV PERS** Accesses the previous personality.
- F4 - NEXT PERS** Accesses the next personality.
- F5 - DELETE PERS** Deletes the current personality. You will be prompted before the personality is actually deleted.
- F6 - WAC AMSS (not shown)** *This function will be visible only if the Failsoft Type field is set to WAC/AMSS.* The Failsoft frequency used depends on which AMSS site the radio is using at the time. The frequencies are entered on the screen accessed by pressing this key.
- F7 - SUBFLEETS or TALKGROUPS** Brings up a screen where you can edit the position of the subfleets/talkgroups and associated data such as SECURE strapping and scan type.
- F8 - EMER OPTIONS (Emergency Options)** *This function will be active only when a radio containing the SMARTNET or SmartZone software option has been read.* Brings up a screen where you can edit and enable emergency information such as default talkgroup and edit emergency options such as Console Acknowledge Required.
- F9 - MORE OPTIONS** Brings up a screen where you can change or view more Trunking personality parameters including Conversation Type and Access Type.

Field Definitions

Personality

Use the UP/DOWN arrow keys or use the **F3/F4** keys to scroll through the available personalities and make your selection. Personalities can be added by pressing **F2** or deleted by pressing **F5**. You will be prompted before the personality is actually deleted.

Protocol Type

Use the UP/DOWN arrows to select the Protocol Type. This refers to the type of Trunking system. The available options are:

Type I	The original MOTOROLA Trunked signalling protocol.
Type II	An enhanced version of the original protocol that provides additional fleet management flexibility for a given system via an expanded signalling format.
Type Iii	A hybrid of Type I and II that permits a radio to operate as a Type II unit on a Type I system.

System/ID

Use the UP/DOWN arrow keys to select the Trunking system the current personality is to use. (The system ID is shown according to system number). *The Trunking system should be set up on the TRUNKING SYSTEM screen (F4/F4/F3) before personality information is entered since some of these fields depend on Trunking system information.*

Type

Use the UP/DOWN arrows to make your selection. The selection in this field indicates the Trunked signalling protocol used on this system.

If the Trunking System is Type I, the range of the ID changes for different size codes. The ID is a three-digit hexadecimal number. If you have more than one fleet on a system, you may want to use a Universal ID so that people calling the radio can use a single ID. Press **F8** to go to the UNIVERSAL ID screen where you can enter the information required to use a universal ID.

If the Trunking System is Type II or Iii, the individual ID is a four-digit hexadecimal number. For Type II Trunking, your radio will have a single Individual ID for each system, independent of the number of talkgroups, user groups or personalities it is affiliated with on that system.

Size Code

A system key or FTR key is required to access this field. Use the UP/DOWN arrow keys to choose the Size Code for this fleet. The Size Code determines the maximum number of fleets, subfleets and individual IDs allowed. Valid size codes are: A, B, C, D, E, F, G, H, I, J, K, M, O and Q.

Note: *The size code and fleet ID chosen must match the programming of the Central Controller.*

Size Code	Prefix	Fleet	Subfleet	Individual ID
A	0 - 7	00 - 7F	A - C	000 - 00F
B	0 - 7	00 - 0F	A - G	000 - 03F
C	0 - 7	00 - 07	A - G	000 - 07F
D	0 - 7	00 - 00	A - O	000 - 1FF
E	0 - 7	00 - 3F	A - C	000 - 01F
F	0 - 7	00 - 1F	A - G	000 - 01F
G	0 - 7	00 - 1F	A - C	000 - 03F
H	0 - 7	00 - 0F	A - C	000 - 07F
I	0 - 7	00 - 07	A - C	000 - 0FF
J	0 - 7	00 - 03	A - G	000 - 0FF
K	0 - 7	00 - 01	A - O	000 - 0FF
M	0 - 3	00 - 00	A - O	000 - 3FF
O	0 - 1	00 - 00	A - O	000 - 7FF
Q	0 - 0	00 - 00	A - O	000 - FFF

Fleet ID

A system key or FTR key is required to access this field. The Fleet ID is a three-digit hexadecimal number where the first digit is the prefix and the second two digits refer to the fleet. For any size code, the subfleets for Fleetwide and Dynamic Regrouping are always available.

The valid range for the Fleet I depends on the size code chosen. Examples of Fleet IDs are 300, 402, 001, and 703.

Announcement Group

Enter a three-digit hexadecimal number for the Announcement Talkgroup directly. This field contains the user talkgroup for announcements for the current personality.

Strapping (*not shown*)

Use the UP/DOWN arrows to make your selection: Clear, SECURE, or Select. This field is used to configure the transmit mode of Announcement Group or Fleet ID.

Clear or SECURE	The Announcement Group or Fleet ID is forced to that particular transmit mode.
Select	The user is allowed to select the SECURE transmit modes using the radio's two-position concentric switch.

Individual ID

Contains the Individual ID number that uniquely identifies your radio on a particular system. Valid IDs range between 1 and FFFF. The decimal equivalent of the Individual ID is used for your radio's Private Conversation Call ID (7 + ID#), interconnect land-to-portable unit calls (7 + ID #) and interconnect land-to-portable talkgroup calls (7 + ID #).

For Type II Trunking, your radio will have a single Individual ID for each system independent of the number of talkgroups, user groups or personalities it is affiliated with on that system.

Failsoft Type

When the Central Site Controller fails in a Trunked system, the system goes into Failsoft operation. Depending on the type of system, there will be different choices for Failsoft operation:

Disabled	No failsoft used.
Personality/Fleet	Uses the Announcement Group Failsoft frequency for all talkgroups within the personality.
Talkgroup/ Subfleet	The frequency is determined by the talkgroup selected and is entered in the TRUNKING TALKGROUP/ SUBFLEET screen (F4/F4/F4/F7). <i>Failsoft by Talkgroup is NOT available with WAC AMSS type.</i>
WAC AMSS	The Failsoft frequency depends on which AMSS site the radio is using at the time. The frequencies are entered using the F6 function key.

A/G Failsoft

Use the UP/DOWN arrow keys to enable/disable Failsoft for this talkgroup. When the Central Site Controller fails in a Trunked system, the system goes into Failsoft operation. If the radio is set to Failsoft by Talkgroup, the radio will use these frequencies to transmit and receive on.

A/G Failsoft Frequency

This field will be visible only if the A/G Failsoft field is set to Enabled. Enter the Failsoft Frequency directly in MHz. A transmit and receive frequency each are required if the system is UHF or VHF.

Talk Permit Tone (*not shown*)

Use the UP/DOWN arrow keys to enable/disable this option. Set this field to Enabled if you want the Talk Permit tone to sound every time the PTT key is pressed. The talk permit tone is a series of three quick tones that sound once the PTT button has been pressed and your radio has keyed up on the voice channel assigned by the Trunked central controller. You may begin talking immediately.

The default is Disabled.

Time-Out Timer

Use the UP/DOWN arrow keys to select the desired Time-Out Timer (TOT) value for this personality. The TOT determines the amount of time the radio can continuously transmit before it must be de-keyed. When the time is about up the radio beeps and then stops transmitting. Each personality may choose one of four different TOT values. The four values for the radio can be changed on the RADIO WIDE OPTIONS MENU (**F4/F3/F2/F9**).

The default is 60 seconds.

Private Call Type

Use the UP/DOWN arrow keys to select the desired Private Call type from among the following:

PC I	Limited to selected fleet and pool. (800 MHz, Type I personalities only).
PC II	Permits calls between fleets and sends an initiator ID so that the person receiving the call will know who sent it (800 MHz, Type I, II and Ili personalities).
PC I/II	Permits both PC I and PC II calls (Type I personalities only).
Enhanced PC	Telephone-like operation (Type II and Ili personalities only).
Disabled	Deactivates the Private Call feature for this personality.

Note: Radio controls may require additional setup for your Private Call configuration. Refer to the RADIO WIDE BUTTON/SWITCH CONFIGURATION MENU (F4/F3/F3) help screen for details.

Operation

This field will be visible only if the Private Call Type field is set to a value other than Disabled. Use the UP/DOWN arrow keys to select the operation of the Private Call feature for this personality from among the following:

Response Only	Allows the radio to only accept calls.
List Only	Allows the user to make calls from the page list.
Unlimited	Requires full keypad. Allows the user to make calls from the call list and from the keypad, and to modify the call ID list.
Disabled	No Private Call operation is allowed. Select Disabled to disable paging facilities.

The default is Disabled.

Call Alert Operation

Use the UP/DOWN arrow keys to select Call Alert (Page) operation for the current personality. Call Alert allows the operator to receive and transmit pages either by typing in a six-digit decimal ID (Unlimited) or by selecting one of the IDs in the Trunking Call ID list (List Select).

Response Only	Allows the radio to accept pages only.
List Only	Allows the user to send pages from the page list.
Unlimited	Allows the user to send pages from the page list and from the keypad. This also allows the radio user to modify the page ID list. (Requires full keypad.)
Disabled	No Call Alert operation is allowed. Disables paging facilities.

Note: Radio controls may require additional setup for your Call Alert configuration. Refer to the RADIO WIDE BUTTON/SWITCH CONFIGURATION MENU (F4/F3/F3) help screen for details.

The default is Disabled.

Phone Interconnect

Use the UP/DOWN arrow keys to select the type of Phone Interconnect for this personality. This option allows the radio to initiate and receive land-to-portable telephone calls and specifies the type of Interconnect. The choices are:

Answer Only	Allows the radio to accept calls only.
List Only	Allows the radio to make calls only from the phone list.
Unlimited	Allows the radio to make calls both from the phone list and the keypad. The stored phone number list may also be modified from the keypad.
Disabled	No phone operation is allowed.

Note: *Radio controls may require additional setup for your Phone Interconnect configuration.* Refer to the RADIO WIDE BUTTON/SWITCH CONFIGURATION MENU (F4/F3/F3) help screen for details.

The default is Disabled.

Hot Keypad (DTMF)

Use the UP/DOWN arrow keys to enable/disable Hot Keypad (DTMF while transmitting) operation for the current personality. When this feature is enabled, the keypad is live during all dispatch operation. Pressing any digit between 0 (zero) and 9, “*”, or “#” will cause that digit to be transmitted.

The default is Disabled.

Status

Use the UP/DOWN arrow keys to enable/disable the transmission of pre-determined Status messages. This feature lets the user send a status message to the dispatcher to inform the dispatcher of the current state of the radio and its owner (“ENROUTE” or “LUNCH” for instance.)

Note: *Radio controls may require additional setup for your Status configuration.* Refer to the RADIO WIDE BUTTON/SWITCH CONFIGURATION MENU (F4/F3/F3). In addition, Status number and name aliasing can be configured on the TRUNKING SYSTEM OPTIONS screen (F4/F4/F3/F9).

The default is Disabled.

Message

Use the UP/DOWN arrow keys to enable/disable the transmission of pre-determined canned messages. This feature lets the radio user send messages to the dispatcher. Message transmissions indicate a temporary condition and/or a response to a query from the dispatcher (“PLS CALL” or “10-4” for instance).

Note: *Radio controls may require additional setup for your Message configuration.* Refer to the RADIO WIDE BUTTON/SWITCH CONFIGURATION MENU (F4/F3/F3). In addition, Status number and name aliasing can be configured on the TRUNKING SYSTEM OPTIONS screen (F4/F4/F3/F9).

The default is Disabled.

Call ID List

This field will not be visible if the Operation field is set to Resp Only. Use the UP/DOWN arrow keys to select the Call List ID for the current personality. This is the number of the Call ID list that this personality will use for Private Call. The Private Call and Call Alert features must have a call list assigned for Unlimited and List operation. The Call ID List cannot be set to None when Call Operation is List or Unlimited.

Note: *Radio controls may require additional setup for your Private Call configuration on the RADIO WIDE BUTTON/SWITCH MENU (F4/F3/F3). Refer also to the TRUNKING WIDE CALL LIST (F4/F4/F6) help screen.*

The default is one list for each Trunking system.

This Call ID (PC I)

This is the six-digit Private Call I ID of this radio.

This Call ID (PC II)

This is the six-digit Private Call II ID of this radio.

Scan List

Use the UP/DOWN arrow keys to select the Scan List to be used for this personality. To change or view the scan list, select the SCAN MENU (F4/F3/F5). Trunking personalities may use Subfleet, Priority Monitor and Talkgroup type scan lists.

Note: *Radio controls may require additional setup for your Scan configuration on the RADIO WIDE BUTTON/SWITCH MENU (F4/F3/F3). Refer to the RADIO WIDE MENU screen (F4/F3/F5).*

The default is None.

WAC AMSS Failsoft



From the MAIN MENU, press **F4** thrice and then **F6** to access this screen.

MOTOROLA Radio Service Software MCS Model:		Enter or Scroll to Select Value.	
..CHANGE/VIEW:TRUNKING:PERS:WAC FLSFT			
Personality.....1			
WAC AMSS FAILSOFT -----			
Number	Status	Frequency	Number Control Channel
-----	-----	-----	-----
1	Enabled	851.01250	1 851.0125
2	Disabled		
3	Disabled		
4	Disabled		
5	Disabled		
6	Disabled		
7	Disabled		
8	Disabled		
F1 HELP	F2	F3	F4
	F5	F6	F7
	F8	F9	F10 EXIT

This screen can be accessed only if a System Key is present and the Failsoft Type field on the TRUNKING PERSONALITY screen (F4/F4/F4) is set to WAC AMSS. It is used to enter Failsoft frequencies used by Wide Area AMSS systems. A transmit and a receive frequency are required for the Other Band Trunking (OBT) protocol. If the Status field on this screen is enabled and the repeater system fails, the radio will go into Failsoft mode. This means the radio will act like a Conventional talkaround radio, transmitting and receiving on the same frequency.

- In non-wide area AMSS systems, the radio can select the talkaround frequency by talkgroup because the groups are assumed to be within range of each other.
- In wide-area AMSS, Failsoft frequencies must be chosen according to the location of the radio, which is determined according to the repeater that the radio is using. A frequency is assigned to each repeater for Failsoft operation.

Press **Tab** to select the desired field, or press the desired function key (**F1 - F10**). If a field is highlighted, use the UP/DOWN arrow keys to select the desired choice or value.

Field Definitions

Personality

Use the UP/DOWN arrow keys to scroll through the available personalities.

Status

Use the UP/DOWN arrow keys to enable/disable Failsoft for the current personality. If this field is enabled and the repeater system fails, the radio will go into Failsoft mode. This means the radio will act like a conventional talkaround radio, transmitting and receiving on the same frequency.

The default is Disabled.

Frequency Enter the WAC AMSS frequency for Failsoft operation directly in MHz. If the radio is set to Failsoft by Talkgroup, it will use these frequencies to transmit and receive on. *Failsoft by Talkgroup is NOT compatible with WAC AMSS.*

Control Channel Enter the Control Channel frequency directly in MHz. *Up to eight frequencies may be specified with WAC AMSS enabled.*

Trunking Subfleets



From the MAIN MENU, press **F4** thrice and then **F7** to access this screen.

MOTOROLA Radio Service Software MCS Model:		
...CHANGE/VIEW:TRUNKING:PERS:TLK GRP		
Personality.....1		
TRUNKING TALKGROUPS -----		
#	Tlk Grp	Rx Freq Tx Freq Strapping
-----	-----	-----
1	001	
F1 HELP	F2 ADD TLK GP	F3 F4 F5 DELETE TLK GP
F6	F7	F8 F9 F10 EXIT

This screen is used to create a list of talkgroups/subfleets. *If the radio is a SECURE-equipped radio, strapping fields will be visible and SECURE strapping can be set up for each personality.* The personality usually has 16 positions (the number of positions on the rotary switch), indicated by the numbers 1 through 16. The Announcement Talkgroup is usually in the sixteenth position. Once the Talkgroups/Subfleets are entered, they are assigned to the Zone/System or Channel/Subfleet selector at the ZONE/CHANNEL ASSIGNMENT screen (**F4/F8**).

Press **Tab** to select the desired field, or press the desired function key (**F1 - F10**). If a field is highlighted, use the UP/DOWN arrow keys to select the desired choice or value.

Function Key Descriptions

F2 - ADD TLK GP/SUB FLT

Adds a talkgroup/subfleet. *This operation is not allowed unless a system key or hardware key is present.*

F5 - DELETE TLK GP/SUB FLT

Deletes a talkgroup/subfleet. You will be prompted before the talkgroup/subfleet is actually deleted.

Field Definitions

Personality	Displays the number of the current personality.
Talkgroup/Subfleet	This screen is used to enter subfleets that will use each personality. Once the talkgroups/subfleets are entered, they are assigned to a Zone/System and a Channel/Subfleet selector position on the ZONE/SUMMARY screen (F4/F8).
Rx Frequency	Enter the Receive frequency directly in MHz. Four Control Channel Frequencies are standard (<i>eight if Wide Area AMSS is enabled and one for Local AMSS</i>).
Tx Frequency	Enter the Transmit frequency directly in MHz. Four Control Channel Frequencies are standard (<i>eight if Wide Area AMSS is enabled and one for Local AMSS</i>).
Failsoft (<i>not shown</i>)	Use the UP/DOWN arrow keys to enable/disable Failsoft for this talkgroup. When the Central Site Controller fails in a Trunked system, the system goes into Failsoft operation. If the radio is set to Failsoft by Talkgroup, the radio will use these frequencies to transmit and receive on.
F/S Frequency (<i>not shown</i>)	Enter the Failsoft Frequency directly in MHz. <i>A transmit and receive frequency each are required if the system is UHF or VHF.</i>
Strapping	<i>This field will be visible only if the radio (or associated codeplug) is SECURE-equipped. This field configures the transmit mode of the talkgroup or subfleet. If set to Clear or SECURE, the talkgroup or subfleet is forced to that particular transmit mode. When set to Select, the user is allowed to choose between SECURE and Clear transmit modes using a button programmed to SECURE on the radio.</i>

Trunking Emergency Data Configuration



From the MAIN MENU, press **F4** thrice and then **F8** to access this screen.

MOTOROLA Radio Service Software MCS Model:	Use UP/DOWN arrows to Select Type.
MAIN:CHANGE/VIEW:TRUNKING:PERS:EMER	
EMERGENCY DATA CONFIGURATION -----	
Protocol Type.....Iii	Revert Size Code.....A
Access Type.....Fast	Revert Fleet ID.....0001
Emergency Call.....Disabled	
Emergency Alarm.....Enabled	
Console Ack Required...Disabled	
Retry Counter..... 1	Revert Subfleet.....001
Tactical.....Enabled	
Revert PTT ID.....Disabled	Strapping.....Select
F1 HELP	F2 F3 F4 F5 F6 F7 F8 F9 F10 EXIT

This screen is used to configure the Emergency feature for the current personality. Each Type II/III personality may have a unique configuration if necessary. *The Emergency button must be enabled in the RADIO WIDE BUTTON/SWITCH MENU (F4/F3/F3). In addition, Silent Emergency must be configured on the RADIO WIDE CONFIGURATION screen (F4/F3/F2/F7).*

Note: *The radio controls may require additional setup for your Status Configuration. Values in the status number and name aliasing fields can be modified on the TRUNKING SYSTEM OPTIONS screen (F4/F4/F3/F9).*

Press **Tab** to select the desired field, or press the desired function key (**F1 - F10**). If a field is highlighted, use the UP/DOWN arrow keys to select the desired choice or value.

Field Definitions

Protocol Type

Use the UP/DOWN arrow keys to select the Trunking Protocol Type for the current personality.

Type I	The original Motorola Trunked signalling protocol.
Type II	An enhanced version of the original Trunked Signalling protocol that provides additional fleet management flexibility for a given system via an expanded signalling format.
Type III	A hybrid of Type I and II that permits a radio to operate a Type II unit on a Type I system.

Access Type

This field will be visible only if the Protocol Type field is set to Ili. Use the UP/DOWN arrow keys to select the Trunking Access Type. This determines how the radio will access a Type II/Ili system.

- Select Tx Fast/Rx Fast for use with fast access systems and Tx Fast/Rx Slow for slow access protocol emergency subfleets.
- New Type I radios operating on fast access systems should be set for fast access.
- Type Ili radios which have to communicate on systems with slow radios should be set to slow access.

Note: *This information must be coordinated with your system manager to ensure proper operation.*

Emergency Call

Use the UP/DOWN arrow keys to enable/disable this option. Emergency Call gives the operator priority to access the channel during an emergency situation.

The Emergency Call condition is entered by pressing a button configured to initiate emergency. All subsequent PTT transmissions while in the Call state will be made with high priority access to a voice channel. Emergency Alarm and Emergency Call may both be enabled, in which case the Call state is entered when PTT is pressed.

This feature is one of the necessary components for Hot Mic Emergency to function properly. For Hot Mic Emergency to function properly, all the following conditions must be met:

1. The radio must be Hot Mic Emergency capable.
2. Emergency Call must be enabled.
3. Emergency Alarm must be enabled.
4. Revert PTT-ID must be enabled.
5. Console Ack Req. must be disabled.

The default is Disabled.

Emergency Alarm

Use the UP/DOWN arrow keys to enable/disable this option. Emergency Alarm allows the operator to press the Emergency button to send an alarm to the dispatcher. Emergency Alarm is a coded transmission made on the control channel in response to pressing a button configured to initiate an emergency. These alarm transmissions will be sent until:

- the control channel acknowledges the alarm;
- the console dispatcher acknowledges the alarm (if console ack is enabled); or
- the alarm retry counter is exhausted.

If normal alarm operation is selected, the display will flash emergency and valid key chirp will be heard when the alarm condition is entered. Four full beeps will be heard when the alarm condition is acknowledged.

If silent alarm is selected, there will be no display or audible indication when the alarm condition is entered. Nor will there be any indication of alarm acknowledgment. In addition, the radio will mute the receiver audio so that no radio traffic is heard. *This feature is one of the necessary components for Hot Mic Emergency to function properly.*



WARNING

Programming of Silent Emergency provides the user NO indication, visible or audible, that the emergency has been sent. If you program silent emergency in conjunction with the Long Press Emergency feature users should be trained to LONG PRESS the emergency press button for an extended duration to ensure that the emergency will be sent.

The default is Disabled.

Console Acknowledgment
Required

This field will be visible only if the Emergency Alarm field is set to Enabled. Use the UP/DOWN arrow keys to enable/disable this option. If a Console Acknowledge is required, an Emergency Alarm is not considered successful unless a Dispatcher Acknowledge is received. When an Emergency Alarm is not successful, the full four-beep Acknowledge Tone is not sounded and the alarm is automatically sent again until the number of retries specified is exhausted. *This feature must be disabled for Hot Mic Emergency to function properly.*

The default is Disabled.

Retry Counter

Use the UP/DOWN arrow keys to select the number of Emergency transmissions to retry should the initial transmission fail. If an unlimited number of retries is desired, select 0 (that is, Infinite). Otherwise, enter a value between 1 and 255.

Normally if the radio is unsuccessful in sending a transmission, it will retry for one ISW sequence before quitting. For Emergency Alarms, however, the radio will retry for the number of ISW sequences specified by the Retry Counter.

The default is 1.

Tactical

Use the UP/DOWN arrow keys to enable (Tactical) or disable (Non-Tactical) this emergency option. Emergency Alarms and Calls are made on the selected talkgroup unless:

- Announcement is selected; or
- Dynamic Regrouping talkgroup is selected and there is no valid dynamic ID.

In both cases the default Talkgroup is used. If this field is set to Disabled, the radio uses the default Talkgroup and default Announcement group for emergency transmissions.

The default is Disabled.

Revert PTT-ID

Use the UP/DOWN arrow keys to enable the default Emergency PTT-ID option. If this feature is enabled, the default Talkgroup/Subfleet or Announcement Group/Fleet-wide transmissions will be in PTT-ID

style. This feature is one of the necessary components for Hot Mic Emergency to function properly.

The default is Disabled.

Emergency Hot Mic (*not shown*)

This field will be visible only if all of the five conditions listed below are met. If this feature is enabled, Emergency Hot Mic operation (also known as Trunking Emergency with voice to follow) will be activated. When an Emergency Alarm is generated and emergency alarm acknowledge is received, the radio will automatically drop into emergency call mode and begin transmitting with the microphone muted for the time specified by the Tx Period.

For Hot Mic Emergency to function properly, all the following conditions must be met:

1. The radio must be Hot Mic Emergency capable.
2. Emergency Call must be enabled.
3. Emergency Alarm must be enabled.
4. Revert PTT-ID must be enabled.
5. Console Ack Req. must be disabled.

Note: *This feature is mutually exclusive of normal emergency operation.* That is, if this feature is enabled, emergency operation will always operate in this manner.

The default is Disabled.

Tx Period (sec)
(*not shown*)

This field will be visible only if the Emergency Hot Mic field is set to Enabled. The Tx Period determines the time period for which the radio will transmit with the mic unmuted, without user intervention. The valid range is 10 to 120 seconds in 10-second increments.

The default is 10 seconds.

Revert Size Code

Use the UP/DOWN arrow keys to choose the Size Code for this personality. Valid Size Codes are: A, B, C, D, E, F, G, H, I, J, K, M, O and Q. The Size Code determines the maximum number of fleets, subfleets and individual IDs allowed.

Note: *The Size Code and Fleet ID chosen must match the programming of the Central Controller.*

Revert Fleet ID/Subfleet

The Fleet ID is a three-digit hexadecimal number where the first digit is the Prefix and second two digits are the Fleet. For any size code, the subfleets for Fleetwide and Dynamic Regrouping are always available.

Size Code	Prefix	Fleet	Subfleet	Individual ID
A	0 - 7	00 - 7F	A - C	000 - 00F
B	0 - 7	00 - 0F	A - G	000 - 03F
C	0 - 7	00 - 07	A - G	000 - 07F
D	0 - 7	00 - 00	A - O	000 - 1FF
E	0 - 7	00 - 3F	A - C	000 - 01F
F	0 - 7	00 - 1F	A - G	000 - 01F
G	0 - 7	00 - 1F	A - C	000 - 03F
H	0 - 7	00 - 0F	A - C	000 - 07F
I	0 - 7	00 - 07	A - C	000 - 0FF
J	0 - 7	00 - 03	A - G	000 - 0FF
K	0 - 7	00 - 01	A - O	000 - 0FF
M	0 - 2 - 4 - 6	00 - 00	A - O	000 - 3FF
O	0 - 4	00 - 00	A - O	000 - 7FF
Q	0 - 0	00 - 00	A - O	000 - FFF

Revert Announcement Group
(or Revert Fleet ID)

Enter the Emergency Default Announcement Talkgroup in this field. This field contains the Emergency User Talkgroup for Announcements during an emergency for the current personality. The Emergency Default Announcement Talkgroup is a three-digit hexadecimal number. While in the emergency call state with tactical emergency disabled, your radio will monitor this talkgroup for fleetwide announcement calls.

Revert Announcement Group
(or Revert Fleet ID) Strapping

Use the UP/DOWN arrow keys to make your selection. This field configures the transmit mode of Emergency Announcement Group or Emergency Fleet ID. If set to Clear or SECURE, the Emergency Announcement Group or Fleet ID is forced to that particular transmit mode. When set to Select, the user is allowed to select the SECURE or Clear transmit modes via a radio button programmed to SECURE.

Revert Talkgroup
(or Revert Subfleet)

Enter a three-digit hexadecimal number for Emergency Default Talkgroup. This field contains the Emergency User Talkgroup for use during an emergency for the current personality.

- If the tactical emergency feature is disabled, all emergency transmissions will be made on this default talkgroup.
- If tactical is enabled, all emergency transmissions are made on the currently selected talkgroup. *The only exception would be when the radio has been dynamically regrouped and the dynamic regrouping mode is selected, in which case the emergency transmission would be made on the dynamic regrouping talkgroup.*

Revert Talkgroup
(or Revert Subfleet) Strapping

Use the UP/DOWN arrow keys to make your selection. This field configures the transmit mode of Emergency Talkgroup or Emergency Subfleet. If set to Clear or SECURE, the Emergency Talkgroup or the Emergency Subfleet is forced to that particular transmit mode. When set to Select, the user is allowed to select the SECURE or Clear transmit modes using a radio button programmed to SECURE.

Trunking Personality Options



From the MAIN MENU, press **F4** thrice and then **F9** to access this screen.

MOTOROLA Radio Service Software MCS Model:	Use UP/DOWN Arrows to Select Choice.								
MAIN:CHANGE/VIEW:TRUNKING:PERS:OPT									
Personality.....1 TRUNKING PERSONALITY OPTIONS ----- Conversation Type.....Message Talk Permit Tone.....Enabled VRM100..... Enabled									
F1 HELP	F2	F3 PREV PERS	F4 NEXT PERS	F5	F6 PREF SITES	F7 VRM OPTIONS	F8	F9	F10 EXIT

This screen is used to view and edit additional information for the current Trunking personality. Press **Tab** to select the desired field, or press the desired function key (**F1 - F10**). If a field is highlighted, use the UP/DOWN arrow keys to select the desired choice or value.

Function Key Descriptions

F3 - PREV PERS

Accesses the previous personality.

F4 - NEXT PERS

Accesses the next personality.

F6 - PREF SITES (*not shown*)

A system key or FTR key must be present and the Coverage Type field must be set to SmartZone on the TRUNKING SYSTEM screen (F4/F4/F3) for this function to be visible. This function accesses the SmartZone Preferred Sites linked to the current personality.

F7 - VRM OPTIONS

This function will be visible only if:

- The VRM500 Capable field on the RADIO WIDE OPTIONS screen (**F4/F3/F2**) is set to Enabled; or
- The VRM100 field on the current screen (TRUNKING PERSONALITY OPTIONS, **F4/F4/F4/F9**) is set to Enabled.

Brings up a screen where you can view and edit VRM100 or VRM500 options depending on whether the VRM100 Capable or VRM500 Capable field is set to Enabled on the RADIO WIDE OPTIONS screen.

Field Definitions

Personality Use the UP/DOWN arrow keys to scroll through the available personalities. Alternately the **F3/F4** function keys can be used to navigate through the available personalities.

Conversation Type Use the UP/DOWN arrow keys to select the Trunking Conversation type. The available choices are:

Message Trunked	After the initiator de-keys the radio, the voice channel stays active (hangtime) so that other members of the talkgroup can respond on the same channel. If a radio in the talkgroup transmits during another user's transmission, he or she will interrupt the original transmission.
Transmission Trunked	No hangtime and no talk-over. When a radio is de-keyed, the channel is immediately de-allocated and reassigned. If a user tries to talk over an active channel, the radio will not key until the channel is clear.
PTT- ID	PTT-ID systems are similar to message conversation type systems with hangtime and talk-over, but they send an ID code to the controller when PTT is pressed. After transmission of the ID, the radio goes back to the voice channel to talk to the other users.

Auto Scan (*not shown*) Use the UP/DOWN arrow keys to enable/disable the Auto Scan option for this personality. When this feature is enabled, the radio will automatically scan when on this personality. To use a scan on/off switch or button, this option must be disabled.

The default is Disabled.

Proper Code Detect (*not shown*) Use the UP/DOWN arrow keys to enable/disable this feature. When this feature is enabled, the speaker will unmute on SECURE data only if it is encrypted with the correct key.

Talk Permit Tone Use the UP/DOWN arrow keys to enable/disable Talk Permit Tones. When this feature is enabled, a Talk Permit Tone beep will be made every time a transmission is made. The tone indicates that the user may begin the talking.

The default is Enabled.

VRM100 *This field cannot be set to Enabled if the VRM500 Capable field on the RADIO WIDE OPTIONS screen has been set to Enabled.* Use the UP/DOWN arrow keys to enable/disable the VRM100 option for the current Trunking personality.

The default is Disabled.

Use the UP/DOWN arrow keys to Enable or Disable System Wide Transmit.

System Wide Transmit When the System Wide Transmit field is set to Enabled, the user will be allowed to enter 'SYS' (System Wide Talkgroup) into the talkgroup list of the corresponding personality.

When the System Wide Transmit field is set to Disabled, the user will not be allowed to enter 'SYS' (System Wide Talkgroup) into the talkgroup list of the corresponding personality. The System Wide Transmit field cannot be set to Disabled if there is a talkgroup entry which has 'SYS'.

When the Coverage field is set to SmartZone (**F4F4F3**), PEF SITES allows access to the SmartZone Preferred Sites linked to this personality.

SmartZone Preferred Sites



From the MAIN MENU, press **F4** thrice, **F9** and then **F6** to access this screen.

MOTOROLA Radio Service Software MCS Model:	Use UP/DOWN Arrows to Select Choice.								
..TRUNKING:PERS:OPT:PREFERRED SITES									
<pre> SMART ZONE PREFERRED SITES ----- Ignore Site Resource Preference.....Disabled # Site ID Prefer Status - - 1 1 None </pre>									
F1 HELP	F2 ADD ITEM	F3	F4	F5 DELETE ITEM	F6	F7	F8	F9	F10 EXIT

A system key or FTR key must be present and the Coverage Type field must be set to SmartZone on the TRUNKING SYSTEM screen (F4/F4/F3) if this screen is to be accessed. This screen is used to program the Preferred Site Status List. You may assign preference to up to 8 sites for each personality associated with a SmartZone system.

Function Key Descriptions

F2 - ADD ITEM

Adds a Preferred Site.

F4 - DELETE ITEM

Deletes a Preferred Site. You will be prompted for confirmation before the Site is actually deleted.

Field Definitions

Ignored Site Resource Preference

Use the UP/DOWN arrow keys to enable/disable this feature. If this feature is enabled, the radio ignores site resource information.

The factory default is Disabled.

Site ID

The value specifies the ID of the site which has preferred status. The ID may range from 1 to 64.

Prefer Status

This field denotes the value of the preferred site status for the site.

None	The site will be avoided unless it is the only usable site for operation.
Least	The site is given no preference. If the site is not listed here, the radio automatically assigns it no preference.
Preferred	The site will be used over all non-preferred sites with similar signal strength.
Always	The site will be used over all non-preferred sites with similar signal strength even if site loses communication with the zone controller (enters site trunking).

The default is Non-Preferred.

OmniLink Preferred Sites

From the MAIN MENU, press **F4** thrice, **F9** and then **F6** to access this screen.



MOTOROLA Radio Service Software
MCS Model:

Use UP/DOWN Arrows to Select Choice.

..TRUNKING:PERS:OPT:PREFERRED SITES

OMNILINK PREFERRED SITES				
Ignore	Site	Resource	Preference	Disabled
#	Site ID		Status	System ID
1	1		None	0001
2	2		Preferred	0001
3	3		Least	0001
4	1		Always	0001
5	2		None	0001
6	3		None	0001
7	1		None	0001
8	2		None	0001

F1	F2	F3	F4	F5	F6	F7	F8	F9	F10
HELP	ADD			DELETE					EXIT
	ITEM			ITEM					

A system key or FTR key must be present and the Coverage Type field must be set to SmartZone and the OmniLink field must be set to Enabled on the TRUNKING SYSTEM screen (F4/F4/F3) if this screen is to be accessed. This screen is used to program the OmniLink Preferred Site Status List. You may assign preference to up to 32 sites for each personality associated with an OmniLink system. There are 4 different levels of preference: NON-PREFERRED, LEAST-PREFERRED, PREFERRED, ALWAYS-PREFERRED. The default ranking of a site is NON-PREFERRED. Radio will attempt to use ALWAYS/PREFERRED sites as frequently as possible and LEAST PREFERRED sites as infrequently as possible.

Function Key Descriptions

F2 - ADD ITEM Adds a Preferred Site.

F4 - DELETE ITEM Deletes a Preferred Site.

You will be prompted for confirmation before the Site is actually deleted.

Field Definitions

Ignored Site Resource Preference Use the UP/DOWN arrow keys to enable/disable this feature. If enabled, the radio ignores site resources information (i.e., if the site has ASTRO, 12 Kbit Secure, or Analog Clear repeaters) received in Adjacent Control Channel OSWs.

If disabled, the radio will select sites based on this site resources information. For example, if a radio has selected an ASTRO TG, it will select sites with ASTRO repeaters over sites with only Analog repeaters.

The factory default is Disabled.

Site ID

The value specifies the ID of the site which has preferred status. The ID may range from 1 to 64.

The factory default is 1.

Prefer Status

Use the UP/DOWN arrow keys to make your selection. This field controls the preferred site status for the site. The choices are:

None (Non-Preferred)	The site is given no preference. If the site is not listed here, the radio automatically assigns it no preference.
Least Preferred	The site will be avoided unless it is the only usable site for operation.
Preferred	The site will be used over all non-preferred sites with similar signal strength.
Always Preferred	The site will be used over all non-preferred sites with similar signal strength even if site loses communication with the Zone Controller (that is, enters site Trunking).

The default is Non-Preferred.

System ID

This field contains the 4-digit hexadecimal number which identifies the trunked System. This number must match the ID of the Trunking Repeater System.

VRM100 Trunk Options

From the MAIN MENU, press **F4** thrice, **F9** and then **F7** to access this screen.



MOTOROLA Radio Service Software MCS Model:		
...TRUNKING:PERS:OPT:VRM100		
Personality.....1		
		VRM100 TRUNK OPTIONS -----
		VRM100 Pager ID.....00001
		VRM100 Talk Group.....001
F1 HELP	F2	F3
	F4	F5
	F6	F7
	F8	F9
	F10 EXIT	

VRM100 Trunking Options for Type II (800 MHz)

MOTOROLA Radio Service Software MCS Model:		
...TRUNKING:PERS:OPT:VRM100		
Personality.....1		
		VRM100 TRUNK OPTIONS -----
		VRM100 Pager ID.....00001
		VRM100 Size Code.....001
		VRM100 Fleet.....001
		VRM100 Sub-Fleet.....001
F1 HELP	F2	F3
	F4	F5
	F6	F7
	F8	F9
	F10 EXIT	

VRM100 Trunking Options for Type Iii (800 MHz)

This screen will vary depending on whether you have enabled VRM100 or VRM500 operation for the radio and the model of the current radio codeplug. Only if VRM100 operation has been enabled will this screen display fields relating to VRM100 operation. (For help information on the VRM500 TRUNK OPTIONS screen, refer to page 195.)

In order to access the VRM100 TRUNK OPTIONS screen:

- The VRM100 field on the RADIO WIDE OPTIONS screen (F4/F3/F2) must be set to Enabled.*
- The VRM100 field on the TRUNKING PERSONALITY OPTIONS screen (F4/F4/F4/F9) must be set to Enabled.*

Field Definitions

VRM100 Pager ID

This field will be visible only if VRM100 operation has been enabled for the radio. (Refer to dependencies detailed in the screen description above.) Enter the Trunking Pager ID. This value represents the Trunking Pager ID of the radio unit which serves as VRM100 master pager unit in the VRM100 network. This pager unit may Call Alert the radio to activate its data mode in order to communicate with the master VRM100.

Valid IDs range between 1 and 65534. The Pager ID is used for the radio's Private Conversation Call ID (7 + ID#), interconnect land-to-portable unit calls (7 + ID#) and interconnect land-to-portable Talkgroup calls (7 + ID#).

VRM100 Talkgroup

This field will be visible only for Type II models and only if VRM100 operation has been enabled for the radio. (Refer to dependencies detailed in the screen description above.) The value in this field represents a Talkgroup dedicated to VRM100 data operation only. Enter the Talkgroup IDs (three-digit) for this personality in Hexadecimal.

The default is 001.

VRM100 Size Code

This field will be visible only for Type III models and only if VRM100 operation has been enabled for the radio. (Refer to dependencies detailed in the screen description above.) Use the UP/DOWN arrow keys to choose the Size Code for this personality. The Size Code determines the maximum number of fleets, subfleets and individual IDs allowed. Valid codes are: A, B, C, D, E, F, G, H, I, J, K, M, O and Q.

Size Code	Prefix	Fleet	Subfleet	Individual ID
A	0 - 7	00 - 7F	A - C	000 - 00F
B	0 - 7	00 - 0F	A - G	000 - 03F
C	0 - 7	00 - 07	A - G	000 - 07F
D	0 - 7	00 - 00	A - O	000 - 1FF
E	0 - 7	00 - 3F	A - C	000 - 01F
F	0 - 7	00 - 1F	A - G	000 - 01F
G	0 - 7	00 - 1F	A - C	000 - 03F
H	0 - 7	00 - 0F	A - C	000 - 07F
I	0 - 7	00 - 07	A - C	000 - 0FF
J	0 - 7	00 - 03	A - G	000 - 0FF
K	0 - 7	00 - 01	A - C	000 - 0FF
M	0, 2, 4, 6	00 - 00	A - C	000 - 3FF
O	0 - 4	00 - 00	A - C	000 - 7FF
Q	0 - 0	00 - 00	A - C	000 - FFF

The Fleet ID is a three-digit hexadecimal number where the first digit is the prefix and the second two digits are the Fleet. For any size code, the subfleets for Fleetwide and Dynamic Regrouping are always available.

Note: *The size code and Fleet ID chosen must match the programming of the Central Controller.*

VRM100 Fleet

This field will be visible only for Type III models and only if VRM100 operation has been enabled for the radio. (Refer to dependencies detailed in the screen description above.) Enter a three-digit hexadecimal number for VRM Fleet ID where the first digit is the prefix and the next two digits identify the Fleet. The VRM100 Fleet is used during a VRM100 transmission for the current personality.

The default is 001.

VRM100 Subfleet

This field will be visible only for Type III models and only if VRM100 operation has been enabled for the radio. (Refer to dependencies detailed in the screen description above.) Enter a three-digit hexadecimal number for VRM100 Subfleet. A Subfleet is a logical grouping of members of an organization.

The default is 001.

VRM500 Trunk Options

From the MAIN MENU, press **F4** thrice, **F9** and then **F7** to access this screen.



MOTOROLA Radio Service Software		
MCS	Model:	
... TRUNKING:PERS:OPT:VRM500		
Personality.....1 <div style="text-align: center;">VRM500 TRUNK OPTIONS -----</div> VRM500 Pager Individual ID.....1 VRM500 Deaffiliation.....Disabled		
F1 HELP	F2	F3
F4	F5	F6
F7	F8	F9
F10 EXIT		

This screen will vary depending on whether you have enabled VRM100 or VRM500 operation for the radio and the model of the current radio codeplug. This screen will display fields relating to VRM500 operation only if VRM500 operation has been enabled. In order to access the VRM500 TRUNK OPTIONS screen, the VRM500 field on the RADIO WIDE OPTIONS screen (F4/F3/F2) must be set to Enabled. (For help information on the VRM100 TRUNK OPTIONS screen, refer to page 192.)

This screen allows you to define and modify VRM500 radio options. Press **Tab** to select the desired field, or press the desired function key (**F1 - F10**). If a field is highlighted, use the UP/DOWN arrow keys to select the desired choice or value.

Field Definitions

VRM500 Pager Individual ID

This field will be visible only if VRM500 operation has been enabled for the radio. (Refer to dependencies detailed in the screen description above.) Enter the Trunking Pager ID. This value represents the Trunking Pager ID of the radio unit which serves as the Robin pager in the VRM500 system. The Robin pager is used to page the radio on the Trunking system, to request it to go to Data mode using Call Alert signalling.

The default is 1.

VRM500 Deaffiliation

This field will be visible only if VRM500 operation has been enabled for the radio. (Refer to dependencies detailed in the screen description above.) If the Affiliation Type field on the TRUNKING SYSTEM screen (F4/F4/F3) is set to On PTT, the setting for this field will be forced to Disabled. If the Affiliation Type field is set to Automatic, this field will be set to Enabled and you can set this field to Enabled or Disabled.

Use the UP/DOWN arrow keys to enable/disable deaffiliation from the Trunking system before the radio enters the VRM500 data mode.

The default is Disabled.

Notes

Trunking Call List Table



From the MAIN MENU, press **F4** twice and then **F5** to access this screen.

MOTOROLA Radio Service Software MCS Model:					Enter or Scroll to Select List.					
MAIN:CHANGE/VIEW:TRUNKING:CALL LIST										
Call List..... 1					CALL LIST TABLE					
-----					-----					
#	Call ID	Call Text	#	Call ID	Call Text	#	Call ID	Call Text	#	Call ID
-	-----	-----	-	-----	-----	-	-----	-----	-	-----
1		CALL 1								
F1	F2	F3	F4	F5	F6	F7	F8	F9	F10	
HELP	ADD	PREV	NEXT	DELETE	ADD	DELETE				EXIT
	LIST	LIST	LIST	LIST	CALL ID	CALL ID				

This screen is used to edit Trunking Call IDs and their associated names (or aliases). *The number of characters for the name will be determined by the display capability of the radio.* Each Trunking system may have a unique call list. *Each list may have a maximum of 10 IDs for a Model I and 19 for other models.*

Note: The call lists defined on this screen are assigned to the Trunking system on the TRUNKING SYSTEM screen (**F4/F4/F3**). *This assignment must be made or else the list will not be accessible.*

Press **Tab** to select the desired field, or press the desired function key (**F1 - F10**). If a field is highlighted, use the UP/DOWN arrow keys to select the desired choice or value.

Function Key Descriptions

F2 - ADD LIST

Adds a call list.

F3 - PREV LIST

Accesses the previous list.

F4 - NEXT LIST

Accesses the next list.

F5 - DELETE LIST

Deletes a call list. You will be prompted before the list is actually deleted.

Note: The call list being deleted may be referenced by other fields. *Deleting such a call list may cause the radio to operate improperly.*

F6 - ADD CALL ID

Adds a new call ID.

F7 - DELETE CALL ID

Deletes a call ID. You will be prompted before the ID is actually deleted.

Conventional Menu

From the MAIN MENU, press **F4** and then **F6** to access this screen.



MOTOROLA Radio Service Software MCS Model:	Select Function F1 - F10.								
MAIN:CHANGE/VIEW:CONV									
CONVENTIONAL MENU ----- F1 - HELP F2 - Conventional Radio Wide Configuration F3 - Conventional Personalities, Options F4 - MDC Systems, Options, Call List F5 - F6 - F7 - Auxiliary Systems F8 - Conventional Message Alias List F9 - Conventional Status Alias List F10 - EXIT									
F1 HELP	F2 CONV WIDE OPT	F3 CONV PERS	F4 MDC CONFIG	F5	F6	F7 AUX SYSTEM	F8 MSG ALIAS	F9 STATUS ALIAS	F10 EXIT

This screen allows you to navigate to the Conventional edit screens. *The options in these menus pertain only to Conventional radio features.*

Function Key Descriptions

F2 - CONV WIDE OPT
(Conventional Radio Wide Options)

Applicable to all Conventional channels and includes options such as monitor type.

F3 - CONV PERS
(Conventional Personality)

This screen is used to define Conventional frequencies, coded squelch type (PL/DPL), and Conventional options (scan, etc.) permitted on each channel.

F4 - MDC CONFIG
(MDC Configuration)

This function will be visible only when a radio with MDC capabilities has been read. Not all radios have this capability. This screen is used to define the MDC signalling configuration for each Conventional personality. Each system can be defined with a unique PTT-ID, emergency operation and signalling timing options.

F7 - AUX SYSTEM
(Auxiliary System)

Takes you to a screen where you can define SingleTone system information, SingleTone Lists, Quick-Call II system information, and GE Star system information.

F8 - MSG ALIAS
(Message Alias)

This option will be visible only when the Message Alias field is set to Enabled. Brings up a screen where you can change and view the parameters associated with the MDC System Message Alias.

F9 - STATUS ALIAS

This option will be visible only when the Status Alias field is set to Enabled. Brings up a screen where you can change and view the parameters associated with the MDC System Status Alias.

Conventional Radio Wide Options



From the MAIN MENU, press **F4**, **F6** and then **F2** to access this screen.

MOTOROLA Radio Service Software MCS Model:		Enter or Scroll to Select Value.							
MAIN:CHANGE/VIEW:CONV:WIDE OPTIONS									
CONVENTIONAL RADIO WIDE OPTIONS ----- Smart PTT Retry Timer (ms)..... 275 Smart PTT Quick Key Timer (ms).....500 Hub Defeats PL.....Enabled Direct Frequency Enabled.....Disabled									
F1 HELP	F2 MPL LIST	F3	F4	F5	F6	F7	F8	F9	F10 EXIT

The options and parameters on this screen apply to all Conventional channels and personalities. Other Radio wide options that apply to both Conventional and Trunking operation are located on the RADIO WIDE OPTIONS screen (**F4/F3/F2**). Trunking options are located on the TRUNKING RADIO WIDE OPTIONS screen (**F4/F4/F2**).

Press **Tab** to select the desired field, or press the desired function key (**F1 - F10**). If a field is highlighted, use the UP/DOWN arrow keys to select the desired choice or value.

Function Key Descriptions

F2 - MPL LIST

MPL LIST allows the MPL entries associated with the User-Selectable PL (MPL) feature to be entered and edited.

Field Definitions

Smart PTT Retry Timer (ms)

Use the UP/DOWN arrow keys to select a value for Smart PTT Retry Timer. When Smart PTT is enabled, this field adjusts the time interval at which the radio will sample for a clear channel. The valid range of values is 0 (zero) to 5000 ms in 25-ms increments.

The default is 275 ms.

Smart PTT Quick Key Timer (ms)

Use the UP/DOWN arrow keys to select a value for Smart PTT Retry Timer. When smart PTT is enabled, a quick key (double press) of the PTT button can override the feature and cause the radio to transmit although the channel is busy. The timer determines the maximum amount of time between PTT presses, that is, how fast the user must press the PTT button to override. The valid range of values is 100 to 5000 ms in 100-ms increments.

The default is 500 ms.

Hub Defeats PL

This feature is only applicable to portable radios when a Vehicular Adapter is used. Use the UP/DOWN arrow keys to enable/disable the Hang-Up Box (HUB) Defeats PL feature. When Hub Defeats PL is enabled, PL/DPL will be disabled when the microphone is removed from the hang-up box. In the SECURE mode, the radio will go out of Proper Mode Detect. This allows for monitoring of a Conventional channel to prevent transmission during another conversation.

The default is Enabled.

Direct Frequency Enabled

Use the UP/DOWN arrow keys to enable/disable this feature. If the Direct Frequency flag is enabled, the user can enter the Direct Frequency in the CONVENTIONAL PERSONALITY screen (**F4/F6/F3**) and modify it. If the Direct Frequency flag is disabled, the Direct Frequency will be copied from the Conventional Rx frequency.

The default is Disabled.

MPL List Configuration



From the MAIN MENU, press **F4**, **F6**, **F2**, and then **F2** to access this screen.

MOTOROLA Radio Service Software MCS Model:		Enter or Scroll to Select List.							
MAIN:CHANGE/VIEW:CONV:WIDE OPTIONS:MPL									
MPL LIST CONFIGURATION -----									
MPL Number..... 1	MPL Name.....MPL 1								
Squelch Type	Receive	Transmit	Direct						
Code	CSQ	Disabled	Disabled						
DPL Invert									
F1 HELP	F2 ADD MPL	F3 PREV MPL	F4 NEXT MPL	F5 DELETE MPL	F6	F7	F8	F9	F10 EXIT

The MPL Configuration screen is used to change/view the parameters that pertain to the MPL List which is used with the User-Selectable PL (MPL) feature in the Conventional Personality Options Screen (Main->**F4**->**F6**->**F3**->**F9**). To print the MPL List, press **F2** from the Print Conventional Menu Screen (**Main**, **F5**, **F6**).

Function Key Descriptions

- F2 - ADD MPL**
ADD MPL is used to add another MPL entry to the MPL List. A total of 16 MPL entries are allowed.
- F3 - PREV MPL**
PREVIOUS MPL is used to navigate to the previous MPL entry while remaining in the same data field.
- F4 - NEXT MPL**
NEXT MPL is used to navigate to the next MPL entry while remaining in the same data field.
- F5 - DELETE MPL**
DELETE MPL is used to remove the current MPL entry from the MPL list.

Field Definitions

- MPL Number**
This field selects an available MPL entry. Alternately, the **F3/F4** function keys can be used to navigate through the MPL entries.
- MPL Name**
The MPL names will ONLY be displayed when viewing or changing the radio's currently selected MPL.

Enter the alphanumeric text that will appear on the radio display for this MPL entry. The maximum number of characters will vary based on the radio model.
- Squelch Type**
Refer to the Conventional Personality Screen's Field Definitions.

PL Code	Refer to the Conventional Personality Screen's Field Definitions.
DPL Code	Refer to the Conventional Personality Screen's Field Definitions.
DPL Invert	Refer to the Conventional Personality Screen's Field Definitions.

Conventional Personality



From the MAIN MENU, press **F4**, **F6** and then **F3** to access this screen.

MOTOROLA Radio Service Software MCS Model:		Enter or Scroll to Select System.	
MAIN:CHANGE/VIEW:CONV:PERS			
Personality.....1 CONVENTIONAL PERSONALITY -----			
Receive Only.....Disabled	Signalling.....MDC		
Direct / Talkaround.....Enabled	MDC System #.....1		
Time Out Timer.....3- 60	PTT ID.....Disabled		
Scan List.....None	Emerg. PTT ID.....Disabled		
Hot Keypad.....Disabled	Revert.....Selected Channel		
Phone Operation.....Unlimited	Quik-Call II System #...Disabled		
Frequency (MHz)	Receive	Transmit	Direct
Squelch Type	136.06250	136.01250	136.06250
Code	CSQ	Disabled	Disabled
DPL Invert			
F1	F2	F3	F4
HELP	ADD	PREV	NEXT
	PERS	PERS	PERS
F5	F6	F7	F8
DELETE	SECURE	MDC	PHONE
PERS	OPTIONS	OPTIONS	OPTIONS
F9	F10		
MORE	EXIT		
OPTIONS	OPTIONS		

This screen allows the user to edit information for Conventional operation. Press **Tab** to select the desired field, or press the desired function key (**F1 - F10**). If a field is highlighted, use the UP/DOWN arrow keys to select the desired choice or value.

Function Key Descriptions

F2 - ADD PERS

Adds a Conventional personality. A maximum of 10 Conventional Personalities may be created. Each personality must be “connected” to a channel on the ZONE/CHANNEL ASSIGNMENT screen (**F4/F8**).

F3 - PREV PERS

Accesses the previous personality.

F4 - NEXT PERS

Accesses the next personality.

F5 - DELETE PERS

Removes the current personality. You will be prompted for confirmation before the personality is deleted. *A minimum of one Conventional personality must be maintained.*

Note: *The only way to recover a deleted personality is to immediately re-read the radio or the archive file. However, any other changes that were made and not previously saved will still be lost.*

F6 - SECURE OPTIONS (not shown)

This function will be active only when a radio equipped with SECURE hardware has been read. Accesses the SECURE parameters linked to this personality.

F7 - MDC OPTIONS

This function will be active only when a radio with MDC capabilities has been read and the Signalling Type field is set to MDC. Allows access to MDC parameters linked to this personality. Other system-wide MDC parameters are located on the MDC SYSTEM screen (**F4/F6/F4/F3**).

F8 - PHONE OPTIONS

This function will be active only when the Phone Operation field has been set to a value other than None. Allows access to Conventional interconnect access codes and digit timing parameters for this personality.

F9 - MORE OPTIONS

Allows you to access additional parameters that can be used to customize a radio to specific system requirements.

Field Definitions

Personality

Use the UP/DOWN arrow keys to select the desired Conventional Personality. You may also enter the number directly.

Note: Refer to the Motorola Radio Catalog Sheets for the maximum number of personalities allowed for this model.

Receive Only

Use the UP/DOWN arrow keys to enable/disable Receive-only operation on this personality. If this feature is enabled, all transmissions including signalling are inhibited.

The default is Disabled.

Direct/Talkaround

This field will not be visible if the Receive Only field is set to Enabled. Use the UP/DOWN arrow keys to enable Talkaround operation on the current personality. In Talkaround (or Direct) mode, the radio will transmit on the receive frequency. This is useful when a repeater is not in operation or is out of range.

Talkaround may be used in a manual or automatic mode. In the manual mode, a talkaround switch must be defined on the RADIO WIDE BUTTON SWITCH MENU (F4/F3/F3). The switch may be either on the top or side of the radio or on the keypad menu (if applicable).

Note: If talkaround operation is enabled and no button/switch is assigned, the radio will default to talkaround operation on this personality.

The default is Enabled.

Time-Out Timer (sec)

This field will not be visible if the Receive Only field is set to Enabled. Use the UP/DOWN arrow keys to select the Time-Out Timer (TOT) for this personality. Time-Out Timer determines the amount of time the radio can continuously transmit before it must be de-keyed. When the Time-Out Timer is about to expire, the radio beeps and then stops transmitting.

Each personality may have one of four different TOT values. These values are: 15, 30, 45, 60, 90, 120 and 180 seconds and Infinite (that is, Time-Out Timer disabled). The four values for the radio can be changed on the RADIO WIDE OPTIONS MENU (F4/F3/F2/F9).

The default is 60 seconds.

Scan List

Use the UP/DOWN arrow keys to select the Scan List to be used for this personality. To change or view the scan list, access the SCAN LIST screen (F4/F3/F5). Conventional personalities may use Conventional or Talkgroup type scan lists.

The default is None.

Hot Keypad

This field will not be visible if the Receive Only field is set to Enabled. Use the UP/DOWN arrow keys to enable/disable Hot Keypad (DTMF while transmitting) operation for this personality. When this feature is enabled, the keypad is live during all dispatch operation. Pressing any digit 0 (zero) through 9, “*”, or “#” will cause that digit to be transmitted.

The default is Disabled.

Phone Operation

This field will not be visible if the Receive Only field is set to Enabled. Use the UP/DOWN arrow keys to select the type of phone service for this personality:

List Only	The user may only call pre-programmed numbers from the phone list stored in the radio.
Unlimited	The user may call phone numbers from the list, or directly enter any number via the keypad.
Resp Only	The user may only answer calls directed to the radio.
None	DisableS phone operation for this personality.

The Phone Options function key will be active only when this field has been set to a value other than None.

Note: If the radio has Manual Access with Live Dialing, this field must be set to Unlimited to allow keypad access.

The default is None.

Signalling

Use the UP/DOWN arrow keys to enable MDC or other signalling types provided for this personality.

MDC	MDC is a MOTOROLA proprietary, 1200-baud digital signalling protocol used for unit identification, selective signalling and emergency features.
GE STAR	A type of signalling protocol which provides features such as Data Operated Squelch (DOS), Emergency Alarm, and PTT-ID.

The MDC Options function key will be active only when this field has been set to MDC.

The default is None.

MDC System #/
GE STAR System #

This field will be visible only if the Signalling field is set to a value other than None. Use the UP/DOWN arrow keys to select the MDC/GE STAR system to be used by this personality. Integer values ranging from 1 to 7 are allowed. The radio supports a maximum of 7 GE STAR systems.

Note: To add and/or configure MDC systems, access the MDC SYSTEM screen (**F4/F6/F4/F3**). To add and/or configure GE STAR systems, access the GE STAR SYSTEM screen (**F4/F6/F7/F5**).

The default is 1.

PTT-ID

Use the UP/DOWN arrow keys to enable the MDC Unit Identification feature for this personality. When this feature is enabled, the Unit ID will be broadcast each time the transmitter is keyed and/or de-keyed.

Note: Access the MDC OPTIONS screen (**F4/F6/F3/F7**) to specify when the ID must be transmitted.

The default is Disabled.

Emergency (*not shown*)

Use the UP/DOWN arrow keys to enable/disable the MDC Emergency feature for this personality.

Note: The Emergency feature for this system can be configured on the MDC SYSTEMS screen (**F4/F6/F4/F3**). The radio can also be set up for silent emergency operation from the RADIO WIDE OPTIONS MENU (**F4/F3/F7**).

The default is Disabled.

Quik-Call II System #

Use the UP/DOWN arrow keys to scroll through the available choices or directly enter the desired value. Integer values from 1 to the maximum number of Quik-Call II systems are allowed. *The radio will support a maximum of 15 Quik-Call II systems.*

The default is Disabled.

Frequency (MHz)

The Transmit and Direct Frequency fields will not be visible if the Receive Only field is set to Enabled. The Direct Frequency field will not be visible if the Direct/Talkaround field is set to Disabled.

Enter the Receive, Transmit or Direct (Talkaround) frequency directly in MHz. Alternatively, the UP/DOWN arrow keys may be used to scroll through the valid channels. *Blank receive frequency fields are not allowed.*

Note: Refer to the MOTOROLA Catalog Sheets/Price Pages for valid receive frequencies for this model.

Squelch Type

Use the UP/DOWN arrow keys to select Receive, Transmit and/or Direct (Talkaround) squelch type from among the following:

CSQ	Carrier Squelch (Receive Only)
PL	Tone Private-Line
DPL	Digital Private-Line
Disabled	(Transmit and Direct Only)

A data field for a Receive code will be displayed if PL or DPL is selected.

Code

Enter the PL (Private-Line) code directly in Hz (192.8 for instance) or use the alphanumeric code (7A for instance). Alternatively, the UP/DOWN arrow keys may be used to scroll through standard frequencies and codes. The code can also be selected by pressing the first letter and then scrolling to select the correct code. Press **F1 HELP** while in this field to view a list of standard frequencies and their respective codes.

Standard Private-Line Frequencies/Motorola codes are:

Freq	Code	Freq	Code	Freq	Code	Freq	Code	Freq	Code
67.0	XZ	91.5	ZZ	123.0	3Z	167.9	6Z	225.7	M4
69.3	WZ	94.8	ZA	127.3	3A	173.8	6A	229.1	9Z
71.9	XA	97.4	ZB	131.8	3B	179.9	6B	233.6	M5
74.4	WA	100.0	1Z	136.5	4Z	186.2	7Z	241.8	M6
77.0	XB	103.5	1A	141.3	4A	192.8	7A	250.3	M7
79.7	WB	107.2	1B	146.2	4B	203.5	M1	254.1	OZ
82.5	YZ	110.9	2Z	151.4	5Z	206.5	8Z		
85.4	YA	114.8	2A	156.7	5A	210.7	M2		
88.5	Y	118.8	2B	162.2	5B	218.1	M3		

Note: A low-level hum or buzz in the received audio MAY be experienced when TPL code OZ (254.1 Hz) is used. This PL code is at the high end of the sub-audible frequency range and may be heard in the audio under certain circumstances. *Use of this code should be avoided if possible.*

DPL Code

Enter the DPL (Digital Private-Line) code directly (023 for instance). *Leading zeros are required.* Alternatively, the UP/DOWN arrow keys may be used to scroll through the standard codes. Press **F1 HELP** while in this field to view a list of standard frequencies and their respective codes. Valid DPL Codes are:

Code	Code	Code	Code	Code	Code	Code	Code	Code
023	071	134	223	306	411	503	631	734
025	072	143	226	311	412	506	632	743
026	073	152	243	315	413	516	654	754
031	074	155	244	331	423	532	662	
032	114	156	245	343	431	546	664	
043	115	162	251	346	432	565	703	
047	116	165	261	351	445	606	712	
051	125	172	263	364	464	612	723	
054	131	174	265	365	465	624	731	
065	132	205	271	371	466	627	732	

DPL Invert

This field will be active (or can be accessed) only if the Squelch Type field is set to DPL. Use the UP/DOWN arrow keys to invert the received DPL code for this personality.

SECURE Options



From the MAIN MENU, press **F4**, **F6**, **F3** and then **F6** to access this screen.

MOTOROLA Radio Service Software MCS Model:	Use UP/DOWN Arrows to Select Choice.								
MAIN:CHANGE/VIEW:CONV:PERS:SECURE									
Personality.....1 CONVENTIONAL SECURE PERSONALITY ----- Secure/Clear Strapping.....Secure XL Transmit..... Enabled Scan Holdoff Strapping.....Both Rx Modulation.....2 Level Receive Proper Code Detect.....Enabled Echo Mute Time (ms)..... 0									
F1 HELP	F2	F3 PREV PERS	F4 NEXT PERS	F5	F6	F7	F8	F9	F10 EXIT

*This screen can be accessed only when a radio equipped with SECURE hardware has been read. This screen permits access to SECURE parameters linked to the current personality. Press **Tab** to select the desired field, or press the desired function key (**F1 - F10**). If a field is highlighted, use the UP/DOWN arrow keys to select the desired choice or value.*

Function Key Descriptions

- F3 - PREV PERS** Accesses the previous personality.
- F4 - NEXT PERS** Accesses the next personality.

Field Definitions

Personality Use the UP/DOWN arrow keys to select the desired conventional personality. The number may also be entered directly.

Note: Refer to the Radio Catalog Sheet for the maximum number of personalities allowed for this model.

Secure/Clear Strapping Use the UP/DOWN arrow keys to select the SECURE/Clear strapping for this personality. This field configures the personality's transmit mode. If this field is set to Clear or SECURE, the current personality is forced to that particular transmit mode. When set to Select, the user is allowed to select the SECURE or Clear transmit modes via the radio's two-position concentric switch.

The factory default is Select (*if switch is programmed for SECURE Tx Select*).

XL Transmit	<p>Use the UP/DOWN arrow keys to enable XL transmit mode for this personality. This field configures the transmit mode of the XL chip. When set to Enabled, XL encrypted data will be transmitted in SECURE transmit mode. When set to Disabled, Non-XL (Cipher Feedback) encrypted data will be transmitted in SECURE transmit mode. The receive mode of the XL chip need not be configured since it will automatically decrypt both XL and Non-XL data streams.</p> <p>The default is Enabled.</p>
Scan Select	<p>Use the UP/DOWN arrow keys to select the secure scan unsquelch duration for this personality. When scanning for coded transmissions, this field is used to select the amount of time the radio will wait for a SECURE detect following a carrier detect. If set to Non-XL, the radio will wait for the time period specified by the Non-XL (Cipher Feedback) Scan Unsquelch Duration field in the RADIO WIDE SECURE OPTIONS screen. If set to Non-XL&XL, the radio will wait for the time period specified by the XL Scan Unsquelch Duration field in the RADIO WIDE SECURE OPTIONS screen.</p>
Scan Holdoff Strapping	<p>Use the UP/DOWN arrow keys to select the desired choice. This feature is used to optimize the scan search algorithm and is normally based off on the receive signal type desired during scan operation. The value selected will determine the duration that the radio will wait on a channel for valid signal activity during scan. When set to either Clear Only or Secure Only, the radio will wait the preset time period specified for the selected signal type. When set to Both, the radio will use the longest preset time period to ensure that enough time is allocated to detect both signal types.</p> <p>The factory default is Both.</p>
Rx Modulation	<p><i>This field applies only to SECURE radios.</i> The value in this field should be based on the expected receive data format for the personality. This field allows the user to configure the radio's personality for:</p> <ul style="list-style-type: none"> <input type="checkbox"/> Strictly binary (two-level) receive operation; <input type="checkbox"/> Strictly multi-level (four-level) receive operation; or <input type="checkbox"/> Both binary and multi-level receive operation (Auto Receive). <p>When operating in Auto Receive mode, the radio will automatically detect the received signal type and process the data accordingly. <i>Two-level sensitivity is reduced when operating in the Auto Receive mode and thus should not be used on channels or systems that are strictly binary (two-level).</i></p> <p>The factory default is 2 Level Receive.</p>
Proper Code Detect	<p>Use the UP/DOWN arrow keys to enable proper code detect operation for this personality. When this field is set to Enabled, the speaker will unmute on SECURE data only if it is encrypted with the correct key.</p> <p>The factory default is Enabled.</p>
Echo Mute Time (ms)	<p>Use the UP/DOWN arrow keys to select the echo mute time for this personality. Values between 0 and 1500 ms may be selected in 50 ms increments. This field defines the time period that the user's radio will</p>

remain muted when dekeying following a secure transmission. In radio systems having a large amount of data throughput delay, the tail end of the user's transmitted message could be heard following dekey if this field is not set correctly to account for systems delays.

The factory default is 0 ms.

Personality MDC Options



From the MAIN MENU, press **F4**, **F6**, **F3** and then **F7** to access this screen.

MOTOROLA Radio Service Software MCS Model:	Use UP/DOWN Arrows to Select Choice.								
MAIN:CHANGE/VIEW:CONV:PERS:MDC									
Personality.....1 <div style="text-align: center;">PERSONALITY MDC OPTIONS -----</div> Call Alert Decode..... Enabled Tx Inhibit On Busy.....Enabled Call Alert Encode.....Enabled Selective Call Decode.....Enabled Unmute Type.....And Selective Call Encode.....Enabled Auto Sel Call Transmit...Enabled MDC Unlimited Calling.....Enabled									
F1 HELP	F2	F3	F4	F5	F6	F7	F8	F9	F10 EXIT

This screen permits access to additional MDC features and options to further customize the radio configuration to specific user needs.

 Caution	Caution should be observed when changing parameters on this screen. MDC System parameter changes can substantially degrade system performance if they are made on one or a few radios, but not all radios in the system.
-------------	--

Press **Tab** to select the desired field, or press the desired function key (**F1 - F10**). If a field is highlighted, use the UP/DOWN arrow keys to select the desired choice or value.

Field Definitions

Personality

Use the UP/DOWN arrow keys to select the desired Conventional personality. The number may also be entered directly or selected using the function keys.

Note: Refer to the Motorola Radio Catalog Sheets for the maximum number of personalities allowed for this model.

Call Alert Decode

Use the UP/DOWN arrow keys to enable/disable Call Alert Decode. If this feature is enabled, the user will be able to receive pages from the base station as well as from other radios.

The default is Disabled.

Call Alert Encode

Use the UP/DOWN arrow keys to enable/disable Call Alert Encode. If this feature is enabled, the user will be able to send pages to other radios.

Note: *If this feature is enabled and the user must be able to select target radio(s) ID(s) via the Call list, data must be programmed into the appropriate Call List Table.*

The default is Disabled.

Selective Call Decode

Use the UP/DOWN arrow keys to enable/disable the MDC Selective Call Decode feature for this personality. If this feature is enabled, this feature allows the user to receive individual and group calls. It is intended not so much to ensure privacy but to eliminate annoyance to users when they receive traffic that does not pertain to them.

The default is Disabled.

Unmute Type

This field will be visible only if the Select Call decode field is set to Enabled. Use the UP/DOWN arrow keys to select the muting type from among the following:

And Muting	Radio must receive both the Selective Call code (or Quik-Call II tones) and the proper code (PL/DPL and/or SECURE) before it will unmute.
Or Muting	Radio will unmute on proper code (PL/DPL and/or SECURE) or on carrier after the Selective Call code (or Quik-Call II tone) is decoded.

The radio will mute or become call-squelched again when the radio is reset by the manual reset option or by the expiration of the auto reset timer.

The default is Or.

Selective Call Decode

Use the UP/DOWN arrow keys to enable the MDC Selective Call Encode feature for this personality. If this feature is enabled, it allows the user to send calls to an individual radio or to a group of radios. It is intended not to ensure privacy but rather to eliminate annoyance to users when they receive traffic that does not pertain to them.

Note: *If this feature is enabled and the user must be able to select target radio(s) ID(s) via the Call list, data must be programmed into the appropriate Call List Table*

The default is Disabled.

Auto Sel Call Transmit

This field will be visible only if the Selective Call Decode field is set to Enabled. Use the UP/DOWN arrow keys to enable/disable the Auto Selective Call Transmit option. If this option is enabled, the radio will remain in Selective Call mode after the PTT switch is released. If not, it will exit Selective Call mode as soon as the PTT switch is released.

The default is Enabled.

MDC Unlimited Calling

This field will be visible only if the Selective Call Encode field is set to Enabled. Use the UP/DOWN arrow keys to enable/disable Unlimited Calling. If this option is enabled, the user will be able to directly enter from the keypad IDs of radios he or she wants to call. Target Radio ID selection via the programmed Call List instead is still a valid option available for models so equipped.

Note: *To be able to take advantage of this feature, a radio must be equipped with a numeric keypad. This option affects only the Call Alert Encode and Selective Call Encode features.*

The default is Disabled.

Tx Inhibit On Busy

Use the UP/DOWN arrow keys to enable/disable the MDC Transmit Inhibit on Busy Channel option for this personality. When this option is enabled, polite MDC transmissions will be inhibited when a carrier is present on the channel.

The default is Disabled.

Conventional Personality Phone Options



From the MAIN MENU, press **F4**, **F6**, **F3** and then **F8** to access this screen.

MOTOROLA Radio Service Software MCS Model:	Enter or Scroll to Select Personality.								
MAIN:CHANGE/VIEW:CONV:PERS:PHONE									
Personality... 1 CONVENTIONAL PERSONALITY PHONE OPTIONS ----- Auto Access Code Select.....1 -*1P# DTMF Access Timing Table.....1 Initial Delay (ms).....1000 Digit Duration (ms).....125 Integer Delay (ms).....75									
F1 HELP	F2	F3 PREV PERS	F4 NEXT PERS	F5	F6	F7	F8	F9	F10 EXIT

This screen allows the user to edit the Conventional phone configuration for each Conventional personality. Press **Tab** to select the desired field, or press the desired function key (**F1 - F10**). If a field is highlighted, use the UP/DOWN arrow keys to select the desired choice or value.

Function Key Descriptions

- F3 - PREV PERS** Accesses the previous personality.
- F4 - NEXT PERS** Accesses the next personality.

Field Definitions

Personality Use the UP/DOWN arrow keys to select the desired Conventional Personality. The number may also be entered directly.

Note: Refer to the Motorola Radio Catalog Sheets for the maximum number of personalities allowed for this model.

Auto Access Code Select Use the UP/DOWN arrow keys to select an Auto Access Code for this personality. The radio contains a table for DTMF Access and Deaccess code pairs and the personality points to one of the table entries. The actual four-digit codes are entered on the RADIO WIDE PHONE CONFIGURATION screen (**F4/F3/F4**).

The default is 1.

DTMF Access Timing Table

Use the UP/DOWN arrow keys to select the set of DTMF timing parameters for this personality. Timing can be changed for Initial Delay, Digit Duration and Integer Delay. The radio contains a table with four sets of values for each of these parameters. The actual parameters are entered on the RADIO WIDE PHONE CONFIGURATION screen (F4/F3/F4).

The default is DTMF timing parameter set to one.

Initial Delay (ms)

This a view-only field. The value shown here depends on the DTMF Access Timing Table chosen.

Digit Duration (ms)

This a view-only field. The value shown here depends on the DTMF Access Timing Table chosen.

Integer Delay (ms)

This a view-only field. The value shown here depends on the DTMF Access Timing Table chosen.

More Conventional Personality Options



From the MAIN MENU, press **F4**, **F6**, **F3** and then **F9** to access this screen.

MOTOROLA Radio Service Software MCS Model:		Use UP/DOWN Arrows to Select Choice.							
MAIN:CHANGE/VIEW:CONV:PERS:OPTIONS									
Personality.....1 CONVENTIONAL PERSONALITY OPTIONS ----- Smart PTT.....Inhibit On Carrier Quick Key Override.....Enabled Override Timer (ms).....500 Tx Power Level.....High Busy LED.....Enabled Unmute/Mute Type.....Standard Rx Unmute Delay (ms).....2- 100 Reverse Burst TOC.....Enabled Squelch (Fine Tune).....0 User-Selectable PL (MPL)..Disabled									
F1 HELP	F2	F3 PREV PERS	F4 NEXT PERS	F5	F6	F7 RAC OPTIONS	F8	F9	F10 EXIT

The CONVENTIONAL PERSONALITY OPTIONS MENU permits access to additional features and options to further customize the radio configuration to your specific communication needs.

 Caution	Be careful when changing parameters on this screen. System parameter changes can substantially degrade radio performance if they are not made system-wide.
-------------	--

Press **Tab** to select the desired field, or press the desired function key (**F1 - F10**). If a field is highlighted, use the UP/DOWN arrow keys to select the desired choice or value.

Function Key Descriptions

- | | |
|------------------|--|
| F3 - PREV PERS | Accesses the previous personality. |
| F4 - NEXT PERS | Accesses the next personality. |
| F7 - RAC OPTIONS | Brings up a screen which contains RAC-related information specific to the current personality. |

Field Definitions

Personality Use the UP/DOWN arrow keys to select the desired Conventional Personality. The number may also be entered directly.

Note: Refer to the Motorola Radio Catalog Sheets for the maximum number of personalities allowed for this model.

Smart PTT Use the UP/DOWN arrow keys to enable/disable the Smart PTT function. The radio can inhibit transmission either on detection of a carrier or on detection of a non-matching PL code. This feature

prevents users from listening in on (or transmitting over) conversations that they are not part of. *The Monitor button is Disabled when this feature is active.*

The default is Disabled.

Quick Key Override

This field will be visible only when the Smart PTT field is set to a value other than Disabled. Use the UP/DOWN arrow keys to enable the Smart PTT (Push-to-Talk) Override feature. If this override feature is enabled, the user can transmit on a busy channel by a quick key (double press) of the PTT switch.

The default is Disabled.

Override Timer (ms)

This field will be visible only when the Quick Key Override field is set to Enabled. This is the amount of time the user can transmit on a busy channel by a quick key (double press) of the PTT button.

Tx Power Level

Use the UP/DOWN arrow keys to select High or Low transmit power for this personality. When set to Low, the transmit power is approximately half that of High.

The factory default is High.

Busy LED

Use the UP/DOWN arrow keys to enable/disable the yellow LED to indicate the presence of a carrier (busy channel).

The default is Enabled.

Unmute/Mute Type

Use the UP/DOWN arrow keys to select the receiver muting and unmuting characteristics for this personality from the choices below:

Standard	The radio unmutes audio when there is a valid PL (or DPL) signal, and mutes when the PL (DPL) signal is no longer present. Use this option for Carrier Squelch operation.
Unmute, Std Mute	The radio unmutes only when there is a valid PL (or DPL) signal AND there is a carrier strong enough to break squelch. The radio mutes when the PL (or DPL) signal is no longer present.
Unmute, OR Mute	The radio unmutes only when there is a valid PL (or DPL) signal AND there is a carrier strong enough to break squelch. The radio mutes when the PL (or DPL) signal is no longer present OR the squelch closes (weak carrier).

The default is Unmute or Mute.

Rx Unmute Delay

Use the UP/DOWN arrow keys to select a Receive Unmute Delay for this personality. This is the amount of time the radio waits to unmute after squelch has been detected. Eight choices between 0 (zero) and 1000 ms are available.

The default is 0 (zero) ms.

Reverse Burst TOC

Use the UP/DOWN arrow keys to enable/disable the Reverse Burst (PL), or turn-off code (DPL), to be transmitted after the radio is de-keyed. The Reverse Burst or turn-off code is used to signal the receiving radio that the transmission is ending and to indicate that audio must be

muted. By muting before the carrier drops, the noise burst (squelch tail) on the receiving end is substantially reduced.

The default is Enabled.

Squelch (Fine Tune)

Use the UP/DOWN arrow keys to adjust the Squelch Fine Tuning. This value is combined with the master squelch setting to determine the overall squelch for this personality. This feature can be used to tighten the squelch on frequencies that are experiencing interference while maintaining maximum sensitivity on all other frequencies. The valid range of values is 0 (zero) to 31 in increments of 1.

The default is 0 (zero).

User-Selectable PL (MPL)

If this feature is enabled, the radio will IGNORE the PL settings in the Conventional Personality Screen (Main->F4->F6->F3) for this personality.

Enabling the User-Selectable PL feature, also known as Multiple PL (MPL), will cause the radio to use the currently selected MPL Number for this personality's PL settings. The MPL Numbers can be created in the MPL List Configuration Screen (Main->F4->F6->F2->F2). The radio's currently selected MPL Number can be viewed and changed by pressing the MPL button appropriately.

Note: The currently selected MPL Number will be used for ALL conventional modes with the User-Selectable PL (MPL) feature enabled.

The factory default is Disabled.

Rx Emphasis

Use the UP/DOWN arrow keys to enable/disable Receive de-emphasis on this personality.

Pre-emphasis	Amplifies the higher frequencies so that, when they are transmitted, the signal-to-noise ratio is better.
De-emphasis	Reverses the pre-emphasis after the signal has been received.

The default is Rx De-emphasis Enabled.

Tx Emphasis

Use the UP/DOWN arrow keys to enable/disable Transmit Emphasis on this personality.

Pre-emphasis	Amplifies the higher frequencies so that, when they are transmitted, the signal-to-noise ratio is better.
De-emphasis	Reverses the pre-emphasis after the signal has been received.

The default is Tx Pre-emphasis Enabled.

Tx Deviation

Use the UP/DOWN arrow keys to select the Transmitter Deviation for this personality. This is the maximum amount that modulation can cause the carrier to deviate from its unmodulated frequency. The choices are:

2.5 kHz	VHF, UHF, and 800 MHz Band Analog (12.5 kHz Channel Spacing)
4.0 kHz	821 MHz Band (20 kHz Channel Spacing)
5.0 kHz	VHF, UHF, and 800 MHz Bands (30/25/25 kHz Channel Spacing)

Note: *The SECURE/Clear Strapping on the CONVENTIONAL SECURE PERSONALITY screen is forced to "Clear" if 2.5 kHz is selected.*

Tx Deviation T/A

This is a read-only field. It specifies the Tx deviation for Talkaround (Direct). This deviation will be the same as the normal Tx deviation.

Channel Spacing

Use the UP/DOWN arrow keys to select the Channel Spacing for this frequency range. End Frequency minus Start Frequency must be evenly divisible by the channel spacing so that the range can be divided into an integer value to assign the control channel number properly.

VRM100

This field will be visible only if the VRM100 Capable field is enabled on the RADIO WIDE OPTIONS screen (F4/F3/F2). Use the UP/DOWN arrow keys to enable/disable Conventional VRM100 data operation.

The default is Disabled.

VRM100 High Speed Data

This field will be visible only if the VRM100 Capable field on the RADIO WIDE OPTIONS (F4/F3/F2) screen and the VRM100 field on this screen are set to Enabled. Use the UP/DOWN arrow keys to enable the external device for fast rate data transfer using the VRM100 type interface with the radio.

The default is Disabled.

Conventional Personality RAC Options



From the MAIN MENU, press **F4**, **F6**, **F3**, **F9** and then **F7** to access this screen.

MOTOROLA Radio Service Software MCS Model:	Use UP/DOWN Arrows to Select Choice.								
...CHANGE/VIEW:CONV:PERS:OPTIONS:RAC									
Personality.....1 CONV PERS RAC OPTIONS ----- Repeater Access.....Enabled Tone Signalling System.....1 Access Type.....Manual RAB 1 Code Type.....Singletone RAB 1 Singletone (Hz).....1- 300.0 RAB 2 Code Type.....Singletone RAB 2 Singletone (Hz).....1- 300.0									
F1 HELP	F2	F3 PREV PERS	F4 NEXT PERS	F5	F6	F7	F8	F9	F10 EXIT

This screen contains all the personality specific RAC-related information. *The information contained in this screen will change depending on the current personality.* Press **Tab** to select the desired field, or press the desired function key (**F1 - F10**). If a field is highlighted, use the UP/DOWN arrow keys to select the desired choice or value.

MOTOROLA Radio Service Software MCS Model:	Use UP/DOWN Arrows to Select Choice.								
...CHANGE/VIEW:CONV:PERS:OPTIONS:RAC									
Personality.....1 CONV PERS RAC OPTIONS ----- Repeater Access.....Enabled Tone Signalling System.....1 Access Type.....Auto PTT Code Type.....MDC PTT MDC Repeater ID.....1- 0001									
F1 HELP	F2	F3 PREV PERS	F4 NEXT PERS	F5	F6	F7	F8	F9	F10 EXIT

For radios not equipped without RAC options

Function Key Descriptions

- F3 - PREV PERS** Accesses the previous personality.
- F4 - NEXT PERS** Accesses the next personality.

Field Definitions

Personality Use the UP/DOWN arrow keys, enter the system number directly, or use the **F3/F4** function keys to select the desired Conventional Personality.

Note: Refer to the Motorola Radio Catalog Sheets for the maximum number of personalities allowed for this model.

Repeater Access This option enables Repeater Access on this personality. Repeater Access is used to access a repeater. Typically, upon receiving the Repeater Access code word the repeater will remain in repeat mode until the hangtime expires.

Repeater Access can be one of the following:

Manual	The Repeater Access code word will be sent when the side button designated for Repeater Access is pressed; up to two side buttons can be designated for Repeater Access. The Repeater Access code word will also be sent automatically in prior to user-initiated data transmissions (that is, prior to Emergency, Status, or Message transmission).
Automatic	The Repeater Access code word will be sent preceding every user-initiated transmission. Repeater Access can be sent either as MDC Repeater Access code words or as a Single Tone transmission. The type of Repeater Access Selected will determine which Repeater Access list is available.

Tone Signalling System *This field will be visible only if the Repeater Access field is set to Enabled.* Use the UP/DOWN arrow keys to select the Tone Signalling System to be used by this personality.

The default is 1.

Access Type *This field will be visible only if the Repeater Access field is set to Enabled.* Use the UP/DOWN arrow keys to select the Repeater Access Type. Choices are Manual or Auto.

The default is Manual.

RAB 1 Code Type *This field will be visible only if the Repeater Access field is set to Enabled and the Access Type field is set to Manual.* Use the UP/DOWN arrow keys to select the type of Repeater Access Button operation. *Depending on your radio capabilities, choices will be Single Tone, DTMF or MDC.*

The default is Single Tone.

RAB 1 Singletone (Hz)/RAB 1 MDC Repeater ID/RAB 1 DTMF Code *This field will be visible only if the Repeater Access field is set to Enabled and the Access Type field is set to Manual.* For Single Tone and MDC, enter the index from the Single Tone List or the MDC Repeater ID List. For DTMF, enter the tone value; DTMF Tone values are 0 (zero) through 9, "*" and "#". Alternatively, the UP/DOWN arrow keys could be used to scroll through indexes/values.

The default is 300 Hz for Single Tone, 0 (zero) Hz for DTMF, and 1 Hz for MDC.

RAB 2 Code Type

This field will be visible only if the Repeater Access field is set to Enabled and the Access Type field is set to Manual. Use the UP/DOWN arrow keys to select the type of Repeater Access Button operation. Depending on your radio capabilities, choices will be Single Tone, DTMF, MDC or None.

The default is None.

RAB 2 Singletone (Hz)RAB 2
MDC Repeater ID/RAB 1 DTMF
Code

This field will be visible only if the Repeater Access field is set to Enabled, the Access Type field is set to Manual

For Single Tone and MDC, enter the index from the Single Tone List or MDC Repeater ID List. Alternatively, the UP/DOWN arrow keys could be used to scroll through indexes/values. For DTMF, enter the tone value. Valid DTMF tone values are 0 (zero) through 9, "*" and "#".

The default is 300 Hz for Single Tone, 0 (zero) Hz for DTMF, and 1 Hz for MDC.

PTT Code Type

This field will be visible only if the Repeater Access field is set to Enabled, and the Access Type field is set to Auto. Use the UP/DOWN arrow keys to select the Repeater Access Button operation. Depending on your radio capabilities, choices will be Single Tone, DTMF or MDC.

The default is Single Tone.

PTT Singletone/PTT MDC
Repeater ID/PTT DTMF Code

This field will be visible only if the Repeater Access field is set to Enabled and the Access Type field is set to Auto. For Single Tone and MDC, enter the index into tone table or repeater access ID table. For DTMF, enter the tone value. DTMF Tone values are 0 (zero) through 9, "" and "#". Alternatively, the UP/DOWN arrow keys could be used to scroll through indexes/values.*

The default is 300 Hz for Single Tone, 0 (zero) Hz for DTMF, and 1 Hz for MDC.

MDC Configuration Menu



From the MAIN MENU, press **F4**, **F6**, and then **F4** to access this screen.

MOTOROLA Radio Service Software MCS Model: MAIN:CHANGE/VIEW:CONV:MDC	Select Function F1 - F10.								
MDC CONFIGURATION MENU -----									
F1 - HELP F2 - F3 - MDC Systems F4 - MDC Call List Data F5 - MDC Repeater ID List F6 - F7 - F8 - F9 - F10 - EXIT									
F1 HELP	F2	F3 SYSTEM DATA	F4 CALL LIST	F5 REPEATER ID LIST	F6	F7	F8	F9	F10

This screen allows you to edit the MDC options for the radio.

Function Key Descriptions

F3 - SYSTEM DATA

Brings up a screen where you can configure the radio to work with various MDC systems.

F4 - CALL LIST

Brings up the MDC CALL ID LIST screen.

F5 - REPEATER ID LIST

Bring up screen that allows you to select or insert a Repeater ID.

MDC Systems



From the MAIN MENU, press **F4**, **F6**, **F4** and then **F3** to access this screen.

MOTOROLA Radio Service Software MCS Model:		Use UP/DOWN Arrows to Select Choice.							
MAIN:CHANGE/VIEW:CONV:MDC:SYSTEMS									
MDC System.....1									
MDC SYSTEMS -----									
Primary ID.....0001	Emergency.....Enabled								
Secondary ID.....00000000	Emergency Type....Alarm and Call								
Variable ID.....000	Emer PTT ID Sidetone....Enabled								
Leading PTT-ID.....Enabled	Acknowledge Alert Tone...Enabled								
PTT-ID Sidetone.....Enabled		Revert Table							
Trailing PTT-ID.....Enabled									
Radio Check.....Enabled									
Radio Inhibit.....Enabled		Num Zone Channel							
Status.....Enabled		-----							
Status Request.....Enabled		1	1 1						
Message.....Enabled		2	1 1						
		3	1 1						
F1	F2	F3	F4	F5	F6	F7	F8	F9	F10
HELP	ADD	PREV	NEXT	DELETE		MORE EMER		MORE	EXIT
	SYS	SYS	SYS	SYS		OPTIONS		OPTIONS	

This screen allows you to change or view parameters that pertain to an MDC system. Press **Tab** to select the desired field, or press the desired function key (**F1 - F10**). If a field is highlighted, use the UP/DOWN arrow keys to select the desired choice or value.

Function Key Descriptions

- F2 - ADD SYS** Adds a system.
- F3 - PREV SYS** Accesses the previous system.
- F4 - NEXT SYS** Accesses the next system.
- F5 - DELETE SYS** Deletes the selected MDC system. You will be prompted for confirmation before the system is actually deleted.
- F7 - MORE EMER OPTIONS** Brings up a screen where you can configure the MDC Emergency Feature parameters in addition to the ones located on the MDC SYSTEMS and MDC SYSTEM OPTIONS screens.
- F9 - MORE OPTIONS** Allows you to change or view additional MDC system field parameters.

Field Definitions

MDC System Use the UP/DOWN arrow keys to change the MDC system or directly enter the system number.

Primary ID Enter the four-digit hexadecimal for primary unit ID or use the UP/DOWN arrow keys to select a primary identification code from 1 to DEEE. *The digit F is not allowed in the ID.* The primary identification code (PID) is in Binary Coded Decimal (BCD) format and indicates which unit on the network sent the message. All out-bound messages will be sent with this identification code.

The default is 0001.

Secondary ID Enter a hexadecimal value or use the UP/DOWN arrow keys to select a secondary identification code from 0 (zero) to 0EEE EEEE for the terminal. *The digit F is not allowed in the ID.* This is the secondary ID assigned to the radio unit by the host.

The default is 0000 0000.

Variable ID Enter the ID directly. The Variable Unit ID is a three-digit hexadecimal number ranging from 0 (zero) to EEE. *The digit F is not allowed in the ID.* The Variable Unit ID is used to group radios so that several radios will decode the same Selective Call or Call Alert. On a system that uses fleets and groups, the first digit of the variable ID represents the fleet and the last two digits of the ID represent the group, that is,

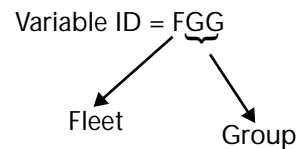

Leading PTT-ID Use the UP/DOWN arrow keys to enable/disable the unit identification data packet transmission at the beginning of each transmission (BOT). If this feature is enabled, the radio will automatically send the radio's unit identification code to the dispatcher each time the microphone PTT is pressed. If PTT-ID sidetones are enabled, a continuous alert tone will sound as soon as you press PTT and will continue until the data packet(s) has been sent. The user must wait until the tone stops before he or she begins talking.

The default is Enabled.

PTT-ID Sidetone *This field will be visible only if the leading PTT-ID field is set to Enabled.* Use the UP/DOWN arrow keys to enable/disable PTT-ID Sidetones. During transmission of data packets, the microphone and all voice transmission is automatically disabled. PTT-ID Sidetones are used to indicate to alert the user of end of transmission so that he or she may begin to talk.

If PTT-ID Sidetones are enabled, a continuous alert tone will sound as soon as the PTT is pressed and will continue until the data packet(s) has been sent. The user must wait until the tone stops before he or she begins talking.

The default is Enabled.

Trailing PTT-ID	<p>Use the UP/DOWN arrow keys to enable/disable the MDC unit identification data packet transmission at the end of each transmission (EOT). If the trailing PTT-ID feature is enabled and the microphone PTT is released, the radio will automatically send the radio's unit identification code to the dispatcher. <i>The PTT-ID Sidetone will NOT sound for trailing PTT-IDs.</i></p> <p>The default is Disabled.</p>
Radio Check	<p>Use the UP/DOWN arrow keys to enable/disable this feature. Enabling this option allows the dispatcher to check the state of the radio (that is, turned on or off), as long as the radio is within range of the system (clear mode).</p> <p>The default is Disabled.</p>
Radio Inhibit	<p>Use the UP/DOWN arrow keys to enable/disable this feature. The Radio Inhibit feature allows the radio to respond to a remote Inhibit signal which is essentially a shut-down command from the dispatcher. Upon receipt of this command, the radio transmits a quick acknowledgment to the dispatch equipment; it then goes into a dormant state during which the receiver audio is muted and the transmit audio path is blocked. In addition, all operator controls are rendered inoperative, channel scan is stopped on the operating Mode which received the command, and all LEDs are turned off. The radio will remain in this Inhibited state until it receives an Enable command. Alternatively, the radio may be uninhibited by reading and re-writing its codeplug with the RSS.</p> <p>The default is Disabled.</p>
Status	<p>This field indicates whether or not the Status feature is enabled. The Status feature, when enabled, allows the user to select and transmit a specific status from a list pre-programmed into the radio. A complete activation of the Status feature therefore includes first enabling the feature and then programming the desired status list to be made available to the user. Status list programming is performed from the STATUS ALIAS screen (F4/F6/F9).</p> <p>The default is Disabled.</p>
Status Request	<p><i>This field will be visible only if the Status field is set to Enabled.</i> Use the UP/DOWN arrow keys to enable/disable this feature. If Status Request is enabled, the radio responds to a remote status interrogation with the last attempted status. Disabling the feature prohibits the radio from responding to a remote status interrogation.</p> <p>The default is Disabled.</p>
Message	<p>Use the UP/DOWN arrow keys to enable/disable this feature. If this feature is enabled, the user can select and transmit a specific message from a list pre-programmed into the radio. A complete activation of the message feature therefore includes first enabling the feature and then programming the desired list of messages to be made available to the user. Message list programming is performed from the MESSAGE ALIAS screen (F4/F6/F8).</p> <p>The default is Disabled.</p>

Emergency

Use the UP/DOWN arrow keys to enable/disable this feature.

The default is Disabled.

Emergency Type

This field will be visible only if the Emergency field is set to Enabled. The following choices are available:

Alarm Only	<p>An emergency message is repeatedly sent to the base station until it is cancelled in one of the following ways:</p> <ul style="list-style-type: none"> <input type="checkbox"/> All the allowed retries (both polite and impolite) have been sent; <input type="checkbox"/> An acknowledgment is received from the base station; <input type="checkbox"/> A first PTT press is executed; or <input type="checkbox"/> A long press of the emergency button occurs.
Alarm & Call	<p>An emergency message is repeatedly sent to the base station until:</p> <ul style="list-style-type: none"> <input type="checkbox"/> All the allowed retries (both polite and impolite) have been sent; or <input type="checkbox"/> The radio receives an acknowledgment from the base station. <p>Once an acknowledgment is received from the base station, the user can talk to the base station. An emergency PTT ID will be sent with the voice on each PTT press. The emergency call is cancelled by a long press of the emergency button.</p>

Both types of emergency support reverting (transmitting emergency on a predetermined channel).

The default is Alarm Only.

Emer PTT ID Sidetone

This field will be visible only if the Emergency Type field is set to Alarm and Call. Use the UP/DOWN arrow keys to choose whether or not a sidetone must be sounded when the emergency ID is being sent.

The default is Enabled.

Acknowledge Alert Tone

This field will be visible only if the Emergency field is set to Enabled. Use the UP/DOWN arrow keys to enable/disable the emergency acknowledge beep which sounds when the radio receives acknowledgment of its emergency call.

The default is Enabled.

Zone & Channel

*This field will be visible only if the Emergency field is set to Enabled. This field is part of the Emergency Channel Revert table. The table contains the channels pointed to in the Conventional personalities to which the radio reverts when it enters emergency call mode. Enter the zone numbers and the channel numbers in the table. Each MDC personality will select one of these channels or choose itself. **Emergency revert channels must Conventional channels which are not receive-only, nor have Quik-Call II enabled on them.***

More Emergency Options



From the MAIN MENU, press **F4, F6, F4, F3** and then **F7** to access this screen.

MOTOROLA Radio Service Software MCS Model: ...CONV:MDC:SYSTEMS:MORE EMER OPT	Use UP/DOWN Arrows to Select Choice.								
MDC System.....1 <p style="text-align: center;">MORE EMERGENCY OPTIONS -----</p> MDC Hot Mic Emergency.....Enabled MDC Hot Mic Tx Period (sec).....10									
F1 HELP	F2	F3	F4	F5	F6	F7	F8	F9	F10 EXIT

This screen allows you to configure more MDC Emergency Options in addition to the ones located on the MDC SYSTEMS and MDC SYSTEM OPTIONS screens. Press **Tab** to select the desired field, or press the desired function key (**F1 - F10**). If a field is highlighted, use the UP/DOWN arrow keys to select the desired choice or value.

Field Definitions

MDC Hot Mic Emergency

Use the UP/DOWN arrow keys to enable/disable this feature. If this feature is enabled, this feature will activate the MDC Emergency Hot Mic Operation (also known as MDC Emergency with Voice to Follow). After one impolite transmission of emergency alarm, the radio will automatically drop into Emergency Call mode and begin transmitting with the microphone unmuted for the time specified by the MDC Hot Mic Tx Period.

The default is Disabled.

MDC Hot Mic Tx Period (sec)

This field will be visible only if the MDC Hot Mic Emergency field is set to Enabled. It determines the time period during which the radio will be transmitting with the microphone unmuted, but without user intervention. The MDC Hot Mic Tx Period may range from 10 to 120 seconds in increments of 10 seconds each.

The default is 10 seconds.

MDC System Options



From the MAIN MENU, press **F4**, **F6**, **F4**, **F3** and then **F9** to access this screen.

MOTOROLA Radio Service Software MCS Model:		Enter or Scroll to Select Value.							
...CONV:MDC:SYSTEMS:OPTIONS									
MDC System.....1									
MDC SYSTEM OPTIONS									

System Pretime (ms).....500		Emergency							
Preamble During Pretime...Enabled		Polite Retries.....5							
Inter-Packet Time (ms).....100		Impolite Retries.....15							
Limited Patience (sec).....60		Emer Prio Tx Inhibit.....Enabled							
DOS (Data Squelch).....Enabled		Emer Limited Patience (sec)...60							
Operation.....1200/1800 Hz		Global Tx Multiplier..... Enabled							
Coast Time (ms).....267.00		Tx Multiplier.....1							
Sel Call Reset.....Auto w/ Carr		RAC (Repeater Access Code)							
Auto Reset Time (sec).....5		Pretime (ms).....200							
		Ack Alert Tone.....Enabled							
		Preambles.....5							
		Sidetone..... Enabled							
F1	F2	F3	F4	F5	F6	F7	F8	F9	F10
HELP		PREV	NEXT					MDC SYS	EXIT
		SYS	SYS					REMOTE	

*The settings shown on this screen apply only to the MDC system numerically identified on the screen. This screen contains more options for MDC systems. Press **Tab** to select the desired field, or press the desired function key (**F1** - **F10**). If a field is highlighted, use the UP/DOWN arrow keys to select the desired choice or value.*

Function Key Descriptions

F3 - PREV SYS

Accesses the previous system.

F4 - NEXT SYS

Accesses the next system.

F9 - MDC SYS REMOTE

MDC SYS REMOTE - is used to change and view parameters associated with MDC System Remote Monitor/Radio Trace features.

Field Definitions

MDC System

Use the UP/DOWN arrow keys to change the MDC system or directly enter the system number.

System Pretime (ms)

Use the UP/DOWN arrow keys to choose a value or enter the desired value directly. This is the amount of pre-time used before the first MDC packet is transmitted. If an RAC packet is transmitted, then the system pre-time is used before the first MDC packet after the RAC packet. Valid entries range from 0 (zero) to 6350 ms in 50-ms increments.

The default is 400.

Preamble During Pretime

Use the UP/DOWN arrow keys to enable/disable the preamble sequence which will precede voice transmissions.

The default is Disabled.

Inter-Packet Time (ms) Use the UP/DOWN arrow keys to choose a value or enter the desired value directly. The inter-sequence pre-time is the period of time between consecutive MDC messages. Valid entries are in the range 0 (zero) to 6350 ms in 50-ms increments.

Note: Due to the rounding that occurs when preamble during pre-time is enabled, the value shown may change by 50 ms when a codeplug is read from a radio or file. *This adjustment occurs only in the Radio Service Software and not in the radio.*

The default is 100.

Limited Patience (sec) Use the UP/DOWN arrow keys to choose a value or enter the desired value directly. This is the amount of time that a polite MDC signal will be transmitted before an impolite signal is sent. The valid range of values is 1 to 255 seconds. A value of Infinite is also permitted.

The default is 60.

DOS (Data Squelch) Use the UP/DOWN arrow keys to enable/disable this feature. If this feature is enabled, the radio will be prevented from unmuting while data is being received.

The default is Enabled.

Operation *This field will be visible only if the DOS (Data Squelch) field is set to Enabled.* Use the UP/DOWN arrows to make your selection. This field allows for the adjustment of DOS operating criteria to either only 1800 Hz or to both 1800 Hz and 1200 Hz.

The default is 1200/1800 Hz.

Coast Time (ms) *This field will be visible only if the DOS (Data Squelch) field is set to Enabled.* Use the UP/DOWN arrow keys to choose a value or enter the desired value directly. This is the time delay during which the audio will remain muted after an MDC message has been received in its entirety. Valid entries range from 0 (zero) to 1134.75 in 4.45-ms increments.

The default is 267.

Sel Call Reset Use the UP/DOWN arrows to make your selection. This determines how the Select Call mode is reset after receiving a Select Call and the radio has unmuted. The radio will return from Carrier Squelch mode to Select Call packet required mode according to the value specified in this field.

Auto	Causes the reset to occur after the Sel Call Auto Reset timer has expired.
Auto w/ Car(rier)	Also causes the reset to occur after the reset timer has expired. However, the timer will resume any/each time a carrier (or voice) is detected.
Manual	Mode must be reset manually by pressing the Monitor button.

The default is Auto w/Car(rier).

Auto Reset Time (sec)	<p>Use the UP/DOWN arrow keys to choose a value or enter the desired value directly. This is the time duration for which the radio will remain in Carrier Squelch mode after it has received a Select Call directed to it. Once the Auto Reset Time has expired, the radio will reset to the Select Call squelch mode. The valid range of values is 0 (zero) to 255 seconds.</p> <p>The default is 5.</p>
Polite Retries	<p>Use the UP/DOWN arrow keys to choose a value or enter the desired value directly. This is the number of times the radio will attempt to transmit an MDC emergency message while no one else is transmitting. A polite attempt is one that transmits only when no one else is transmitting. The valid range of values is 0 (zero) to 14 seconds. A value of Infinite is also available.</p> <p>The default is 5.</p>
Impolite Retries	<p>Use the UP/DOWN arrow keys to choose a value or enter the desired value directly. This is the number of times that the radio will attempt to transmit an emergency message even if someone else is transmitting. An impolite attempt is one that is transmitted regardless of whether or not someone else is transmitting. The valid range of values is 1 to 15 seconds.</p> <p>The default is 15.</p>
Emer Prio(rity) Tx Inhibit	<p>Use the UP/DOWN arrow keys to enable/disable this feature. If this feature is enabled, all other radios on the system will decode the Emergency Acknowledgment or the Emergency PTT code word and inhibit its transmitter for the time required for the acknowledgment or until the receive carrier goes away respectively.</p> <p>The user's call request has priority over all other types of call traffic. The radio will transmit voice and an Emergency Code Word if:</p> <ul style="list-style-type: none"> <input type="checkbox"/> the user presses the PTT button; or <input type="checkbox"/> the dispatcher's alarm acknowledge has a command to remotely key up. <p>The default is Disabled.</p>
Emergency Limited Patience (sec)	<p><i>This field will be visible only if the Emer Prio(rity) Tx Inhibit field is set to Enabled.</i> Use the UP/DOWN arrow keys to choose a value or enter the desired value directly. When the radio is in Emergency Call Mode, this is the amount of time the radio will wait before impolitely transmitting voice if voice transmission is inhibited by the Emergency Priority Inhibit feature. The valid range of values is 0 (zero) to 255 seconds.</p> <p>The default is 60.</p>

Global Tx Multiplier	<p>Use the UP/DOWN arrow keys to enable/disable this feature. Enabling this feature causes the default Tx Multiplier field value to double. This effectively doubles how long the transmitter will key after the radio exhausts all retries without receiving an Ack during Emergency Call. If this feature is disabled, no doubling of the Tx Multiplier field value will occur.</p> <p>The default is Disabled.</p>
Tx Multiplier	<p>Use the UP/DOWN arrow keys to choose a value or enter the desired value directly. This value indicates how long the transmitter will key after the radio exhausts all retries without receiving an Ack during Emergency Call. This value is multiplied by the radio's base time. The valid range of values is 0 (zero) to 3.</p> <p>The default is 1.</p>
RAC (Repeater Access Code)	<p>Allows the user to send a repeater ID to select a repeater either manually or automatically. Manual repeater access (MRAC) requires the operator to select and send a repeater access codeword (RAC) prior to voice transmissions with</p>
Pretime (ms)	<p>This is the amount of pretime used before the first MDC Repeater Access Code (RAC) packet is transmitted. Valid entries are 0 to 6350 ms in steps of 50 ms. The factory default is 200 ms.</p>
Ack Alert Tone	<p>If this field is enabled, when a Repeater Access Code (RAC) packet is transmitted, the repeater will indicate acceptance of the packet by causing the radio to sound 4 beeps. The factory default is Disabled.</p>
Preambles	<p><i>This is a view only field.</i></p>
Sidetone	<p>If this field is enabled, the radio will generate a sidetone upon Automatic Repeater Access Code transmission to warn the user not to talk until the transmission is complete.</p>

MDC System Remote Options

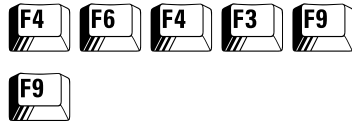

From the MAIN MENU, press **F4, F6, F4, F3, F9** and then **F9** to access this screen.

MOTOROLA Radio Service Software MCS Model:		Enter or Scroll to Select System.
...MDC:SYSTEMS:OPTIONS:REM OPTIONS		
MDC System.....1 <div style="text-align: center;"> MDC SYSTEM REMOTE OPTIONS ----- Remote Mon/Radio Trace.....Enabled Remote Radio Mode..Remote Monitor Tx Base Time (sec).....10 Rx Base Time (sec).....10 </div>		
F1 HELP	F2	F3 PREV SYS
F4 NEXT SYS	F5	F6
F7	F8	F9
F10 EXIT		

This screen allows you to change/view parameters pertaining to the MDC system remote capabilities of the radio.

Function Key Descriptions

F3 - PREV SYS

Is used to navigate to the previous MDC System while remaining in the same data field.

F4 - NEXT SYS

NEXT SYS is used to navigate to the next MDC System while remaining in the same data field.

Field Definitions

MDC System

This is the number of the MDC system. Use the UP/DOWN arrow keys to change the system, or directly enter the number of the system.

Remote Mon/Radio Trace

Use the UP/DOWN arrow keys to enable/disable the MDC Remote Monitor/Radio Trace feature. When the MDC Remote Monitor/Radio Trace feature is enabled, the radio will be able to decode an MDC Remote Monitor or Radio Trace command sent from the dispatch console. After decoding this command, the radio will key-up its transmitter for a time period calculated using the 'Tx Base Time' and another value embedded within the Remote Monitor/Radio Trace command. The factory default is Disabled.

Remote Radio Mode

Use the UP/DOWN arrow keys to select the MDC Decode Operation. The MDC Decode Operation allows the radio to operate in one of two possible states when it decodes an MDC Remote Monitor/Radio Trace command:

- Radio Trace - The radio will automatically key-up sending unmodulated carrier.
- Remote Monitor - The radio will automatically key-up and unmute the microphone thus sending voice on the channel.

Tx Base Time (sec) Use the UP/DOWN arrow keys to select the desired MDC Tx Base Time. The value may also be entered directly. The MDC Tx Base Time is a value used to calculate the period that a radio will key-up after receiving an MDC Remote Monitor/Radio Trace command. This Tx Base Time is multiplied by a second value that is sent from the dispatch console and transmitted to the radio via an MDC Remote Monitor/Radio Trace command. The range is from 10 to 120 seconds in 10 second increments.

Rx Base Time (sec) Use the UP/DOWN arrow keys to select the desired MDC Tx Base Time. The value may also be entered directly. The MDC Rx Base Time is a value used to calculate the period that a radio will 'listen' after keying-up while it is in the Remote Monitor mode. This Rx Base Time is multiplied by a second value that is sent from the dispatch console and transmitted to the radio via a Remote Monitor/Radio Trace command. The range is from 10 to 120 seconds in 10 second increments.

MDC Call List Table

From the MAIN MENU, press **F4**, **F6**, and then **F7** to access this screen.



MOTOROLA Radio Service Software MCS Model:					Enter or Scroll to Select Value.				
...CHANGE/VIEW:CONV:MDC:MDC CALL LIST									
CALL LIST TABLE -----									
#	Call ID	Call Text	#	Call ID	Call Text				
-	-----	-----	-	-----	-----				
1	----	CALL 1							
F1	F2	F3	F4	F5	F6	F7	F8	F9	F10
HELP	ADD			DELETE					EXIT
	CALL ID			CALL ID					

This screen is used to edit Conventional MDC Call IDs and their associated names or aliases. The ID entries in this table are stored in the radio and made available to the radio user in Selective Call or Call Alert operation. For radio models capable of supporting multiple MDC Systems, the Call list defined here is made available to all MDC Systems.

An MDC Call ID is either an Individual Call ID or a Group Call ID. The RSS interprets each entry which begins with the hexadecimal digit "E" as a Group ID. Call IDs beginning with a digit other than "E" are treated as Individual IDs. In addition, the number of characters for the ID alias labelled "Call Text" is automatically determined according to the display capability of the radio.

Function Key Descriptions

F2 - ADD CALL ID

Adds a Call ID.

F5 - DELETE CALL ID

Deletes the highlighted Call ID. You will be prompted for confirmation before the ID is actually deleted.

Field Definitions

Call ID

Enter the four-digit (hexadecimal) MDC CALL ID comprised of hexadecimal digits “A” through “F” for this member of the call list. The Call ID is used to target a radio when an individual or group call has to be sent to that radio or set of radios. The valid range of values is 1 through FFFF.

A Call ID preceded by the hexadecimal digit “E” is interpreted by the RSS as a Group ID. *IDs of the form “Exxx” (where x implies any hexadecimal digit) should therefore be avoided for Individual/Primary ID specification.* Note also that the digit “F” serves as a wild-card character; it can be strategically placed in a Call ID to make it match other Call IDs thus creating the effect of a group ID. The string “FFFF” would for instance specify all radios in system.

Call Text

Enter the alphanumeric name for this Call ID. This name will appear on the radio display to facilitate ease of operation.

MDC Repeater ID



From the MAIN MENU, press **F4**, **F6**, **F4** and then **F5** to access this screen.

MOTOROLA Radio Service Software MCS Model:		Enter ID (Only 0-9 Digits Allowed).	
MAIN:CHANGE/VIEW:CONV:MDC:RPTR ID			
MDC REPEATER ID -----			
#	Repeater ID	#	Repeater
--	-----	--	-----
1	0001		
F1	F2	F3	F4
HELP	ADD		DELETE
	ID		ID
F5	F6	F7	F8
F9	F10		
	EXIT		

The MDC Repeater Access Code (RAC) Transmission will be targetted to the listed Repeater IDs.

Function Key Descriptions

F2 - ADD CALL ID

Adds an ID.

F5 - DELETE CALL ID

Deletes the current ID.

Field Definitions

Repeater ID

Use the UP/DOWN Arrow Keys to select or directly enter the desired ID of the Repeater. Valid Entries are from 0001 to 9999 in increments of 1. A Maximum of 16 IDs is allowed.

Auxiliary Menu



From the MAIN MENU, press **F4**, **F6**, and then **F7** to access this screen.

MOTOROLA Radio Service Software MCS Model: MAIN:CHANGE/VIEW:CONV:AUX	Select Function F1 - F10.								
AUXILARY SYSTEMS MENU -----									
F1 - HELP F2 - Singletone Systems F3 - Singletone List F4 - Quik-Call II Systems F5 - GE STAR Systems F6 - F7 - F8 - F9 - F10 - EXIT									
F1 HELP	F2 SINGLE SYSTEM	F3 SINGLE TONES	F4 QUIK CALL-II	F5 GE STAR SYSTEM	F6	F7	F8	F9	F10 EXIT

This menu contains the advanced Conventional signalling features other than MDC.

Function Key Descriptions

F2 - SINGLE SYSTEM
(Singletone System)

Brings up the SINGLETONE SYSTEM screen. The Single Tone feature allows the capability to selectively access repeaters. The Single Tone Systems defined from this screen can be specified in the CONV PERS RAC OPTIONS screen (**F4/F6/F3/F9/F7**) by setting the Repeater Access field to Enabled.

F3 - SINGLE TONES
(Single Tones List)

Brings up the SINGLE TONE LIST screen which contains the programmable tone frequencies for the Single Tone Feature.

F4 - QUIK-CALL II

Brings up the QUIK-CALL II SYSTEM screen. The Quik-Call II feature provides a decoding method for the radio to unmute when receiving the proper tones programmed in the systems. The systems defined from this option can be chosen in the CONVENTIONAL PERSONALITY screen (**F4/F6/F3**) under the following conditions:

1. *If GE STAR is used as the signalling type, DOS must be disabled in the specified GE STAR system; and*
2. *If MDC is used as the signalling type, DOS and MDC Demodulator need to be disabled.*

F5 - GE STAR SYSTEM

Brings up the GE STAR SYSTEM screen. GE STAR is a signalling protocol which provides such features as Data Operated Squelch (DOS), Emergency Alarm, and PTT-ID. The GE STAR systems defined from this menu option can be specified in the CONVENTIONAL PERSONALITY screen (**F4/F6/F3**) when GE STAR is selected for the signalling field.

Single Tone Systems



From the MAIN MENU, press **F4**, **F6**, **F7** and then **F2** to access this screen.

MOTOROLA Radio Service Software MCS Model: ...CONV:AUX:SINGLETONE SYSTEM	Enter or Scroll to Select System.								
System..... 1 SINGLETONE SYSTEM ----- Tone Pretime (ms).....250 Tone Duration (ms).....500 PTT Sidetone.....Enabled RAB Sidetone.....Enabled									
F1 HELP	F2 ADD SYS	F3 PREV SYS	F4 NEXT SYS	F5 DELETE SYS	F6	F7	F8	F9	F10 EXIT

This screen allows you to change/view the parameters that pertain to a Single Tone System. Press **Tab** to select the desired field, or press the desired function key (**F1 - F10**). If a field is highlighted, use the UP/DOWN arrow keys to select the desired choice or value.

Function Key Descriptions

F2 - ADD SYS

Adds a system.

F3 - PREV SYS

Accesses the previous system.

F4 - NEXT SYS

Accesses the next system.

F5 - DELETE SYS

Deletes a system. You will be prompted for confirmation before the system is actually deleted.

Field Definitions

System

Use the UP/DOWN arrow keys to select the desired Single Tone system, enter the system number directly, or use the **F3/F4** function keys to scroll through the available systems. *The radio may have a maximum of 16 systems.*

Tone Pretime (ms)

Use the UP/DOWN arrow keys to select or directly enter the desired value. The Tone Pretime for Tone Signalling specifies the length of time that “dead” carrier is transmitted between the initiation of the Tone (RAC) transmission and the actual Tone (RAC) transmission. The valid range of values is 25 to 6375 ms in 25-ms increments.

The default is 250.

Tone Duration (ms)	<p>Use the UP/DOWN arrow keys to select or directly enter the desired value. Upon expiration of the Single Tone Pretime period, the Single Tone will be encoded onto the carrier for the duration of the value specified in this field. The valid range of values is 25 to 6375 ms in 25-ms increments.</p> <p>The default is 500 ms.</p>
PTT Sidetone	<p>Use the UP/DOWN arrow keys to enable/disable this feature. When the PTT button is pressed, the radio will generate a continuous sidetone during transmission of the Automatic Repeater Access code word (RAC) preceding a voice transmission under the following conditions:</p> <ol style="list-style-type: none"> <i>1. This field is set to Enabled;</i> <i>2. Repeater Access is set to Enabled; and</i> <i>3. The Repeater Access Type is set to Automatic RAC.</i> <p>The default is Enabled.</p>
RAB Sidetone	<p>Use the UP/DOWN arrow keys to enable/disable this feature. If this field is set to Enabled, a continuous sidetone will sound during transmission of the Manual Repeater Access code word (MRAC) when MRAC is initiated via Repeater Access Button (RAB) #1 or RAB #2. Termination of the RAB Sidetone indicates that transmission of the RAC is complete and that the user that he or she may begin talking.</p> <p>The default is Enabled.</p>

Single Tone List



From the MAIN MENU, press **F4**, **F6**, **F7** and then **F3** to access this screen.

MOTOROLA Radio Service Software MCS Model: ...CONV:AUX:SINGLE TONE LIST	Enter or Scroll to Select Frequency.		
SINGLE TONE LIST -----			
#	Tone (Hz)	#	Tone (Hz)
-	-----	-	-----
1	300.0		

F1	F2	F3	F4	F5	F6	F7	F8	F9	F10
HELP	ADD			DELETE					EXIT
	TONE			TONE					

This screen pertains to the Single Tone list. Press **Tab** to select the desired field, or press the desired function key (**F1 - F10**). If a field is highlighted, use the UP/DOWN arrow keys to select the desired choice or value.

Function Key Descriptions

F2 - ADD TONE

Adds a tone (Hz).

F5 - DELETE TONE

Deletes the current tone. You will be prompted for confirmation before the tone is actually deleted.

Field Definitions

Tone (Hz)

Use the UP/DOWN arrow keys to select the desired tone frequency or enter a value directly. The defined tones can be used on a personality-by-personality basis in the CONV PERS RAC OPTIONS screen (**F4/F6/F3/F9/F7**) by setting the Repeater Access field to Enabled. The field "Single Tone (Hz)" should contain a tone from this list. The valid range of values is 300 to 3000 Hz in 0.1-Hz increments.

The default is 300 Hz.

Signalling Muting Type

Use the UP/DOWN arrow keys to scroll through the available selections. This field dictates the Signalling Muting Type to be used during Quik-Call II operations:

AND	Both Signalling Unmuting (Quik-Call) and Radio Unmuting must be satisfied for the radio to unmute.
OR	Either Signalling Unmuting (Quik-Call) or Radio Unmuting must be satisfied for the radio to unmute.

The default is AND.

Initial Squelch Type

This is a view-only field which will be visible only if the Signalling Muting Type field is set to AND.

Reset Type

Use the UP/DOWN arrow keys to scroll through the available selections. This field dictates the Quik-Call II Call Reset Type to be used: Manual or Auto. When Manual Reset is selected, a Monitor button is required for proper Quik-Call II operation.

The default is Auto.

Auto Reset Carr Ovrdr

Use the UP/DOWN arrow keys to scroll through the available selections. When this feature is enabled, the Auto Reset Duration will be re-loaded into the Auto Reset Timer when the radio mutes.

The default is Enabled.

Auto Reset Duration (sec)

Use the UP/DOWN arrow keys to scroll or directly enter the desired value. This field determines the maximum amount of uninterrupted time spent in Release Squelch Mode. When this duration expires, the radio will exit Release Squelch Mode and enter Quik-Call II Squelch Mode. Integer values from 1 to 255 are allowed.

The default is 5.

Decoder 1 Call Type

Use the UP/DOWN arrow keys to scroll through the available selections. This field dictates the Decoder 1 Call Type: Individual or Group.

Note: When Group is selected, a steady beep will be heard when a call is decoded. When Individual is selected, an intermittent beep will be heard when a call is decoded.

The default is Individual.

Decoder 2 Call Type

Use the UP/DOWN arrow keys to scroll through the available selections. This field dictates the Decoder 2 Call Type: Individual or Group.

Note: When Group is selected, a steady beep will be heard when a call is decoded. When Individual is selected, an intermittent beep will be heard when a call is decoded.

The default is Group.

Decoder Option

Use the UP/DOWN arrow keys to scroll through the available selections. This field controls the number of decoders (1 or 2) and the decode sequences to be used on this Quik-Call II system. The available selections are:

(1) A-B

(1) A-B, (2) A-C

(1) A-B, (2) C-B

(1) A-B, (2) B

(1) A-B, (2) C

(1) A-B, (2) C-D

The default is (1) A-B.

Long Tone Duration

This field will be visible only if the Decoder Option field is set to (1) A-B, (2) C or (1) A-B, (2) B. Use the UP/DOWN arrow keys to scroll or directly enter the desired value. This is the duration that a tone has to last in order for it to be considered a valid long tone. This value may range from 4 to 10 seconds in 100-ms increments.

The default is 4.

Frequency (Hz)

Use the UP/DOWN arrow keys to scroll or directly enter the available tones. This field represents the frequency of the audible tone in 0.1-Hz increments. Values ranging from 288.5 to 3010.0 in 0.1 Hz increments are valid.

Code

Use the UP/DOWN arrow keys to scroll or directly enter the desired code. This field contains a code that represents a Quik-Call II Tone frequency. *Codes vary depending on the type of Signalling system selected.*

Quik-Call II System Options



From the MAIN MENU, press **F4**, **F6**, **F7**, **F4** and then **F9** to access this screen.

MOTOROLA Radio Service Software MCS Model: ...AUX:QUIK-CALL II SYSTEM:OPTIONS	Enter or Scroll to Select System.								
System.....1 <p style="text-align: center;">QUIK-CALL II SYSTEM OPTIONS -----</p> Inter-Tone Duration (sec).....2.0 Observ Window Dur (cycles).....B400 Detections Required.....6									
F1 HELP	F2	F3 PREV SYS	F4 NEXT SYS	F5	F6	F7	F8	F9	F10 EXIT

*A system or FTR key is required to access this screen. This screen allows you to change/view additional Quik-Call II system parameters. Press **Tab** to select the desired field, or press the desired function key (**F1 - F10**). If a field is highlighted, use the UP/DOWN arrow keys to select the desired choice or value.*

Function Key Descriptions

F3 - PREV SYS

Accesses the previous Quik-Call system.

F4 - NEXT SYS

Accesses the next Quik-Call system.

Field Definitions

System

Use the UP/DOWN arrow keys to select the desired Quik-Call II system. You may enter a number directly or make your selection using the **F3/F4** function keys. *The radio may have a maximum number of 15 systems.*

Inter-Tone Duration (sec)

Use the UP/DOWN arrow keys to scroll through the available choices or directly enter the desired value. This is the maximum time duration allotted to detect the second tone of a two-tone sequence. This time period begins with the detection of the first tone of the sequence. The valid range of values is 1 to 6 seconds in 100-ms increments.

The default is 2 seconds.

Observ Window Dur (cycles)

Use the UP/DOWN arrow keys to scroll through the available choices or directly enter the desired value. This field is used to specify the number of clock cycles in an observation window divided by four. This calculation is used to keep the value within an integer size field.

The default is B400.

Detections Required

Use the UP/DOWN arrow keys to scroll through the available choices or directly enter the desired value. This field dictates the number of valid tone detections (per observation window) required within the last 8 observation windows to qualify a Quik-Call II tone detection. Valid values are integers ranging from 1 to 7.

The default is 6.

GE STAR System



From the MAIN MENU, press **F4**, **F6**, **F7** and then **F5** to access this screen.

MOTOROLA Radio Service Software MCS Model:	Use UP/DOWN Arrows to Select Choice.
..CHANGE/VIEW:CONV:AUX:GE STAR SYSTEM	
System.....1	
GE STAR SYSTEM -----	
Addressing Mode.....Extended	Emergency Alarm..... Enabled
Radio ID.....0000	Monitor w Sil Emer.....Disabled
PTT ID Type.....Leading	Impolite Retries.....10
PTT ID Sidetone.....Enabled	
Pretime Duration (ms).....500	Revert Table
Baud Rate.....400 bps	
DOS.....Enabled	Num Zone Channel
Unmute Hold-Off (ms).....550	-----
Coast Time (ms).....100	1 Blank Blank
	2 Blank Blank
	3 Blank Blank
F1 HELP	F2 ADD SYS
F3 PREV SYS	F4 NEXT SYS
F5 DELETE SYS	F6
F7	F8
F9	F10 EXIT

This screen allows you to change/view the parameters that pertain to a GE STAR system. Press **Tab** to select the desired field, or press the desired function key (**F1 - F10**). If a field is highlighted, use the UP/DOWN arrow keys to select the desired choice or value.

Function Key Descriptions

F2 - ADD SYS

Adds a system.

F3 - PREV SYS

Accesses the previous system.

F4 - NEXT SYS

Accesses the next system.

F5 - DELETE SYS

Deletes a system. You will be prompted for confirmation before the system is actually deleted.

Field Definitions

System

Use the UP/DOWN arrow keys to select the desired GE STAR system. or entered a number directly. You may also use the function keys to scroll through the available choices. *The radio may have a maximum number of 7 systems.*

Addressing Mode

Use the UP/DOWN arrow keys to select Normal or Extended. The state of this field determines the range of valid IDs that the radio can use. Specifies the GE STAR addressing mode for the Radio ID.

The default is Disabled.

Radio ID	<p>Use the UP/DOWN arrow keys to scroll or directly enter the Radio ID. This field specifies the ID of the radio in decimals. For normal addressing mode, valid radio IDs range from 0 (zero) to 2047. For the extended addressing mode, valid radio IDs range from 0 (zero) to 9999. This ID is used for both PTT-ID and Emergency Alarm data transmissions.</p> <p>The default is 0000.</p>
PTT-ID Type	<p>Use the UP/DOWN arrow keys to make a selection. The value in this field specifies the placement of the PTT-ID data in a GE STAR transmission. The PTT-ID Data can be sent using one of the following methods:</p> <ul style="list-style-type: none"> <input type="checkbox"/> Immediately after a PTT press and before voice (Leading); <input type="checkbox"/> Immediately after a PTT release and after voice (Trailing); or <input type="checkbox"/> Both immediately after a PTT press and PTT release (Lead/Trail). <p>The default is Disabled.</p>
PTT-ID Sidetone	<p><i>This field will be visible only if the PTT-ID Type field is set to a value other than Disabled.</i> Use the UP/DOWN arrow keys to enable/disable this feature. This field specifies whether or not the radio generates a sidetone when sending leading GE STAR PTT-ID data.</p> <p>The default is Enabled.</p>
Pretime Duration (ms)	<p>Use the UP/DOWN arrow keys to scroll or directly enter the desired duration. This field specifies the duration of the pre-time transmission preceding the PTT-ID and Emergency GE STAR data. The range is 0 (zero) to 2000 ms in 25-ms increments.</p> <p>The default is 500.</p>
Baud Rate	<p>Use the UP/DOWN arrow keys to select 400 bps or 800 bps. This field specifies the baud rate of the GE STAR data in bits per second.</p> <p>The default is 400 bps.</p>
DOS	<p>Use the UP/DOWN arrow keys to enable/disable the Data Operated Squelch (DOS) feature for this system.</p> <p>The default is Enabled.</p>
Unmute Hold-Off (ms)	<p><i>This field will be visible only if the DOS field is set to Enabled.</i> Use the UP/DOWN arrow keys to scroll through the available choices or enter the desired time directly. The range is 25 through 2550 in 25-ms increments. This field specifies the duration that the radio waits with speaker muted for a DOS detect after a carrier is first detected.</p> <p>The default is 550.</p>

Coast Time (ms)	<p><i>This field will be visible only if the DOS field is set to Enabled.</i> Use the UP/DOWN arrow keys to scroll through the available choices or directly enter the desired time. This field specifies the duration that the radio waits with speaker muted after DOS detect has been lost but prior to unmuting. The range is 0 (zero) through 500 in 25-ms increments.</p> <p>The default is 100.</p>
Emergency Alarm	<p>Use the UP/DOWN arrows to select enable/disable GE STAR Emergency Alarm.</p> <p>The default is Disabled.</p>
Monitor w/Sil Emer	<p><i>This field will be visible only if the Emergency Alarm field is set to Enabled.</i> Use the UP/DOWN arrows to enable/disable this feature. This function allows the monitor button to function during silent emergency.</p> <p>The default is Disabled.</p>
Impolite Retries	<p><i>This field will be visible only if the Emergency Alarm field is set to Enabled.</i> Use the UP/DOWN arrows to scroll or enter the desired value directly. This field specifies the number of impolite Emergency Alarm packets that the radio will send. The valid range of values is 1 to 255.</p> <p>The default is 10.</p>
Zone	<p><i>This field will be visible only if the Emergency Alarm field is set to Enabled.</i> Use the UP/DOWN arrows to scroll through the available zones. This table specifies three Conventional zone/channel combinations that the selected Conventional zone/channel can use (or revert to) when initiating GE STAR Emergency Alarm transmissions. The radio remains on the revert channel only for the duration of the Emergency Alarm transmissions.</p>
Channel	<p><i>This field will be visible only if the Emergency Alarm field is set to Enabled.</i> Use the UP/DOWN arrows to scroll through the available channels or enter the number of the desired channel directly. This table specifies three Conventional zone/channel combinations that the selected Conventional zone/channel can use (or revert to) when initiating GE STAR Emergency Alarm transmissions. The radio remains on the revert channel only for the duration of the Emergency Alarm transmissions.</p>

Conventional Message Alias List



From the MAIN MENU, press **F4**, **F6**, and then **F8** to access this screen.

MOTOROLA Radio Service Software MCS Model:		Enter or Scroll to Select Value.							
..CHANGE/VIEW: CONV: MESSAGE ALIAS LIST									
CONV MESSAGE ALIAS LIST -----									
Entry	Message Alias Number	Message Alias Text							

1	1	MESSAGE 1							
2	2	MESSAGE 2							
3	3	MESSAGE 3							
4	4	MESSAGE 4							
5	5	MESSAGE 5							
6	6	MESSAGE 6							
7	7	MESSAGE 7							
8	8	MESSAGE 8							
F1 HELP	F2 ADD MESSAGE	F3	F4	F5 DELETE MESSAGE	F6	F7	F8	F9	F10 EXIT

This screen contains the Conventional Message Alias List and is used to view and edit the Message Alias number and corresponding text. Press **Tab** to select the desired field, or press the desired function key (**F1 - F10**). If a field is highlighted, use the UP/DOWN arrow keys to select the desired choice or value.

Function Key Descriptions

F2 - ADD MESSAGE

Allows you to add a message to the list.

F5 - DELETE MESSAGE

Allows you to delete a message from the list. You will be prompted for confirmation before the message is actually deleted.

Field Definitions

Message Alias Number

The Message Alias Number will match the message entry number in most cases. However, if the first entry in the list should cause the fourth message to be sent, then four should be assigned to the Message Alias Number of entry 1.

The default for the Message Alias Number matches the message entry number.

Message Alias Text

Enter the ASCII text for the message to be displayed for each of the Message Alias Text fields. *The size of the message will be display-dependent.*

The default will be either MSG X or MESSAGE X, where X is the entry number, *depending on the display type of the radio.*

Conventional Status Alias List



From the MAIN MENU, press **F4**, **F6**, and then **F9** to access this screen.

MOTOROLA Radio Service Software MCS Model:		Enter or Scroll to Select Value.
...CHANGE/VIEW:CONV:STATUS ALIAS LIST		
CONV STATUS ALIAS LIST -----		
Entry	Status Alias Number	Status Alias Text

1	1	STATUS 1
2	2	STATUS 2
3	3	STATUS 3
4	4	STATUS 4
F1	F2	F3
F4	F5	F6
F7	F8	F9
F10		
HELP	ADD STATUS	DELETE STATUS
		EXIT

This screen contains the Conventional Status Alias List and is used to view and edit the Status Alias Number and Status Alias Text. Press **Tab** to select the desired field, or press the desired function key (**F1 - F10**). If a field is highlighted, use the UP/DOWN arrow keys to select the desired choice or value.

Function Key Descriptions

F2 - ADD STATUS

Allows you to add a status alias to the list.

F5 - DELETE STATUS

Allows you to delete a status alias from the list. You will be prompted for confirmation before the status alias is actually deleted.

Field Definitions

Status Alias Number

The Status Alias Number will match the status entry number in most cases. However, if the first entry in the list should cause the fourth status to be sent, then 4 should be assigned to the Status Alias Number of entry 1.

The default for the Status Alias Number matches the status entry number.

Status Alias Text

Enter the ASCII text for the message to be displayed. *The size of the status is display-dependent.* This field contains the ASCII text for each of the Status Alias Text Fields.

The default will be either STS X or STATUS X, where X is the entry number, *depending on the display type of the radio.*

Field Definitions

Zone Number	Use the UP/DOWN arrow keys to select the desired zone. The number may also be entered directly.
Zone Name	Each zone may be assigned an alphanumeric name. The number of characters allotted for the zone name versus the channel name is defined on the RADIO WIDE DISPLAY OPTIONS screen (F4/F3/F6). The zone name will appear to the left of the channel name on the radio display. <i>For single-zone radios, the zone name is optional.</i>
Channel Number	<i>This is a read-only field.</i> A channel number refers to the position in the list which a particular member occupies. Depending on the radio model and configuration, channel selection may be via the rotary switch, the toggle switch, or the keypad.
Channel Name	Each channel may be assigned an alphanumeric name. The number of characters allotted for the channel name versus the zone name is defined on the RADIO WIDE DISPLAY OPTIONS screen (F4/F3/F6). The channel name will appear to the right of the zone name on the radio display.
Personality Type	Use the UP/DOWN arrow keys to select either a Conventional or Trunked personality for each zone member. Both types may be assigned within a single zone. Note: <i>Personalities must be defined before they can be assigned on this screen.</i> Trunking personalities are entered on the TRUNKING PERSONALITY screen (F4/F4/F4), and Conventional personalities are entered on the CONVENTIONAL PERSONALITY screen (F4/F6/F3).
Personality Number	Use the UP/DOWN arrow keys to select the personality number for this channel. The number may also be entered directly. Note: <i>Personalities must be defined before they can be assigned on this screen.</i> Trunking personalities are entered on the TRUNKING PERSONALITY screen (F4/F4/F4) and Conventional personalities are entered on the CONVENTIONAL PERSONALITY screen (F4/F6/F3).

Print Menu Functions

The print function is used to produce permanent records of codeplug configurations. A printer is required and should be connected to your computer according to instructions in the user's manual that came with your computer. Graphics capability is NOT required. *In order to print radio configuration data, you must first read or retrieve a codeplug file using the GET/SAVE MENU and related screens.*

Each print-out will contain the following data in addition to configuration information: radio model and serial number information, software version numbers, RSS version numbers, and the date and time of the print-out.

Menu Map

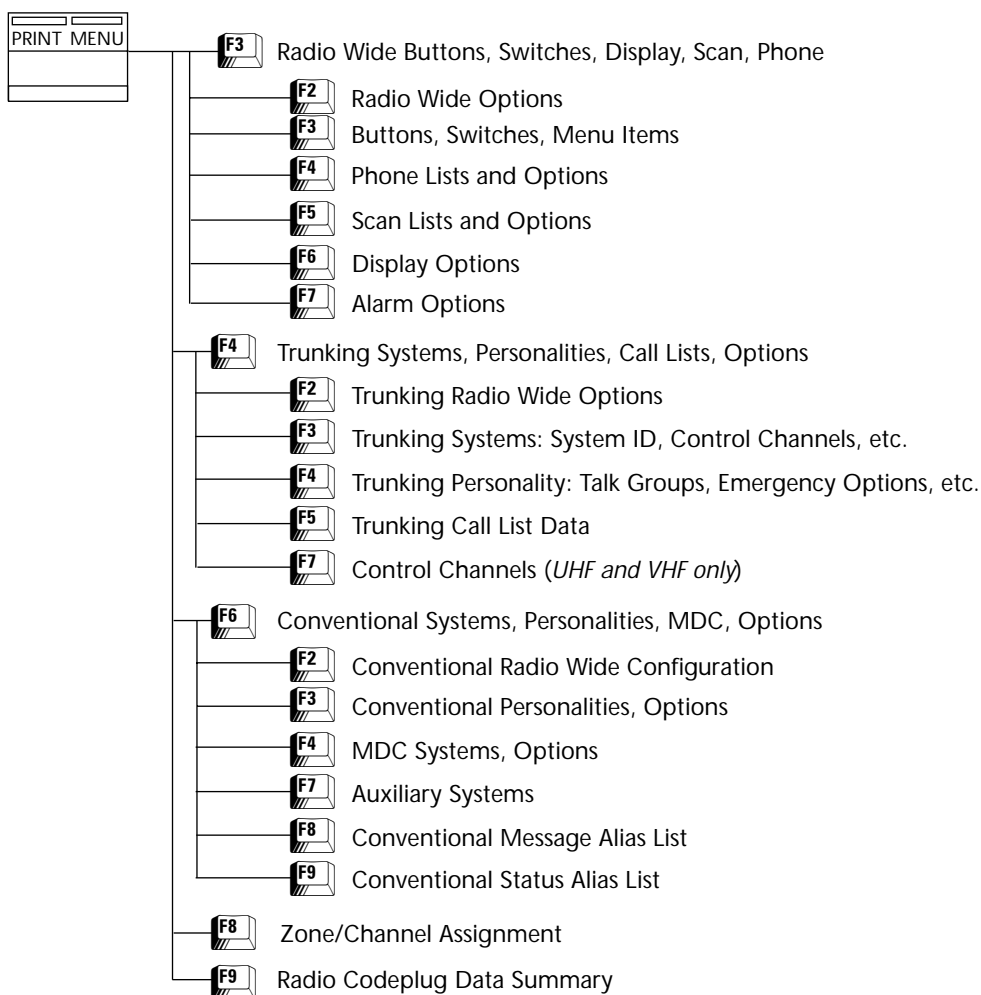

Print Menu



At the MAIN MENU, press **F5** to access the PRINT MENU.

MOTOROLA Radio Service Software MCS Model: MAIN:PRINT	Select Function F1 - F10.								
PRINT MENU -----									
F1 - HELP F2 - F3 - Radio Wide Buttons, Switches, Display, Scan, Phone F4 - Trunking Systems, Personalities, Call Lists, Options F5 - F6 - Conventional Systems, Personalities, MDC, Options F7 - F8 - Zone/Channel Assignment F9 - Radio Codeplug Data Summary F10 - EXIT, Return to Main Menu									
F1 HELP	F2	F3 RADIO CONFIG	F4 TRUNK DATA	F5	F6 CONV DATA	F7	F8 ZONE/CHN ASSIGN	F9 DATA SUMMARY	F10 EXIT

Make sure you have read a codeplug file using the GET/SAVE functions before you attempt to print configuration information. The PRINT function is used to produce permanent records of codeplug configurations. A printer is required and should be connected to your computer according to instructions in the user's manual that came with your computer. Graphics capability is NOT required.

Note: *When printing, misalignment of page breaks may result if the printer is not set up properly.* For best results, configure the printer as an IBM ProPrinter or an Epson FX/MX having factory default settings. The default number of lines per page is 66.

Function Key Descriptions

F3 - RADIO CONFIG
(Radio Configuration)

Brings up a screen from which you can print a summary of Radio Configuration information, including Button and Switch settings, Phone Lists, Scan Lists, and Display information.

F4 - TRUNK DATA
(Trunking Data)

Brings up a screen from which you can print a summary of Trunking information including personalities, call lists, and options.

F6 - CONV DATA
(Conventional Data)

Brings up a screen from which you can print out a summary of Conventional Personality and MDC system information.

F8 - ZONE/CHANNEL ASSIGN
(Zone/Channel Assignment)

Prints out a summary of current Zone/Channel Assignment information for the radio.

F9 - DATA SUMMARY (Radio Codeplug Data Summary)

Prints a summary of key radio programming parameters.

Print Radio Wide Features Configuration Menu



From the MAIN MENU, press **F5** and then **F3** to access the RADIO WIDE CONFIGURATION PRINT MENU.

MOTOROLA Radio Service Software MCS Model:	Select Function F1 - F10.								
MAIN:PRINT:CONFIG									
<p>RADIO WIDE CONFIGURATION MENU -----</p> <p>F1 - HELP F2 - Radio Wide Options F3 - Buttons, Switches, Menu Items F4 - Phone Lists and Options F5 - Scan Lists and Options F6 - Display Options F7 - Alarm Options F8 - F9 - F10 - EXIT, Return to PRINT MENU</p>									
F1 HELP	F2 RADIO OPTIONS	F3 FEATURE OPTIONS	F4 PHONE OPTIONS	F5 SCAN OPTIONS	F6 DISPLAY OPTIONS	F7 ALARM OPTIONS	F8	F9	F10 EXIT

You must use the GET/SAVE functions to first read or get a codeplug for printing radio configuration data. The PRINT function is used to produce permanent records of codeplug configurations. A printer is required and should be connected to your computer according to instructions in the user's manual that came with your computer. Graphics capability is NOT required.

Note: *When printing, misalignment of page breaks may result if the printer is not set up properly. For best results, configure the printer as an IBM ProPrinter or an Epson FX/MX having factory default settings. The default number of lines per page is 66.*

Function Key Descriptions

F2 - RADIO OPTIONS	Prints a summary of Radio Wide Options settings.
F3 - FEATURE OPTIONS	Prints a summary of Button/Switch/Menu/DEK Options settings.
F4 - PHONE OPTIONS	Prints a summary of Phone Options settings.
F5 - SCAN OPTIONS	Prints a summary of the Scan List and associated Scan Option settings.
F6 - DISPLAY OPTIONS	Prints a summary of Display Options settings.
F7 - ALARM OPTIONS	Prints a summary of Alarm Options settings.

Trunking Print Menu



At the MAIN MENU, press **F5** and then **F4** to bring up the TRUNKING PRINT MENU.

MOTOROLA Radio Service Software MCS Model:	Select Function F1 - F10.								
MAIN:PRINT:TRUNKING									
TRUNKING MENU ----- F1 - HELP F2 - Trunking Radio Wide Options F3 - Trunking Systems: System ID, Control Channels, etc. F4 - Trunking Personality: Talk Groups, Emergency options, etc. F5 - Trunking Call List Data F6 - F7 - Control Channels (UHF and VHF only) F8 - F9 - F10 - EXIT, Return to PRINT MENU									
F1 HELP	F2 TRUNK WIDE OPT	F3 TRUNK SYS	F4 TRUNK PERS	F5 TRUNK ID LIST	F6	F7 CONTROL CHANNEL	F8	F9	F10 EXIT

You must use the GET/SAVE functions to first read or get a codeplug for printing radio configuration data. The PRINT function is used to produce permanent records of codeplug configurations. A printer is required and should be connected to your computer according to the instructions in the user's manual that came with your computer. Graphics capability is NOT required.

Each print-out contains radio model and serial number information, software version numbers, Radio Service Software version numbers, and the date and time of the print-out.

Note: *When printing, misalignment of page breaks may result if the printer is not set up properly. For best results, configure the printer as an IBM ProPrinter or an Epson FX/MX having factory default settings. The default number of lines per page is 66.*

Function Key Descriptions

F2 - TRUNK WIDE OPT	Prints information about options which are applicable to all Trunking operations, regardless of system type.
F3 - TRUNK SYS	Prints Trunking system information.
F4 - TRUNKING PERSONALITY	Prints the Trunking personality and talkgroups.
F5 - TRUNK ID LIST	Prints the screen which documents the Trunking call lists.
F7 - CONTROL CHANNEL	Prints the CONTROL CHANNELS screen (<i>VHF/UHF only</i>).

Conventional Print Menu



At the MAIN MENU, press **F5** and then **F6** to access the CONVENTIONAL PRINT MENU.

MOTOROLA Radio Service Software MCS Model:	Select Function F1 - F10.								
MAIN:PRINT:CONV									
CONVENTIONAL MENU ----- F1 - HELP F2 - Conventional Radio Wide Configuration F3 - Conventional Personalities, Options F4 - MDC Systems, Options F5 - F6 - F7 - Auxiliary Systems F8 - Conventional Message Alias List F9 - Conventional Status Alias List F10 - EXIT, Return to PRINT MENU									
F1	F2	F3	F4	F5	F6	F7	F8	F9	F10
HELP	CONV WIDE OPT	CONV PERS	MDC SYSTEM			AUX SYSTEM	MSG ALIAS	STATUS ALIAS	EXIT

You must first read or get a codeplug using the GET/SAVE functions in order to print radio configuration data. The PRINT function is used to produce permanent records of codeplug configurations. A printer is required and should be connected to your computer according to instructions in the user's manual that came with your computer. Graphics capability is NOT required.

Each print-out contains radio model and serial number information, software version numbers, Radio Service Software version numbers, and the date and time of the print-out.

Note: *When printing, misalignment of page breaks may result if the printer is not set up properly.* For best results, configure the printer as an IBM ProPrinter or an Epson FX/MX having factory default settings. The default number of lines per page is 66.

Function Key Descriptions

F2 - CONV WIDE OPT
(Conventional Radio Wide Options)

Prints the Conventional Radio Wide information, along with the MPL List Configuration.

F3 - CONV PERS
(Conventional Personality)

Prints the Conventional Personality information.

F4 - MDC SYSTEM

Prints a summary of the MDC system options.

F7 - AUX SYSTEM
(Auxiliary Systems)

Takes you to a sub-menu from where you can print information about Single Tone Systems and Lists, Quik-Call II, and GE STAR systems.

F8 - MSG ALIAS
(Message Alias)

Prints the Conventional Message Alias List.

F9 - STATUS ALIAS
(Status Alias)

Prints the Conventional Status Alias List.

Notes

File Maintenance Menu Functions

7

This section describes all the functions available from the FILE MAINTENANCE MENU. To guide you through these functions, related menus and screens are shown with their paths from the MAIN MENU, function key descriptions and field definitions.

Menu Map

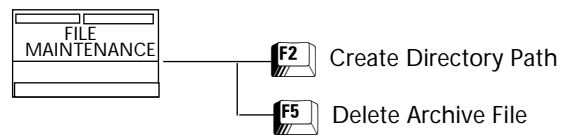

File Maintenance Menu



At the MAIN MENU, press **F6** to access the FILE MAINTENANCE MENU.

MOTOROLA Radio Service Software MCS Model: MAIN:FILE MAINT	Select Function F1 - F10.								
FILE MAINTENANCE MENU -----									
F1 - HELP F2 - Create Directory Path F3 - F4 - F5 - Delete Archive File F6 - F7 - F8 - F9 - F10 - Exit									
F1 HELP	F2 DEFINE PATH	F3	F4	F5 DELETE FILE	F6	F7	F8	F9	F10 EXIT

This RSS feature allows you to perform file management tasks from within the Radio Service Software package. Tasks such as creating directories and deleting files can be accomplished without exiting the RSS.

Function Key Descriptions

F2 - DEFINE PATH

Allows you to enter a new path name.

F5 - DELETE FILE

Allows you to delete a file from the path. This feature is similar to the DEL file name command in DOS.

Create Directory Path



From the MAIN MENU, press **F6** and then **F2** to bring up this screen.

MOTOROLA Radio Service Software MCS Model: MAIN:FILE MAINT:CREATE	Enter Path.								
CREATE DIRECTORY PATH -----									
New Path Name :									
F1 HELP	F2 DEFINE PATH	F3	F4	F5	F6	F7	F8	F9	F10 EXIT

This screen allows you to create a new directory on your computer disk drive. This is similar to the MKDIR command in DOS.

Programming Procedure

1. Type in the new directory path name, or press the desired function key (**F1 - F10**).
2. If you entered a new directory path, press **F2** to create the directory.

Function Key Description

F2 - DEFINE PATH

Creates a directory with the path name specified by the New Path Name field.

Delete Archive File

From the MAIN MENU, press **F6** and then **F5** to bring up this screen.



MOTOROLA Radio Service Software MCS Model:	Enter Path.								
MAIN:FILE MAINT:DELETE ARCHIVE									
Current Archive									
DELETE ARCHIVE FILE -----									
FileName	FileName	FileName	FileName						
-----	-----	-----	-----						
khh_h38.exe									
khl_h38.exe									
khm_h37.exe									
khn_h38.exe									
F1	F2	F3	F4	F5	F6	F7	F8	F9	F10
HELP	CHANGE			DELETE					EXIT
	ARCHIVE			FILE					

This screen allows you to delete unwanted files. Enter the path of the directory which holds the unwanted files by typing the path name in the Current Archive field.

Programming Procedure

1. Enter the path of the directory which holds the unwanted files by typing the path name in the Current Archive field.
2. Press **Tab** to select the desired file name.
3. Press **F5** to delete the selected file. You will be prompted for confirmation before the file is actually deleted.

Function Key Descriptions

F2 - CHANGE ARCHIVE

Allows you to access a different directory from the current directory. This function is similar to the CHDIR command in DOS.

F5 - DELETE FILE

Allows you to delete a file from the path. This function is similar to the DEL file name command in DOS. You will be prompted for confirmation before the file is actually deleted.

Field Definitions

Current Archive

The default archive path will always be the specified default path from the CONFIGURE PATHS AND PORT screen (**F9/F3**).

File Name

This field holds the name of the file that you wish to delete.

Note: Refer to the owner's manual that came with your computer for a complete description of file names.

FLASHport Upgrade

FLASHport is a revolutionary new method of upgrading the software in a subscriber radio. It involves enabling downloading new features to the radio or FLASHing new software into the radio.

This section is a brief preview of FLASHport capabilities. Detailed procedures can be found in the FLASHport User's Manual that accompanies the FLASHport software upgrade kit.

Note: *Your screens may vary slightly from the screens shown in this section.* The FLASHport path and key titles (HELP, EXIT, FLASH RADIO, etc.) may be the same for portable and mobile radios, but the function keys may be different.

Menu Map

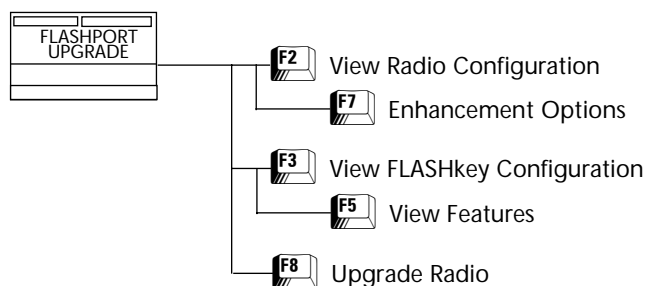

FLASHport Upgrade



At the MAIN MENU, press **F8** to access the FLASHport UPGRADE MENU.

MOTOROLA Radio Service Software MCS Model: MAIN:FLASHport UPGRADE	Select Function F1 - F10.								
FLASHPORT UPGRADE MENU -----									
F1 - HELP F2 - View Radio Configuration F3 - View FLASHkey Configuration F4 - F5 - F6 - F7 - F8 - Upgrade Radio F9 - F10 - EXIT, Return to Main Menu									
F1 HELP	F2 VIEW RADIO	F3 VIEW FLASHKEY	F4	F5	F6	F7	F8 UPGRADE RADIO	F9	F10 EXIT

You must have FLASHport software installed on your computer in order to access this screen from the MAIN MENU. This is a menu that is used to view the radio's configuration, to view the FLASHkey's contents, to upgrade the codeplug, and to FLASH the radio. The HELP screen (F1) and the User's Manual that came with your FLASHport Upgrade package will guide you through the upgrade process.

Note: *If you have NOT installed the FLASHport software on your computer, the RSS will display the following error message: "UNABLE TO OPEN THE SRIB SOFTWARE FILE. PLEASE PRESS F9 FROM THE MAIN MENU AND CHECK THE PATH".*

Note: *After upgrading the radio, you must reset it by pressing the power button off and on again.*

Function Key Descriptions

F2 - VIEW RADIO

Displays the radio's current system and enhancements prior to the FLASHport upgrade. *You must have specified the displayed information when you order a FLASHport upgrade package from the subscriber.* Since the FLASHport upgrade involves downloading new software to the radio, the memory size of the radio's controller board will also be displayed in order to reveal possible memory limitations in FLASHing the radio.

F3 - VIEW FLASHKEY

Displays the contents of the FLASHkey you will receive with your FLASHport upgrade package. This screen displays information such as the FLASH software required, number of purchased and remaining upgrades, and a side-by-side comparison of the features currently enabled in the radio and the features that will be enabled when the radio is FLASHed.

F8 - UPGRADE RADIO

Brings up the screen which displays the names of the files that exist in the default directory for the FLASH software. You will be asked to select a FLASH software file. When this is done, press **F8** in order to start the upgrade process.

View Radio Configuration



At the MAIN MENU, press **F8** and then **F2** to access this screen.

MOTOROLA Radio Service Software MCS Model: MAIN:FLASHport:RADIO CONFIG	Select Function F1 - F10.								
RADIO CONFIGURATION ----- FLASHcode.....000004-000000-6 Memory.....1Meg System Package.....H37 System Version.....1.0									
F1 HELP	F2	F3	F4	F5	F6	F7 ENHANCEMENT OPTIONS	F8	F9	F10 EXIT

You must have FLASHport software installed on your computer in order to access this screen. This screen displays the current configuration of your radio.

Note: *All the fields in this screen are view-only fields.*

Function Key Descriptions

F7 - ENHANCEMENT OPTIONS

Displays the radio's enhancement options and their current status (that is, whether they are enabled or disabled).

Enhancement Options



At the MAIN MENU, press **F8**, **F2** and then **F7** to access this screen.

MOTOROLA Radio Service Software MCS Model:	Select Function F1 - F10.
MAIN:FLASHport:RADIO CONFIG:OPTIONS	
ENHANCEMENT OPTIONS -----	
SmartZone Operation.....Disabled	Stat Alert Decode Feat.....Disabled
SMARTNET Operation.....Disabled	Stat Alert Encode Feat.....Disabled
Startsite Operation.....Disabled	
Conventional Operation.... Enabled	
150 Modes (Model I).....Disabled	
250 Modes (Models II/III)..Disabled	
GE Star Signaling.....Disabled	
Quick Call II/SingleTone...Disabled	
Trk One Touch Button.....Disabled	
SMARTNET Type I.....Disabled	
Trk Remote Monitor.....Disabled	
MDC Sel. Radio Inhibit....Disabled	
F1 F2 F3 F4 F5 F6 F7 F8 F9 F10	
HELP	EXIT

You must have FLASHport software installed on your computer in order to access this screen. This screen displays the enhancement options for your radio and their current status (that is, whether they are enabled or disabled).

Note: All the fields in this screen are view-only fields.

View FLASHkey Configuration



At the MAIN MENU, press **F8** and then **F3** to access this screen.

MOTOROLA Radio Service Software MCS Model: MAIN:FLASHport:FLASHkey	Select Function F1 - F10.								
<p>FLASHKEY CONFIGURATION</p> <p>-----</p> <p>Model Number.....M01KHH9PW5AN Current FLASHcode.....00001-000000-9 New FLASHcode.....00001-000000-9 Required FLASH Software.....TVN6369A Upgrades Purchased.....1 Upgrades Remaining.....1 Factory Order Number.....4818-0948-40432</p>									
F1 HELP	F2	F3	F4	F5 VIEW FEATURES	F6	F7	F8	F9	F10 EXIT

You must have FLASHport software installed on your computer in order to access this screen. This screen displays the contents of your FLASHkey.

Note: All the fields in this screen are view-only fields.

Function Key Descriptions

F5 - VIEW FEATURES

Displays the list of options currently available for your radio and the list of options that will be available after you perform an upgrade.

Field Definitions

Model Number

This field is a view-only field. This is the model number of the radio that the upgrade kit was ordered for.

Current FLASHcode

This field is a view-only field. It determines the options that are currently available on your radio.

New FLASHcode

This field is a view-only field. It determines the options that will be available on your radio after you perform the upgrade.

Required FLASH Software

This field is a view-only field. This is the kit number of the software package that was shipped to you with the FLASHkey. In order to perform a successful upgrade, the kit number on the FLASHkey must match the kit number in the Upgrade Software kit.

Upgrades Purchased

This field is a view-only field. This is the number of upgrades you have purchased.

Upgrades Remaining

This field is a view-only field. This is the number of upgrades remaining.

Factory Order Number

This field is a view-only field. It displays your factory order number.

View Features

At the MAIN MENU, press **F8**, **F3** and then **F5** to access this screen.



MOTOROLA Radio Service Software MCS Model:					Select Function F1 - F10.				
MAIN:FLASHport:FLASHkey:FEATURES									
Current FLASHcode -----					New FLASHcode -----				
FLASHcode.....000001-000000-9					FLASHcode.....000001-000000-9				
System Package.....H35					System Package.....H35				
System Version.....0					System Version.....0				
Enhancements:					Enhancements:				
SmartZone Operation.....Disabled					SmartZone Operation.....Disabled				
SMARTNET Operation.....Disabled					SMARTNET Operation.....Disabled				
Startsite Operation.....Disabled					Startsite Operation.....Disabled				
Conventional Operation....Disabled					Conventional Operation....Disabled				
150 Modes (Model I).....Disabled					150 Modes (Model I).....Disabled				
250 Modes (Models II/III)..Disabled					250 Modes (Models II/III)..Disabled				
GE Star Signaling.....Disabled					GE Star Signaling.....Disabled				
Quick Call II/SingleTone...Disabled					Quick Call II/SingleTone...Disabled				
F1	F2	F3	F4	F5	F6	F7	F8	F9	F10
HELP								MORE	
								EXIT	
								FEATURES	

You must have FLASHport software installed on your computer in order to access this screen. This screen displays the list of options currently available on your radio and the features that will be available after the upgrade.

Note: All the fields in this screen are view-only fields.

Function Key Descriptions

F9 - MORE FEATURES

Displays more radio options and features.

More Features



At the MAIN MENU, press **F8**, **F3**, **F5** and then **F9** to access this screen.

MOTOROLA Radio Service Software MCS Model: ...FLASHkey:MORE FEATURES	Select Function F1 - F10.														
<table><thead><tr><th>Current FLASHcode</th><th>New FLASHcode</th></tr></thead><tbody><tr><td>Trk One Touch Button.....Disabled</td><td>Trk One Touch Button.....Disabled</td></tr><tr><td>SMARTNET Type I.....Disabled</td><td>SMARTNET Type I.....Disabled</td></tr><tr><td>Trk Remote Monitor.....Disabled</td><td>Trk Remote Monitor.....Disabled</td></tr><tr><td>MDC Sel. Radio Inhibit.....Disabled</td><td>MDC Sel. Radio Inhibit.....Disabled</td></tr><tr><td>Stat Alert Decode Feat.....Disabled</td><td>Stat Alert Decode Feat.....Disabled</td></tr><tr><td>Stat Alert Encode Feat.....Disabled</td><td>Stat Alert Encode Feat.....Disabled</td></tr></tbody></table>	Current FLASHcode	New FLASHcode	Trk One Touch Button.....Disabled	Trk One Touch Button.....Disabled	SMARTNET Type I.....Disabled	SMARTNET Type I.....Disabled	Trk Remote Monitor.....Disabled	Trk Remote Monitor.....Disabled	MDC Sel. Radio Inhibit.....Disabled	MDC Sel. Radio Inhibit.....Disabled	Stat Alert Decode Feat.....Disabled	Stat Alert Decode Feat.....Disabled	Stat Alert Encode Feat.....Disabled	Stat Alert Encode Feat.....Disabled	
Current FLASHcode	New FLASHcode														
Trk One Touch Button.....Disabled	Trk One Touch Button.....Disabled														
SMARTNET Type I.....Disabled	SMARTNET Type I.....Disabled														
Trk Remote Monitor.....Disabled	Trk Remote Monitor.....Disabled														
MDC Sel. Radio Inhibit.....Disabled	MDC Sel. Radio Inhibit.....Disabled														
Stat Alert Decode Feat.....Disabled	Stat Alert Decode Feat.....Disabled														
Stat Alert Encode Feat.....Disabled	Stat Alert Encode Feat.....Disabled														
F1 HELP	F2 F3 F4 F5 F6 F7 F8 F9 F10 EXIT														

You must have FLASHport software installed on your computer in order to access this screen. This screen displays more options currently available on your radio and the features that will be available after the upgrade.

Note: All the fields in this screen are view-only fields.

Upgrade Radio



At the MAIN MENU, press **F8** twice to access this screen.

MOTOROLA Radio Service Software MCS Model: MAIN:FLASHport:UPGRADE RADIO	Press Enter to Select Upgrade File. Press F8 to Upgrade the Radio.								
Software Path: C:\MRSS\MCS\UPGRADE DIRECTORY CONTENTS ----- mcsboot.enc									
F1 HELP	F2 CHANGE PATH	F3	F4	F5	F6 CHDIR UP	F7 CHDIR DOWN	F8 FLASH RADIO	F9	F10 EXIT

*You must have FLASHport software installed on your computer in order to access this screen. This screen is used to upgrade your radio. Press **Tab** to move to the desired field. Once a file is highlighted, press **Enter** to select it and then **F8** to upgrade the radio.*

Note: *The kit number of the selected file must match the kit number on your FLASHkey. Otherwise, the RSS will not perform the upgrade. Selecting a file that is not a FLASHport upgrade file will result in a "CHECKSUM" or "INVALID FILE FORMAT" error.*

Function Key Descriptions

F2 - CHANGE PATH

Used to change the directory path in order to locate the directory where the FLASHport upgrade files are located.

F6 - CHDIR UP

Moves one level up the directory tree.

F7 - CHDIR DOWN

Moves one level down the directory tree.

F8 - FLASH RADIO

Used to upgrade the radio using the selected FLASHport file.

Note: *The kit number of the selected file must match the kit number on your FLASHkey. Otherwise, the RSS will not perform the upgrade. Selecting a file that is not a FLASHport upgrade file will result in a "CHECKSUM" or "INVALID FILE FORMAT" error.*

Field Definitions

Software Path

This field will default to the FLASH software path specified on the CONFIGURE PATHS AND PORT screen (**F9/F3**).

Computer-to-Radio Communication Error Codes



Error Code	Description	Recommended Corrective Action
01	No response from the radio	Check programming cable connections. Eliminate background routines on the PC. Check power to the RIB.
02	Transmit register time-out	Check serial port. Busy low time-out.
03	Busy low time-out	Check to make sure that the radio is turned on. Check radio's battery. Check COM port selection on the CONFIGURE PATHS AND PORT screen (F9/F3).
04	Communication collision	Retry operation. Check COM port selection on the CONFIGURE PATHS AND PORT screen (F9/F3). Check power to the RIB. Check programming cable connections.
05	Programmer not receiving its own transmission	Check COM port selection on the CONFIGURE PATHS AND PORT screen (F9/F3). Check RIB-to-PC cable. Check power to the RIB. Check serial card. Eliminate background routines on the PC.
06	Re-transmission not acknowledged (NAKed)	Retry operation.
07	CRC error	Retry operation.
08	CRC error	Retry operation.
09	No Acknowledgment received	Check radio's battery. Check power to the RIB.
11	Busy high after pulled low	Check COM port selection on the CONFIGURE PATHS AND PORT screen (F9/F3). Check COM port. Check RIB-to-PC connections. Check power to the RIB.

Note: A low-level hum or buzz in the received audio MAY be experienced when TPL code OZ (254.1 Hz) is used. This PL code is at the high end of the sub-audible frequency range and may be heard in the audio under certain circumstances. *Use of this code should be avoided if possible.*

Notes

TPL Frequencies and Codes



Frequency (Hz)	Code	Frequency (Hz)	Code
067.0	XZ	136.5	4Z
069.3	WZ	141.3	4A
071.9	XA	146.2	4B
074.4	WA	151.4	5Z
077.0	XB	156.7	5A
079.7	WB	162.2	5B
082.5	YZ	167.9	6Z
085.4	YA	173.8	6A
088.5	YB	179.9	6B
091.5	ZZ	186.2	7Z
094.8	ZA	192.8	7A
097.4	ZB	203.5	M1
100.0	1Z	206.5	8Z
103.5	1A	210.7	M2
107.2	1B	218.1	M3
110.9	2Z	225.7	M4
114.8	2A	229.1	9Z
118.8	2B	233.6	M5
123.0	3Z	241.8	M6
127.3	3A	250.3	M7
131.8	3B	254.1	OZ

Notes

DPL Codes

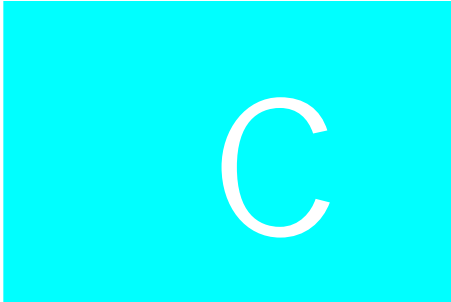

Code	Code	Code	Code
023	143	315	532
025	152	331	546
026	155	343	565
031	156	346	606
032	162	351	612
043	165	364	624
047	172	365	627
051	174	371	631
054	205	411	632
065	223	412	645
071	226	413	654
072	243	423	662
073	244	431	664
074	245	432	703
114	251	445	712
115	261	464	723
116	263	465	731
125	265	466	732
131	271	503	734
132	306	506	743
134	311	516	754

Notes

MCS 2000 Features



Conventional Signalling System Features

Features	MDC-1200	DTMF	DTMF/ Phone
Data-Operated Squelch	✓		
Radio Check	✓		
PTT-ID	Encode		
Emergency Alarm	Encode		
Voice Selective Call	Encode/ Decode		
Emergency Revert	✓		
Memory Dial (19 Numbers)			✓
Last Number Dial			✓
19 Access/De-Access Codes			✓
Call Alert	Encode/ Decode		
Hot Keypad		✓	
Mandown	✓		
Immediate/Delayed Access			✓
Live/Buffered Dialing			✓
GE STAR	✓		
VRM100 Data Operation	✓		
Quik-Call II	✓		
Single Tone	✓		
Radio Inhibit	✓		
Emergency with Voice to Follow (<i>excluding Type I</i>)	✓		
Status/Message	✓		

Note: Access to many of these features will be model-dependent.

Trunking Signalling System Features

Features	Type I	Type II
Universal ID	✓	
Failsoft	✓	✓
PTT-ID	✓	✓
Emergency Alarm Call		✓
Private Call	Encode/Decode	Encode/Decode
Call Alert	Encode/Decode	Encode/Decode
Phone Interconnect	Encode/Decode	Encode/Decode
Hot Keypad	✓	✓
Status/Message		Encode
Talkgroup Scan	✓	✓
Priority Monitor		✓
Subfleet Scan	✓	
Mandown		✓
Affiliation		✓
Dynamic Regrouping		✓
Radio Inhibit		✓
AMSS	✓	✓
SmartZone		✓
Group Privacy	✓	✓
Full SMARTNET	✓	✓
VRM100 Data Operation	✓	✓
Voice On Control	✓	✓
Remote Monitor	✓	✓
Emergency with Voice to Follow	✓	✓

Note: Access to many of these features will be model dependent.

Radio Wide Features

Features	Type I	Type II
Selectable Keypad Mute	✓	✓
Alert Tones	✓	✓
Block Pending CA/PC		✓
Codeplug Self Test	✓	✓
Rotary Switch Function in Scan Programming	✓	✓
Short/Long Keypress Duration	✓	✓
Radio-to-Radio Cloning	✓	
Time-Out Timer Values	✓	✓
Emergency Silent Alarm	✓	✓
Emergency Channel Delay	✓	✓
Mandown Pre/Post Alert	✓	✓
Button Functions	✓	✓
Switch Functions	✓	✓
Menu Item List Functions	✓	✓
Display Scrolling and Name Size Option	✓	✓
Display Backlight	✓	✓
Scan List Creation	✓	✓
VRM100 Data Operation	✓	✓

Trunking Wide Features

Features	Conventional	Trunking
Telephone Interconnect Half/Full Duplex		✓
Call Alert/PC Response		✓
ISW Window Adjust		✓
Auto Dial Holdoff		✓
RF Modem		✓
Voice On Control		✓

Conventional Wide Features

Features	Conventional	Trunking
Smart PTT Parameters	✓	
Hub Defects PL	✓	
Direct Frequency Enabled	✓	

By-Personality Features

Features	Conventional	Trunking
Mode Name (Assigned on Zone/ Channel screen)	✓	✓
Rx Frequency	✓	
Tx Frequency	✓	
Rx Squelch Type	✓	
Rx Squelch Code	✓	
Tx Squelch Type	✓	
Tx Squelch Code	✓	
Talkaround/Direct	✓	
Smart PTT	✓	
Choose Scan List	✓	✓
Hot Keypad	✓	✓
Tx Power Level (For Applicable Bands)	✓	✓
MDC Signaling System	✓	
GE STAR Signaling System	✓	
Tx Deviation	✓	
Phone Operation (DTMF Timing Parameters)	✓	✓
Auto Scan	✓	✓
Mute/Unmute Options	✓	
Choose Time-Out Timer Value	✓	✓
Squelch Fine Tune	✓	
Channel Spacing	✓	
Pre/De-emphasis	✓	
Trunking System		✓
Trunking Individual ID		✓
Failsoft Type		✓
Talk Permit Tone		✓
Call Alert	✓	✓
Private Call		✓
Conversation Type (Message, Transmission, PTT-ID)		✓
Talkgroups		✓

By-Personality Features

Features	Conventional	Trunking
Quik-Call II Signalling System	✓	
Status	✓	✓
Message	✓	✓
Access Type (Fast/Slow)		✓
20-Channel Synthesized		✓
Emergency Parameters		✓

By-Personality Features

Features	Conventional MDC	Type I Trunking	Type II Trunking
System ID		✓	✓
System Type (I, II, Iii)		✓	✓
System ID Aliasing			✓
Individual ID	✓	✓	✓
Universal ID		✓	
Connect Tone		✓	✓
Coverage Type		✓	✓
Affiliation Type			✓
Tx Power		✓	✓
Repeater Offset		✓	✓
Channel Assignment Type (International / Domestic)		✓	✓
Splinter Channel		✓	✓
Phone DTMF Timing		✓	✓
Hot Keypad DTMF Timing		✓	✓
Status/Message Aliasing	✓		✓
PTT-ID Enable	✓		
Sidetone Enable	✓		
Radio Check Enable	✓		
Emergency Type, Parameters	✓		
Emergency Revert, Table Definition	✓		
MDC Timing Parameters	✓		
DOS Parameters	✓		
Sel Call Reset Parameters	✓		

Notes

Field/Menu Navigation Key Sequences



Below is an alphabetized list of all fields and menus available in the RSS. The list can be reached on-line in the RSS from any Help screen by pressing **F6** (A to P) or **F7** (Q to Z).

Note: The availability of individual fields cataloged in the list depends on the features ordered with the radio and, in some cases, on specific settings of other fields in the RSS.

150 Modes (Model I)..... F8→F2→F7
 150 Modes (Model I)..... F8→F3→F5
 250 Modes (Model II/III)..... F8→F2→F7
 250 Modes (Model II/III)..... F8→F3→F5

A

A/G F/S FREQ (MHz)..... F4→F4→F4
 A/G Failsoft F4→F4→F4
 ALARM OPTIONS..... F4→F3→F7
 ARCHIVE FILES..... F3→F3
 AUXILARY SYSTEMS MENU..... F4→F6→F7
 Access Code..... F4→F3→F4→F8
 Access Strapping F4→F6→F3→F9→F7
 Access Type F4→F4→F3
 Access Type F4→F4→F4→F8
 Access Type F4→F4→F4→F9
 Access Type F4→F6→F3→F9→F7
 Ack Alert Tone..... F4→F6→F4→F3→F9
 Acknowledge Alert Tone..... F4→F6→F4→F3
 Addressing Mode F4→F6→F7→F5
 Aff. Hold Off (sec)..... F4→F4→F2→F2
 Affiliation Type F4→F4→F3
 Alarm Rearm Option..... F4→F3→F7
 Alert Tone Vol Offset (db)..... F4→F3→F2
 Alert Tones F4→F3→F2
 Alias..... F4→F4→F3
 Alt Display Time (ms) F4→F3→F6
 Announcement Group F4→F4→F4
 Archive Filename F3→F5→F3→F7
 Archive Filename F3→F5→F4→F7
 Archive Filename F3→F5→F7
 Archive Filename F3→F5→F8
 Archive Filename F3→F7
 Archive Path..... F9→F3
 Archive: F3→F3
 Archive: F3→F5→F4→F7
 Archive: F3→F5→F4→F7
 Archive: F3→F5→F7

Archive: F3→F5→F8
 Archive: F3→F7
 Auto Access Code Select F4→F6→F3→F8
 Auto Dial Holdoff (ms) F4→F4→F2
 Auto Reset Carr Ovr..... F4→F6→F7→F4
 Auto Reset Duration (sec) F4→F6→F7→F4
 Auto Reset Time (sec)..... F4→F6→F4→F3→F9
 Auto Scan..... F4→F4→F4→F9
 Auto Scan..... F4→F6→F3→F9
 Auto Sel Call Transmit..... F4→F6→F3→F7

B

BACKGROUND..... F9→F7
 Baud Rate F4→F6→F7→F5
 Block Pending CA/PC..... F4→F3→F2
 Bootstrap Code Path & File F9→F3
 Busy LED..... F4→F6→F3→F9
 Busy Override Chirp Ack..... F4→F4→F2→F2
 Busy Override Delay (sec)..... F4→F4→F2→F2
 Button 1 Feature F4→F4→F3→F9→F5
 Button 2 Feature F4→F4→F3→F9→F5
 Button 3 Feature F4→F4→F3→F9→F5
 Button 4 Feature F4→F4→F3→F9→F5

C

CALL LIST TABLE..... F4→F4→F5
 CALL LIST TABLE..... F4→F6→F4→F4
 CCID Delay Timer F4→F3→F2
 CCID Registration..... F4→F6→F3→F9
 CHANGE/VIEW MENU F4
 CHANNEL ASSIGNMENT
 DATA..... F4→F4→F3→F6
 CONFIGURE PATHS AND PORT..... F9→F3
 CONTROL CHANNELS..... F4→F4→F3→F6
 CONTROL CHANNELS..... F4→F4→F3→F6→F6
 CONTROLLER BOARD INIT
 F2→F9
 CONV MESSAGE ALIAS LIST..... F4→F6→F8

CONV PERS RAC
 OPTIONS F4→F6→F3→F9→F7
 CONV STATUS ALIAS LIST F4→F6→F9
 CONVENTIONAL F4→F3→F5→F8
 CONVENTIONAL MENU F4→F6
 CONVENTIONAL PERSONALITY F4→F6→F3
 CONVENTIONAL PERSONALITY
 OPT F4→F6→F3→F9
 CONVENTIONAL PERSONALITY
 PHN F4→F6→F3→F8
 CONVENTIONAL RADIO
 WIDE OPT F4→F6→F2
 CONVENTIONAL SECURE
 PERS F4→F6→F3→F6
 CREATE DIRECTORY PATH F6→F2
 CURRENT LIMIT F2→F2→F9
 Call Alert Decode F4→F6→F3→F7
 Call Alert Encode F4→F6→F3→F7
 Call Alert Operation F4→F4→F4
 Call ID F4→F4→F5
 Call ID F4→F6→F4→F4
 Call ID List F4→F4→F4
 Call List F4→F4→F5
 Call Text F4→F4→F5
 Call Text F4→F6→F4→F4
 Car Radio Mute F4→F3→F2→F9
 Car Radio Mute Timer (sec) F4→F3→F2→F9
 Carrier Detect Required F4→F3→F5→F8
 Chan F4→F4→F3
 Channel F4→F3→F2
 Channel F4→F3→F5
 Channel F4→F6→F4→F3
 Channel F4→F6→F7→F5
 Channel Assgn. Type F4→F4→F3→F9
 Channel Bandwidth F4→F4→F3→F9
 Channel Change ID F4→F3→F2
 Channel Delay (sec) F4→F3→F2→F7
 Channel Grant Polarity F4→F3→F2→F5
 Channel Spacing F2→F2→F6
 Channel Spacing F4→F6→F3→F9
 Channel Text Size F4→F3→F6
 Chn F4→F3→F5
 Coast Time (ms) F4→F6→F4→F3→F9
 Coast Time (ms) F4→F6→F7→F5
 Code F4→F6→F2→F2
 Code F4→F6→F3
 Codeplug Self Test F4→F3→F2
 Connect Tone (Hz) F4→F4→F3
 Console Ack Required F4→F4→F4→F8
 Control Channel F4→F4→F4→F6
 Control Station Equipped F4→F3→F2
 CONTROLLER BOARD
 INITIALIZATION PROGRAM F2→F9
 Conv Item F4→F3→F4→F4
 Conventional Operation F8→F2→F7
 Conventional Operation F8→F3→F5
 Conversation Type F4→F4→F3

Conversation Type F4→F4→F4→F9
 Coverage Type F4→F4→F3
 Current Archive F6→F5
 Current FLASHcode F8→F3
 Current FLASHcode F8→F3→F5
 Current FLASHcode F8→F3→F5→F9

D

DEFAULT RSSI F2→F3→F7
 DEK BUTTON CONFIGURATION F4→F3→F3→F5
 DELETE ARCHIVE FILE F6→F5
 DIALING OPTIONS F4→F3→F4→F9
 DOS F4→F6→F7→F5
 DOS (Data Squelch) F4→F6→F4→F3→F9
 DPL Invert F4→F6→F2→F2
 DPL Invert F4→F6→F3
 DTMF ACCESS/DEACCESS
 CODES F4→F3→F4→F8
 DTMF Access Timing Table F4→F6→F3→F8
 DTMF Digit Hangtime (ms) F4→F3→F4→F9
 DTMF Pause Time (ms) F4→F3→F4→F9
 DTMF TRANSMIT DEVIATION F2→F4→F2
 Data Mode Request Polarity F4→F3→F2→F5
 Data On Failsoft F4→F3→F2→F5
 Data Overrides Voice F4→F3→F2→F5
 Deaccess Code F4→F3→F4→F8
 Decoder 1 Call Type F4→F6→F7→F4
 Decoder 2 Call Type F4→F6→F7→F4
 Decoder Option F4→F6→F7→F4
 Designated Tx Mem F4→F3→F5
 Detections Required F4→F6→F7→F4→F9
 Digit Duration (ms) F4→F4→F3→F9
 Digit Duration (msec) F4→F6→F3→F8
 Direct Mode F4→F3→F2→F9
 Direct/Talkaround F4→F6→F3
 Direct Frequency Enabled F4→F6→F2
 Directory Contents F8→F8
 Disconnect On Data F4→F3→F2→F5
 Display Site Trunking F4→F4→F2→F2
 Duplex Phone F4→F4→F4→F9
 Dynamic Priority F4→F3→F5
 Dynamic Regrouping F4→F4→F3

E

EMERGENCY DATA CONFIG F4→F4→F4→F8
 ENHANCEMENT OPTIONS F8→F2→F7
 ENVIRONMENT F4→F4→F2→F2
 Echo Mute Time (ms) F4→F6→F3→F6
 Emer Limited Patience (sec) .. F4→F6→F4→F3→F9
 Emer PTT-ID Sidetone F4→F6→F4→F3
 Emer Prio Tx Inhibit F4→F6→F4→F3→F9
 Emerg. PTT-ID F4→F6→F3
 Emerg. Steering Channel F4→F3→F2→F9
 Emerg. Steering Zone F4→F3→F2→F9
 Emergency F4→F6→F4→F3
 Emergency Alarm F4→F4→F4→F8
 Emergency Alarm F4→F6→F7→F5

Emergency Call F4→F4→F4→F8
 Emergency Hot Mic F4→F4→F4→F8
 Emergency Power Up..... F4→F3→F2→F7
 Emergency Receive F4→F3→F6
 Emergency Type..... F4→F6→F4→F3
 Ext Alarm Delay (sec)..... F4→F3→F7
 Ext Radio Ignition..... F4→F3→F9→F2

F

F/S Freq (MHz) F4→F4→F4
 F/S Frequency..... F4→F4→F4→F7
 F/W F/S Freq (MHz) F4→F4→F4
 F/W Failsoft..... F4→F4→F4
 FILE MAINTENANCE MENU F6
 FLASH Software Path F9→F3
 FLASHKEY CONFIGURATION F8→F3
 FLASHcode F2→F9
 FLASHcode F8→F2
 FLASHcode F8→F3→F5
 FLASHport UPGRADE MENU F8
 FRAME..... F9→F7
 FRONT END FILTER..... F2→F3→F2
 Failsoft..... F4→F4→F4→F7
 Failsoft Hold Time (sec) F4→F3→F5→F8
 Failsoft Inactivity (sec)..... F4→F4→F2→F2
 Failsoft Type..... F4→F4→F4
 Fast Scroll Rate (ms) F4→F3→F6
 FileName F6→F5
 Filter Constant K1 F4→F4→F2→F2
 Filter Constant K2..... F4→F4→F2→F2
 Filter Constant K3..... F4→F4→F2→F2
 Filter Threshold Con T1..... F4→F4→F2→F2
 Filter Threshold Con T2..... F4→F4→F2→F2
 Filter Threshold Con T3..... F4→F4→F2→F2
 Fleet ID F4→F4→F3
 Fleet ID F4→F4→F4
 Flt/ATG..... F3→F5
 Frequency..... F4→F4→F3→F6
 Frequency..... F4→F4→F4→F6
 Frequency (MHz) F4→F6→F3
 Full Spectrum CC Scan F4→F4→F2→F2
 Full Spectrum CC Scan Timer..... F4→F4→F2→F2

G

GE STAR SYSTEM F4→F6→F7→F5
 GE STAR System..... F4→F6→F3
 GE Star Signaling F8→F2→F7
 GE Star Signaling F8→F3→F5
 GET/SAVE/PROGRAM MENU F3
 Global Tx Multiplier F4→F6→F4→F3→F9

H

HIGHLIGHT F9→F7
 HUB Suspends Scan F4→F3→F5→F8
 HearClear F4→F4→F3→F9
 HearClear F2→F3→F3
 HearClear F4→F6→F3→F9

HiLo Airhorn Tones F4→F3→F9→F2
 High Pwr F2→F2→F3
 Home Mode Selection..... F4→F3→F2
 Horn & Light Duration F4→F3→F7
 Horn And Lights F4→F3→F7
 Hot DTMF Timing..... F4→F4→F3→F9
 Hot Keypad F4→F6→F3
 Hot Keypad (DTMF) F4→F4→F4
 Hub Defeats PL..... F4→F6→F2

I

ID..... F3→F5
 ISW Window Adjust..... F4→F4→F2
 Ignition Switch..... F4→F3→F3→F3
 Ignore Data Display F4→F3→F2→F5
 Ignore Site Resource Pref..... F4→F4→F4→F9→F6
 Impolite Retries..... F4→F6→F4→F3→F9
 Impolite Retries..... F4→F6→F7→F5
 Individual ID..... F4→F4→F3
 Individual ID..... F4→F4→F4
 Indv ID F3→F5
 Initial Delay (ms) F4→F4→F3→F9
 Initial Delay (msec)..... F4→F6→F3→F8
 Initial Squelch Type F4→F6→F7→F4
 Integer Delay (msec) F4→F6→F3→F8
 Inter-Digit Delay (ms) F4→F4→F3→F9
 Inter-Packet Time (ms)..... F4→F6→F4→F3→F9
 Inter-Tone Duration (sec)..... F4→F6→F7→F4→F9

L

Last Programmed F3→F5→F3→F7
 Last Programmed F3→F5→F4→F7
 Last Programmed F3→F5→F7
 Last Programmed F3→F5→F8
 Last Programmed F3→F7
 Leading PTT-ID..... F4→F6→F4→F3
 Limited Patience (sec) F4→F6→F4→F3→F9
 Long Press/Emer Duration (ms)..... F4→F3→F2
 Long Tone Duration (sec) F4→F6→F7→F4
 Low Pwr..... F2→F2→F3

M

MDC CONFIGURATION MENU F4→F6→F4
 MDC DATA CLONING..... F3→F5
 MDC DATA CLONING..... F3→F5→F3
 MDC DATA CLONING..... F3→F5→F4
 MDC Hot Mic Emergency..... F4→F6→F4→F3→F7
 MDC Hot Mic Tx
 Period (sec)..... F4→F6→F4→F3→F7
 MDC REPEATER ID F4→F6→F4→F5
 MDC SYSTEM OPTIONS F4→F6→F4→F3→F9
 MDC SYSTEMS..... F4→F6→F4→F3
 MDC Sel. Radio Inhibit..... F8→F2→F7
 MDC System F4→F6→F4→F3
 MDC System F4→F6→F4→F3→F7
 MDC System F4→F6→F4→F3→F9
 MDC System F4→F6→F3

MDC Unlimited Calling..... F4→F6→F3→F7
MERGE FORM..... F3→F4
MESSAGE TEXT..... F9→F7
MONITOR TYPE..... F9→F7
MORE EMERGENCY OPTIONS..... F4→F6→F4→F3→F7
MORE RADIO WIDE OPTIONS..... F4→F3→F9
MPL LIST CONFIGURATION F4→F6→F2→F2
MPL Name..... F4→F6→F2→F2
MPL Number..... F4→F6→F2→F2
Man Acc Live Dialing..... F4→F3→F4
Mandatory Password..... F4→F3→F6
Manual Tone F4→F3→F9→F2
Max Password Length F4→F3→F6
Maximum Channels (Talkgroups) F4→F3→F2
Memory F4→F3→F5
Memory Optimization F9→F3
Message F4→F4→F4
Message F4→F6→F4→F3
Message Alias Number F4→F4→F3→F9→F7
Message Alias Number F4→F6→F8
Message Alias Text..... F4→F4→F3→F9→F7
Message Alias Text..... F4→F6→F8
Message Aliasing F4→F4→F3→F9
Mic AGC..... F4→F3→F2→F9
Min Alert Tone Volume..... F4→F3→F2
Model Number F2→F9
Model Number F3→F5→F3→F7
Model Number F3→F5→F4→F7
Model Number F3→F5→F7
Model Number F3→F5→F8
Model Number F3→F7
Model Number F3→F9
Model Number F8→F3
Monitor Hold Time (sec)..... F4→F3→F5→F8
Monitor w Sil Emer F4→F6→F7→F5
Motorcycle Radio F4→F3→F2→F9

N

NEW TRUNKING IDS..... F3→F5
Native Language..... F4→F3→F6
New FLASHcode F8→F3
New FLASHcode F8→F3→F5
New FLASHcode F8→F3→F5→F9
New Path Name F6→F2
Non-XL Scan Unsquench
Duration (ms)..... F4→F3→F2→F6
NonPriority Members F4→F3→F5
Nuisance Mode Delete F4→F3→F5→F8
Number of DEK boxes..... F4→F3→F3→F5

O

ONE TOUCH BUTTON

OPTIONS F4→F4→F3→F9→F5
Observ Window Due (cycles) F4→F6→F7→F4→F9
Operation F4→F4→F4
Operation F4→F6→F4→F3→F9
Options Audio Muting..... F4→F3→F9→F2

Out Of Range..... F4→F3→F2
Override Timer (ms) F4→F6→F3→F9

P

PA Ignition Sense..... F4→F3→F9→F2
PERSONALITY MDC
OPTIONS F4→F6→F3→F7
PHONE CONFIGURATION F4→F3→F4
POPUP BACKGROUND..... F9→F7
PRINT MENU..... F5
PROGRAM RADIO
CODEPLUG F3→F5→F3→F8
PROGRAM RADIO
CODEPLUG F3→F5→F4→F8
PROGRAM RADIO CODEPLUG F3→F5→F8
PROGRAM RADIO CODEPLUG F3→F8
PROGRAMMING HISTORY F3→F9
PTT Code Type F4→F6→F3→F9→F7
PTT DTMF Code F4→F6→F3→F9→F7
PTT-ID..... F4→F6→F3
PTT-ID Sidetone..... F4→F6→F7→F5
PTT-ID Type F4→F6→F7→F5
PTT MDC Repeater ID F4→F6→F3→F9→F7
PTT Sidetone..... F4→F6→F7→F2
PTT Singletone (Hz)..... F4→F6→F3→F9→F7
PTT-ID Sidetone..... F4→F6→F4→F3
Password F4→F3→F6
Periodic Keyfail Alert Tone..... F4→F3→F2→F6
Permanent Horn & Lights..... F4→F3→F7
Pers F3→F5
Personality F4→F4→F4
Personality F4→F4→F4→F6
Personality F4→F4→F4→F7
Personality F4→F4→F4→F9
Personality F4→F6→F3
Personality F4→F6→F3→F6
Personality F4→F6→F3→F7
Personality F4→F6→F3→F8
Personality F4→F6→F3→F9
Personality F4→F6→F3→F9→F7
Phone DTMF Timing..... F4→F4→F3→F9
Phone Dialing..... F4→F3→F4→F9
Phone Interconnect..... F4→F4→F4
Phone Num Display Format..... F4→F3→F4
Phone Number F4→F3→F4
Phone Operation F4→F6→F3
Phone Text..... F4→F3→F4
Polite Retries..... F4→F6→F4→F3→F9
Preamble During Pretime F4→F6→F4→F3→F9
Preambles F4→F6→F4→F3→F9
Prefer Status..... F4→F4→F4→F9→F6
Pretime (ms) F4→F6→F4→F3→F9
Pretime Duration (ms) F4→F6→F7→F5
Primary ID F3→F5
Primary ID F3→F5→F3
Primary ID F3→F5→F4
Primary ID F4→F6→F4→F3

Priority 1 Member..... F4→F3→F5
 Priority 1 Type F4→F3→F5
 Priority 2 Member..... F4→F3→F5
 Priority 2 Type F4→F3→F5
 Priority Chan Marking..... F4→F3→F5→F8
 Priority Scan Alert..... F4→F3→F5→F8
 Private Call Type..... F4→F4→F4
 Private Call Type..... F4→F4→F4
 Program Source F3→F5→F3→F7
 Program Source F3→F5→F4→F7
 Program Source..... F3→F5→F7
 Program Source..... F3→F5→F8
 Program Source..... F3→F7
 Program Source..... F3→F9
 Programmed Date..... F3→F9
 Proper Code Detect..... F4→F4→F4→F9
 Proper Code Detect..... F4→F6→F3→F6
 Protocol Type..... F4→F4→F4
 Protocol Type..... F4→F4→F4→F8
 Public Address..... F4→F3→F9→F2

Q

QUICK-CALL II SYSTEM..... F4→F6→F7→F4
 QUICK-CALL II SYSTEM
 OPTIONS..... F4→F6→F7→F4
 Quick-Call II/SingleTone..... F8→F2→F7
 Quick-Call II/SingleTone..... F8→F3→F5
 Quick Key Override..... F4→F6→F3→F9
 Quik-Call II System..... F4→F6→F3

R

RAB 1 Code Type F4→F6→F3→F9→F7
 RAB 1 DTMF Code F4→F6→F3→F9→F7
 RAB 1 MDC Repeater ID F4→F6→F3→F9→F7
 RAB 1 SingleTone (Hz)..... F4→F6→F3→F9→F7
 RAB 2 Code Type F4→F6→F3→F9→F7
 RAB 2 DTMF Code F4→F6→F3→F9→F7
 RAB 2 MDC Repeater ID F4→F6→F3→F9→F7
 RAB 2 SingleTone (Hz)..... F4→F6→F3→F9→F7
 RAB Sidetone..... F4→F6→F7→F2
 RADIO WIDE F4→F3→F5→F8
 RADIO WIDE CONFIGURATION F4→F3
 RADIO WIDE DISPLAY OPTIONS..... F4→F3→F6
 RADIO WIDE EMERGENCY
 OPTIONS..... F4→F3→F2→F7
 RADIO WIDE FEATURES CONFIG..... F4→F3→F3
 RADIO WIDE MENU ITEM
 CONFIG F4→F3→F3→F4
 RADIO WIDE OPTIONS..... F4→F3→F2
 RADIO WIDE OPTIONS..... F4→F3→F2→F9
 RADIO WIDE DISPLAY OPTIONS..... F4→F3→F6
 RADIO WIDE SECURE
 OPTIONS..... F4→F3→F2→F6
 RADIO WIDE SWITCH
 CONFIG F4→F3→F3→F3
 RATED AUDIO F2→F3→F3
 READ RADIO CODEPLUG F3→F2

RECEIVER ALIGNMENT MENU..... F2→F3
 REFERENCE OSCILLATOR F2→F2→F2
 RF Modem..... F4→F4→F2
 RIB..... F9→F3
 RM Base Time (sec) F4→F4→F3
 RSSI..... F2→F3→F7
 RSSI Acceptable Threshold..... F4→F4→F2→F2
 RSSI Acceptable Threshold..... F4→F4→F2→F3
 RSSI Excellent Threshold F4→F4→F2→F2
 RSSI Good Threshold F4→F4→F2→F2
 RSSI OSW Counter F4→F4→F2→F2
 Radio Check F4→F6→F4→F3
 Radio Cloning..... F4→F3→F2
 Radio Codeplug Version F3→F9
 Radio ID F4→F6→F7→F5
 Radio Inhibit F4→F6→F4→F3
 Radio Software Version F3→F9
 Receive F4→F6→F3
 Receive Only F4→F6→F3
 Remote Monitor..... F4→F4→F3
 Repeater Access F4→F6→F3→F9→F7
 Repeater ID..... F4→F6→F4→F5
 Required FLASH software..... F8→F3
 Reset Type F4→F6→F7→F4
 Retry Counter..... F4→F4→F4→F8
 Reverse Burst TOC..... F4→F6→F3→F9
 Revert F4→F6→F3
 Revert Announcement Group F4→F4→F4→F8
 Revert Fleet ID..... F4→F4→F4→F8
 Revert Individual ID..... F4→F4→F4→F8
 Revert PTT-ID F4→F4→F4→F8
 Revert Size Code..... F4→F4→F4→F8
 Revert Subfleet..... F4→F4→F4→F8
 Revert Talkgroup F4→F4→F4→F8
 Rotary Alert F4→F3→F2
 Rx Channel Ranges (MHz)..... F4→F4→F3→F6
 Rx Emphasis..... F4→F6→F3→F9
 Rx F/S Freq (MHz) F4→F4→F4
 Rx Freq F4→F4→F3→F6→F6
 Rx Freq F4→F4→F4→F6
 Rx Freq F4→F4→F4→F7
 Rx Hold Time (sec)..... F4→F3→F5→F8
 Rx Modulation F4→F4→F3→F9
 Rx Modulation F4→F6→F3→F6
 Rx Unmute Delay (ms) F4→F6→F3→F9

S

S/N..... F3→F4
 SAVE CODEPLUG DATA TO
 ARCHIVE..... F3→F5→F3→F7
 SAVE CODEPLUG DATA TO
 ARCHIVE..... F3→F5→F4→F7
 SAVE CODEPLUG DATA TO
 ARCHIVE..... F3→F5→F7
 SAVE CODEPLUG DATA TO
 ARCHIVE..... F3→F5→F8

SAVE CODEPLUG DATA TO

ARCHIVE..... F3→F7
 SCAN LIST..... F4→F3→F5
 SCAN OPTIONS..... F4→F3→F5→F8
 SCREEN COLORS..... F9→F7
 SECURE RECEIVE
 DISCRIMINATOR..... F2→F3→F8
 SECURE TRANSMIT DEVIATION..... F2→F2→F8
 SELECTED TEXT..... F9→F7
 SERVICE MENU..... F2
 SERVICE SOFTWARE CONFIGURATION..... F9
 SIGNALING ALIGNMENT MENU..... F2→F4
 SINGLETONE LIST..... F4→F6→F7→F3
 SINGLETONE SYSTEM..... F4→F6→F7→F2
 SIREN AND PA OPTIONS..... F4→F3→F9→F2
 SMART ZONE PREFERRED
 SITES..... F4→F4→F4→F9→F6
 SMARTNET Operation..... F8→F2→F7
 SMARTNET Operation..... F8→F3→F5
 SMARTNET Type I..... F8→F2→F7
 SMARTNET Type I..... F8→F3→F5→F9
 SQUELCH (12.5 kHz)..... F2→F3→F4
 SQUELCH (20 kHz)..... F2→F3→F5
 SQUELCH (25/30 kHz)..... F2→F3→F6
 SRIB Software Path & FileName..... F9→F3
 STATUS TEXT..... F9→F7
 SUBFLEETS..... F4→F4→F4→F7
 Save Dim State..... F4→F3→F6
 Scan Holdoff Strapping..... F4→F6→F3→F6
 Scan List..... F4→F3→F5
 Scan List..... F4→F4→F4
 Scan List..... F4→F6→F3
 Scan Select..... F4→F6→F3→F6
 Scan Type..... F4→F3→F5
 Secondary ID..... F3→F5
 Secondary ID..... F3→F5→F3
 Secondary ID..... F3→F5→F4
 Secondary ID..... F4→F6→F4→F3
 Secure Equipped..... F4→F3→F2
 Secure Punch Thru..... F4→F3→F2→F6
 Secure/Clear Strapping..... F4→F6→F3→F6
 Sel Call Reset..... F4→F6→F4→F3→F9
 Selectable Keypad Mute..... F4→F3→F2
 Selective Call Decode..... F4→F6→F3→F7
 Selective Call Encode..... F4→F6→F3→F7
 Self Test Alert Tone..... F4→F3→F2
 Serial Number..... F2→F9
 Serial Number..... F3→F5
 Serial Number..... F3→F5→F3
 Serial Number..... F3→F5→F3→F7
 Serial Number..... F3→F5→F4
 Serial Number..... F3→F5→F4→F7
 Serial Number..... F3→F5→F7
 Serial Number..... F3→F5→F8
 Serial Number..... F3→F7
 Serial Number..... F3→F9
 Signalling..... F4→F6→F3

Signalling Muting Type..... F4→F6→F7→F4
 Silent Alarm..... F4→F3→F2→F7
 Silent Mode Change..... F4→F3→F2
 Siren Ignition Sense..... F4→F3→F9→F2
 Site Alias Number..... F4→F4→F3→F9→F8
 Site Alias Text..... F4→F4→F3→F9→F8
 Site Aliasing..... F4→F4→F3→F9
 Site ID..... F4→F4→F3
 Site ID..... F4→F4→F4→F9→F6
 Size Code..... F4→F4→F3
 Size Code..... F4→F4→F4
 Slow Scroll Count..... F4→F3→F6
 Slow Scroll Rate (ms)..... F4→F3→F6
 Smart PTT..... F4→F6→F3→F9
 Smart PTT Quick Key Timer..... F4→F6→F2
 Smart PTT Retry Timer (ms)..... F4→F6→F2
 Smartzone Operation..... F8→F2→F7
 Smartzone Operation..... F8→F3→F5
 Software Option..... F3→F9
 Software Path..... F8→F8
 Spacing..... F4→F4→F3→F6
 Speaker Unmute On Data..... F4→F3→F2→F5
 Speed Optimization..... F9→F3
 Splinter Channel..... F4→F4→F3→F9
 Squelch (Fine Tune)..... F4→F6→F3→F9
 Squelch Type..... F4→F6→F2→F2
 Squelch Type..... F4→F6→F3
 Startsite Operation..... F8→F2→F7
 Startsite Operation..... F8→F3→F5
 Stat Alert Decode Feature..... F8→F2→F7
 Stat Alert Decode Feature..... F8→F3→F5→F9
 Stat Alert Encode Feature..... F8→F2→F7
 Stat Alert Encode Feature..... F8→F3→F5→F9
 Status..... F4→F4→F3→F6
 Status..... F4→F4→F4
 Status..... F4→F4→F4→F6
 Status..... F4→F6→F4→F3
 Status Alias Number..... F4→F4→F3→F9→F6
 Status Alias Number..... F4→F6→F9
 Status Alias Text..... F4→F4→F3→F9→F6
 Status Alias Text..... F4→F6→F9
 Status Aliasing..... F4→F4→F3→F9
 Status Request..... F4→F6→F4→F3
 Std. Audio..... F2→F3→F3
 Strapping..... F4→F4→F4
 Strapping..... F4→F4→F4→F7
 Strapping..... F4→F4→F4→F8
 Subfleet..... F4→F4→F4→F7
 Subflt..... F4→F4→F4→F7
 Supervisor Pool ID..... F4→F4→F4
 Suspend All Scan..... F4→F3→F5→F8
 Switch Labels..... F4→F3→F3→F3
 Sys..... F3→F5
 Sys..... F3→F5→F3
 Sys..... F3→F5→F4
 System..... F4→F4→F3
 System..... F4→F4→F3→F6

System F4→F4→F3→F6→F6
 System F4→F4→F3→F9
 System F4→F6→F7→F2
 System F4→F6→F7→F4
 System F4→F6→F7→F4→F9
 System F4→F6→F7→F5
 System ID F4→F4→F3
 System Key F3→F5
 System Key F4→F4→F3
 System Key F9→F3
 System Package F8→F2
 System Package F8→F3→F5
 System Pretime (ms) F4→F6→F4→F3→F9
 System Search Time (sec) F4→F3→F5→F8
 System Signalling Type F4→F6→F7→F4
 System Type F4→F4→F3
 System Type I II/III F3→F5
 System Version F8→F3→F5
 System ID F4→F4→F4

T

TCMS Path F9→F3
 TCMS Path F3→F4
 TRANSMIT DEVIATION BALANCE... F2→F2→F4
 TRANSMIT DEVIATION LIMIT F2→F2→F5
 TRANSMIT DEVIATION LIMIT F2→F2→F6
 TRANSMIT POWER F2→F2→F3
 TRANSMIT SIGNALING: HIGH F2→F4→F3
 TRANSMIT SIGNALING:
 MDC-1200 F2→F4→F4
 TRANSMITTER ALIGNMENT MENU F2→F2
 TRUNKING MENU F4→F4
 TRUNKING MESSAGE
 ALIAS F4→F4→F3→F9→F7
 TRUNKING PERSONALITY F4→F4→F4
 TRUNKING PERSONALITY
 OPTIONS F4→F4→F4→F9
 TRUNKING RADIO WIDE
 OPTIONS F4→F4→F2
 TRUNKING SITE ALIAS F4→F4→F3→F9→F8
 TRUNKING STATUS ALIAS ... F4→F4→F3→F9→F6
 TRUNKING SUBFLEETS F4→F4→F4→F7
 TRUNKING SYSTEM F4→F4→F3
 TRUNKING SYSTEM OPTIONS... F4→F4→F3→F9
 TRUNKING TALKGROUPS F4→F4→F4→F7
 Tactical F4→F4→F4→F8
 Talk Permit Tone F4→F4→F4
 Talk Permit Tone F4→F4→F4→F9
 Telephone Interconnect F4→F4→F2
 Temp Msg Display Time (ms) F4→F3→F6
 Text Justification F4→F3→F6
 This Call ID F4→F4→F3
 This Call ID (PC I) F4→F4→F4
 This Call ID (PC II) F4→F4→F4
 Time-Out Timer F4→F4→F4
 Time-Out Timer F4→F6→F3
 Time-Out Timer Table (sec) F4→F3→F2→F9

Tlk Grp F4→F4→F4→F7
 Tone (Hz) F4→F6→F7→F3
 Tone Signalling System F4→F6→F3→F9→F7
 Trailing PTT-ID F4→F6→F4→F3
 Transmit Enable Polarity F4→F3→F2→F5
 Trk One Touch Button F8→F2→F7
 Trk One Touch Button F8→F3→F5
 Trunk Remote Monitor F8→F2→F7
 Trunk Remote Monitor F8→F3→F5→F9
 Trunk Item F4→F3→F3→F4
 Trunk Repeater Offset F4→F4→F3→F9
 Trunking System ID F4→F3→F5
 Trunking System Type F4→F3→F5
 Twenty Channel Synthesized F4→F4→F4→F9
 Tx Channel Ranges (MHz) F4→F4→F3→F6
 Tx Clear Alert Tones F4→F3→F2→F6
 Tx Defeat F4→F4→F3
 Tx Deviation F4→F6→F3→F9
 Tx Deviation T/A F4→F6→F3→F9
 Tx Emphasis F4→F6→F3→F9
 Tx F/S Freq (MHz) F4→F4→F4
 Tx Freq F4→F4→F3→F6→F6
 Tx Freq F4→F4→F4→F6
 Tx Inhibit On Busy F4→F6→F3→F7
 Tx Multiplier F4→F6→F4→F3→F9
 Tx Period (sec) F4→F4→F4→F8
 Tx Power Level F4→F6→F3→F9
 Tx Power Select F4→F4→F3→F9

U

UNIVERSAL ID F4→F4→F3
 Unmute Hold-Off (ms) F4→F6→F7→F5
 Unmute Type F4→F6→F3→F7
 Unmute/Mute Type F4→F6→F3→F9
 Upgrades Purchased F8→F3
 Upgrading Radio Block F8→F8→F8
 User-Selectable PL (MPL) F4→F6→F3→F9

V

VOC Activation Time (ms) F4→F4→F2→F3
 VOC Capable F4→F4→F2→F3
 VOC OPTIONS F4→F4→F2→F3
 VOC Pended Emer Time (ms) F4→F4→F2→F3
 VOC Site Lock Time (sec) F4→F4→F2→F3
 VRM100 F4→F4→F4→F9
 VRM100 F4→F6→F3→F9
 VRM100 Capable F4→F3→F2
 VRM100 Fleet F4→F4→F4→F9→F7
 VRM100 High Speed Data F4→F6→F3→F9
 VRM100 OPTIONS F4→F3→F2→F5
 VRM100 Pager ID F4→F4→F4→F9→F7
 VRM100 Size Code F4→F4→F4→F9→F7
 VRM100 SubFleet F4→F4→F4→F9→F7
 VRM100 TRUNK
 OPTIONS F4→F4→F4→F9→F7
 VRM100 Talk Group F4→F4→F4→F9→F7
 VRM500 F8→F2→F7

VRM500..... F8→F3→F5→F9
 VRM500 Capable..... F4→F3→F2
 VRM500 Deaffiliation F4→F4→F4→F9→F7
 VRM500 Pager
 Individual ID F4→F4→F4→F9→F7
 VRM500 Rx DISCRIMINATOR
 LEVEL F2→F3→F9
 VRM500 TRUNK
 OPTIONS F4→F4→F4→F9→F7
 VSP F4→F4→F4→F9
 Variable ID..... F3→F5
 Variable ID..... F3→F5→F3
 Variable ID..... F3→F5→F4
 Variable ID..... F4→F6→F4→F3

W

WAC AMSS FAILSOFT F4→F4→F4→F6

X

XL IC Present F4→F3→F2→F6
 XL Scan Unsilence Duration
 (ms) F4→F3→F2→F6
 XL Transmit..... F4→F6→F3→F6

Z

ZONE TALKGROUP (CHANNEL) F4→F8
 Zn F4→F3→F5
 Zone..... F4→F3→F2
 Zone..... F4→F3→F5
 Zone..... F4→F4→F3
 Zone..... F4→F6→F4→F3
 Zone..... F4→F6→F7→F5
 Zone Name F4→F8
 Zone Number F4→F8
 Zone Text Size F4→F3→F6

Notes

Notes

Glossary



Active Channel	A channel in which the radio is receiving or transmitting a signal.
Adjustment	A means of tuning a radio parameter to a specified value.
Alignment	A means of adjusting any parameter that can be tuned to obtain optimum product performance.
ANI	Automatic Number Identification. Used for access/release codes that are frequently used for system management and billing purposes. ANI numbers can be programmed by the RSS and cannot be changed in the field.
Announcement Group	Grouping structure used in a Type II or Type III Trunking system. An Announcement Group is a large group of radio users who, under normal circumstances, coordinate actions amongst themselves.
Antenna Connector	The UHF/VHF RF coax connector located on the top of the radio and used to connect the antenna to the radio.
Archive File	The contents of the radio's codeplug. A computer file that contains the personality data of a radio. It is standard practice to name archive files according to the radio serial numbers that they relate to.
Archive File Cloning	The procedure of merging data from two codeplugs to copy a customer personality from one radio to another. In the case of archive file cloning, the source of the factory data is an archive file and the source of the tuning data is the target radio.
Asynchronous Communication	A method of data communication in which information is transmitted one character at a time with no specific starting time. Each character is preceded by a start bit and followed by one or more stop bits.
Auto-Affiliation	The ability of radios in a Type II or Type III system to automatically transmit their talkgroup and unit ID information to the Central Controller. Affiliation occurs after the radio has locked on to the control channel frequency. It does not require that the radio user press PTT.
Automatic Retry	The ability of a Portable radio to send up to 16 in-bound signalling words in a four-second period provided the out-bound signalling word is not received from the Central Controller <i>after</i> the radio has made a request to transmit.
Back-up File	A duplicate file of the archive file that can be used if the original archive file becomes damaged or erased.

Base Station Identifier (BSI)	An identifier which is programmed into the Central Controller and sent out in Morse code ID on the lowest frequency Trunked repeater.
Blank Frequency	A channel that is not assigned a transmit frequency.
Blank PL Code	A channel that is not assigned a receive or transmit PL code.
Busy Channel Lockout (BCL)	A feature on Conventional modes that gives “listening privacy”. The radio will not key when there is a carrier on channel unless it is the user’s PL/DPL group. Instead, the user will hear a busy tone while PTT is held. In addition, the user will not be allowed to monitor the channel. If all the users who share the channel have BCL enabled, they have privacy similar to that provided by a Trunked radio system.
Call Alert (CA)	A Stat-Alert signalling feature that is similar to a tone-only or a tone-and-voice pager. The “page” can leave a persisting indication on the target radio. A Call Alert stops the channel scan until the alert is cleared.
Call Light	A visual indicator that flashes when transmission is received.
Call List	A list of IDs from one or more signalling formats that is used to send a message to individual groups.
Carrier	A term that represents any channel activity.
Carrier Squelch	A radio receive mode of operation that uses receiver squelch as the only method of muting the speaker.
Channel	A single path, separated by frequency or time divisions, for transmitting electrical signals. A receive (one-way) or receive-and-transmit (two-way) frequency path.
Cloning	An RSS function which allows quick duplication programming of a radio’s codeplug data to many radios. Electronic tuning/alignment information is the only data not copied.
Cloning Cable	A radio-to-radio connector cable used to program one radio’s personality into another radio.
Codeplug	The contents of the radio’s EEPROM that determine the radio’s personality. This personality information consists of system ID, Unit ID and Fleet/Subfleet/Talkgroup information, as well as the control channel information. The codeplug contains all the features and options stored in the codeplug.
COMport	The logical name of the serial port available on personal computers. They may be COM1, COM2, COM3 or COM4.
Communications Port	See “COMport”.
Connect Tone	A tone generated by the radio over the voice channel to the Trunked Repeater. Connect tone is used as a signal to the Central Controller that a specific voice channel has been assigned. There are eight different connect tones available: 76.60 Hz, 83.72 Hz, 90.00 Hz, 105.88 Hz, 116.13 Hz, 128.57 Hz and 138.46 Hz.

Continuous Assignment	The ability of the Motorola Trunked system to ensure that a radio just coming into service will be sent to the appropriate voice channel to join the rest of the Fleet, Subfleet or Talkgroup. Once a group has been assigned a voice channel, the control channel will continue to transmit the voice channel information for that call for the duration of the call.
Control Channel	One of the four highest frequencies in a Trunking system that is used to provide a continuous two-way communications path between Central Controller and all radios on the system.
CSQ	See "Carrier Squelch".
Data Operated Squelch (DOS)	If enabled, DOS will detect an incoming packet of the same signalling scheme as the radio and squelch the audio for the duration of the packet. A small blip of data will be heard but most of the packet will not be heard.
Defaults	Standard settings that the RSS uses for input/output (I/O) port locations, file locations and display settings. Also, the values a field will automatically contain if a user does not specifically change it.
Default Drive	The disk or diskette drive that the RSS will use to get or save data or files. You can change the default drive from the SERVICE SOFTWARE CONFIGURATION MENU (F9).
DOS	See "Data Operated Squelch".
DPL	A continuous sub-audible data signal that is transmitted along with a carrier. A radio that has DPL on the receive frequency will require both the presence of carrier and the correct DPL code before it will unmute. In addition, if there is DPL on the transmit frequency, the DPL code will be continuously relayed during transmissions made on that channel.
DTMF	Acronym for Dual Tone Multi-Frequency. DTMF is a signalling system used by the telephone system.
EEPROM	Electrically Erasable Programmable Read Only Memory. Used by the radio microcomputer system to store the radio's codeplug data (personality).
Emergency Alarm	A feature that triggers an alarm output on a console when an emergency signalling message is received.
Encoder Features	Features relating to the transmit (or encode) portion of a signalling system(s).
Failsoft	In the event that the Central Controller should fail, the radios in the system will enter a "Conventional" pre-assigned failsoft channel. Each Trunked repeater in the system will key and transmit a data word informing every radio in the system that the system has gone into the failsoft mode and communication will act as a Conventional radio repeater.
Field Choices	A set of direct-entry values (or values that can be scrolled) from which the user may select to populate a field (feature) on an RSS screen.

Fleet	A grouping structure used in Type I Trunking. A fleet is a group of radio users with a common functional responsibility who, under normal circumstances, coordinate actions among themselves.
Fleet Mapping	The process of identifying who needs to talk to whom and how individual radio users should be grouped. The fleet map also addresses expansion needs, that is, how many radios can be added to the system in future.
Frequency	The location of an RF channel operating in the radio spectrum (typically measured in MHz).
Function Keys	The ten (or twelve) keys located on the PC keyboard that are labeled F1 through F10 (or F1 through F12) that perform specific functions within the RSS.
GET	The computer action that transfers data from a radio codeplug or from a radio archive file to the computer's RAM for use by an RSS user. Synonymous with "read".
Group	A collection of radios that communicate with each other.
Handshaking	The data interchange that takes place between the radio and the Central Controller via the control and voice channels. This is to make sure that each side knows that the other is present on the channel and is ready to exchange information or allow voice conversation to proceed.
Hard Disk	An alterable permanent magnetic storage medium with a much larger storage capacity than a diskette, located inside the computer's system unit.
Home Channel	The channel the user was on prior to pushing the SCAN button.
Home Revert	The channel the user will revert to when PTT is pressed while in scan mode unless the scan talkback feature is enabled. Defines the transmit channel requirement for a feature. Typically refers to scan mode operation.
Hz	Hertz, or cycles per second.
kHz	Kilohertz, thousands of cycles per second.
Logic Board	The circuit board within the radio that contains the embedded microprocessor and other logic-related components.
MDC-1200	A Motorola-proprietary signalling format. It is a binary format using 1200-baud minimum shift keying modulation.
Menu	Contains a list of functions that can be selected and performed by pressing a function key. Also see "Screen".
Message	Upon releasing the PTT, a Portable radio will remain on the voice channel for a pre-programmed period of time. This allows a response to be made by other members of the talkgroup without returning to the control channel for another voice channel assignment. Message Trunking is commonly referred to as Hangtime on the repeater. Message Trunking Systems generate less control channel traffic per conversation than Transmission Trunking Systems.

MHz	Megahertz, million of cycles per second.
Mode	A mode is a collection of personality values, such as frequency, PL codes and scan lists, and is assigned a number in the Name field.
Mode Number	The number assigned to a particular mode.
MS-DOS	Microsoft Disk Operating System. DOS is a group of programs that control the way the computer interfaces with other programs, that instructs the computer how to use, read and return information to and from application programs and how to organize/use information on disks.
OmniLink	When an OmniLink feature is enabled, the radio will be allowed to roam from one SmartZone System within an OmniLink System to another SmartZone System within the same OmniLink System.
Operating System	A computer program that coordinates your computer's activities such as memory allocation, file management, input and output operations, communications and interfacing to other application software packages, such as the RSS.
Path	The location of a sub-directory on a disk or diskette. Paths start at the root directory of the disk or diskette and end at the directory containing the desired file. For example, the directory path C:\MRSS\MCS\ARCHIVE shows the hierarchy or ordering of directories that the computer must descend to reach a file located under the ARCHIVE directory.
Path Name	See "Path".
Personality	A term used to describe the data in the radio's codeplug or in an archive file that contains a set of unique, customer-specific features.
Personality File	A file that contains the data to be stored in a radio's EEPROM. This file contains information such as receive frequency, transmit frequency, squelch code, and so on.
PL	Private-Line Coded Squelch. A channel that has PL on the receive frequency will require both the presence of a carrier as well as the correct PL code before it will unmute. Also, if PL is on the transmit frequency, all transmissions on that channel will be modulated at a sub-audible level by the PL code. Modulation is continuous.
PL Code	A two-digit alphanumeric code for specific sub-audible tones.
Pop-up Window	A message area that overlaps on a data entry/display area; used to indicate a data entry error or to verify destructive commands and provide function key choices for the next course of action. Also known as the Dialog Box.
Port	A parallel or serial hardware interface connection at the back of a computer used to communicate with other hardware devices such as a radio, a modem or a printer. A port is normally designated by a slot position such as COM1, COM2, COM3 or COM4.
Priority Channel	A channel that is deemed more important to the radio operator than any other. The radio is required to always unmute on activity there

even though receiving activity on another channel during priority scan.

Priority Levels	A number given to each radio user on a Trunked system to allow system access to the most critical users during busy periods. Assignment of priority levels is controlled by the System Manager. Three levels of priority are available on a Privacy Plus System and five levels are available on Type I SMARTNET system.
Priority Sample Rate	The rate at which the priority channel is checked for activity in priority scan.
Private-Line	See "PL".
Privacy Plus	Privacy Plus is a type of Trunking system which is limited in the options it provides to radio users. The system does not have emergency or dynamic regrouping capabilities. Most shared (Public) Trunking Systems are of the Privacy Plus variety.
Program Tree	A figurative term used to describe the organization of a multi-level menu-driven software program.
PTT	Push-To-Talk feature or button.
PTT-ID	Push-To-Talk IDentification. A feature that sends your radio's identification number on each transmission.
Queuing	A method of servicing users which is used when a Trunking system is busy. The Central Controller stores a radio's request to transmit and makes determinations as to what radio will be serviced on a First-In First-Out (FIFO) basis.
Quik- Call II	A two-tone sequential tone signalling system.
Radio Check Software	A signalling feature that lets your radio be polled to see if the radio is within range and turned on. The user receives no indication of the poll, except perhaps a brief lighting of the transmit or busy light.
Radio Interface Box	See "RIB".
Radio Interface Cable	A cable that allows the radio to be connected (interfaced) to a host computer for programming or tuning purposes.
Radio Service Software	Software purchased by Motorola product resellers through a license agreement that is delivered on a 3-1/2" diskette(s) and used to program two-way radios with a unique set of features called personalities.
RAM	Random Access Memory. A computer's RAM is used to store the contents of the current workspace. The radio's RAM is loaded with a copy of the EEPROM data. The program will sometimes write to the radio's RAM to temporarily change certain features such that the user can get immediate feedback. These changes will not become permanent in the radio's codeplug until the radio is programmed.
READ	The means by which a radio's codeplug information is transferred from the radio's EEPROM to the workspace via the RIB.
Receive Frequency	The center of the receive channel in MHz.

Recent User Priority	The ability of the Motorola Central Controller to ensure uninterrupted communications to a recent user of the Trunked system. Recent User Priority ensures that a group engaged in a conversation will get priority access even if there is a significant delay between transmissions.
Repeater	An electric device with transmit and receive capabilities. A repeater will re-transmit information at 125, 70, or 35 Watts of power. A Trunked repeater used in 800 MHz Trunking systems will typically have transmit and receive frequencies separated by 45 MHz depending upon the original communications system configuration.
RIB	Radio Interface Box. Used to connect a computer system to a radio for the purpose of communication between the radio and the computer. The RIB consists of level-shifting circuits that convert the standard RS-232 voltage levels of the computer's asynchronous serial interface to the single-ended voltage levels present on the Serial Bus contacts of the radio's feature connector. An appropriate RIB-to-radio cable and RIB-to-computer cable must be used in conjunction with the RIB.
RS-232	An asynchronous, serial data transmission standard for computers that defines the required sequencing, timing and hardware interface.
Scan	The process by which the radio checks receive frequencies stored in a list for activity. If activity is found, the radio is locked on that frequency until the frequency is no longer active.
Serial Ports	See "Port".
Signalling Systems	Systems used to alert radio operators or to perform specific functions using the radio.
SMARTNET	A type of Trunking system primarily used in support of public safety and industrial communication systems. This type of system has emergency and dynamic regrouping capabilities.
Squelch	A radio circuit which eliminates noise from the loudspeaker when a "received" signal is not present.
Synthesizer	The frequency generating unit of a radio.
System Central	Referred to as Central Controller, this is the heart of Motorola's Trunking system. The Central Controller is a software controlled, computer-driven device that receives and generates data for the Trunked radios assigned to it. The Central Controller is responsible for monitoring and directing the operations of the Trunked repeaters.
System ID	A number assigned to a Trunked system distinguishing it from other systems. The system ID is sent out every three seconds on the Control Channel.
Talkaround Frequency	A frequency used for simplex conversions or radio-to-radio communications without the use of a repeater.
Talkback	Indicates that a call can be answered by pressing PTT and dispatching a response.
Talkback scan	Allows the operator to respond to a call on the same channel as the call during the talkback time in scan.

Talkgroup	A group of users in a Type II or Type III system.
Talk Permit Tone	A brief series of beeps that provides radio operators with an indication that a voice channel is available for use and is assigned to them.
Talk Prohibit Tone	An audible tone (honk) heard from the radio's speaker when PTT is pressed. The tone will be heard when the radio is out of range of the system or it is programmed with the incorrect system information.
Time-Out Timer (TOT)	A function that limits the transmission period to a pre-defined time. The radio will automatically stop transmitting when the timer goes off after the pre-defined time and will generate an alert tone to notify the user that no transmission is taking place.
Transmission Trunking	Upon releasing the PTT, the radio will return to monitor the Control Channel if the user desires to initiate another call.
Trunking	The automatic sharing of communications paths between a large number of users.
Type I	A type of Trunking that is composed of Fleets and Subfleets and is limited by the size of codes of those groups. A Type I system handshaking includes sending of the Acknowledge Tone and High Speed Handshake.
Type II	A type of Trunking system that is composed of Announcement Groups and Talkgroups. A Type II system is limited on talkgroups and individual ID combinations to 48,000 IDs and 4,000 talkgroups per system. The Type II system handshaking does not include sending Acknowledge tone and High Speed Handshake.
Type III	A type of Trunking system composed of Fleets, Subfleets and Talkgroups. This Trunking type supports both Type I and Type II Handshaking. This Trunking type also allows Type I radios to communicate with Type II radios on the same voice channel.
Unit ID	The electronic tuning/alignment information of a particular radio.
Universal ID	A particular personality in a radio unit which is chosen as the one whose Trunking identity will always be used to address this unit. In this manner, a unit would respond to an individual call (Private Call, Call Alert, Phone Interconnect, etc.) regardless of the current personality chosen.
User Scan	Scan type which is programmable through the front panel buttons on the radio.
Voice Channel	A Trunked repeater that is used to transmit and receive data and voice from the radios on the system.
Wide Area Call	A call in a wide area coverage system which utilizes a voice channel in all sites of the system.
Zone	A collection of channels which have something in common.

Index

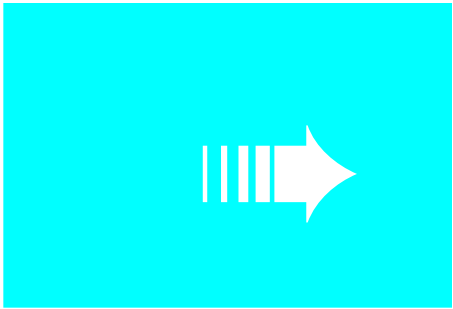

A

A/G Failsoft	171
A/G Failsoft Frequency	171
Acceptable Threshold	142
Access Codes	120–121
Access Type	152, 180, 222
Ack Alert Tone	233
Acknowledge Alert Tone	228
Add Conventional Item	112
Add DEK Box	117
Add Number	118
Add Truked Item	112
Addressing	248
Addressing Mode	248
Aff. (affiliating) Hold Off	140
Affiliation Type (Type II/III)	150
Alarm Options	89, 135
Alarm Rearm Option	135
Alert Tone Volume Offset	91
Alert Tones	91
Alias	149
Alt Display Time	132
Anatomy of a Menu	11
Anatomy of a Screen	13
Announcement Group	170
Archive File Name	81
Archive File, how to delete	75, 264
Archive Path	24
How to configure	23
Assembling The Hardware	4
Auto Access Code Select	215
Auto Dial Holdoff	139
Auto Reset Carr Ovrdr	244
Auto Reset Duration	244
Auto Reset Time	232
Auto Scan	187
Auto Sel Call Transmit	213
Auxiliary Menu	239
Auxiliary System	198

B

Background Color	27
Back-up Path, how to set up	18
Banner Screen	10
Baud Rate	249

Block Pending CA/PC	93
Bootstrap Code Path & File Name	24
Busy LED	218
Busy Override Chirp Ack	141
Busy Override Delay	140
Button	163
Button Configuration	105

C

Call Alert Decode	212
Call Alert Encode	213
Call Alert Operation	172
Call ID	237
Call ID List	174
Call Text	237
Caller ID	134
Car Radio Mute	102
Car Radio Mute Timer	103
Carrier Detect Required	129
Caution, what it means	3
Change Archive	264
Change/View Menu	19, 87
Changing A Field Value	14
Channel	94, 150
Channel Assign Type	159
Channel Assignment	148, 153
Channel Assignment Data	153
Channel Bandwidth	159
Channel Delay	101
Channel Grant Polarity	97
Channel Name	254
Channel Number	254
Channel Range	154
Channel Spacing	220
Channel Text Size	131
Clone Radios, how to	35, 73, 77
Cloning	
Full Clone	78
Limited Clone	77–78
Coast Time	231, 250
Code	202, 245
Codeplug Version	83
Communications Port	23, 25
How to configure	23
Communications Test, how to perform	23
Complete Menu Map	15

Computer Defaults, how to specify	17
Computer-to-Radio Communication	
Error Codes	273
Configuring Paths and Port	23
Connect Tone	149
Console Acknowledgement Required	181
Control Channel	148, 153, 155, 176
Control Station Equipped	92
Controller Board Initialization	39, 68
Conventional Data Configuration	88
Conventional ID	77
Conventional Item	113
Conventional Menu	198
Conventional Message Alias List	251
Conventional Personality	198, 203, 217
How to Add	203
How to Delete	203
How to Print Data	256
Conventional Personality Phone Options	215
Conventional Personality RAC Options	221
Conventional Print Menu	259
Conventional Radio Wide Options	198–199
Conventional Signalling System Features	279
Conventional Status Alias List	252
Conversation Type	152, 187
Coverage Type	149
Current Archive	264
Current FLASHcode	269

D

Data Mode Request Polarity	97
Data On Failsoft	96
Data Operated Squelch (DOS)	231
Deaccess Codes	120–121
Decoder 1 Call Type	244
Decoder 2 Call Type	244
Decoder Option	245
DEK Configuration	105
Delete Conventional Item	112
DELETE DEK BOX	117
Delete Number	118
Delete Trunked Item	112
Designated Tx Mem	126
Detections Required	247
Dialing Options	118, 122
Digit Duration	123, 160, 216
Direct Frequency Enabled	200
Direct/Talkaround	204
Direct-entry fields	14
Disconnect On Data	96
Disk Codeplug Files, how to read	21
Display Options	89, 131
Display Site Trunking	141
DOS (Data Squelch)	231, 249
DPL Code	202
DPL Codes	208, 277

DPL Invert	202, 208
DTMF Access Codes	118
DTMF Access Timing Table	216
DTMF Access/Deaccess Codes	120
DTMF Deaccess Codes	118
DTMF Digit Hangtime	122
DTMF Pause Time	122
DTMF Transmit Deviation	64
Duplicate II/III ID	77
Dynamic Priority	125
Dynamic Regrouping	150

E

Echo Mute Time (ms)	210
Electric Stop	91
Emer Priority TX Inhibit	232
Emergency	206, 228
Emergency Alarm	180, 250
Emergency Call	180
Emergency Data Configuration	179
Emergency Hot Mic	183
Emergency Limited Patience	232
Emergency Options	90, 168
Emergency Receive	132
Emergency Type	228
End (Channel Range)	154
Enhancement Options	267–268
Exit the RSS, how to	18, 36
Ext Alarm Delay	135

F

Factory Order Number	269
Failsoft	178
Failsoft Frequency	178
Failsoft Hold Time	130
Failsoft Hold Time (sec)	130
Failsoft Inactivity	140
Failsoft Type	171
Fast Scroll Rate	132
Feature Options	89
Field Value, how to change	14
File Maintenance Menu	20, 262
File Name	264
File, how to delete	75, 262
Fill in the Scan List	
How to	33
Filter Constants K1, K2, and K3	143
Filter Threshold Constants T1, T2, and T3	144
FLASH Radio	272
FLASH Software Path	24
FLASHcode	69
FLASHport Upgrade Menu	266
Fleet ID	151, 170
Frame Color	27
Frequency	176, 206
Front-End Filter Alignment	55

Full Cloning	78
Full Spectrum CC Scan	141
Full Spectrum CC Scan Timer	141
Function Key ID Area	11

G

GE STAR System	239, 248
GE STAR System #	206
Get Codeplug Data From Archive File	75
Get/Save/Program Menu	19, 71–72
Global TX Multiplier	233
Good Threshold	142

H

Hard Disk, how to organize	7
Hardware, how to assemble	4
HearClear	159
Highlight Color	27
Home Mode Selection	94
Horn & Light Duration	135
Horn and Lights	135
Hot DTMF Timing	160
Hot Keypad	205
Hot Keypad (DTMF)	173
How to	

Add a Conventional Item	112
Add a Conventional Personality	203
Add a DEK Box	117
Add a New Phone Number Entry	118
Add a Scan List	124
Add a Trunked Item	112
Add a Trunking Personality	168
Add a Trunking System	148
Add a Zone	253
Adjust Squelch	57–59
Align Transmit Deviation Limit	47, 49
Clone Radios	77
Configure Paths and Port	23
Configure the PC	22
Create a Directory	263
Delete a Conventional Item	112
Delete a Dek Box	117
Delete a File	75, 262, 264
Delete a New Phone Number Entry	118
Delete a Personality	203
Delete a Scan List	124
Delete a Trunked Item	112
Delete a Trunking Personality	168
Delete a Trunking System	148
Delete a Zone	253
Delete an Archive File	264
Exit the RSS	18, 36
Install the RSS	8
Load an Archive File	73
MERGE TCMS	73
Perform a Communications Test	23

Print Alarm Options	257
Print Conventional Data	256
Print Display Options	257
Print Feature Options	257
Print Phone Options	257
Print Radio Configuration Data	255–256
Print Radio Options	257
Print Scan Options	257
Print Trunking Data	256
Program a Basic MCS 2000 Radio	29
Program Data into Radio Codeplug	34
Read Codeplug Data from Archive Files	21
Read Codeplug Data from Radio	21, 73
Save an Archive File	73
Save Codeplug Data to Archive File	80
Save Configuration Information	23
Service the Radio Using the RSS	37
Set Screen Colors	22, 26
Set Up Back-up File Paths	18
Set Up Computer Configuration	22
Specify Directory Paths for Archive Files	75
Use this Manual	3
View Radio Programming History	73
Hub Defeats PL	200

I

Ignition Switch	111
Ignore Data Display	97
Ignored Site Resource Preference	189–190
Impolite Retries	232, 250
Index	163
Individual ID	149, 152, 171
Information fields	14
Initial Delay	123, 160, 216
Initial Squelch Type	244
Install the RSS, how to	8
Instruction Area	11
Integer Delay	216
Interdigit Delay	123, 160
Inter-Packet Time	231
Inter-Tone Duration	246
Introduction	1
ISW Window Adjust	139

L

Last Programmed	83
Leading PTT-ID	226
Limited Clone	78
Limited Patience Time	231
Long Press/Emer Duration	93
Long Tone Duration	245

M

Main Menu	19
Man Acc Live Dialing	118

Mandatory Password	133
Max Password Length	133
Maximum Channels (Talkgroups)	94
MCS 2000 Features	279
MDC Call ID List	224
MDC Call List Table	236
MDC Configuration	198
MDC Configuration Menu	224
MDC Emergency Options	225
MDC Hot Mic Emergency	229
MDC Hot Mic TX Period	229
MDC Options	203, 212
MDC Repeater ID	238
MDC System	225–226, 230
MDC System #	206
MDC System Options	224, 230
MDC System Remote Options	234
MDC Unlimited Calling	214
Menu Item Configuration	105
Message	173, 227
Message Alias	158, 165
Message Alias Number	165, 251
Message Alias Text	165, 251
Message Aliasing	160
Message Text	27
Message Trunked	187
Message Trunked Systems	152
Mic AGC	102
Minimum Alert Tone Volume	91
Mode/Channel Assignment	88
Model Number	81, 83
Monitor Hold Time	129
Monitor Type	27
Monitor w/Silent Emergency	250
More Conventional Options	204
More Conventional Personality Options	217
More Emergency Options	229
More MDC Options	225
More Quik-Call II Options	243
More Radio Wide Options	90
More Trunking Options	148, 168
MPL List	199
MPL List Configuration	201
MPL Name	201
MPL Number	201

N

Native Language	132
Navigate Through RSS, how to	12
New FLASHcode	269
New Softpot Value 44, 46, 48, 50–51, 53, 55–62, 64–65,	67
Non-Priority Members	126
Non-Tactical	181
Non-XL Scan Unsilence Duration	99
Nuisance Mode Delete	128

O

Observe Window Duration	246
OmniLink	150
One-Touch Button Options	158, 162
Operation	231
Out of Range	91
Override Timer	218

P

Password	133
PC, how to configure	22
Periodic Keyfail Alert Tone	98
Permanent Horn & Lights	135
Personality	204, 212, 215, 217, 222
How to Add	203
How to Delete	203
Personality MDC Options	212
Personality Number	178, 254
Personality Type	254
Phone Configuration	118
Phone Dialing	122
Phone DTMF Timing	160
Phone Interconnect	173
Phone Num Display Format	119
Phone Number	119
Phone Operation	205
Phone Options	204, 215
Phone Text	119
Phone TX Options	89
PL Code	207
Polite Retries	232
Pop-up Background Color	27
Portable Products Test Set	4
Preamble During Pretime	230
Prefer Status	189
Preferred Sites	186, 189–190
Prerequisites	2
Pretime (ms)	233
Pretime Duration	249
Primary ID	226
Print Alarm Options	257
Print Button and Switch Options	257
Print Conventional Data	256
Print Display Options	257
Print Menu	20, 256
Print Phone Options	257
Print Radio Codeplug Data Summary	256
Print Radio Configuration	256
Print Radio Options	257
Print Radio Wide Features Configuration Menu 257	
Print Scan Options	257
Print Trunking Data	256
Print Zone/Channel Assignment Information	256
Priority 1 Member	126
Priority 1 Type	125

Priority 2 Member	126	Radio Wide Options	90, 98, 100, 102
Priority 2 Type	125	Radio Wide Switch Configuration	111
Priority Chan Marking	129	Rated Audio Alignment	56
Priority Scan Alert	128	Read Radio Codeplug	73–74
Private Call	163	Read Serial Number	77
Private Call Operation	172	Receive Alignment Menu	54
Private Call Type	172	Receive Only	204
Program	34	Received Signal Strength Indication	60, 141
Program Mode/Channel Features	31	Receiver Alignment	39
Program Radio	73	Reference Oscillator Alignment	41–42
Program Source	81, 84	Reference Oscillator, how to align	42
Program Zone/Channel Features	33	Remote Mon/Radio Trace	234
Programmable Features	1	Remote Monitor	150
Programming History	83	Remote Radio Mode	234
Programming the Radio's Codeplug	82	Repeater Access	222
Proper Code Detect	187, 210	Repeater ID	238
Protocol Type	169, 179	Required FLASH Software	269
PTT Code Type	223	Reset Type	244
PTT DTMF Code	223	Retrieve Archive File	75
PTT- ID	187	Retry Counter	181
PTT MDC Repeater ID	223	Reverse Burst TOC	218
PTT Sidetone	228, 241	Revert Announcement Group	184
PTT Singletone	223	Revert Announcement Group Strapping	184
PTT-ID	206	Revert Fleet ID	184
PTT-ID Sidetone	226, 249	Revert Fleet ID Strapping	184
PTT-ID Type	249	Revert Fleet ID/Subfleet	184
Q			
Quick Key Override	218	Revert PTT-ID	181
Quik-Call II System	239, 243	Revert Size Code	183
Quik-Call II System #	206	Revert Subfleet	184
R			
RAB 1 Code Type	222	Revert Subfleet Strapping	185
RAB 1 DTMF Code	222	Revert Talkgroup	184
RAB 1 MDC Repeater ID	222	Revert Talkgroup Strapping	185
RAB 1 Singletone	222	RF Modem	139
RAB 2 Code Type	223	RIB	4, 25
RAB 2 Singletone	223	RIB Power Supply	4
RAB Sidetone	241	RIB-to-Radio Cable	4
RAC (Repeater Access Code)	233	RKN4047A	4
RAC Options	217, 221	RLN1015B	4
Radio Check	227	RM Base Time	150
Radio Cloning	94	Rollover Alert	91
Radio Codeplug Data, how to read	21	Rotary Alert	91
Radio Codeplug Version	83	RSS Location ID Area	11
Radio Configuration Data, how to print	255	RSS Service Functions	1
Radio ID	249	RSS Start-Up Procedure	9
Radio Inhibit	227	RSSI	60
Radio Interface Box	4	RSSI Acceptable Threshold	141, 145
Radio Lock	133	RSSI Excellent Threshold	142
Radio Options	89	RSSI Good Threshold	142
Radio Software Version	83	RSSI OSW Counter	141
Radio Wide Configuration Menu	88–89	RSSI Threshold Constants	142
Radio Wide Features Configuration Menu	105	Rx Base Time (sec)	235
Radio Wide Menu Item Configuration	112	Rx Emphasis	219
		RX Frequency	156, 178
		Rx Hold Time	129
		RX Modulation	159, 210
		RX Unmute Delay	218

S

Save Archive	73, 80
Save Configuration Information	23
Save Dim State	132
Scan Holdoff Strapping	210
Scan List	125, 174, 205
Scan List and Options	124
Scan Options	89, 124, 128
Scan Select	210
Scan Type	125
Scrollable fields	14
Secondary ID	226
SECURE Equipped	95
SECURE Options	90, 203, 209
Secure Punch Thru	99
SECURE Receive Discriminator Level	61
SECURE Transmit Deviation	41, 51
Secure/Clear Strapping	209
Sel Call Reset	231
Selectable Keypad Mute	93
Selected Text Color	27
Selective Call Decode	213
Self Test Alert Tone	91
Serial Number	81, 83
How to read	77
Service Menu	19, 38, 40
Setting a Default Port	18
Setting Default Archive and Backup Paths	18
Setting RSS Computer Defaults	17
Setting Screen Colors	26
Setup Computer Configuration	22
Setup Configuration Screen	20
Sidetone	233
Signalling	205
Signalling Alignment	39
Signalling Alignment Menu	63
Signalling Muting Type	244
Silent Alarm	100
Singletone List	239, 242
Singletone System	239–240
Site Alias	158
Site Alias Number	166
Site Alias Text	166
Site Aliasing	160
Site ID	149, 189, 191
Site Path	24
Size Code	151, 169
Slow Scroll Count	132
Slow Scroll Rate	132
Smart PTT	217
Smart PTT Quick Key Timer	199
Smart PTT Retry Timer	199
Smart Radio Interface Box	4
Smart RIB Power Supply	4
SMARTZONE Environment	138, 140
SMARTZONE Preferred Sites	186, 189

Software Option	83
Software Version	83
Spacing	154
Speaker Unmute On Data	96
Splinter Channel (800 MHz Only)	159
Squelch (Fine Tune)	219
Squelch Attenuator (12.5 kHz) Alignment	57
Squelch Attenuator (20 kHz) Alignment	58
Squelch Attenuator (25/30 kHz) Alignment	59
Squelch Type	201, 207
SRIB	4
SRIB Software Path & File Name	24
STAR System	239
Start (Channel Range)	154
Start The RSS, how to	8
Status	154, 173, 175, 227
Status Alias	158, 164, 198
Status Alias Number	164, 252
Status Alias Text	164, 252
Status Aliasing	160
Status Request	227
Status Text Color	27
Std. Audio	56
Strapping	170, 178
Subfleet	177–178
Subfleets	168
Suspend All Scan	129
Switch Configuration	105
System	148, 154, 158, 248
System ID	148
System Key	148
System Pretime	230
System Search Time	130
System Signalling Type	243
System Type	148
System/ID	169

T

Tactical	181
Talk Permit Tone	171, 187
Talkgroup	178
Talkgroups	168
TCMS Merge Procedure	76
TCMS Path	76
Telephone Interconnect	139
Temp Msg Display Time	132
Text Color	27
Text Justification	131
This Call ID	152
This Call ID (PC I)	174
This Call ID (PC II)	174
Time-Out Timer (TOT)	171, 204
Time-Out Timer Table	103
Toggle PTT	64
Tone	242
Tone Duration	241

Tone Pretime	240
Tone Signalling System	222
TPL Frequencies and Codes	275
Trailing PTT-ID	227
Transmission Trunked	187
Transmission Trunked Systems	152
Transmit Current Limit	41, 52
Transmit Deviation Balance (Compensation)	
Alignment	41, 45
Transmit Deviation Limit Alignment	41, 47
Reference Softpot	49
Transmit Enable Polarity	96
Transmit Power Alignment	41, 43
Transmit Signalling	
High Speed	65
MDC-1200	66
Transmitter Alignment	39
Transmitter Alignment Menu	40
Transmitter Deviation Limit Alignment	
Reference Softpot	41
Transmitter Power, how to adjust	43, 46–47, 49
Trunk Item	115
Trunk Repeater Offset	159
Trunking Call List	137
Trunking Call List Table	197
Trunking Data Configuration	88
Trunking Emergency Data Configuration	179
Trunking Menu	137
Trunking Personality	137, 167, 169
Trunking Print Menu	258
Trunking Radio Wide Options	137–138
Trunking Signalling System Features	280
Trunking Subfleets	177
Trunking System	137
Trunking System ID	127
Trunking System Options	157
Trunking System Type	127
Trunking Systems	147
Tx Base Time (sec)	235
Tx Clear Alert Tones	98
TX Defeat	152
Tx Deviation	220
Tx Deviation T/A	220
Tx Emphasis	219
TX Frequency	156, 178
TX Inhibit On Busy	214
TX Multiplier	233
TX Period	183
TX Power Level	218
TX Power Select	159
Type	169

U

Universal ID (Type I Only)	151
Unmute Hold-Off	249
Unmute Type	213

Unmute/Mute Type	218
Upgrade Radio	266, 272
Upgrades Purchased	269
Upgrades Remaining	269
User-Selectable PL (MPL)	219
Using This Manual	3

V

Variable ID	226
VC RSSI ACCpt Threshold (Voice Channel RSSI Acceptable Threshold)	142
View Features	270
View FLASHkey Configuration	266, 269
View History	73
View Radio Configuration	266–267
VOC Activation Time	146
VOC Options	138, 145
VOC Pended Emer Time	146
Voice-On-Control Capable	145
Voice-On-Control Options	138, 145
Voice-On-Control Site Lock Time	146
Voting Scan	130
VRM Options	90, 186
VRM100	187, 220
VRM100 Capable	92
VRM100 Fleet	194
VRM100 High Speed Data	220
VRM100 Options	96
VRM100 Pager ID	193
VRM100 Size Code	193
VRM100 Subfleet	194
VRM100 Talkgroup	193
VRM100 Trunk Options	192
VRM500 Capable	92
VRM500 Deaffiliation	195
VRM500 Pager Individual ID	195
VRM500 Receive Discriminator Level	62
VRM500 Trunk Options	195

W

WAC AMSS	168, 175
Warning, what it means	3
What's On The RSS Diskettes	6
Working Area	11

X

XL IC Present	98
XL Scan Unsquench Duration	99
XL Transmit	210

Z

Zone	94, 150
Zone Name	254
Zone Number	254
Zone Switch Debounce Timer (sec)	160

Zone Text Size	131
Zone/Talkgroup (Channel) Assignment	253



RADIO SERVICE SOFTWARE
USER'S GUIDE QUESTIONNAIRE

At Motorola, we believe that comments from users provide valuable information for producing high-quality User's Guides. You can help us improve the next revision of this manual by filling out this form and sending it to us.

With reference to Manual No. 68-81081C15-E
MCS 2000

Use the following scale to answer each question listed below. If you have a specific comment about any section, please write it in the space below the appropriate question.

Strongly Agree 1	Agree 2	Disagree 3	Strongly Disagree 4	
				1. The list of required equipment and the setup procedure are clear and complete. 1 2 3 4
				2. The procedure for backing up and installing the software is clear and complete. 1 2 3 4
				3. The explanations of keyboard commands and screen arrangement are clear. 1 2 3 4
				4. The explanation of the Get/Save procedures is clear and complete. 1 2 3 4
				5. The explanation of the Change/View procedures is clear and complete. 1 2 3 4
				6. The explanation of the Programming procedures is clear and complete. 1 2 3 4
				7. The explanation of the Service/Alignment procedures is clear and complete. 1 2 3 4
				8. The explanation of how to print the codeplug is clear and complete. 1 2 3 4
				9. The Table of Contents and Index are complete and accurate. 1 2 3 4
				10. The illustrations and tables added to the understanding of the explanations. 1 2 3 4
				11. The Glossary and List of Abbreviations are helpful. 1 2 3 4
				12. The User's Guide is well organized and helpful. 1 2 3 4



NO POSTAGE
NECESSARY
IF MAILED
IN THE
UNITED STATES

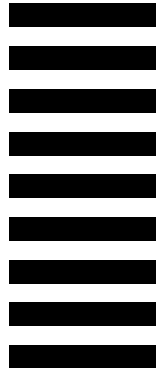

BUSINESS REPLY MAIL
FIRST CLASS MAIL PERMIT NO 9040 FT. LAUDERDALE, FL

POSTAGE WILL BE PAID BY ADDRESSEE



MOTOROLA

Attention: Technical Communications
8000 W. Sunrise Boulevard
Ft. Lauderdale, FL 33322



FOLD

FOLD

Please identify any errors you may have found and provide any suggestions you may have for improving the next version of this manual.

Name: _____

Company: _____

Customer COSC MSS FTR Other

Address: _____

City/State/Zip: _____

Phone Number (Please include Area Code): _____

PLEASE USE TAPE TO SEAL
POSTAL REGULATIONS PROHIBIT USE OF STAPLES



68P81081C15-E

Motorola, Inc.
8000 West Sunrise Boulevard
Fort Lauderdale, FL 33322