

ANT-20SE
Advanced Network Tester
“SONET Version”

BN 3060/02

Software Version 7.20

Operating Manual

BN 3060/98.22



Please direct all enquiries to your local Wavetek Wandel Goltermann sales company. The addresses are given at the end of this handbook.

Copyrights

This product or parts of it are based upon Recommendations and/or Standards of the Standardization Sector of the International Telecommunication Union - ITU-T and/or of the European Telecommunications Standards Institute - ETSI. These Recommendations and Standards are subject to copyrights of these organizations. Without written permission of the ITU-T and/or ETSI it is not permitted to copy ITU-T Recommendations or ETSI standards or parts thereof and/or make them available to third parties.

Wavetek Wandel Goltermann
Eningen GmbH & Co.
Mühleweg 5, 72800 Eningen u. A.
© 2000

Author: MDD/TD
Translator: John Nutley
Order no.: BN 3060/98.22
Edition: 02/00.07 (V 7.20)

Previous edition:
01/00.04 (V 7.1)

Subject to change without notice.
Our normal guarantee and delivery
terms apply.

Printed in Germany

Test Sequencer for ANT-20SE (Demo)

CVI Application Test Sequences

Dear customer,

your ANT-20SE now comes with a pre-installed demo version of our ANT-20SE test sequencer tool, which belongs to the CATS (= CVI Application Test Sequences) family of products from Wavetek Wandel Goltermann.

CATS is a test automation software based on the popular National Instruments product "Lab Windows CVI Test Executive", and it may be used to make routine, consecutive test jobs in

- R&D
- Acceptance Testing
- Installation
- Troubleshooting

as easy as the click of a mouse button.

CATS usually runs on a Windows PC and can control one or more test instruments in small Automatic Test Systems via the IEEE bus or other communication interfaces.

Since the ANT-20SE itself is a PC-based test instrument, Wavetek Wandel Goltermann provide the unique ANT-20SE Test Sequencer as a stand-alone application that runs on the instrument's internal PC. Hence, no external controller PC is needed to take full advantage of this test automation tool.

Operation of the ANT-20SE Test Sequencer Demo

You may start the demo version by leaving the ANT-20SE user interface and then double clicking on the ANT-20SE Test Sequencer icon in the Windows Program Manager.

Please follow these hints to walk your way through the demo

The demo is not protected by a password. When you are prompted by the program to enter your user name and password, simply press the "Enter" key. The preset sequence will then be loaded automatically. Start the sequence by clicking on the "Test UUT" button. You can enter any text you like in the "UUT No." field.

The preset demo sequences "_DEMO...SQU" are a selection of typical test cases with loop measurements between the generator and receiver of the ANT-20SE.

You may change the individual parameters in a test case by double-clicking on the appropriate line in the display. The sequence can be edited from the "SEQUENCE / EDIT SEQUENCE" menu.

You can also create your own test sequence using the demo. Use the test cases provided by Wavetek Wandel Goltermann as templates. This test sequence cannot be saved for subsequent use.

We hope you find the demo useful. If you want to know more about the ANT-20SE Test Sequencer and the CATS product range, please contact your local Wavetek Wandel Goltermann sales engineer.

If you have questions or suggestions regarding this demo, please contact Walter Besse at:

Email: walter.besse@wwgsolutions.com

or

FAX: --49 7121 862 054 c/o Walter Besse.

Introduction	1
Getting started	2
Operating Fundamentals	3
Virtual Instruments	4
Application Guide	5
Standards/Abbreviations	6
Technical Background	7
Maintenance	8
Remote Operation	9
Specifications	10
	11
Index	12



Contents

Introduction

- 1 The ANT-20SE conceptI-1
- 2 ANT-20SE: Supremely easy to use.....I-4

Getting Started

- 1 Safety instructionsG-1
- 2 Packing and unpacking, transportG-6
- 3 Power supplyG-8
- 4 Instrument checklist.....G-11
- 5 Data backupG-11

Operating Fundamentals

- 1 Control elementsO-1
- 2 Basic operation.....O-6
- 3 Switching on the ANT-20SEO-6
- 4 ANT-20SE windowsO-11
- 5 Creating, saving and loading applicationsO-19
- 6 MeasuringO-25
- 7 On-line help.....O-31
- 8 How to use the windowsO-32
- 9 Printing and exporting resultsO-35
- 10 ANT-20SE behavior in the event of an AC power failureO-42

Virtual instruments

- 1 Overview VI-1
- 2 Signal Structure VI-3
- 3 Anomaly/Defect Insertion VI-12
- 4 Anomaly/Defect Analyzer VI-14



- 5 Overhead Generator.....VI-23
- 6 Overhead Analyzer.....VI-27
- 7 Pointer Generator.....VI-32
- 8 Pointer Analyzer.....VI-35
- 9 PDH Generator/Analyzer.....VI-38
- 10 Performance Analysis.....VI-41

Application Guide

- 1 Introduction.....A-1
- 2 In-Service Monitoring.....A-5
- 3 Automatic Trouble Scan function.....A-7
- 4 Automatic Scan function.....A-10
- 5 Automatic Search function.....A-12
- 6 APS switching time measurement.....A-14
- 7 Bit error rate test (BERT).....A-17
- 8 Performance analysis to G.821, G.826, G.828, G.829,
M.2100, M.2101.....A-22
- 9 Pointer stress test.....A-25
- 10 Editing and analyzing the Transport/Path overhead.....A-29
- 11 DCC/ECC bit error test.....A-34
- 12 Maximum Tolerable Jitter (MTJ).....A-37
- 13 Fast Maximum Tolerable Jitter (F-MTJ).....A-40
- 14 Jitter Transfer Function (JTF).....A-43
- 15 Phase Hit Measurement.....A-47
- 16 Wander Generator.....A-50
- 17 Wander Analysis to 2.5 Gbit/s.....A-53
- 18 Maximum Tolerable Wander (MTW).....A-58
- 19 Consecutive Identical Digit (CID) Test
to G.783, Appendix X.....A-61



20	Setting the ATM signal structure	A-63
21	ATM bit error rate test (ATM-BERT)	A-66
22	ATM latency test for ATM switches	A-71
23	ATM latency test with background load (ATM Background Generator)	A-75
24	Sensor test - loss of cell delineation (LCD)	A-78
25	Measuring the CLR with a variable cell rate (VBR traffic)	A-81

Standards/Abbreviations

1	Recommendations/Standards	SA-1
2	Alarm messages	SA-9
3	Abbreviations	SA-12

Technical Background

1	Multiplexing structures	TB-1
2	Pointer action generation	TB-2
3	Performance Analysis	TB-6

Maintenance

1	Cleaning the instrument	M-1
2	Tools	M-1
3	Exchanging Versacon inserts	M-2
4	Replacing the fuse	M-3
5	Replacing the air filter pad	M-4

Remote operation

1	Introduction	RO-1
2	Remote Operation via Modems	RO-2
3	Remote Operation via Ethernet (IEEE 802.3)	RO-4



Specifications

1	Generator section.	S-2
2	Receiver section.	S-5
3	DS1 and DS3 signals	S-9
4	E1 to E4 signals	S-16
5	Measurement modes	S-22
6	Automatic measurements	S-27
7	Other inputs and outputs	S-36
8	Built-in operation and control computer (PC)	S-39
9	General specifications.	S-41

Index

Introduction



Contents

Introduction

1	The ANT-20SE concept	I-1
2	ANT-20SE: Supremely easy to use	I-4
2.1	Ideal for mobile use	I-4



Notes:



Introduction

1 The ANT-20SE concept

There is an ever-increasing demand for flexible and versatile measurement solutions for installing, maintaining and troubleshooting modern networks to allow testing of various network elements. Such measurement concepts must also be economic, due to the highly competitive situation which affects manufacturers, installers and private and public network operators alike.

Simple solutions for individual measurement tasks used to be sufficient. These days, well-planned measurement concepts which can keep pace with the rapid pace of network and system development are needed. The measurement equipment must be able to handle both the classical measurements for the plesiochronous hierarchy as well as being able to analyze the SDH and SONET mappings for STM-1/STS-1.

The **A**dvanced **N**etwork **T**ester ANT-20SE can make measurements on all standard electrical and optical interfaces from 2 Mbit/s up to STM-64 and from DS1 up to OC-192. It can resolve signal structures up to the 10 Gbit/s level and analyze them down to the lowest level. Access to all standardized mappings is available both for different transmission methods (SDH, SONET, ATM) and for mixed structures (e.g. DS1 in STM-1).

The ANT-20SE can, for example, measure synchronous functions at high bit rates and also jitter simultaneously. To do this, the 2.5 Gbit/s Module and the 2.5 Gbit/s Jitter Module can be combined with the 622 Mbit/s Jitter Module in the ANT-20SE. This eliminates the complicated and time consuming need for several different test instruments during network installation or troubleshooting.

ATM test functions and performance quality analysis on ATM links are further features of the ANT-20SE which ensure its suitability for future applications. It can handle ATM frame structures on PDH and SDH interfaces.

The ANT-20SE is equipped with a powerful operating processor and 32 MB RAM. The use of the Windows95 operating system provides for extra advantages:

- Standard software ensures future viability
- Modern operating system
- Other Windows95 compatible software can be used
- Matches the normal work environment
- Easy access to PCMCIA interface without additional software

The ANT-20SE is thus a future-oriented solution to measurement tasks in SDH and SONET networks, covering a previously unimaginable range. In particular, new measurement tasks arise where communications involve transfers between networks using different standards, or where new technology such as ATM network elements is employed. The ANT-20SE is already equipped with the foundation for handling these future tasks.

The PC concept and standard color display screen of the ANT-20SE make for superior ease of use without the need to learn new operating procedures.

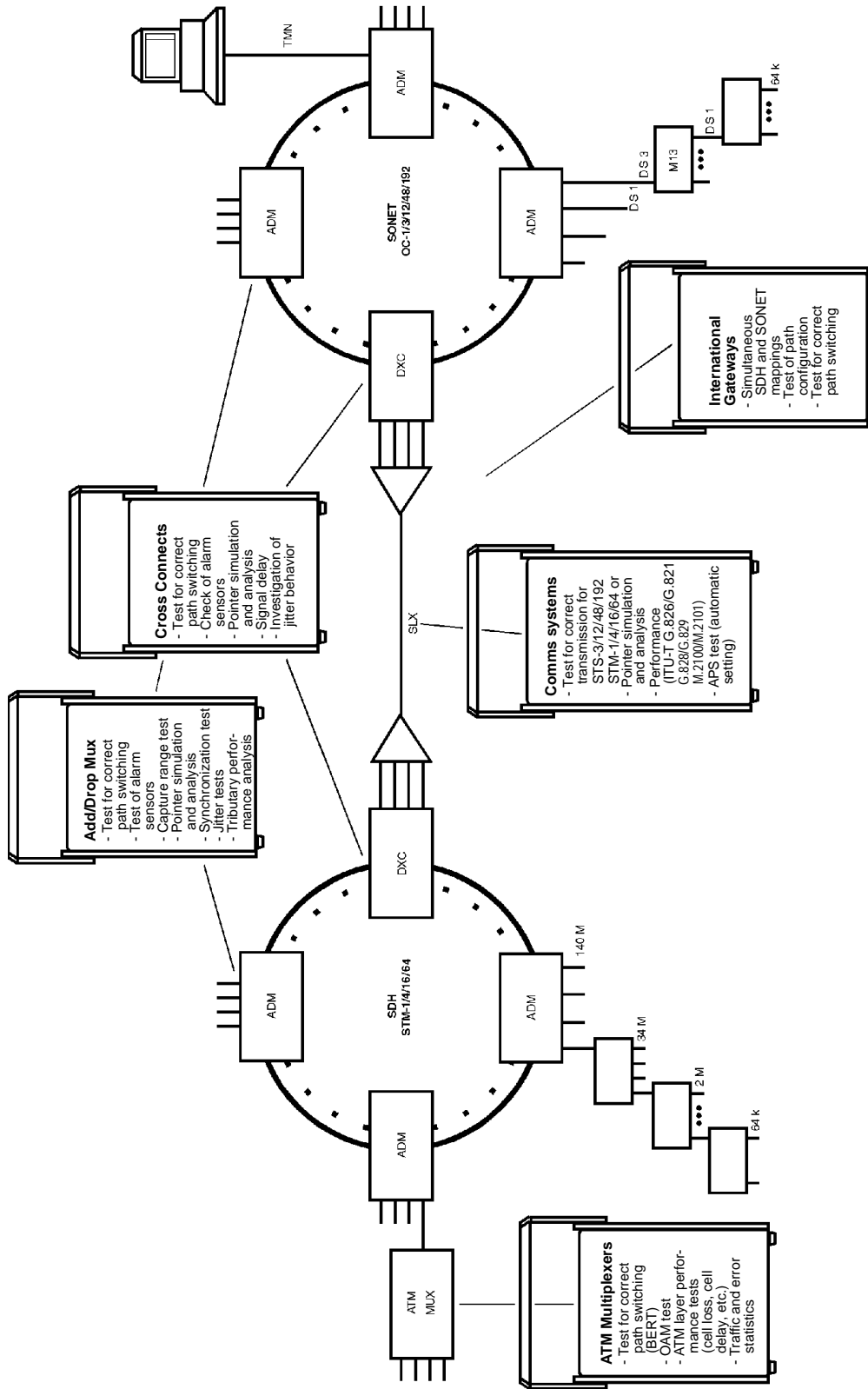
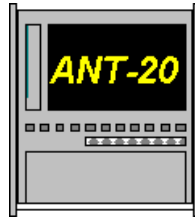

Fig. I-1 The wide range of applications



The ANT-20SE can always provide the answer to the wide range of measurement tasks on modern network components, as the functions can be combined to match your current requirements just like adding building blocks. Functions can be added at any time.



Color TFT display
Touchscreen

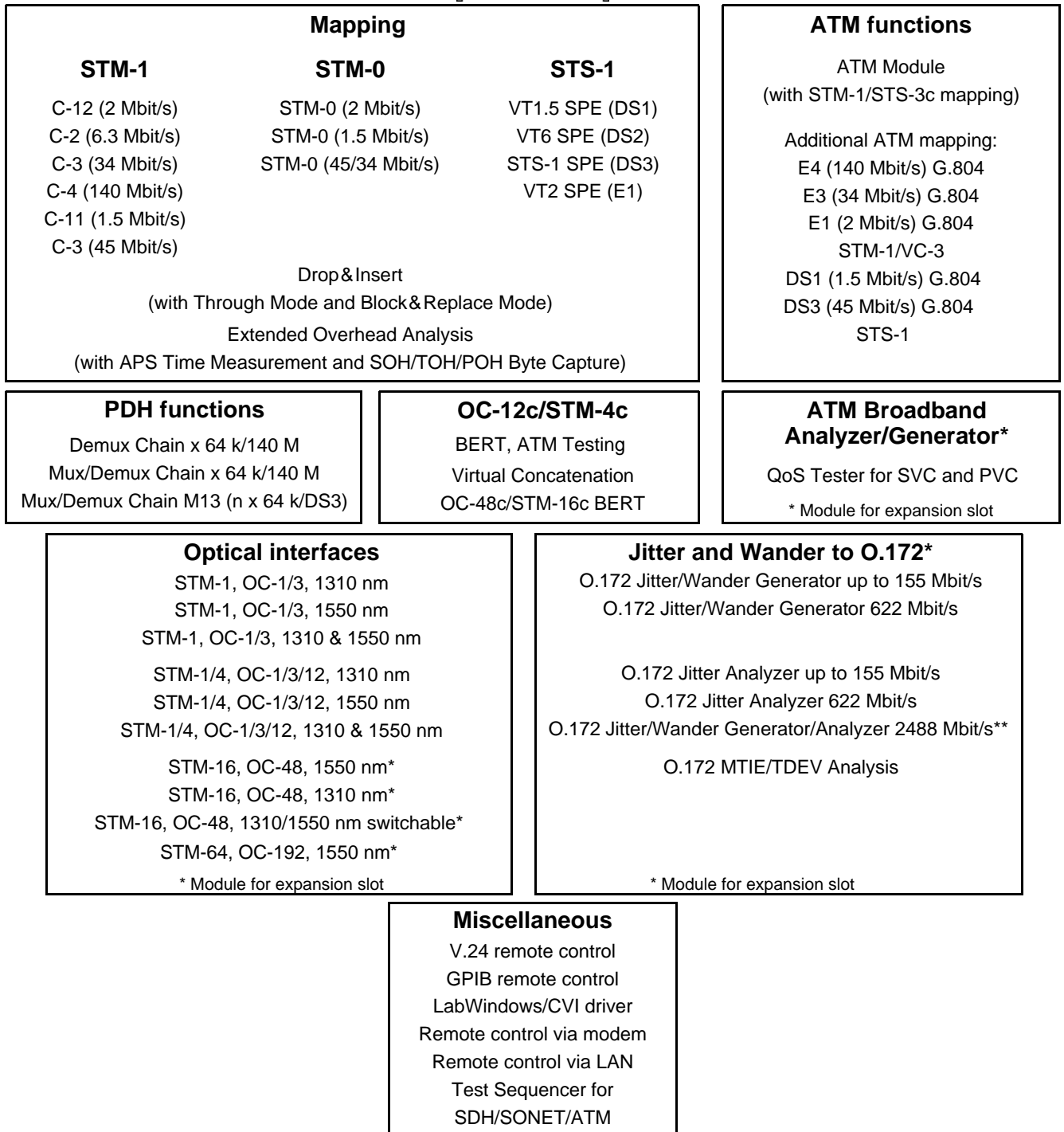

Fig. I-2 Additional functions available for the ANT-20SE



2 ANT-20SE: Supremely easy to use

The Advanced Network Tester ANT-20SE combines the advantages of cost-effective customized solutions with supreme ease of use in a unique way. The instrument provides basic configurations which are international in scope for installation, acceptance, maintenance and troubleshooting. Options can be added at any time to extend the facilities of the basic configuration and match the ANT-20SE to new requirements. The standard Windows user interface is supported by the strongly application-oriented operating structure. MS-Excel, Windows and Windows95 are registered trademarks of Microsoft Corporation. The graphics user interface makes for fast setting of the instrument to suit the application. All the important parameters and results for the current task are displayed simultaneously. On-line help ensures that you can correctly use all functions of the ANT-20SE. A full keyboard is fitted to make input of text for documentation purposes that much easier. Rapid switching between several windows displayed simultaneously is particularly practical: The ANT-20SE can be precisely configured for every application.

The modular, future-oriented software architecture is clearly shown in Fig. I-3. The ANT-20SE can be re-configured to match a new requirement quickly and simply by adding extra hardware and/or software. Remote operation from a standard PC is possible, as is the exporting of measurement data for processing and evaluation. The ANT-20SE is ready to accept future remote operation interfaces such as LAN, ISDN, infra-red or GSM (via PCMCIA slots).

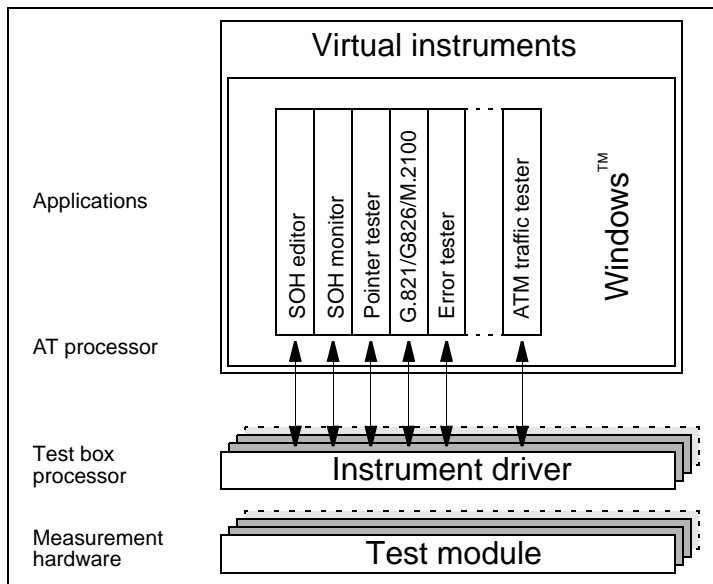

Fig. I-3 ANT-20SE software architecture

2.1 Ideal for mobile use

Despite the exceptional flexibility and wide range of functions of the ANT-20SE, it is one of the most compact instruments of its class. The low-volume casing with extra large area display screen was designed specifically with the requirements of mobile use in mind.

Getting Started



Contents

Getting Started

1	Safety instructions	G-1
1.1	Correct usage	G-1
1.2	AC line voltage	G-1
1.3	Safety class	G-1
1.4	Faults and excessive stresses	G-2
1.5	Repair and maintenance instructions	G-2
1.6	Laser safety	G-4
2	Packing and unpacking, transport	G-6
2.1	Unpacking	G-6
2.2	Checking for transport damage	G-6
2.3	Packing for transport and storage	G-6
2.4	Operation after storage and transport	G-7
2.5	Ventilation	G-7
3	Power supply	G-8
3.1	AC line operation	G-8
3.2	Lithium batteries	G-8
3.3	Switching on	G-9
3.3.1	Solving problems	G-9
4	Instrument checklist	G-11
5	Data backup	G-11



Notes:



Getting Started

1 Safety instructions

This instrument was shipped in perfect condition. To ensure that this condition is maintained and that operation is safe, please follow the instructions in this section carefully.

1.1 Correct usage

This instrument may only be used under the conditions and for the purpose for which it was constructed. Further information on this is given in the sections "Specifications" and "Introduction" of this operating manual.

Use outside the specified conditions may be dangerous and may also damage the instrument.

Sec. 1.4, Page G-2.

In particular, the instrument must not be connected to measurement circuits for which it is not designed.

1.2 AC line voltage

Before switching the instrument on, make sure that the instrument operating voltage corresponds to the voltage of your local AC power supply.

AC line voltage range	AC line frequency	Power consumption
100 V to 127 V 200 V to 240 V	50 Hz or 60 Hz	< 600 VA

Table G-1 AC power supply range for ANT-20SE

1.3 Safety class

The ANT-20SE is a Safety Class 1 equipment as defined in EN 61010-1 (IEC Publ. 1010-1). The AC line cord supplied with the instrument contains a protective ground conductor. The AC line plug may only be inserted into AC line socket outlets equipped with a protective ground contact unless the AC line circuit is specially isolated.

The protective ground conductor must not be interrupted, either inside or outside the instrument casing.

A connection to measurement circuits carrying dangerous voltages is not intended.

If the AC line protective ground connection can be used for this purpose, connect the instrument to the AC line before connecting it to the measurement circuit.

If the measurement circuit itself is equipped with a protective ground conductor, this should be connected to the instrument casing before connecting the rest of the measurement circuit.



1.4 Faults and excessive stresses

If it is suspected that the instrument is no longer safe to use, it should be taken out of service and secured against unintentional operation. This situation is possible if:

- the instrument is visibly damaged,
- the instrument does not work,
- the instrument is exposed to stresses of any kind which are outside the permitted limits,
- the instrument has been stored for a long period under unsuitable conditions or handled roughly during transport (see Sec. 2, Page G-6).

In such cases, contact your nearest Service Center. The addresses are listed at the end of this operating manual.

1.5 Repair and maintenance instructions

If the covers are removed or parts of the instrument are manipulated using tools, it is possible that other parts carrying dangerous voltages may be exposed. The connectors may also be live.

For this reason, the instrument must be disconnected from all voltage sources before it is opened. Simply switching it off using the AC line switch is not sufficient.

Capacitors in the instrument may retain a charge even long after the instrument has been disconnected from all voltage sources.

If subsequent calibration, maintenance or repair of the opened instrument under voltage becomes necessary, such work should only be performed by trained persons familiar with the risks involved.

Repairs

Repairs must be carried out by trained persons. The constructional features of the instrument must not be altered in any way which might adversely affect the safety characteristics of the instrument. In particular, creepage and air paths and the insulation spacing must not be reduced.

Wherever possible, use only original spare parts for replacement. Other parts may only be used if they do not adversely affect the safety characteristics of the instrument.

Fuses

Use only the prescribed fuses (see Sec. 3.1, Page G-8).



Tests after repairs and maintenance

The insulation resistance and the protective ground connection of the AC line circuitry must be checked after repair or maintenance work on the instrument. Check the connection and general condition by visual inspection and measure the resistance between the protective ground contact of the AC line plug and the instrument enclosure. The resistance must be $< 0.1 \Omega$. Shake the cable during the measurement. Resistance variations may mean that the cable is faulty; in such cases, the cable must not be reused.

Repeat the measurement using a new cable. If the cause of the changes in resistance proves not to be due to the cable, the instrument must be taken out of service until the fault has been determined and repaired in accordance with the safety requirements.

Measure the insulation resistance between the AC line terminals which have been shorted together and the protective conductor terminal of the instrument using a 500 V insulation tester. Ensure that the instrument's AC line switch is in the "I" position. The insulation resistance must be $> 2 \text{ M}\Omega$ according to EN 61010-1. If the resistance is less than $2 \text{ M}\Omega$, the instrument must be taken out of service and repaired.



1.6 Laser safety

The following options for the ANT-20SE are fitted with laser output devices:

- BN 3035/90.40 through BN 3035/90.59
- BN 3035/91.40
- BN 3035/91.41
- BN 3035/91.53 through BN 3035/91.59

Optical radiation with wavelengths in the range 1300 to 1600 nm is present at sockets [18], [47] and [103].

Maintenance and repair work on the laser sources should only be carried out by qualified service operatives familiar with the risks involved.

The laser source is active if the yellow LED next to the connector is on.

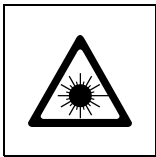

Caution

Invisible laser radiation.

Laser light can cause irreparable damage to the eyes, particularly to the retina.

- ⇒ Never look directly into the generator outputs [18], [47] and [103] or the connector end surfaces of the connected cables (free ends) if the laser sources are activated.
- ⇒ Never use a microscope to check the generator outputs if the laser sources are activated.
- ⇒ Do not activate the laser sources until all measurement connections have been made.

The output power at socket [18] of the STM-4/OC-12 module is within the limits for a CLASS 1 LASER PRODUCT.

The output power at socket [47] or [103] of the STM-16/OC-48 module or STM-64/OC-192 is also within the limits for a CLASS 1 LASER PRODUCT (IEC 825-1: 1993) during normal operation. Under fault conditions, the output power level may exceed these limits and the output is then a CLASS 3A LASER PRODUCT (IEC 825-1: 1993).

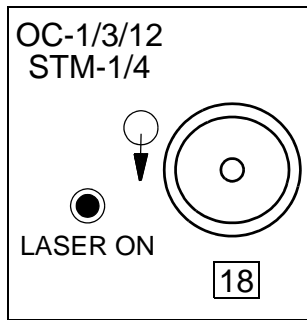

Mainframe

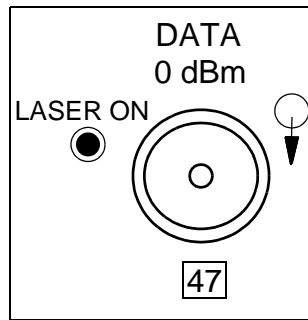

STM-16/OC-48 Module

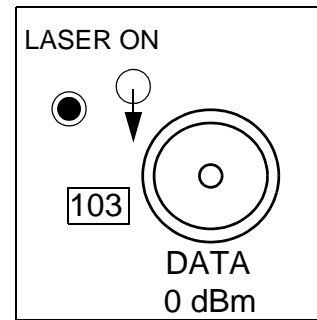

STM-64/OC-192 Module

Fig. G-1 ANT-20SE optical connections



Affixing the laser safety warning labels

A laser safety warning label in the local language indicating the laser class must be affixed to the outside of the ANT-20SE in such a position that it is clearly visible to the user.

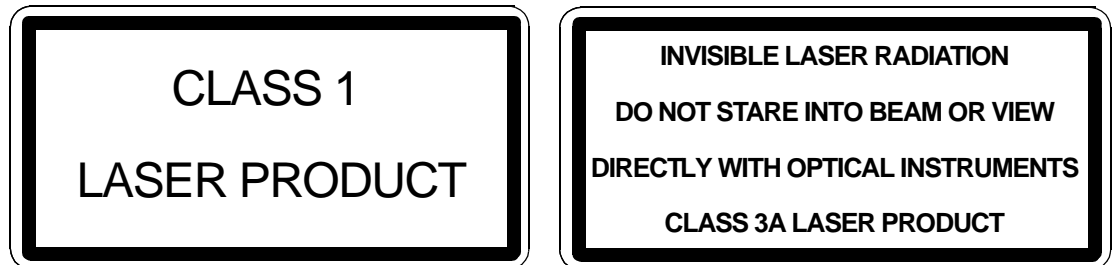

Fig. G-2 Laser class safety warning labels

We recommend that the laser safety warning label is affixed to the front panel of the ANT-20SE below socket [05] (see Fig. G-3).

Use the following laser safety warning labels:

- CLASS 1 LASER PRODUCT
for Options BN 3035/90.43 through 90.48
- CLASS 3A LASER PRODUCT
for Options BN 3035/90.53, BN 3035/90.54, BN 3035/90.59, BN 3035/91.53, BN 3035/91.54, BN 3035/91.59, BN 3035/91.40 and BN 3035/91.41

A sheet of laser safety warning labels is included with each module.

Note: If Options in the BN 3035/90.43 through 90.48 range **and** BN 3035/90.53, BN 3035/90.54, BN 3035/90.59, BN 3035/91.53, BN 3035/91.54, BN 3035/91.59, BN 3035/91.40 or BN 3035/91.41 are both fitted, the CLASS 3A LASER PRODUCT label should be affixed. Any CLASS 1 LASER PRODUCT label already affixed to the instrument should be removed or the new label affixed over it so that it is completely concealed.

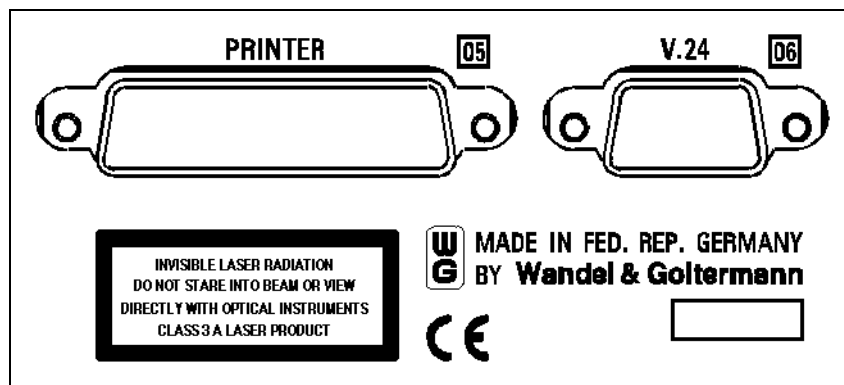

Fig. G-3 Laser safety warning label on the front panel of the ANT-20SE



2 Packing and unpacking, transport

2.1 Unpacking

Do not discard the packing materials and any transport protection. These items have been specially designed to be reused if they are not damaged. The instrument can only be reliably protected against damage if the original packing is used when transporting it.

2.2 Checking for transport damage

After unpacking the instrument check it for transport damage. Such damage is likely if the packaging itself has been severely damaged. Do not attempt to use an instrument which is visibly damaged, as this may result in further damage to the instrument and may be dangerous (see Sec. 1, Page G-1).

2.3 Packing for transport and storage

If the instrument is to be shipped, e.g. to a Wavetek Wandel Goltermann Service Center for repairs, follow the instructions below to ensure that damage does not occur during transport.

Packing

If possible, use the original packing (undamaged) for shipping the instrument.

If the original packing is not available, use a strong box made from double-layer corrugated cardboard which is at least 4 mm thick.

The box should be big enough to allow padding of at least 70 mm thickness to be placed all round the instrument. The padding can be rigid foam plastic or corrugated cardboard.

The padding should cover as large an area of the instrument surface as possible and ensure that the instrument does not move within the box. Any spaces can be filled with polystyrene chips or similar.

The use of polystyrene chips as the only padding material is insufficient.

The box should be sealed along the butt edges using waterproof textile adhesive tape which is at least 70 mm wide.

Storage under damp conditions

If transport is likely to take a long time or if the instrument is to be stored for a long period under conditions where high air humidity is likely, it is a good idea to protect the instrument against moisture using the original packing materials. Sachets of drying agent are placed in the plastic bag containing the instrument, and the bag is sealed using strong adhesive tape.

Drying agent which is saturated with water must not be put or allowed to remain in the plastic bag, as it may increase the humidity and cause damage. Drying agent which is saturated is pink in color, unsaturated drying agent is blue.

Check list

Make a list of all the items in the box and place it in the box.



2.4 Operation after storage and transport

Storage and transport can subject the instrument to severe stresses. Refer to the safety instructions Sec. 1, Page G-1 and all of the instructions for packing and unpacking, transport Sec. 2, Page G-6.

Recovery time

Condensation may form on an instrument which has been stored or transported at a low temperature when it is brought into a warm environment. To prevent any damage, wait until all signs of condensation on the instrument surfaces have disappeared before switching the instrument on. The instrument is only ready for use when it has reached the guaranteed operating temperature range of +5 to +45 °C.

The latter also applies if the instrument has been stored at a higher temperature.

2.5 Ventilation

Make sure that the ventilation slots are not obscured during operation.

The instrument must not be operated above the permitted maximum ambient temperature of +45 °C. Adequate ventilation must be provided.



3 Power supply

3.1 AC line operation

AC line frequency

The ANT-20SE is operated from AC line power supplies having a frequency of 50 or 60 Hz.

Fuse

The following type and value of fuse must be used:

AC line voltage range	Fuse type
100 to 240 V	T5.0 A

Table G-2 Fuses

Two spare fuses are supplied separately.

3.2 Lithium batteries

The ANT-20SE contains lithium batteries for buffering the data storage memory. Replacement of expired (flat) batteries can be carried out by your local Wavetek Wandel Goltermann Service Center.

The batteries need not be removed from the instrument if it is to be scrapped.



3.3 Switching on

Switching on

The ANT-20SE is switched on using the AC power switch located on top of the instrument (switch position “I”).

When you switch on, the Windows95 operating systems will start. MS-Excel and Windows95 are registered trademarks of Microsoft Corporation. The ANT-20SE software will then start automatically.

The display will then look something like the next figure.

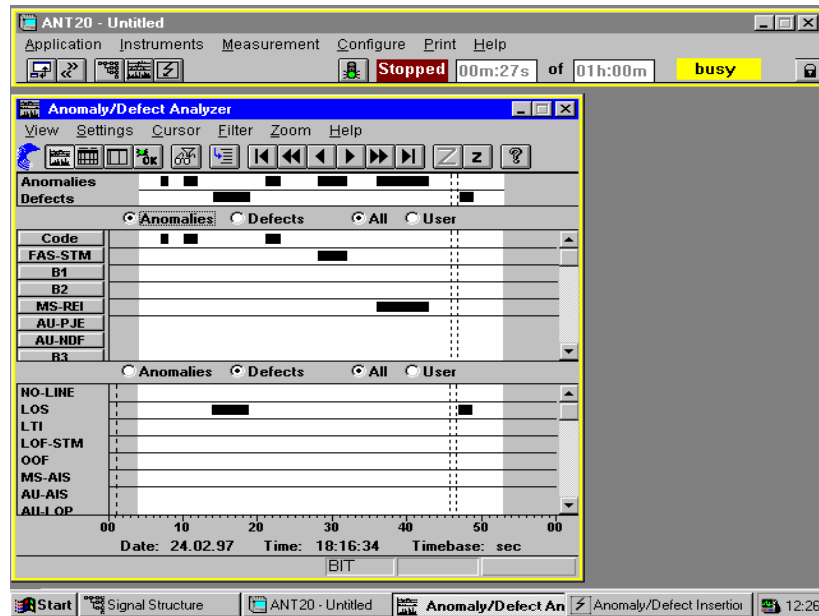

Fig. G-4 ANT-20SE screen after switching on

3.3.1 Solving problems

The following situations may lead to a loss of the “CMOS setup” data:

- Switching off the instrument during boot-up
- Power supply failure during boot-up
- Software crash

To restore and save the “CMOS setup” data, proceed as follows:

1. Switch on the instrument.
2. Wait until the BIOS version is displayed on the screen.
3. Then press the “CTRL”, “ALT” and “F1” keys simultaneously.
This initiates the “CMOS Setup” program.
4. Use the “Tab” key or arrow keys to select the appropriate menus and make the settings listed on the next page.
5. Save the settings and exit from the “CMOS Setup” program.



“C-MOS Setup”

Date/Time: Date: xx yy zzzz enter current date
 Time: xx yy zz enter current time

Hard-Disk:

	Auto	Type	...	Block Mode	32-Bit	Fast PIO
Master	(✓)	USR1	...	(✓)	(✓)	(✓)
Slave	()	None	...	()	()	()

First press “Auto All Drives”. Then set the missing flags.

Floppy Disk: Drive A: Drive B: Test Floppy Disk
 (*) 1.44 MB (*) None ()

Boot Features: (*) A:, C: Boot Sequence
 (✓) Halt on Errors
 () Display Graphic Logo
 (✓) Num Lock on
 (✓) Quick Memory Test

System Option: Cache (*) External and CPU
 Error Mode (*) None
 DRAM Speed (*) 60 ns
 Shadow (✓) System Bios Cachable
 (✓) ISA Video Shadow
 (✓) ISA Video Cachable

Peripheral: Serial Port A: Auto
 Serial Port B: Auto
 Parallel Port: Auto
 Primary IDE: Auto
 Floppy Disk: Auto Normal
 PS/2 Mouse: Enabled

All other settings can be selected to suit your requirements.



4 Instrument checklist

The following items are supplied with the ANT-20SE:

- ANT-20SE Mainframe
- Protective cover
- Options (will be built in to the Mainframe according to your order instructions)
- AC line power cord
- Bag containing two spare fuses and tools (allen key and mounting key)
- Windows95 operating system and handbook
- Operating manual
- Calibration certificate (or optional calibration report)

5 Data backup

The ANT-20SE software together with the Windows95 operating system is pre-installed on the hard disk drive of the ANT-20SE. The instrument is ready to use immediately.

The following directories are stored on the hard disk drive of the ANT-20SE:

Directory	Contents
c:\ant20\ ...	ANT-20SE programs and data
c:\windows\ ...	Windows95
c:\win95.sup\setup.exe \ ...	Windows95 setup program
c:\ant20.sup\disk1\setup.exe \ ... \disk2 \ ... \diskn \ ...	ANT-20SE setup program

Table G-3 Directories on the hard disk drive of the ANT-20SE

To back up the ANT-20SE data, copy each one of the directories c:\ant20.sup\disk1 through c:\ant20.sup\disk *n* on to a separate floppy disk.

Tip: It is a good idea to make a backup of all the data on the hard disk drive using a suitable backup program.

Help with problems

If a reinstallation of the software is necessary for some reason, please contact your nearest Wavetek Wandel Goltermann Service Center. The addresses are listed at the end of this operating manual.

When making inquiries, always quote the following:

- ANT-20SE serial number
- ANT-20SE Software Package version number



Notes:

Operating Fundamentals



Contents

Operating Fundamentals

1	Control elements	O-1
1.1	ANT-20SE front panel	O-1
1.2	ANT-20SE connector panel	O-2
1.3	Description of control elements and connectors	O-3
1.3.1	Front panel control elements	O-3
1.3.2	Control elements and connectors on the connector panel	O-3
1.3.3	Front panel LED array	O-5
2	Basic operation	O-6
3	Switching on the ANT-20SE	O-6
3.1	Connecting up	O-6
3.2	Switching on	O-6
3.2.1	After switching on	O-7
3.3	Switching on with function key “F3” APPL pressed	O-7
3.4	Further operating procedure	O-8
3.5	Starting programs with the “Instant Access Buttons”	O-8
4	ANT-20SE windows	O-11
4.1	Overview	O-11
4.1.1	The “ANT20 - <Application Title> (Application Manager) window	O-11
4.1.2	Virtual instruments	O-12
4.2	Elements of the “ANT20 - <Application Title>” window	O-13
4.2.1	Minibar (Application Manager reduced form)	O-13
4.2.1.1	Displaying virtual instruments	O-13
4.2.1.2	Starting and stopping a measurement	O-13
4.2.1.3	Disabling entries	O-14
4.2.1.4	Enabling entries	O-14
4.2.1.5	Other important functions	O-14
4.2.2	Menu bar and pull-down menus	O-15
4.2.2.1	The “Application” menu	O-15
4.2.2.2	The “Instruments” menu	O-16



- 4.2.2.3 The “Measurement” menu O-16
- 4.2.2.4 The “Configure” menu O-17
- 4.2.2.5 The “Print” menu O-17
- 4.2.2.6 The “Help” menu O-17
- 4.2.3 Title bar O-18

- 5 Creating, saving and loading applications O-19**
 - 5.1 Selecting the virtual instruments for an application. O-19
 - 5.2 Entering the signal structure O-21
 - 5.3 Saving an application O-23
 - 5.4 Loading an application O-23

- 6 Measuring O-25**
 - 6.1 Setting the parameters O-25
 - 6.2 Starting and stopping the measurement O-27
 - 6.2.1 Starting and stopping a measurement manually O-27
 - 6.2.2 Starting a measurement manually and stopping automatically O-28
 - 6.2.3 Starting and stopping a measurement automatically (timer). O-28
 - 6.3 Displaying results e.g. anomalies O-29

- 7 On-line help. O-31**
 - 7.1 Calling up on-line help O-31
 - 7.2 Calling up a help topic. O-31
 - 7.3 Setting the size of the help window. O-31

- 8 How to use the windows O-32**
 - 8.1 Arranging the application windows O-32
 - 8.2 Commonly-used controls O-33

- 9 Printing and exporting results O-35**
 - 9.1 Installing a printer O-36
 - 9.2 The “Print” menu – Application Manager O-37
 - 9.2.1 Printing results O-37
 - 9.2.1.1 The “Print Headers” dialog O-37
 - 9.3 The “Print” menu – Virtual instruments O-38
 - 9.3.1 Printing out results O-38
 - 9.3.1.1 The “Print” dialog O-38



9.3.1.2	The “Print Headers” dialog	O-39
9.3.1.3	The “Printer Setup” dialog	O-39
9.3.2	Exporting results	O-39
9.3.2.1	The “Save as” dialog	O-40
9.3.2.2	The “Export Format” dialog	O-40
9.4	The “Screen Dump” print function	O-41
10	ANT-20SE behavior in the event of an AC power failure	O-42
10.1	Backup data set.	O-42
10.2	Examples.	O-43
10.2.1	Manually triggered measurements	O-43
10.2.2	Timer-controlled measurements	O-44



Notes:



Operating Fundamentals

1 Control elements

1.1 ANT-20SE front panel

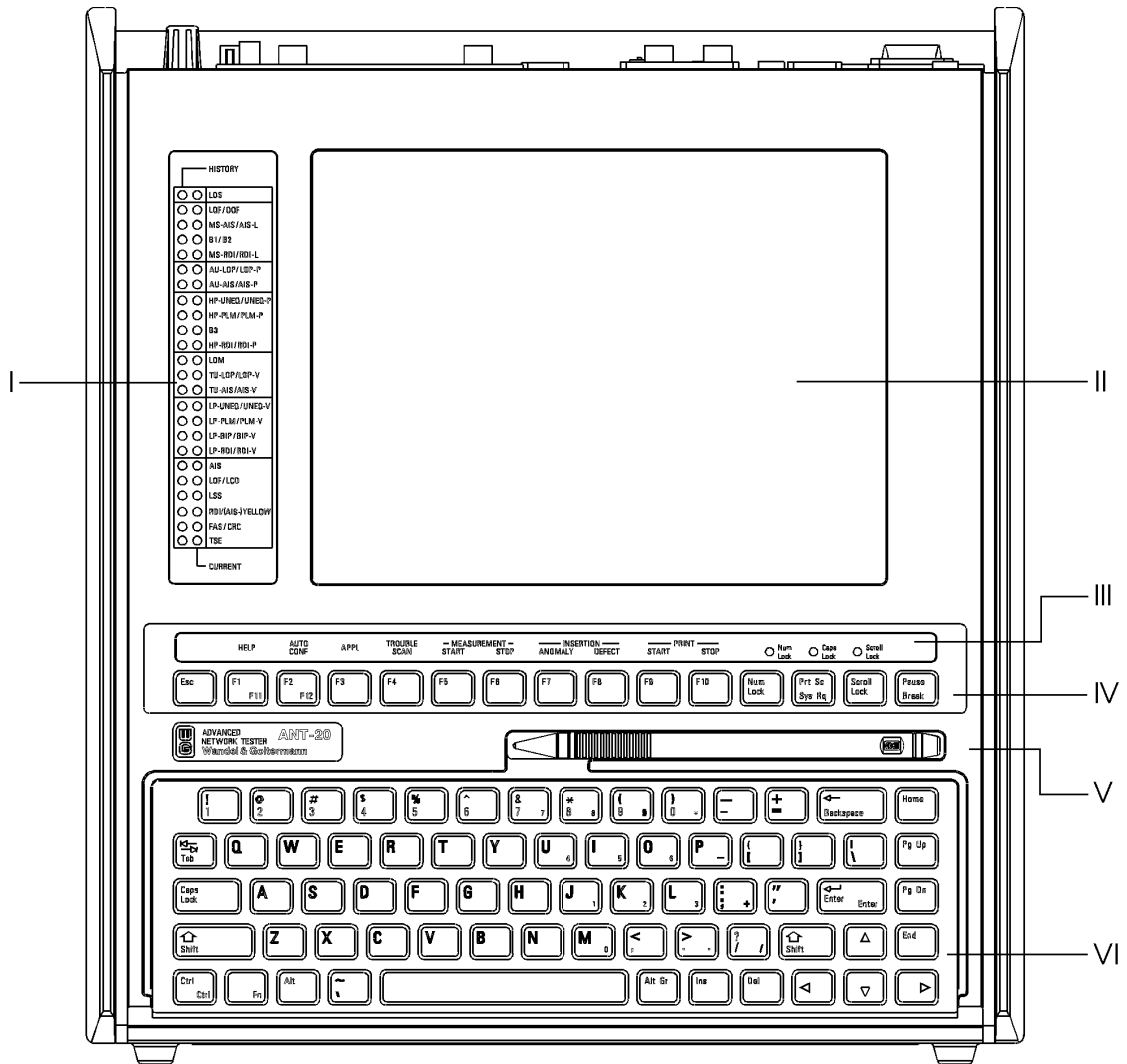

Fig. O-1 ANT-20SE front panel



1.2 ANT-20SE connector panel

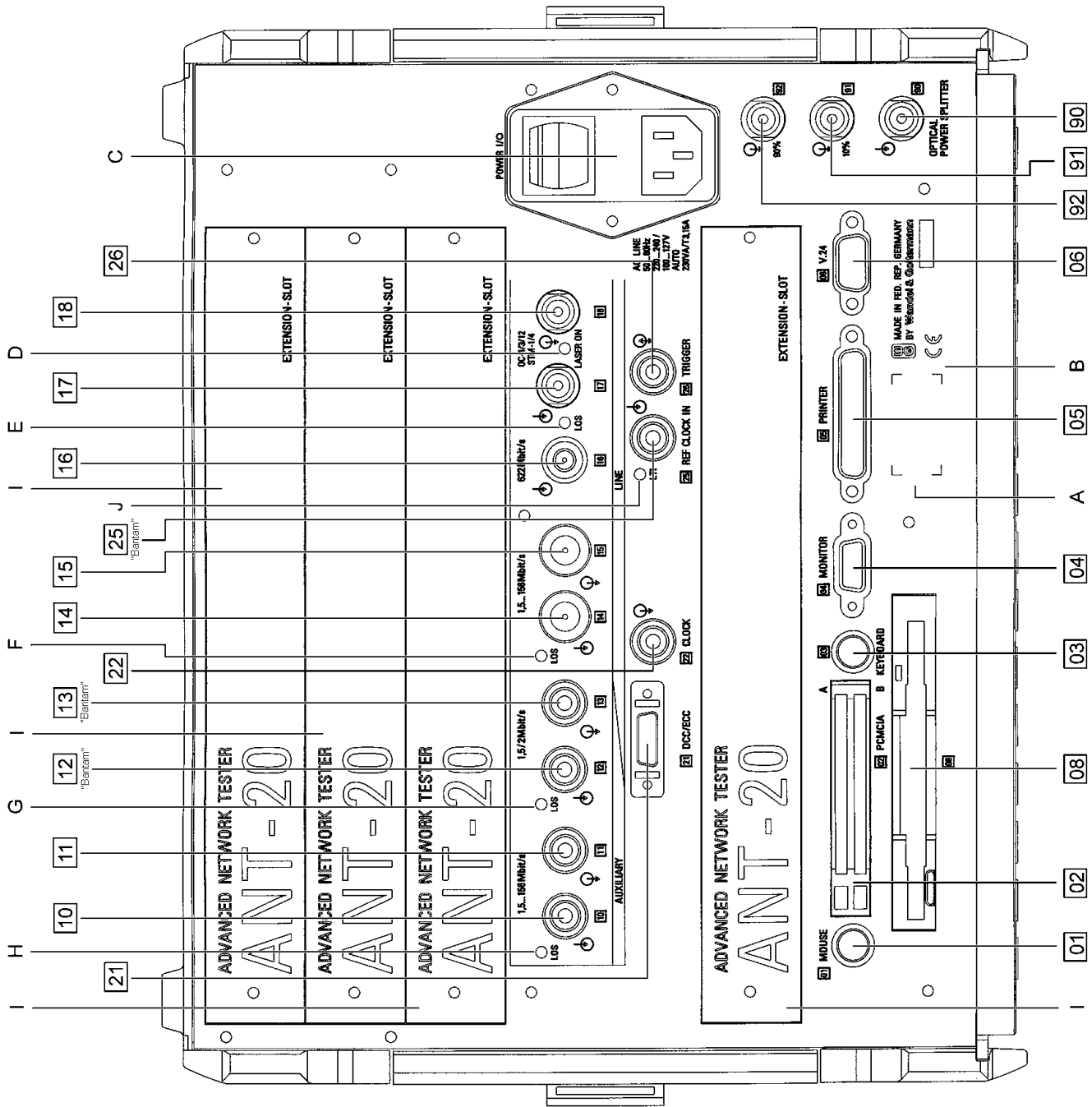

Fig. O-2 ANT-20SE connector panel



1.3 Description of control elements and connectors

1.3.1 Front panel control elements

see Fig. O-1, Page O-1 and Fig. O-3, Page O-5

Position	Designation
I	LED array
II	ANT-20SE display monitor
III	Function key assignments during ANT-20SE operation
IV	Function keys
V	Touchscreen pointer pen
VI	Built-in keyboard

Table O-1 Front panel control elements

1.3.2 Control elements and connectors on the connector panel

see Fig. O-2, Page O-2

Position	Designation
[01]	Mouse connector PS2 interface
[02]	PCMCIA interfaces A and B
[03]	External keyboard connector PS2 interface
[04]	External display monitor connector VGA interface
[05]	External printer connector Parallel (Centronics) interface
[06]	Serial interface V.24 interface
[08]	Floppy disk drive
[10]	“Insert Tributary” input
[11]	“Drop Tributary” output
[12]	“Insert Tributary” balanced input or balanced electrical input
[13]	“Drop Tributary” balanced output or balanced electrical output
[14]	Electrical input (coded) 1.5 to 156 Mbit/s
[15]	Electrical output (coded) 1.5 to 156 Mbit/s
[16]	Electrical input STM-1/STM-4 622 Mbit/s

Table O-2 Control elements on the connector panel



Position	Designation
[17]	Optical input OC-1/-3/-12/STM-1/STM-4 1310/1550 nm
[18]	Optical output OC-1/-3/-12/STM-1/STM-4 1310/1550 nm
[21]	Input/output for DCC/ECC signals V.11 interface
[22]	Clock output (unjittered TX clock)
[25]	Reference clock input 2048 kbit/s, 1544 kbit/s
[26]	Trigger output
[90]	Optical power splitter: Input
[91]	Optical power splitter: 10% output
[92]	Optical power splitter: 90% output
A	Laser class label
B	Manufacturer's name CE label ANT-20SE serial number
C	AC line switch AC line connector Fuse
D	"LASER ON" LED indicator is lit when laser generator is on
E, F, G, H	"LOS" Loss of signal LED indicators
I	Empty slot for further options
J	"LTI" Loss of timing interval LED indicator

Table O-2 Control elements on the connector panel (continued)



1.3.3 Front panel LED array

HISTORY		
○ ○	LOS	Loss of signal
○ ○	LOF/OOF	Loss of frame/Out of frame
○ ○	MS-AIS/AIS-L	Multiplexer section alarm indication signal/Alarm indication signal line
○ ○	B1/B2	B1 or B2 Bit interleaved parity errors
○ ○	MS-RDI/RDI-L	Multiplexer section remote defect indication/Remote defect indication line
○ ○	AU-LOP/LOP-P	AU Loss of pointer/Loss of pointer path or AU-NDF
○ ○	AU-AIS/AIS-P	AU Alarm indication signal/Alarm indication signal path
○ ○	HP-UNEQ/UNEQ-P	High order path unequipped/Unequipped path
○ ○	HP-PLM/PLM-P	High order path path-label mismatch/Path label mismatch path
○ ○	B3	B3 Bit interleaved parity errors
○ ○	HP-RDI/RDI-P	High order Path remote defect indication/ Remote defect indication path
○ ○	(TU)-LOM	Loss of multiframe
○ ○	TU-LOP/LOP-V	TU Loss of pointer/Loss of pointer VT or TU-NDF
○ ○	TU-AIS/AIS-V	TU Alarm indication signal/Alarm indication signal VT
○ ○	LP-UNEQ/UNEQ-V	Low order path unequipped/Unequipped VT
○ ○	LP-PLM/PLM-V	Low order path path-label mismatch/Path label mismatch VT
○ ○	LP-BIP/BIP-V	Low order path bit interleaved parity errors/Bit interleaved parity errors VT
○ ○	LP-RDI/RDI-V	Low order path remote defect indication/Remote defect indication VT
○ ○	AIS	Alarm indication signal (payload)
○ ○	LOF/LCD	Loss of frame (payload) / Loss of cell delineation
○ ○	LSS	Loss of sequence synchronization
○ ○	RDI(AIS-)Yellow	Remote defect indication (payload) / (Alarm indication signal) yellow
○ ○	FAS/CRC	Frame alignment signal errors (payload) / Cyclic redundancy check error
○ ○	TSE	Test sequence errors (bit errors)
CURRENT		

Fig. O-3 Meanings of the LED indicators on the ANT-20SE front panel

The abbreviations refer to SDH and SONET events.

The following events apply to SONET only:

AIS-L	RDI-L
LOP-P	AIS-P
UNEQ-P	PLM-P
RDI-P	LOP-V
AIS-V	UNEQ-V
PLM-V	BIP-V
RDI-V	(AIS-)Yellow



2 Basic operation

The ANT-20SE are operated just like any other Windows application. Entries are usually made using the trackball. More complex entries are made using the built-in keyboard and pre-defined function keys. An external keyboard can be connected to socket [03] if required.

The following sections describe the operating concept of the ANT-20SE with the aid of some typical examples. Most functions are self-explanatory, so you will become familiar with the basic operation of the instrument fairly quickly. On-line help is provided to allow you to use the ANT-20SE to the full and to match it to your requirements. For this reason, these operating instructions have been kept brief. On-line help is accessed by pressing function key F1 (see Sec. 7, Page O-31).

3 Switching on the ANT-20SE

Before switching the instrument on, observe the following precautions:

- The instrument must not be damaged in any way that would affect safe operation.
- The instrument must not be switched on if condensation is present.
- The local a.c. line voltage and frequency must match the a.c. line voltage and frequency ranges of the ANT-20SE.
- The protective ground conductor must be properly connected.

3.1 Connecting up

1. Connect the ANT-20SE a.c. line input to the local a.c. power supply using the line cord supplied with the instrument.
2. Connect the signal output [14] and signal input [15] together with a screened coaxial cable.

3.2 Switching on

⇒ Switch on the ANT-20SE by setting the POWER switch to the "I" position.



3.2.1 After switching on

The ANT-20SE is factory-configured to perform the following actions when it is switched on:

- Windows starts.
- All necessary windows drivers are loaded.
- The ANT-20SE software is loaded and started.

3.3 Switching on with function key “F3” APPL pressed

If you want to start the ANT-20SE with the default settings and ignore the last application that was saved

– or –

if problems occur with a previously-saved application during boot-up of the ANT-20SE software:

1. Press function key F3 “APPL” when the welcome screen is displayed.
A dialog window opens after a few seconds.
2. Click on the “Yes” button in the dialog window.

When switched on for the first time, the ANT-20SE screen will look like this:

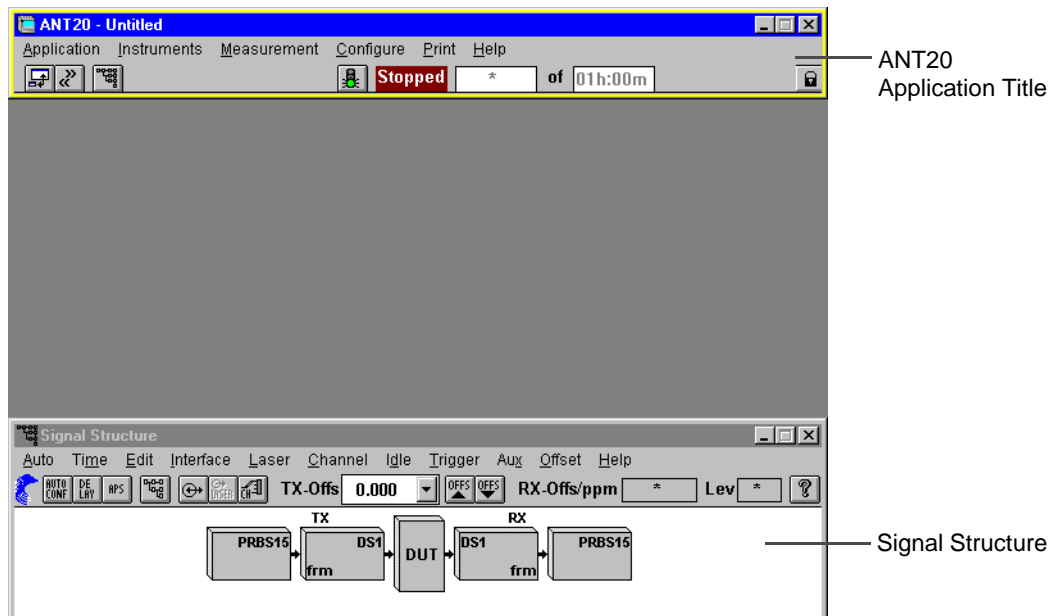

Fig. O-4 ANT-20SE screen display when first switched on

The display initially comprises two windows or virtual instruments, namely:

- ANT20 - <Application Title>
- Signal Structure



3.4 Further operating procedure

In the following sections of part 3, the basic elements of the “ANT20 - <Application Title>” window are described first. This will teach you the operating concept of the ANT-20SE and tell you how to call up the virtual instruments (VI) required for a particular application, and how to use them for future tasks.

In part 4 of this manual you will find detailed information about the windows and dialogs of the individual virtual instruments. This information is also found in the on-line help for the particular VI to provide instant assistance for measurement tasks.

In part 5 you will find some selected measurement examples which will help you to understand the basic operating sequences for the ANT-20SE and how you can approach each measurement effectively.

3.5 Starting programs with the “Instant Access Buttons”

Note: When you switch on the ANT-20SE, Windows starts by default and the ANT-20SE software will be loaded (see Fig. O-4).

Other programs are installed on the ANT-20SE. These programs can be started with the “Instant Access Buttons” or using icons (shortcuts). Proceed as follows:

1. Click on “Exit” in the “Application” menu of the “ANT-20SE - <Application Title>” (Application Manager) window.
The ANT-20SE program terminates.

Note: Programs that do not utilize the ANT-20SE hardware, such as “Notepad”, “Acrobat Reader” or other Windows applications, can be run at the same time as the ANT-20 program.

2. Double click on the  icon on the desktop.

The “Instant Access Buttons” application will be activated.
The desktop will now look like this:

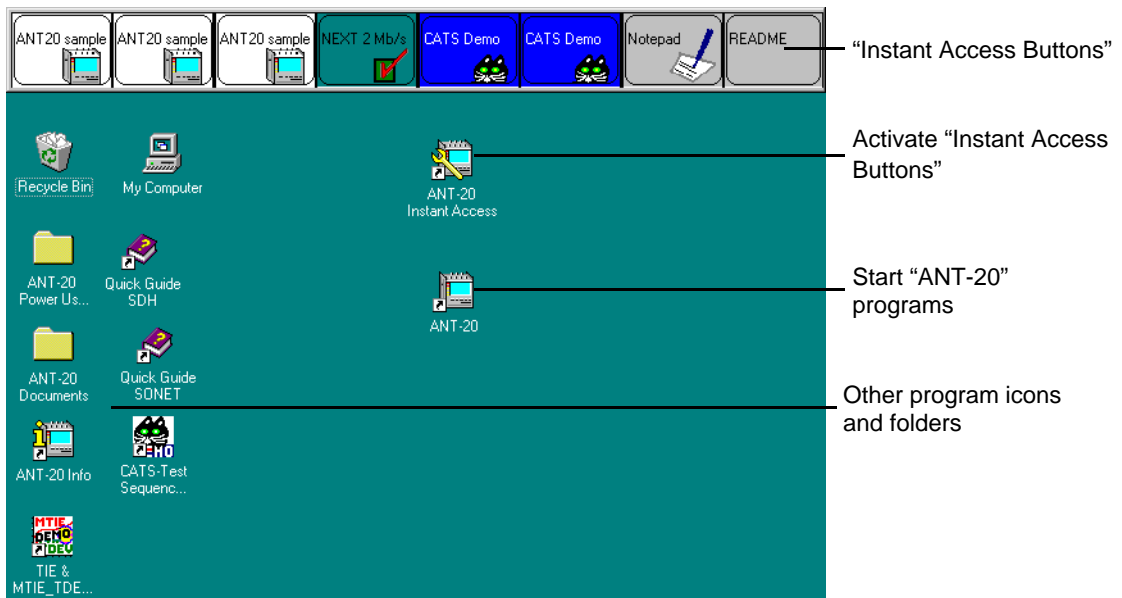
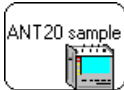
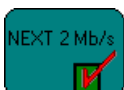
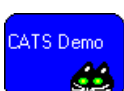

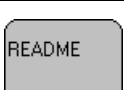

Fig. O-5 ANT-20SE desktop after activating the “Instant Access Buttons”







- Click on the “Instant Access Button” or on the icon for the program that you want to start. The program will start.

The following programs can be started in this way:

Instant Access Button	Program / File	Explanation
	ANT-20	Starts the ANT-20 program with a pre-defined application.
	ANT-20 NEXT BN 3035/95.40	Starts the demo version ¹ of the “ANT-20 NEXT” (ANT-20 Network Expert Test) software.
	ANT-20 CATS BN 3035/95.90	Starts the demo version ¹ of the “ANT-20 CATS” software with a pre-defined application.
	NOTEPAD.EXE	Starts the Window Notepad program (text editor).
	NOTEPAD.EXE	Opens the readme file about the “Instant Access Buttons”.

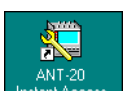
1 The full version of the program starts once software access has been released.

Table O-3 Programs / Files that may be started with the “Instant Access Buttons”

Icon	Program / File	Explanation
	ANT-20	Starts the ANT-20 program with the last application that was loaded.
	Shortcut	Activates the “Instant Access Buttons”.
	MTIE/TDEV Analysis BN 3035/95.21	Starts the demo version ¹ of the “MTIE/TDEV Analysis” software.
	CATS Test Sequencer BN 3035/95.90	Starts the demo version ¹ of the “CATS Test Sequencer” software.
	Acrobat Reader	Opens the “Quick Guide SDH” pdf file.

1 The full version of the program starts once software access has been released.

Table O-4 Programs / Files that may be started with icons (links)







Icon	Program / File	Explanation
	Acrobat Reader	Opens the “Quick Guide SONET” pdf file.
	Shortcut	Opens a folder with pdf files that can be read using the Acrobat Reader.
	Shortcut	Opens a folder with pdf files that can be read using the Acrobat Reader.
	Shortcut	For service purposes only.
1 The full version of the program starts once software access has been released.		

Table O-4 Programs / Files that may be started with icons (links) (continued)

Notes on the use of the “Instant Access Buttons”

If you often use the “Instant Access Buttons” or you work with other applications, remove the shortcut for starting the ANT-20SE program from the “Startup” group.

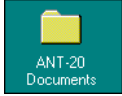
The “ANT-20SE”, “CATS” or “ANT-20 NEXT” programs cannot be run simultaneously. If one of these programs has been started, you cannot start another of these applications using the “Instant Access Buttons”.

If you remove the ANT-20 program shortcut from the “Startup” group, long-term measurements will not be resumed if they are interrupted by an AC power failure. Copy the “ANT-20” icon back into the “Startup” group or use an uninterruptible power supply if you want to make long term measurements.

Removing the “Instant Access Buttons” application

1. Press the “Shift” key.
2. Click on one of the “Instant Access Buttons” at the same time.
A context menu opens.
3. Click on “Exit”.
The “Instant Access Buttons” are removed.

– or –

- ⇒ Press the “Alt” + “F4” keys simultaneously when the “Instant Access Buttons” are activated.
The “Instant Access Buttons” are removed.

Editing the “Instant Access Buttons”

Each of the “Instant Access Buttons” can be customized to your requirements. You can change the labelling or link a button to a different application. More information about how to do this is found in the README file for the “Instant Access Buttons” (open by double clicking on the README icon).



4 ANT-20SE windows

4.1 Overview

4.1.1 The “ANT20 - <Application Title>” (Application Manager) window



The “ANT20 - <Application Title>” window is the control panel for the ANT-20SE. It performs the following important tasks:

Management of:

- Measurement applications
- Virtual instruments (VI) associated with the measurements
- Results recorded by the measurements

Other functions:

- Starting a measurement
- Stopping a measurement
- Entering the duration of a measurement
- etc.

Overview of the “ANT20 - <Application Title>” window

- | | |
|-------------------------------|-------------------------|
| • Loading an application | see Sec. 5.4, Page O-23 |
| • Creating an application | see Sec. 5.1, Page O-19 |
| • Saving an application | see Sec. 5.3, Page O-23 |
| • Measuring with the ANT-20SE | see Sec. 6, Page O-25 |
| • Calling up on-line help | see Sec. 7, Page O-31 |

Information on using the windows is found in Sec. 8, Page O-32.

The remaining sections cover the following topics:

- | | |
|---|------------------------|
| • Printing out and exporting results | see Sec. 9, Page O-35 |
| • ANT-20SE reaction to a.c. power failure | see Sec. 10, Page O-42 |



4.1.2 Virtual instruments



Various virtual instruments are combined to form a measurement application.

Note: Up to eight virtual instruments can be loaded simultaneously. A warning message is displayed when no further virtual instruments can be loaded.

Each virtual instrument is displayed in a separate window. The virtual instruments for the measurement application that is currently loaded are also shown as icons on the left-hand side of the Application Manager.

Virtual instruments are used to control or display certain related functions or measurement results. Detailed information about the individual virtual instruments is found in Part 4 of this manual. This information is also found in the on-line help for the particular VI to provide instant assistance for measurement tasks.

The virtual instruments fall into four main groups:

- Signal Structure see: Part 4, Section 2

The “Signal Structure” VI is a universal instrument that is required for practically every application. It is normally loaded at the same time as the Application Manager when the program is booted up.

- Physical Layer

These VIs are used for measurements in the physical layer:

- Anomaly/Defect Insertion see: Part 4, Section 3
- Anomaly/Defect Analyzer see: Part 4, Section 4
- Overhead Generator see: Part 4, Section 5
- Overhead Analyzer see: Part 4, Section 6
- Pointer Generator see: Part 4, Section 7
- Pointer Analyzer see: Part 4, Section 8
- PDH Generator/Analyzer see: Part 4, Section 9
- Performance Analysis see: Part 4, Section 10
- O.172 Jitter Generator/Analyzer see see Operating Manual BN 3060/96.21, Part 5

- ATM Standard

These VIs are used for measurements in the ATM layer if the “ATM Module/ATM Mappings” option is fitted.

- ATM Signal Structure see Operating Manual BN 3060/96.21, Part 6
- ATM Background Generator see Operating Manual BN 3060/96.21, Part 6
- ATM Traffic Analyzer see Operating Manual BN 3060/96.21, Part 6

- ATM Advanced

These instruments are used for measurements in the ATM and higher service layers if the “Broadband Analyzer/Generator” option is fitted.

- ATM Test Control see Operating Manual BN 3060/96.21, Part 7
- ATM Test Result see Operating Manual BN 3060/96.21, Part 7
- ATM Channel Explorer see Operating Manual BN 3060/96.21, Part 7



4.2 Elements of the “ANT20 - <Application Title>” window

The “ANT20 - <Application Title>” window is made up from the following elements:

- Toolbar
- Menu bar with pull-down menus
- Title bar

Some functions can be accessed from the menus and from the icons in the toolbar. The individual elements are described in the sections that follow.

To allow you to make the best use of the screen area while you are working, the “ANT20 - <Application Title>” window can be switched from its normal size (see Fig. O-6) to a space-saving reduced size (see Sec. 4.2.1).

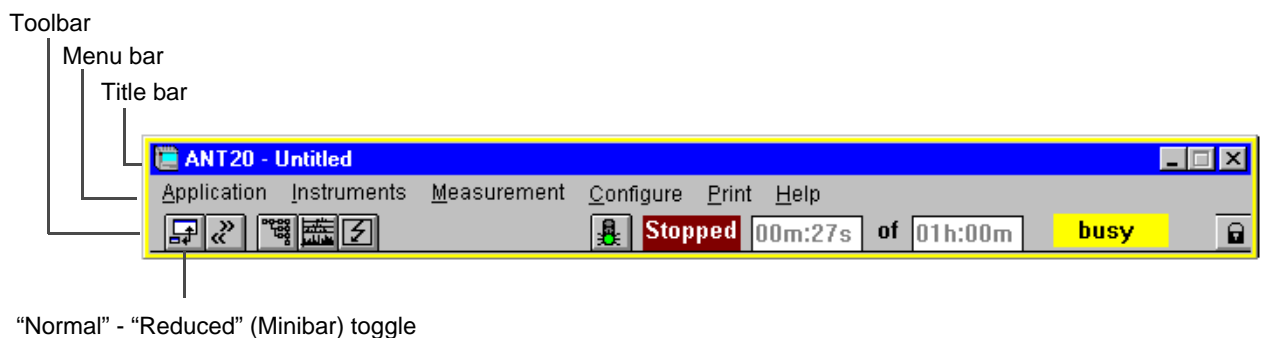

Fig. O-6 The “ANT20 <Application Title>” window, normal size

4.2.1 Minibar (Application Manager reduced form)

The Toolbar includes the main functions of the Application Manager and corresponds to the reduced form of the Application Manager window, also called “Minibar”. You still have instant access to the central control and management functions of the ANT-20SE from this Minibar. You can configure it so that it is always on top (never hidden by other windows).

4.2.1.1 Displaying virtual instruments

Next to the toggle button there is an arrow button which is used to select the virtual instruments for an application (Add & Remove). The example shows an application with three virtual instruments. To enter parameters or read the results in a particular VI, simply click on the corresponding icon button in the Minibar. The corresponding window will then be placed on top. This gives you instant access to every window in an application even if some windows are concealed by others or have been reduced to icons (see Fig. O-31).

4.2.1.2 Starting and stopping a measurement

Measurements are started and stopped using the “traffic signal” icon button. The progress of the measurement can be monitored in the adjacent display fields.

These show the status of the measurement and the elapsed measurement time as well as the set measurement time.



4.2.1.3 Disabling entries

You can disable entries from the keyboard, touchscreen or trackball to prevent unintentional operation.

⇒ Click on the “Keyboard Lock ...” command in the “Configure” menu.
– or –

⇒ Click on the  icon in the “ANT20 - <Application Title>” (“Minibar”) window.
Entry will be disabled.

4.2.1.4 Enabling entries

1. Press the “Alt” + “Tab” keys repeatedly until the “Minibar” is activated.
2. Press the “ESC” key.

4.2.1.5 Other important functions

The Minibar still provides access to all major instrument functions. If you click on an area where there are no icon buttons, a pop-up menu appears. This contains a selection of functions from the menu bar, including functions for application management and closing the program.

Tip: If you want the reduced Application Manager to be always visible, select the “Always on Top” option in the “Configure” menu (see Sec. 4.2.2.4).

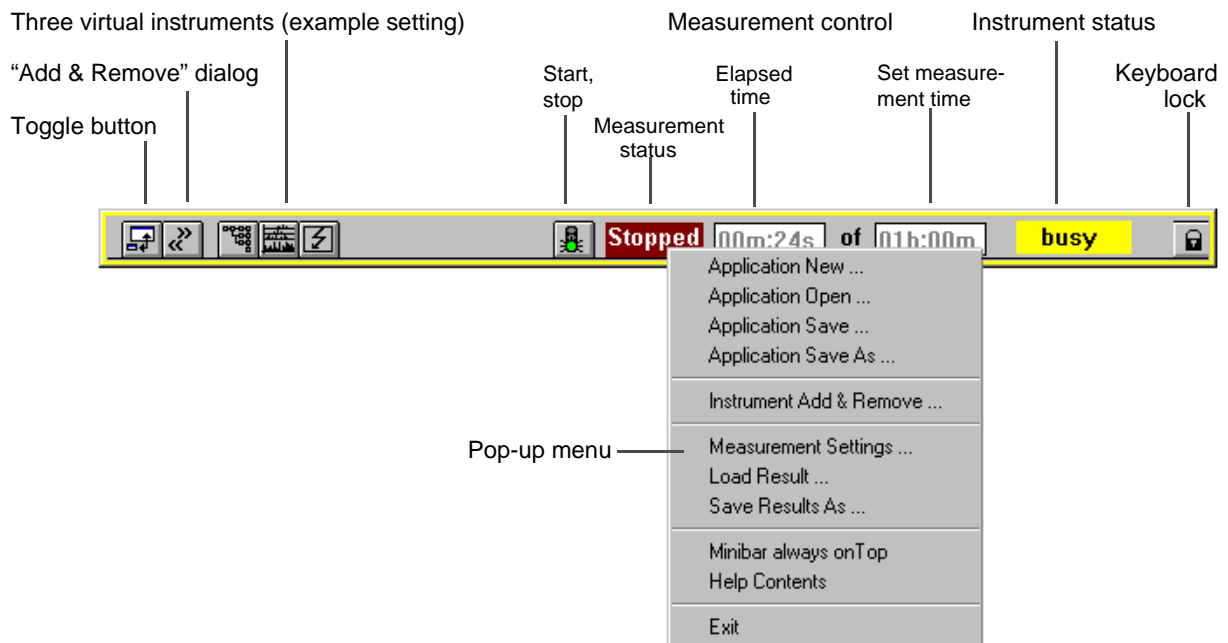

Fig. O-7 Elements of the Minibar or reduced “ANT20 - <Application Title>” window



4.2.2 Menu bar and pull-down menus

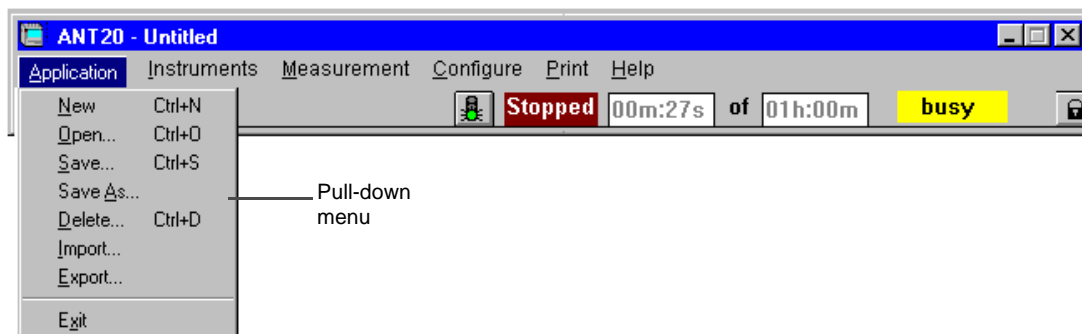

Fig. O-8 Menu bar with “Application” pull-down menu opened

The menu bar shows the names of the various pull-down menus.

Menu commands followed by an ellipsis (...) open further windows or dialogs. Some commands are followed by a hotkey combination. Press the keys shown to execute the command directly.

4.2.2.1 The “Application” menu

The “Application” menu (see Fig. O-8) handles the following functions for ANT-20SE applications:

- Create
- Load
- Save
- Delete
- Import
- Export

The “Exit” command closes the “ANT20 - <Application Title>” window and any other ANT-20SE windows that are open. The program stops and all settings are saved.



4.2.2.2 The “Instruments” menu

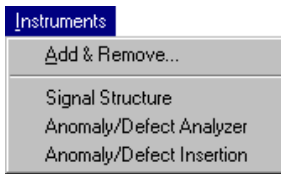

Fig. O-9 The “Instruments” menu of the “ANT20 - <Application Title>” window (example)

The menu has two parts:

- Add & Remove
This command opens the “Add & Remove Instruments” dialog window which is used to add VIs to an application or remove VIs from an application (see Sec. 5.1, Page O-19).
- List of VIs in the current application.
Selecting one of the items in this part of the menu places the corresponding VI window on top.

4.2.2.3 The “Measurement” menu

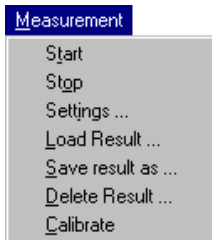

Fig. O-10 The “Measurement” menu of the “ANT20 - <Application Title>” window

The “Measurement” menu is used to start and stop the measurement. It is also used to configure the measurement sequence with the “Settings ...” dialog. The menu items “Load, Save, Delete Result” are used to handle the measurement results. Each set of measurement results consists of the instrument settings and all the measurement results for the last measurement interval that has elapsed.



4.2.2.4 The “Configure” menu



Fig. O-11 The “Configure” menu of the “ANT20 - <Application Title>” window

The “Configure” menu sets whether the Minibar (Application Manager) is to be always visible or not. It is also used to set the menu language and lock the keyboard to prevent inadvertent operation, if required.

The “LED Display ...” command extends the functions of the LED display on the front panel. The “AU-LOP/LOP-P” LED can be used to indicate the message “AU-NDF” in addition to the “AU-LOP/LOP-P” messages. The “TU-LOP/LOP-V” LED can be used in the same way to indicate the message “TU-NDF” in addition to the “TU-LOP/LOP-V” messages.

The “Keyboard Lock ...” command disables entries using the keyboard, touchscreen or trackball to prevent unintentional operation. Entry is enabled again when you press the “ESC” key. The “ANT20 - <Application Title>” (“Minibar”) window must be active for this (also see Sec. 4.2.1.4, Page O-14).

The “Delete result warning” item is used to activate a warning message that will appear if you perform an operating step that will result in deletion of results.

4.2.2.5 The “Print” menu

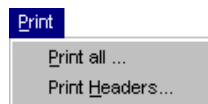

Fig. O-12 The “Print” menu of the “ANT20 - <Application Title>” window

The “Print” menu of the Application Manager allows you to collectively print out the available measurement results from the opened virtual instruments.

4.2.2.6 The “Help” menu

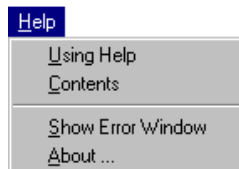

Fig. O-13 The “Help” menu of the “ANT20 - <Application Title>” window

This menu opens the on-line help for the Application Manager window and also opens the error window. The “About...” option displays a window showing the instrument version, software version and a list of the options fitted to the mainframe.



4.2.3 Title bar

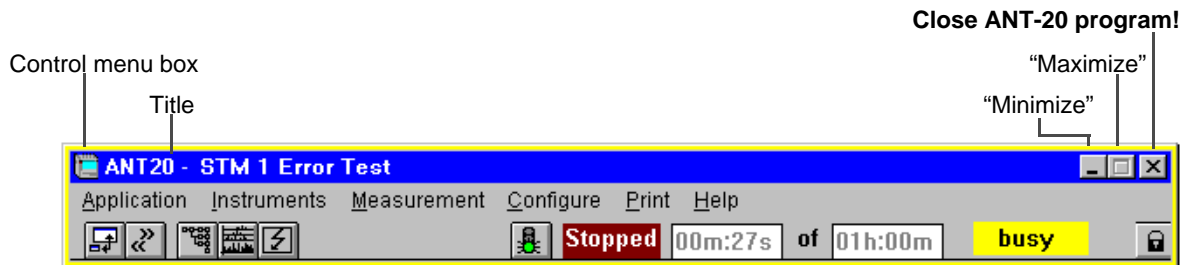

Fig. O-14 Title bar

Control menu box

The control menu box is located in the upper left corner of a window. The control menu itself varies from one application to another, and contains commands for handling the application windows.

Tip: The main VI windows of the ANT-20SE cannot be closed by double clicking on the control menu box. A double click on the control menu box reduces the window to an icon (exception: "ANT20 - <Application Title>" window).

Title

The title shows the name of the application that is loaded, e.g. "STM-1 Error Test". If you create a new application the title will initially show "Untitled".

Minimize button

Click on the "Minimize" button to reduce the Application Manager to its reduced size. The "Minimize" button reduces all other virtual instruments to icons.

Maximize button

The "Maximize" button has no function in the main VI windows. It is grayed out in Windows95.

Close ANT-20SE program button

Click on the "Close" button to close the window and exit from the application.

The button corresponds to the menu command "Application / Exit".



5 Creating, saving and loading applications

An application is created in three steps:

- Select the virtual instruments for the application.
- Set the signal structure.
- Save the application.

5.1 Selecting the virtual instruments for an application



The virtual instruments to be used for an application are selected in the “Add & Remove Instruments” dialog of the Application Manager (see Fig. O-15). There are two basic ways to set up an application:

- ⇒ You can create a new application by modifying an existing selection. To do this, call up the “Add & Remove Instruments” dialog directly by clicking on the icon button shown above.
 - or –
- ⇒ You can create a new application without reference to a previous selection. To do this, call up the “Add & Remove Instruments” dialog using the “Application / New” command. This removes all the currently loaded VIs and loads the default settings.

“Add & Remove” dialog when no ATM options are fitted

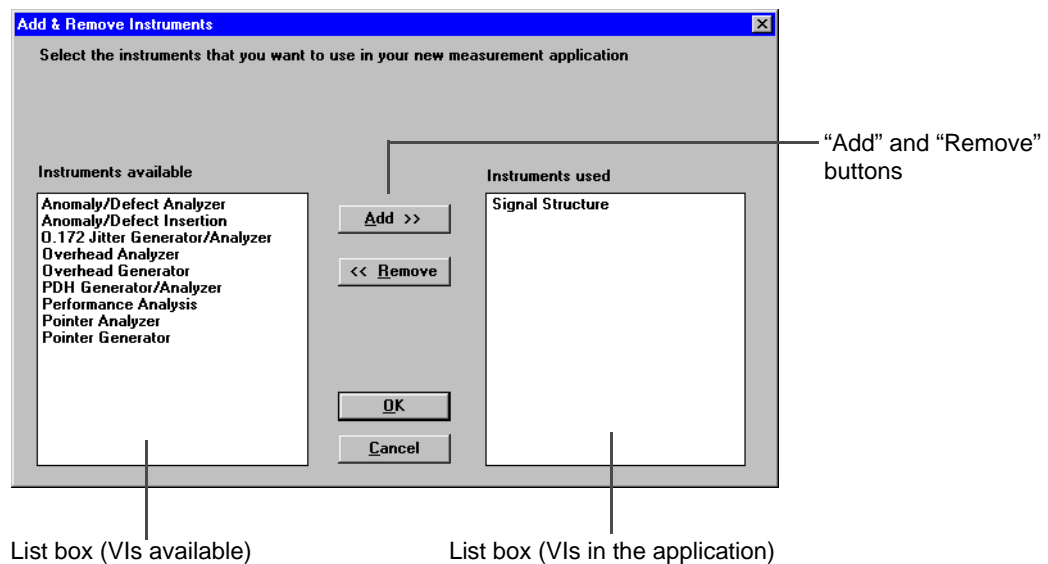

Fig. O-15 The “Add & Remove Instruments” dialog window of the Application Manager

The dialog is split into the following parts:

- “Instruments available” list box: This shows all the VIs that are available, depending on the selection already made. All the VIs except “Signal Structure” are listed if the “Application/ New” command was used to open the dialog.
- “Instruments used” list box: This shows the VIs used for the application. The “Signal Structure” VI is shown if the “Application/New” command was used to open the dialog.
- Action buttons for adding and removing VIs to / from an application.



To select VIs for an application

1. Click on the first VI that you want to load from the “Instruments available” list box, e.g. “Anomaly/Defect Analyzer”.
The name is highlighted.
2. Click on the “Add >>” button.
– or –
Double click on the VI that you want to load, e.g. “Anomaly/Defect Analyzer”.
The item in the list will be transferred from the “Instruments available” list box to the “Instruments used” list box.
3. Repeat steps 1 and 2 to add further VIs to your application.
The “Add & Remove Instruments” dialog window will then look something like the figure below.
4. Click on the “OK” button when you have added all the VIs that you require.
In the example, the “Anomaly/Defect Insertion”, “Anomaly/Defect Analyzer” and “Signal Structure” VI windows will now open. The icons for these VIs are also now displayed in the “ANT20 - <Application Title>” window (normal or reduced size) and the names of these VIs are also listed in the “Instruments” menu.

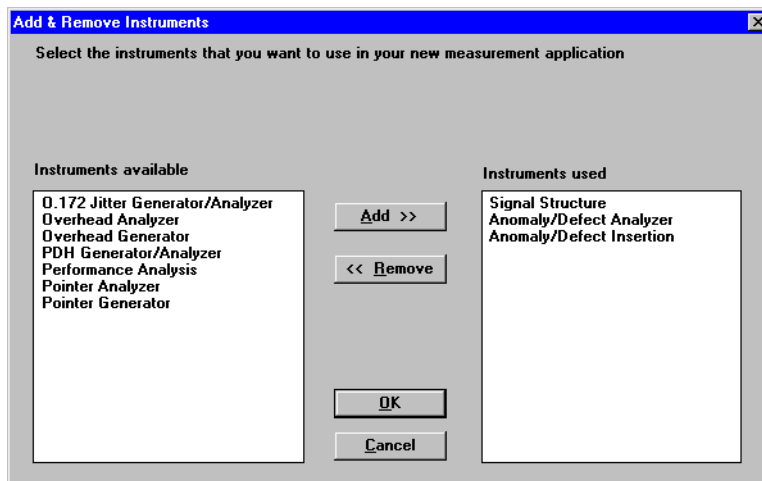

Fig. O-16 “Add & Remove Instruments” dialog window after adding the VIs required (“Physical Layer” group pre-selected)

The “Add & Remove” dialog when ATM options are fitted

If your ANT-20SE is equipped with one or more ATM options (ATM Module, Broadband Analyzer/Generator), you can display the virtual instruments in groups for selection from the “Instruments available” list box.

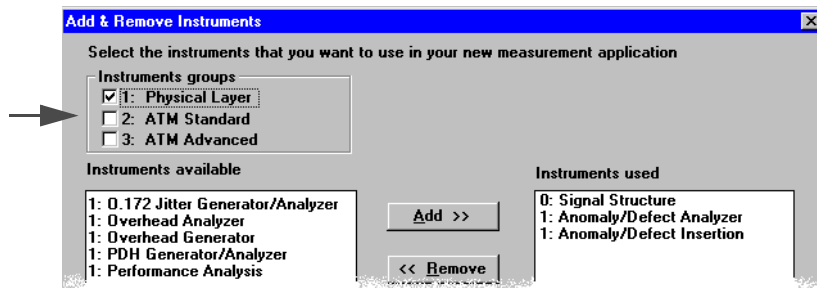

Fig. O-17 Check boxes for selecting / deselecting instrument groups



This reduces the scope of the list for a given application to make it easier to locate the VIs you want to select. When all options are fitted, the following instrument groups are available:

- Group 1: “Physical Layer”: VIs for the physical layer (standard)
- Group 2: “ATM Standard”: VIs for the “ATM Module” option (BN 3035/90.70)
- Group 3: “ATM Advanced”: VIs for the “Broadband Analyzer/Generator” option (BN 3035/90.80)

For applications that only involve the physical layer, the Group 2 and 3 instruments can be removed.

5.2 Entering the signal structure



The “Signal Structure” virtual instrument has a special position among the ANT-20SE VIs. Before you start to make the settings for your application in the various VIs, the structure of the signal to which the ANT-20SE is to be connected must be entered (sets the interface conditions for the physical layer).

1. In the Application Manager, click on the icon button shown above to activate the instrument. The “Signal Structure” window opens. The display area of the window depicts the signal structure setting that is currently valid.

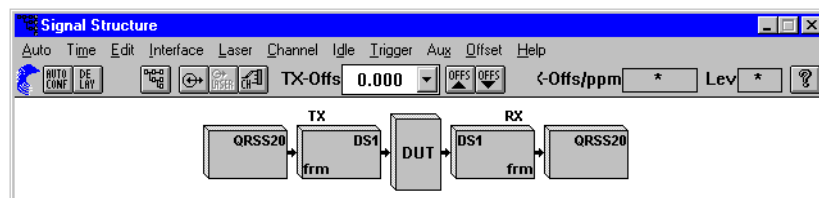

Fig. O-18 The “Signal Structure” window



2. Click on the above icon in the toolbar.
– or –
Click on the “Signal Structure” command in the “Edit” menu.
The “Edit Signal Structure - TX” dialog window opens.



Fig. O-19 The “Edit Signal Structure - TX” dialog window



Example

The following example shows how to set up a “STS-1/VT1.5/DS1 framed” multiplex structure for the generator (TX) and receiver (RX).

3. Click on the “TX” button in the “Edit” field of the “Edit Signal Structure - TX” dialog window.
4. Click on the “Clear” button.
The TX signal structure is cleared.
5. Click on the “ANSI” button.
6. Click on the following buttons in the “Edit Signal Structure - TX” dialog window in the order given:
 - “TX”
 - “STS1”
 - “VT1.5 SPE”
 - “DS1”
 - “Framed”
 - “TX => RX”

The “Signal Structure” dialog window will then look like this:

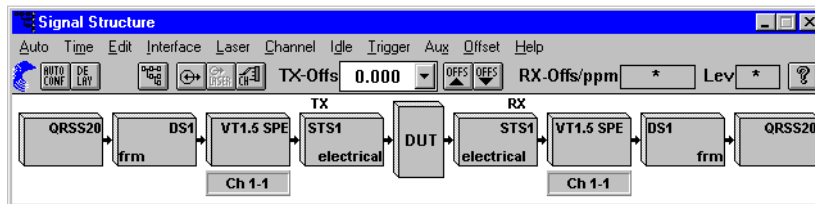

Fig. O-20 “Signal Structure” dialog window after entering the signal structure

7. Confirm the settings you made by clicking on “OK”.

You can also enter the signal structures for the TX and RX sides separately if you want to use different signal structures for the generator and the receiver.

Using the menus or the toolbar of the “Signal Structure” dialog window, you can make other settings such as:

- Offset
- Clock Source
- Line code
- etc.

The “Mapping” and “Channel” boxes in the signal structure are “context-sensitive”. If you click on one of the elements, a specific dialog window (channel settings dialog) opens.

The signal structure is saved along with the application.

Tip: More information on the “Signal Structure” VI is found in Part 4, Section 2 or in the on-line help for the window.



5.3 Saving an application



Once you have created an application, it is saved using the “Save Application As” dialog. Depending on the Application Manager setting (reduced or normal size) the dialog is opened in various ways.

- ⇒ Open the dialog using the “Application Save As...” command in the pop-up menu (reduced size Application Manager).
 - or –
- ⇒ Open the dialog using the command sequence “Application / Save As...” (normal size Application Manager).
The “Save Application As” dialog window opens.

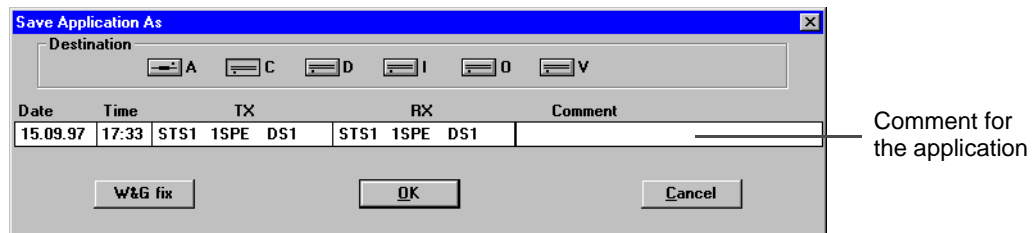

Fig. O-21 The “Save Application As” window

To save an application

1. Click on the “Comment” box.
 2. Use the keyboard to enter a comment for the application, e.g. “Error Measurement”.
 3. Click on “OK”.
The application is saved. The window title shown in the title bar of the Application Manager will change from “Untitled” to the title you entered in the “Comment” box, e.g. “Error Measurement”.
- The “Application Save” (reduced size) and “Application / Save” (normal size) Application Manager menu commands modify the current application in the database.
 - The “Application Save As...” (reduced size) and “Application / Save As...” (normal size Application Manager) menu commands create a new application.

5.4 Loading an application

The ANT-20SE allows you to load pre-defined applications using the “Open Application” dialog.

- ⇒ Open the dialog using the “Application Open...” command in the pop-up menu (reduced size Application Manager).
 - or –
- ⇒ Open the dialog using the command sequence “Application / Open...” (normal size Application Manager).
 - or –
- ⇒ Press function key “F3” APPL.
The “Open Application...” dialog window opens.



The “Open Application” dialog

The “Open Application” dialog contains a list of available applications for a particular drive (Source). The scrollbars are used to move through the list horizontally and vertically.

To load an application

1. Click on the item in the list corresponding to the application that you want to load.
The item is highlighted in gray.
2. Click on the “OK” button.
The selected application is loaded and the ANT-20SE is immediately ready to measure.

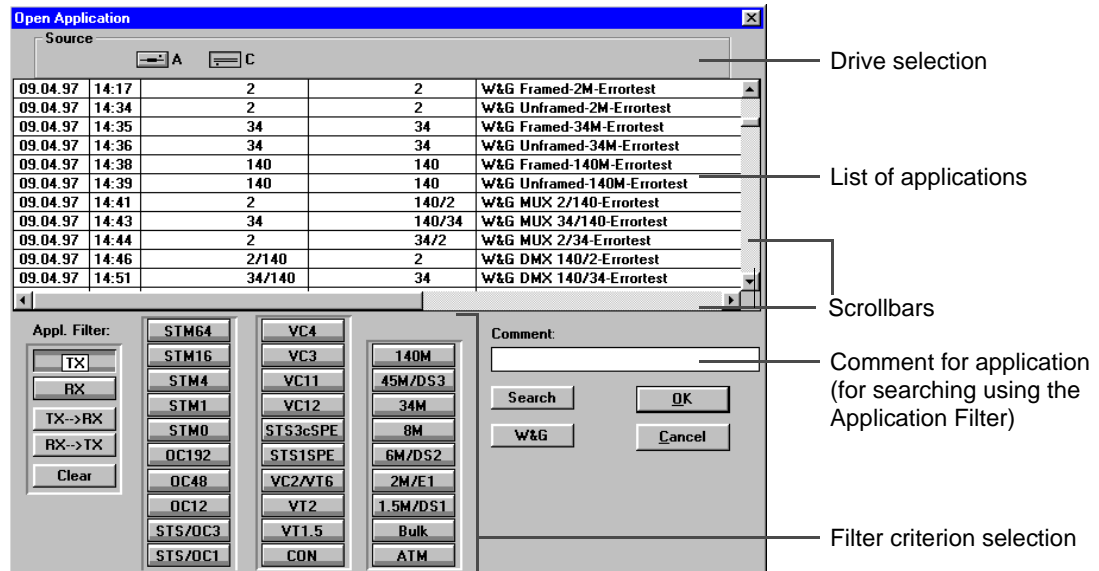

Fig. O-22 The “Open Application” dialog window

Press function key “F5” MEASUREMENT START to start a measurement using the pre-selected measurement parameters.

Tip: Handling of applications is simplified by selecting filter criteria.

Saved applications are differentiated by the following features:

- Date/time saved
- TX signal structure
- RX signal structure
- Comment

Using the buttons in the “Application Filter:” field, you can select a signal structure, separate for the generator and receiver.

Only those applications having this signal structure will then be displayed.

Enter a comment in the “Comment:” field to search for applications with corresponding comments. The “W&G” button lists only those pre-defined applications with names beginning with “W&G ...”.



6 Measuring

This section basically describes how to

- set the measurement duration
 - for a manually-started measurement
 - for an automatically-started measurement
- set the measurement parameters, e.g. insert an anomaly
- start the measurement
- stop the measurement
- display the results e.g. using the “Anomaly/Defect Analyzer” VI
- Other TX parameters are normally set using the Generator VIs or windows.
- Results are normally displayed using the Analyzer VIs or windows.
Further information is found in Part 4.

6.1 Setting the parameters

Setting the measurement duration (Application Manager)



The measurement duration (e.g. 60 seconds) is set using the “Measurement Settings” dialog in the Application Manager.

1. Open the dialog using the “Measurement Settings...” command in the pop-up menu (reduced size Application Manager).
 - or –
 - Open the dialog using the command sequence “Measurement / Settings...” (normal size Application Manager).
 - The “Measurement Settings” dialog window opens.
2. Activate the “Seconds” option button in the “Gate Time” field (“Seconds” button is marked with a dot).
3. Enter the value 60 into the “Gate Time” input field unless this value is not already displayed.
4. Click on “OK”.

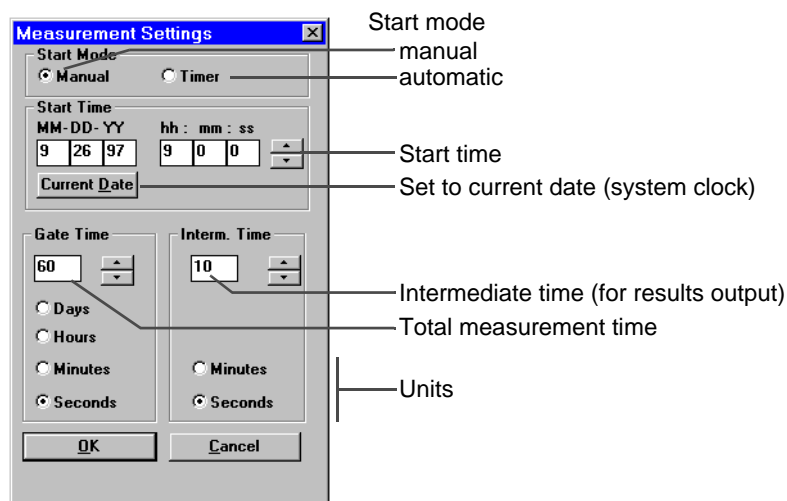

Fig. O-23 The “Measurement Settings” dialog window



Inserting an anomaly (“Anomaly/Defect Insertion” VI)



Anomalies or defects are inserted from the “Anomaly/Defect Insertion” window. The following example describes how to insert a “TSE” (Test Sequence Error) with an error rate of 10^{-6} .

To insert e.g. an anomaly

1. Activate the “Anomaly/Defect Insertion” window.
2. Select “Anomalies” from the “View” menu.
 - or –
 - Click on the corresponding button in the toolbar.
3. Activate the “TSE” (Test Sequence Error, Bit Error) option button in the “Anomaly” field.
4. Activate the “continuous” option button in the “Insertion” field.
5. Select an anomaly rate of “1E-6” from the “Rate” list box.
6. Click the “ON” button in the toolbar.
 - or –
 - Press function key “F7” INSERTION/ANOMALY.
 - “TX ANOMALY” appears in the status box in the Application Manager toolbar.
 - The results of the measurement in progress are displayed in the windows of the appropriate VIs, in this case in the “Anomaly/Defect Analyzer” window.

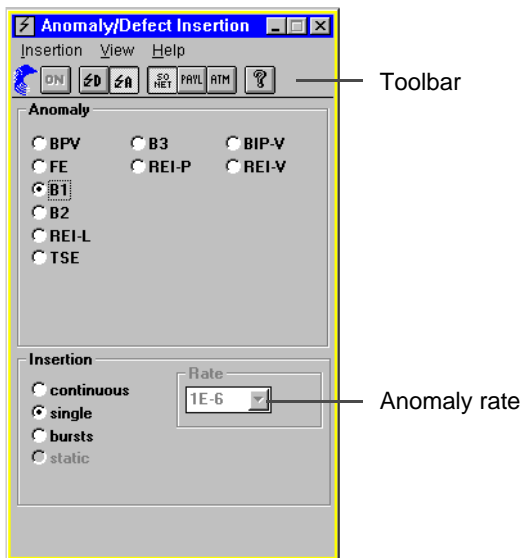

Fig. O-24 The “Anomaly/Defect Insertion” window

Tip: More information about the “Anomaly/Defect Insertion” VI is found in Part 4, Section 3 or in the on-line help for the window.



6.2 Starting and stopping the measurement



The measurement is controlled from the Application Manager as follows:

- Start and stop measurement manually (see Sec. 6.2.1)
- Start measurement manually and stop measurement automatically (see Sec. 6.2.2)
- Start and stop measurement automatically (see Sec. 6.2.3)

6.2.1 Starting and stopping a measurement manually

Measurements can be controlled manually by clicking on the “Traffic signal” icon in the Application Manager (start / stop toggle function).

- ✓ “Manual” start mode must be activated, see “Measurement Settings” dialog.
- ✓ Before starting the measurement, the traffic signal icon is set to “green”.

Starting a measurement manually



Fig. O-25 Icon and menu command for starting a measurement

- ⇒ Click on the “Traffic signal” icon button.
 - or –
- ⇒ Select the “Start” command in the “Measurement” menu.
 - or –
- ⇒ Press function key “F5” MEASUREMENT START.
 - The traffic signal button changes to a “red light” and the “Stop” command in the “Measurement” menu is activated.
 - The Application Manager status display changes from <Stopped> to <Running>.

Stopping a measurement manually

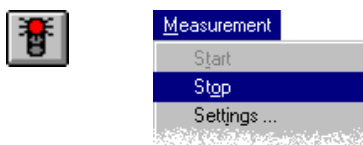

Fig. O-26 Icon and menu command for stopping a measurement

- ⇒ Click on the “Traffic signal” icon button again.
 - or –
- ⇒ Select the “Stop” command in the “Measurement” menu.
 - or –
- ⇒ Press function key “F6” MEASUREMENT STOP.
 - The measurement stops and the traffic signal button changes to a “green light”.
 - The Application Manager status display changes from <Running> to <Stopped>.



6.2.2 Starting a measurement manually and stopping automatically

Measurements can be controlled semi-automatically. Starting is manual, the measurement is stopped automatically as soon as the measurement time interval has elapsed.

Controlling the measurement

1. Open the "Measurement Settings" dialog (see Fig. O-23).
2. Enter the desired timing for the measurement in the "Gate Time" box, e.g. 60 seconds.
3. Click the "OK" button to confirm the settings.

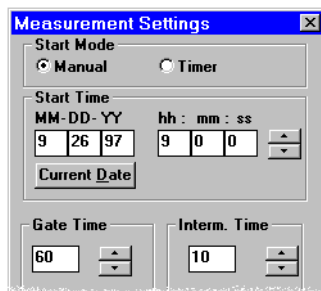

Fig. O-27 Setting the start mode (Timer)

4. Click on the "green light" to start the measurement.
 - The measurement starts and the traffic signal icon changes to a "red light".
 - The measurement stops automatically when the set gate time has elapsed.

6.2.3 Starting and stopping a measurement automatically (timer)

Measurements can also take place fully automatically by programming the start time and stop time. The start time is specified as an absolute time (date and time). The stop time is a relative time, determined by the measurement time or "Gate Time".

Controlling the measurement

1. Open the "Measurement Settings" dialog (see Fig. O-23).
2. Select "Timer" start mode.
3. Enter the desired start date in the "MM-DD-YY" boxes.
 - or –
 - Click on the "Current Date" button if you want the measurement to start today.
4. Enter the desired start time in the "hh-mm-ss" boxes.
5. Enter the measurement time in the "Gate Time" box. The measurement stops after this time.
6. Click the "OK" button to confirm your entries.
 - The measurement will start at the pre-selected time.
 - The measurement will stop as soon as the pre-set gate time has elapsed.

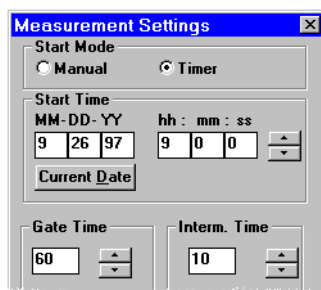

Fig. O-28 Settings: Start mode (Timer), Start Time and Gate Time



6.3 Displaying results e.g. anomalies



The results are displayed by various virtual instruments (see Analyzer VIs in Part 4).

The “Anomaly/Defect Analyzer” VI is used here as an example. This instrument displays the intermediate and final results of measurements of anomalies or defects.

⇒ Click on the above icon for this VI in the Application Manager.

The “Anomaly/Defect Analyzer” VI is placed on top.

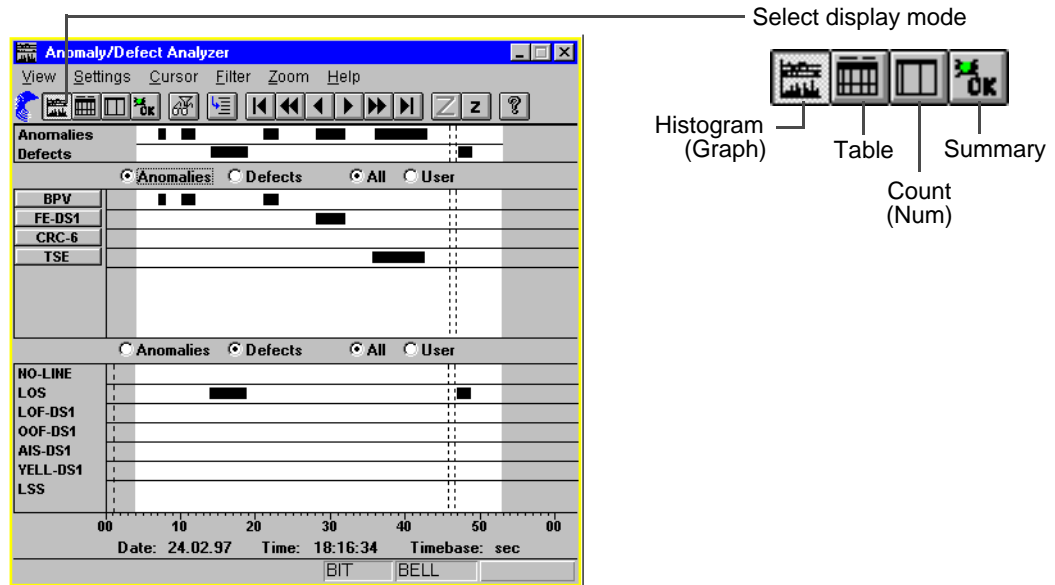

Fig. O-29 Example result display in “Anomaly/Defect Analyzer” window (View “Graph”)

Setting the filter

The “User Filter ...” command in the “Filter” menu opens the “User Filter” window. You can make filter settings in this window so that only certain anomalies or defects are displayed. The filter operates when the “User” option button in the current display mode is activated. Filter settings can only be changed when the instrument status is “STOPPED”.

Positioning the cursor (View “Graph”/“Table”)

The “Goto ...” command in the “Cursor” menu moves the cursor to a specified time section of the results list. The “Cursor” menu also contains other commands that are used to position the cursor.

Printing out the results (View “Table”/“Num”)

The “Print ...” command in the “Print” menu is used to print out the results when a printer is connected to socket [05] or [06] (see Sec. 9.3.1, Page O-38).

**Exporting results (View “Table”/“Num”)**

The “Export ...” command in the “Print” menu is used to export results in a CSV formatted file. This file can be processed with any word processor or spreadsheet program (also see Sec. 9.3.2, Page O-39).

Setting the display resolution (View “Graph”)

The commands in the “Zoom” menu are used to set the display resolution. The selected time segment is automatically transferred to the “Table” display when you select this View mode.

Other results are shown in the windows of other VIs.

Tip: More information on the “Anomaly/Defect Analyzer” VI is found in Part 4, Section 4 or in the on-line help for the window.



7 On-line help

On-line help is available for each VI window.

The on-line help function provides information about a particular task, function, command or parameter.

7.1 Calling up on-line help

To call up the on-line help function

- ⇒ Press function key “F1”.
- or –
- ⇒ Select the “Contents” command from the “Help” menu.
- or –
- ⇒ Click on “?” in the toolbar.



Fig. O-30 Commands and keys for calling up on-line help

7.2 Calling up a help topic

- ⇒ Click on the terms underlined in green in the text on which you require more information.
- or –
- ⇒ Click on the context-sensitive areas of the figures when this feature is indicated.

7.3 Setting the size of the help window

When on-line help is called up, the help window fills the entire display area. You can reduce the size of the window and move its position on the display as required.

If you make the help window very small, part of the text may be obscured. If this is so, scrollbars appear down the right-hand side and along the bottom of the window. These are used to scroll through the text.

Tip: If you reduce the size of the help window so as to display the measurement program at the same time, select the “Small” font (“Options” menu). This makes best use of the available area of the help window.



8 How to use the windows

8.1 Arranging the application windows

The number of virtual instruments in your ANT-20SE depends on the hardware and software fitted. The VIs are included into applications that are created and managed using the Application Manager. When an application is loaded, all the windows for the VIs included in the application will be opened. The parameters for the VIs are set using these windows and other dialog windows. The dialog windows open when you click on various buttons or certain menu commands in the VI windows.

Tip: As the display area of the screen is limited, all VI windows that are not needed should be reduced to icon buttons (use the “Minimize” button).
An iconized VI window can be restored to its original size at any time
- by clicking on the corresponding icon in the Application Manager, or
- by clicking on the corresponding icon button in the task bar at the bottom of the screen.

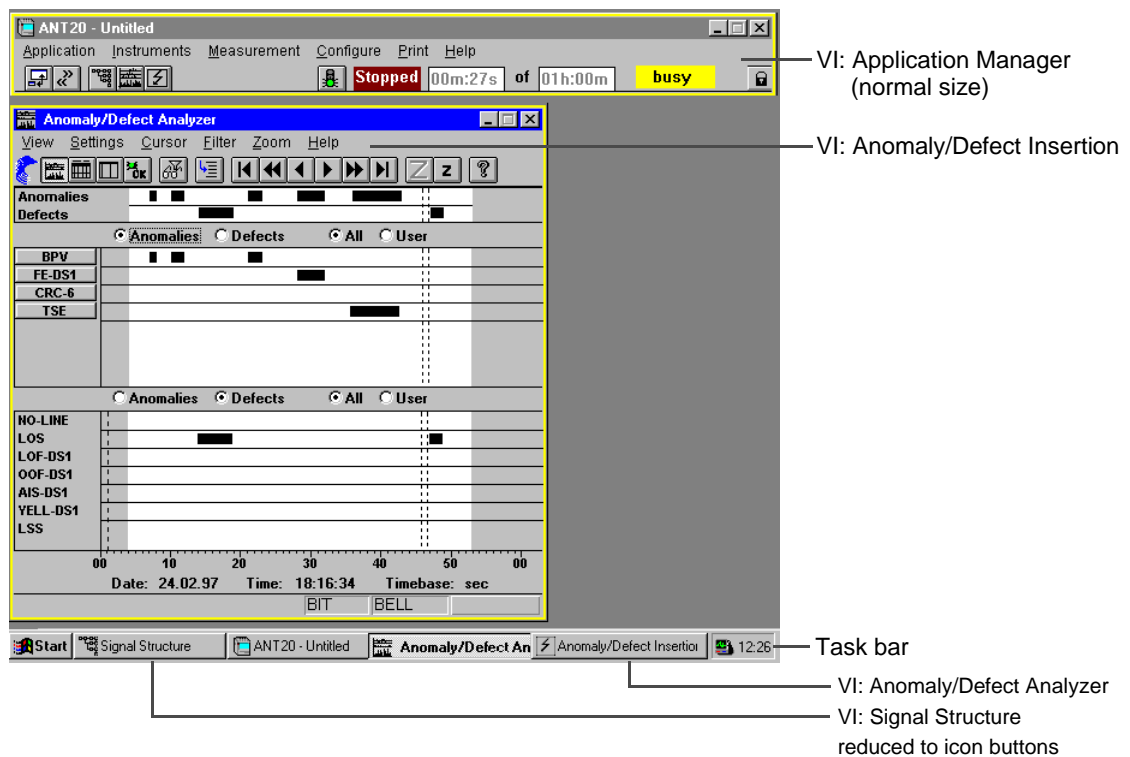

Fig. O-31 Screen display of virtual instruments



8.2 Commonly-used controls

When you select a menu command or an icon, a dialog window may appear in the foreground for you to make further settings. If required, a dialog window can be open at the same time as a display window, for example if you want to display results during a measurement and change the parameters on-line.

The commonly-used dialog window controls are described below using the “User Filter” (VI “Anomaly/Defect Analyzer”) dialog as an example.

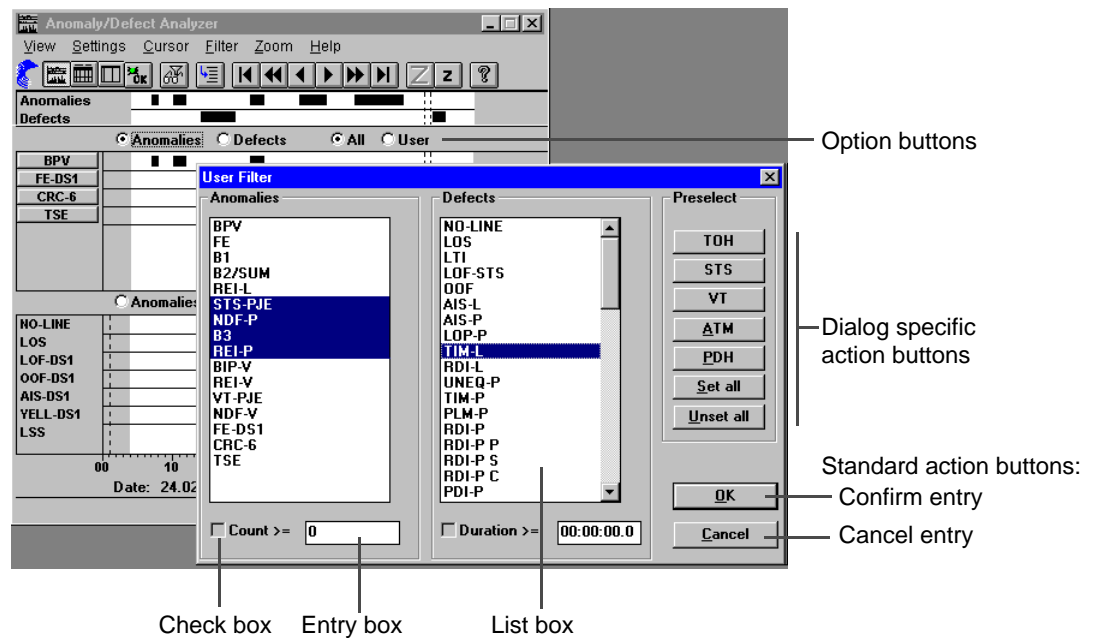

Fig. O-32 Dialog window showing commonly-used controls

Option buttons

Option buttons are arranged in groups. Only one button can be activated in each group. The selected or activated option is indicated by a black dot. Inactive option buttons are empty.

Action buttons

Clicking on an action button executes an action directly.

Action buttons with toggle functions appear pressed when clicked on once and the label on the button changes (e.g. from “OFF” to “ON”). Clicking the button again causes it to “pop up” and the label reverts to its original function (e.g. “OFF”).

Check boxes

Check boxes are used to activate / deactivate other options. The option that you selected is indicated by a check (✓).

List boxes

List boxes generally contain one or more items arranged in a certain order. A current item in the list is activated by clicking on it. A scrollbar appears next to the list if it contains more items than can be displayed in the box at one time.



Entry boxes

These are boxes where you enter alphanumeric characters (parameter values, names). Where numerical values are to be entered, the range of values allowed for the parameter will be checked. Invalid parameter values are ignored.

Important: Entries are accepted only when the cursor in the entry box stops blinking. This happens when you move to another entry box by clicking on it or by pressing the "TAB" key.

You can enter characters from the normal keyboard or by means of the "Keyboard" window if you have activated the "Keyboard On" option.

"OK" button

The "OK" button confirms the parameter entries or changes you made and closes the dialog.

"Cancel" button

The "Cancel" button cancels the parameter entries or changes you made and closes the dialog window.

"CLOSE" button (not shown)

If a dialog window includes a "CLOSE" button instead of the two buttons "OK" and "Cancel", this means that parameters are set as soon as they are entered or altered (see input boxes). The "CLOSE" button simply closes the dialog window.

Keyboard

If the keyboard is activated, you can enter numerical values "on-screen". The "Keyboard" window appears whenever a dialog window containing entry boxes is opened.

The alpha keys are also activated if the parameter to be entered is in hexadecimal code.

The "OK" button transfers the value in the "Keyboard" entry box to the entry box in the dialog window that was previously selected.

The "Keyboard" window closes as soon as you close the dialog window.

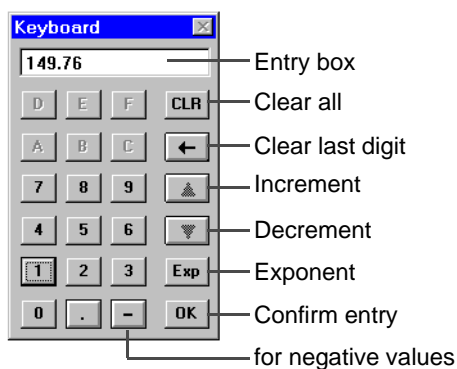

Fig. O-33 The "Keyboard" window for entering numerical parameter values



9 Printing and exporting results

You can connect a printer to the parallel interface (socket [05]) or to the serial interface (socket [06]).

The results can only be printed out or exported when all measurements in progress have ended.

Printing out all final results from the Application Manager

The available measurement results from the opened virtual instruments can be printed out collectively from the Application Manager.

The following virtual instruments can supply results:

Virtual instrument	Results
Signal Structure	Optical level (range) Offset (range)
Anomaly/Defect Analysis	Results that are available from the "Num" display
Performance Analysis	Performance results for the currently selected evaluation and the corresponding setting values.
Jitter O.172 (Jitter O.171)	<p>Jitter measurement: Jitter peak - peak max Jitter + peak max Jitter - peak max Phase Hits pos. count Phase Hits neg. count</p> <p>Wander measurement: MTIE final result plus the corresponding setting values for the results</p>

Table O-5 Possible results included in the printout for the "Print all ..." command

All other virtual instruments provide no results for the printout.

Unavailable results are indicated by * on the printout.

Virtual instrument print and export functions

The following virtual instruments allow printout of results:

- Anomaly/Defect Analyzer
- Pointer Analyzer
- Performance Analysis
- ATM Traffic Analyzer (options BN 3035/90.70 through 90.77)
- Jitter Generator/Analyzer (options BN 3035/90.60 through 90.69)
- ATM Test Results (option BN 3035/90.80)
- ATM Test Control (option BN 3035/90.80)



9.1 Installing a printer

If the driver for the printer that you want to use is not yet installed on the ANT-20SE, you must install the driver first.

You can install the driver from Windows95 if it is included in these programs. The printer drivers are located in directory C:\WIN95.SUP.

We recommend that you install the driver supplied with your printer, or a newer version if this is available. The latest version of the driver can usually be downloaded from the printer manufacturer's Internet home page.

Installing printer drivers on the ANT-20SE

1. Double-click on the "My Computer" icon on the Desktop.
The "My Computer" window opens.
2. Double-click on the "Printer" directory.
The "Printer" window opens.
3. Double-click on the "New Printer" icon.
4. Install the printer driver.



9.2 The “Print” menu – Application Manager

The “Print” menu of the Application Manager allows you to collectively print out the available measurement results from the opened virtual instruments.

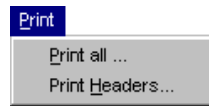

Fig. O-34 “Print” menu in the “ANT20 - <Application Title>” window

9.2.1 Printing results

1. Select the “Print all ...” command in the “Print” menu.
The printer dialog for the default printer opens.
2. Make any settings that are necessary.
3. Start the printout.

9.2.1.1 The “Print Headers” dialog

The “Print Headers” dialog is used to select information that is to be printed out together with the results. The dialog window contains entry fields for:

- Company logo stored as a bitmap (*.BMP- or *.DIB file) in a directory
- Signal structure
 - as a graph if the “Signal Structure” VI is loaded
 - as text if the “Signal Structure” VI is not loaded
- Printout header with data identifying the measurement:
Test instrument inventory number, Customer name, Test object description, Tester’s name, Date
- Comment text (information about the measurement)

The company logo is printed out at a fixed size with its original aspect ratio preserved on all pages of the printout. The other items are printed out on the first page only.

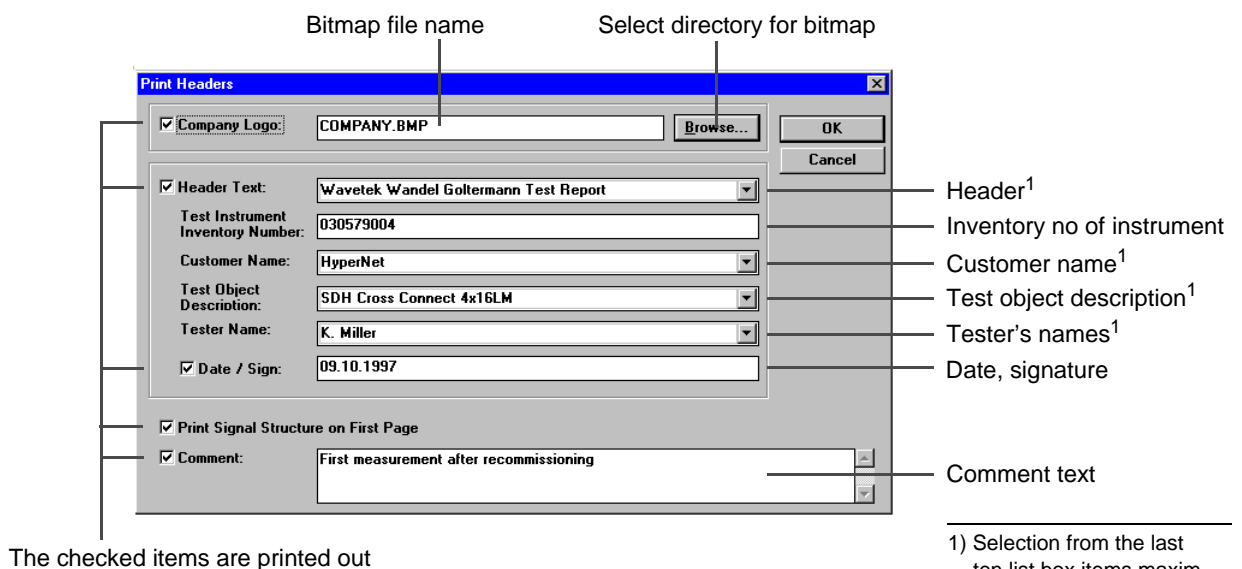

1) Selection from the last ten list box items maxim.

Fig. O-35 The “Print Headers” dialog



9.3 The “Print” menu – Virtual instruments

The “Print” menu is used to print out the results or to export them for further processing with other programs.

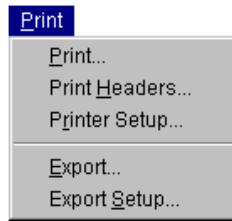

Fig. O-36 The “Print” menu

9.3.1 Printing out results

The results are output to the default printer.

1. Select the “Print...” command in the “Print” menu.
The “Print” dialog opens (see Sec. 9.3.1.1).
2. Click on action button “Headers...”
The “Print Headers” dialog opens (see Sec. 9.3.1.2):
3. Check off the elements that are to be printed.
4. Select the additional information you require from the list boxes.
5. Enter a comment in the “Comment” entry box.
6. Click on “OK” to confirm your entries and to come back to the “Print” dialog.
7. Enter the print quality and the number of copies if required.
8. Click on “OK” to start the print process.
The result record will be output to the default printer. The contents of the active results window are printed out along with the additional information. The printout may take up several pages, depending on the number of results that have been obtained.

9.3.1.1 The “Print” dialog

The “Print” dialog is used to trigger the printout. The following options can be pre-selected:

- Selection and input of additional informations via sub-dialogs
- Selection of printer, paper format via sub-dialog
- Setting the print quality
- Setting number of copies

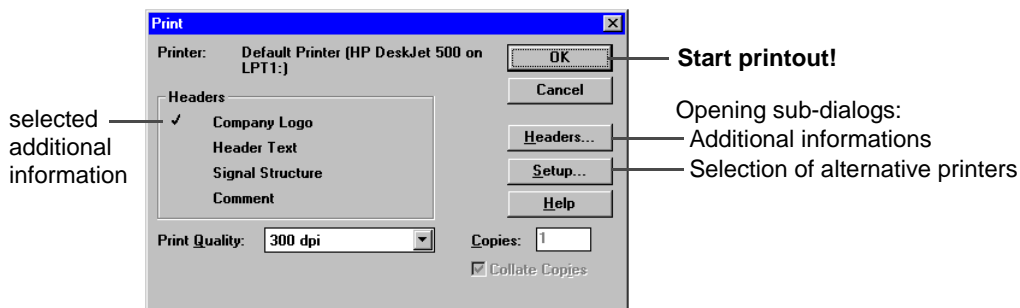

Fig. O-37 The “Print” dialog



9.3.1.2 The “Print Headers” dialog

See also Fig. O-35, Page O-37.

The “Print Headers” dialog is used to select information that is to be printed out together with the results. The dialog window contains entry fields for:

- Company logo stored as a bitmap (*.BMP- or *.DIB file) in a directory
- Signal structure
 - as a graph if the “Signal Structure” VI is loaded
 - as text if the “Signal Structure” VI is not loaded
- Printout header with data identifying the measurement:
Test instrument inventory number, Customer name, Test object description, Tester’s name, Date
- Comment text (information about the measurement)

The company logo is printed out at a fixed size with its original aspect ratio preserved on all pages of the printout. The other items are printed out on the first page only.

9.3.1.3 The “Printer Setup” dialog

The standard Windows “Printer Setup” dialog is used to select the following settings:

- Actual printer
- Paper size / format
- Other options in the “Options” sub-dialog.

The “Options” sub-dialog

The “options” sub-dialog of the “Printer Setup” dialog is used to select the following basic settings:

- Print normally or redirect to Postscript file
- Margins
- Preface on / off

9.3.2 Exporting results

The results can be stored in a specified destination directory or on floppy disk for archiving or for further processing.

1. Select the “Export...” command in the “Print” menu.
The “Save as” dialog opens (see Sec. 9.3.2.1).
2. Select the destination directory where you want the result file to be stored
(if you want to save to a floppy disk, insert one in the drive first).
3. Select the type of file for the saved results.
4. Click on the “OK” button to start exporting the results.

The file type can be altered using the “Export Setup” dialog (see Sec. 9.3.2.2).
The file type selection does not affect the contents of the file.



9.3.2.1 The “Save as” dialog

This dialog is used to define the file in which the results are to be exported. Exported data can be processed with other programs, e.g. spreadsheet programs.

Data are output in CSV format (**c**omma **s**eparated **v**alues). Each item of data is separated from the next by a list separator. The list separator can be selected in the “Export Format” dialog.

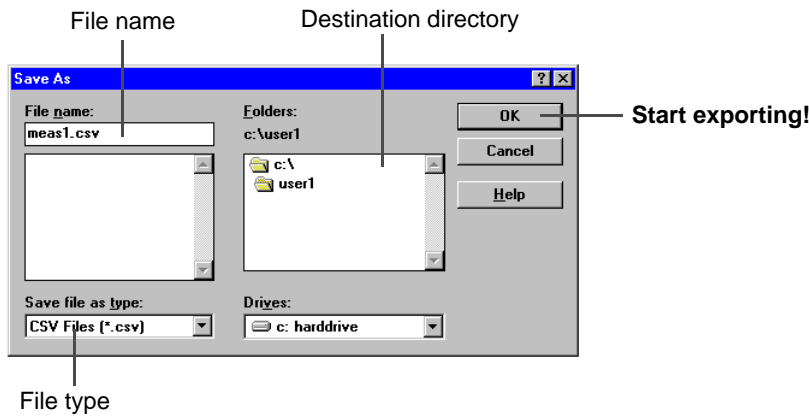

Fig. O-38 Standard Windows “Save As” dialog for exporting results

9.3.2.2 The “Export Format” dialog

This dialog is used to select a list separator character to be used when exporting data. You can also select the character to be used to indicate a decimal point. This allows you to match the exported results to the requirements of any spreadsheet program you may be using.

If the results include time information, the time format can also be selected, e.g. “hh:mm:ss,ms”.

The “Defaults” button sets the current Windows system settings. These settings are useful if, for example, you have installed MS Excel on your ANT-20SE. Data exported using the “Defaults” setting can be directly imported into MS Excel. When importing to another Windows PC, the default configuration can be viewed and edited by opening the window “Control Panel”/ “Regional Settings”.

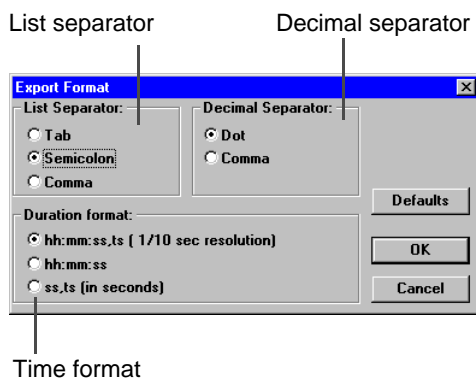

Fig. O-39 The “Export Format” dialog



9.4 The “Screen Dump” print function

You can print out a copy of the screen display if a printer is connected to the ANT-20SE.

To print out the current screen display

⇒ Press the “Prt Sc” key on the front of the ANT-20SE
(see Fig. O-1, Page O-1; keyboard area IV).



10 ANT-20SE behavior in the event of an AC power failure

10.1 Backup data set

Once a measurement has started, the ANT-20SE generates a set of backup data once every minute. This data set contains all the measurement parameters and all measurement results up to that point collected from the VIs. The ANT-20SE can use the backup data set to continue with the measurement after an AC power failure. The first backup data set is available approximately 10 to 15 seconds after the start of the measurement. If a backup data set has not yet been saved before a power failure occurs, the measurement cannot be continued when power is restored.

The AC power failure time is saved as a “No-Power” alarm and is displayed when a backup data set is generated.

Exceptions

No backup data are generated for automatic measurement sequences (Autoconfiguration, MTJ, JTF, etc.).

A wander measurement is not an automatic measurement sequence. Wander measurements will be resumed after an AC power failure.

The “intermediate” evaluation starts afresh on restoration of AC power. The “intermediate” intervals are then no longer synchronous with the absolute time.



10.2 Examples

10.2.1 Manually triggered measurements

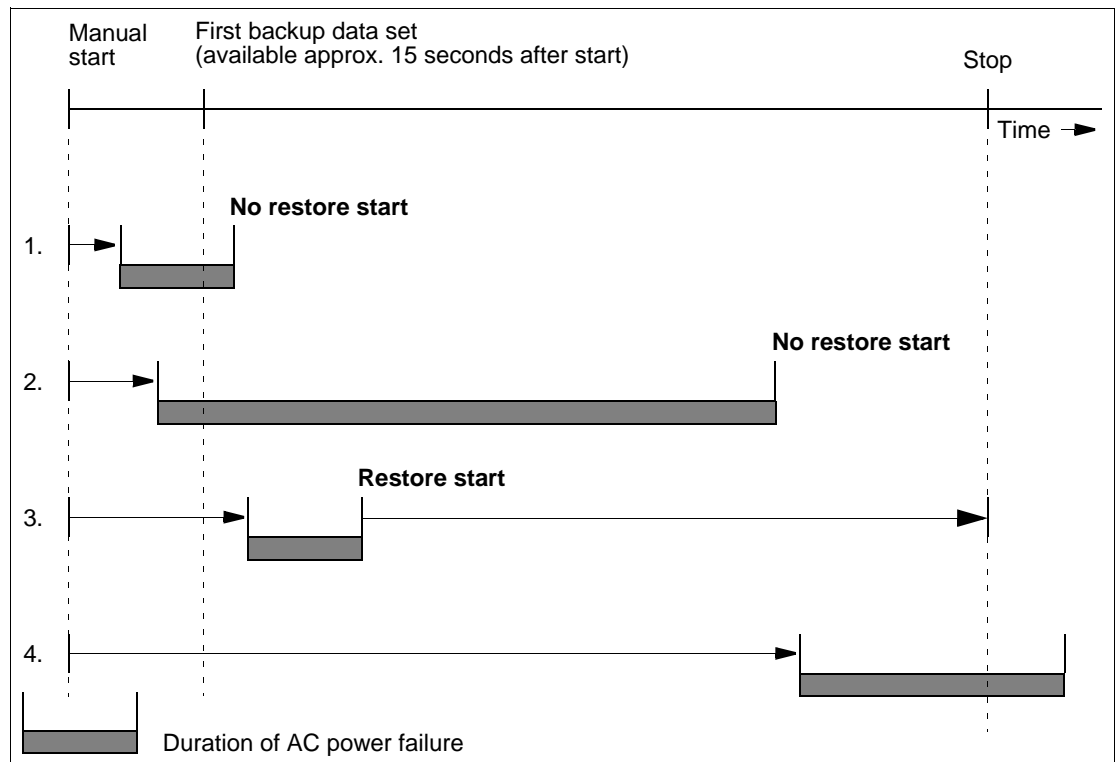

Fig. O-40 Examples of ANT-20SE behavior in the event of an AC power failure (manually triggered measurements)

1. AC power fails before the first set of backup data is generated:
On restoration of AC power, the measurement is **not resumed**.
A power failure within the first 15 seconds of a measurement means that no backup data has been generated. The measurement must be restarted manually.
A "No-Power" alarm will not be displayed.
2. AC power fails before the first set of backup data is generated. The power failure lasts much longer than in the previous case:
On restoration of AC power, the measurement is **not resumed**.
A power failure within the first 15 seconds of a measurement means that no backup data has been generated. A "restore start" is therefore not possible; the measurement must be restarted manually. The duration of the power failure in this case is almost until the normal end of the measurement. A "No-Power" alarm will not be displayed.



3. AC power fails after the first set of backup data has been generated:
On restoration of AC power, the last set of backup data is loaded. The data is restored and the measurement resumed.
The time from the generation of the last set of backup data until the “restore start” of the measurement is indicated as a “No-Power” alarm and is taken into account in the restored measurement values. The original stop time is retrieved from the last backup data and the measurement restarted so that it ends at the stop time originally programmed (“Restore Start”).
The “No-Power” alarm time is included in the “Elapsed Time”. At the end of the measurement, the “Elapsed Time” is equal to the “Gate Time”.
4. AC power fails after the first set of backup data has been generated:
AC power is restored after the normal end of the measurement time.
As backup data was generated before the power failure, this backup data will be loaded when power is restored. The data is restored and the end results generated (measurement has ended). The time from the start of the AC power failure until the programmed end of the measurement is indicated as a “No-Power” alarm. The “No-Power” alarm time up to the programmed end of the measurement is included in the “Elapsed Time”. Hence the “Elapsed Time” is equal to the “Gate Time”.

10.2.2 Timer-controlled measurements

If the measurement start time that you enter has already passed, the ANT-20SE will start measuring immediately when you press “F5” MEASUREMENT START. The measurement will run for the set gate time. This behavior is independent of the AC power failure behavior.

Timer-controlled measurements are handled as follows:

The ANT-20SE calculates the remaining time to the originally-programmed end of the measurement from the configuration parameters. The measurement resumes and runs for this calculated remaining time.

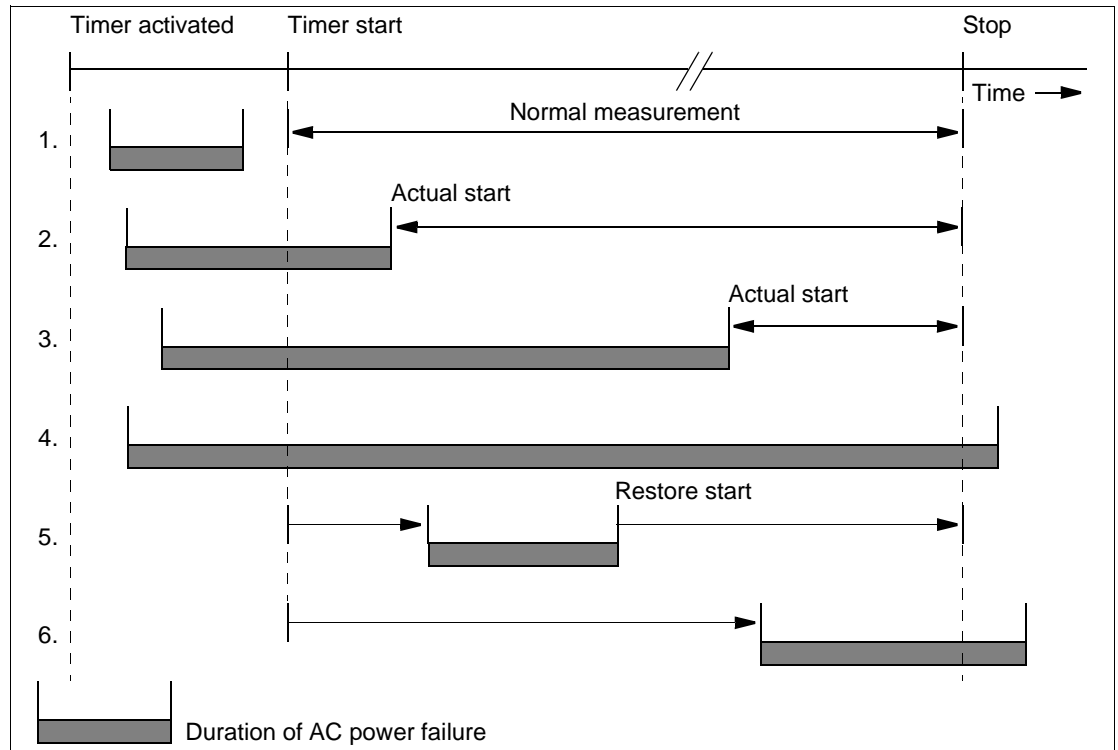

Fig. O-41 Examples of ANT-20SE behavior in the event of an AC power failure (timer-controlled measurements)

1. The AC power failure occurs between activation of the timer and the time when the timer triggers the start of the measurement:
The AC power failure has no effect.
As no backup data could be generated and the actual start of the measurement is still in the future, the measurement will be set normally with timer activated as soon as the AC power is restored. A "No-Power" alarm will not be recorded or displayed.
2. The AC power failure lasts beyond the time when the timer should trigger the measurement start:
The measurement starts asynchronously as soon as AC power is restored and runs for the remaining time to the programmed stop time. The stop time is given by the timer start time setting plus the gate time setting. A "No-Power" alarm will be detected and recorded. The duration of the "No-Power" alarm is the time difference between the timer start and the actual start. As the "No-Power" alarm is counted from the timer start time setting, the "Elapsed Time" = "Gate Time" at the end of the measurement.
3. As for case 2, but the AC power failure lasts much longer:
The duration of the power failure in this case is almost until the normal end of the measurement.
Although the "Elapsed Time" = "Gate Time" at the end of the measurement, the effective measurement time may be very short.



4. The AC power failure lasts for the entire programmed measurement time:
On restoration of AC power, the ANT-20SE establishes that no backup data was generated and that the stop time has already been reached. The measurement will therefore **not** be started.
The ANT-20SE stores the calculated stop time when the timer is activated and compares this with the actual date and time when power is restored. The start time, "No-Power" alarm duration and stop time may therefore be recorded.
5. AC power fails during a timer-controlled measurement. AC power is restored before the normal end of the measurement time:
As backup data was generated before the power failure, this backup data will be loaded when power is restored. The data is restored and the measurement resumed. The time from the generation of the last set of backup data until the "restore start" of the measurement is indicated as a "No-Power" alarm and is taken into account in the restored measurement values. The "No-Power" alarm time is included in the "Elapsed Time". At the end of the measurement, the "Elapsed Time" is equal to the "Gate Time".
6. AC power fails during a timer-controlled measurement. AC power is restored after the normal end of the measurement time:
As backup data was generated before the power failure, this backup data will be loaded when power is restored. The data is restored and the end results generated (measurement has ended). The time from the start of the AC power failure until the programmed end of the measurement is indicated as a "No-Power" alarm. The "No-Power" alarm time up to the programmed end of the measurement is included in the "Elapsed Time". Hence the "Elapsed Time" is equal to the "Gate Time".

Virtual Instruments



Contents

Virtual instruments

1	Overview	VI-1
1.1	Application Manager	VI-2
2	Signal Structure	VI-3
2.1	Main window: Signal Structure	VI-3
2.2	Dialog: Edit Signal Structure	VI-4
2.3	Dialog: Interface	VI-7
2.4	Dialog: Channel	VI-7
2.5	Dialog: Autoconfiguration	VI-8
2.6	Dialog: Delay Measurement	VI-9
2.7	Dialog: APS Time Measurement (Option 3035/90.15) . . .	VI-10
2.8	Scan functions	VI-11
3	Anomaly/Defect Insertion	VI-12
3.1	Main window: Anomaly/Defect Insertion	VI-12
3.2	Inserting defects	VI-13
3.3	Inserting anomalies	VI-13
4	Anomaly/Defect Analyzer	VI-14
4.1	Display mode: View - Graph	VI-14
4.2	Display mode: View - Table	VI-15
4.3	Display mode: View - Num	VI-17
4.3.1	Enlarged display	VI-18
4.4	Display mode: View - Summary	VI-19
4.5	Dialog: User Filter	VI-21
4.6	Dialog: Go to	VI-22
4.7	Settings menu	VI-22
5	Overhead Generator	VI-23
5.1	Main window: Overhead Generator	VI-23
5.2	Basic procedure	VI-24
5.3	Icon button: Default	VI-24



- 5.4 Dialog: DescriptorVI-25
- 5.5 Dialog: Background POHVI-25
- 5.6 Dialog: TCM Sequence.VI-26

- 6 Overhead AnalyzerVI-27**
 - 6.1 Main window: Overhead AnalyzerVI-27
 - 6.2 Menu: TypeVI-28
 - 6.3 Window: Interpreter.VI-28
 - 6.4 Dialog: Settings.VI-29
 - 6.5 Dialog: Byte Capture (Option BN 3035/90.15)VI-30

- 7 Pointer GeneratorVI-32**
 - 7.1 Main window: Pointer Generator.VI-32
 - 7.2 Generating pointer actionsVI-33

- 8 Pointer AnalyzerVI-35**
 - 8.1 Main window: Pointer Analyzer.VI-35
 - 8.2 Main window: Pointer Analyzer for Virtual Concatenation .VI-35
 - 8.3 Window: CursorVI-36
 - 8.4 Window: Cursor for Virtual ConcatenationVI-37
 - 8.5 Menu: PrintVI-37

- 9 PDH Generator/AnalyzerVI-38**
 - 9.1 Main window: PDH Generator/Analyzer (ITU-T and ANSI interfaces)VI-38
 - 9.2 TX parameters (ITU-T)VI-38
 - 9.3 RX parameters (ITU-T, ANSI).VI-39
 - 9.4 Dialog: IdleVI-39
 - 9.5 Main window: PDH Generator/Analyzer (ANSI interfaces) .VI-40

- 10 Performance AnalysisVI-41**
 - 10.1 Main window: Performance Analysis (general).VI-41
 - 10.2 Performance Analysis: ANSI/BELL.VI-42
 - 10.3 Performance Analysis: ITU-T G.821.VI-44
 - 10.4 Performance Analysis: ITU-T G.826.VI-45
 - 10.5 Performance Analysis: ITU-T G.828.VI-46
 - 10.6 Performance Analysis: ITU-T G.829.VI-48
 - 10.7 Performance Analysis: ITU-T M.2100.VI-50
 - 10.8 Performance Analysis: ITU-T M.2101.VI-52



Virtual instruments

1 Overview

To allow the instrument to be operated simply and logically despite the large number of functions, a user interface was developed for the ANT-20SE family of instruments that makes use of virtual instruments, VIs. These VIs are designed so that each VI is assigned to a clearly defined task. By selecting specific VIs, customized applications (or tools) can be generated which are tailor-made for each particular measurement task.

The following is an overview of all VIs that are available.

Mainframe virtual instruments











Virtual instrument		Function	More information
Icon	Name		
	Application Manager	Control and management of measurement applications	Sec. 1.1, Page VI-2
	Signal Structure	Configures the physical layer.	Sec. 2, Page VI-3
	Anomaly/Defect Insertion	Generates anomalies and defects for the physical layer including the "Transmission Convergence Sublayer".	Sec. 3, Page VI-12
	Anomaly/Defect Analyzer	Analyzes anomalies and defects for the physical layer including the "Transmission Convergence Sublayer".	Sec. 4, Page VI-14
	Overhead Generator	Edit physical frame overhead information. Used with SDH, SONET and PDH/ATM frames to G.832 (34 Mbit/s and 140 Mbit/s).	Sec. 5, Page VI-23
	Overhead Analyzer	Analyzes physical frame overhead information. Used with SDH, SONET and PDH/ATM frames to G.832 (34 Mbit/s and 140 Mbit/s).	Sec. 6, Page VI-27
	Pointer Generator	Generates SDH/SONET pointers.	Sec. 7, Page VI-32
	Pointer Analyzer	Analyzes SDH/SONET pointers.	Sec. 8, Page VI-35
	PDH Generator/ Analyzer	Set and display physical frame overhead. Used with PDH frames.	Sec. 9, Page VI-38
	Performance Analysis	Performance analysis to G.821, G.826, M.2100, M.2101 and Bellcore/ANSI.	Sec. 10, Page VI-41

Table VI-1 Overview of ANT-20SE virtual instruments



1.1 Application Manager

The “ANT20 - <Application Title>” VI, also known as the Application Manager is the central control panel for the ANT-20SE.

This VI has overall control of

- Measurement applications
- Measurement results generated using the applications
- Measurement sequence.

Detailed information is found in part 3 “Operating Fundamentals”.



2 Signal Structure

2.1 Main window: Signal Structure

“Signal Structure” VI is used to match your ANT-20SE to the measurement interface of the device under test and to generate appropriate signal structures for the generator and receiver. The VI has the following functions:

- Entering the signal structure
- Selecting the Tx/Rx interfaces
- Automatic functions: Auto Config, Search, Trouble Scan, Delay, APS-measurement.

After the VI has booted up, the main window, “Signal Structure”, is displayed.

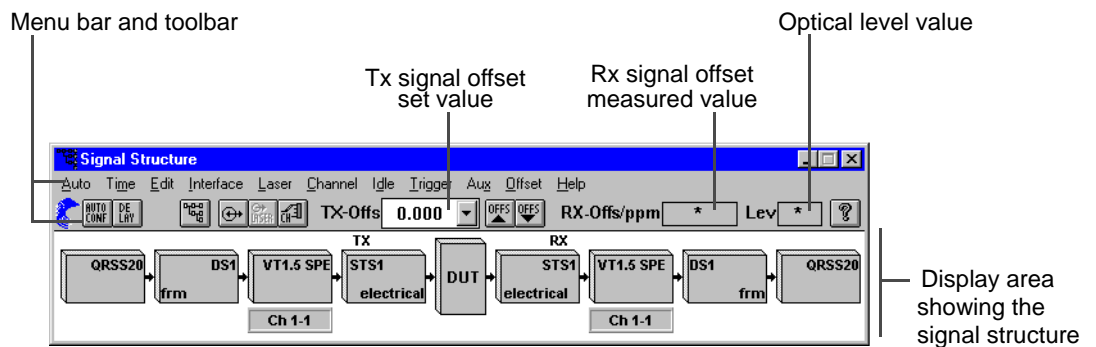

Fig. VI-1 Elements in the “Signal Structure” main window

Menu	Icon button	Function	More information
Auto		Automatic functions, e.g. receiver configuration	Sec. 2.5, Page VI-8
Time		Delay / APS measurements	Sec. 2.6, Page VI-9/ Sec. 2.7, Page VI-10
Edit		Edit signal structur	Sec. 2.2, Page VI-4
Interface		Enter interface parameters	Sec. 2.3, Page VI-7
Laser		Switch laser on / off	-
Channel		Select tributary channels	Sec. 2.4, Page VI-7
Idle		Set fill pattern for idle channals	-
Trigger		Set trigger signals	-
Aux		Select interface for Drop&Insert function	Sec. 2.3, Page VI-7
Offset		Set Tx signal (clock frequency) offset	-
Help		On-line help	-



2.2 Dialog: Edit Signal Structure



This dialog is used to set the structures of the asynchronous (DSn, En), SONET and SDH signals using corresponding buttons arranged in columns. Additional instrument modes are also provided.



Fig. VI-2 Displaying and setting the signal structure using ANSI (Tx side) as an example

The dialog includes the following buttons:

- Edit**
 - “TX”/“RX” Select Tx or Rx signal structure to be edited.
 - “ANSI” Select signal structure to ANSI (SONET).
 - “ITU-T” Select signal structure to ITU-T (SDH).
 - “TX => RX” Copy Tx signal structure settings to Rx.
 - “RX => TX” Copy Rx signal structure settings to Tx.
 - “Clear” Clear Tx or Rx signal structure settings.
- Mode**
 - “Normal” Normal mode: Tx and Rx signal structures are independent. Example:

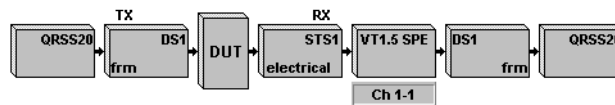

- “Through” Through mode: The Rx signal is looped through to the generator and transmitted. Tx and Rx clocks are identical. Example:

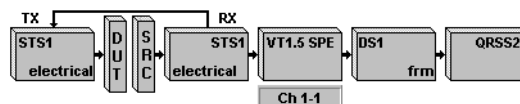

Basic procedure:

1. Set Rx signal structure.
2. Click the “Tx” button.
3. Click the “Through” button.



“Replace” Block&Replace: (only possible with STS3c SPE and STS1 SPE mapping) Generator and receiver are coupled. The received signal is looped through from the receiver to the generator. The ANT-20SE is used on the receive side as a measurement channel monitor. The AU of the measurement channel is re-formed on the transmit side.

Example:

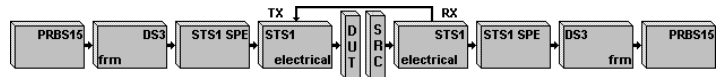

Basic procedure:

1. Set Rx signal structure.
2. Click the “TX” button.
3. Click the “Replace” button.

“ADM Test” Add/drop multiplexer test: ADMs require a valid optical signal, even for measurements on tributaries. The instrument provides an optical signal in addition to the electrical signal.

Example:

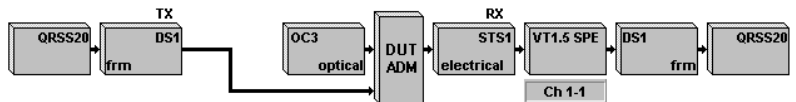

Basic procedure:

1. Set Rx signal structure.
2. Click the “Tx” button.
3. Click the “ADM Test” button.
4. Select the optical signal in the “SONET” column.
When the signal is ready, the “PDH” column is enabled.
5. Set the Tx signal structure in the “PDH” column.

Interface	“Electric.”	Electrical interfaces	Tx: [13] or [15]	Rx: [12] or [14]
	“Optical”	Optical interfaces for OC-48/STM-16	Tx: [18] Tx: [47]	Rx: [17] Rx: [44]

Mapping **“CONCAT.”** Operating mode selection: Contiguous Concatenation or Virtual Concatenation
Selection between Contiguous and Virtual modes is made under “Settings”/“Concat. Mode”.

“Bulk” Fills the entire synchronous signal container with a pseudo random test pattern.

“ATM” Generates an ATM cell stream in the selected mapping (ATM mapping in SONET and SDH signals). For further signal definitions, see “ATM Signal Structure” VI.



PDH Mode “External” Tx: An externally-applied DS_n or E_n signal is multiplexed into the selected signal from socket “Aux” [10].
Rx: A tributary is demultiplexed from the receive signal and output to socket “Aux” [11].

“ATM” Generates an ATM cell stream in the selected PDH signal (ATM mapping in PDH signals). For further signal definitions, see “ATM Signal Structure” VI.

“Info” button

Press this button to display SONET or SDH signal structures conforming to the corresponding standard, “ANSI” or “ITU-T”, that you have selected previously.



2.3 Dialog: Interface



The “Interface” dialog is used to configure the parameters for the Tx and Rx interfaces.

Tip: The interfaces for “Drop & Insert” mode are configured in the “Aux” menu.

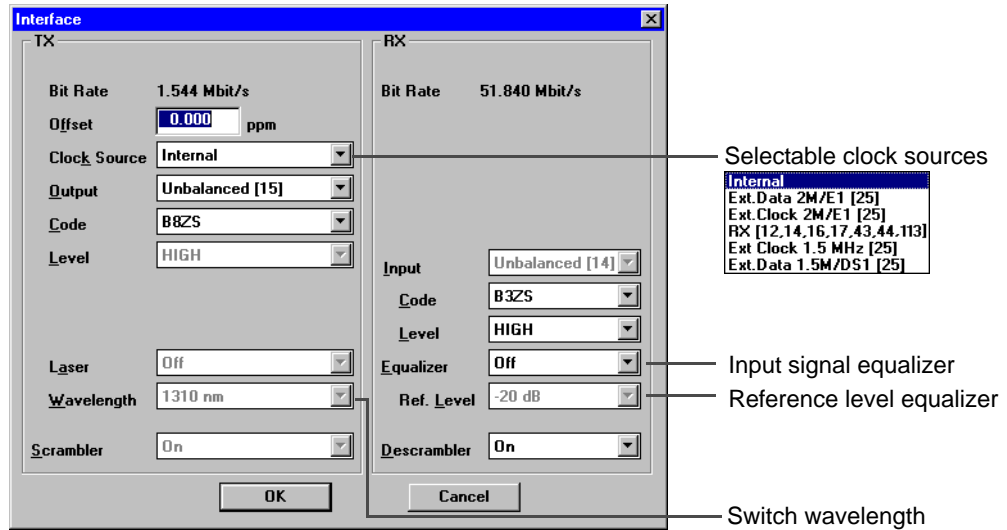

Fig. VI-3 “Interface” dialog with “Clock Source” list box

2.4 Dialog: Channel



The “Channel” dialog is used to set the measurement channel in all hierarchy levels of the tributary structure for the generator and receiver.

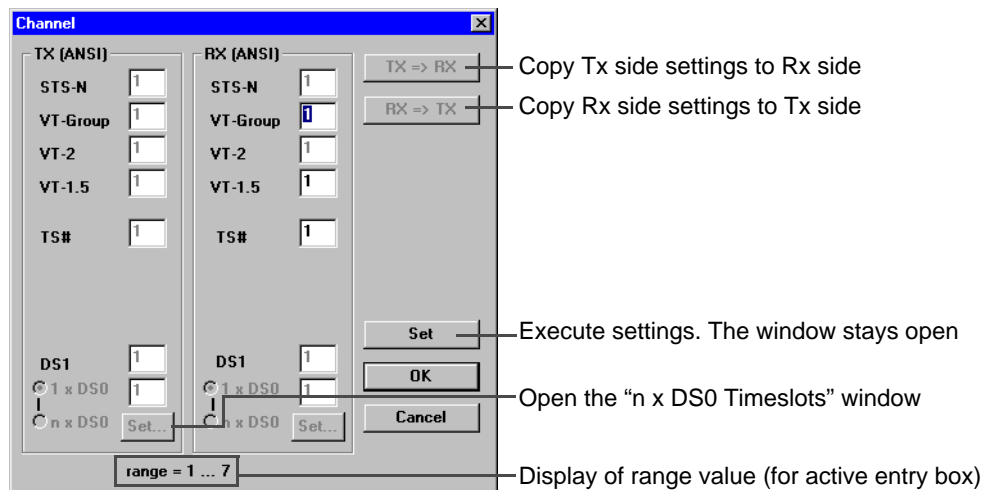

Fig. VI-4 “Channel” dialog



2.5 Dialog: Autoconfiguration



The “Autoconfiguration” dialog automatically sets the receiver of the ANT-20SE. A search is made at the electrical inputs (input voltage ranges “ITU-T”/“High” or “PMP”/“Low”) or at the optical inputs for standard SONET, SDH, PDH or ATM signals. The instrument version and options fitted determine the scope of the search. The main objective is to determine the signal structure. Detailed matching to the signal contents can be made manually if required.

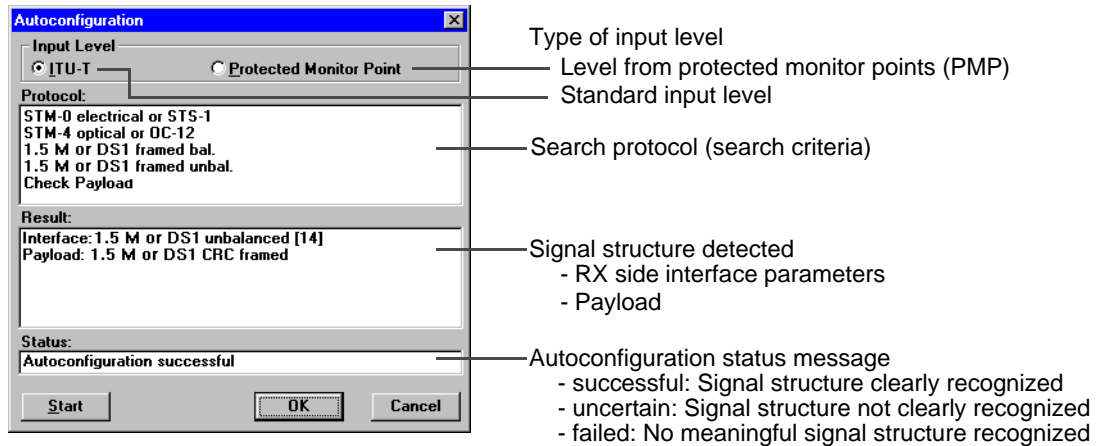

Fig. VI-5 “Autoconfiguration” dialog

Basic procedure

1. Select the type of input level (ITU-T or PMP).
2. Click the “Start” button to start the search.
The Rx signal is checked for its system bit rate, line code, pattern and signal level. If the search is successful, the “Result” will display the signal structure that was detected.
3. To configure the receiver to the detected signal structure, click the “OK” button.

Only one channel is considered in the signal structure hierarchy in each case.

Status message “Autoconfiguration uncertain”

1. Click the “Start” button.
The search is triggered again.
2. If the search is successful, click the “OK” button.
– or –
If the search result is again uncertain, click the “Cancel” button.
The previous signal structure settings will be reinstated, which was selected before beginning Autoconfiguration.

Search criteria

The signal structure is determined according to the following search criteria:

Check Interface

Matching to the physical parameters (bit rate / line code)

Defects taken into account: LOS

Further criterion Input bit rate frequency offset < 150 ppm



Check Mapping

Searches for the mapping structure using the signal label and pointer bytes (distinction between AU-4 / AU-3). The search is always made in channel #1. If the signal is STM-16 / OC-48, the search is made for an AU-4 structure only in "ITU-T" mode or for an AU-3 structure only in "ANSI" mode.

SDH defect	SONET defect
LOF/OOF	LOF/OOF
AU-AIS	AIS-P
MS-AIS	AIS-L
TU-AIS	AIS-V
AU-LOP	LOP-P
TU-LOP	LOP-V
LOM	LOM

Table VI-2 Defects taken into account in autoconfiguration

If an UNEQuipped signal is detected, the previously selected mapping setting will be reinstated or a default mapping will be set. Autoconfiguration recognizes "C-11 via TU-12" mapping as "C-12" mapping.

Check Payload

The search only takes account of the test patterns recommended in the standards.

PDH signals: Search for unframed or framed payload signals on all hierarchy levels

Defects taken into account: LOF/(OOF), AIS

ATM signals: Search for ATM signals

Defects taken into account: LOF/(OOF), AIS, LCD, LOF PLCP, AIC, IDLE DS3

If no pattern synchronization is reached (Defect LSS), the test pattern evaluation will be switched off (Pattern = Real Traffic).

2.6 Dialog: Delay Measurement



The "Delay Measurement" is used to measure the signal delay times between the Tx and Rx sides using characteristic patterns included in the pseudo-random sequences. The delay measurement is an automatic measurement made by repeating single measurements continuously. It can be made using practically all the available ANT-20SE signal structures.

Exceptions:

- ATM signal structures
- Measurements in the overhead
- Through mode
- ADM test
- Contiguous concatenation
- Virtual concatenation



The measurement range and measurement time depend on the pattern bit rate and the pattern selected. The maximum possible measured value is determined by the length of the pseudo-random sequence. This maximum is calculated and displayed; it can be influenced by selecting a shorter or a longer test pattern.

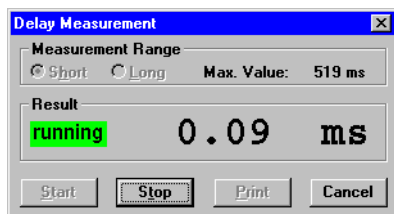

Fig. VI-6 "Delay Measurement" dialog

2.7 Dialog: APS Time Measurement (Option 3035/90.15)



The "APS Time Measurement" dialog is used for measuring the switching times of automatic protection switching (APS) to demonstrate that the permitted maximum drop-out times for a connection are not exceeded. The dialog is only available if the "Extended Overhead Analysis" option is fitted.

Using a selected criterion such as AIS or bit error burst, the drop-out times of tributary connections are measured and compared with a pre-set check value. The selectable criteria are:

- AIS-L, AIS-P, AIS-V, TSE (ANSI)
- MS-AIS, AU-AIS, TU-AIS and TSE (ITU-T)

The result is a simple "Passed" or "Failed" message.

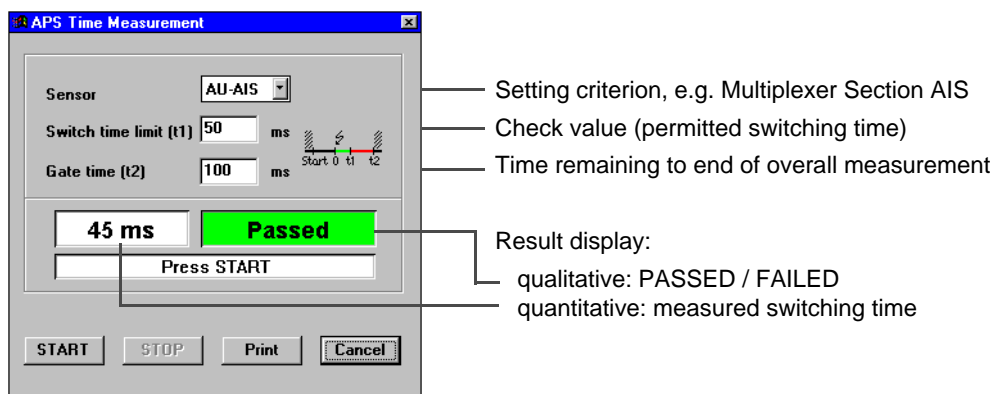

Fig. VI-7 "APS Time Measurement" dialog

Sensor: Selecting the setting criterion

"Sensor" specifies which event is to be evaluated and measured as the switching event:

- e.g. MS-AIS measures the duration of a Multiplexer Section Alarm
- e.g. TSE measures the time for which the test pattern (PRBS) dropped out.



Tip: If the sensor criterion is already present in the signal at the start of the measurement, the time cannot be measured. To correctly detect test pattern drop-out (sensor = TSE) the basic bit error rate of the path must not exceed $2E-4$.

Switch time limit (t1): Setting the check value

The measured switching time is compared with the 'Switch Time Limit' value at the end of the measurement time. If the measured value is less than or equal to this value, the result is a PASSED message, otherwise a FAILED message is displayed.

Gate time (t2): Setting the measurement time

The measurement begins as soon as the sensor event first occurs. It ends after the set measurement time has elapsed. This ensures that multiple switching is also detected.

Result and status display

After the measurement the following are displayed:

- The switching time required
- A status message

Display	Meaning
PASSED	Measured value \leq Switch Time Limit
FAILED (Time)	Measured value $>$ Switch Time Limit
FAILED (Signal)	An impermissible defect occurred during the measurement that blocked the sensor (e.g. LOS or LOF if sensor = AIS-L)

Table VI-3 Display of test result after measurement

2.8 Scan functions

Further information on the automatic scan functions such as "Trouble Scan" and "Search" are found in part 5: "Application Guide" of this operating manual.



3 Anomaly/Defect Insertion

3.1 Main window: Anomaly/Defect Insertion

The “Anomaly/Defect Insertion” VI is used to insert anomalies (errors) and defects (alarms) into signals of synchronous (SDH/SONET), asynchronous (PDH) and ATM communications systems.

After the VI has booted up, the “Anomaly/Defect Insertion” window appears.

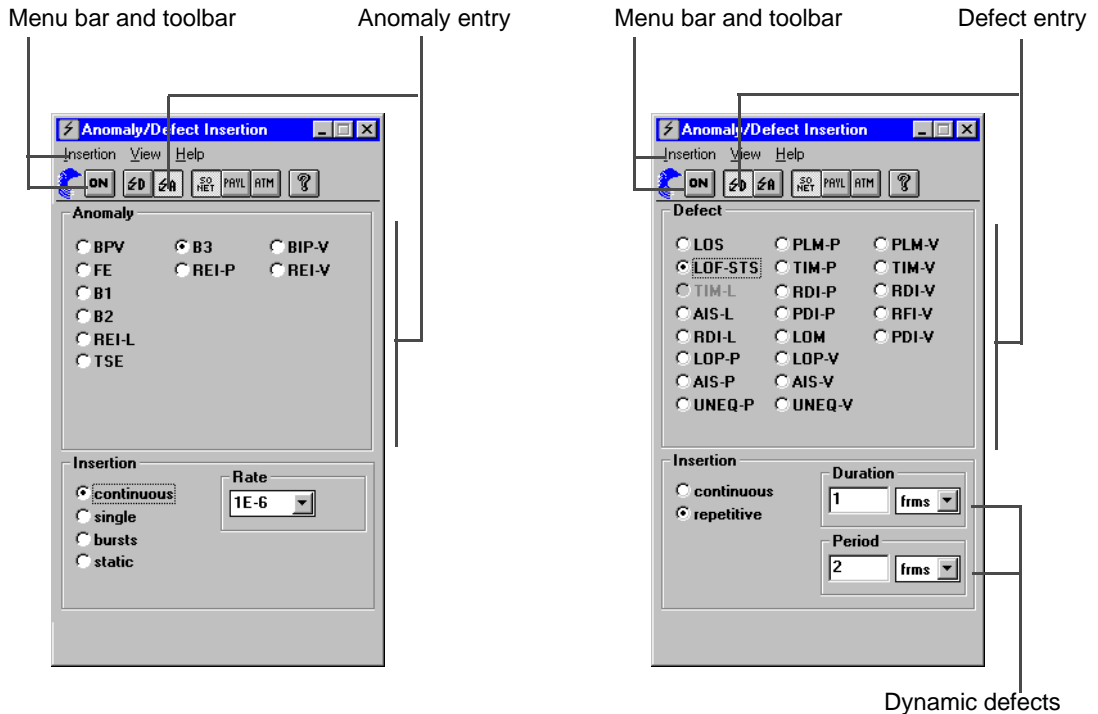

Fig. VI-8 Elements of the “Anomaly/Defect Insertion” window

Menu - Command	Icon button	Function
Insertion - ON		Inserts anomalies or defects (A/D)
View - Defects		Display and entry of defects
View - Anomalies		Display and entry of anomalies
View - SONET		Anomalies or defects for SONET technology
View - PAYLOAD		Anomalies or defects for asynchronous technology (DSn, En)
View - ATM		Anomalies or defects for ATM technology
View - RDI		Select Remote Defect Indication options
View - Pointer Options		Select AISx/LOPx for Concatenation
Help		On-line help



3.2 Inserting defects

Basic procedure for inserting defects continuously and repetitively.

Continuous insertion of defects

- ✓ The “D” (Defect) button has already been clicked.
- ✓ The “continuous” option has been selected.
- 1. Select the technology type (SONET or PAYL or ATM).
- 2. Select the defect required using the “Defect” entry box.
The corresponding check box will be marked.
- 3. Click the “ON” button.
The defect will be inserted continuously.

Repetitive insertion of defects

The same procedure is used as for continuous insertion, with the following additional step between steps 2 and 3:

- ⇒ Select the “repetitive” option.
The “Duration” and “Period” list boxes can now be accessed.
- ⇒ Enter the duration of defect insertion (in frames or seconds) in the “Duration” box
- ⇒ Enter the repetition period (in frames or seconds) in the “Period” box.
- ⇒ Continue with step 3 above.

Defects can be inserted or removed and the type of defect changed even while a measurement is running.

3.3 Inserting anomalies

Basic procedure for inserting anomalies continuously and singly.

Continuous insertion of anomalies

- ✓ The “continuous” option has been selected.
- 1. Click the “A” (Anomaly) button.
The anomaly insertion entry box is activated.
- 2. Select the technology type (SONET or PAYL or ATM)
- 3. Select the anomaly required in the “Anomaly” entry box.
The corresponding check box will be marked.
- 4. Enter the anomaly rate in the “Rate” list box
- 5. Click the “ON” button.
The anomaly will be inserted continuously.

Inserting single anomalies

As for continuous insertion above but with step 4 as follows:

- ⇒ Select the “single” option in the “Insertion” field.
- ⇒ Continue with step 5.
The anomaly is inserted each time the (ON) button is clicked.

When inserting anomalies in bursty ATM traffic, HUNC and HCOR anomalies can also be inserted repetitively. The repetition period and the burst duration (in cells) can be entered for this.



4 Anomaly/Defect Analyzer

The "Anomaly/Defect Analyzer" VI is used to display the results obtained using the "Anomaly/Defect Insertion" VI in four different ways.

4.1 Display mode: View - Graph



After the VI has booted up, the results window for displaying the anomalies and defects as a histogram (View - Graph) appears. The alternative display modes are described in subsequent sections.

Menu bar and toolbar

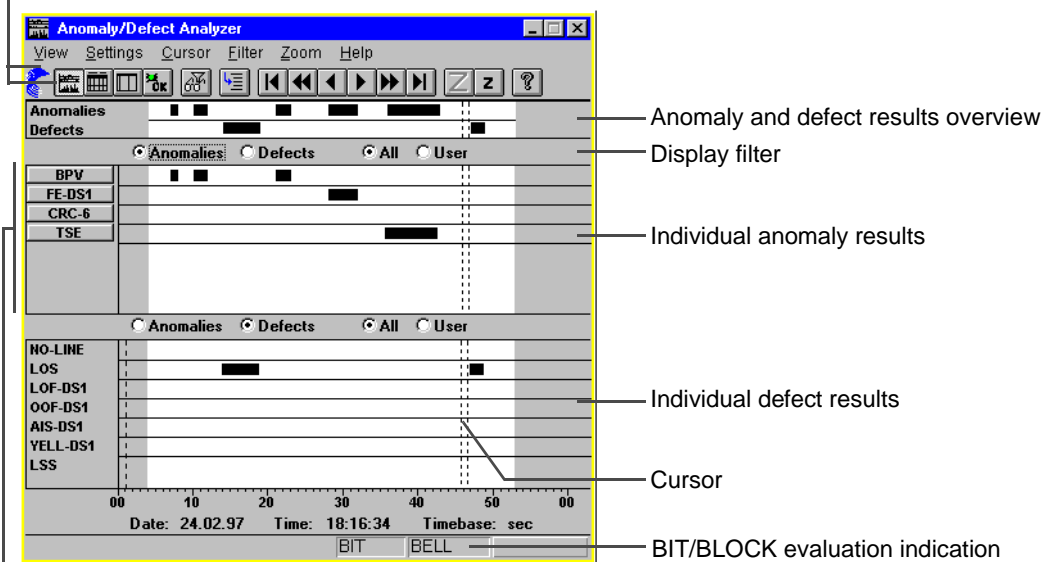





Event buttons

Fig. VI-9 Elements of the main window showing results as a histogram (default setting)

Menu - command	Icon button	Function
View - Graph/Table/Num/Summary		Switch display modes
Settings		Select various detection and measurement modes
Cursor - Go to		Moves cursor position to date and time entered
Cursor - First/Last		Sets cursor to start / end of the measuring interval
Cursor - Prev/Next		Moves cursor page by page to the left / right



Menu - command	Icon button	Function
Cursor	 	Moves cursor in intervals (single step) to the left / right
Filter		Display selected results only (user filter)
Zoom - In/Out	 	Increase / decrease resolution of time axis

The option buttons of the display filter (see Fig. VI-9) are used to select the results registered within the measurement interval and enable their access in the appropriate results windows. The results for anomalies and defects can be shown separately or in a combined display. Other selection criteria are provided in the “User Filter” dialog.

The scrollbar lets you display all the registered results within the display window. Clicking on an event button causes the rate per time for that event to be displayed.

4.2 Display mode: View - Table





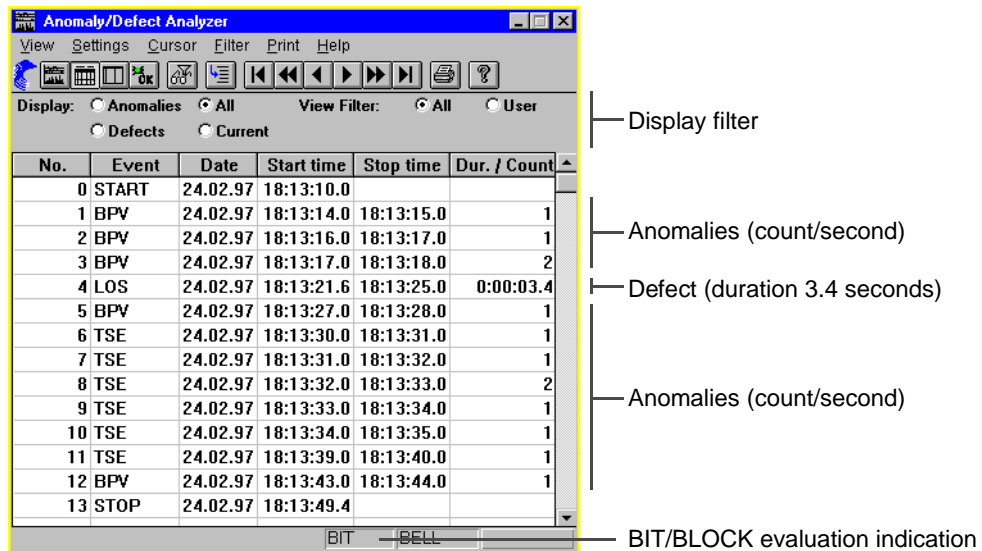



In “View - Table” display mode, a table is displayed of anomalies as count values and defects as duration values.



No.	Event	Date	Start time	Stop time	Dur. / Count
0	START	24.02.97	18:13:10.0		
1	BPV	24.02.97	18:13:14.0	18:13:15.0	1
2	BPV	24.02.97	18:13:16.0	18:13:17.0	1
3	BPV	24.02.97	18:13:17.0	18:13:18.0	2
4	LOS	24.02.97	18:13:21.6	18:13:25.0	0:00:03.4
5	BPV	24.02.97	18:13:27.0	18:13:28.0	1
6	TSE	24.02.97	18:13:30.0	18:13:31.0	1
7	TSE	24.02.97	18:13:31.0	18:13:32.0	1
8	TSE	24.02.97	18:13:32.0	18:13:33.0	2
9	TSE	24.02.97	18:13:33.0	18:13:34.0	1
10	TSE	24.02.97	18:13:34.0	18:13:35.0	1
11	TSE	24.02.97	18:13:39.0	18:13:40.0	1
12	BPV	24.02.97	18:13:43.0	18:13:44.0	1
13	STOP	24.02.97	18:13:49.4		

Fig. VI-10 Elements of the “View - Table” window

Menu - command	Icon button	Function
View - Graph/Table/Num/Summary	   	Switch display modes
Settings		Select various detection and measurement modes
Cursor - Go to		Moves cursor position in table to date and time entered



Menu - command	Icon button	Function
Cursor - First/Last		Moves cursor position to start / end of table
Cursor - Prev/Next		Moves cursor position up / down half a page
Cursor		Moves cursor position up / down by one line
Filter		Display selected results only (user filter)
Print		Print and export results

Display filter

If a large number of events that cannot all be displayed at once occur during the measurement interval (long-term measurement), the scrollbar can be used to move the results that are not visible into the display window.

The option buttons (display filter) are used to select the results list. The results for anomalies and defects can be shown separately or in a combined list in order of occurrence. The "Current" option displays all current defects. "Current" can only be selected during a running measurement.

Other selection criteria are provided in the "User Filter" dialog.

Print/Export

The "Print" menu is used to print out the measurement results or to export them for further processing using other programs.

Print ...	Print out results.
Print Headers	Definition of additional information to the measurement results, e. g. description of DUT, comments, etc.
Printer Setup ...	Select printer, paper format, etc.
Export ...	Save the current results in a file for export (on floppy or hard disk).
Export Setup ...	Set the list and decimal separators and the time format for the export file; Default settings: Semicolon, period (dot) and hh:mm:ss, respectively.



4.3 Display mode: View - Num



In "View - Num" display mode, all anomalies are listed in a table of "Total Results" (Count and Ratio) and "Intermediate Results" (Count and Ratio).

"Total Results" is the number of events that occurred during the entire measurement interval. "Intermediate Results" is the number of events occurring within a defined time period ("Interm. Time"). Both these time periods are set in the "Application manager" ("Measurement Settings ...").

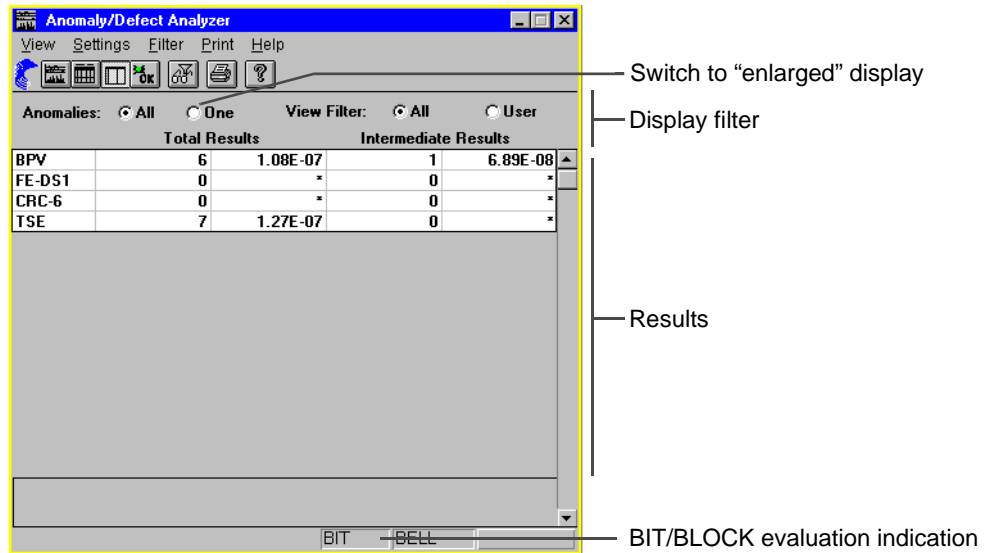

Fig. VI-11 Elements of the "View - Num" window

Menu - command	Icon button	Function
View - Graph/Table/Num/Summary		Switch display modes
Settings		Select various detection and measurement modes
Filter		Display selected results only (user filter)
Print		Print and export results
Help		On-line help



4.3.1 Enlarged display

The “Anomalies: One” option button provides an enlarged display of a single result.

The single result to be displayed (Total or Intermediate Result) is selected from the list box. The “Anomalies: All” option button switches the display back to “View - Num” mode. All other icons and menus in the enlarged display correspond to the “View - Num” display.

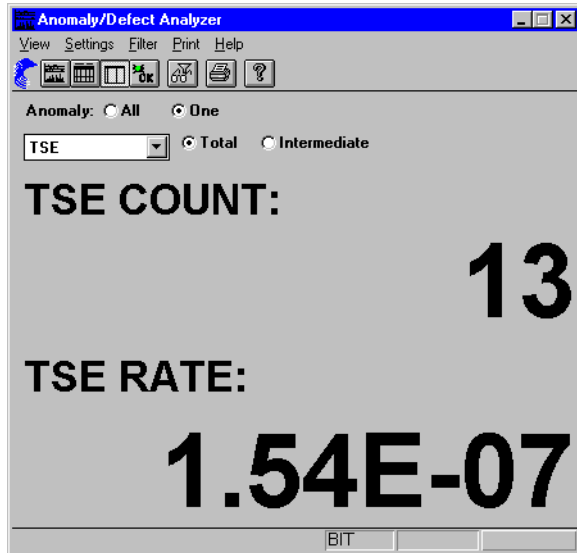

Fig. VI-12 Single result in enlarged display



4.4 Display mode: View - Summary



In “View - Summary” display mode, anomalies and defects are shown as a summary during the course of the measurement.

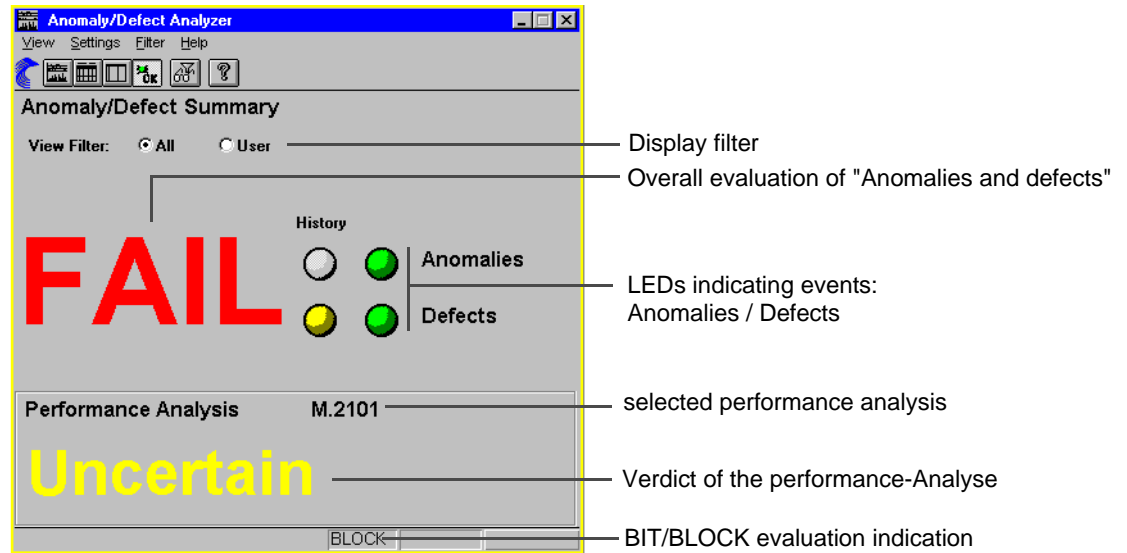

Fig. VI-13 Elements of the “View - Summary” window

Menu - command	Icon button	Function
View - Graph/Table/Num/Summary		Switch display modes
Settings		Select various detection and measurement modes
Filter		Display selected results only (user filter)
Help		On-line help

Overall evaluation of “Anomalies and defects”

The result of the overall evaluation is either “OK” or “FAIL”.

Note: The result of the overall evaluation is independent of the result of performance analysis.

LEDs indicating events: Anomalies / Defects

Left-hand LED column (History)

The display changes from gray to yellow when an event occurs during the measurement. The display remains yellow when the event ends.



Right-hand LED column

Indicate current status when measurement is running:

The display changes from green to red for the duration of the event. The display reverts to green when the event ends.

The LEDs are grayed out when no measurement is running.

Verdict of the performance analysis

Display of the verdict of the performance analysis. The following results are possible:

Result	Condition, explanation
Accepted	Depending on the setting selected in the "Hierarchy" menu, only "NEAR END" results (e.g. TSE) or "NEAR END" and "FAR END" results will be taken into account.
Uncertain	Only possible for M.2100 and M.2101. Depending on the setting selected in the "Hierarchy" menu, only "NEAR END" results (e.g. TSE) or "NEAR END" and "FAR END" results will be taken into account.
Rejected	Depending on the setting selected in the "Hierarchy" menu, only "NEAR END" results (e.g. TSE) or "NEAR END" and "FAR END" results will be taken into account.
No Verdict	No verdict is provided for G.829 and ANSI evaluations.
No display	Performance analysis "Off".

Tabelle VI-4 Results of the Verdict of the performance analysis

G.821 evaluation provides "NEAR END" results only.



4.5 Dialog: User Filter



The “User Filter” dialog is used to select specific results to be displayed in the result windows of the VI. To do this, the “User” option must be selected in the corresponding result window.

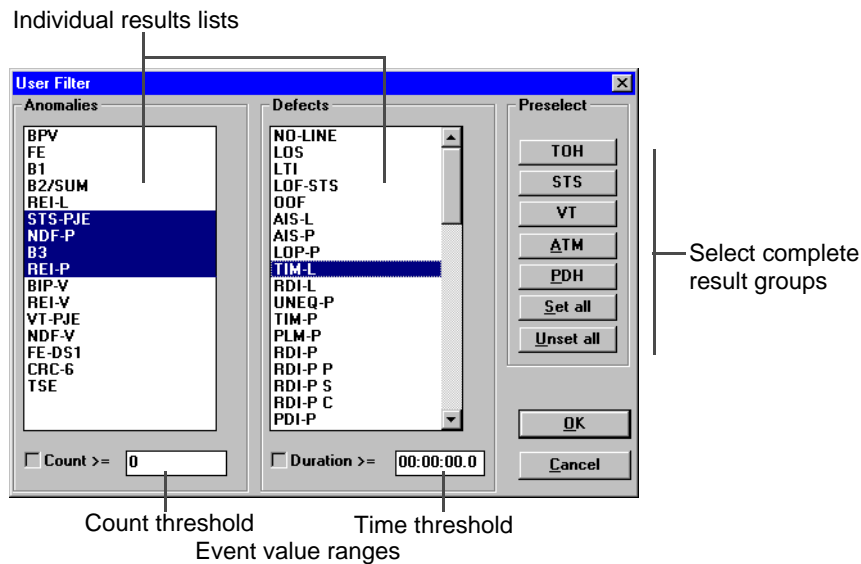

Fig. VI-14 Elements of the “User Filter” dialog

Individual results can be evaluated and displayed by clicking on the event required in the “Anomalies” or “Defects” list boxes. One or more events can be marked in each list box. You can also select complete groups of anomalies and defects using the buttons in the “Preselect” field.

The selected anomalies and defects are used for all four display modes of the VI.

The result display takes all registered result values for the events into account. If only a certain range of values is of interest, count thresholds can be set for anomalies and time thresholds for defects. When these thresholds are activated, only those values above the threshold value will be displayed.

The “User Filter” can only be activated when there is no measurement running.



4.6 Dialog: Go to



The "Go to" dialog provides support in analyzing long-term measurements where a large number of results are displayed. The date and exact time for the display are entered in the "Go to" dialog. When you exit from the dialog (by clicking the "OK" button),

- the cursor jumps to the corresponding position in the histogram (View - Graph)
 - or –
- the corresponding event is displayed in the first line of the table (View - Table).

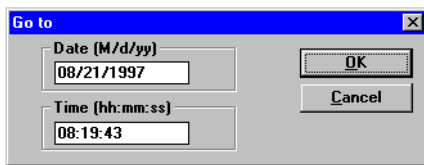

Fig. VI-15 "Go to" dialog for entering the time for the analysis

4.7 Settings menu

The "Settings" menu is used to set various detection parameters and to select measurement modes.

The menu contains the following commands:

- Bit** Record bit errors.
- Block/Word** Record block errors / word errors.
- T1X1** Detection of anomalies and defects to T1X1 (ANSI).
- BELL** Detection of anomalies and defects to GR-253 (Bellcore).
- RDI enhanced** "On / Off" switch for "RDI enhanced". If detection of anomalies and defects to GR-253 (Bellcore) is active, the switch activates "RDI enhanced" evaluation. This selection is not required for T1X1 (ANSI) evaluation as detection is automatic.
- Select measurements ...** The "Select measurement" dialog window opens. Various measurements can be selected for DS3 and DS3 PLCP mappings.
- Beep on Anomalies/Defects¹** On / off toggle for "Beep on Anomalies/Defects". If the toggle is on, any anomalies and / or defects occurring during a measurement will be signaled by a beep.

¹ in preparation



5 Overhead Generator

5.1 Main window: Overhead Generator

The “Overhead Generator” VI is used to edit the bytes in the TOH (SONET) / SOH (SDH) and POH of the selected channel. The dynamic bytes (B1, B2, B3) and the pointer line cannot be edited.

Menu bar and toolbar

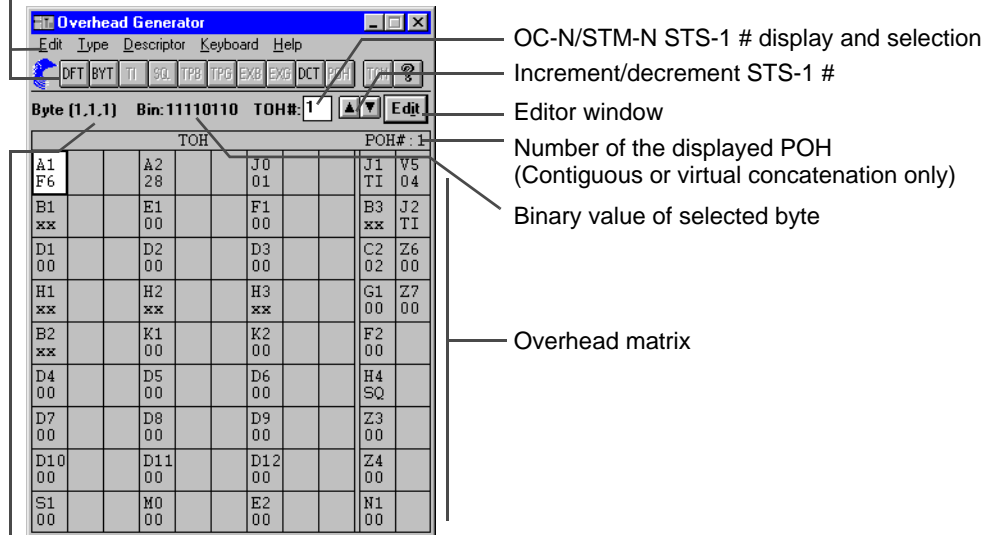

Location of selected byte in TOH (row/column/STS-1 #)

Fig. VI-16 Elements of the “Overhead Generator” main window



Menu	Icon button	Function
Edit		Default: Set overhead bytes to default values
Type		Byte: Enter static value
		Trace Identifier: Enter J0, J1, J2 bytes (ASCII string)
		Sequence: Select standard H4 sequence (4, 48, off)
		Test Pattern: Fill byte with test pattern
		Test Pattern Group: Fill byte group with test pattern
		External Byte: Insert externally-generated signal from socket [21] in selected byte
		External Byte Group: Insert externally-generated signal from socket [21] in selected byte group
	Descriptor	
Edit		Selection of the background POH
Type		Opens the "TCM Sequence" dialog for editing the TCM sequence

5.2 Basic procedure

1. Click on the TOH/SOH byte in the main window, which has to be edited.
2. Select desired function in the toolbar.
3. Press "Edit" button.
Depending on the byte type selected, one of the following windows will open:
 - "Edit Overhead Byte"
 - "Trace Identifier Editor" (when J0, J1, J2 or TR selected)
 - "H4 sequence editor" (for VT1.5/VT2/VT6 mapping or C-11/C-12/C2 mapping)

The selected byte is edited in this window. The button has no function for E1, E2, F1, F2 and D1 to D12 and K1 to K2 if the selected byte is set to TP (test pattern) or EX (external).

Note: If you want to edit the TCM sequence, first click on the N1 or Z6 byte in the main window and then click on the "TCM" icon button.

5.3 Icon button: Default



Clicking this icon button sets all elements of the TOH/SOH and POH matrix to their default values.



5.4 Dialog: Descriptor



The “Descriptor” dialog is used to fill certain bytes in the overhead matrix with plain text information:

- K1 to K4: APS commands
- S1: Clock source
- C2/V5: Path label

The information is identical to the commands in the corresponding standard. You can also select whether the commands for Ring APS (G. 841) or Linear APS (G. 783) are to be applied.

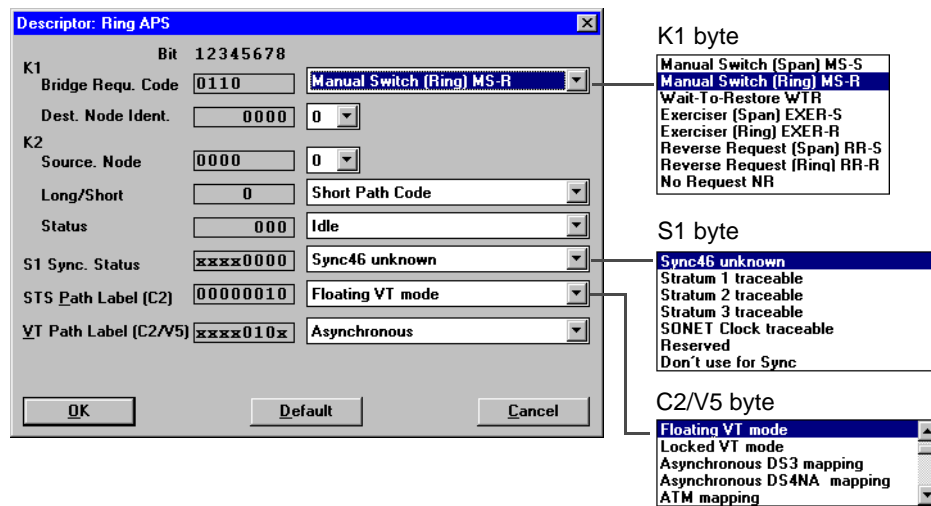

Fig. VI-17 “Descriptor” dialog with SOH/POH bytes for plain text input

5.5 Dialog: Background POH



This button opens the “Background POH” dialog. The button is only active if option BN 3035/90.92 is fitted and “Virtual Concatenation” signal structure is selected.



Fig. VI-18 “Background POH” dialog

- Same as Channel #1 POH #2 through #4 are filled with the same content as POH #1.
- Fixed Bytes POH #2 through #4 are filled with a fixed value.



5.6 Dialog: TCM Sequence



The "TCM" button is only active if one of the bytes N1 or Z6 is marked in the overhead matrix (POH).

The "TCM Sequence" dialog and the "Keyboard" dialog open when you click on the "TCM" button. "TCM" stands for "Tandem Connection Monitoring". You can edit the 76-byte TCM sequence for the TCM bytes N1 and Z6 using the "Keyboard" dialog.

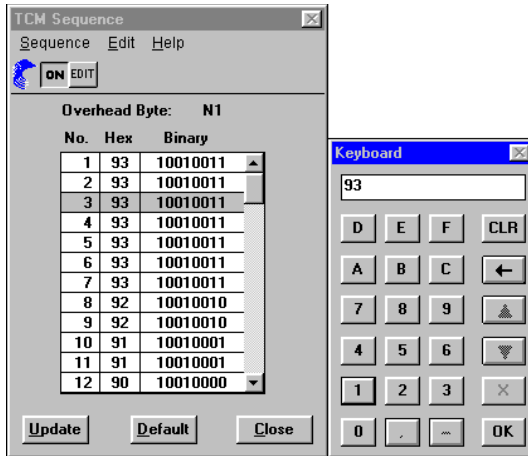

Fig. VI-19 "TCM Sequence" dialog with "Keyboard" dialog for editing the TCM sequence

If you click the "ON" button in the "TCM Sequence" dialog, the TCM sequence shown in the list box will be transmitted. If the content of the list box is changed while a sequence is being transmitted, the changes will not take effect until you click the "Update" button.

If you click the "Edit" button in the "TCM Sequence" dialog, the "Edit TCM Sequence" dialog opens. This dialog allows you to insert TCM anomalies and TCM defects into the TCM sequence very easily.

If you want to transfer the current content of the list box to the transmitter when the "Edit TCM Sequence" dialog is open, you must click on the "Update" button in the "Edit TCM Sequence" dialog.

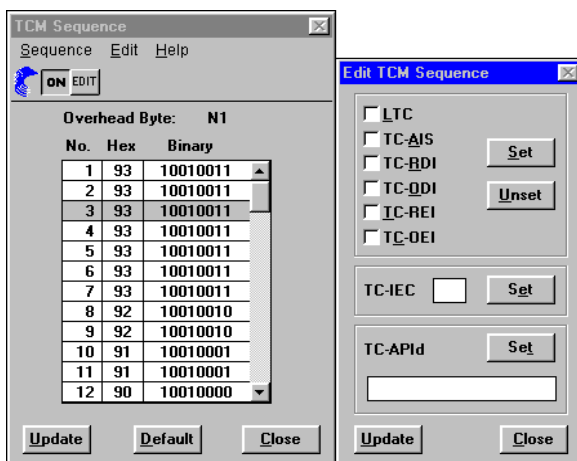

Fig. VI-20 "TCM Sequence" dialog with "Edit TCM Sequence" dialog for editing the TCM sequence



6 Overhead Analyzer

6.1 Main window: Overhead Analyzer

The “Overhead Analyzer” VI is used to display the contents of the “TOH (SONET) / SOH (SDH)” and “POH” overhead bytes of the received channel.

Menu bar and toolbar

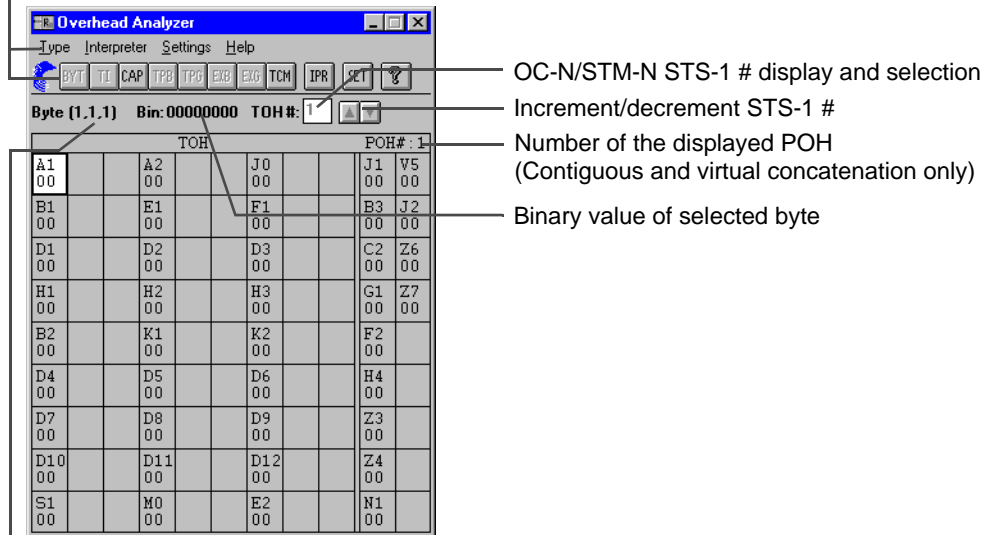

Location of selected byte in TOH (row/column/STS-1 #)

Fig. VI-21 Elements of the “Overhead Analyzer” main window

Menu	Icon button	Function
Type		Byte: Select individual byte analysis
		Trace Identifier: Display of bytes J0, J1, J2
		Capture function for recording selected bytes
		Test Pattern Byte: Display test pattern in individual bytes
		Test Pattern Group: Display test pattern in byte groups (e.g.. D1 to D4)
		External Byte: Outputs a byte to socket [21]
		External Group: Outputs a byte group to socket [21]
		Switch on TCM evaluation (Tandem Connection Monitoring). Only possible, if one of the bytes N1 or N2 (Z6) is marked.
Interpreter		On-line interpretation of APS, sync. and path label
Settings		Select expected values for trace identifier, path label and H1 byte



6.2 Menu: Type

The "Type" menu is used to set the various evaluation modes for the individual bytes.

J0, J1, J2:	Byte and Sequence evaluation
D1 to D4:	Byte, Test Pattern Byte and Test Pattern Group
D5 to D12:	Ext. Byte and Ext. Group
E1, E2, F1, F2:	Test Pattern Byte and Ext. Byte
K1, K2:	Ext. Group
K3, K4:	Ext. Byte
N1, N2 (Z6)	TCM evaluation

Basic procedure

1. Select the byte of interest in the overhead matrix.
The field color changes from gray to white.
2. Select the evaluation mode from the "Type" menu or using the corresponding icon buttons.

6.3 Window: Interpreter



The "Interpreter" window is used to display the actual content of the various bytes in plain text. You can also select whether the evaluation is to be performed according to "Ring APS (G. 841)" or "Linear APS (G. 783)".

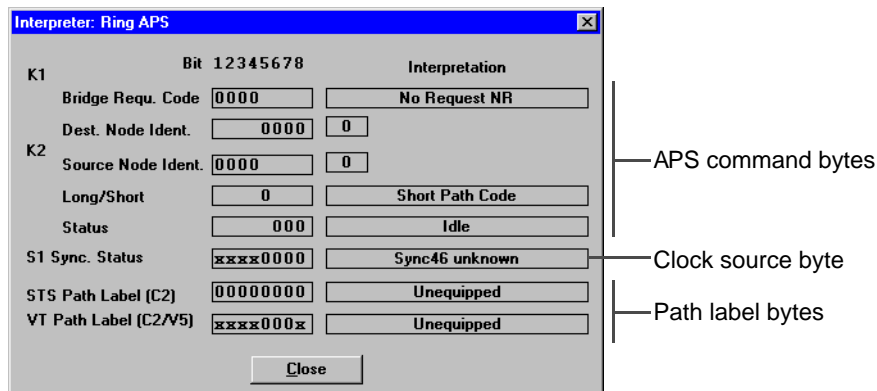

Fig. VI-22 "Interpreter" window for plain text display of TOH/POH bytes



6.4 Dialog: Settings



The “Settings” dialog is used to activate the receiver for checking the Trace Identifier or the Path Label. To do this, specify expected values for the Trace Identifier (J0, J1, J2) or Path Label (PLM-P, PLM-V). The device under test is operating correctly if the receive signal meets the expected values. If the receive signal does not match the expected values, the “Trace Identifier Mismatch” or “Path Label Mismatch” alarm messages can be generated. These defects are indicated in the “Anomaly/Defect Analyzer” VI.

You can also set the expected values for the SS bits in the H1 byte in the “Settings” dialog. The “LOP-P” alarm is generated if the SS bits received do not correspond to the expected SS bits. SS bits will not be evaluated if you set the expected value of the SS bits to “Don’t care” (xx).

Trace identifier bytes (TC-TIM bytes in preparation)

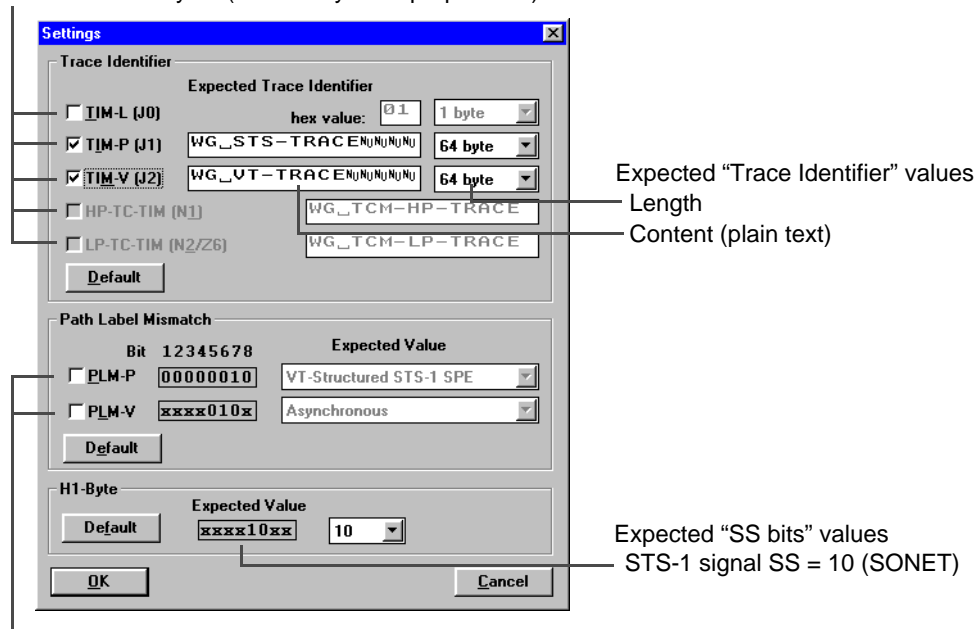

Defect definition

Fig. VI-23 “Settings” dialog

Checking the expected values and generating defects

Basic procedure:

1. Select the desired Trace Identifier byte (check box).
2. Enter the corresponding expected values (hexadecimal value or plain text messages).
3. Select the desired defect for a “Path Label Mismatch” (check box).
4. Select the corresponding expected values (“Expected Value” list box; Path Label Mismatch).
5. Select the expected values for the SS-Bits (“Expected Value” list box; H1-Byte).
6. Click the “OK” button.
The expected values will be checked and a message output if there is a mismatch.



6.5 Dialog: Byte Capture (Option BN 3035/90.15)



The "Byte Capture" dialog is part of the "Extended Overhead Analysis" option, BN 3035/90.15 and is opened by clicking on the above icon button.

The capture function allows you to record a single byte, or two bytes simultaneously in the case of K1 and K2. Recording is prepared by clicking the "START" button and begins when a pre-set trigger condition occurs. After this, a change into this byte is recorded on a frame-by-frame basis with timestamp until the buffer is full or you click the "STOP" button. When recording 2 bytes (K1 and K2), the buffer capacity is 200 entries. For single bytes, 265 entries can be saved.

Capture in the presence of defects

Capture is interrupted if LOF, LOS and OOF or LOP-P, AIS-P, LOP-V and AIS-V (POH capture) occur.

Capture is resumed when the defect clears. The duration of an LOS failure is not measured accurately to the nearest frame (LOS and LOF).

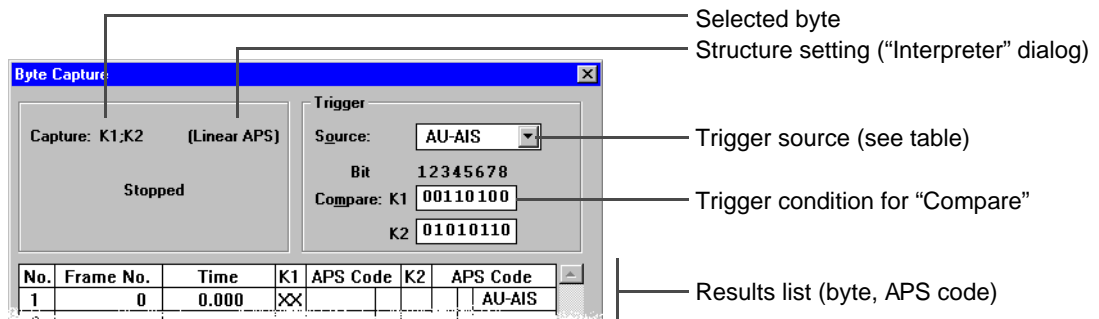

Fig. VI-24 "Capture" dialog

Setting the trigger condition

The "Source" list box is used to set the event that will start byte capture:

Setting		Start condition
Manual		Immediately after clicking START
Compare		The content of the recorded byte must be the same as the compare value. Enter 'X' for 'don't care' bit values
Compare not		Inverse compare condition. Recording starts when the value no longer corresponds to the compare value.
AU-AIS	AIS-P	Occurrence of AU-AIS or AIS-P
AU-LOP	LOP-P	Occurrence of AU-LOP or LOP-P

Table VI-5 "Source" list box



Setting		Start condition
MS-RDI	RDI-L	Occurrence of MS-RDI or RDI-L
MS-AIS	AIS-L	Occurrence of MS-AIS or AIS-L
N1/N2-TCM	N1/Z6-TCM	Starts recording TCM frames when the TCM FAS word has occurred (Tandem Connection Monitoring). Requirement: The N1/N2 or N1/Z6 byte is activated for Tandem Connection Monitoring.

Table VI-5 "Source" list box



7 Pointer Generator





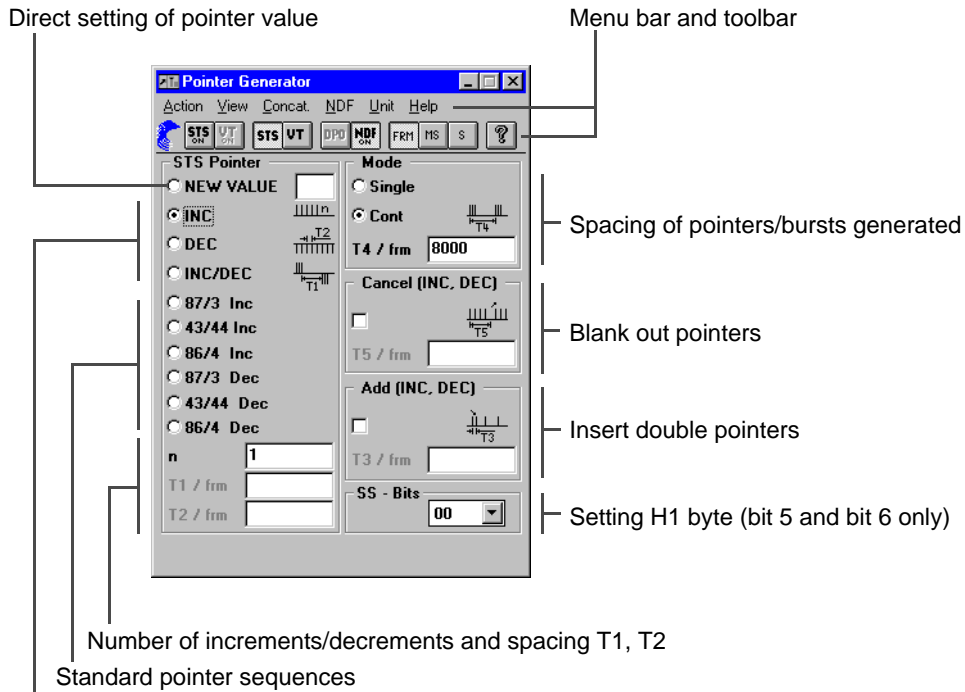





7.1 Main window: Pointer Generator

The "Pointer Generator" VI is used to generate individual pointer actions and pointer sequences according to the ANSI, Bellcore and ITU-T standards.



Pointer continuously or single increment/decrement

Fig. VI-25 Elements of the "Pointer Generator" main window

Menu - command	Icon button	Function
Action	 	Trigger STS or VT pointer action
View	 	Select STS or VT pointer layer
Concat.		Delta Pointer Offset
NDF		Set pointer value with NDF on / off
Unit - Frame		Units for the time parameters (T1 to T5) in frames
Unit - Millisecond		Units for the time parameters (T1 to T5) in milliseconds
Unit - Second		Units for the time parameters (T1 to T5) in seconds
Help		On-line help



7.2 Generating pointer actions

The Pointer Generator allows simultaneous generation of AU and TU pointers using independent parameters.

Periodic pointers and pointer bursts

- Periodic (single / multiple) pointers of identical polarity (“INC” or “DEC” pointer actions)
- Periodic (single / multiple) pointers of different polarity (“INC/DEC” pointer action)
- Periodic pointers with one double pointer (“INC” or “DEC” pointer actions with “Add” function, $T4 = n \times T2$)
- Periodic pointers with one missing pointer (“INC” or “DEC” pointer actions with “Cancel” function, $T4 = n \times T2$)
- Pointer burst with missing pointers (“INC” or “DEC” pointer actions with “Cancel” function, $T4 \gg n \times T2$)

Standard sequences

All the standard sequences to ITU-T G.783/ANSI T1.105.03 can be used directly or can be edited for special applications.

- “87-3” sequence
- “43-44” sequence with double pointer
- “86-4” sequence with double pointer

More information on generating special pointer actions / sequences is found in part 7 “Technical Background”.

Setting pointers (see Fig. VI-25)

1. Select the “NEW VALUE” option.
2. Enter pointer value in entry field (right).
3. Press “STS ON” button, if pointer actions have to be executed in the “Administrative Unit”.
– or –
Press “VT ON” button, if pointer actions have to be executed in the “Tributary Unit”.
4. Press “NFD ON” button to run pointer action.

Pointer range:

STS Pointer:	0 to 782
VT6 Pointer:	0 to 427
VT2 Pointer:	0 to 139
VT1.5 Pointer:	0 to 103

Selecting parameters

T1, T4:	0.25 ms to 600 s or 2 to 4800000 frames / multiframes
T2, T3:	0.25 ms to 10 s or 2 to 80000 frames / multiframes
T5:	0 ms to 600 s or 0 to 4 800000 frames / multiframes
n:	1 to 2000



Delta Pointer Offset

Only with option BN 3035/90.92 and “Virtual Concatenation” signal structure.

Pointer actions are possible for all channels for the TX settings “STM4” or “OC12” and “CONCAT.” mapping in the “Signal Structure” VI.



Clicking on this icon or selecting the “Delta Pointer Offset” command in the “Concatenation” menu opens the “Delta Pointer Offset” dialog. This dialog remains open until you select the “Delta Pointer Offset” command again.

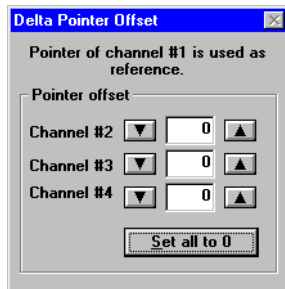

Fig. VI-26 “Delta Pointer Offset” dialog

An offset carried by the pointer for channel #1 can be set in this dialog for the pointers for channels #2 through #4. The pointer actions for channel #1 are set in the display / entry box of the main window.

The pointer actions for all channels are activated from the “Action” menu.

A change of more than 1 in the value of the pointer offset will be realized by consecutive changes of 1 at intervals of 32 frames. During this time, the Pointer Generator cannot be operated.

In the extreme case: $160 \text{ changes} \times 32 \text{ frames} \times 125 \text{ microseconds} = 640 \text{ milliseconds}$.



8 Pointer Analyzer

8.1 Main window: Pointer Analyzer

The "Pointer Analyzer" VI is used to display the pointer values (addresses) and to show the number of pointer actions graphically:

Menu bar and toolbar

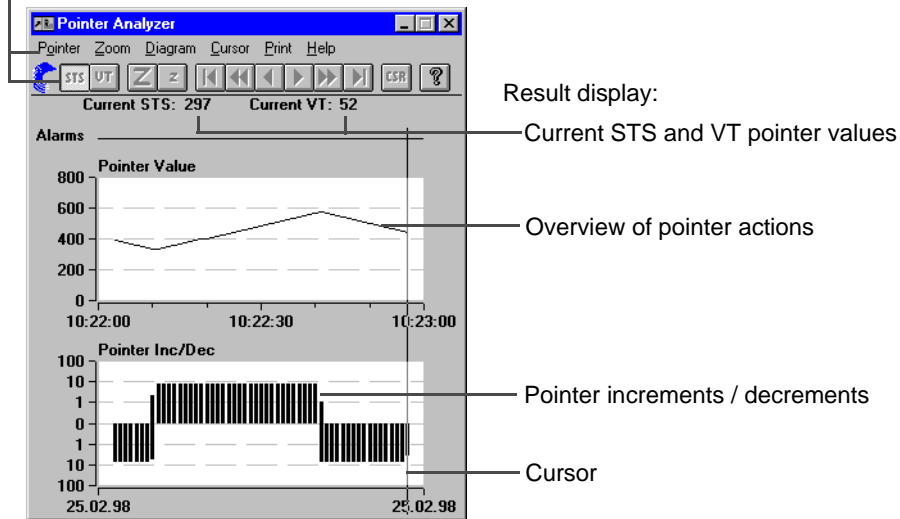

Fig. VI-27 Elements of the "Pointer Analyzer" main window

8.2 Main window: Pointer Analyzer for Virtual Concatenation

Only with option BN 3035/90.92

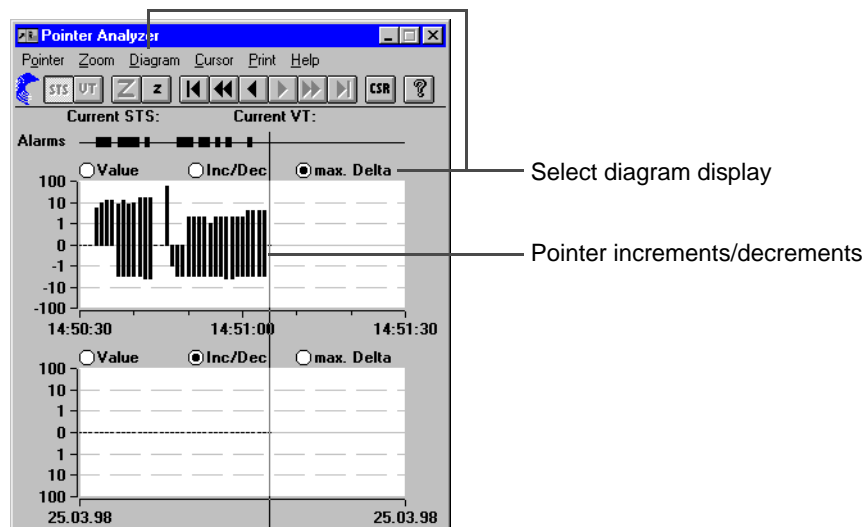

Fig. VI-28 "Pointer Analyzer" main window for Virtual Concatenation

The option buttons and the "Diagram" menu for selecting the diagram display and the "Print Delta Pointer" command are only active for virtual concatenation.



Menu - command	Icon button	Function
Pointer		Selects the pointer layer
Zoom - In/Out		Increase / decrease time axis resolution
Diagram		Select the diagram display (for Virtual Concatenation only)
Cursor - First/Last		Set the cursor to the start / end of the record
Cursor - Prev/Next Page		Move back / forwards by half a display width
Cursor - Prev/Next Value		Move back / forwards by one pointer address
Cursor - Position		Numerical display of pointer value at cursor position
Print		Print and export results
Help		On-line help

8.3 Window: Cursor



The results for the actual position of the cursor are displayed in the “Cursor” window. It also shows the pointer increments and decrements and the equivalent clock deviation in ppm.

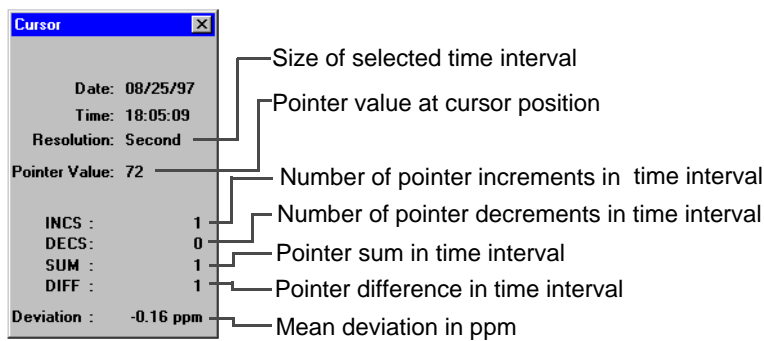

Fig. VI-29 “Cursor” window



8.4 Window: Cursor for Virtual Concatenation

Only with option BN 3035/90.92

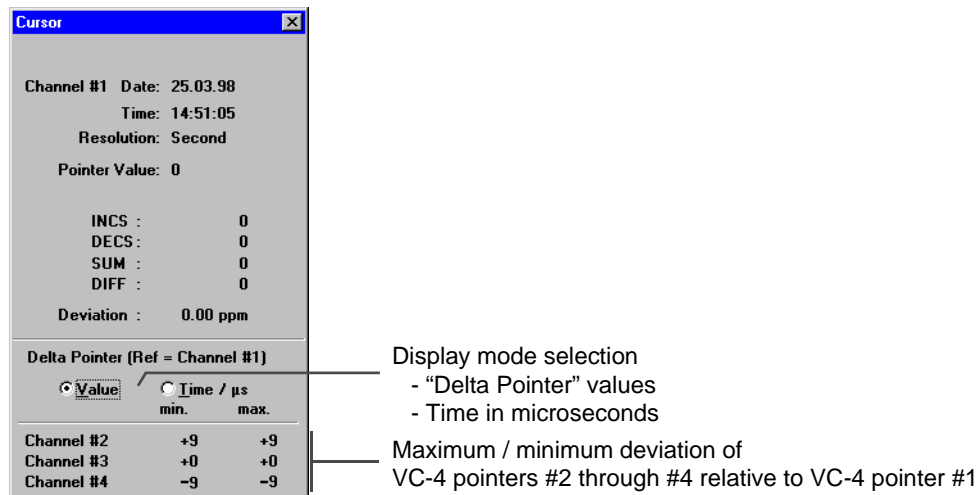

Fig. VI-30 "Cursor" window for Virtual Concatenation

8.5 Menu: Print

The "Print" menu is used to print out the results or to export them for processing using other programs.

Print ...	Print out results (Windows printer).
Printer Setup ...	Set parameters for the default printer, e.g. paper format, etc.
Export ...	Save the current results in a file for export (on floppy or hard disk).
Print Delta Pointer	Activates or deactivates print out of "Delta Pointer" measurement values.
Export Setup ...	Set the list and decimal separators and the time format for the export file; CSV settings selected: Semicolon, period (dot) and hh:mm:ss, respectively.

9 PDH Generator/Analyzer

9.1 Main window: PDH Generator/Analyzer (ITU-T and ANSI interfaces)

The “PDH Generator/Analyzer” VI is used to set and analyze selected parameters of framed PDH signals.

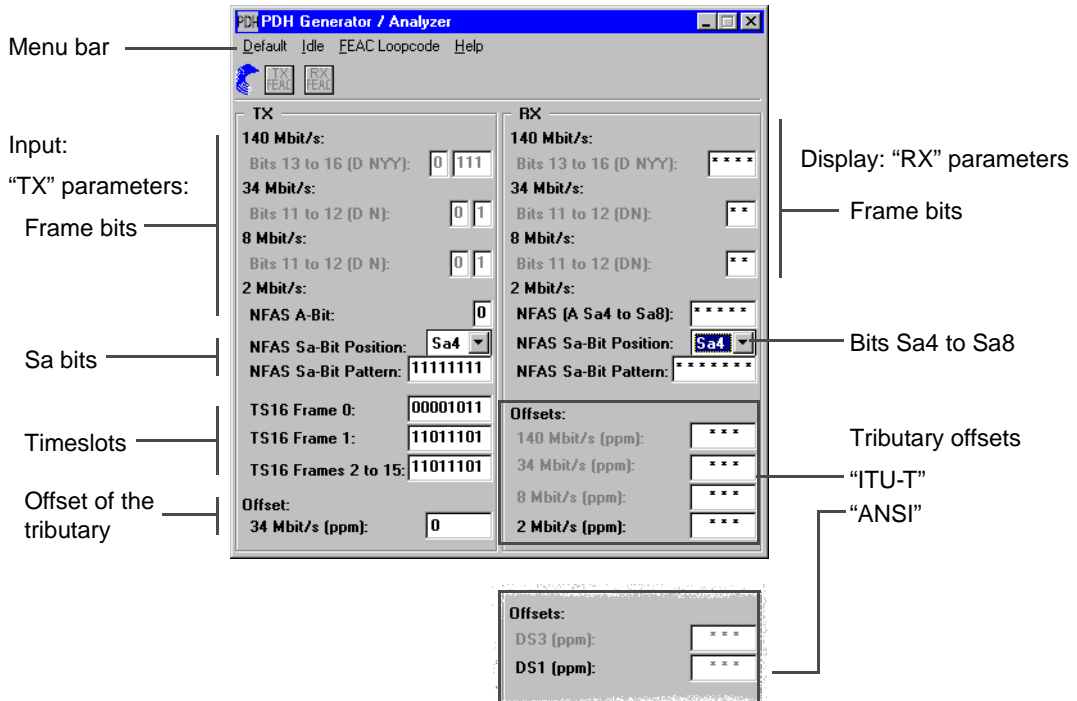

Fig. VI-31 Elements of the “PDH Generator/Analyzer” main window
TX side: ITU-T signal structure, RX side: ITU-T or ANSI signal structure

Menu	Function
Default	Sets the TX parameters to their default values
Idle	Enter selected frame bits in the idle channel
Feac Loopcode	Loops for system components can be activated and deactivated (active only for “DS3/Framed/C-Parity”)
Help	On-line help

9.2 TX parameters (ITU-T)

Frame and Sa bits

- 8/34/140 Mbit/s: Static entry of D and N frame bits
- 2 Mbit/s:
 - NFAS A bit: Static entry of the A bits.
 - NFAS Pattern: Fills bits Sa4 to Sa8 with one independent 8-bit sequence each.



Timeslot contents

- TS 16 Frame 0: For timeslot 16 in frame 0 (user-defined 8-bit word).
- TS 16 Frame 1: For timeslot 16 in frame 1 (user-defined 8-bit word for signals with special multiframe structure).
- TS 16 Frame 2 to 15: For timeslot 16 in frames 2 through 15 together (user-defined 8-bit word for signals with special multiframe structure).

9.3 RX parameters (ITU-T, ANSI)

Frame and Sa bits

- 8/34/140 Mbit/s: Display of D and N frame bits
- 2 Mbit/s:
 - NFAS A-Bit: Display of the A bit.
 - NFAS Pattern: Display of bits Sa4 to Sa8.

Tip: Select the Sa bit position for which the pattern is to be displayed from the “NFAS Sa-Bit Position” list box.

Offset (TX)

Static offset for the PDH tributary bit rate during insertion into the SDH container (± 100 ppm for all bit rates, relative to container; Step width: 1 ppm)

The offset is an average value. The actual offset at any given time may be above or below this value.

Offsets (RX)

Display of tributary channel offset. The deviation from the nominal bit rate is shown for each tributary in ppm.

Asterisks (*) are displayed in the boxes if display or measurement is not possible, e.g. because of an alarm being present or because of the signal structure setting.

9.4 Dialog: Idle

The “Idle” dialog is used to set the D and NFAS bits for the idle channels.

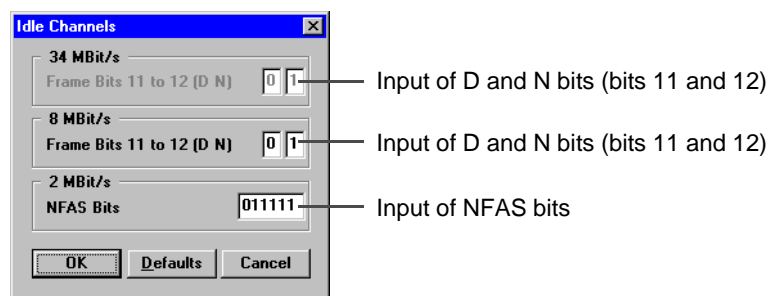

Fig. VI-32 “Idle Channels” dialog

9.5 Main window: PDH Generator/Analyzer (ANSI interfaces)

If signal structures according to ANSI are selected, the “PDH Generator/Analyzer” VI serves to display offsets of DS1 and DS3 tributaries.



Bild VI-33 Elements of the “PDH Generator/Analyzer” main window (ANSI)



10 Performance Analysis

10.1 Main window: Performance Analysis (general)

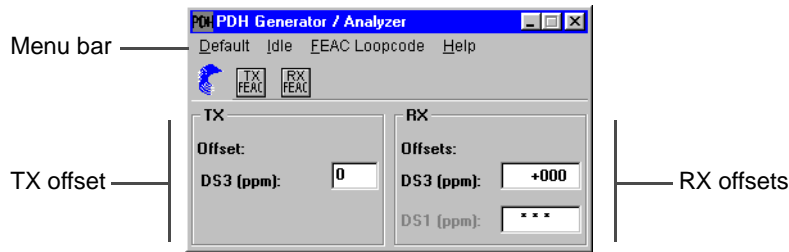
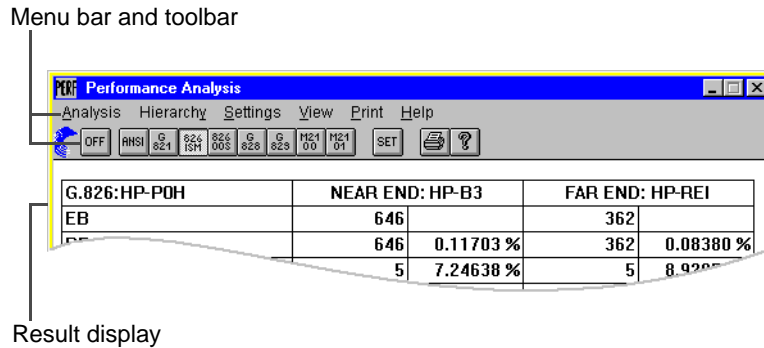

Fig. VI-34 "Performance Analysis" window

Menu - Command	Icon button	Function	More information
Analysis - OFF		Switch off analysis	-
Analysis - ANSI		ANSI analysis	Sec. 10.2, Page VI-42
Analysis - G.821		G.821 analysis	Sec. 10.3, Page VI-44
Analysis - G.826 ISM		G.826 In-service measurement	Sec. 10.4, Page VI-45
Analysis - G.826 OOS		G.826 Out of service analysis	
Analysis - G.828		G.828 analysis	Sec. 10.5, Page VI-46
Analysis - G.829		G.829 analysis	Sec. 10.6, Page VI-48
Analysis - M.2100		M.2100 analysis	Sec. 10.7, Page VI-50
Analysis - M.2101		M.2101 analysis	Sec. 10.8, Page VI-52
Settings		Set parameters depending on the selected analysis: G.821: Allocation, SES Threshold, DM Threshold, MUX Factor G.826: Allocation, SES Threshold, UAS-Limit (on/off), UAS-Mode (individual/global) G.828: Allocation, SES-Threshold, UAS-Limit (on/off), UAS-Mode (individual/global), SEP used in Verdict (on/off) G.829: SES-Threshold M.2100: Allocation, BISO Multiplier, UAS-Limit (on/off), UAS-Mode (individual/global)	-

Menu - Command	Icon button	Function	More information
Settings (continued)		M.2101: Allocation, BISO Multiplier, SES-Threshold, UAS-Limit (on/off), UAS-Mode (individual/global), M.2101-Version (4/1997 oder 6/2000), SEP used in Verdict (on/off)	
View		Switch toolbar and status line on/off	-
Print		Print out and export results	-
Help		On-line help	-

10.2 Performance Analysis: ANSI/BELL



For performance analysis to ANSI/BELL standards, definitions from GR-253 and T1.231 are used. The parameters ES, SES, EFS, SEFS and UAS measured for various hierarchy levels.

Analysis is performed on the following levels:

- SONET: Section (B1), line (B2SUM, REI-L), STS path (B3, REI-P), VT path (BIP-V, REI-V)
- DS3: Line (BPV), path (FE, Parity, FEBE)
- DS2: Line (BPV)
- DS1: Line (BPV), path (FE, CRC6)
- Bit: TSE

Note: Analysis is only possible on the selected hierarchy level.

The ANT-20SE analyzes the “near end” and “far end” where these are present.

The “far end” analysis will be interrupted if near end defects occur which make far end analysis impossible.

SECTION ANALYSIS	NEAR END: B1 BIP		FAR END: *	
ES	16	16 %	*	*
EFS	85	84 %	*	*
SES	9	9 %	*	*
UAS	0	0 %	*	*
SEFS	4	4 %		

Fig. VI-35 “Performance Analysis” window showing ANSI/BELL analysis



Dependence of defects on different levels

Some lower level defects depend on higher order defects. The GR-253, T1.105 standard specifies which defects at a lower level are triggered by higher level alarms.

For example, "AIS-L" generates "AIS-P", etc.

This is taken into account for the analysis; e.g. an "AIS-L" alarm generates "Path SES" as well as "Path SES" etc.

Note: As the ANSI/BELL analysis uses bit error evaluation, you cannot switch to block error evaluation.

Further information see part 7 "Technical Background".

10.3 Performance Analysis: ITU-T G.821



Clicking on the above icon button allows you to perform a G.821 analysis in the “Performance Analysis” window. The ITU-T G.821 analysis corresponds to Recommendation G.821 (Issue date 07/95).

Degraded minutes are also evaluated.

A multiplex factor can be taken into account during the analysis, corresponding to older versions of Recommendation G.821 (Annex D).

G.821 analysis can be performed on the following events:

- Bit errors (TSE, Test Sequence Error)
- FAS bit errors (FAS 2, FAS 8, FAS 34, FAS 140)
- CRC errors
- EBIT errors

The following signals can be measured when G.821 analysis is performed for test sequence errors (TSE):

- Unframed pattern without bit rate limitations
- N x 64 kbit/s
- Framed patterns and bulk signals
- Overhead bytes E1, E2, F1, F2, F2L, D1 to D3 and D4 to D12 in the SOH / POH of SDH signals

Note: As the G.821 analysis uses bit error evaluation, you cannot switch to block error evaluation.

G.821: TSE	COUNT	RATIO
ES	37	39.78495 %
EFS	56	60.21505 %
SES	0	0.00000 %
DM	1	64.51613 %
UAS	0	0.00000 %
VERDICT	Rejected	
PATH ALLOCATION	100.00000 %	

Fig. VI-36 “Performance Analysis” window showing ITU-T G.821 analysis

Further information see part 7 “Technical Background”.



10.4 Performance Analysis: ITU-T G.826



Clicking on the appropriate icon button shown above allows you to perform G.826 “In Service” (ISM) and “Out of Service” (OOS) analysis in the “Performance Analysis” window.

The following results are determined for the various hierarchy levels: EB, BBE, ES, EFS, SES, UAS, PATH UAS and VERDICT.

In the case of G.826 ISM, the ANT-20SE analyses both forward and backward channel (“Near End” and “Far End”), if this is possible at the measuring point selected.

Measurement is performed at framed signals of the primary system level or higher in the case of G.826 ISM. The following anomalies can be evaluated:

B1, B2SUM/MS-REI, HP-B3/HP-REI, LP-BIP8/LP-REI, LP-BIP2/LP-REI, FAS140, FAS34, FAS8, FAS2, CRC4/EBIT, G832-FAS140, G832-EM140/REI, G832-FAS34 and G832-EM34/REI.

For ANSI mappings, the following anomalies can also be measured: DS3 P-Parity, DS3 C-Parity, FAS45, FAS1.5 and DS1-CRC6.

The measuring point the G.826 ISM evaluation is performed at is set in the “Hierarchy” menu.

In the case of G.826 OOS, measurement is performed at unframed test signals. TSE block errors are always evaluated.

Note: As the G.826 analysis uses block error evaluation, you cannot switch to bit error evaluation.

G.826: HP-POH	NEAR END: HP-B3		FAR END: HP-REI	
EB	646		362	
BBE	646	0.11703 %	362	0.08380 %
ES	5	7.24638 %	5	8.92857 %
EFS	64	92.75362 %	51	91.07143 %
SES	0	0.00000 %	2	3.57143 %
UAS	0		13	
VERDICT	Rejected		Rejected	

PATH ALLOCATION	18.50000 %	Attention: Check TIM/PLM Defect Evaluation please!
PATH UAS	13	

Fig. VI-37 “Performance Analysis” window showing ITU-T G.826 ISM (in-service measurement)

Further information see part 7 “Technical Background”.

10.5 Performance Analysis: ITU-T G.828



Clicking on the above icon button allows you to perform a G.828 analysis in the “Performance Analysis” window.

G.828 evaluation conforms to ITU-T Recommendation dated 3/2000. The G.828 standard is a further development of Recommendation G.826 for synchronous digital paths.

Recommendation G.828 specifies additional measurement values and measurement points:

- SEP (Severely Errored Period, declared as optional)
- Performance measurement on TCM bytes (in preparation for ANT-20)

G.828 evaluation can be performed on the following events:

- B1
- B2SUM
- MS-REI
- B3
- HP-REI
- LP-BIP 2/8
- LP-REI
- Bit errors (TSE)

Selecting the meas. point

If you change the signal structure, a new meas. point is normally sought automatically. Either B3 or TSE will be set.

The meas. point is retained if the mapping is not altered.

G.828 evaluation will be disabled if measurements cannot be made at any of the meas. points listed (e.g. for ATM or G.832).

G.828: MSOH	NEAR END: B2SUM	FAR END: MS-REI
ES	0 0.00000 %	0 0.00000 %
EFS	28 100.00000 %	28 100.00000 %
SES	0 0.00000 %	0 0.00000 %
BBE	0 0.00000 %	0 0.00000 %
SEP	0 0.00000 %	0 0.00000 %
UAS	0 0.00000 %	0 0.00000 %
VERDICT	Accepted	Accepted
PATH ALLOCATION	18.50000 %	
PATH UAS	*	

Fig. VI-38 “Performance Analysis” window showing an ITU-T G.828 analysis

Parallel evaluation at the near end and far end

Where permitted by the signal structure, simultaneous evaluation takes place on the near end and far end. This applies to the following meas. points:

- B2SUM and MS-REI
- B3 and HP-REI
- LP-BIP 2/8 and LP-REI



All G.828 results are determined separately for the near end and far end.

The far end evaluation will be interrupted by certain alarms, such as LOS, LOF or AIS. These alarm times are excluded from the reference value for the rate computation at the far end.

G.828 evaluation on bit errors (TSE)

G.828 evaluation on bit errors (TSE) can be performed on the following signals:

- Unframed patterns without bit rate limitation
- Framed patterns and bulk signals
- Overhead bytes E1, E2, F1, F2, F2L, D1 through D3 and D4 through D12 in the SOH/POH of SDH signals

Since G.828 evaluation is a block error evaluation, it is not possible to switch to bit error evaluation.

Further information see part 7 "Technical Background".

10.6 Performance Analysis: ITU-T G.829



Clicking on the above icon button allows you to perform a G.829 analysis in the “Performance Analysis” window. G.829 evaluation can be performed on the following events:

- B1
- B2SUM
- MS-REI
- Bit errors (TSE)

Selecting the meas. point

If you change the signal structure, a new meas. point is normally sought automatically. Either B2SUM or TSE will be set.

The meas. point is retained if the mapping is not altered.

G.829 evaluation will be disabled if measurements cannot be made at any of the meas. points listed (e.g. for ATM or G.832).

Parallel evaluation at the near end and far end

Where permitted by the signal structure, simultaneous evaluation takes place on the near end and far end. This applies to the following meas. point:

- B2SUM and MS-REI

The G.829 results are determined separately for the near end and far end.

The far end evaluation will be interrupted by certain alarms, such as LOS, LOF or AIS. These alarm times are excluded from the reference value for the rate computation at the far end.

G.829 evaluation on bit errors (TSE)

G.829 evaluation on bit errors (TSE) can be performed on the following signals:

- Unframed patterns without bit rate limitation
- Framed patterns and bulk signals
- Overhead bytes E1, E2, F1, F2, F2L, D1 through D3 and D4 through D12 in the SOH/POH of SDH signals.

G.829: MSOH	NEAR END: B2SUM		FAR END: MS-REI	
ES	0	0.00000 %	0	0.00000 %
EFS	28	100.00000 %	28	100.00000 %
SES	0	0.00000 %	0	0.00000 %
BBE	0	0.00000 %	0	0.00000 %
UAS	0	0.00000 %	0	0.00000 %

For Help, press F1

Fig. VI-39 “Performance Analysis” window showing an ITU-T G.829 analysis



Note: The special block error evaluation using BIP-1 blocks means that the instrument is run in bit error evaluation mode. It is therefore not possible to switch to block error evaluation. This does not apply to the TSE meas. point, for which real block errors are evaluated. You cannot therefore switch to bit error evaluation when making a G.829 evaluation on TSEs.

Further information see part 7 "Technical Background".

10.7 Performance Analysis: ITU-T M.2100



Clicking on the above icon button allows you to perform a M.2100 analysis in the “Performance Analysis” window. M.2100 analysis can be performed on the following events:

- Bit errors (TSE)
- FAS bit errors (FAS1.5, FAS2, FAS8, FAS34, FAS45 and FAS140)
- CRC errors (CRC-4 and CRC-6)
- EBIT errors
- PBIT errors

Selecting the test point

The measuring point evaluation shall be performed at is set in the “Hierarchy” menu.

If you change the signal structure, a new test point will be selected automatically.

The new test point is selected in the following order of priority:

FAS 140, DS3 P-Bit, FAS 34, FAS 8, 2Mbit/s CRC 4, FAS 2, DS1 CRC 6, DS1 FAS, TSE.

The first possible test point in the new signal structure will be selected. Analysis is disabled if measurement is not possible at any of the test points listed.

Parallel M.2100 analysis at the “near end” and the “far end”

Analysis of PCM30CRC signals is performed simultaneously at the “near end” and the “far end”. All the M.2100 results for the near end and for the far end are determined separately.

Far end analysis will be interrupted by certain alarms, e.g. LOS, LOF or AIS. The times of these alarms will be subtracted from the reference value for determining the far end ratio results.

M.2100: PDH2CRC	NEAR END: CRC-4		FAR END: E-BIT	
ES	12	13.33333 %	9	10.22727 %
EFS	78	86.66666 %	79	89.77272 %
SES	2	2.22222 %	4	4.54545 %
UAS	0	0.00000 %	0	0.00000 %
VERDICT	Uncertain		Rejected	

ALLOCATION	100.00000 %				
BISO-ES	36	ES-S1	24	ES-S2	48
BISO-SES	2	SES-S1	0	SES-S2	4

Fig. VI-40 “Performance Analysis” window showing an ITU-T M.2100 analysis



M.2100 analysis of bit errors (TSE)

M.2100 analysis of test sequence errors can be performed on the following signals:

- Unframed pattern without bit rate limitations
- N x 64 kbit/s
- Framed patterns and bulk signals
- Overhead bytes E1, E2, F1, F2, F2L, D1 to D3 and D4 to D12 in the SOH / POH of SDH signals

Note: As the M.2100 analysis uses bit error evaluation, you cannot switch to block error evaluation.

Further information see part 7 "Technical Background".

10.8 Performance Analysis: ITU-T M.2101



M.2101 evaluation takes the issue of Recommendation M.2101 dated 6/2000 as well as the version M.2101.1 of April 1997 into account. You can switch between the two versions via a list box in the "Settings" menu. The main differences between the Recommendation M.2101 (4/1997) and the Recommendation M.2101 (6/2000) concern additional measurement values as well as differences in the error performance objectives:

- BBE (Background Block Error)
- SEP (Severely Errored Period)
- Performance measurement on TCM bytes (in preparation for ANT-20)

SEP evaluation is optional in the new Recommendation M.2101 (6/2000). The "Settings" menu therefore includes a separate switch for including or excluding SEP from the assessment verdict.

M.2101 evaluation can be performed on the following events:

- B1
- B2SUM
- MS-REI
- B3
- HP-REI
- LP-BIP 2/8
- LP-REI
- Bit errors (TSE)

Selecting the meas. point

If you change the signal structure, a new meas. point is normally sought automatically. Either B3 or TSE will be set.

The meas. point is retained if the mapping is not altered.

M.2101 evaluation will be disabled if measurements cannot be made at any of the meas. points listed (e.g. for ATM or G.832).

M.2101: MSOH	NEAR END: B2SUM		FAR END: MS-REI		
ES	0	0.00000 %	0	0.00000 %	
EFS	28	100.00000 %	28	100.00000 %	
SES	0	0.00000 %	0	0.00000 %	
BBE	0	0.00000 %	0	0.00000 %	
SEP	0	0.00000 %	0	0.00000 %	
UAS	0	0.00000 %	0	0.00000 %	
VERDICT	Accepted		Accepted		
ALLOCATION	100.00000 %				
BISO-ES	173	ES-S1	147	ES-S2	199
BISO-SES	43	SES-S1	30	SES-S2	56
BISO-BBE	165888	BBE-S1	165073	BBE-S2	166703
BISO-SEP	2	SEP-S1	0	SEP-S2	5

Fig. VI-41 "Performance Analysis" window showing an ITU-T M.2101 analysis



Parallel M.2101 evaluation at the near end and far end

Where permitted by the signal structure, simultaneous evaluation takes place on the near end and far end. This applies to the following meas. points:

- B2SUM and MS-REI
- B3 and HP-REI
- LP-BIP 2/8 and LP-REI

All M.2101 results are determined separately for the near end and far end.

The far end evaluation will be interrupted by certain alarms, such as LOS, LOF or AIS. These alarm times are excluded from the reference value for the rate computation at the far end.

M.2101 evaluation on bit errors (TSE)

M.2101 evaluation on bit errors (TSE) can be performed on the following signals:

- Unframed patterns without bit rate limitation
- Framed patterns and bulk signals
- Overhead bytes E1, E2, F1, F2, F2L, D1 through D3 and D4 through D12 in the SOH/POH of SDH signals

Note: Since M.2101 evaluation is a block error evaluation, it is not possible to switch to bit error evaluation, with the exception of B2SUM. BIP-1 blocks are used for this evaluation, which are only accessible via the bit error measurement function. For this reason, you cannot switch to block error evaluation when performing M.2101 evaluation on B2SUM.

Further information see part 7 "Technical Background".



Notes:

Application Guide



Contents

Application Guide

1	Introduction	A-1
1.1	The Application Manager	A-1
1.2	Signal Structure	A-3
2	In-Service Monitoring	A-5
3	Automatic Trouble Scan function	A-7
3.1	Test setup and description	A-7
3.1.1	In-service monitoring	A-7
3.1.2	Out of service measurement	A-7
3.2	Application settings	A-8
3.3	Measurement	A-8
4	Automatic Scan function	A-10
4.1	Test setup and description	A-10
4.2	Application settings	A-11
4.3	Measurement	A-11
5	Automatic Search function	A-12
5.1	Test setup and description	A-12
5.2	Application settings	A-13
5.3	Measurement	A-13
6	APS switching time measurement	A-14
6.1	Test setup and description	A-14
6.2	Application settings	A-15
6.3	Measurement	A-15
7	Bit error rate test (BERT)	A-17
7.1	Test setup and description	A-17
7.2	Application settings	A-17
7.3	Measurement	A-18



- 8 Performance analysis to G.821, G.826, G.828, G.829, M.2100, M.2101 A-22**
 - 8.1 Test setup and description A-22
 - 8.2 Application settings A-23
 - 8.3 Measurement A-23

- 9 Pointer stress test A-25**
 - 9.1 Test setup and description A-25
 - 9.2 Application settings A-26
 - 9.3 Measurement A-26

- 10 Editing and analyzing the Transport/Path overhead A-29**
 - 10.1 Test setup and description A-29
 - 10.2 Application settings A-29
 - 10.3 Measurement A-30

- 11 DCC/ECC bit error test. A-34**
 - 11.1 Test setup and description A-34
 - 11.2 Application settings A-34
 - 11.3 Measurement A-35

- 12 Maximum Tolerable Jitter (MTJ) A-38**
 - 12.1 Test setup and description A-38
 - 12.2 Application settings A-38
 - 12.3 Measurement A-39

- 13 Fast Maximum Tolerable Jitter (F-MTJ) A-41**
 - 13.1 Test setup and description A-41
 - 13.2 Application setting A-41
 - 13.3 Measurement A-42

- 14 Jitter Transfer Function (JTF) A-44**
 - 14.1 Test setup and description A-44
 - 14.2 Application setting A-45
 - 14.3 Measurement A-45



15	Phase Hit Measurement	A-48
15.1	Test setup and description	A-48
15.2	Application setting	A-48
15.3	Measurement	A-49
16	Wander Generator	A-51
16.1	Test setup and description	A-51
16.2	Application setting	A-51
16.3	Measurement	A-52
17	Wander Analysis to 2.5 Gbit/s	A-54
17.1	Test setup and description	A-54
17.2	Application setting	A-55
17.3	Measurement	A-55
18	Maximum Tolerable Wander (MTW)	A-59
18.1	Test setup and description	A-59
18.2	Application settings	A-59
18.3	Measurement	A-60
19	Consecutive Identical Digit (CID) Test to G.783, Appendix X	A-62
19.1	Test setup and description	A-62
20	Setting the ATM signal structure	A-64
20.1	Test setup and description	A-64
20.2	Application settings	A-64
21	ATM bit error rate test (ATM-BERT)	A-67
21.1	Test setup and description	A-67
21.2	Switch configuration	A-67
21.3	Application selection on the ANT-20SE	A-67
21.4	Measurement	A-68
22	ATM latency test for ATM switches	A-72
22.1	Test setup and description	A-72
22.2	Switch configuration	A-72
22.3	Application selection on the ANT-20SE	A-72
22.4	Measurement	A-73



- 23 ATM latency test with background load (ATM Background Generator) A-76**
 - 23.1 Test setup and description A-76
 - 23.2 Switch configuration A-76
 - 23.3 Application selection on the ANT-20SE A-76
 - 23.4 Measurement A-77

- 24 Sensor test - loss of cell delineation (LCD) A-79**
 - 24.1 Test setup and description A-79
 - 24.2 Switch configuration A-79
 - 24.3 Application selection on the ANT-20SE A-80
 - 24.4 Measurement A-80

- 25 Measuring the CLR with a variable cell rate (VBR traffic) A-82**
 - 25.1 Test setup and description A-82
 - 25.2 Switch configuration A-82
 - 25.3 Application selection on the ANT-20SE A-82
 - 25.4 Measurement A-83



Application Guide

1 Introduction

This manual is intended to simplify use of the ANT-20SE. Starting with the basic settings, the procedure for a successful measurement is explained step by step for each of the various measurement applications of the ANT-20SE. The basic settings are repeated for each subsequent application described.

1.1 The Application Manager

Once you have switched the instrument on and the Windows environment is displayed, the Application Manager appears in reduced format.



Fig. A-1 Application Manager in reduced format: "Minibar"

1. Click on the  button.
The full Application Manager window opens.

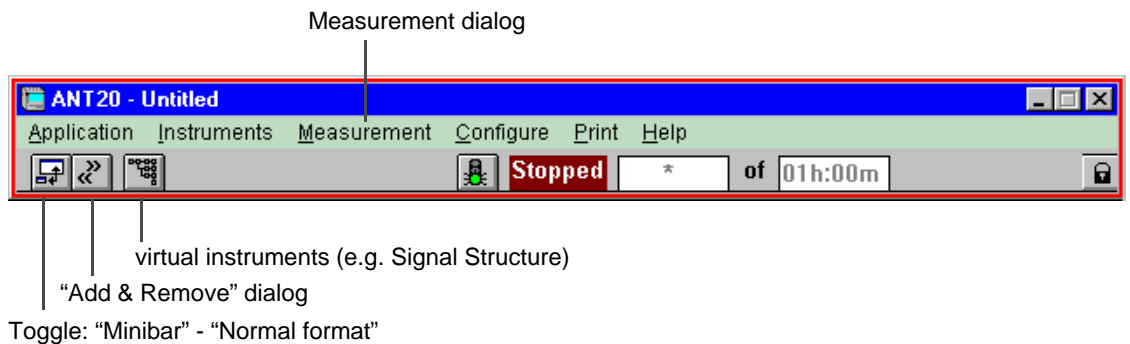

Fig. A-2 Application Manager in normal format

Virtual instruments

The Application Manager is the starting point for each measurement. The various measurement windows for a measurement are selected and the maximum measurement duration is set here.

The ANT-20SE represents a collection of several specialized measuring instruments, each of which fulfils a particular task. Each "instrument" is represented by a corresponding window. The ANT-20SE test windows are therefore called "Virtual Instruments" (VI). Depending on the measurement, various VIs are combined to make an application.



Setting the measurement duration

The maximum measurement duration is set in the “Measurement” menu using the “Settings...” dialog. You can also program a timer that allows measurements to be started automatically.

Selecting the virtual instruments

⇒ Click on the “Add & Remove” button in the Application Manager.

– or –

⇒ Select the “Add & Remove...” dialog from the “Instruments” menu.

All the instruments needed for your application are selected here. The menu lists all of the windows that are currently active.

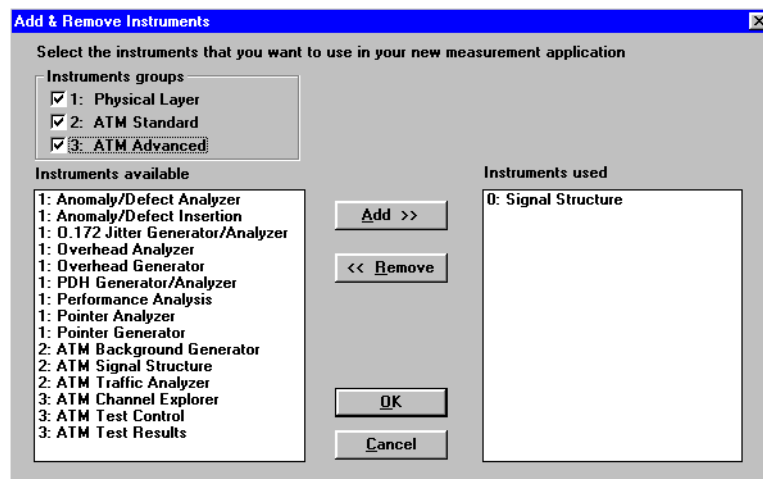

Fig. A-3 “Add & Remove” dialog window

Select the instruments required from the left-hand list box and add them to the application using the “Add>>” button. In the initial state, the list of VIs used (right-hand list box) contains the “Signal Structure” window. The other VIs needed for a particular application are detailed in this documentation. We will begin with the “Signal Structure” VI.



1.2 Signal Structure

The signal structure used for the measurement is set using the “Signal Structure” VI. Use the Application Manager to activate the window:



Fig. A-4 Minibar (Application Manager) after selecting the VIs

⇒ Click on the “Signal Structure” button.

The display area of the window shows the signal structure that is currently set.

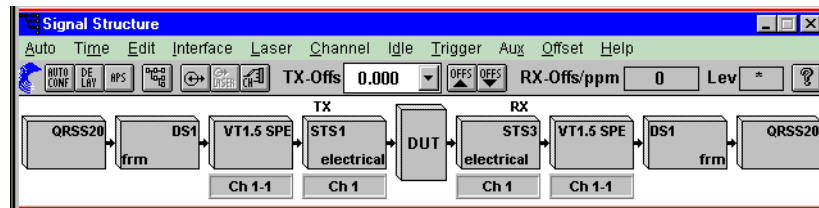

Fig. A-5 “Signal Structure” display window

⇒ To change the structure, select the “Signal Structure...” sub-menu from the “Edit” menu. The following window will be displayed:

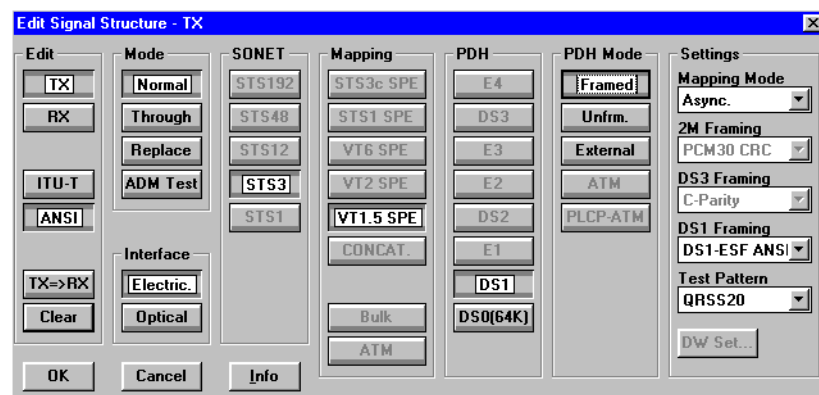

Fig. A-6 “Signal Structure” dialog window

Setting the signal structure manually

The setting is made column by column from left to right:

1. First select in the “**Edit**” column whether you want to edit the Tx or the Rx side. Then select the standard that is to apply (ITU-T or ANSI).
2. If you click on “**Clear**”, the Tx or Rx side (depending on your previous choice) will be cleared.
3. Now set the signal structure that you require (start with SDH or PDH). The “**TX =>RX**” or “**RX =>TX**” buttons automatically set the receiver or generator to the same settings as their counterpart. The generator and receiver now have the same settings.
4. Click on the “**OK**” button. The configuration you selected will be set only after you have clicked on the “**OK**” button.



Setting the signal structure automatically using the autoconfiguration function

This function lets you configure the ANT-20SE to standard input signals automatically. The electrical and optical interfaces are checked for the presence of standard PDH and OC-N/ STS-N signals and the payload contents in each case in channel 1.

1. Connect the ANT-20SE to the device under test (DUT).
2. Select the "Autoconfiguration..." sub-menu from the "Auto" menu.
3. Click on the "Start" button.
The input signal contents are checked.
The result is displayed.
4. Confirming the result sets the receiver to the corresponding signal structure.

Setting the channels

1. Select the "Set Channel..." dialog from the "Channel" menu.
You can now make settings in the active number windows:
2. Click on "**TX=>RX**" or "**RX=>TX**" to set the counterpart to the same settings.
3. Confirm by clicking "**OK**".

Setting the interface

- ⇒ Select the "Settings..." dialog from the "Interface" menu.
The window displayed is split into Tx and Rx sides.
This window allows you to configure the interface.



2 In-Service Monitoring

This section describes how you can use your ANT-20SE to monitor systems that are in service. This type of monitoring is required for various measurements that are described later on.

1. Monitoring from a protected monitoring point (PMP) of the DUT or a special test cable

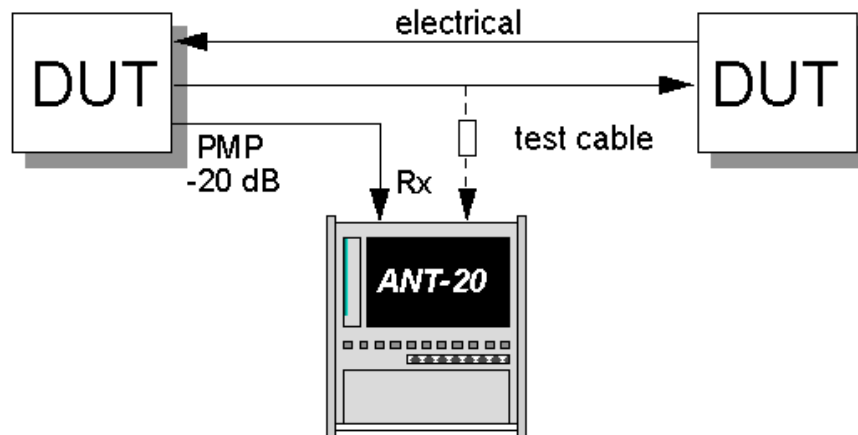

Fig. A-7 Monitoring from a protected monitoring point (PMP)

Interfaces

- electrical unbalanced Rx : [14]
- electrical balanced Rx : [12]

2. Monitoring by looping the signal through the ANT-20SE (“Through” mode)

The signal is looped through the ANT-20SE and simultaneously analyzed by the receiver.

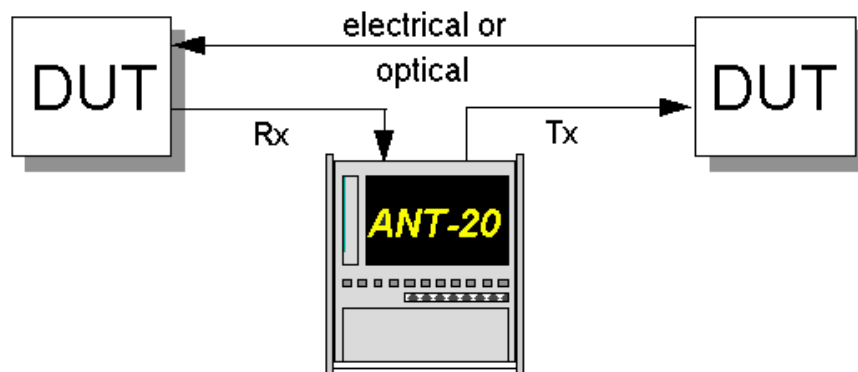

Fig. A-8 Monitoring using the ANT-20SE in “Through” mode

Interfaces

- electrical unbalanced Rx : [14] Tx : [15]
- optical 52, 155, 622 Mbit/s Rx : [17] Tx : [18]
- optical 2,5 Gbit/s Rx : [44] Tx : [47] (1550 nm)
Tx : [48] (1310 nm)



3. Monitoring using an optical power splitter

The ANT-20SE is equipped with a built-in optical power splitter.

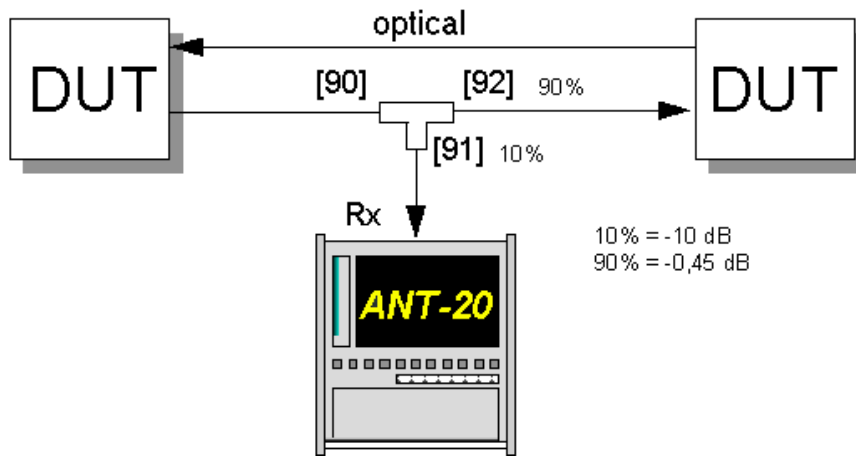

Fig. A-9 Monitoring using an optical power splitter

Interfaces

- Optical Power Splitter Rx : [90]
- optical 52, 155, 622 Mbit/s Rx : [17]
- optical 2.5 Gbit/s Rx : [44]



3 Automatic Trouble Scan function

3.1 Test setup and description

3.1.1 In-service monitoring

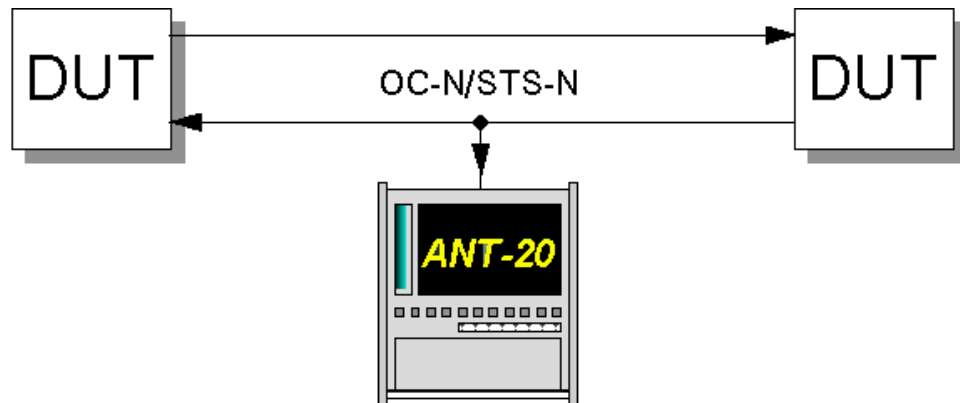

Fig. A-10 In-service monitoring setup

Interfaces

see Sec. 2, Page A-5

3.1.2 Out of service measurement

This function allows sequential testing of all VT6, VT2 and VT1.5 channels in a STS-1/OC-1 signal. The ANT-20SE receiver checks whether alarms have occurred in the input signal, in the SONET structure and in the channels. The channels are then indicated in a table as being OK or not OK. After the measurement, the detailed alarm status for each channel can be displayed.

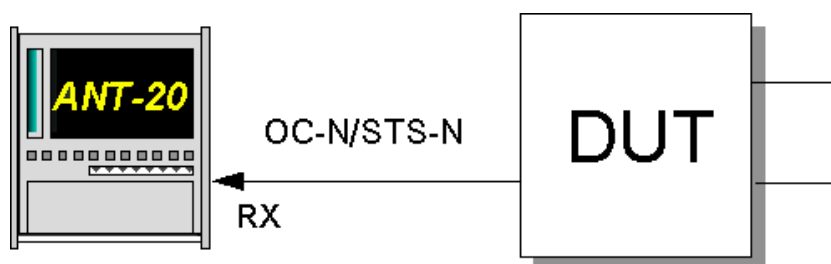

Fig. A-11 Out of service measurement setup

Interfaces

- electrical unbalanced Rx : [14] Tx : [15]
- optical 52, 155, 622 Mbit/s Rx : [17] Tx : [18]



Schematic diagram

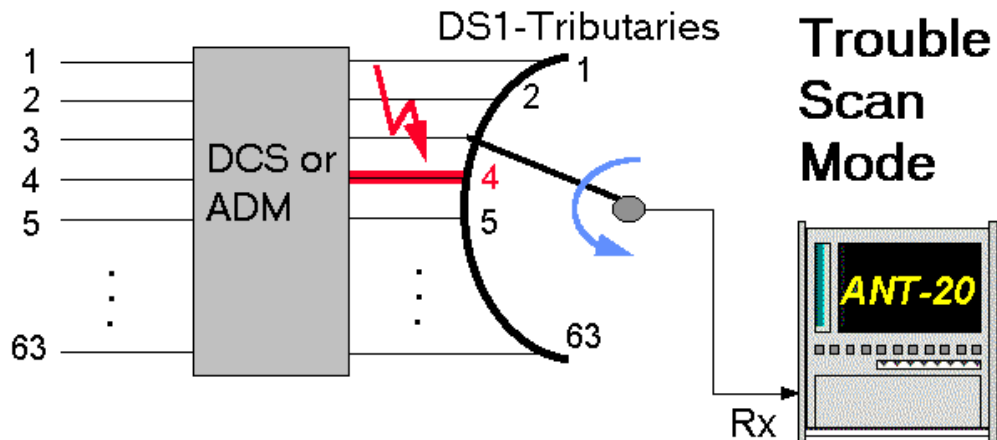

Fig. A-12 Alarm status recalled (Trouble Scan)

3.2 Application settings

VIs required

- Signal Structure

⇒ Add the VIs required to the list of VIs used in the Application Manager.

The Application Manager should include at least the following instruments (see Fig. A-13):



Fig. A-13 Minibar (Application Manager) after selecting the VIs

3.3 Measurement

1. Click on "Trouble Scan..." in the "Auto" menu in the "Signal Structure" window. A window showing a matrix of all the channels opens.
2. Click on the "Start" button. The measurement starts. Each channel is tested and marked separately. The measurement stops automatically.

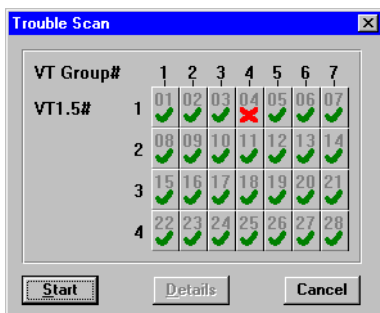

Fig. A-14 "Trouble Scan" window

3. To analyze a channel in more detail, select the channel and then click on the "Details" button.



The following window opens:

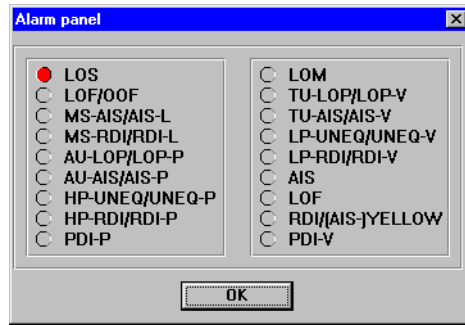

Fig. A-15 Display of alarms that occurred

The alarms that occurred in the channel during the measurement are indicated by red dots.



4 Automatic Scan function

4.1 Test setup and description

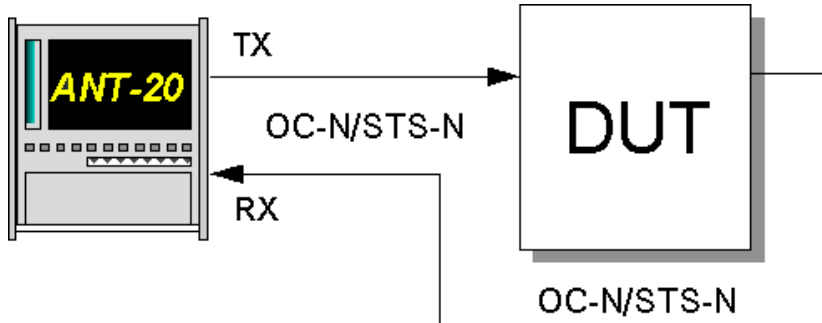

Fig. A-16 Automatic Scan function setup

In contrast to the Trouble Scan function, in this function the generator and receiver channels are switched and tested simultaneously. The synchronization of the selected pattern is tested in all channels in addition to the presence of any alarms. The channels are then indicated in a table as being OK or not OK.

Interfaces

- electrical unbalanced Rx : [14] Tx : [15]
- optical 52, 155, 622 Mbit/s Rx : [17] Tx : [18]

Schematic diagram

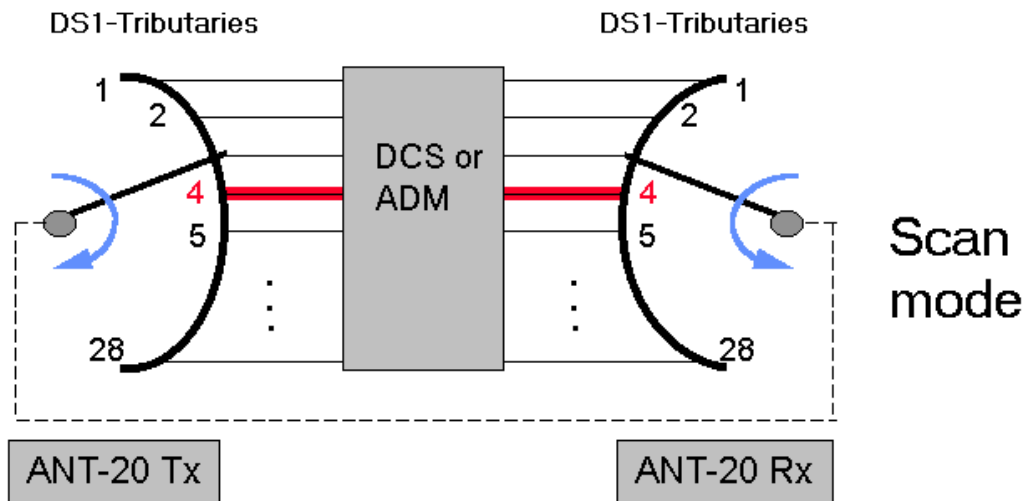

Fig. A-17 Automatic Scan mode



4.2 Application settings

VIs required

- Signal Structure

⇒ Add the VIs required to the list of VIs used in the Application Manager.

The Application Manager should include at least the following instruments (see Fig. A-18):



Fig. A-18 Minibar (Application Manager) after selecting the VIs

4.3 Measurement

1. Click on “Scan...” in the “Auto” menu in the “Signal Structure” window.
A window showing a matrix of all the channels opens.
2. Click on the “Start” button.
The measurement starts.
Each channel is tested and the measurement stops automatically.

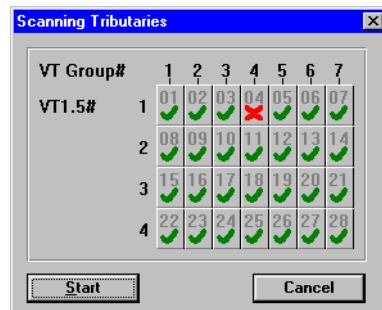

Fig. A-19 “Scanning Tributaries” window

- Errored channels are marked with a red cross (see channel 04 in example).



5 Automatic Search function

5.1 Test setup and description

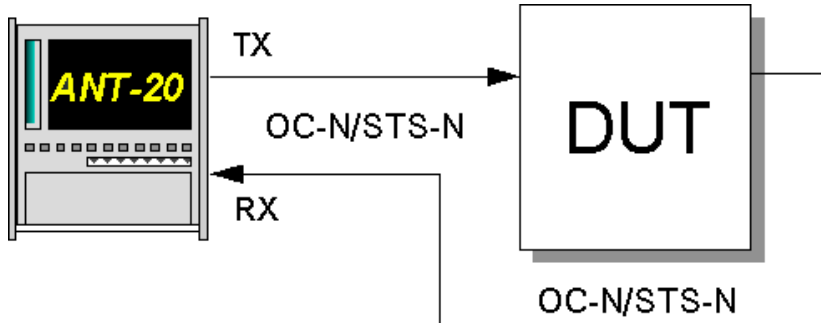

Fig. A-20 Search function setup

Interfaces

- electrical unbalanced Rx : [14] Tx : [15]
- optical 52, 155, 622 Mbit/s Rx : [17] Tx : [18]

This function provides a rapid and simple way of finding channel shifts in synchronous DCS and ADMs. The ANT-20SE receiver searches all channels for a pre-selected test signal. When the signal is found, the channel is marked in the table with a green check. Depending on the configuration of the DUT, the test pattern may be present in more than one channel. The ANT-20SE transmit channels are **not** switched simultaneously.

Schematic diagram

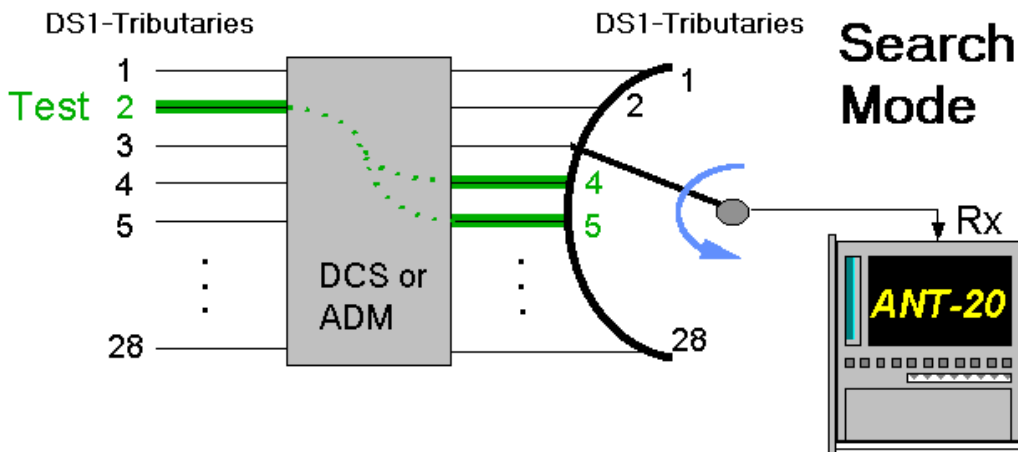

Fig. A-21 Automatic Search function



5.2 Application settings

VIs required

- Signal structure

⇒ Add the VIs required to the list of VIs used in the Application Manager.

The Application Manager should include at least the following instruments (see Fig. A-22):



Fig. A-22 Minibar (Application Manager) after selecting the VIs

5.3 Measurement

1. Set a test channel in the output signal.
Select the "Channel" menu in the "Signal Structure" VI to do this.
2. Click on "Search ..." in the "Auto" menu in the "Signal Structure" window.
A window showing a matrix of all the channels opens.
3. Click on the "Start" button.
The measurement starts.
Each channel is tested and the measurement stops automatically.

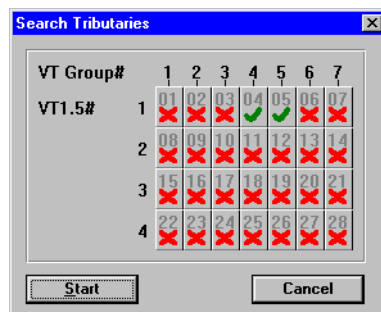

Fig. A-23 "Search Tributaries" window

The figure shows an example Search mode result. The channels to be located are channel 04 and 05.



6 APS switching time measurement

6.1 Test setup and description

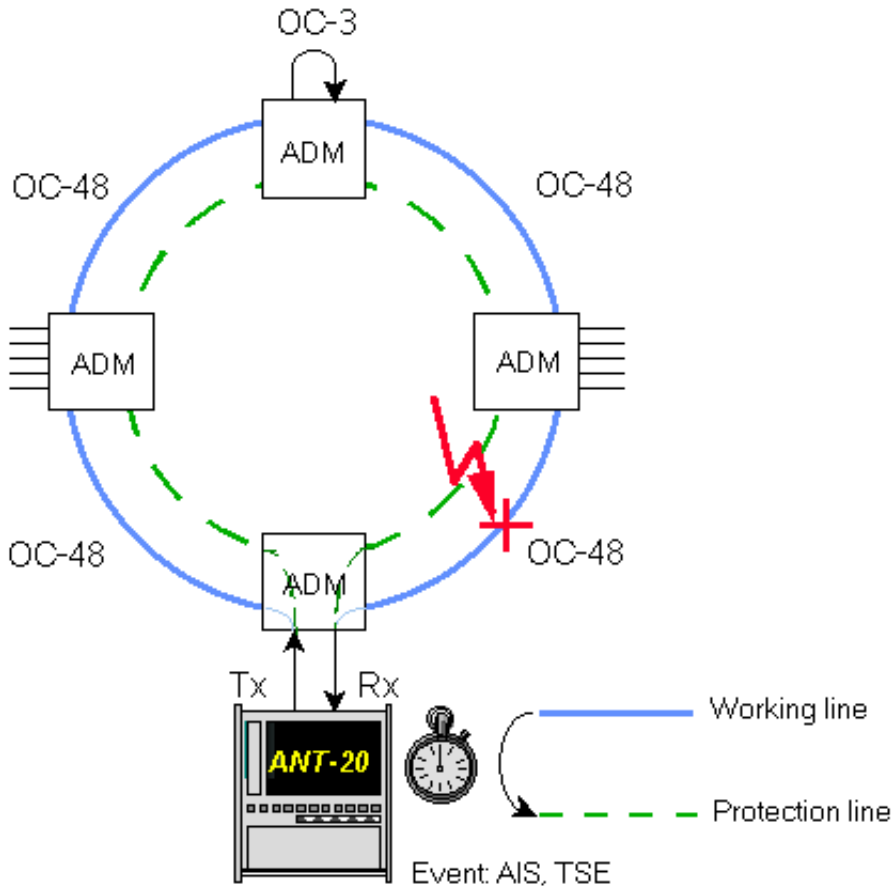

Fig. A-24 APS switching time setup

Interfaces

- electrical balanced Rx : [12] Tx : [13]
- electrical unbalanced Rx : [14] Tx : [15]
- optical 52, 155, 622 Mbit/s Rx : [17] Tx : [18]

APS stands for Automatic Protection Switching. This is a function of SONET networks that prevents connections from being interrupted for a long period if a working line fails.

If a problem occurs with the working line, the system automatically switches to a back-up line. The time taken to switch circuits must conform to certain requirements.

To check that the network meets these requirements, the ANT-20SE measures how long a particular event (e.g. AIS or loss of test pattern) remains present after APS has been triggered. The measured time is compared with a previously set threshold. This provides a simple PASSED/FAILED assessment of the APS switching time.



6.2 Application settings

VIs required

- Signal Structure

⇒ Add the VIs required to the list of VIs used in the Application Manager.

The Application Manager should include at least the following instruments (see Fig. A-25):



Fig. A-25 Minibar (Application Manager) after selecting the VIs

6.3 Measurement

Settings

1. Click on the APS icon button in the “Signal Structure” VI toolbar.

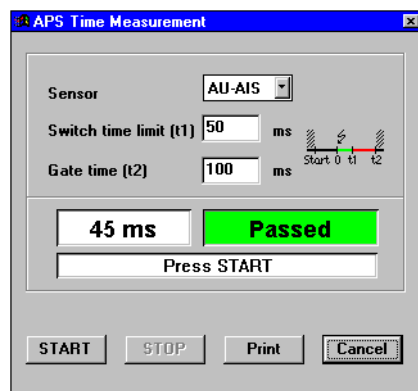

Fig. A-26 “APS Time Measurement” window

2. Select an event for triggering the switch process from the “Sensor” list box.
3. Set the maximum permitted switching time threshold value in the “Switch time limit (t1)” box.
4. Enter the required duration for the complete measurement in the “Gate time (t2)” box. This time should be more than the threshold value in order to detect multiple switching.
5. Start the measurement by clicking the “START” button.
6. Trigger the switching process by e.g. interrupting the working line.
The measurement stops automatically when completed.



Analysis

Two results are displayed once the measurement is completed:

- The total duration of the event pre-set in the “Sensor” list box.
- An interpretation of the measured value.

Display	Meaning
PASSED	Measured value \leq Switch time limit
FAILED (Time)	Measured value $>$ Switch time limit
FAILED (Signal)	A non-permitted defect occurred during the measurement that blocked the sensor (e.g. LOS or LOF if “Sensor” is set to MS-AIS)

Table A-1 Display of switching time measurement results



7 Bit error rate test (BERT)

7.1 Test setup and description

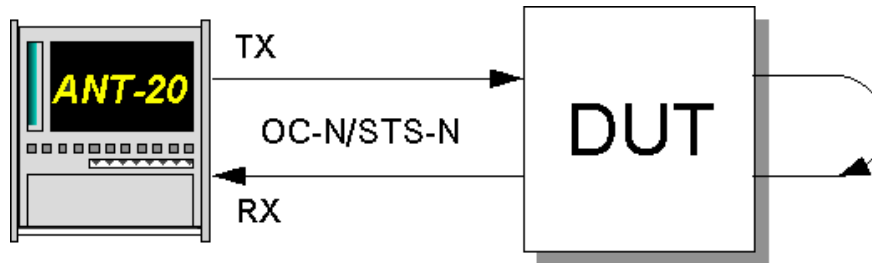

Fig. A-27 Bit error rate test setup

Interfaces

- electrical balanced Rx : [12] Tx : [13]
- electrical unbalanced Rx : [14] Tx : [15]
- optical 52, 155, 622 Mbit/s Rx : [17] Tx : [18]
- optical 2.5 Gbit/s Rx : [44] Tx : [47] (1550 nm)
Tx : [48] (1310 nm)
- optical 10 Gbit/s Rx : [113] Tx : [103]

This measurement is used to monitor a certain channel for defects and error messages that occur or to test the reaction of the DUT to artificially-induced defects and error messages.

7.2 Application settings

VIs required

- Signal Structure
- Anomaly/Defect Analyzer
- Anomaly/Defect Insertion

✓ The signal structure has been set and the ANT-20SE is connected to the DUT.

Tip: Make sure that you select the corresponding interface when you set the signal structure.

1. Add the VIs required to the list of VIs used in the Application Manager.
The Application Manager should include at least the following instruments (see Fig. A-28).
2. Now click first on the “Anomaly and Defect Analyzer” button and then on the “Anomaly and Defect Insertion” button in the Application Manager.
This activates both these applications. To monitor a signal, only the “Anomaly/Defect Analyzer” is needed.



Fig. A-28 Minibar (Application Manager) after selecting the VIs



7.3 Measurement

Example

Measurement of the reaction of a DUT to the insertion of a B2 error at a rate of 1E-6.

Error insertion

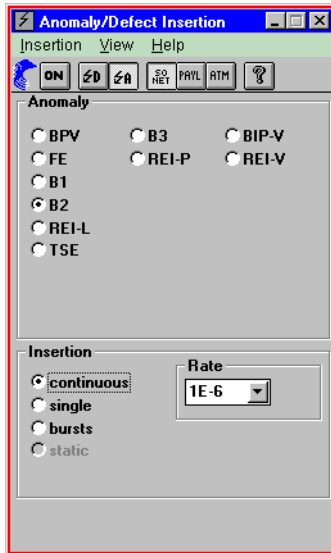

Fig. A-29 "Anomaly/Defect Insertion" window

1. Select "Anomalies" and "SONET" in the "View" menu.
– or –
Click on the corresponding buttons in the toolbar.
2. Select the item "B2" from the "Anomaly" list box.
3. Click on "continuous" in the "Insertion" box and select the appropriate rate from the selection box.
4. Click on the "ON" button in the toolbar.
– or –
Press function key F7.
Insertion of the anomaly is now activated.

Starting the measurement ("Application Manager" VI)

⇒ Start the measurement by pressing function key F5.

– or –

⇒ Click on the "green traffic signal" icon in the "Minibar" (Application Manager).



Error analysis

The signal and the reaction of the DUT are monitored using the “Anomaly and Defect Analyzer”. You can choose between four different types of result display.

Histogram (Graph)

The error rate is shown in the “Anomalies” box by clicking on the “B2” button.

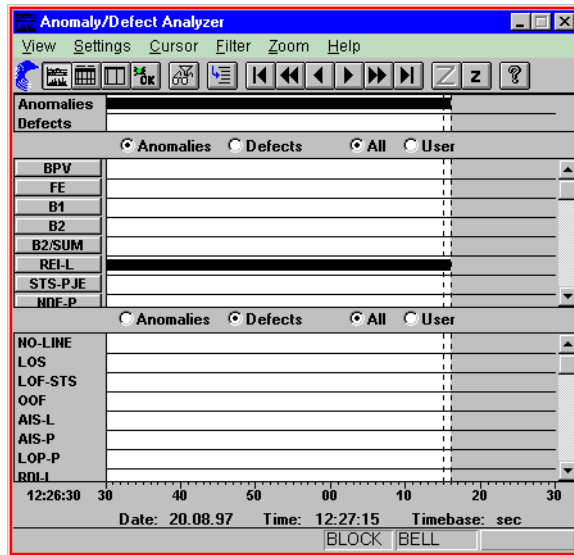

Fig. A-30 Histogram display

Table

This display window is particularly useful if you want to determine when and for how long a particular event occurred. Errors are shown as a count per second and alarm durations are shown with a resolution of 100 millisecond.

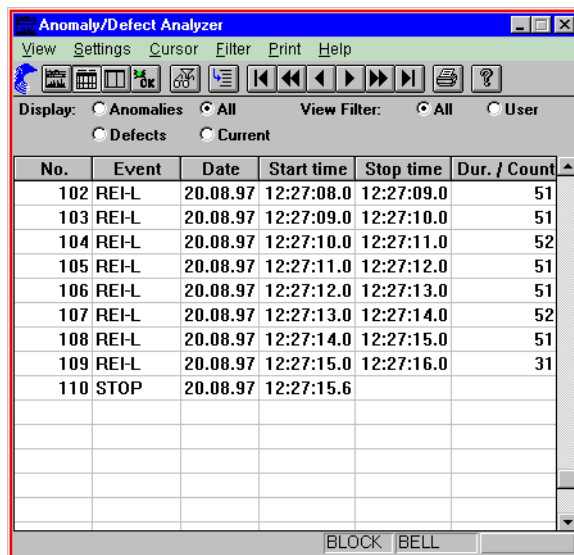

Fig. A-31 Table display



Count result (Num)

The “total” and “intermediate” results are displayed. The measurement parameters can be set under “Measurement Settings...” in the Application Manager.

The number of alarms displayed can be reduced by selection using appropriate filters.

	Total Results		Intermediate Results	
BPV	0	0	0	0
FE	0	0	0	0
B1	0	0	0	0
B2SUM	0	0	0	0
REI-L	5570	5.41E-3	441	5.41E-3
STS-PJE	0	0	0	0
NDF-P	0	0	0	0
B3	0	0	0	0
REI-P	0	0	0	0
BIP-V	0	0	0	0
REI-V	0	0	0	0
VT-PJE	0	0	0	0
NDF-V	0	0	0	0
FE-DS1	0	0	0	0
CRC-6	0	0	0	0
TSE	0	0	0	0

Fig. A-32 Numerical display

Summary

Summary display of anomalies and defects. The “Summary” view allows you to see at a glance whether anomalies or defects occurred during the measurement. The filter function allows you to exclude certain anomalies and defects from the Summary evaluation.

If the Performance Analyzer is loaded and an evaluation has been selected, the results of this evaluation will also be displayed.

Anomaly/Defect Summary

View Filter: All User

History

- Anomalies
- Defects

FAIL

Performance Analysis M.2101

Uncertain

Bild A-33 Summary display

**Stopping the measurement (“Application Manager” VI)**

⇒ Stop the measurement by pressing function key F6.

– or –

⇒ Click on the “red traffic signal” icon in the Minibar (Application Manager).



8 Performance analysis to G.821, G.826, G.828, G.829, M.2100, M.2101

8.1 Test setup and description

1. In-service monitoring

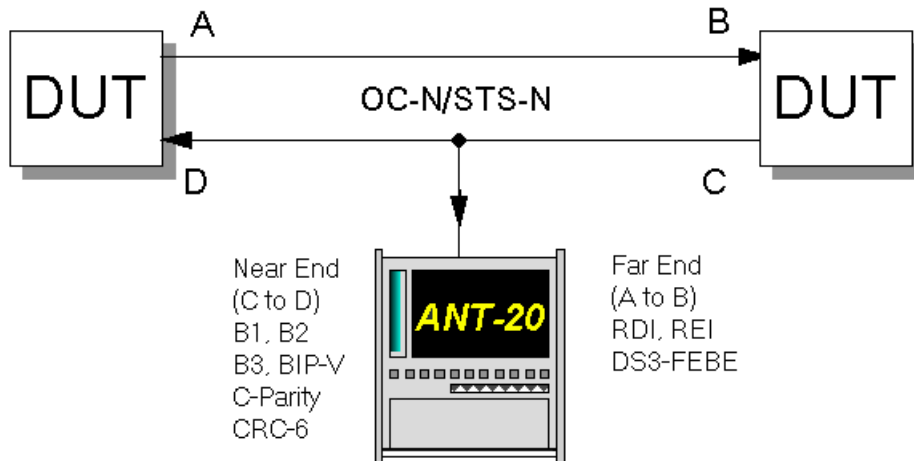

Fig. A-34 In-service monitoring setup

Interfaces: see Sec. 2, Page A-5

2. Out of service measurement

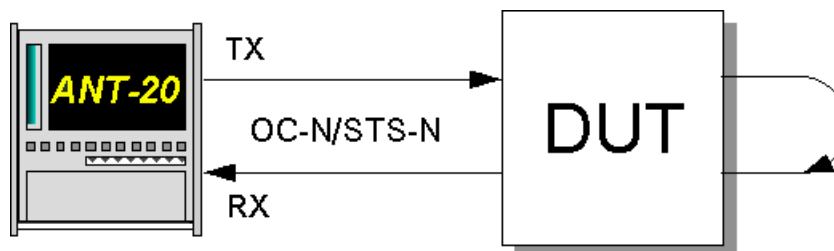

Fig. A-35 Out of service measurement setup

Interfaces

- electrical balanced Rx : [12] Tx : [13]
- electrical unbalanced Rx : [14] Tx : [15]
- optical 52, 155, 622 Mbit/s Rx : [17] Tx : [18]
- optical 2.5 Gbit/s Rx : [44] Tx : [47] (1550 nm)
Tx : [48] (1310 nm)
- optical 10 Gbit/s Rx : [113] Tx : [103]



These measurements are performed in order to determine the quality of a transmission path. The measurements are in accordance to ANSI (T1.231) and Bellcore (GR 253) recommendations. The measurement is based on transmission path test in three different layers: Section layer, line layer and STS/VT path layer. In this case the corresponding parity bytes (B1, B2, B3, BIP-V, C-Parity, CRC-6) and the transmitted alarm messages (RDI, REI, DS3-FEBE) of the reverse direction will be evaluated.

In OOS mode the test signals will be transmitted with PRBS in the payload and evaluated on far end of the path.

8.2 Application settings

VIs required

- Signal Structure
- Performance Analysis

1. Add the VIs required to the list of VIs used in the Application Manager.
The Application Manager should include at least the following instruments (see Fig. A-36):
2. Click on the "Performance Analysis" button to activate the VI.



Fig. A-36 Minibar (Application Manager) after selecting the VIs

8.3 Measurement

Example

ANSI performance analysis.

Settings

1. Select "ANSI" from the "Analysis" menu.
– or –
Click on the appropriate button in the toolbar.
2. Click on the "Hierarchy" menu (see Fig. A-37).
3. Set the desired hierarchy level for the measurement.
Selecting the TSE setting replaces the path payload by a PRBS and performs an end-to-end measurement.
4. Start the measurement by pressing function key F5.
– or –
Click on the "green traffic signal" icon in the "Minibar" (Application Manager).

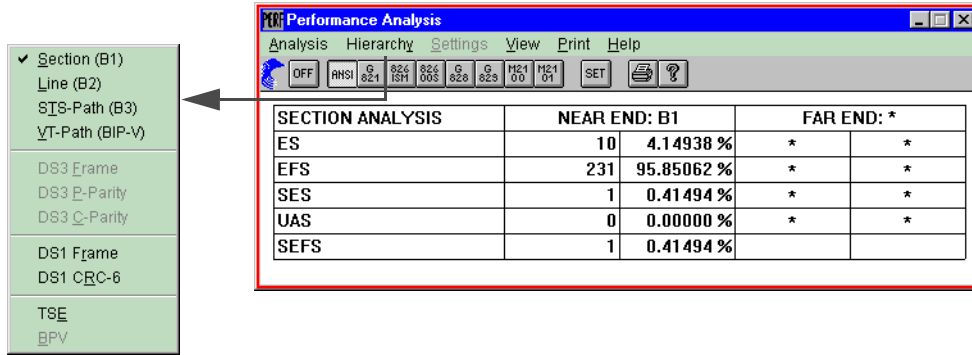

Fig. A-37 "Performance Analysis" window with open pull-down menu "Hierarchy"

Analysis

The analysis provides separate results for the "NEAR END" and the "FAR END". Put simply, this means that errors occurring directly in the path are analyzed as well as errors occurring in the return path which are indicated by a REI message. This allows both directions to be monitored without actually connecting to both.

For detailed descriptions of different evaluation modes see part 7 "Technical Background".



9 Pointer stress test

9.1 Test setup and description

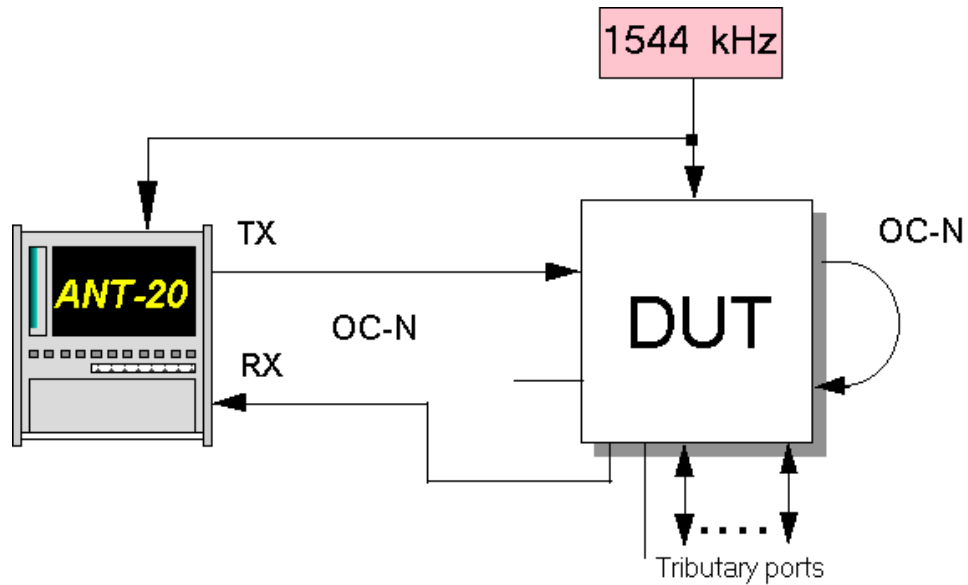

Fig. A-38 Pointer stress test setup

Interfaces

- electrical unbalanced Rx : [14] Tx : [15]
- optical 52, 155, 622 Mbit/s Rx : [17] Tx : [18]
- optical 2.5 Gbit/s Rx : [44] Tx : [47] (1550 nm)
Tx : [48] (1310 nm)
- optical 10 Gbit/s Rx : [113] Tx : [103]
- reference clock Rx : [25]

This measurement is intended to demonstrate that a network does not produce errors even when extreme pointer operations occur. Pointer sequences that are specified by the Recommendation T.1.105.03 are used for this. User-defined sequences can also be used. The following sequences are pre-defined:

- Single pointer with reversed polarity
- Pointer sequences with one double pointer
43/44 sequence: 43 pointers - 1 double pointer - 44 pointers
- Pointer sequences with missing pointers
87/3 sequence: 87 pointers - 3 missing pointers
86/4 sequence: 86 pointers - 4 missing pointers
26/1 sequence: 26 pointers - 1 missing pointers
- Double pointer with reversed polarity



9.2 Application settings

VIs required

- Signal Structure
- Pointer Generator
- Pointer Analyzer

1. Add the VIs required to the list of VIs used in the Application Manager.
The Application Manager should include at least the following instruments (see Fig. A-39).
2. To open the “Pointer Generator” and “Pointer Analyzer” windows, click on the appropriate buttons in the Application Manager.



Fig. A-39 Minibar (Application Manager) after selecting the VIs

9.3 Measurement

Example

Measurement of an 86/4 sequence for the STS pointer.

Settings

Synchronizing the ANT-20SE to an external clock signal:

1. Click on “Settings...” in the “Interface” menu in the “Signal Structure” VI.
2. Select “Ext. Clock 2M/E1 [25]” from the “Clock Source” box and click “OK” to confirm.

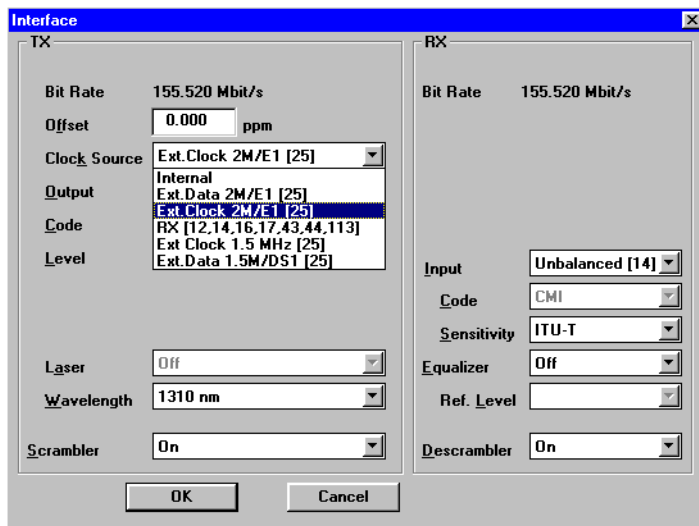

Fig. A-40 The “Interface” window

Selecting the sequence

The “Pointer Generator” allows simultaneous generation of test sequences (to G.783) for the STS and VT pointers. Both pointers can be tested simultaneously and independently of each other.

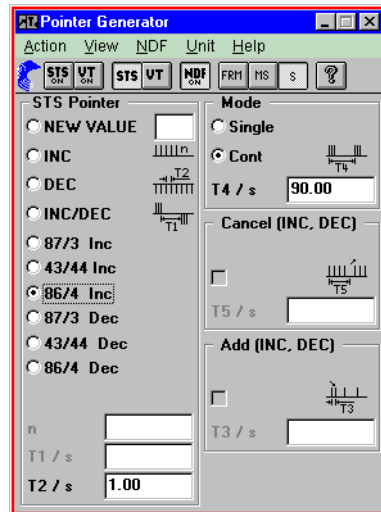

Fig. A-41 The "Pointer Generator" window

1. Click the "STS" button in the toolbar.
2. Select "86/4 Inc." from the "STS Pointer" box.
86 pointer jumps are generated, followed by 4 missing pointers.
3. Set the distance between two pointer actions in the "T2" entry box.
4. Set the desired sequence length in the "Mode" box.
Select between a single sequence or continuous repetition.
5. Click on the "STSON" button to activate the pointer sequence.
6. Start the measurement by pressing function key F5.
– or –
Click on the "green traffic signal" icon in the "Minibar" (Application Manager).

For detailed descriptions of the available pointer sequences, see part 7 "Technical Background"

Pointer analysis

The "Pointer Analyzer" has two windows for the two types of pointer, just like the "Pointer Generator". The measurement record starts once function key F5 has been pressed.

The results are shown as a display of pointer address versus time and as an absolute value of increment/decrement (INC/DEC) versus time.

The graphic display makes it easy to see if the system is running synchronously or if wander is present.

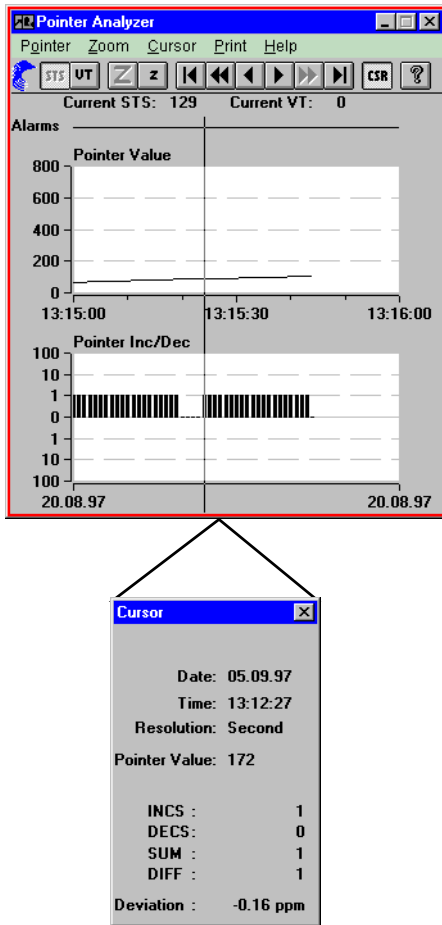

Fig. A-42 Pointer Analyzer

If you click on the “CSR” button, the “Cursor” window opens. This shows the actual pointer value and the increment or decrement of the pointer per unit time. The corresponding clock deviation is indicated under the heading “Deviation”.



10 Editing and analyzing the Transport/Path overhead

10.1 Test setup and description

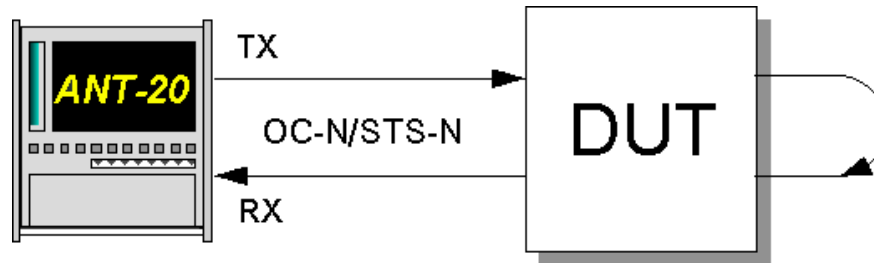

Fig. A-43 Setup for editing and analyzing the transport/path overhead

Interfaces

- electrical balanced Rx : [12] Tx : [13]
- electrical unbalanced Rx : [14] Tx : [15]
- optical 52, 155, 622 Mbit/s Rx : [17] Tx : [18]
- optical 2.5 Gbit/s Rx : [44] Tx : [47] (1550 nm)
Tx : [48] (1310 nm)

Access for manipulation of the individual bits in the TOH and POH is very important for conformance testing and fault clearance. The ANT-20SE allows you to immediately see the reaction to a manipulation, since the windows for OH generation **and** analysis are displayed together on the screen. This allows you to check APS information in the K1 and K2 bytes, for example. It is also possible to perform BERTs on the embedded communication channels (ECCs).

10.2 Application settings

VIs required

- Signal Structure
- Overhead Generator
- Overhead Analyzer

1. Add the VIs required to the list of VIs used in the Application Manager.
The Application Manager should include at least the following instruments (see Fig. A-44).
2. Click on the “Overhead Generator” and “Overhead Analyzer” buttons to activate both windows.



Fig. A-44 Minibar (Application Manager) after selecting the VIs



10.3 Measurement

Editing an overhead byte

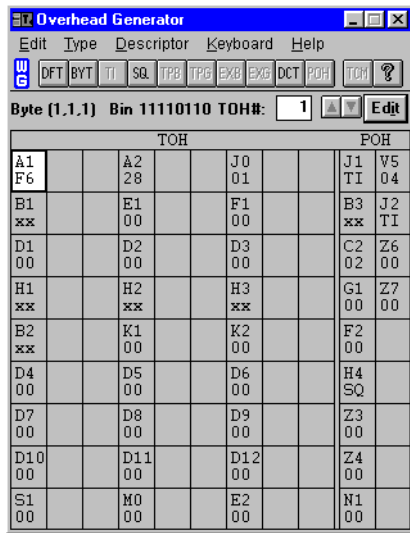

Fig. A-45 The "Overhead Generator" window

The TOH and POH bytes for the selected channel are displayed.

This tool can be used to change the overhead bytes to suit your requirements.

The following bytes are excluded: A1 and A2 (OC-48 only), B1 to B3 and H1 to H4.

The first row of the matrix shows the byte name. The hexadecimal value of the byte is shown in the next row.

Other abbreviations:

- xx Byte cannot be overwritten
- SQ Shown in the H4 byte field if a sequence is present
- TP Test pattern
- EX External access to DCC/ECC via V.11
- TI Trace identifier
- RX Receiver

Some or all of these abbreviations are also found in the toolbar.

Editing the overhead bytes:

1. First select a byte by clicking on it.
– or –
Mark it, using the cursor buttons.
2. Click on the selected field a second time to open the "Edit Overhead Byte" window.
3. Select a new value for the byte.
4. Click on "OK" to confirm your choice.
The new value will now be shown in the corresponding byte field.



Editing the trace identifier (J0, J1, J2)

1. Select a J byte from the matrix and click on the "TI" button in the toolbar.
The "Trace Identifier Editor" opens and an ASCII keyboard is displayed.
The default value is shown in the "Trace" box.
2. Edit the TI and click on "OK" to confirm.

The same value should be found in the trace identifier for the "Overhead Analyzer".

If this is not the case and you start a measurement, a TIM (Trace Identifier Mismatch) alarm will result.

You can return to the stored default value at any time by simply clicking on the "Default" button.

Editing bytes K1, K2, S1, C2 and V5

1. Select "Edit Descriptor" in the "Descriptor" menu.
– or –
Click on the "DCT" button in the "Overhead Generator" VI toolbar.
The following window opens.

	Bit	1	2	3	4	5	6	7	8
K1	Bridge Requ. Code	0	0	0	0				
	Dest. Node Ident.	0	0	0	0				
K2	Source. Node	0	0	0	0				
	Long/Short	0							
	Status	0	0	0					
S1	S1 Sync. Status	x	x	x	x	0	0	0	0
STS	STS Path Label (C2)	0	0	0	0	0	0	1	0
VT	VT Path Label (C2/V5)	x	x	x	x	0	1	0	x

Fig. A-46 The "Descriptor" window

Bytes K1/K2 and K3/K4 contain control commands for the APS system (automatic protection switching).

The byte name is shown in the left-hand column. The byte is shown in binary code in the center column. **Plain text** selection boxes are found on the right-hand side. You can set the various commands from the ANSI standard here without having to edit individual bits.



Analyzing the overhead bytes

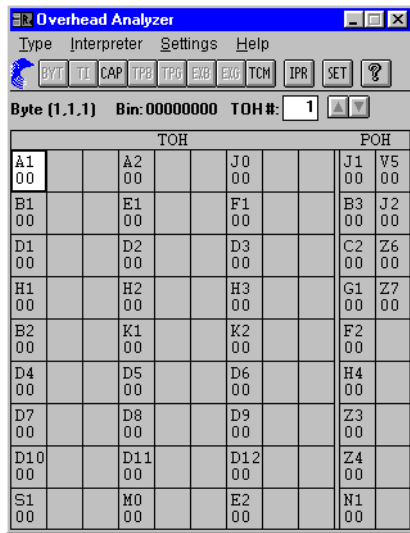

Fig. A-47 The "Overhead Analyzer" window

The "Overhead Analyzer" window is very similar to the "Overhead Generator" in its layout. The same byte matrix is used. The byte fields also correspond to those of the "Overhead Generator".

The toolbar contains two different buttons.

IPR

This button opens the "Interpreter" window. This provides an overview of the contents of the K bytes, the S1 byte and bytes C2/V5.

The bit patterns for each are interpreted and are also displayed in plain text.

SET

Click on this button to open the "Settings" window. In this window you can edit the expected values for the trace identifier, path label mismatch and the H1 byte.

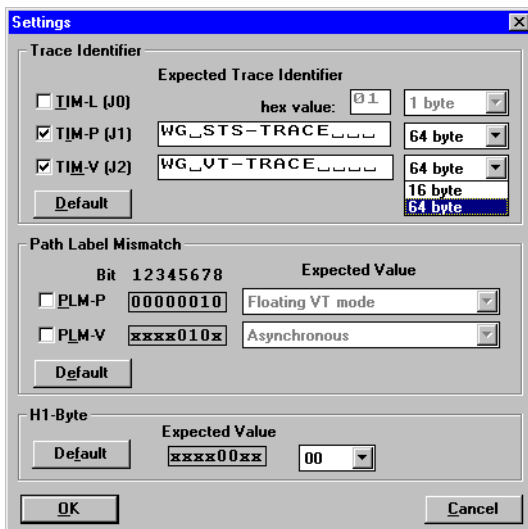

Fig. A-48 The "Settings" window



What happens if the generator and receiver trace identifiers do not match?

If the generator and receiver trace identifiers do not match a TIM alarm (trace identifier mismatch) will be detected. This will **not** be indicated by the LED display on the instrument front panel.

The presence of the alarm can be demonstrated using the “Anomaly and Defect Analyzer” (see figure below).

You can select whether an alarm is to be triggered or not in the “Settings” window of the “Overhead Analyzer” VI. The condition is activated by placing an identifier in front of the trace identifier (e.g. TIM-V).

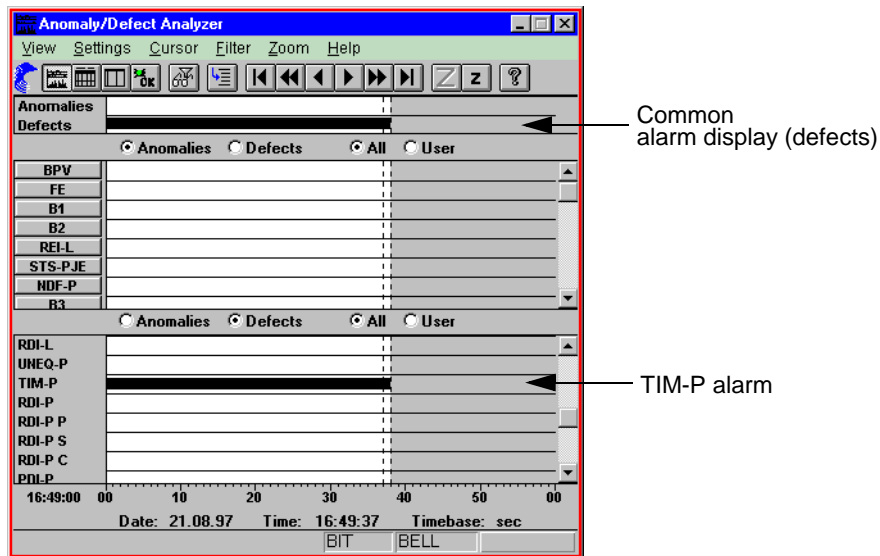

Fig. A-49 The Anomaly/Defect Analyzer window



11 DCC/ECC bit error test

11.1 Test setup and description

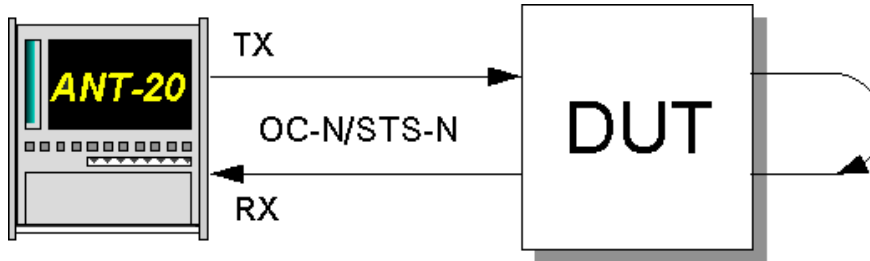

Fig. A-50 DCC/ECC bit error test setup

Interfaces

- electrical balanced Rx : [12] Tx : [13]
- electrical unbalanced Rx : [14] Tx : [15]
- optical 52, 155, 622 Mbit/s Rx : [17] Tx : [18]
- optical 2,5 Gbit/s Rx : [44] Tx : [47] (1550 nm)
Tx : [48] (1310 nm)
- optical 10 Gbit/s Rx : [113] Tx : [103]

The data communication channels (DCC) are used to control network elements via the network management system (TMN, Telecommunications Management Network). Bytes D1 to D4 (Section OH) and D5 to D12 (Line OH) make up the DCC. The embedded communication channels (ECC) contain the DCCs and also bytes E1, E2 and F1. To ensure that these channels operate correctly, the ANT-20SE inserts a bit pattern and performs a bit error test on the receiver side.

11.2 Application settings

VIs required

- Signal Structure
- Overhead Generator
- Overhead Analyzer
- Anomaly and Defect Insertion
- Anomaly and Defect Analyzer

⇒ Add the VIs required to the list of VIs used in the Application Manager.

The Application Manager should include at least the following instruments (see Fig. A-51).



Fig. A-51 Minibar (Application Manager) after selecting the VIs



11.3 Measurement

Example

BERT measurement in the DCC

Settings

1. First activate the “Overhead Generator“ and “Overhead Analyzer“ windows so that both are in the foreground.
 2. Select one of the D bytes in the Section OH or Line OH of the “Overhead Generator“ (field has a white background).
 3. Click on the “TPG“ (test pattern generator) button in the toolbar of the window. This fills one group (D1 to D4, D5 to D12) with a test pattern.
 4. Set the desired test pattern in the “Test pattern“ list box of the “Edit Signal Structure“ window in the “Signal Structure“ VI.
 5. Repeat the last three steps for the “Overhead Analyzer“ instead of the “Overhead Generator“.
- The D byte fields on both sides will now show “TP“.

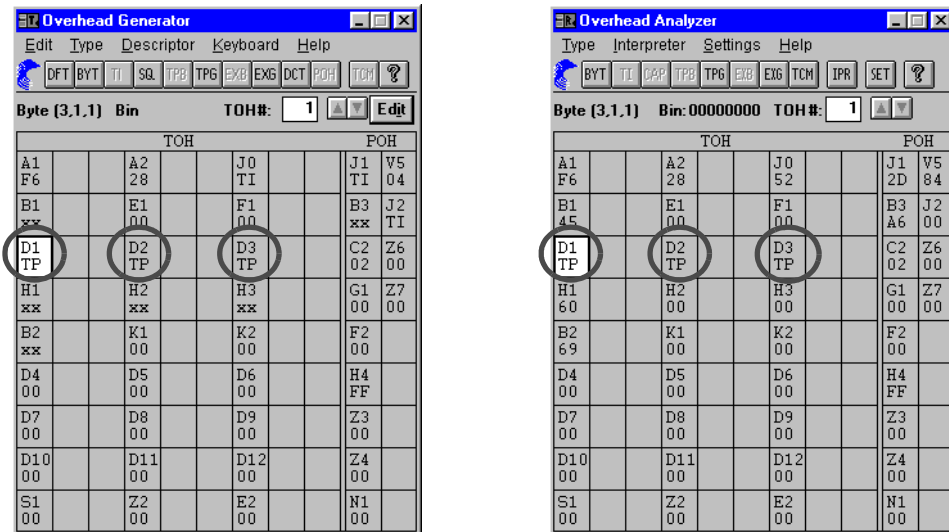

Fig. A-52 The “Overhead Generator“ and “Overhead Analyzer“ windows

6. Activate the “Anomaly and Defect Insertion“ VI and “Anomaly and Defect Analyzer“ VI windows.

Starting the measurement (“Application Manager“ VI)

- ⇒ Start the measurement by pressing function key F5.
- or –
- ⇒ Click on the “green traffic signal“ icon in the “Minibar“ (Application Manager).

Analysis

You can see if errors occur by means of the “Anomaly and Defect Analyzer“. These are displayed in the line labelled “TSE-OH“. You can insert TSEs using the “Anomaly and Defect Insertion“ VI and then observe whether these errors are reflected in the “Anomaly and Defect Analyzer“ (see Fig. A-53).

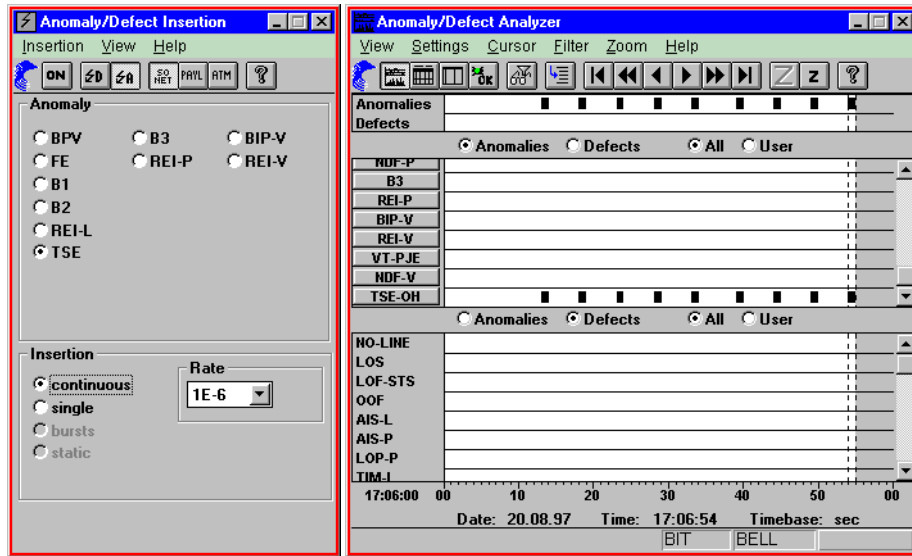

Fig. A-53 The "Anomaly/Defect Insertion" and "Anomaly/Defect Analyzer" windows

⇒ Stop the measurement by pressing function key F6.



12 Maximum Tolerable Jitter (MTJ)

To G.823, G.825, G.958, O.172

12.1 Test setup and description

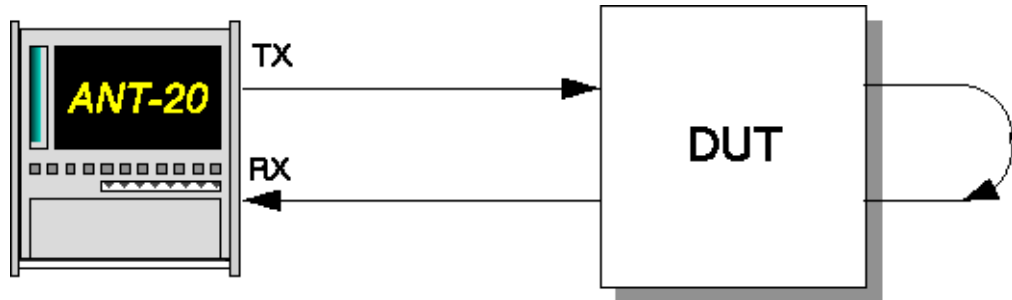

Fig. A-54 MTJ measurements setup

Interfaces

- electrical balanced Rx : [12] Tx : [13]
- electrical unbalanced Rx : [14] Tx : [15]
- optical 52, 155, 622 Mbit/s Rx : [17] Tx : [18]
- optical 2.5 Gbit/s Rx : [44] Tx : [47]

The measurement is used to check the maximum tolerable jitter of the electrical and optical line and tributary inputs.

When a sine-wave modulation signal is used with a pseudorandom sequence as the test pattern, at a given frequency, the amplitude of the jitter signals is increased using a half-interval progression until errors occur at the output of the device under test.

12.2 Application settings

VIs required

- Signal Structure
- O.172 Jitter Generator/Analyzer

1. Add the VIs required to the list of VIs used in the Application Manager.
The Application Manager should include at least the following instruments (see Fig. A-55).
2. Click on the "JIT" button to open the window for the O.172 Jitter Generator/Analyzer.



Fig. A-55 Minibar (Application Manager) after selecting the VIs



12.3 Measurement

Settings

- ✓ The O.172 Jitter Generator/Analyzer window must already be open.
 - 1. Select the “MTJ” command in the “Mode” menu.
 - or –
 - Click on the corresponding button in the toolbar.
 - 2. Select the error source (e.g. TSE, Test Sequence Error) in the “Error Source” list field (currently only bit errors are available).
 - 3. Enter the error threshold in the “Error Threshold” field. The error threshold provides a decision criterion for the search algorithm.
 - 4. In the “Settling Time” field, enter a delay for each measurement that allows the DUT to settle before the measurement is made.
 - 5. Enter the gate time in the “Gate Time” box.
 - 6. In the “Settings” menu select the “MTJ ...” item.
 - or –
 - Click on the “SET” symbol.
- The “Settings” dialog box is opened.

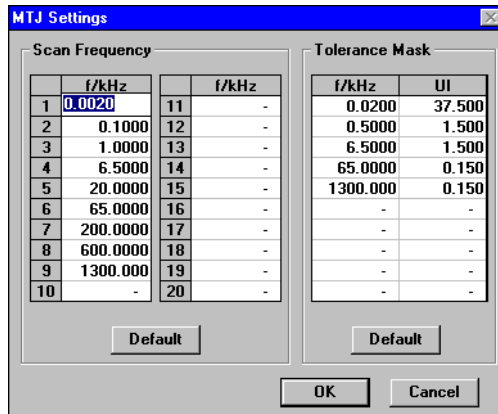

Fig. A-56 “MTJ Settings” dialog

In the box, you will find the measurement frequencies for the MTJ measurement and the characteristic data for the tolerance mask.

- 7. If necessary select your own scan frequencies and modify the tolerance mask values.
- 8. Confirm the input with “OK”.
 - The “Settings” dialog box is closed.
- 9. Start the measurement with “Start”. The measurement stops automatically, but can be halted at any time by clicking on “Stop”.



Analysis

When an MTJ measurement is made, the default values for the scan frequencies and the tolerance mask are set in the “MTJ Settings” window according to the bit rate. The default values are changed automatically when the bit rate is changed.

There are two windows for displaying results (see Fig. A-57).

Table format

- Measurement results are displayed in the table under “UI”.
- Measurement results where the tolerable jitter of the DUT is greater than the maximum amplitude that can be set on the jitter generator, are indicated by a “>” (e.g. >64 UI).
- Measurement results which are below the tolerance mask are marked with an “!” in the table.

Graphics format

- Measurement results are marked with a “+” on the graphics.
- Measurement results where the tolerable jitter of the DUT is greater than the maximum amplitude that can be set on the jitter generator are marked with “Δ” on the graphics (instead of the “+”).

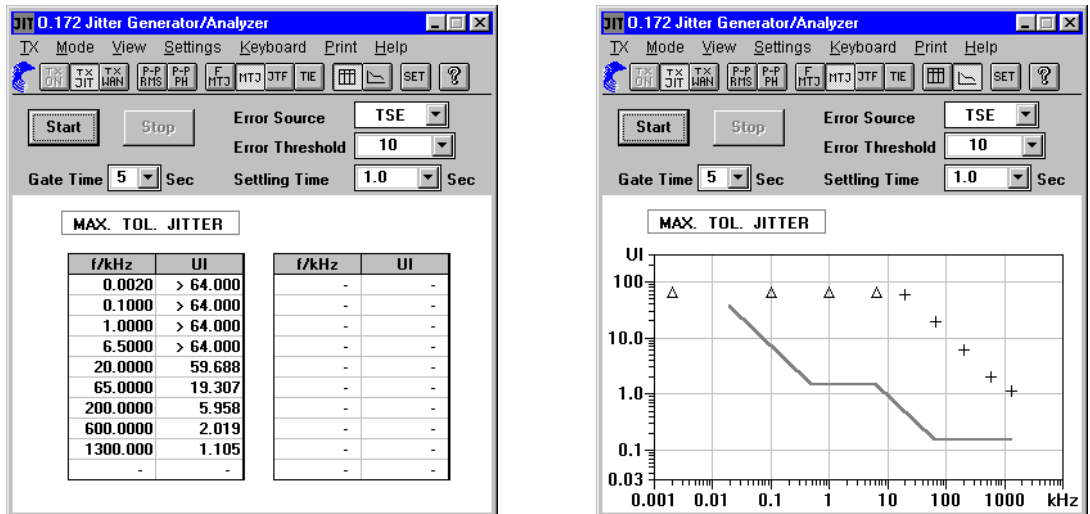

Fig. A-57 MTJ measurements: Results displayed as a table (left) and graphics (right)



13 Fast Maximum Tolerable Jitter (F-MTJ)

13.1 Test setup and description

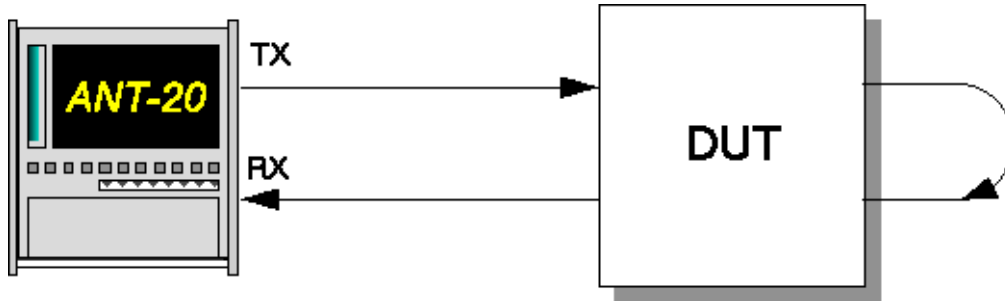

Fig. A-58 Fast MTJ measurements setup

Interfaces

- electrical balanced Rx : [12] Tx : [13]
- electrical unbalanced Rx : [14] Tx : [15]
- optical 52, 155, 622 Mbit/s Rx : [17] Tx : [18]
- optical 2.5 Gbit/s Rx : [44] Tx : [47]

With a Fast MTJ measurement, given combinations of jitter frequencies and jitter amplitudes which lie on the limit curves stipulated by ANSI are set on the jitter generator.

Each measurement point is classified as “OK” or “Failed”. This indicates whether the DUT meets the limit curve or not.

13.2 Application setting

VIs required

- Signal Structure
- O.172 Jitter Generator/Analyzer

1. Add the VIs required to the list of VIs used on the Application Manager.
The Application Manager should include at least the following instruments (see Fig. A-59).
2. Click on the “JIT” button to open the window for the O.172 Jitter Generator/Analyzer.



Fig. A-59 Minibar (Application Manager) after selecting the VIs



13.3 Measurement

Settings

- ✓ The “O.172 Jitter Generator/Analyzer” window has already been opened.
- 1. Select the “Fast MTJ” command in the “Mode” menu.
 - or –
 - Click on the corresponding button in the tool bar.
- 2. Select the error source (e.g. TSE, Test Sequence Error) from the “Error Source” list box.
- 3. In the “Error Threshold” box, enter the error threshold above which a device under test is to be considered as having “Failed” the test.
 - An error threshold cannot be entered if an alarm is selected from the “Error Source” list box.
- 4. In the “Settling Time” box, enter a settling time for each measurement to allow the d.u.t to settle.
- 5. Select “MTJ ...” in the “Settings” menu.
 - or –
 - Click on the “SET” icon.
 - The “Settings” dialog opens.

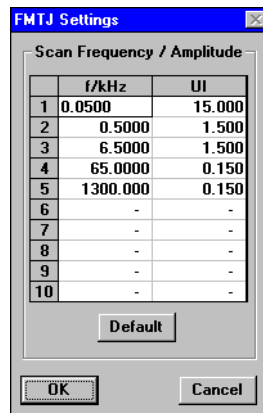

Fig. A-60 “FMTJ Settings” dialog

- 6. If required, select individual frequency and amplitude combinations to be used for performing the measurement.
- 7. Confirm your entries by clicking “OK”.
 - The “Settings” dialog closes.



- Click “Start” to start the measurement. The measurement stops automatically on completion or when you click on “Stop”.

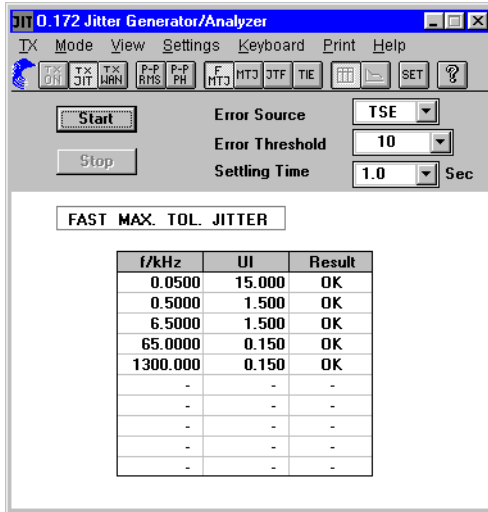

Fig. A-61 Fast MTJ measurements window

Analysis

- The table (see Fig. A-61) contains combinations of jitter frequencies and jitter amplitudes or default values specified by the user. Starting with the smallest frequency, they are set when the measurement is started.
- After the delay set with “Settling Time”, a check is made to determine if there are any alarms or errors in the input signal.
- According to the result, each setting is classified as “OK” or “Failed”.
- The measurement stops automatically when the last measurement point has been completed or by clicking on “Stop”.



14 Jitter Transfer Function (JTF)

To G.958, G.823, O.172

14.1 Test setup and description

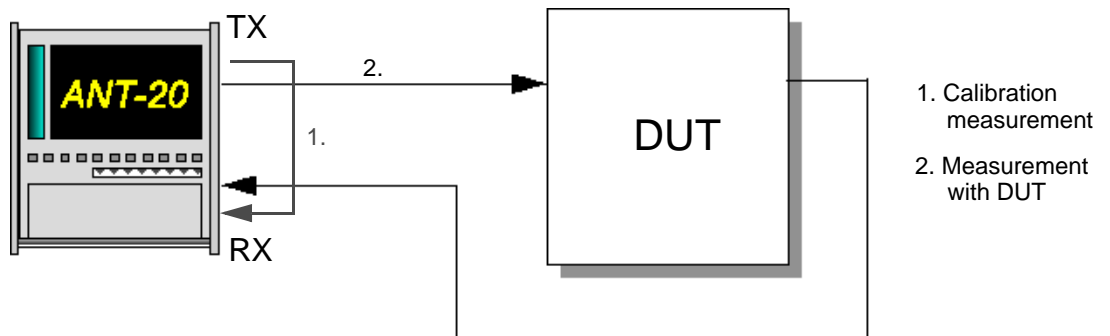

Fig. A-62 Jitter transfer function measurements setup

Interfaces

- electrical balanced Rx : [12] Tx : [13]
- electrical unbalanced Rx : [14] Tx : [15]
- optical 52, 155, 622 Mbit/s Rx : [17] Tx : [18]
- optical 2.5 Gbit/s Rx : [44] Tx : [47]

Jitter transfer function measurements are of particular importance when dealing with regenerative repeaters. Checks are carried out to demonstrate that the jitter gain of a regenerative repeater is below a predefined value. If this is not the case, “jitter runaway” occurs after several regenerative repeaters.

The jitter transfer function (JTF) is measured by applying a signal whose jitter is constant over frequency to the DUT. The jitter amplitude is selected so that the DUT can handle it at high frequencies.

The Jitter Analyzer measures the resulting jitter amplitude at the output of the DUT at various TX jitter frequencies. The log of the ratio gives the jitter gain or attenuation.

Tip: For maximum measurement accuracy, it is a good idea to make a calibration measurement before every JTF measurement (see Fig. A-62).



14.2 Application setting

VIs required

- Signal Structure
- O.172 Jitter Generator/Analyzer

1. Add the VIs required to the list of VIs used in the Application Manager.
The Application Manager should include at least the following instruments (see Fig. A-63).
2. Click on the “JIT” button to open the window for the O.172 Jitter Generator/Analyzer.



Fig. A-63 Minibar (Application Manager) after selecting the VIs

14.3 Measurement

Settings

- ✓ The “O.172 Jitter Generator/Analyzer” window has been opened already.
1. In the “Mode” menu, select the “JTF” command.
– or –
Click on the corresponding button in the tool bar.
 2. Select the appropriate range (1.6 UI or 20 UI; the range is pre-set for STM-16/OC-48) in the “RX: Range” box.
 3. Enter an appropriate delay time for the various measurements in the “Settling Time” field, so that the measurement starts after the DUT has settled.

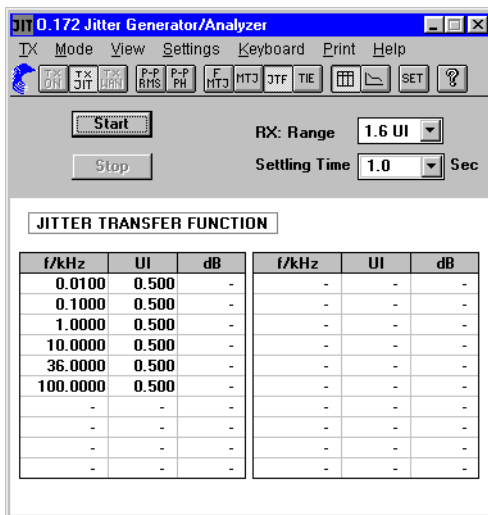

Fig. A-64 “O.172 Jitter Generator/Analyzer” window for JTF measurements



Dialog “JTF Settings”

Scan Frequency/Amplitude		Tolerance Mask						
	f/kHz	UI		f/kHz	UI	f/kHz	max.	min. dB
1	0.0100	1.000	11	-	-	0.0100	0.5	-99.9
2	0.1000	1.000	12	-	-	36.0000	0.5	-99.9
3	1.0000	1.000	13	-	-	100.0000	-8.4	-99.9
4	10.0000	0.360	14	-	-	-	-	-
5	36.0000	0.200	15	-	-	-	-	-
6	100.0000	0.200	16	-	-	-	-	-
7	-	-	17	-	-	-	-	-
8	-	-	18	-	-	-	-	-
9	-	-	19	-	-	-	-	-
10	-	-	20	-	-	-	-	-

Fixed Amplitude
 0.500 UI

Calibrate before every Measurement
 Use previous Calibration

RMS Integration Period: 1 Sec

Fig. A-65 Dialog “JTF Settings”

The measurement frequencies for the JTF measurement and the specifications for the tolerance mask are found here.

1. Select “JTF ...” in the “Settings” menu.
– or –
Click on the “SET” icon.
The “JTF Settings” dialog opens.
2. If required, select individual scan frequencies and amplitudes, as well as altered tolerance mask values.
3. If you want the measurement to be performed using a constant amplitude for all scan frequencies, check the “Fixed Amplitude” check box and enter the required amplitude in the box below it.
4. If you want to use the results of a previous MTJ measurement for the scan frequencies and amplitudes, click on the “MTJ Adaptation” button. The MTJ results are then automatically matched to the permissible ranges (measurement and frequency) of the jitter meter. If there are no MTJ results available, the button is grayed out.
5. Select whether you want to perform a calibration measurement before every JTF measurement or to use a single calibration measurement (stored internally). For maximum measurement accuracy, it is a good idea to make a calibration measurement before every JTF measurement
6. Click “Start” to start the measurement. The measurement stops automatically when finished or when you click “Stop”.



Analysis

The measurement results are displayed in three different windows. The default values for the scan frequencies and the tolerance masks in the "JTF-Settings" window are set in the window with the table display (see Fig. A-66).

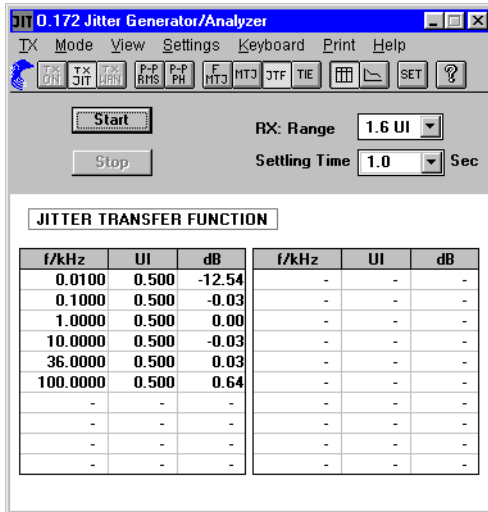

Fig. A-66 JTF measurements: results displayed as tables

- The default values depend on the bit rate and change automatically when the bit rate is changed.
- Measurement results are displayed in the table under "dB".
- Measurement results in the table that are outside the tolerance mask(s) are marked with an "!".

There are two graphics windows. The right window has the higher y-axis resolution. On the graph, the measurement values are marked with a "+".

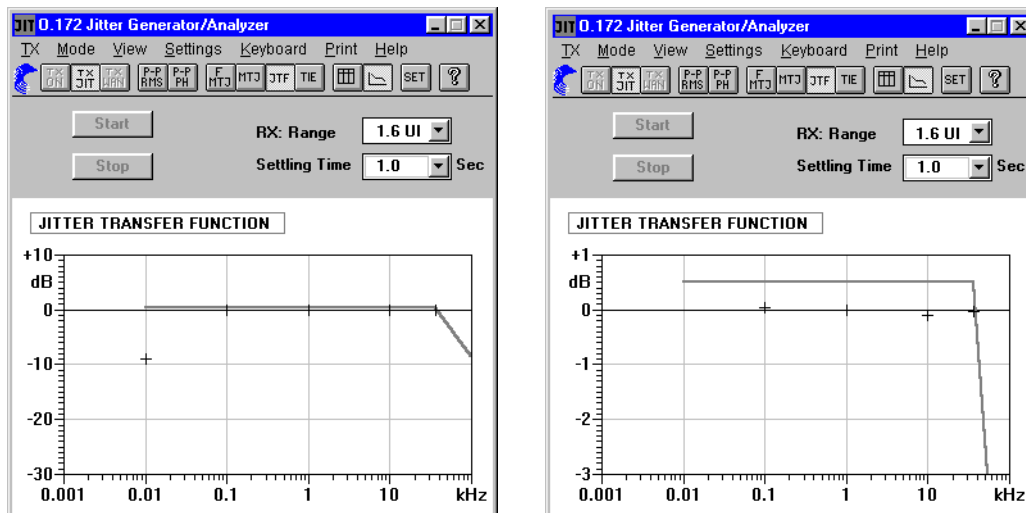

Fig. A-67 JTF measurements: result graphics with various resolutions



15 Phase Hit Measurement

15.1 Test setup and description



Fig. A-68 Phase hit measurement setup

Interfaces

- electrical balanced Rx: [12]
- electrical unbalanced Rx: [14]
- optical 52, 155, 622 Mbit/s Rx: [17]
- optical 2.5 Gbit/s Rx: [44]

Phase hits occur when a specific jitter threshold is exceeded. Events of this kind are recorded using a counter. The current counter reading indicates how often the phase hit threshold has been exceeded since the measurement was started.

Positive counts and negative counts can be made mutually with the ANT-20SE Jitter Analyzer.

15.2 Application setting

VIs required

- Signal Structure
- O.172 Jitter Generator/Analyzer

1. Add the VIs required to the list of VIs used in the Application Manager.
The Application Manager should at least include the following instruments (see Fig. A-69).
2. Click on the "JIT" button to open the "O.172 Jitter Generator/Analyzer" window.



Fig. A-69 Minibar (Application Manager) after selecting the VIs



15.3 Measurement

Settings

1. In the “Mode” menu select the “PP+PH” command.
 – or –
 Click on the corresponding button in the toolbar.
 The “O.172 Jitter Generator/Analyzer” window opens.

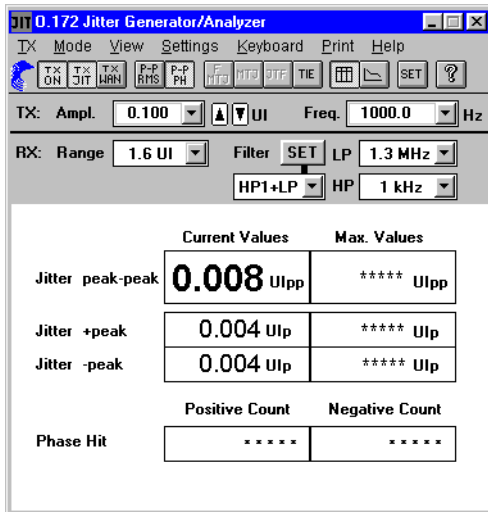

Fig. A-70 “O.172 Jitter Generator/Analyzer” window when the auto function is turned off

2. In the “Settings” menu click on the “General ...” command.
 – or –
 Click on the corresponding button in the tool bar.
 The “Jitter-General Settings” window opens.

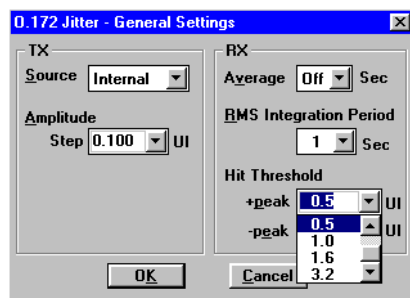

Fig. A-71 “Jitter - General Settings” dialog box

3. Enter the threshold values you want under “Hit Threshold” using the list fields.
4. Confirm with “OK”.
5. Start the measurement by
 - pressing function key F5 or
 - clicking on the “green traffic signal” icon in the Application Manager.

Input to the “Hit Threshold” can be made with the normal keyboard or with the “virtual” keyboard window.



Analysis

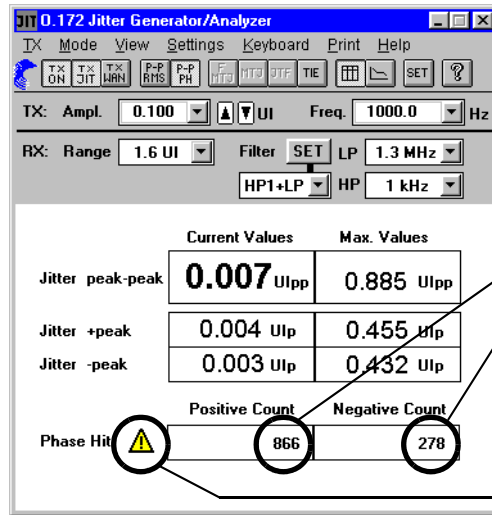

Current display of counted threshold transgressions

A phase hit measurement will be interrupted when synchronization or the AC line supply fails. The counters are stopped during the interruption. Counting continues as soon as the instrument re-synchronizes after the interruption. The yellow warning label indicates that the measurement was interrupted.

Fig. A-72 Phase hit measurement



16 Wander Generator

The Wander Generator is used to make manually tolerance to wander measurements conforming to ITU-T G.823, G.824, G.825, O.172 and ETSI EN302084.

16.1 Test setup and description

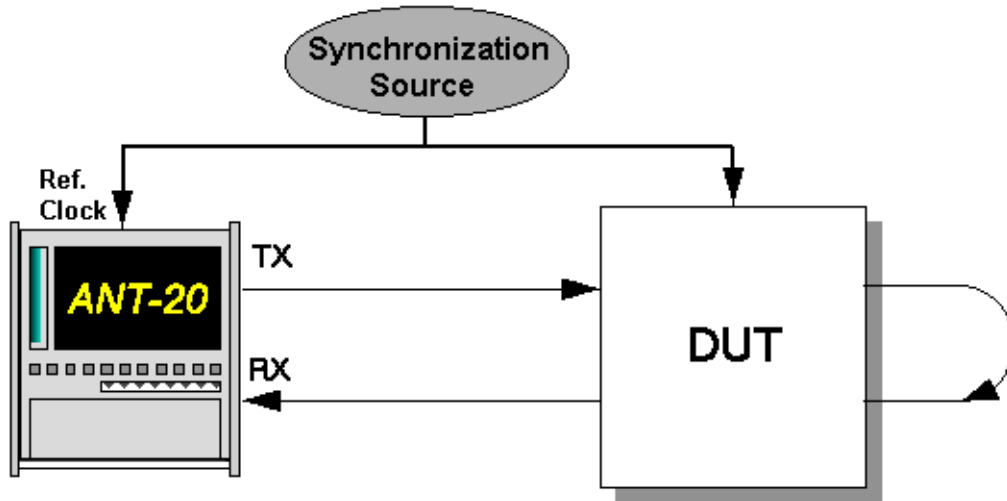

Fig. A-73 Test setup for tolerance to wander measurements

Interfaces

- electrical balanced Rx : [12] Tx : [13]
- electrical unbalanced Rx : [14] Tx : [15]
- optical 52, 155, 622 Mbit/s Rx : [17] Tx : [18]
- optical 2.5 Gbit/s Rx : [44] Tx : [47]
- Ref Clock in [25] Generator synchronization input; clock or data signal (2 Mbit/s or 1.5 Mbit/s)

16.2 Application setting

VIs required

- Signal Structure
- O.172 Jitter Generator/Analyzer
- Anomaly/Defect Analyzer

1. Add the VIs required to the list of VIs used in the Application Manager. The Application Manager should at least include the following instruments (see Fig. A-74).
2. Click on the "JIT" button to open the "O.172 Jitter Generator/Analyzer" window.
3. Click on the button to the right of the "JIT" button to open the "Anomaly/Defect Analyzer" window.



Fig. A-74 Minibar (Application Manager) after VI selection



16.3 Measurement

Settings

- ✓ The “O.172 Jitter Generator/Analyzer” window is already open.
- 1. Select the “Settings ...” command from the “Interface” menu in the “Signal Structure” window.
The “Interface” dialog opens.

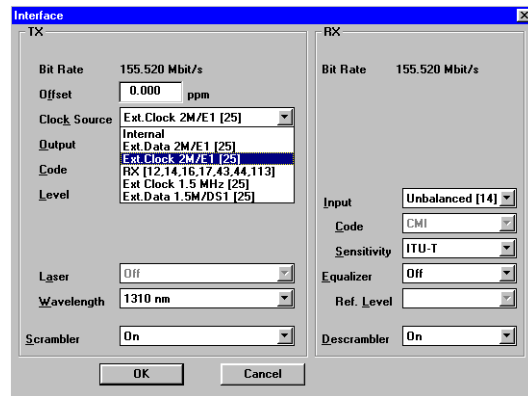

Fig. A-75 “Interface” dialog

- 2. Select the clock source corresponding to the clock frequency at input [25] on the TX side from the “Clock Source” list box.
- 3. Select the “Wander” command from the “TX” menu in the “O.172 Jitter Generator/Analyzer” window.
- 4. Set the TX amplitude and frequency according to the tolerance masks of the appropriate standard.
- 5. Select the “On” command from the “TX” menu.

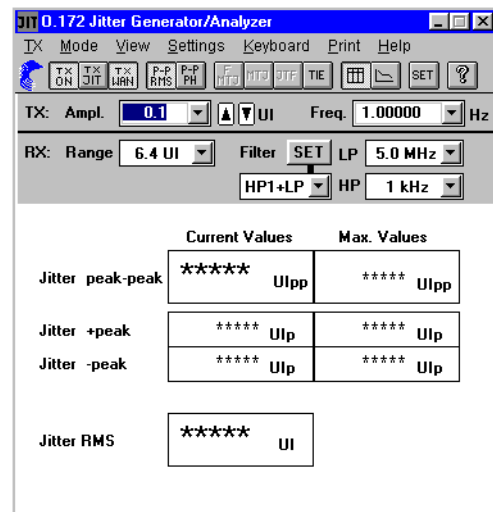

Fig. A-76 “O.172 Jitter Generator/Analyzer” window with wander generator activated



- In the Application Manager, select the "Settings ..." command from the "Measurement" menu.
The "Measurement Settings" dialog opens.

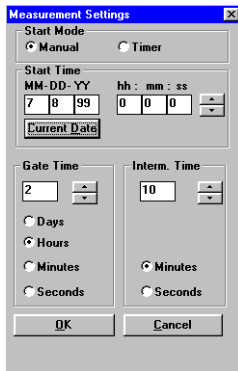

Fig. A-77 "Measurement Settings" dialog

- Enter the gate time required.
When setting the gate time, remember that the period time can be very long, depending on the wander frequency that you selected. Select the gate time such that it corresponds to at least one wander modulation period ($\hat{=} \frac{1}{f_{mod}}$).
- Start the measurement
 - by pressing function key F5, or
 - by clicking the "green traffic signal" icon in the Application Manager.

Analysis

The "Anomaly/Defect Analyzer" window indicates the wander frequency or wander amplitude above which errors or alarms occur.

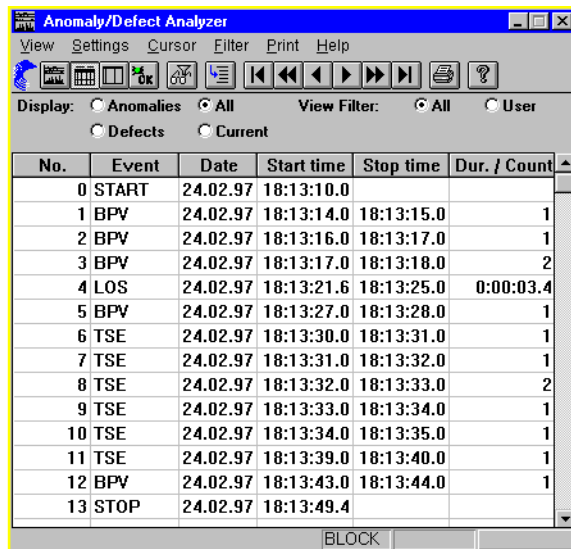

Fig. A-78 "Anomaly/Defect Analyzer" window



17 Wander Analysis to 2.5 Gbit/s

To G.811, G.812, G.813, G.823, G.824, G.825, O.172

17.1 Test setup and description

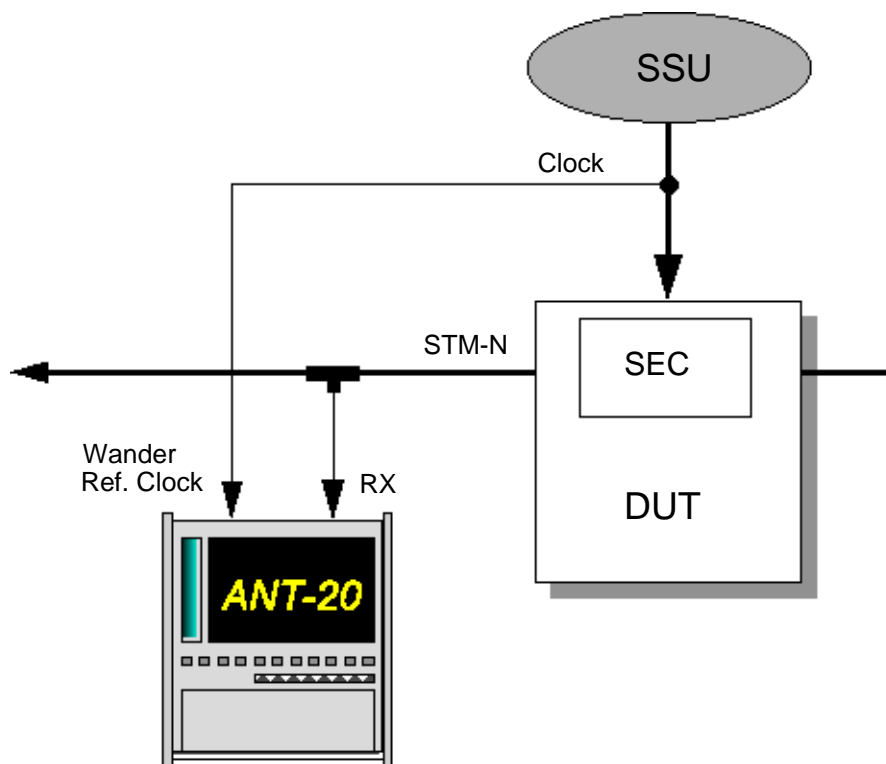

Fig. A-79 Wander measurements setup

Interfaces

- electrical balanced Rx : [12]
- electrical unbalanced Rx : [14]
- optical 52, 155, 622 Mbit/s Rx : [17]
- optical 2.5 Gbit/s Rx : [44]
- wander ref clock in [35] (to 622 Mbit/s)
[54] (2.5 Gbit/s)

Every SDH network element can make use of an internal clock (SEC-SDH Equipment Clock). This clock source is synchronized by means of an SSU (Synchronization Supply Unit) via a 2.048 MHz clock line. To check the quality of the internal clock source, the clock stability of the reference source (SSU) is compared with that of the transmitted data signal. The difference is referred to as wander.

The ANT-20SE can be used to perform measurements on all interfaces of the instrument.



17.2 Application setting

VIs required

- Signal Structure
- O.172 Jitter Generator/Analyzer

1. Add the VIs required to the list of VIs used in the Application Manager.
The Application Manager should at least include the following instruments (see Fig. A-80).
2. Click on the “JIT” button to open the window for the “O.172 Jitter Generator/Analyzer”.



Fig. A-80 Minibar (Application Manager) after selecting the VIs

17.3 Measurement

Settings

1. In the “Mode” menu select “TIE”.
– or –
Click on the “Wander” button in the toolbar.
The wander display appears in the “O.172 Jitter Generator/Analyzer” window.

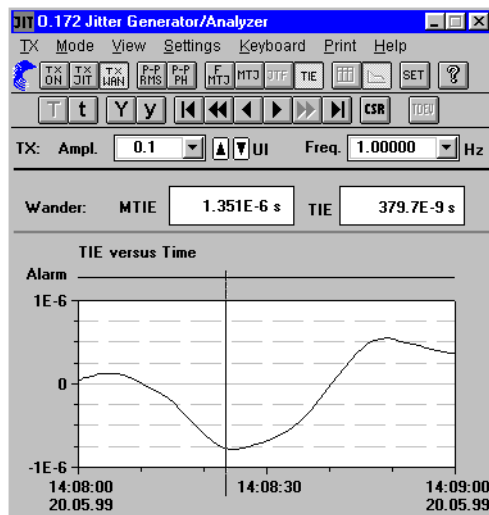

Fig. A-81 “O.172 Jitter Generator/Analyzer” window with wander display

2. In the “Settings” menu select “Wander ...”.
– or –
Click on the “SET” icon in the toolbar.
Set the reference clock frequency in this window.

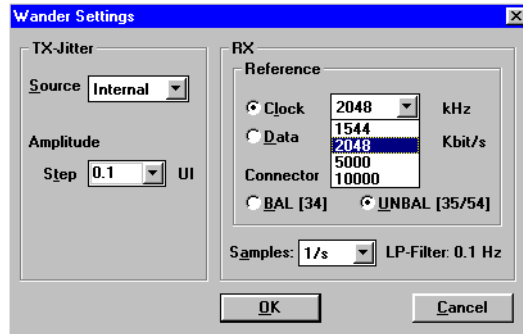

Fig. A-82 "Wander Settings" dialog

3. In the "Wander Settings" dialog, set the frequency or bit rate (not for 2488 Mbit/s) of the reference signal.
4. Select the reference signal input required (BAL [34] or UNBAL [35]) (not for 2488 Mbit/s).
5. Select the sample rate required. The low-pass filter is set automatically.
6. Click "OK" to confirm.
7. Start the measurement by
 - pressing function key F5 or
 - clicking on the "green traffic signal" icon in the Application Manager.

Wander analysis

Wander analysis involves measurements that take a particularly long time. Measurement intervals up to 99 days can be set on the ANT-20SE.

The measured values are displayed in the "O.172 Jitter Generator/Analyzer" window as a graph of the TIE values and numerically in the MTIE and TIE fields above.

⇒ Click on the "CSR" button in the toolbar.

The "Cursor Position" window then opens. This gives you an overview of the current values on the curve which is being recorded.

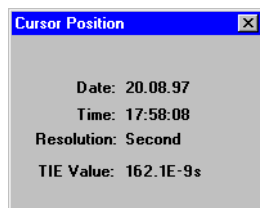

Fig. A-83 "Cursor Position" window

Storing results

1. Select the "Export ..." command in the "Print" menu.
The "Save as" dialog box is opened.
2. Select the target directory, under the current file shall be stored and set the "CSV" format.
3. Click on "Ok" to start exporting.



Analysis for MTIE and TDEV (BN 3035/95.21)

The “MTIE/TDEV Analysis” software (option BN 3035/95.21) is available for precise time-domain analysis of MTIE and TDEV. The program can be started from the “O.172 Jitter Generator/Analyzer” or separately from the ANT-20SE software. The program evaluates TIE values that were measured using an ANT-20SE. The evaluations follow the recommendations set out in ETSI ETS 300462, EN 302084, ITU-T G.811, G.812, G.813 and ANSI T1.101, and include the masks for the various signal sources.

Starting the “MTIE/TDEV Analysis” program from the “O.172 Jitter Generator/Analyzer”

1. Click on the “TDEV” button in the “O.172 Jitter Generator/Analyzer” (wander side) window. The program starts and the TIE data from the previous measurement (stored in the file “WANDMSEC.BIN”) are loaded automatically. The TIE data are displayed in the graphics box of the “TIE analysis” window.
2. Click on the “MTIE/TDEV ...” button. The “MTIE analysis” window opens (see Fig. A-84).
3. Click on the “Analysis” button in this window. The values are calculated and displayed.

Starting the “MTIE/TDEV Analysis” program from the Windows 95 Start menu

1. Click on the appropriate item in the Windows 95 “Start” menu. The program starts.
2. Click on the “Load” button. The “Load data file” dialog opens.
3. Select the “WANDMSEC.BIN” file from the “C:\ANT20\RESULTS” directory.
– or –
Select a previously exported CSV format file. The TIE data are displayed in the graphics box of the “TIE analysis” window.
4. Click on the “MTIE/TDEV ...” button. The “MTIE analysis” window opens (see Fig. A-84).
5. Click on the “Analysis” button in this window. The values are calculated and displayed.

Possible evaluations

- The check boxes at the lower left of the “MTIE analysis” window are used to select the values that you want to display.
- You can limit the number of measurement points to be displayed by entering a range in the “Analysis range” text boxes.
- You can select different tolerance masks from the “Masks” list box. These can be used to give you a quick impression of whether the measured values meet the tolerance requirements or not.
- The displayed graph can be printed out (“Print” button) and exported (“Export” menu).

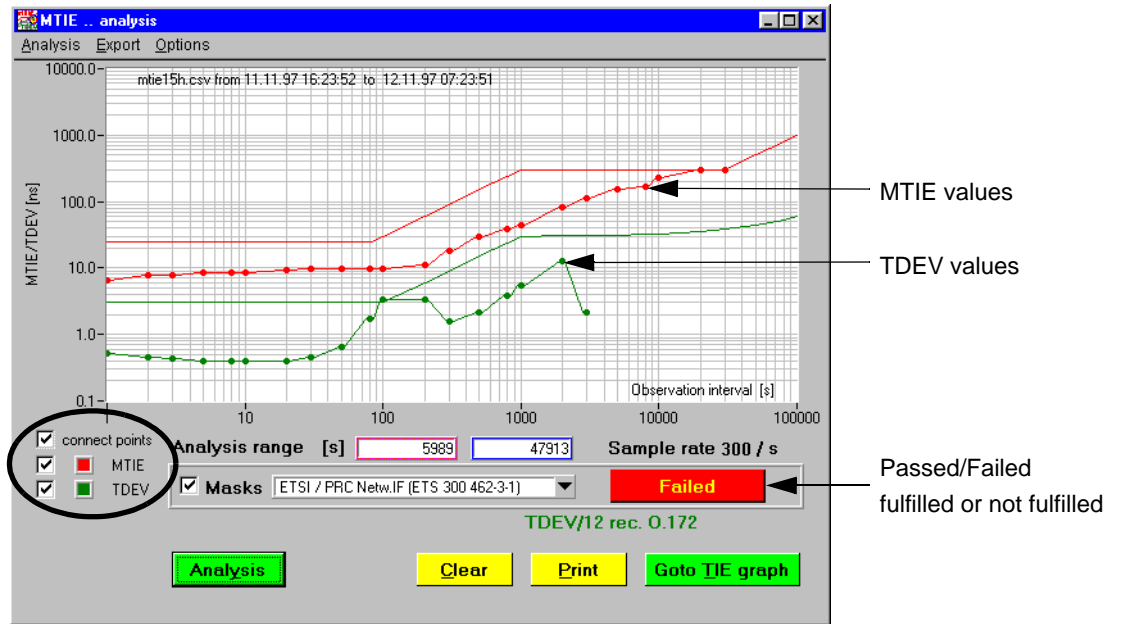

Fig. A-84 MTIE and TDEV analysis



18 Maximum Tolerable Wander (MTW)

The Maximum Tolerable Wander (MTW) function is used to perform automatic measurements of wander tolerance conforming to ITU-T G.823, G.824, G.825 and O.172 and ETSI EN302084.

18.1 Test setup and description

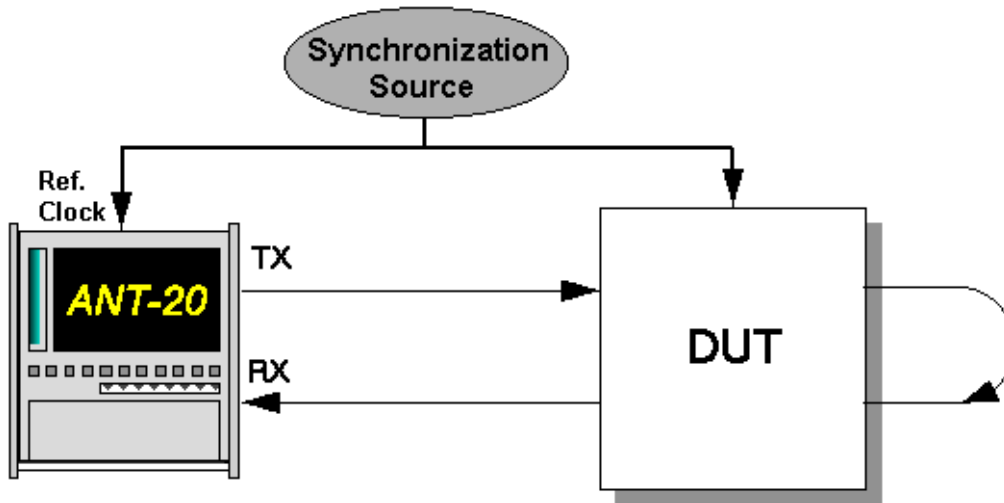

Fig. A-85 Test setup for measuring maximum tolerable wander

Interfaces

- electrical balanced Rx : [12] Tx : [13]
- electrical unbalanced Rx : [14] Tx : [15]
- optical 52, 155, 622 Mbit/s Rx : [17] Tx : [18]
- optical 2.5 Gbit/s Rx : [44] Tx : [47]
- Ref Clock in [25] Generator synchronization input; clock or data signal (2 Mbit/s or 1.5 Mbit/s)

18.2 Application settings

VIs required

- Signal Structure
- O.172 Jitter Generator/Analyzer

1. Add the VIs required to the list of VIs used in the Application Manager.
The Application Manager should include at least the following instruments (see Fig. A-86).
2. Click on the "JIT" button to open the window for the O.172 Jitter Generator/Analyzer.



Fig. A-86 Minibar (Application Manager) after selecting the VIs



18.3 Measurement

Settings

- ✓ The “O.172 Jitter Generator/Analyzer” window must already be open.

Settings in the “Interface” dialog of the “Signal Structure” window

1. Select the “Settings ...” command from the “Interface” menu in the “Signal Structure” window.

The “Interface” dialog opens.

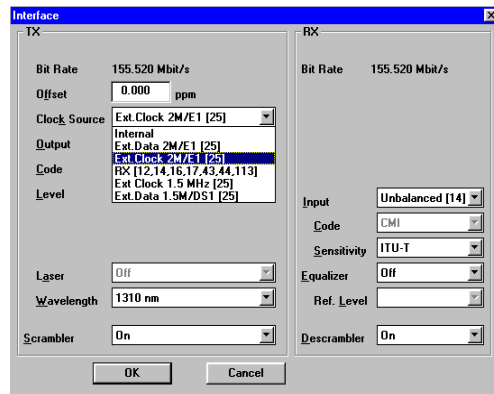

Fig. A-87 “Interface” dialog

2. Select the clock source corresponding to the clock frequency at input [25] from the “Clock Source” list box on the TX side of the box.

Settings in the “O.172 Jitter Generator/Analyzer” window

1. Select the “Wander” command from the “TX” menu in the “O.172 Jitter Generator/Analyzer” window.
 - or –
 - Click on the “TX WAN” icon in the toolbar.
2. Select the “MTW” command from the “Mode” menu.
 - or –
 - Click on the “MTW” icon in the toolbar.

Note: The MTW function can only be activated if you first set the generator to wander (TX WAN).

The generator must be set back to jitter (TX JIT) if you want to use other automatic jitter measurement functions (MTJ, F-MTJ, JTF) after making a MTW measurement.

3. Select the error source (e.g. TSE, Test Sequence Error) in the “Error Source” list box.
4. In the “Error Threshold” box, enter the error threshold above which the result will be assessed as “Failed”.
 - An error threshold cannot be entered if an alarm was selected in the “Error Source” box.
5. In the “Settling Time” box, enter the delay between individual measurement points.
6. Select the “MTW” command from the “Settings” menu.
 - or –
 - Click on the “SET” icon in the toolbar.

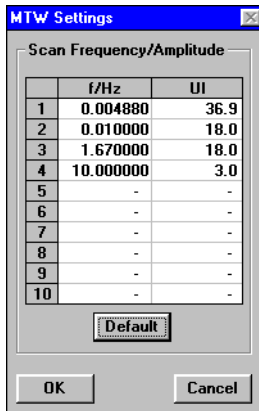

Fig. A-88 "MTW Settings" dialog

7. If required, select your own combinations of frequency and amplitude to be used for the measurement.
8. Click "OK" to confirm your entries.
The "MTW Settings" closes.
9. Click "Start" to start the measurement. The measurement stops automatically after all measurement points have been tested. It can also be stopped at any time by clicking on "Stop".

Note: The measurement times may be very long due to the frequency settings.

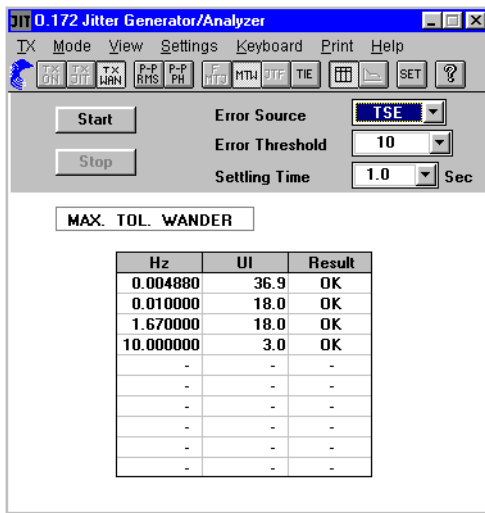

Fig. A-89 "O.172 Jitter Generator/Analyzer" window for MTW measurements

Analysis

- The table (see Fig. A-89) contains combinations pre-selected by the user or the default values for wander frequencies and wander amplitudes. These are set one after the other in the order they are entered in the table when the measurement is started.
- After the "Settling Time" has elapsed, the output signal of the ANT-20SE is modulated for one period of the current frequency and the input signal is monitored for the presence of alarms or errors.
- Depending on the result, each setting will be indicated as "OK" or "Failed".
- The measurement stops automatically when the last measurement point has been tested. It can also be stopped at any time by clicking on "Stop".



19 Consecutive Identical Digit (CID) Test to G.783, Appendix X

19.1 Test setup and description

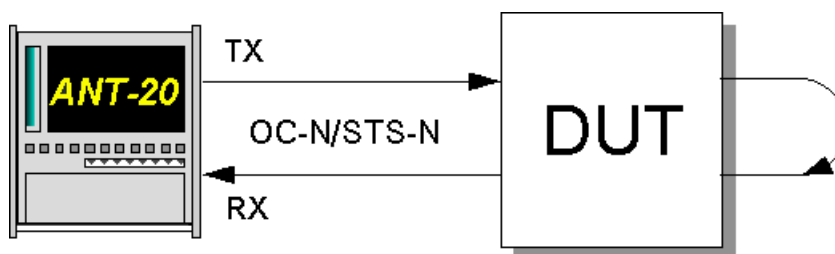

Fig. A-90 Test setup for consecutive identical digit tests

Interfaces

- electrical unbalanced Rx : [14] Tx : [15]
- optical 52, 155, 622 Mbit/s Rx : [17] Tx : [18]
- optical 2.5 Gbit/s Rx : [44] Tx : [47] (1550 nm)
Tx : [48] (1310 nm)
- optical 10 Gbit/s Rx : [113] Tx : [103]

SDH network elements must operate without errors even when long sequences occur in which the bit state remains the same (all zeros or all ones sequences). The Recommendations G.958 and G.783 stipulate that a network element must be able to cope with a bit sequence of zeros or ones of a length of at least 72 bits (9 bytes) without errors. The tolerance of a network element to all zeros or all ones sequences is known as consecutive identical digit (CID) immunity.

A method for testing the CID immunity of network elements is suggested in Appendix X of the 1999 revision of ITU-T Recommendation G.783: The bytes in columns 7, 8 and 9 of the first row of the SOH / TOH are filled with an all zeros or all ones signal. The J0 byte, i.e. byte S(1,7,1), is not changed, since it contains the path trace information.

The maximum number of overhead bits that can contain the all ones or all zeros signal depends on the signal structure:

Signal structure	Maximum number of zero or one bits
STM-4/OC-12	88 (= 11 bytes)
STM-16/OC-48	376 (= 47 bytes)
STM-64/OC-192	1528 (= 191 bytes)

Table G-2 Maximum lengths of all zeros or all ones sequences

To assist you in setting these CID overhead patterns, a number of example applications are supplied along with the ANT-20 Software. The applications are found on the ITU-T or ANSI Application Disk.



There is an application for each of the above signal structures, which sets an all ones signal with a length of 72 bits. There is also an application which sets the maximum number of ones indicated in the above table for each of the signal structures.

The applications have the following names:

ANSI	SONET
<ul style="list-style-type: none"> • W&G STM-4 VC4 16c 72 bit CID • W&G STM-4 VC4 16c 88 bit CID • W&G STM-16 VC4 16c 72 bit CID • W&G STM-16 VC4 16c 376 bit CID • W&G STM-64 VC4 16c 72 bit CID • W&G STM-64 VC4 16c 1528 bit CID 	<ul style="list-style-type: none"> • W&G OC-12 1SPE 72 bit CID • W&G OC-12 1SPE 88 bit CID • W&G OC-48 3c 72 bit CID • W&G OC-48 3c 376 bit CID • W&G OC-192 3cSPE 72 bit CID • W&G OC-192 3cSPE 1528 bit CID

Table G-3 Applications for CID tests

When you invoke one of these applications, the bytes in columns 7 to 9 of SOH #1 through #N are set to the value "FF" (all ones) instead of the default value (AA). The J0 byte remains unchanged.

If you require CID sequences of other lengths (e.g. for other signal structures), you can generate these using the ANT-20 "Overhead Generator" VI.

To load one of the applications:

- ✓ The Application Manager is on top.
- 1. Click on the "Open" command in the "Application" menu.
The "Open Application" window opens.
- 2. Click on the application in the list box that you want to use.
The item will be highlighted in gray.
- 3. Click on the "OK" button.
The selected application will be loaded and the ANT-20 is ready to make measurements.



20 Setting the ATM signal structure

20.1 Test setup and description

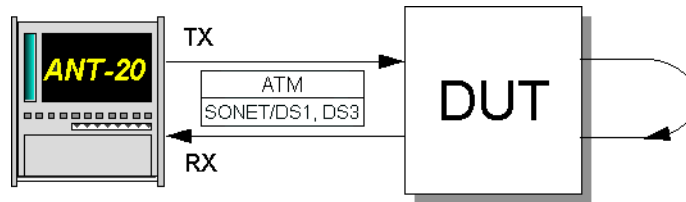

Fig. A-91 ATM signal structure test setup

Interfaces

- | | | |
|-------------------------------|-----------|--|
| • electrical balanced | Rx : [12] | Tx : [13] |
| • electrical unbalanced | Rx : [14] | Tx : [15] |
| • optical 52, 155, 622 Mbit/s | Rx : [17] | Tx : [18] |
| • optical 2.5 Gbit/s | Rx : [44] | Tx : [47] (1550 nm)
Tx : [48] (1310 nm) |

To perform an ATM measurement with the ANT-20SE, you must first select the corresponding signal structure. This section describes the step-by-step procedure for this with the aid of an example.

20.2 Application settings

VIs required

- Signal Structure
- ATM Signal Structure

1. Add the VIs required to the list of VIs used in the Application Manager.
The Application Manager should include at least the following instruments (see Fig. A-92).
2. For the following settings click on one of the buttons (minibar) to bring the desired window on top.



Fig. A-92 Minibar (Application Manager) after selecting the VIs

Example

ATM signal structure with STS-3 / STS-3c SPE ATM mapping, electrical interface

Setting the physical layer (“Signal Structure” VI)

- ✓ The “Signal Structure” window is activated. The display area shows the current signal structure.
1. Select “Signal Structure...” from the “Edit” menu.
– or –
Click on the corresponding icon in the Application Manager.



The “Signal Structure Editor” dialog opens (see Fig. A-93).



Fig. A-93 Displaying and setting the signal structure to ANSI standard

2. Select the interface by clicking the “Electric” button.
3. Set the required signal structure:
 - the SONEt signal, by clicking the “STS3” button
 - the mapping structure, by clicking the “STS3c SPE” and “ATM” button.
4. Confirm your settings by clicking on the “OK” button.
The display area shows the new signal structure.

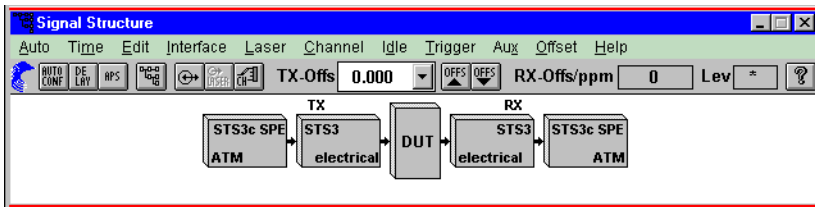

Fig. A-94 Physical layer signal structure (“Signal Structure” VI)

Setting the ATM / AAL layers (“ATM Signal Structure” VI)

✓ The “ATM Signal Structure” window is activated. The display area shows the current ATM signal structure.

1. Select “ATM Signal Structure...” from the “Edit” menu.
 - or –
 - Click on the corresponding icon in the toolbar.
 The “ATM Structure” dialog opens (see Fig. A-95).

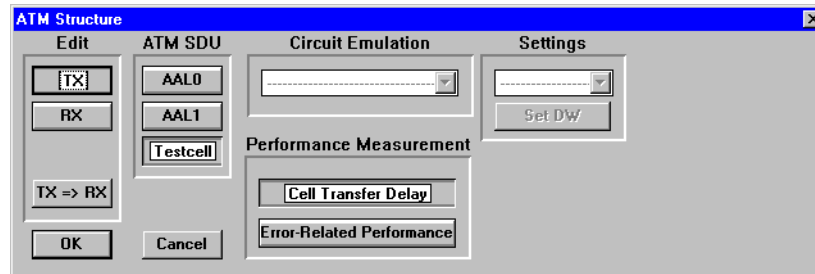

Fig. A-95 “ATM Structure” dialog (“ATM Signal Structure” VI)



2. Select the ATM SDU to be transmitted and received in the test channel:
 - Testcell: Test cells to O.191
 - AAL-0: PRBS or DW in cell payload
 - AAL-1: PRBS or DW as AAL-1 PDU
3. Select the “Performance Measurement” to be used:
 - Cell Transfer Delay Results shown in ATM Traffic Analyzer, and
 - Error Related Performance Results shown in Anomaly and Defect Analyzer
4. Confirm your settings by clicking on the “OK” button.
The “ATM Structure” dialog will be closed.

Setting the VPI/VCI parameters

- ✓ The “ATM Signal Structure” window is activated.
1. Select “ATM Channel...” from the “Channel” menu.
 - or –
 - Click on the corresponding icon in the toolbar.
 - The “ATM Channel” dialog opens.

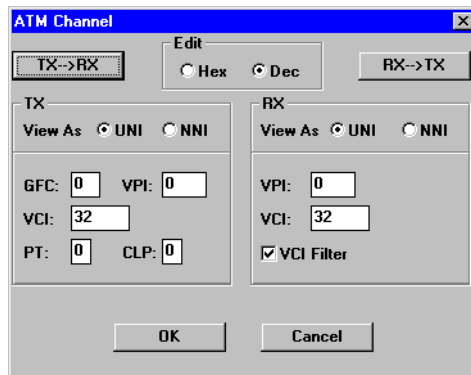

Fig. A-96 The “ATM Channel” dialog (“ATM Signal Structure” VI)

2. Enter the VPI/VCI parameters of the test connection for the generator and receiver.
3. Confirm your entries by clicking on the “OK” button.
4. The “ATM Channel” dialog will be closed.
The desired ATM signal structure appears in the display area of the “ATM Signal Structure” VI.

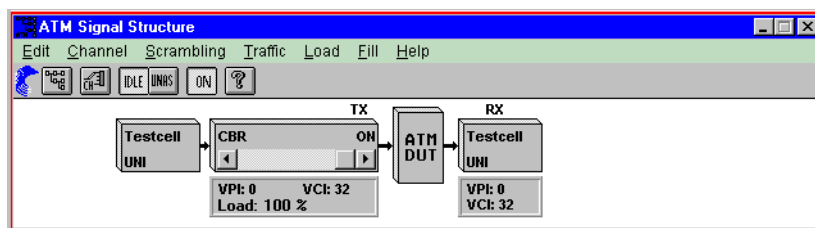

Fig. A-97 ATM layer signal structure (“ATM Signal Structure” VI)

- Click on the “ON” icon in the “ATM Signal Structure” VI to activate ATM traffic and the selected test cells are transmitted. If this channel is not active, empty cells will be transmitted.
- The default setting of the ATM Generator is:
 - Traffic type: CBR (constant bit rate)
 - 100% load



21 ATM bit error rate test (ATM-BERT)

BN 3035/90.70 only

21.1 Test setup and description

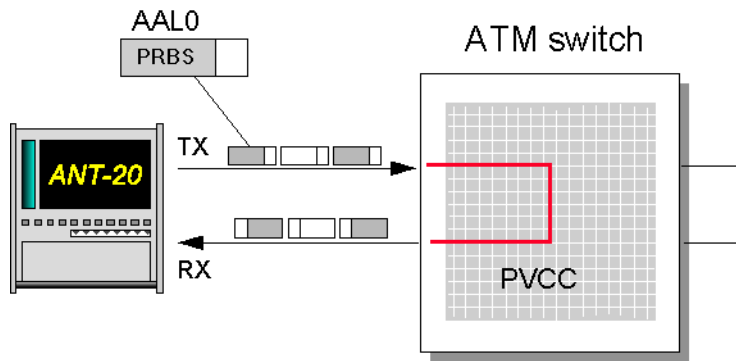

Fig. A-98 Setup for the ATM bit error rate test

For ATM networks too the bit error test is a basic measurement method that makes it possible to test network paths quickly and simply or to check configurations of network elements. With the ANT-20SE, you measure the bit errors via a test cell channel. Apart from bit error measurements on the cell payload, parallel measurements for correctable and non-correctable header errors are also being performed. If this error measurement is performed on cells with an AAL-1 structure, the ANT-20SE also simultaneously checks the cell sequence integrity so that cell losses can also be found.

21.2 Switch configuration

⇒ Set up an unidirectional, permanent connection with a UBR (Unspecified Bit Rate) contract through the switch.

21.3 Application selection on the ANT-20SE

VIs required

- Signal Structure
- ATM-Signal Structure
- Anomaly and Defect Insertion
- Anomaly and Defect Analyzer

⇒ Add the VIs required to the list of VIs used in the Application Manager..

The Application Manager should include at least the following instruments (see Fig. A-99).



Fig. A-99 Minibar (Application Manager) after selecting the VIs



21.4 Measurement

Example 1

Determining the bit error rate in the ATM layer.

Settings

1. First of all, set the Signal Structure VI as described.
2. Open the ATM Signal Structure VI.
3. In the "Edit" menu select the item "ATM Structure...".
 - or –
 - Click on the corresponding button in the toolbar.
 - This activates the "ATM Structure" window.
4. In the "ATM SDU" field press the button "AAL0" and confirm with "OK".
5. Start the measurement by pressing function key F5.
 - or –
 - Click the "green traffic signal" icon in the Application Manager.

Analysis

Using the Anomaly and Defect Analyzer VI, you can observe whether errors are occurring or not. In the example below, HUNC (Header error UNCorrectable) errors occur.

Code	Total Results		Intermediate Results	
	Count	Rate	Count	Rate
FAS-STM	0	*	0	*
B1	0	*	0	*
B2/SUM	0	*	0	*
MS-REI	0	*	0	*
AU-PJE	0	*	0	*
AU-NDF	0	*	0	*
B3	0	*	0	*
HP-REI	0	*	0	*
HUNC	27	1.00E-06	3	1.33E-06
HCOR	0	*	0	*
CER	0	*	0	*
CLR	0	*	0	*
CMR	0	*	0	*

Fig. A-100 "Anomaly and Defect Analyzer" window



Example 2

Insertion of a HCOR at a repetition rate of 1E-6 with analysis of the DUT reaction.

Settings

Do not change the settings of the VIs Signal Structure and ATM Signal Structure. The VI Anomaly and Defect Insertion must be reset.

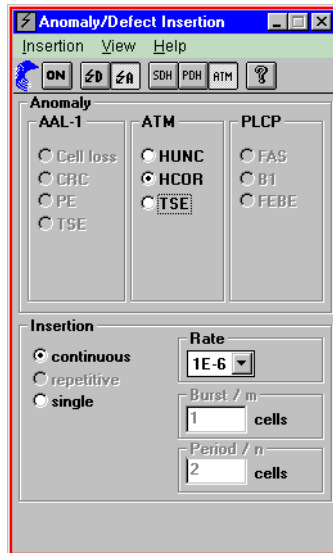

Fig. A-101 “Anomaly and Defect Analyzer” window

1. In the “View” menu select the items “Anomalies” and “ATM”.
– or –
Click the appropriate icons on the toolbar.
2. Mark the item “HCOR” in the “ATM” field.
3. Select the item “continuous” in the “Insertion” field.
4. Set a “Rate” of 1E-6 in the selection field.
5. In the insertion menu, select the item “ON”.
– or –
Confirm by clicking the “ON” button on the toolbar.
6. Start the measurement by pressing function key F5.
– or –
Click on the “green traffic signal” icon in the Application Manager.

Analysis

You can observe the effect of the inserted error in the window of the Anomaly and Defect Analyzer VI. There is a choice of four different windows to display the result.



Code	Total Results	Intermediate Results
FAS-STM	0	0
B1	0	0
B2	0	0
MS-REI	0	0
AU-PJE	0	0
AU-NDF	0	0
B3	0	0
HP-REI	0	0
HUNC	0	0
HCOR	0	0
TSE	1643	306

Fig. A-102 Table display

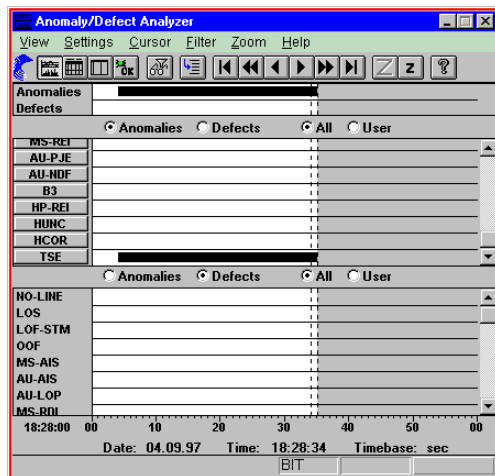

Fig. A-103 Histogram display

No.	Event	Date	Start time	Stop time	Dur. / Count
26	TSE	04.09.97	18:28:29.0	18:28:30.0	56
27	TSE	04.09.97	18:28:30.0	18:28:31.0	56
28	TSE	04.09.97	18:28:31.0	18:28:32.0	55
29	TSE	04.09.97	18:28:32.0	18:28:33.0	56
30	TSE	04.09.97	18:28:33.0	18:28:34.0	55
31	TSE	04.09.97	18:28:34.0	18:28:35.0	28
32	STOP	04.09.97	18:28:34.5		

Fig. A-104 Single-value display

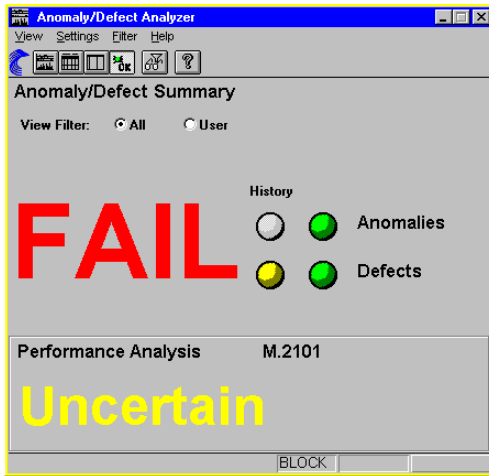

Fig. A-105 Summary display



22 ATM latency test for ATM switches

BN 3035/90.70 only

22.1 Test setup and description

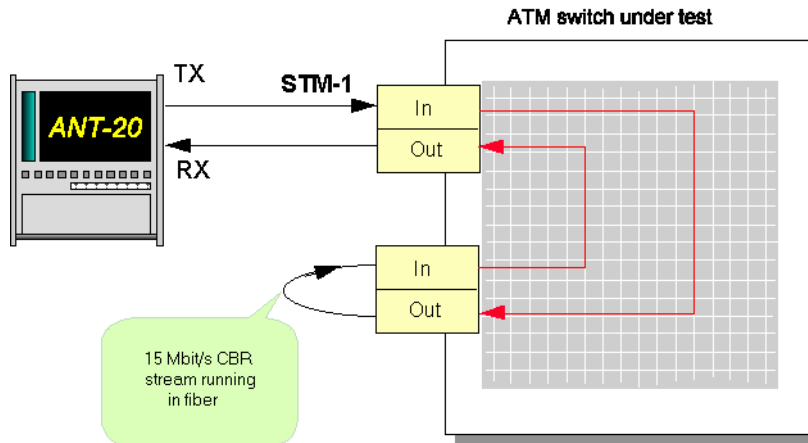

Fig. A-106 Setup for ATM latency test (ATM switch)

If the above configuration is used, the more port modules that are included the loop, the greater the delay. Measurements are made on ATM switches to determine whether there is a constant increase in delay as the number of looped-in port modules are increased.

22.2 Switch configuration

1. Set up an unidirectional connection with a constant bit rate through the switch for the reason that you can set up a physical loop at the second port.
2. Check that the switch accepts the PCR of 14.98 Mbit/s (35523 cells per second).
3. Set the CBR contract, say, to a PCR of 15 Mbit/s.

22.3 Application selection on the ANT-20SE

VIs required

- Signal Structure
- ATM Signal Structure
- ATM Traffic Analyzer

⇒ Add the VIs required to the list of VIs used in the Application Manager.

The Application Manager should include at least the following instruments (see Fig. A-107).



Fig. A-107 Minibar (Application Manager) after selecting the VIs



22.4 Measurement

Settings

Signal Structure VI

⇒ First of all, set the Signal Structure VI as described.

ATM Signal Structure VI

1. Open the ATM Signal Structure VI.
2. In the “Edit” menu select the item “ATM Structure...”.
 - or –
 - Click on the corresponding button in the toolbar.
 - This activates the “ATM Structure” window.
3. In the “ATM SDU” field select the “Testcell” test channel structure. (“Tx => Rx”).
4. Activate the “Cell Transfer Delay” button in the “Performance Measurement” field.
5. In the “Channel” menu select “ATM Channel...”.
 - or –
 - Click on the corresponding button in the toolbar.
 - The “ATM Channel” dialog box opens.

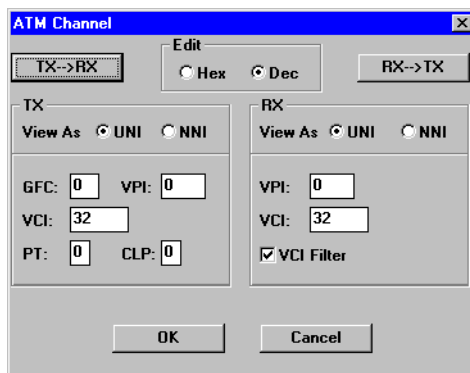

Fig. A-108 “ATM Channel” dialog box of the “ATM Signal Structure” VI

6. In the “Channel” dialog box, enter your VPI/VCI parameters for the transmitter and receiver and confirm with “OK”.
7. Transfer the send-side (Tx) settings in the “ATM Signal Structure” window to the receive side (Rx), by clicking the “Tx=>Rx” button.
8. Using the slider, set a load of 10% or 14.98 MBit/s in the displayed signal structure.
9. Confirm your entries with “OK”.
 - The selected ATM signal structure is now activated.
10. Click on the “ON” button on the toolbar.
 - The test channel is now connected and test cells are being sent.
 - In the off-state, the transmitter outputs empty cells only.

ATM Traffic Analyzer VI

1. Open the ATM Traffic Analyzer VI.
2. In the “View” menu select “Cell Transfer Delay”.
 - or –
 - Click on the “CTD” icon button on the toolbar.
 - The display changes to “Cell Transfer Delay”.



3. Set the measurement interval in the "Cell Transfer Delay Setup" dialog box.
4. Activate "Cell Transfer Delay..." in the "Settings" menu.
 - or –
 - Click on the "SET" icon button.

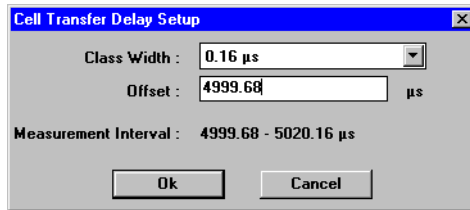

Fig. A-109 "Cell Transfer Delay Setup" dialog box

Application Manager VI

- ⇒ Start the measurement:
 - Press function key F5.
 - or –
 - Click the "green traffic signal" button in the Application Manager.

Explanation of the parameters "measurement interval", "class width" etc.

A **measurement interval** is always divided into 128 **classes**. This means that, say, a measurement interval of 1310 μs gives a time per class of 10 μs ($1310 \mu\text{s} / 128 = 10.23 \mu\text{s}$). The number of test cells whose delay lies within a class is summed and displayed as a bar. If you increase the class width, you automatically increase the measurement interval. As a result, you also automatically reduce the resolution of the histogram.

Use **Offset** to obtain the smallest possible classes when the delays are large. Offset allows you to shift your measurement range. But you have to estimate the expected range of your results. Offset selection is **not** automatic.

Analysis

The results are displayed in the form of a histogram on the "ATM Traffic Analyzer" VI. There is a bar for each class that contains at least one cell.

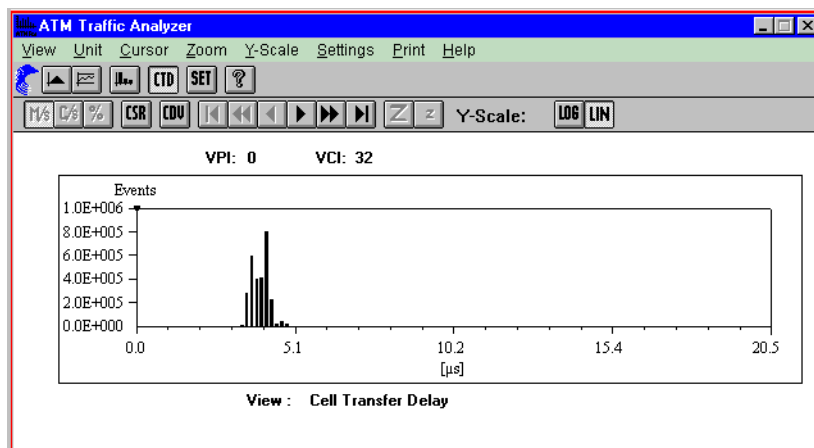

Fig. A-110 Result display in the "ATM Traffic Analyzer" window



Cursor read-off

⇒ Click the “CSR” icon on the toolbar.

The window shown below opens and displays the numerical value indicated by the cursor.

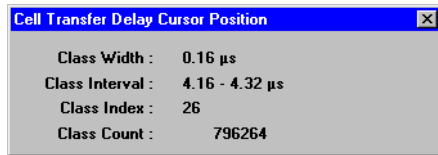

Fig. A-111 “Cell Transfer Delay Cursor Position” display window on the ATM Traffic Analyzer

The cell delay variation (CDV) can be determined in the “Cell Transfer Delay” display mode. The peak-to-peak CDV can be derived from the histogram. The peak-to-peak CDV corresponds to the 2-point cell delay variation to ITU-T I.356. The following results are provided by the CDV evaluation mode:

- the minimum cell delay
- the maximum cell delay
- the mean cell delay
- the 2-point cell delay variation (2-point CDV)

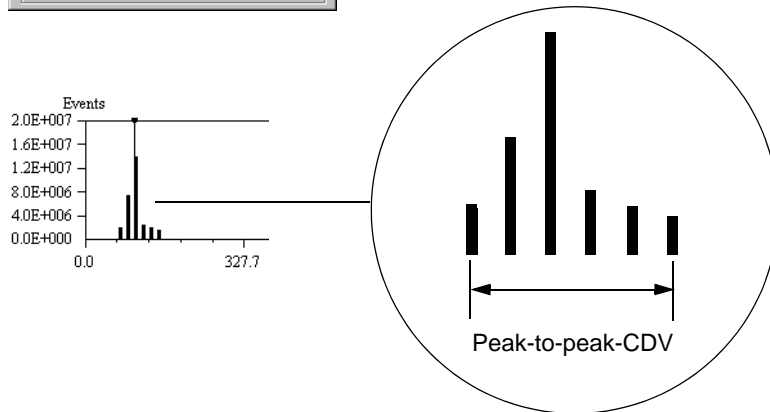
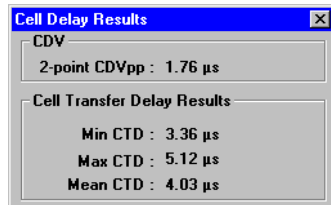

Fig. A-112 “Cell Delay Results” display window on the ATM Traffic Analyzer and definition of the peak-to-peak CDV



23 ATM latency test with background load (ATM Background Generator)

BN 3035/90.70 only

23.1 Test setup and description

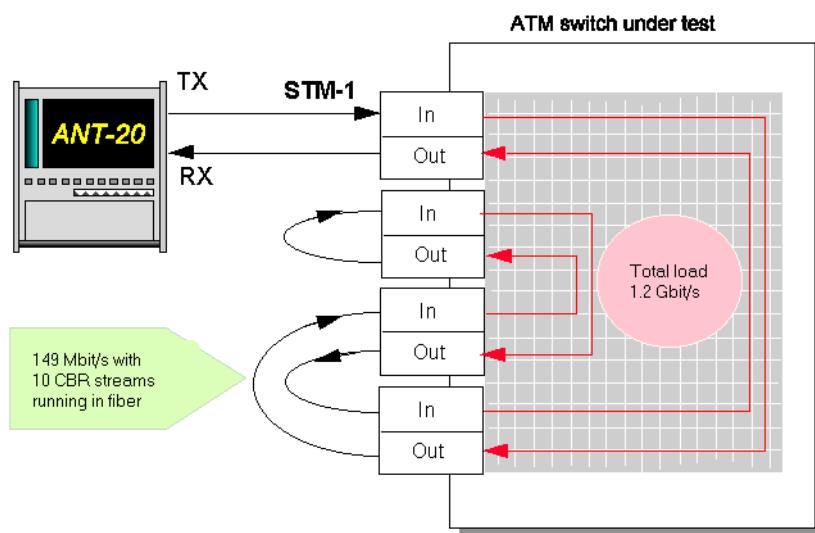

Fig. A-113 Setup for the ATM latency test (ATM switch) with background load

This test is performed to determine the extent to which the cell transit time through an ATM switch goes up when the switch loading is increased by connection requests. The result from the "ATM Latency Test for ATM switch" measurement is used as the reference. To perform this measurement, you must first set up the switch configuration as shown above.

23.2 Switch configuration

1. As shown above, set up two bidirectional connections with a constant bit rate via four port modules in the ATM switch.
2. Check that the switch accepts the PCR of 149.76 Mbit/s (353209 cells per second), e.g. CBR contract: PCR = 15 Mbit/s.

23.3 Application selection on the ANT-20SE

VIs required

- Signal Structure
- ATM Signal Structure
- ATM Traffic Analyzer
- ATM Background Generator



- ⇒ Add the VIs required to the list of VIs used in the Application Manager.
The Application Manager should include at least the following instruments (see Fig. A-114).



Fig. A-114 Minibar (Application Manager) after selecting the VIs

23.4 Measurement

Example

Load test on an ATM switch

Settings

“Signal Structure” and “ATM Signal Structure” VIs

Do not change the settings of these two VIs.

“ATM Background Generator” VI

The ATM Background Generator is an independent cell generator which you can use to define your own background traffic. The ATM traffic comprises one or more cell sequences.

1. Activate the “Background Generator” VI on the Application Manager.
2. Click on the “New” icon button in the “Sequence Control” field.
The “Sequence Editor- ‘NONAME’ ” window opens:
At this stage, you can enter settings for a sequence. You can influence the contents of the header field of the ATM cells by doing so. Note that there are reserved values for VCI/VPI.
3. Enter the following parameters in the “Sequence” field:
 - Number of cell repetitions
 - Number of subsequent empty cells per sequence
 - Number of sequence repetitions
4. Confirm your entries with “OK”.
You will now be asked to assign a name to the sequence (e.g. “test1”).
The name is displayed in the “Cell Sequence” list in the main window.

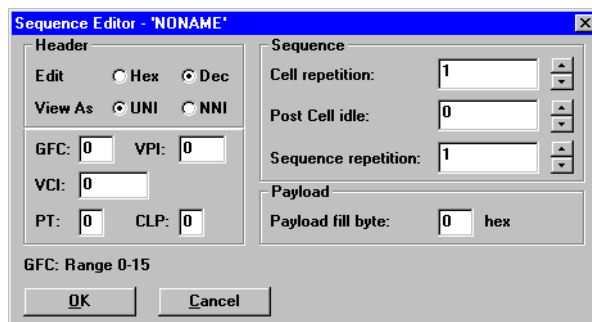

Fig. A-115 “Sequence Editor” dialog box in the “ATM Background Generator” window



Generating further sequences

For this measurement, you require a total of 9 sequences with different VCI/VPI values. In this way, you create 9 different virtual channels.

1. Click on the “New” button.
2. Repeat the sequence generation procedure 1 to 4 on the previous page (see “Sequence Editor”).

Defining and activating background traffic

Define the background traffic by inserting the generated sequences in the “Cell Sequence” list into the “Transmit List” (see Fig. A-116).

1. Mark the first sequence to be inserted (e.g. “sequ_1”).
2. Click on the “Add >>” button.
The sequence is added to the Transmit List.
3. Insert the other sequences by repeating 1 and 2.
4. Activate the background traffic by clicking the “ON” button on the toolbar.

You will then be asked to store the settings. In response enter a name (e.g. “traffic1”).

Start measurement (“Application Manager” VI)

- ⇒ Press function key F5.
– or –
Click on the “green traffic signal” icon.

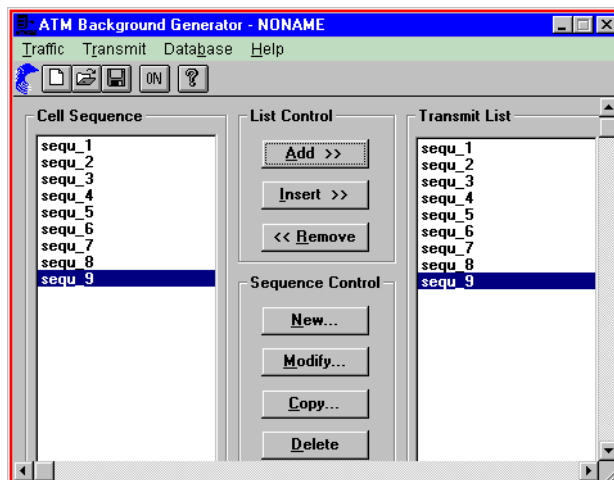

Fig. A-116 “ATM Background Generator” window

Analysis

- ⇒ Activate the window of the “ATM Traffic Analyzer” VI.

The measurement results are analyzed in the same way as the results of the previous reference measurement (ATM latency test for ATM switches).

Select the item “Export...” in the “Print” menu to store the measurement results in CSV format for further processing with EXCEL.



24 Sensor test - loss of cell delineation (LCD)

BN 3035/90.70 only

24.1 Test setup and description

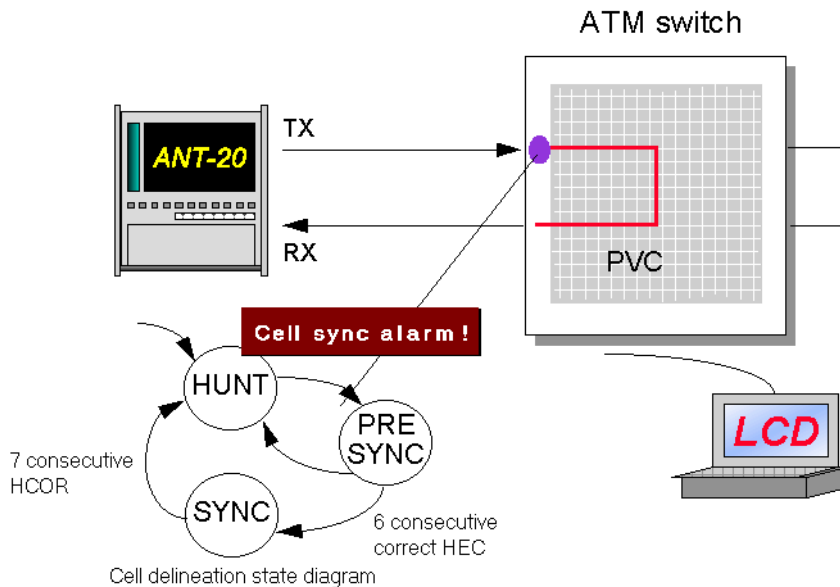

Fig. A-117 Setup for loss of cell delineation sensor tests

The purpose of this test is to demonstrate that the alarm and error sensors in an ATM switch are operating properly (to ITU-T or ATM Forum). If there is an LCD alarm, the system has lost cell stream synchronization. The synchronization and the monitoring of the cell stream is performed by a state automat which is specified in ITU-T Recommendation I.432.

When a simple LCD alarm is inserted, the ANT-20SE sends 7 consecutive cells with header errors. In this case, the ATM switch should output an LCD alarm for the port. The insertion time can be limited to 6 cells with header errors. In this case, the switch should synchronize.

24.2 Switch configuration

1. Set up a unidirectional, permanent connection with constant bit rate through the switch.
2. Check that the PCR (Peak Cell Rate) is 10% of the channel capacity (in cells per second).



24.3 Application selection on the ANT-20SE

VIs required

- Signal Structure
- ATM Signal Structure
- Anomaly and Defect Insertion
- Anomaly and Defect Analyzer

⇒ Add the VIs required to the list of VIs used in the Application Manager.

The Application Manager should include at least the following instruments (see Fig. A-118).



Fig. A-118 Minibar (Application Manager) after selecting the VIs

24.4 Measurement

Settings

“ATM Signal Structure” VI

1. Open the “ATM Signal Structure” window.
2. In the “Edit” menu, select the item “ATM Structure...”.
– or –
Click on the corresponding button in the toolbar.
This activates the “ATM Structure” window.
3. In the “ATM SDU” field, click on the “Testcell” button.
4. In the “Performance Measurement” field, click on “Error-Related Performance”.
5. Transfer the send-side settings to the receive side by clicking the “Tx => Rx” button.
6. Confirm your entries with “OK”.
7. Set a load of 10% in the display window (“CBR” icon).

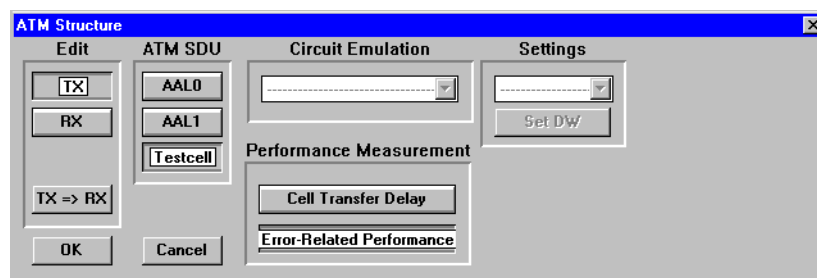

Fig. A-119 “ATM Structure” dialog box in the “ATM Signal Structure” window

“Anomaly and Defect Insertion” VI

1. Open the “Anomaly and Defect Insertion” window.
2. Click on the “ATM” icon on the toolbar.
3. Click on the “Defects” icon on the toolbar.
4. In the “ATM” field, select the item “LCD”.
5. In the “Insertion” field, select the item “single”.
6. Check that there is a “7” in the “Duration” field.



Start measurement (“Application Manager” VI)

⇒ Press function key F5.

– or –

Click on the “green traffic signal” icon.

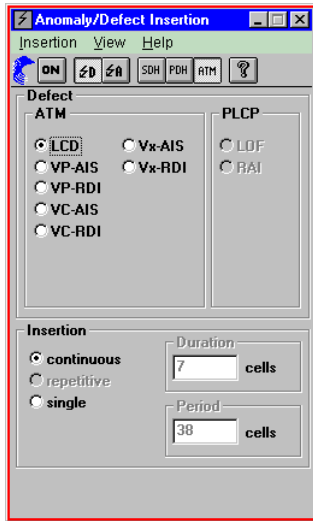

Fig. A-120 “Anomaly and Defect Insertion” window

Analysis: “Anomaly/Defect Analyzer” VI

The ATM switch should output an LCD alarm, send a VP-RDI alarm and a VC-RD alarm in the opposite direction and resynchronize.

1. Open the window of the “Anomaly and Defect Analyzer” VI.
The “VP-RDI” and the “VC-RDI” alarms are clearly visible in the histogram display mode (see Fig. A-121).
2. Open the “Anomaly and Defect Insertion” window and change the number “7” in the “Duration” field to a “6”.
3. Restart the measurement.

If the switch is functioning properly, there should be no LCD alarm this time. The ATM switch remains synchronized.

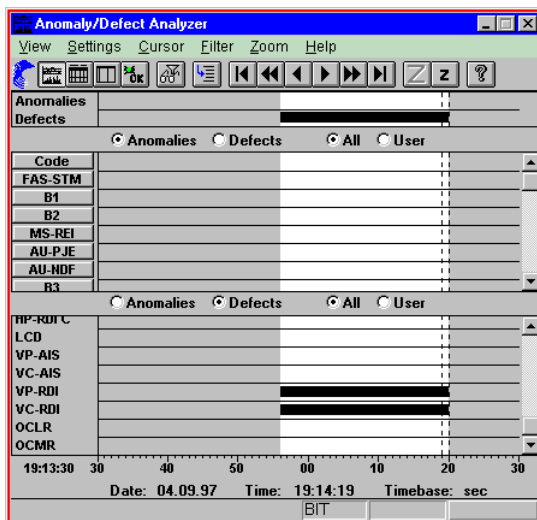

Fig. A-121 “Anomaly/Defect” Analyzer window



25 Measuring the CLR with a variable cell rate (VBR traffic)

BN 3035/90.70 only

25.1 Test setup and description

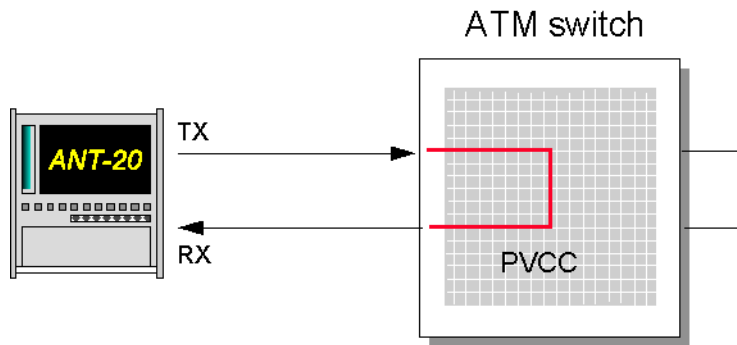

Fig. A-122 Setup for cell loss ratio measurements

The Cell Loss Ratio (CLR) is a quality of service parameter. The CLR is the ratio of the number of lost cells to the total cells sent.

25.2 Switch configuration

1. Set up a unidirectional, permanent connection with a variable bit rate through the switch.
2. Configure the VBR contract for the connection.

25.3 Application selection on the ANT-20SE

Vis required

- Signal Structure
- ATM Signal Structure
- ATM Traffic Analyzer
- Anomaly and Defect Analyzer

⇒ Add the VIs required to the list of VIs used in the Application Manager.

The Application Manager should include at least the following instruments (see Fig. A-123).



Fig. A-123 Minibar (Application Manager) after selecting the VIs



25.4 Measurement

Settings

1. Open the "ATM Signal Structure" window.
2. In the "Edit" menu, select the item "ATM Structure...".
– or –
Click on the corresponding button in the toolbar.
This activates the "ATM Structure" window.
3. In the "ATM SDU" field, click the "Testcell" button.
4. In the "Performance Measurement" field, click on "Error-Related Performance".
5. Transfer the send-side settings to the receive side by clicking the "Tx => Rx" button.
6. Confirm your entries with "OK".
7. In the "Traffic" menu, select the item "VBR".
8. In the "Traffic" menu, select the item "Set VBR...".
The "VBR" dialog box opens.

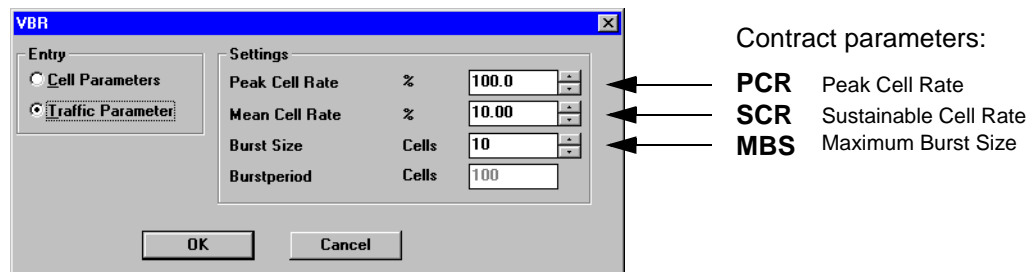

Fig. A-124 "VBR" dialog box in the "ATM Signal Structure" window

9. Set the following parameters in the "Settings" field:
 - the Peak Cell Rate (PCR),
 - the Mean Cell Rate (MCR),
 - the burst length and
 - the burst period.
10. Confirm your entries with "OK".

The mean cell rate that has been set is reflected in the ATM Signal Structure display.

Starting the measurement ("Application Manager" VI)

- ⇒ Press the function key F5.
– or –
Click on the "green traffic signal" icon.

Overview of the parameters: PCR, MCR, burst length, etc.

You can use the following parameters to define the variable load on the test channel:

- the Peak Cell Rate (PCR),
- the Mean Cell Rate (MCR),
- the burst length and
- the burst period.

The next Figure clarifies the significance of the various parameters: All parameters are related.



⇒ First of all, set the **Peak Cell Rate**.
This cell rate equals the burst load.

The **Mean Cell Rate** is, therefore, directly dependent on the ratio of the burst length to the burst period. If you want a mean cell rate which is 50% of the peak cell rate, the burst period must be two times the burst length.

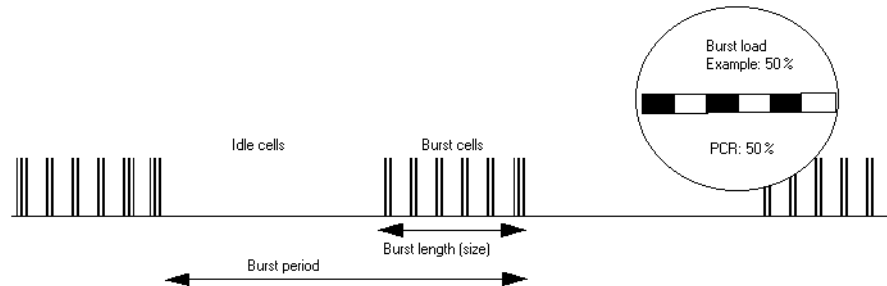

Fig. A-125 Definition of the burst period, burst length etc.

Analysis

1. Open the "Anomaly and Defect Analyzer" window.
2. In the "View" menu, select the item "Table".
– or –
Click the appropriate icon on the toolbar.
The measurement results are displayed as a table.
If there are cell losses, you will find the precise CLR in this table.



Notes:

Standards/Abbreviations



Contents

Standards/Abbreviations

1	Recommendations/Standards	SA-1
1.1	ITU-T recommendations	SA-1
1.2	ANSI standards	SA-4
1.3	Bellcore standards	SA-4
1.4	ETSI standards	SA-5
1.5	ATM Forum recommendations	SA-6
2	Alarm messages	SA-9
2.1	SDH/SONET	SA-9
2.2	ATM Path	SA-11
2.3	Virtual Concatenation	SA-11
3	Abbreviations	SA-12



Notes:



Standards/Abbreviations

1 Recommendations/Standards

1.1 ITU-T recommendations

Recommendations	Title
E.164	Numbering plan for the ISDN era
E.191	B-ISDN numbering and addressing
G.702	Digital hierarchy bit rates
G.703	Physical/electrical characteristics of hierarchical digital interfaces
G.704	Synchronous frame structures used at primary and secondary hierarchical levels
G.706	Frame alignment and cyclic redundancy check (CRC) procedures relating to basic frame structures defined in recommendation G.704
G.707	Network node interface for the synchronous digital hierarchy (SDH) (replaces G.707, G.708 and G.709 version of 03/93)
G.742	Second order digital multiplex equipment operating at 8448 kbit/s and using positive justification
G.751	Digital multiplex equipments operating at third order bit rate of 34368 kbit/s and fourth order bit rate of 139264 bit/s and using positive justification
G.755	Digital multiplex equipment operating at 139264 kbit/s and multiplexing three tributaries at 44736 kbit/s
G.772	Protected monitoring points provided on digital transmission systems
G.773	Protocol suites for Q interfaces for management of transmission systems
G.774	SDH information model for the network element view
G.774.01	SDH performance monitoring for the network element view
G.774.02	SDH configuration of the payload structure for the network element view
G.774.03	SDH management of multiplex section protection for the network element view
G.774.04	SDH management of sub network connection protection from the network element view
G.774.05	SDH management of the connection supervision functionality (HCS/LCS) for the network element view
G.774.06	SDH unidirectional performance monitoring for the network element view
G.774.07	SDH G.774 implementors guide
G.774.08	SDH management of radio-relay systems network element view
G.775	Loss of signal (LOS) and alarm indication signal (AIS) detection and clearance criteria
G.780	Vocabulary of terms for SDH networks and equipment

Table SA-1 Overview of important ITU-T recommendations



Recommendations	Title
G.783	Characteristics of synchronous digital hierarchy (SDH) equipment functional blocks (G.783 (April 97) replaces G.781, G.782 and G.783 version of 01/94)
G.784	Synchronous digital hierarchy (SDH) management
G.803	Architectures of transport networks based on the synchronous digital hierarchy (SDH)
G.804	ATM cell mapping into plesiochronous digital hierarchy (PDH)
G.810	Definitions and terminology for synchronisation networks
G.811	Timing requirements at the output of primary reference clocks suitable for plesiochronous operation of international digital links
G.812	Timing requirements at the output of slave clocks suitable for plesiochronous operation of international digital links
G.813	Timing characteristics of SDH equipment slave clocks (SEC)
G.821	Error performance of an international digital connection operating below the primary rate and forming a part of an ISDN
G.823	The control of jitter and wander within digital networks which are based on the 2048 kbit/s hierarchy
G.824	The control of jitter and wander within digital networks which are based on the 1544 kbit/s hierarchy
G.825	The control of jitter and wander in digital networks based on the SDH
G.826	Error performance parameters and objectives for international, constant bit rate digital paths at or above the primary rate
G.828	Error performance parameters and objectives for international, constant bit rate synchronous digital paths
G.829	Error performance events for SDH multiplex and regenerator section
G.831	Management capabilities of transport network based on the SDH
G.832	Transport of SDH elements on PDH networks
G.841	Types and characteristics of SDH network protection architectures
G.842	Interworking of SDH network protection architectures
G.911	Parameters and calculation methodologies for reliability of fibre optic systems
G.957	Optical interfaces for equipments and systems relating to the synchronous digital hierarchy
G.958	Digital line systems based on the synchronous digital hierarchy for use on optical fibre cables
I.356	B-ISDN ATM layer cell transfer performance
I.363	B-ISDN ATM Adaptation Layer (AAL) Specification
I.371	B-ISDN Traffic control and congestion
I.432	B-ISDN User-Network Interface Physical Layer Specification
I.610	B-ISDN Operation and Maintenance Principles and Functions
M.60	Maintenance terminology and definitions

Table SA-1 Overview of important ITU-T recommendations (*continued*)



Recommendations	Title
M.2100	Performance limit for bringing into service and maintenance of international PDH paths, sections and transmission systems
M.2101	Performance limit for bringing into service and maintenance of international SDH paths and multiplex sections
M.2110	Bringing into service international digital paths, sections and transmission systems
M.2120	Digital path, section and transmission fault detection and localization
M.3010	Principles of telecommunications management networks
M.3020	TMN interface specification methodology
M.3100	Generic network information model
M.3200	TMN management services: overview
M.3300	TMN management capabilities presented in the F interface
M.3400	TMN management functions
O.150	General requirements for instrumentation for performance measurements on digital transmission equipment
O.151	Error performance measuring equipment operating at the primary rate and above
O.171	Timing jitter and wander measuring equipment for digital systems which are based on the PDH
O.172	Jitter and Wander measuring equipment for digital systems which are based on the SDH
O.181	Equipment to assess error performance on STM-N SDH interfaces
O.191	Equipment to assess ATM layer cell transfer performance
Q.2010	B-ISDN Overview Signalling Capability Set 1, Release 1
Q.2100	B-ISDN Signalling ATM Adaption Layer (SAAL) Overview Description
Q.2110	B-ISDN ATM Adaptation Layer - Service Specific Connection Oriented Protocol (SSCOP)
Q.2130	B-ISDN Signalling ATM Adaptation Layer - Service Specific Coordination Function for Support of Signalling at the User Network Interface (SSCF at UNI)
Q.2931	B-ISDN - Digital Subscriber Signalling No. 2 (DSS 2) - User Network Interface Layer 3 Specification for Basic Call / Connection Control
Q.2932.1	B-ISDN - Digital Subscriber Signalling System No. 2 (DSS 2) - Generic Functional Protocol - Core Functions
Q.2961	B-ISDN - Digital Subscriber Signalling System No. 2 (DSS 2) - Additional Traffic Parameters
V.11	Electrical characteristics for balanced double-current interchange circuits for general use with integrated circuit equipment in the field of data communications
X.21	Interface between data terminal equipment (DTE) and data circuit-terminating equipment (DCE) for synchronous operation on public networks

Table SA-1 Overview of important ITU-T recommendations (*continued*)



1.2 ANSI standards

Standard	Title
T1.101-1994	Synchronization interface standards for the digital networks
T1.102-1993	Digital hierarchy - electrical interfaces
T1.102.01-1996	Digital hierarchy - VT 1.5 electrical interface
T1.105-1995	SONET - basic description including multiplex structure, rates and formats
T1.105.01-1995	SONET - automatic protection
T1.105.02-1995	SONET - payload mappings
T1.105.03-1994	SONET - jitter at network interfaces
T1.105.04-1995	SONET - data communication channel (DCC) protocol and architectures
T1.105.05-1994	SONET - tandem connection maintenance
T1.105.06-1996	SONET - physical layer specifications
T1.105.07-1996	SONET - sub STS-1 interface rates and formats specifications
T1.105.09-1996	SONET - network element timing and synchronisation
T1.106-1988	Digital hierarchy - optical interface specification (replaced by T1.105.06)
T1.107-1995	Digital hierarchy - formats specification (PDH)
T1.119-1994	SONET - operations administrations, maintenance and provisioning (OAM&P) communications
T1.119.01-1995	SONET - OAM&P communications protection switching fragment
T1.204-1993	OAM&P - lower layer protocol for interfaces between operation systems and network elements
T1.208-1993	OAM&P - upper layer protocol for interfaces between operation systems and network elements
T1.210-1993	OAM&P - principles of functions, architectures and protocols for TMN interfaces
T1.231-1993	Digital hierarchy - Layer 1 in-service digital transmission performance monitoring

Table SA-2 Overview of important ANSI standards

1.3 Bellcore standards

Standard	Title
GR-253-CORE	SONET Transport System: Common Generic Criteria
GR-499-CORE	Transport Systems Generic Requirements (TSGR): Common Requirements

Table SA-3 Overview of important Bellcore standards



1.4 ETSI standards

Standard	Title
ETS 300 147 R3	Synchronous digital hierarchy (SDH); Multiplexing structure (based on ITU-T Recommendation G.707)
ETS 300 166	Physical and electrical characteristics of hierarchical digital interfaces for equipment using the 2048 kbit/s-based plesiochronous or synchronous digital hierarchies (based on ITU-T Recommendation G.703)
ETS 300 167	Functional characteristics of 2 048 Mbit/s interfaces (based on ITU-T Recommendations G.704 and G.706)
ETS 300 417-1-1	Generic requirements of transport functionality of equipment - Part 1-1: Generic processes and performances
ETS 300 417-2-1	Generic requirements of transport functionality of equipment - Part 2-1: SDH and PDH physical section layer functions
ETS 300 417-3-1	Generic requirements of transport functionality of equipment - Part 3-1: STM-N regenerator and multiplex section layer functions
ETS 300 417-4-1	Generic requirements of transport functionality of equipment - Part 4-1: SDH path layer functions
ETS 300 417-5-1	Generic requirements of transport functionality of equipment - Part 5-1: PDH path layer functions
ETS 300 417-6-1	Generic requirements of transport functionality of equipment - Part 6-1: Synchronization layer functions
ETS 300 462-1	Generic requirements for synchronization networks - Part 1: Definitions and terminology for synchronization networks
ETS 300 462-2	Generic requirement for synchronization networks - Part 2: Synchronization network architecture
ETS 300 462-3	Generic requirement for synchronization networks - Part 3: The control of jitter and wander within synchronization networks
ETS 300 462-4	Generic requirements for synchronization networks; Part 4: Timing characteristics of slave clocks suitable for synchronization supply to SDH and PDH equipment
ETS 300 462-5	Generic requirements for synchronization networks; Part 5: Timing characteristics of slave clocks suitable for operation in synchronous Digital Hierarchy (SDH) equipment
ETS 300 462-6	Generic requirements for synchronization networks; Part 6: Timing characteristics of primary reference clocks

Table SA-4 Overview of important ETSI standards



1.5 ATM Forum recommendations

Approved Items as of May 1997

Below is a listing of all specifications completed and approved by the ATM Forum since its inception in 1991.

These documents may be found on the ftp server in several different formats. The document numbers listed here link to the .pdf version of the document where available.

Technical Working Group	Approved Specifications	Specification	Approved Date
B-ICI	B-ICI 1.0	af-bici-0013.000	Sep, 1993
	B-ICI 1.1	af-bici-0013.001	-
	B-ICI 2.0 (delta spec to B-ICI 1.1)	af-bici-0013.002	Dec, 1995
	B-ICI 2.0 (integrated specification)	af-bici-0013.003	Dec, 1995 B-
	B-ICI 2.0 Addendum or 2.1	af-bici-0068.000	Nov, 1996
Data Exchange Interface	Data Exchange Interface version 1.0	af-dxi-0014.000	Aug, 1993
ILMI (Integrated Layer Mgmt. Interface)	ILMI 4.0	af-ilmi-0065.000	Sep, 1996
LAN Emulation	LAN Emulation over ATM 1.0	af-lane-0021.000	Jan, 1995
	LAN Emulation Client Management Specification	af-lane-0038.000	Sep, 1995
	LANE 1.0 Addendum	af-lane-0050.000	Dec, 1995
	LANE Servers Management Spec v1.0	af-lane-0057.000	Mar, 1996
Network Management	Customer Network Management (CNM) for ATM Public Network Service	af-nm-0019.000	Oct, 1994
	M4 Interface Requirements and Logical MIB	af-nm-0020.000	Oct, 1994
	CMIP Specification for the M4 Interface	af-nm-0027.000	Sep, 1995
	M4 Public Network view	af-nm-0058.000	Mar, 1996
	M4 "NE View"	af-nm-0071.000	Jan, 1997
	Circuit Emulation Service Interworking Requirements, Logical and CMIP MIB	af-nm-0072.000	Jan, 1997
	M4 Network View CMIP MIB Spec v1.0	af-nm-0073.000	Jan, 1997
	M4 Network View Requirements & Logical MIB Addendum	af-nm-0074.000	Jan, 1997
Physical Layer	Issued as part of UNI 3.1: 44.736 DS3 Mbps Physical Layer 100 Mbps Multimode Fiber Interface Physical Layer 155.52 Mbps SONET STS-3c Physical Layer 155.52 Mbps Physical Layer	af-uni-0010.002	-

Table SA-5 Overview of important ATM forum recommendations



Technical Working Group	Approved Specifications	Specification	Approved Date
Physical Layer	ATM Physical Medium Dependent Interface Specification for 155 Mb/s over Twisted Pair Cable	af-phy-0015.000	Sep, 1994
	Utopia	af-phy-0017.000	Mar, 1994
	Mid-range Physical Layer Specification for Category 3 UTP	af-phy-0018.000	Sep, 1994
	6.312 Kbps UNI Specification	af-phy-0029.000	June, 1995
	Utopia Level 2	af-phy-0039.000	June, 1995
	Physical Interface Specification for 25.6 Mb/s over Twisted Pair	af-phy-0040.000	Nov, 1995
	A Cell-based Transmission Convergence Sublayer for Clear Channel Interfaces	af-phy-0043.000	Jan, 1996
	622.08 Mbps Physical Layer	af-phy-0046.000	Jan, 1996
	155.52 Mbps Physical Layer Specification for Category 3 UTP (See also UNI 3.1, af-uni-0010.002)	af-phy-0047.000	-
	120 Ohm Addendum to ATM PMD Interface Spec for 155 Mbps over TP	af-phy-0053.000	Jan, 1996
	155 Mbps over MMF Short Wave Length Lasers, Addendum to UNI 3.1	af-phy-0062.000	July, 1996
	WIRE (PMD to TC layers)	af-phy-0063.000	July, 1996
P-NNI	Interim Inter-Switch Signaling Protocol	af-pnni-0026.000	Dec, 1994
	P-NNI V1.0	af-pnni-0055.000	Mar, 1996
	PNNI 1.0 Addendum (soft PVC MIB)	af-pnni-0066.000	Sep, 1996
	PNNI ABR Addendum	af-pnni-0075.000	Jan, 1997
Service Aspects and Applications	Frame UNI	af-saa-0031.000	Sep, 1995
	Native ATM Services: Semantic Description	af-saa-0048.000	Feb, 1996
	Audio/Visual Multimedia Services: Video on Demand v1.0	af-saa-0049.000	Jan, 1996
	Audio/Visual Multimedia Services: Video on Demand v1.1	af-saa-0049.001	Mar, 1997
	ATM Names Service	af-saa-0069.000	Nov, 1996
Signaling	(See UNI 3.1, af-uni-0010.002)		
	UNI Signaling 4.0	af-sig-0061.000	July, 1996
	Signaling ABR Addendum	af-sig-0076.000	Jan, 1997
Testing	Introduction to ATM Forum Test Specifications	af-test-0022.000	Dec, 1994
	PICS Proforma for the DS3 Physical Layer Interface	af-test-0023.000	Sep, 1994
	PICS Proforma for the SONET STS-3c Physical Layer Interface	af-test-0024.000	Sep, 1994

Table SA-5 Overview of important ATM forum recommendations (*continued*)



Technical Working Group	Approved Specifications	Specification	Approved Date
Testing	PICS Proforma for the 100 Mbps Multimode Fibre Physical Layer Interface	af-test-0025.000	Sep, 1994
	PICS Proforma for the ATM Layer (UNI 3.0)	af-test-0028.000	Apr, 1995
	Conformance Abstract Test Suite for the ATM Layer for Intermediate Systems (UNI 3.0)	af-test-0030.000	Sep, 1995
	Interoperability Test Suite for the ATM Layer (UNI 3.0)	af-test-0035.000	Apr, 1995
	Interoperability Test Suites for Physical Layer: DS-3, STS-3c, 100 Mbps MMF (TAXI)	af-test-0036.000	Apr, 1995
	PICS Proforma for the DS1 Physical Layer	af-test-0037.000	Apr, 1995
	Conformance Abstract Test Suite for the ATM Layer (End Systems) UNI 3.0	af-test-0041.000	Jan, 1996
	PICS for AAL5 (ITU spec)	af-test-0042.000	Jan, 1996
	PICS Proforma for the 51.84 Mbps Mid-Range PHY Layer Interface	af-test-0044.000	Jan, 1996
	Conformance Abstract Test Suite for the ATM Layer of Intermediate Systems (UNI 3.1)	af-test-0045.000	Jan, 1996
	PICS for the 25.6 Mbps over Twisted Pair Cable (UTP-3) Physical Layer	af-test-0051.000	Mar, 1996
	PICS for ATM Layer (UNI 3.1)	af-test-0059.000	July, 1996
	Conformance Abstract Test Suite for the UNI 3.1 ATM Layer of End Systems	af-test-0060.000	June, 1996
	Conformance Abstract Test Suite for the SSCOP Sub-layer (UNI 3.1)	af-test-0067.000	Sep, 1996
	PICS for the 155 Mbps over Twisted Pair Cable (UTP-5/STP-5) Physical Layer	af-test-0070.000	Nov, 1996
Traffic Management	(See UNI 3.1, af-uni-0010.002)		
	Traffic Management 4.0	af-tm-0056.000	Apr, 1996
	Traffic Management ABR Addendum	af-tm-0077.000	Jan, 1997
User-Network Interface (UNI)	ATM User-Network Interface Specification V2.0	af-uni-0010.000	June, 1992
	ILMI MIB for UNI 3.0	af-uni-0011.000	-
	ILMI MIB for UNI 3.1	af-uni-0011.001	-

Table SA-5 Overview of important ATM forum recommendations (*continued*)

Recommendation	Title
UNI 3.1	ATM User-Network Interface Specification 3.1, 4.0
CES V2.0	Circuit Emulation Services V2.0 Baseline

Table SA-6 Overview of important ATM forum recommendations (obsolete)



2 Alarm messages

2.1 SDH/SONET

Abbreviation SDH	Old Expression	Meaning	Abbreviation SONET	Old Expression	Meaning
ITU-T G.707 (new), G.783			ANSI T1.105, BELLCORE GR-253		
LOS	NO-SIG	Loss of Signal	LOS	-	Loss of Signal
TSE	BER	Test Sequence Error (Bit error)	TSE	-	Test Sequence Error (Bit error)
LSS	NO-PATT	Loss of Sequence Synchronization	LSS	-	Loss of Sequence Synchronization
LTI	NO-CLOCK	Loss of incoming Timing Intervals	LTI	-	Loss of incoming Timing Intervals
Regenerator Section			Section		
OOF	-	Out Of Frame	OOF	-	Out Of Frame
LOF	-	Loss Of Frame	LOF	-	Loss Of Frame
B1 (8 bits)	-	Regenerator section error monitoring	B1 (8 bits)	-	Section error monitoring
Multiplex Section			Line (L)		
B2 (n x 24 bits)	-	Multiplex section error monitoring	B2 (n x 8 bits)	-	Line error monitoring
MS-AIS	S-AIS	Multiplex Section AIS	AIS-L	-	Line AIS
MS-RDI	MS-FERF	Multiplex Section Remote Defect Indication	RDI-L	LINE FERF	Line Remote Defect Indication
MS-REI	-	Multiplex Section Remote Error Indication	REI-L	LINE FEBE	Line Remote Error Indication
Administrative Unit			STS Path (SP)		
AU-LOP	-	Loss Of AU Pointer	LOP-P	-	SP Loss of Pointer
AU-NDF	-	AU Pointer New Data Flag	NDF-P	-	SP New Data Flag
AU-AIS	P-AIS	AU AIS	AIS-P	-	SP AIS
AU-PJE	-	AU Pointer Justification Event	-		
HO Path			-		
B3 (8 bits)	-	HO Path error monitoring (VC-3/4)	B3 (8 bits)	-	SP error monitoring
HP-UNEQ	-	HO Path UNEQuipped	UNEQ-P	-	SP UNEQuipped

Table SA-7 Alarm messages SDH/SONET



Abbreviation SDH	Old Expression	Meaning	Abbreviation SONET	Old Expression	Meaning
ITU-T G.707 (new), G.783			ANSI T1.105, BELLCORE GR-253		
HP-RDI	HP-FERF	HO Path Remote Defect Indication	RDI-P	STS Path YELLOW	SP Remote Defect Indication
HPRDIEP	-	HO Path RDI Payload Defect	RDIEPP	-	SP RDI Payload Defect
HPRDIES	-	HO Path RDI Server Defect	RDIEPS	-	SP RDI Server Defect
HPRDIEC	-	HO Path RDI Connectivity Defect	RDIEPC	-	SP RDI Connectivity Defect
HP-REI	HP-FEBE	HO Path Remote Error Indication	REI-P	STS Path FEBE	SP Remote Error Indication
-	-	-	PDI-P	-	SP Payload Defect Indication
HP-TIM	-	HO Path Trace Identifier Mismatch	TIM-P	-	SP Trace Identifier Mismatch
HP-PLM	HP-SLM	HO Path Payload Label Mismatch	PLM-P	-	SP Path Label Mismatch
Tributary Unit			VT Path (VP)		
TU-LOP	-	Loss of TU Pointer	LOP-V	-	VP Loss of Pointer
TU-NDF	-	TU pointer New Data Flag	NDF-V	-	VP New Data Flag
TU-AIS	-	TU AIS	AIS-V	-	VP AIS
TU-LOM	-	Loss Of Multiframe (H4)	LOM	-	Loss of Multiframe
LO Path			-		
BIP-2	-	LO Path error monitoring (VC-11/12)	BIP-V	-	VP error monitoring
B3 (8 bits)	-	LO Path error monitoring (VC-3)	-		
LP-UNEQ	-	LO Path UNEQuipped	UNEQ-V	VT Uneq.	VP UNEQuipped
LP-RDI	LP-FERF	LO Path Remote Defect Indication	RDI-V	VT Path YELLOW	VP Remote Defect Indication
LPRDIEP	-	LO Path RDI Payload Defect	RDIEVP	-	VP RDI Payload Defect
LPRDIES	-	LO Path RDI Server Defect	RDIEVS	-	VP RDI Server Defect
LPRDIEC	-	LO Path RDI Connectivity Defect	RDIEVC	-	VP RDI Connectivity Defect
LP-REI	LP-FEBE	LO Path Remote Error Indication	REI-V	VT Path FEBE	VP Remote Error Indication

Table SA-7 Alarm messages SDH/SONET (continued)



Abbreviation SDH	Old Expression	Meaning	Abbreviation SONET	Old Expression	Meaning
ITU-T G.707 (new), G.783			ANSI T1.105, BELLCORE GR-253		
LP-RFI	-	LO Path Remote Failure Indication	RFI-V	-	VP Remote Failure Indication
-	-	-	PDI-V	-	VP Payload Defect Indication
LP-TIM	-	LO Path Trace Identifier Mismatch	TIM-V	-	VP Trace Identifier Mismatch
LP-PLM	LP-SLM	LO Path Payload Mismatch	PLM-V	-	VP Path Label Mismatch

Table SA-7 Alarm messages SDH/SONET (continued)

2.2 ATM Path

Abbreviation	Meaning	ITU-T Rec.
AAL-1 OOS	AAL-1 Out Of Sync	I.363
LCD	Loss of Cell Delineation (Cell Synchronization)	I.610
OCLR	Overflow Cell Loss Ratio Measurement	-
OCMR	Overflow Cell Misinsertion	-
OCR	Overflow Cell Rate	-
VP-AIS	Virtual Path Alarm Indication Signal	I.610
VP-RDI	Virtual Path Remote Defect Indication	I.610
VC-AIS	Virtual Channel Alarm Indication Signal	I.610
VC-RDI	Virtual Channel Remote Defect Indication	I.610
Vx-AIS	Virtual Channel AIS and Virtual Path AIS simultaneously	-
Vx-RDI	Virtual Channel RDI and Virtual Path RDI simultaneously	-

Table SA-8 Alarm messages ATM Path

2.3 Virtual Concatenation

Abbreviation	Meaning	ITU-T Rec.
DPOVC	Delta Pointer Overflow Virtual Concatenation	-

Table SA-9 Alarm message Virtual Concatenation



3 Abbreviations

Abbreviation	Meaning
A	
A1	SOH Framing Byte 11110110
	TOH Framing Byte 11110110
	Framing Byte 11110110 (PLCP)
A2	SOH Framing Byte 00101000
	TOH Framing Byte 00101000
	Framing Byte 00101000 (PLCP)
AAL	ATM Adaptation Layer
AAL-1 CRC	AAL1 CRC error
AAL-1 OOS	AAL1 Out Of Sync
AAL-1 PE	AAL1 Parity Error
ADEV	Allan Deviation
ADM	Add Drop Multiplexer
AFI	Authority and Format Identifier
AGE	Aging
AIS	Alarm Indication Signal
AIS-L	Alarm Indication Signal - Line
AIS-P	Alarm Indication Signal - Path
AIS-V	Alarm Indication Signal - VT
AMI	Alternated Mark Inversion
APS	Automatic Protection Switching (K1, K2)
ATM	Asynchronous Transfer Mode
AU	Administrative Unit
AU-AIS	AU Alarm Indication Signal
AU-LOP	AU Loss of Pointer
AU-n	Administrative Unit, Level n = 3; 4
AUG	Administrative Unit Group
AvBW	Average Bandwidth

Table SA-10 Standard abbreviations used in this manual



Abbreviation	Meaning
B	
B1	Parity Word BIP-8 for Regenerator Section (RSOH)
	Parity Word BIP-8 for Section
	Path Error Monitoring (BIP-8) Byte (PLCP)
B2	Parity Word BIP-Nx8 for Line
	Parity Word BIP-Nx24 for Multiplex Section (MSOH)
B3	Parity Word BIP-8 for VC-3, 4 Path (POH)
	Parity Word BIP-8 for Path Overhead (POH)
B3ZS	Bipolar with three-zero substitution
B8ZS	Bipolar with eight-zero substitution
BBE	Background Block Error
BBER	Background Block Error Ratio
BER	Bit Error Ratio
BIP-2	Parity Word BIP-8 for VC-1, 2 Path (POH)
BIP-n	Bit Interleaved Parity n Bit
BIP-V	Parity Word BIP-8 for Tributary POH
BIS[P]O	Bringing into service [performance] objectives
BPV	Bipolar Violation
BT	Burst Tolerance
BW	Bandwidth
C	
C-n	Container, n = 1 to 4 (STM-16 n = 1 to 16)
C1	STM-N Identifier
	Cycle Stuff Counter (PCLP)
C2	Signal Label (VC-3, 4 POH)
	Signal Label
CAS	Channel Associated Signaling
CBR	Constant Bit Rate
CDV	Cell Delay Variation
CDVT	Cell Delay Variation Tolerance
CER	Cell Error Ratio
CI	Concatenation Indication
	Congestion Indicator
CI-BW	Congestion Indicator Bandwidth
CK	Clock

Table SA-10 Standard abbreviations used in this manual (*continued*)



Abbreviation	Meaning
CLP	Cell Loss Priority
CLP1-BW	Cell Loss Priority 1 Bandwidth
CLR	Cell Loss Ratio
CMI	Coded Mark Inversion (Signal code)
CMR	Cell Misinsertion Rate
CPS	Cells per Second
CRC-N	Cyclic Redundancy Check, width N
CTD	Cell Transfer Delay
CuBW	Current Bandwidth
D	
D	Pointer: Decrement Bit
D1 to D3	(RSOH) 196 kbit/s DCC for Regenerator Section
D4 to D12	(MSOH) 576 kbit/s DCC for Multiplex Section
DBR	Deterministic Bit Rate
DC	Dropped Cells
DCC	Data Communication Channel
	Data Country code (ATM)
DCN	Data Communication Network
DPOVC	Delta Pointer Overflow Virtual Concatenation
DS1	Electrical Interface Signal 1544 kbit/s
DS3	Electrical Interface Signal 44736 kbit/s
DUT	Device Under Test
DXC	Digital Cross Connect System
E	
E1	Electrical Interface Signal 2048 kbit/s
	(RSOH) Orderwire Channel (voice) for Regenerator Section
	(TOH) Orderwire Channel (voice)
E2	Electrical Interface Signal 8448 kbit/s
	(MSOH) Orderwire Channel (voice) for Multiplex Section
	(TOH) Orderwire Channel (voice)
E3	Electrical Interface Signal 34368 kbit/s
E4	Electrical Interface Signal 139264 kbit/s
EBC	Errored Block Count
ECC	Embedded Communication Channel
EDC	Error Detection Code

Table SA-10 Standard abbreviations used in this manual (*continued*)



Abbreviation	Meaning
EEPO	End to End Performance Objectives
EF	Equipment Failure
EFS	Error Free Second
EM	Error Monitoring Byte (BIP-8) (G.832)
ES	Errored Second (G.826)
ESF	Extended Super Frame (DS1)
ESI	End System Identifier
ESR	Errored Second Ratio (G.826)
F	
f	Frequency
F1	(RSOH) User Channel e.g. for maintenance purposes
	(TOH) User Channel e.g. for maintenance purposes
F2, F3	(POH) Path User Channels
F4	OAM flow ATM Path
F5	OAM flow ATM Channel
FA1	Framing byte 11110110 (G.832)
FA2	Framing byte 00101000 (G.832)
FAS	Frame Alignment Signal
FE	Frame Error
FEAC	Far End Alarm and Control Signal
FEBE	Far End Block Error
FMTJ	Fast Maximum Tolerable Jitter
G	
G1	(POH) Path Status
	PLCP Path Status (PLCP)
GC	General Purpose Communication Channel (G.832)
GCRA	Generic Cell Rate Algorithm
GFC	Generic Flow Control
H	
H1	Pointer Byte 1: Bit No. 1 to 4: New Data Flag (01101001), Bit No. 5 and 6: ss bits, Bit No. 7 and 8: Pointer value (MSB bits)
H2	Pointer Byte 2: Pointer value (LSB bits)
H3	Pointer Byte 3: Negative Justification Opportunity
H4	(POH) Position Indicator e.g. for quadframe
HBER	High Bit Error Ratio

Table SA-10 Standard abbreviations used in this manual (continued)



Abbreviation	Meaning
HCOR	Correctable Header Error
HDB3	High Density Bipolar of order 3
HEC	Header Error Check (ATM)
HO-DSP	High Order Domain Specific Part
HP	Higher Order Path
	High-pass Filter (Jitter VI)
HPRDIEC	Higher Order Path RDI Connectivity Defect
HPRDIEP	Higher Order Path RDI Payload Defect
HPRDIES	Higher Order Path RDI Server Defect
HUNC	Uncorrectable Header Error
I	
I	Pointer: Increment Bit
ICD	International Code Designator
IDI	Initial Domain Identifier
IEC	Incoming Error Count
IDLE	Idle Cells
INC	Increment
ISDN	Integrated Services Digital Network
ISM	In Service Measurement
J	
J0	Regenerator Section Trace (RSOH)
	Section Trace (TOH)
J1	Path Trace (POH in VC-3, 4)
	STS-Path Trace (POH)
J2	Path Trace (POH in VC-1, 2)
	VT-Path Trace (POH)
JTF	Jitter Transfer Function
K	
K1, K2	Automatic Protection Switching (APS) signalling channel (MSOH)
	Automatic Protection Switching (APS) signalling channel (TOH)
K3, K4	Automatic Protection Switching (APS) signalling channel (POH)
L	
LCD	Loss of Cell Delineation

Table SA-10 Standard abbreviations used in this manual (*continued*)



Abbreviation	Meaning
LOF	Loss of Frame
LOM	Loss Of Multiframe
LOP	Loss Of Pointer
LOP-P	Loss Of Pointer - Path
LOP-V	Loss Of Pointer - VT
LOS	Loss Of Signal
LP	Lower Order Path
	Low-pass Filter (Jitter VI)
LPAC	Loss of Performance Access Capability
LPRDIEC	Lower Order Path RDI Connectivity Defect
LPRDIEP	Lower Order Path RDI Payload Defect
LPRDIES	Lower Order Path RDI Server Defect
LSS	Loss of Sequence Synchronisation (Pattern Loss)
LTC	Loss of Test Channel
	for Tandem Connection: Loss of Tandem Connection
LTI	Loss of all Incoming Timing references
M	
M1	MS-REI byte (MSOH)
	MS-REI byte (TOH)
MA	Maintenance Adaption byte (G.832)
MBS	Maximum Burst Size
MDEV	Modified Allan Deviation
MFE	Multiframe Error
MS	Multiplexer Section
MS-AIS	Multiplexer Section AIS
MSB	Most Significant Bit
MSOH	Multiplexer Section Overhead
MTBF	Mean Time Between Failures
MTIE	Maximum Time Interval Error
MTJ	Maximum Tolerable Jitter
MUX	Multiplexer
N	
N1, 2	Network operator bytes (POH) for Tandem Connection Monitoring (TCM)
NCC	Non-Conforming Cells

Table SA-10 Standard abbreviations used in this manual (*continued*)



Abbreviation	Meaning
NCS	Not Connected Seconds
NDF	New Data Flag
NE	Network Element
NNI	Network Node Interface
NPI	Null Pointer Indication
NR	Network Operator Channel (G.832)
NRZ	Non-Return to Zero
NSA	Non-service Affecting Failure
NSAP	Network Service Access Point
NU	National Use
O	
OAM	Operation, Administration and Management
OC-N	Optical Carrier, N = 1; 3; 12; 48
OCLR	Overflow of Cell Loss Ratio
OCMR	Overflow of Cell Misinsertion Rate
OCR	Overflow Cell Rate
OH	Overhead
OOF	Out Of Frame
OOS	Out of Service Measurement
P	
P1, P2	Automatic Protection Switching (G.832)
PCR	Peak Cell Rate
PDH	Plesiochronous Digital Hierarchy
PDI	Payload Defect Indication
PJE	Pointer Justification Event
PLCP	Physical Layer Convergence Protocol
PLL	Phase Locked Loop
PLM	Payload Mismatch
PLM-P	Payload Mismatch - Path
PLM-V	Payload Mismatch - VT
PMP	Protected Monitoring Point
POH	Path Overhead
POI	Path Overhead Identifier (PLCP)
PRBS	Pseudo Random Binary Sequence
PT	Payload Type

Table SA-10 Standard abbreviations used in this manual (continued)



Abbreviation	Meaning
PTR	Pointer
PVC	Permanent Virtual Channel
Q	
QOS	Quality Of Service
R	
RAI	Remote Alarm Indication
RDI	Remote Defect Indication
RDIEPC	STS Path RDI Connectivity Defect
RDIEPP	STS Path RDI Server Defect
RDIEPS	STS Path RDI Payload Defect
RDIEVC	VT Path RDI Connectivity Defect
RDIEVP	VT Path RDI Server Defect
RDIEVS	VT Path RDI Payload Defect
RDI-L	Remote Defect Indication - Line
RDI-P	Remote Defect Indication - Path
RDI-V	Remote Defect Indication - VT
REI	Remote Error Indication
RFI	Remote Failure Indication
RS	Regenerator Section
RSOH	Regenerator Section Overhead
RX	Receiver
S	
S1	Synchronization Status Byte (MSOH)
	Synchronization Status Byte (TOH)
SA	Service Affecting Failure
SAAL	Signaling ATM Adaptation Layer
SBR	Statistical Bit Rate
SBW	Signaling Bandwidth
SCR	Sustainable Cell Rate
SDH	Synchronous Digital Hierarchy
SECB	Severely Errored Cell Block
SEL	Selector
SEP	Severely Errored Period
SES	Severely Errored Second
SESR	Severely Errored Second Ratio

Table SA-10 Standard abbreviations used in this manual (*continued*)



Abbreviation	Meaning
SF	Super Frame (DS1)
SIG	Signaling
SLX	Synchronous Line System
SOH	Section Overhead
SONET	Synchronous Optical Network
SPE	Synchronous Payload Envelope
SSCOP	Service Specific Convergence Protocol
STM	Synchronous Transfer Module
STM-N	Synchronous Transport Module, level N = 0, 1, 4, 16, 64
STS	Synchronous Transport Signal
STS-N	Synchronous Transport Signal, level N = 1, 3, 12, 48, 192
SVC	Switched Virtual Channel
T	
TC	Tandem Connection
TC-APId	TC Access Point Identifier (Trace Identifier)
TC-IEC	TC Incoming Error Count
TCM	Tandem Connection Monitoring
TC-ODI	TC Outgoing Defect Indication
TC-OEI	TC Outgoing Error Indication
TC-REI	TC Remote Error Indication
TC-RDI	TC Remote Defect Indication
TC-UNEQ	TC unequipped
TDEV	Time Deviation
TI	Trace Identifier
TIE	Time Interval Error
TIM	Trace Identifier Mismatch
TMN	Telecommunications Management Network
TOH	Transport Overhead
TR	Trail trace (G.832)
TS	Timeslot
TSE	Test Sequence Error (bit errors)
TU	Tributary Unit
TU-m	Tributary Unit, level m = 1 to 3
TUG-m	Tributary Unit Group, level m = 1, 2
TX	Transmitter

Table SA-10 Standard abbreviations used in this manual (continued)



Abbreviation	Meaning
U	
UAS	Unavailable Second
UBR	Unspecified Bit Rate
UBW	User Traffic Bandwidth
UNAS	Unassigned Cell
UNEQ	Unequipped
UNEQ-P	Unequipped - Path
UNEQ-V	Unequipped - VT
UNI	User Network Interface
UI	Unit Interval
V	
V5	POH byte (VC-1, 2)
VBR	Variable Bit Rate
VBR-nRT	Variable Bit Rate - non Real Time
VBR-RT	Variable Bit Rate - Real Time
VC	Virtual Container (SDH)
	Virtual Channel (ATM)
VC-AIS	Virtual Channel Alarm Indication
VC-n	Virtual Container, level n = 1, 2, 3, 4
VC-n-Xc	Concatenated Virtual Container, level n, X concatenated VCs
VC-RDI	Virtual Channel Remote Defect Indication
VCI	Virtual Channel Identifier
VI	Virtual Instrument
VP	Virtual Path
VP-AIS	Virtual Path Alarm Indication
VP-RDI	Virtual Path Remote Defect Indication
VPI	Virtual Path Identifier
VT	Virtual Tributary
W	
WTR	Wait to Restore
Z	
Z0	Spare byte (RSOH)
Z6	Network operator byte (POB) for Tandem Connection Monitoring (TCM)

Table SA-10 Standard abbreviations used in this manual (*continued*)



Notes:

Technical Background



Contents

Technical Background

1	Multiplexing structures	TB-1
1.1	SONET Multiplexing Structure ANSI T1.105-1995	TB-1
1.2	SDH Multiplexing Structure ITU-T G.707	TB-1
2	Pointer action generation	TB-2
2.1	Periodic pointers	TB-2
2.1.1	Identical polarity: "INC" or "DEC"	TB-2
2.1.2	Different polarity: "INC / DEC"	TB-2
2.1.3	Double pointer: "Add (INC, DEC)"	TB-2
2.1.4	Messing pointer: "Cancel (INC, DEC)"	TB-3
2.2	Pointer burst with missing pointers: "INC" or "DEC" with "Cancel (INC, DEC)"	TB-3
2.3	Standard sequence	TB-3
2.3.1	"87-3" sequence	TB-3
2.3.2	"43-44" sequence with double pointer	TB-4
2.4	"86-4" sequence with missing pointer	TB-4
2.5	Setting a new pointer	TB-4
2.6	Pointer sequences parameter	TB-5
3	Performance Analysis	TB-6
3.1	ANSI/BELL evaluation	TB-6
3.1.1	ANSI/BELL results	TB-6
3.1.2	ANSI/BELL parameter settings	TB-7
3.1.3	Measurement point (SONET Performance Monitoring, PM)	TB-7
3.1.3.1	Section (B1)	TB-7
3.1.3.2	Line (B2SUM)	TB-8
3.1.3.3	STS-Path (B3)	TB-8
3.1.3.4	VT-Path (BIP-V)	TB-9
3.1.3.5	BPV	TB-10
3.1.3.6	DS3 Frame, DS3 P-Parity or DS 3 C-Parity (yellow)	TB-10
3.1.3.7	DS1 Frame or DS1 CRC-6	TB-10
3.1.3.8	TSE	TB-11



3.2	ITU-T G.821 evaluation.	TB-12
3.2.1	G.821 results.	TB-12
3.2.2	G.821 parameter settings	TB-13
3.3	ITU-T G.826 evaluation.	TB-14
3.3.1	G.826 results.	TB-14
3.3.2	G.826 parameter settings	TB-15
3.3.3	G.826 measurement points and anomalies evaluated . . .	TB-16
3.3.4	G.826/G.828/M.2101 blocklengths	TB-17
3.3.4.1	G.826 ISM/G.828/M.2101 (RSOH, MSOH, HP, LP).	TB-17
3.3.4.2	G.826 OOS/G.828 (TSE)/G.829 (TSE)/ M.2100 (TSE)/M.2101 (TSE)	TB-18
3.4	ITU-T G.828 evaluation.	TB-19
3.4.1	G.828 results.	TB-19
3.4.2	G.828 parameter settings	TB-20
3.5	ITU-T G.829 evaluation.	TB-21
3.5.1	G.829 results.	TB-21
3.5.2	G.829 Multiplex section: blocks per second	TB-21
3.5.3	G.829 parameter settings	TB-22
3.6	ITU-T M.2100 evaluation	TB-23
3.6.1	M.2100 results	TB-23
3.6.2	M.2100 parameter settings	TB-24
3.6.2.1	End-to-end error reference performance objectives (EERPO).	TB-25
3.6.2.2	BIS[P]O, S1 and S2: Threshold definition and computing	TB-25
3.7	ITU-T M.2101 evaluation	TB-26
3.7.1	M.2101 results	TB-26
3.7.2	M.2101 parameter settings	TB-27
3.7.2.1	End-to-end performance objectives (EEPO) for M.2101.1 (4/1997).	TB-29
3.7.2.2	End-to-end performance objectives (EEPO) for M.2101 (6/2000)	TB-29
3.7.2.3	BIS[P]O, S1 und S2: Threshold definition and computing for M.2101.1 (4/1997)	TB-30
3.7.2.4	BIS[P]O, S1 und S2: Threshold definition and computing for M.2101 (6/2000).	TB-31
3.7.2.5	SES thresholds	TB-34



Technical Background

1 Multiplexing structures

1.1 SONET Multiplexing Structure ANSI T1.105-1995

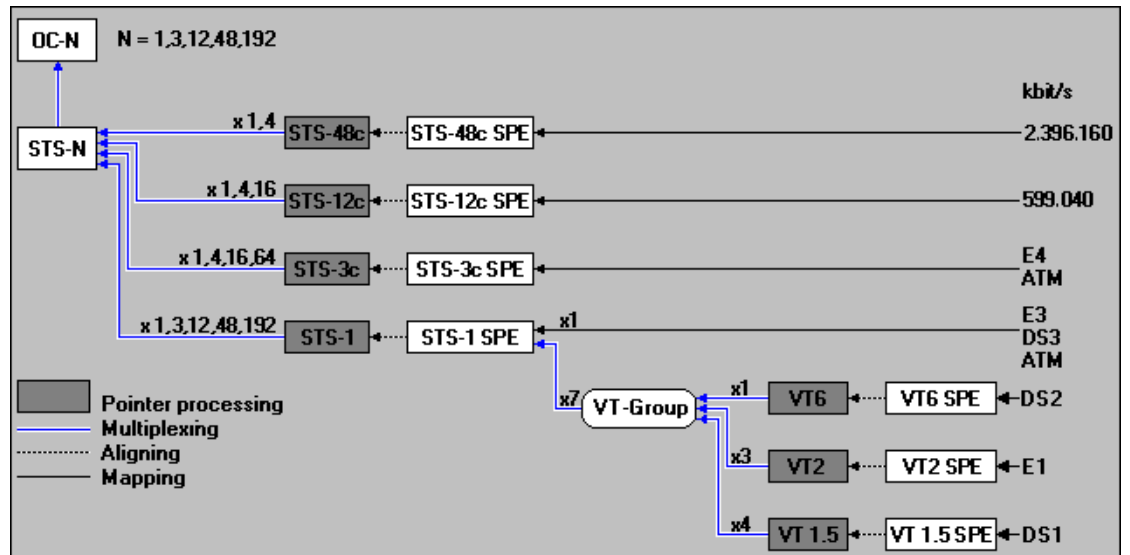

Fig. TB-1 SONET Multiplexing Structure ANSI T1.105-1995

1.2 SDH Multiplexing Structure ITU-T G.707

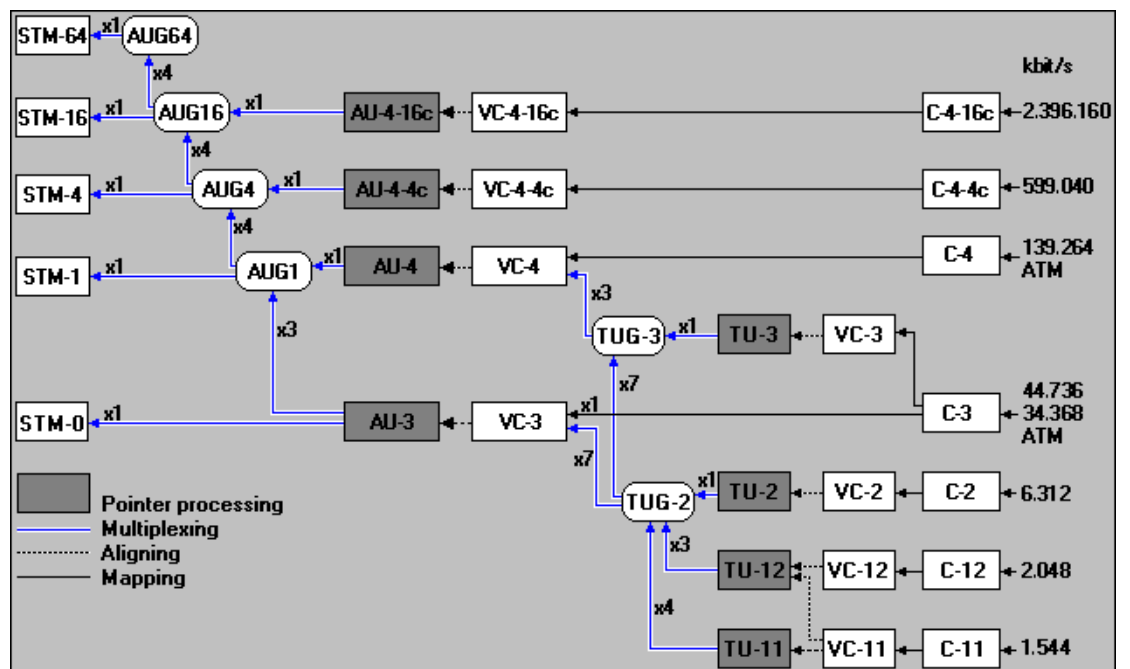

Fig. TB-2 SDH Multiplexing Structure ITU-T G.707



2 Pointer action generation

VIs: "Pointer Generator" and "Pointer Analyzer" (Physical layer instruments)

2.1 Periodic pointers

2.1.1 Identical polarity: "INC" or "DEC"

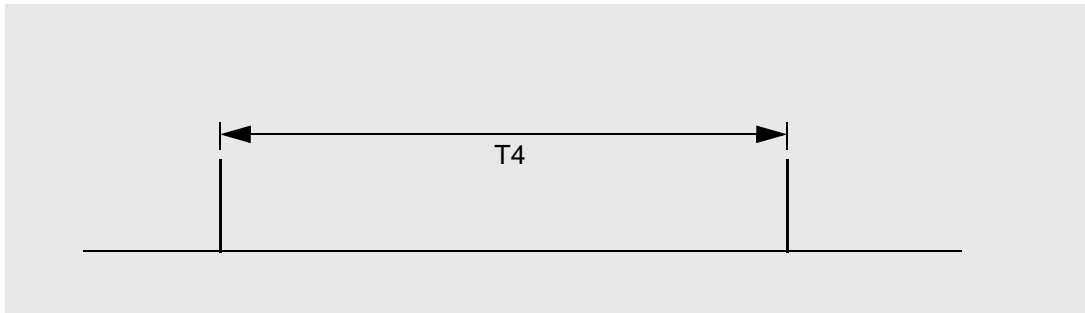

Fig. TB-3 Periodic pointers with identical polarity

2.1.2 Different polarity: "INC / DEC"

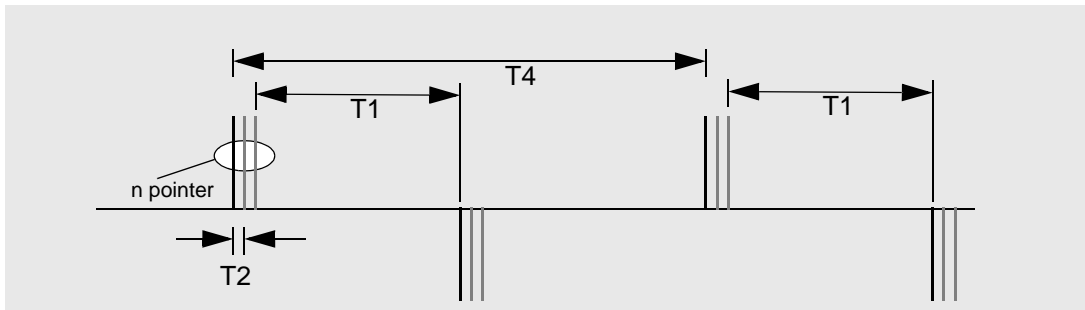

Fig. TB-4 Periodic (single/multiple) pointers with different polarity

2.1.3 Double pointer: "Add (INC, DEC)"

✓ Condition: $T4 = n \times T2$

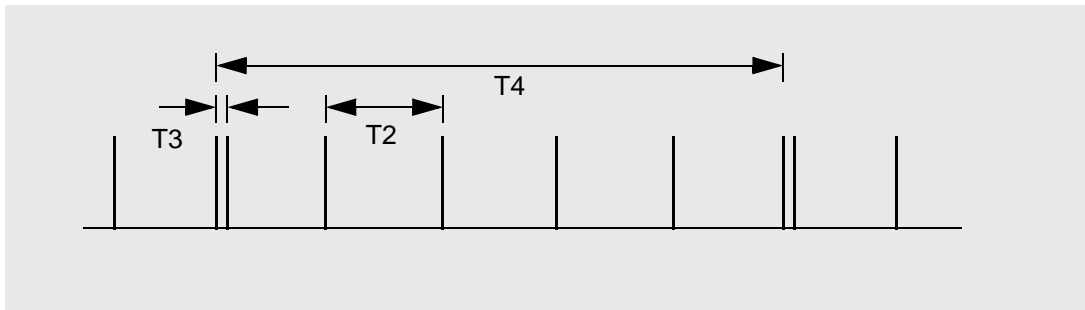

Fig. TB-5 Periodic pointers with different polarity, e.g. $T4 = 5 \times T2$



2.1.4 Messing pointer: "Cancel (INC, DEC)"

✓ Condition: $T4 = n \times T2$

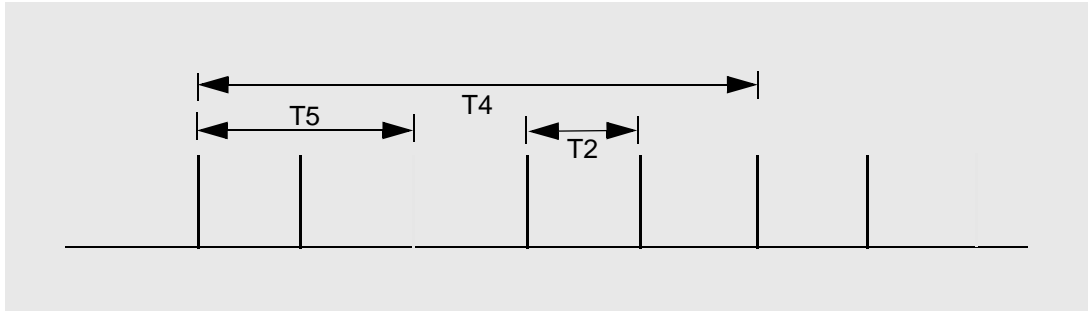

Fig. TB-6 Periodic pointers with one missing pointer, e.g. $T4 = 5 \times T2$

2.2 Pointer burst with missing pointers: "INC" or "DEC" with "Cancel (INC, DEC)"

✓ Condition: $T4 \gg n \times T2$

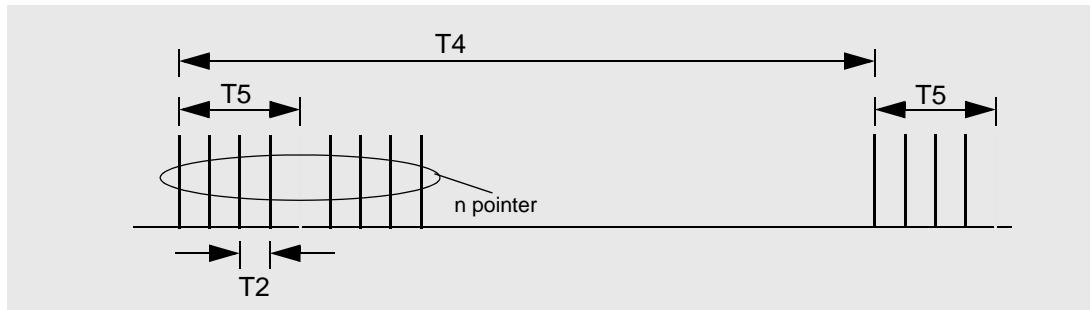

Fig. TB-7 Pointer burst with missing pointers

2.3 Standard sequence

2.3.1 "87-3" sequence

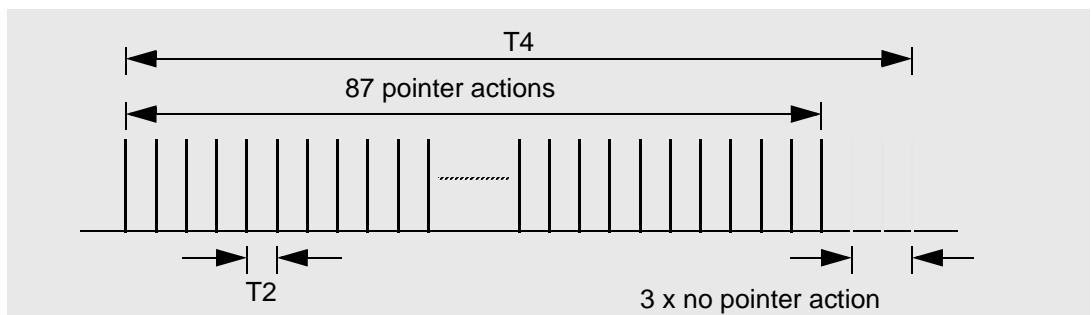

Fig. TB-8 "87-3" sequence



2.3.2 "43-44" sequence with double pointer

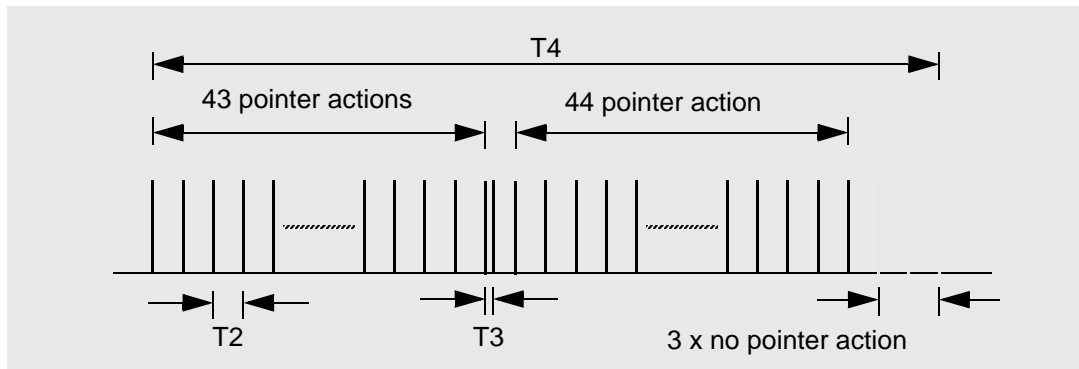

Fig. TB-9 "43-44" sequence with double pointer

2.4 "86-4" sequence with missing pointer

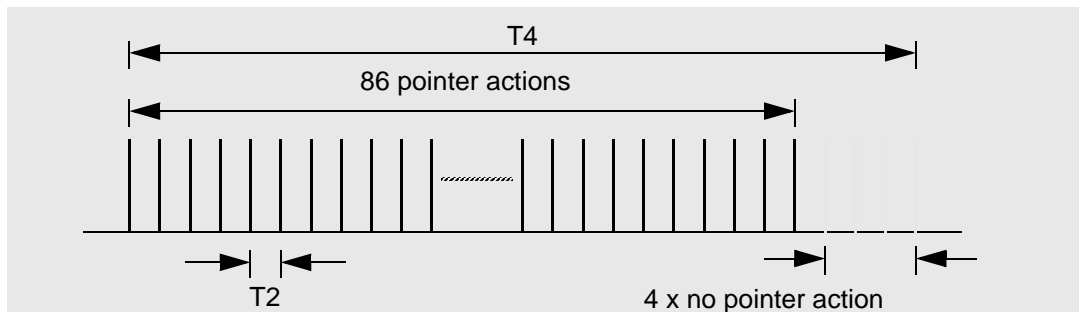

Fig. TB-10 "86-4" sequence with missing pointer

2.5 Setting a new pointer

Setting a new pointer is executed with or without NDF.

Pointer ranges

STS pointer	0 to 782
VT6 pointer	0 to 427
VT2 pointer	0 to 139
VT1.5 pointer.....	0 to 103



2.6 Pointer sequences parameter

T1, T4: 0.25 ms to 600 s(2 to 4800000 frames)
T2, T3: 0.25 ms to 10 s(2 to 80000 frames)
T5: 0 ms to 600 s(0 to 4800000 frames)
n: 1 to 2000



3 Performance Analysis

VI: Performance Analysis (Physical layer instrument)

3.1 ANSI/BELL evaluation

Definitions from GR-253 and T1.231 are used for this performance analysis.

3.1.1 ANSI/BELL results

The following results are determined and displayed:

Error type	Explanation	
ES	Errored Seconds	Seconds containing at least one error.
EFS	Error Free Seconds	Sum of all error free seconds since the start of the measurement.
SES	Severely Errored Seconds	Severely errored seconds (see Sec. 3.1.3, Page TB-7).
SEFS	Severely Errored Frame Seconds	Seconds containing OOF (LOF, LOS) in the Section Analysis.
UAS	Unavailable Seconds	UAS is issued after 10 consecutive SES. The 10 SES are counted towards the UAS total and subtracted from the SES total. UAS is retracted when 10 consecutive seconds without SES occur. These 10 seconds are subtracted from the UAS total. No ES, SES and SEFS are counted during UAS.

Table TB-1 ANSI/BELL evaluation, results

The absolute and percentage values of the results are displayed.

These rules apply: The percentages quoted for ES, SES, SEFS and EFS refer to the available time,
i.e. the measurement time less UAS.

The percentage quoted for UAS refers to the total measurement time:

$ES \text{ (including SES, SEFS)} + EFS = 100\% \text{ (available time)}$

$ES \text{ (including SES, SEFS)} + EFS + UAS = \text{total measurement time.}$

“Far End” evaluation is interrupted if certain alarms occur, e.g. LOS, LOF or AIS. These alarm times are removed from the reference value for calculating the ratio at the “Far end”.



3.1.2 ANSI/BELL parameter settings

If "ANSI/BELL" evaluation is selected, the following parameters are used:

Menu	Explanation
• Hierarchy	Select measurement point and hence the events used to perform the evaluation (see Sec. 3.1.3).
• Settings	For ANSI/BELL evaluation no function.

Table TB-2 ANSI/Bell parameters

3.1.3 Measurement point (SONET Performance Monitoring, PM)

The menu "Hierarchy" can be used for selecting the following Measurement points:

3.1.3.1 Section (B1)

Section Layer PM

Parameter	Criterion	SES thresholds	
SEFS	OOF, LOF, LOS	-	
ES	B1-Bit error ≥ 1 or SEFS	-	
SES	SEF or B1-Bit error $\geq X$	Rate	X
		OC1	52
		OC3	155
		OC12	616
		OC48	2392
OC192	9568		
UAS	SES ≥ 10	-	
EFS	no ES or UAS	-	

Table TB-3 Section Layer PM



3.1.3.2 Line (B2SUM)

Line Layer PM for "Near End"

Parameter	Criterion	SES thresholds	
ES	B2SUM-Bit error ≥ 1 or AIS-L	-	
SES	B2SUM-Bit error $\geq X$ or AIS-L	Rate	X
		OC1 OC3 OC12 OC48 OC192	51 154 615 2459 9836
UAS	SES ≥ 10	-	
EFS	no ES or UAS	-	

Table TB-4 Line Layer PM "Near End"

Line Layer PM for "Far End"

Parameter	Criterion	SES thresholds	
ES	REI-L ≥ 1 or RDI-L	-	
SES	REI-L $\geq X$ or RDI-L	Rate	X
		OC1 OC3 OC12 OC48 OC192	51 154 615 2459 9836
UAS	SES ≥ 10	-	
EFS	no ES or UAS	-	

Table TB-5 Performance Monitoring Line Layer PM "Far End"

3.1.3.3 STS-Path (B3)

STS Path Layer PM for "Near End"

Parameter	Criterion	SES thresholds	
ES	B3 ≥ 1 or AIS-P or LOP-P	-	
SES	B3-Bit error $\geq X$ or AIS-P or LOP-P	SPE	X
		STS1 STS3c STS12c STS48c	2400 2400 2400 2400
UAS	SES ≥ 10	-	
EFS	no ES or UAS	-	

Table TB-6 STS Path Layer PM "Near End"



STS Path Layer PM for "Far End"

Parameter	Criterion	SES thresholds	
ES	REI-P \geq 1 or RDI-P	-	
SES	REI-P \geq X or RDI-P	SPE	X
		STS1	2400
		STS3c	2400
		STS12c	2400
STS48c	2400		
UAS	SES \geq 10	-	
EFS	no ES or UAS	-	

Table TB-7 STS Path Layer PM "Far End"

3.1.3.4 VT-Path (BIP-V)

VT Path Layer PM for "Near End"

Parameter	Criterion	SES thresholds	
ES	BIP-V \geq 1 or AIS-V or LOP-V	-	
SES	BIP-V \geq X or AIS-V or LOP-V	Path	X
		VTx	600
UAS	SES \geq 10	-	
EFS	no ES or UAS	-	

Table TB-8 VT Path Layer PM "Near End"

VT Path Layer PM "Far End"

Parameter	Criterion	SES thresholds	
ES	REI-V \geq 1 or RDI-V	-	
SES	REI-V \geq X or RDI-V	Path	X
		VTx	600
UAS	SES \geq 10	-	
EFS	no ES or UAS	-	

Table TB-9 VT Path Layer PM "Far End"



3.1.3.5 BPV

DSn Performance Monitoring, Line Analysis

Parameter	Criterion	SES thresholds
ES	BPV ≥ 1 or LOS	-
SES	BPV $\geq X$ or LOS	X(DS1) = 1544 X(DS2) = 6312 X(DS3) = 44
UAS	SES ≥ 10	-
EFS	no ES or UAS	-

Table TB-10 DSn Line Analysis

3.1.3.6 DS3 Frame, DS3 P-Parity or DS 3 C-Parity (yellow)

DS3 Path Analysis (FE, Parity, FEBE)

Parameter	Criterion	SES thresholds
ES	EC ¹ ≥ 1 , AIS or OOF or LOF	-
SES	EC ¹ $\geq X$, AIS or OOF or LOF	X = 44
UAS	SES ≥ 10	-
EFS	no ES or UAS	-

1 EC stands for FE, PBit, FEBE or CBit

Table TB-11 DS3 Path Analysis (FE, Parity, FEBE)

3.1.3.7 DS1 Frame or DS1 CRC-6

DS1 Path Analysis (FE, CRC6)

Parameter	Criterion	SES thresholds
ES	FE, CRC ≥ 1 , AIS or OOF or LOF	-
SES	FE $\geq X$, AIS or OOF or LOF CRC $\geq Y$	X = 4 Y = 320
UAS	SES ≥ 10	-
EFS	no ES or UAS	-

Table TB-12 DS1 Path Analysis (FE, CRC6)



3.1.3.8 TSE

Bit Performance Monitoring

Parameter	Criterion	SES thresholds
ES	$TSE \geq 1$ or LSS	-
SES	$TSE \geq X$ or LSS	$X = 10E-3$
UAS	$SES \geq 10$	-
EFS	no ES or UAS	-

Table TB-13 Bit Performance Monitoring



3.2 ITU-T G.821 evaluation

ITU-T G.821 evaluation corresponds to Recommendation G.821 (Issue 07/95).

Degraded minutes (DM) are also evaluated.

The multiplex factor used in older versions of Recommendation G.821 (Annex D) can be applied if required.

3.2.1 G.821 results

The following results are determined and displayed:

Result	Explanation	
ES	Errored Seconds	Errored seconds, as a numerical count and as an error rate.
EFS	Error Free Seconds	Determined as error count and error rate.
SES	Severely Errored Seconds	Determined as error count and error rate.
DM	Degraded Minutes	Number and ratio of degraded minutes.
UAS	Unavailable Seconds	Number and ratio of unavailable seconds.
VERDICT		Accepted/Rejected; Overall assessment of path: accepted/rejected. The ES and SES error ratios are compared with the appropriate target values.
PATH ALLOCATION		Path allocation setting.

Table TB-14 G.821 evaluation, results



3.2.2 G.821 parameter settings

If "G.821" evaluation is selected, the following parameters are used:

Menu	Item	Explanation
<ul style="list-style-type: none"> • Hierarchy 	Select measurement point and hence the events used to perform the evaluation.	
	PDH 140 Mb	FAS140 bit error
	PDH 34 Mb	FAS34 bit error
	PDH 8 Mb	FAS8 bit error
	PDH 2 Mb CRC4	CRC4 word error
	PDH 2 Mb EBIT	EBIT error
	PDH 2 Mb FAS	FAS2 bit error
	TSE	bit error
<ul style="list-style-type: none"> • Settings 	Dialog window for input of the following parameters:	
	Allocation ¹	Entry of path allocation in percent (%): Setting range: 0.1% to 100% Step width: 0.1% Default: 100% The actual limit values for ESR and SESR are calculated internally: "HRX ESR" limit value = 8% x Allocation "HRX SESR" limit value = 0.1% + (0.1% x Allocation)
	SES-Threshold ²	Threshold for SES count: Setting range: 1E-2 to 1E-5 Setting values: 1E-2, 1E-3, 1E-4, 1E-5 Default: 1E-3
	DM Threshold ³	Threshold for DM count: Setting range: 1E-4 to 1E-7 Setting values: 1E-4, 1E-5, 1E-6, 1E-7 Default: 1E-6
	MUX Factor	Multiplex factor input: Off: Evaluation to the latest G.821 recommendation ⁴ On: Evaluation to older G.821 recommendation ⁵ Multiplex factor N = measurement bit rate/64 kbit/s. Default: Off
<p>1 "Allocation" indicates the percentage of the "End to End" target values for ESR (Errored Seconds Ratio) and SESR (Severely Errored Seconds Ratio) which must be met for the measured path to be acceptable (VERDICT = Accepted). The "End to End" target values are based on the "Hypothetical Reference Configuration" (HRX) of length 27 500 km. The following "End to End" target values are specified by G.821: SESR <0.1%, ESR <8%. The "End-to-End" target values for DM (Degraded Minutes) corresponding to older G.821 recommendations are not taken into account.</p> <p>2 This threshold indicates the bit error rate above which a second is counted as an SES (Severely Errored Second)</p> <p>3 This threshold indicates the bit error rate above which DM (Degraded Minutes) are evaluated.</p> <p>4 Regardless of the bitrate, an ES is a second in which at least one error occurs.</p> <p>5 According to annex D. ES is a second in which at least n errors occurred.</p>		

Table TB-15 G.821 parameter settings



3.3 ITU-T G.826 evaluation

The ANT-20SE can perform “In Service” (ISM) and “Out of Service” (OOS) G.826 evaluation.

3.3.1 G.826 results

The following results are determined and displayed:

Result	Explanation	
EB	Errored Blocks	Count of errored blocks
BBE	Background Block Errors	Errored blocks not in SES as a count and as an error rate.
ES	Errored Seconds	Errored seconds as a count and as an error rate
EFS	Error Free Seconds	Error-free seconds as a count and as an error rate
SES	Severely Errored Seconds	Severely errored seconds as a count and as an error rate
UAS	Unavailable Seconds	Unavailable seconds as a count and as an error rate
VERDICT		Accepted/Rejected: Overall assessment of the path quality.
PATH ALLOCATION		Path allocation setting
PATH UAS		For “Far End” measurements, the “Unavailable Seconds” (UAS) are determined for the complete path (Path UAS). They are determined from the “Near End” and “Far End” results using a logical OR function.

Table TB-16 G.826 evaluation, results

The following is recorded in the header line of the results table:

- Measurement point used to determine the results.
- Anomaly used to perform the “Near End” measurement.
- Anomaly used to perform the “Far End” measurement.

Example

G.826: PDH2CRC NEAR END: CRC4 FAR END: EBIT

A set of results for the “Near End” and for the “Far End” is determined in each case.

The PATH ALLOCATION is also displayed.

The “Unavailable Seconds” (UAS) for the entire path (Path UAS) are also determined in “Far End” measurements. The “Path UAS” result is determined by logically ORing the “Near End” and “Far End” UAS results.

The message “Attention: Check TIM/PLM Defect Evaluation please!” may be displayed. This message indicates that you should check to see if evaluation of both these alarms has been activated. These defects should normally be considered in a G.826 evaluation. Evaluation is enabled or disabled in the “Overhead Analyzer”.



3.3.2 G.826 parameter settings

If "G.826 ISM" or "G.826 OOS" evaluation is selected, the following parameters are used:

Menu	Item	Explanation
• Hierarchy		Select measurement point and hence the events used to perform the evaluation (see Tab. TB-18). For G.826 OOS not available.
• Settings		Dialog window for input of the following parameters:
	Allocation ¹	Entry of path allocation in percent (%): Setting range: 0.1% to 100% Step width: 0.1% Default: 18.5%
	SES-Threshold ²	Threshold for SES count Setting range: 1 to 47563 Step width: 1 Default value as per G.826 (depends on signal structure).
	UAS-Limit	Switch and threshold value for taking UAS into account in the path status (VERDICT) Off: UAS do not affect the path status. On: If the UAS threshold is exceeded, the path status is assessed as "Rejected". Setting range: 0 to 100000 Step width: 1 Default: 0
	UAS-Mode	Switch for separate or common rating of UAS for "Near" and "Far End". Individual: Separate rating of UAS for "Near" and "Far End". Global: Common rating of UAS for "Near" and "Far End". The total path is "unavailable" as soon as one side is "unavailable". Default: Individual.
<p>1 "Allocation" indicates what percentage of the "End to End" target values for ESR (Errored Seconds Ratio), SESR (Severely Errored Seconds Ratio) and BBER (Background Block Error Ratio) must be met for the measured path to be considered acceptable. The "End to End" target values are based on a hypothetical path of length 27 500 km. The target values for various system bit rates are specified in Recommendation G.826.</p> <p>2 This threshold indicates the number of EB (Errored Blocks) required before a one-second period is evaluated as SES (Severely Errored Second).</p>		

Table TB-17 G.826 parameter settings



3.3.3 G.826 measurement points and anomalies evaluated

- The measurement point where the G.826 ISM evaluation is made, is selected in the “Hierarchy” menu. In the case of G.826 OOS, there is no “Hierarchy” menu, and evaluation is always made on bit errors (TSE).
- “Near End” and “Far End” evaluations are simultaneous as soon as the set signal structure allows the “Far End” measurement to be made.
The “Far End” evaluation requires the presence of REI or EBIT.

G.826: measurement point	NEAR END: anomalies	FAR END: anomalies
G.826: RSOH	B1	no evaluation
G.826: MSOH	B2SUM	MS-REI
G.826: HP-POH	HP-B3	HP-REI
G.826: LP-POH	LP-BIP8	LP-REI
G.826: LP-POH	LP-BIP2	LP-REI
G.826: PDH140	FAS140	no evaluation
G.826: PDH34	FAS34	no evaluation
G.826: PDH8	FAS8	no evaluation
G.826: PDH2	FAS2	no evaluation
G.826: PDH2CRC	CRC4	EBIT
G.826: DS3 P-Parity	P bits	no evaluation
G.826: DS3 C-Parity	CP bits	FEBE bits
G.826: DS3-FAS	frame error DS3	no evaluation
G.826: DS1-CRC6	CRC-6 error	no evaluation
G.826: DS1-FAS	frame error DS1	no evaluation
G.826: 140M G832	FAS140	no evaluation
G.826: 140M G832	EM140	REI
G.826: 34M G832	FAS34	no evaluation
G.826: 34M G832	EM34	REI
G.826: OOS	TSE	no evaluation

Table TB-18 G.826 measurement points and anomalies evaluated



3.3.4 G.826/G.828/M.2101 blocklengths

3.3.4.1 G.826 ISM/G.828/M.2101 (RSOH, MSOH, HP, LP)

Measurement point	Blocklength [time]	Blocklength [bit]
RSOH / STM64 B1	125 μ s	1244160
RSOH / STM16 B1	125 μ s	311040
RSOH / STM4 B1	125 μ s	77760
RSOH / STM1 B1	125 μ s	19440
RSOH / STM0 B1	125 μ s	6480
MSOH / STM64 B2SUM	125 μ s	1225728
MSOH / STM16 B2SUM	125 μ s	306432
MSOH / STM4 B2SUM	125 μ s	76608
MSOH / STM1 B2SUM	125 μ s	19152
MSOH / STM0 B2SUM	125 μ s	6384
HP-POH / AU-4 VC-4-16C B3	125 μ s	300672
HP-POH / AU-4 VC-4-4C B3	125 μ s	75168
HP-POH / AU-4 VC-4 B3	125 μ s	18792
HP-POH / AU-3 VC-3 B3	125 μ s	6264
LP-POH / AU-4 VC-3 BIP8	125 μ s	6120
LP-POH / VC-2 BIP2	500 μ s	3424
LP-POH / VC-12 BIP2	500 μ s	1120
LP-POH / VC-11 BIP2	500 μ s	832
FAS140	21 μ s	12
FAS34	44.7 μ s	10
FAS8	100.4 μ s	10
PDH2FAS	250 μ s	7
PDH2CRC	1 ms	2048
DS3 FAS	106 μ s	56
DS3 C-Parity	106 μ s	4760
DS3 P-Parity	106 μ s	4760
DS1/SF FAS	1.5 ms	12
DS1/ESF FAS	3 ms	24
DS1/ESF CRC6	3 ms	4632
140M G832 FAS	125 μ s	16

Table TB-19 G.826 ISM/G.828/M.2101 (RSOH, MSOH, HP, LP), blocklength



Measurement point	Blocklength [time]	Blocklength [bit]
140M G832 EM	125 µs	17408
34M G832 FAS	125 µs	16
34M G832 EM	125 µs	4296

Table TB-19 G.826 ISM/G.828/M.2101 (RSOH, MSOH, HP, LP), blocklength (*continued*)

3.3.4.2 G.826 OOS/G.828 (TSE)/G.829 (TSE)/M.2100 (TSE)/M.2101 (TSE)

Measurement point	Blocklength [time]	Blocklength [bit]
DS1 unframed	3 ms	4632
DS1/ESF framed pattern	3 ms	4608
DS1/SF framed pattern	1.5 ms	2304
VC11 Bulk	3 ms	4800
Nx64	1 ms	N x 64
Overhead Bytes RSOH: E1, F1, D1 to D3 MSOH: D4 to D12, E2 POH: F2, F2L	1 ms	N x 64
2M unframed	1 ms	2048
PCM31 framed pattern	1 ms	1984
PCM30 framed pattern	1 ms	1920
VC12 Bulk	1 ms	2176
8M unframed	500 µs	4224
8M framed pattern	500 µs	4168
VC2 Bulk	500 µs	3392
DS2 unframed	500 µs	3160
34M unframed	125 µs	4296
34M framed pattern	125 µs	4264
VC3 Bulk	125 µs	6048
DS3 unframed	106 µs	4760
DS3 framed pattern	106 µs	4704
140M unframed	125 µs	17408
140M framed pattern	125 µs	17312
VC4 Bulk	125 µs	18720
VC4-4c Bulk	125 µs	74880
VC4-16c Bulk	125 µs	299520

Table TB-20 G.826 OOS/G.828 (TSE)/G.829 (TSE)/M.2100 (TSE)/M.2101 (TSE), blocklength



3.4 ITU-T G.828 evaluation

G.828 evaluation conforms to ITU-T Recommendation dated 3/2000. The G.828 standard is a further development of Recommendation G.826 for synchronous digital paths.

Recommendation G.828 specifies additional measurement values and measurement points:

- SEP (Severely Errored Period, declared as optional)
- Performance measurement on TCM bytes (in preparation for ANT-20)

G.828 evaluation can be performed on the following events:

- B1
- B2SUM
- MS-REI
- B3
- HP-REI
- LP-BIP 2/8
- LP-REI
- Bit errors (TSE) blocks per s

3.4.1 G.828 results

The following results are determined and displayed:

Result	Explanation	
ES	Errored Seconds	Errored seconds as a count and as an error rate
EFS	Error Free Seconds	Error-free seconds as a count and as an error rate
SES	Severely Errored Seconds	Severely errored seconds as a count and as an error rate
BBE	Background Block Error	Number and ratio of background block errors
SEP	Severely Errored Period	Number and ratio of severely errored periods (number of SES between 3 and 9)
UAS	Unavailable Seconds	Unavailable seconds as a count and as an error rate
VERDICT	-	Accepted/Uncertain/Rejected: Overall assessment of the path quality
PATH ALLOCATION	-	Path allocation setting
PATH UAS	-	For "Far End" measurements, the "Unavailable Seconds" (UAS) are determined for the complete path (Path UAS). They are determined from the "Near End" and "Far End" results using a logical OR function.

Table TB-21 G.828 evaluation, results



3.4.2 G.828 parameter settings

If “G.828” evaluation is selected, the following parameters are used:

Menu	Item	Explanation
• Hierarchy	Select measurement point and hence the events used to perform the evaluation.	
	RSOH B1	B1 block errors
	MSOH B2SUM	Common evaluation of B2 and MS-REI block errors
	HP B3	Common evaluation of B3 and HP-REI block errors
	LP BIP2/8	Common evaluation of BIP2/8 and LP-REI block errors
	TCM ¹	TC-Diff block error
	TSE	Bit errors
• Settings	Dialog window for input of the following parameters:	
	Allocation ²	Entry of path allocation in percent (%): Setting range: 0.1% to 100% Step width: 0.1% Default: 18.5%
	SES-Threshold ³	Threshold for SES count Setting range: 1 to 8000 Step width: 1 Default value as per G.828 (depends on signal structure).
	UAS-Limit	Switches and threshold for taking UAS into account in the path status (VERDICT): Off: UAS have no influence on path status. On: If UAS limit exceeded, path status is rated as “Rejected” Setting range: 0 to 100000 Step width: 1 Default: 0
	UAS-Mode	Switch for separate or common rating of UAS for “Near” and “Far End”. Individual: Separate rating of UAS for “Near” and “Far End”. Global: Common rating of UAS for “Near” and “Far End”. The total path is “unavailable” as soon as one side is “unavailable”. Default: Individual.
SEP used in Verdict	Toggle for including SEP in the verdict. The measurement values are determined and displayed regardless of the toggle setting. Default: ON	
<p>¹ In preparation</p> <p>² “Allocation” indicates how many percent of the end-to-end target specs are to be met for the path under test to be acceptable.</p> <p>³ This threshold indicates the number of EB (Errored Blocks) required before a one-second period is evaluated as SES (Severely Errored Second).</p>		

Table TB-22 G.828 parameter settings



3.5 ITU-T G.829 evaluation

G.829 evaluation conforms to ITU-T Recommendation dated 3/2000. The G.829 standard describes the recording and classification of error performance events for SDH multiplex and regenerator-sections. The Recommendation does not discuss allocations and does not specify objectives to be met. An assessment verdict is therefore not possible. The measured values are determined on a block basis in the sense that the individual bits of an EDC (Error Detection Code) each monitor separate blocks. This is in contrast with the G.826 and G.828 evaluations, where the entire EDC only monitors a single block in each case.

G.829 evaluation can be performed on the following events:

- B1
- B2SUM
- MS-REI
- Bit errors (TSE)

3.5.1 G.829 results

The following results are determined and displayed:

Result	Explanation	
ES	Errored Seconds	Errored seconds as a count and as an error rate
EFS	Error Free Seconds	Error-free seconds as a count and as an error rate
SES	Severely Errored Seconds	Severely errored seconds as a count and as an error rate
BBE	Background Block Error	Number and ratio of background block errors
UAS	Unavailable Seconds	Unavailable seconds as a count and as an error rate

Table TB-23 G.829 evaluation, results

3.5.2 G.829 Multiplex section: blocks per second

Bit rate	Block length	Blocks per frame	Blocks per second	Error detection code
STM-0	801 Bits	8	64 000	8xBIP-1
STM-1	801 Bits	24	192 000	24xBIP-1
STM-4	801 Bits	96	768 000	96xBIP-1
STM-16	801 Bits	384	3 072 000	384xBIP-1
STM-64	801 Bits	1 536	12 288 000	1536xBIP-1

Table TB-24 G.829 evaluation, Multiplex section: blocks per second



3.5.3 G.829 parameter settings

If “G.828” evaluation is selected, the following parameters are used:

Menu	Item	Explanation
• Hierarchy	Select measurement point and hence the events used to perform the evaluation.	
	RSOH B1	B1 block error
	MSOH B2SUM	B2 and MS-REI block error
	TSE	Bit errors
• Settings	Dialog window for input of the following parameters:	
	SES-Threshold ¹	Threshold for SES count Setting range: 1 to 2 147 483 647 Step width: 1 Default value as per G.829 (depends on signal structure).
<p>¹ This threshold indicates the number of EB (Errored Blocks) required before a one-second period is evaluated as SES (Severely Errored Second).</p>		

Table TB-25 G.829 parameter settings



3.6 ITU-T M.2100 evaluation

ITU-T M.2100 evaluation conforms to Recommendation M.2100 07/95.

The M.2100 evaluation can be performed on the following events:

- Bit errors (TSE)
- FAS bit errors (FAS1.5, FAS2, FAS8, FAS34, FAS45 and FAS140)
- CRC errors (CRC-4 and CRC-6)
- EBIT errors
- PBIT errors

3.6.1 M.2100 results

The following results are determined and displayed:

Result	Explanation	
ES	Errored Seconds	Errored seconds as a count and as an error rate
EFS	Error Free Seconds	Error-free seconds as a count and as an error rate
SES	Severely Errored Seconds	Severely errored seconds as a count and as an error rate
UAS	Unavailable Seconds	Unavailable seconds as a count and as an error rate
VERDICT	-	Accepted/Uncertain/Rejected: Overall assessment of the path quality
ALLOCATION	-	Path allocation setting
BISO-ES, ES-S1, ES-S2	-	Threshold values, calculated internally
BISO-SES, SES-S1, SES-S2	-	Threshold values, calculated internally

Table TB-26 M.2100 evaluation, results



3.6.2 M.2100 parameter settings

If “M.2100” evaluation is selected, the following parameters are used:

Menu	Item	Explanation
• Hierarchy	Select measurement point and hence the events used to perform the evaluation.	
	PDH 140 Mb	FAS140 bit error
	PDH 34 Mb	FAS34 bit error
	PDH 8 Mb	FAS8 bit error
	PDH 2 Mb CRC4	CRC4 word error ¹
	PDH 2 Mb FAS	FAS2 bit error
	DS3	P-Bit Error
	DS3	FAS45 bit error
	DS1	CRC6 word error
	DS1	FAS1.5 bit error
	TSE	bit error
• Settings	Dialog window for input of the following parameters:	
	Allocation ²	Entry of path allocation in percent (%): Setting range: 0.1% to 100% Step width: 0.1% Default: 100%
	BISO Multiplier ³	Weighting factor for BIS[P]O ⁴ Setting range: 0.1 to 100 Step width: 0.1 Default: 1.0
	UAS-Limit	Switches and threshold for taking UAS into account in the path status (VERDICT): Off: UAS have no influence on path status. On: If UAS limit exceeded, path status is rated as “Rejected” Setting range: 0 to 100000 Step width: 1 Default: 0
UAS-Mode	Switch for separate or common rating of UAS for “Near” and “Far End”. Individual: Separate rating of UAS for “Near” and “Far End”. Global: Common rating of UAS for “Near” and “Far End”. The total path is “unavailable” as soon as one side is “unavailable”. Default: Individual.	
<p>1 CRC4 word error and EBIT error are computed parallel.</p> <p>2 “Allocation” indicates how many percent of the end-to-end target specs are to be met for the path under test to be acceptable (see Tab. TB-28).</p> <p>3 The BISO value is internally computed for ES and SES (see Sec. 3.6.2.2).</p> <p>4 Bringing into Service (Performance) Objectives.</p>		

Table TB-27 M.2100 parameter settings



3.6.2.1 End-to-end error reference performance objectives (EERPO)

Network level	Max. ES % of time	Max. SES % of time
64 kbit/s	4.0	0.1
Primary	2.0	0.1
Secondary	2.5	0.1
Tertiary	3.75	0.1
Quaternary	8.0	0.1

Table TB-28 EERPO: End-to-end error reference performance objectives

3.6.2.2 BIS[P]O, S1 and S2: Threshold definition and computing

The BISO value is internally computed for ES and SES. It is defined as follows:

$$\text{BISO ES[SES]} = (\text{Allocation} \times \text{EERPO ES[SES]} \times \text{Test Period} \times \text{BISO Multiplier}) / 2$$

From BISO, the thresholds S1 and S2 are computed for ES and SES:

$$\text{S1 Limit ES[SES]} = \text{BISO ES[SES]} - 2 \times \text{sqrt}(\text{BISO ES[SES]})$$

$$\text{S2 Limit ES[SES]} = \text{BISO ES[SES]} + 2 \times \text{sqrt}(\text{BISO ES[SES]})$$

For meas. times ≤ 15 minutes: BISO = S1 = S2 = 0

For meas. times ≥ 7 days: BISO = S1 = S2

The computed values for BISO, S1 and S2 for ES and SES are displayed below the result page.

For determining the path status, the measurement results are compared with the thresholds S1 and S2 as follows:

Meas. value ES or SES > S2 or EFS = 0:	Path status = rejected
Meas. value ES or SES between S1 and S2:	Path status = uncertain
Meas. value ES and SES \leq S1:	Path status = accepted

Meas. value UAS may also be taken into account, cf. switch UAS-limit (see Tab. TB-27).



3.7 ITU-T M.2101 evaluation

M.2101 evaluation takes the issue of Recommendation M.2101 dated 6/2000 as well as the version M.2101.1 of April 1997 into account. You can switch between the two versions via a list box in the “Settings” menu. The main differences between the Recommendation M.2101 (4/1997) and the Recommendation M.2101 (6/2000) concern additional measurement values as well as differences in the error performance objectives:

- BBE (Background Block Error)
- SEP (Severely Errored Period)
- Performance measurement on TCM bytes (in preparation for ANT-20)

SEP evaluation is optional in the new Recommendation M.2101 (6/2000). The “Settings” menu therefore includes a separate switch for including or excluding SEP from the assessment verdict.

M.2101 evaluation can be performed on the following events:

- B1
- B2SUM
- MS-REI
- B3
- HP-REI
- LP-BIP 2/8
- LP-REI
- Bit errors (TSE)

3.7.1 M.2101 results

The following results are determined and displayed:

Result	Explanation	
ES	Errored Seconds	Errored seconds as a count and as an error rate
EFS	Error Free Seconds	Error-free seconds as a count and as an error rate
SES	Severely Errored Seconds	Severely errored seconds as a count and as an error rate
BBE	Background Block Error	Number and ratio of background block errors
SEP	Severely Errored Period	Number and ratio of severely errored periods (number of SES between 3 and 9)
UAS	Unavailable Seconds	Unavailable seconds as a count and as an error rate
VERDICT	-	Accepted/Uncertain/Rejected: Overall assessment of the path quality
ALLOCATION	-	Path allocation setting
BISO-ES, ES-S1, ES-S2	-	Threshold values, calculated internally

Table TB-29 M.2101 evaluation, results



Result	Explanation	
BISO-SES, SES-S1, SES-S2	-	Threshold values, calculated internally
BISO-BBE, BBE-S1, SES-S2	-	Threshold values, calculated internally
BISO-SEP, SEP-S1, SEP-S2	-	Threshold values, calculated internally

Table TB-29 M.2101 evaluation, results

3.7.2 M.2101 parameter settings

If "M.2101" evaluation is selected, the following parameters are used:

Menu	Item	Explanation
• Hierarchy		Select measurement point and hence the events used to perform the evaluation.
	RSOH B1	B1 block errors
	MSOH B2SUM	Common evaluation of B2 and MS-REI block errors
	HP B3	Common evaluation of B3 and HP-REI block errors
	LP BIP2/8	Common evaluation of BIP2/8 and LP-REI block errors
	TSE	Bit errors
• Settings		Dialog window for input of the following parameters:
	Allocation ¹	Entry of path allocation in percent (%): Setting range: 0.1% to 100% Step width: 0.1% Default: 100%
	BISO Multiplier ²	Weighting factor for BIS[P]O ³ Setting range: 0.1 to 100 Step width: 0.1 Default: 1.0
	UAS-Limit	Switches and threshold for taking UAS into account in the path status (VERDICT): Off: UAS have no influence on path status. On: If UAS limit exceeded, path status is rated as "Rejected" Setting range: 0 to 100000 Step width: 1 Default: 0
	UAS-Mode ⁴	Switch for separate or common rating of UAS for "Near" and "Far End". Individual: Separate rating of UAS for "Near" and "Far End". Global: Common rating of UAS for "Near" and "Far End". The total path is "unavailable" as soon as one side is "unavailable". Default: Individual.

Table TB-30 M.2101 parameter settings



	M.2101-Version	This list box allows you to select between evaluation according to M.2101.1 (4/1977) or M.2101 (6/2000). The two Recommendations differ in the specified performance objective values. The newer Recommendation also includes evaluation of BBE and SEP. Default: 6/2000
	SEP used in Verdict ⁵	Toggle for including SEP in the verdict. The measurement values are determined and displayed regardless of the toggle setting. Default: ON
<p>1 "Allocation" indicates how many percent of the end-to-end target specs are to be met for the path under test to be acceptable (see Tab. TB-32).</p> <p>2 The BISO value is internally computed for ES and SES (see Sec. 3.7.2.3).</p> <p>3 Bringing into Service (Performance) Objectives.</p> <p>4 Only selectable for meas. points for which both near end and far end are evaluated</p> <p>5 SEP is only included in the verdict for measurement times ≥ 7 days.</p>		

Table TB-30 M.2101 parameter settings (continued)



3.7.2.1 End-to-end performance objectives (EEPO) for M.2101.1 (4/1997)

The End to End Performance Objectives (EEPOs) are listed in table 3 of the M.2101.1 recommendation of 04/1997:

Bit rate	EEPO values for ¹	
	ESR	SESR
≤ 5 Mbit/s	2%	0.1%
5 Mbit/s ≤ Bit rate ≤ 15 Mbit/s	2.5 %	0.1%
15 Mbit/s ≤ Bit rate ≤ 55 Mbit/s	3.75%	0.1%
55 Mbit/s ≤ Bit rate ≤ 160 Mbit/s	8%	0.1%
160 Mbit/s ≤ Bit rate ≤ 3500 Mbit/s	NA ²	0.1%
> 3500 Mbit/s	NA ²	0.1%

1 There is no BBE and no SEP in the M.2101.1 recommendation of 4/1997.
 2 NA (Not Applicable) means that this value is **not** taken into account in the "VERDICT".

Table TB-31 End to End Performance Objectives (EEPOs) from the recommendation M.2101.1 (4/1997)

3.7.2.2 End-to-end performance objectives (EEPO) for M.2101 (6/2000)

The End to End Performance Objectives (EEPOs) are listed in the following tables of the Recommendation M.2101 (06/2000):

Table 3a/M.2101: International **paths**

Table 3b/M.2101: International **multiplex sections**

The following values are used for measurement points that are not defined in the recommendation:

Measurement point	Bit rate	EEPO values for			
		ESR	SESR	SEP ¹	BBER
M.2101: RSOH B1	STM-0	1%	0.1%	1E-4	2.5E-5
	STM-1	2%	0.1%	1E-4	5E-5
	STM-4 bis STM-64	NA ²	0.1%	1E-4	5E-5
M.2101: TSE	≤ 15 Mbit/s	0.5%	0.1%	1E-4	2.5E-5
	15 Mbit/s < Bit rate ≤ 55 Mbit/s	1%	0.1%	1E-4	2.5E-5
	> 55 Mbit/s	2%	0.1%	1E-4	5E-5
	VC4-nC	NA ²	0.1%	1E-4	5E-5

1 SEP is only included in the verdict for measurement times ≥ 7 days.
 2 NA (Not Applicable) means that this value is not taken into account in the "VERDICT"

Table TB-32 End-to-end performance objectives (EEPO) that are not defined in the recommendation



3.7.2.3 BIS[P]O, S1 und S2: Threshold definition and computing for M.2101.1 (4/1997)

The BISO value is internally computed for ES, SES, BBE and SEP. The threshold values S1 and S2 are also determined from BISO. The values calculated for BISO, S1 and S2 are displayed on the results page.

The BISO value is computed as follows:

Path section (B3, LPBIP 2/8) and regenerator section (B1)	
	$\text{BISO ES} = (\text{Allocation} \times \text{EEPO ES} \times \text{Test Period} \times \text{BISO Multiplier})/2$ $\text{S1 Limit ES} = \text{BISO ES} - 2 \times \text{sqrt}(\text{BISO ES})$ $\text{S2 Limit ES} = \text{BISO ES} + 2 \times \text{sqrt}(\text{BISO ES})$
	$\text{BISO SES} = (\text{Allocation} \times \text{EEPO SES} \times \text{Test Period} \times \text{BISO Multiplier})/2$ $\text{S1 Limit SES} = \text{BISO SES} - 2 \times \text{sqrt}(\text{BISO SES})$ $\text{S2 Limit SES} = \text{BISO SES} + 2 \times \text{sqrt}(\text{BISO SES})$

Table TB-33 "BISO" formulae for the path section (B3, LPBIP 2/8) and regenerator section (B1)

Multiplex section (B2SUM)	
	$\text{BISO ES} = (\text{Allocation} \times \text{EEPO ES} \times \text{Test Period} \times \text{BISO Multiplier})/10$ $\text{S1 Limit ES} = \text{BISO ES} - 2 \times \text{sqrt}(\text{BISO ES})$ $\text{S2 Limit ES} = \text{BISO ES} + 2 \times \text{sqrt}(\text{BISO ES})$
	$\text{BISO SES} = (\text{Allocation} \times \text{EEPO SES} \times \text{Test Period} \times \text{BISO Multiplier})/10$ $\text{S1 Limit SES} = \text{BISO SES} - 2 \times \text{sqrt}(\text{BISO SES})$ $\text{S2 Limit SES} = \text{BISO SES} + 2 \times \text{sqrt}(\text{BISO SES})$

Table TB-34 "BISO" formulae for the multiplex section (B2SUM)

Measurements on patterns (TSE)	
	$\text{BISO ES} = (\text{Allocation} \times \text{EEPO ES} \times \text{Test Period} \times \text{BISO Multiplier})/2$ $\text{S1 Limit ES} = \text{BISO ES} - 2 \times \text{sqrt}(\text{BISO ES})$ $\text{S2 Limit ES} = \text{BISO ES} + 2 \times \text{sqrt}(\text{BISO ES})$
	$\text{BISO SES} = (\text{Allocation} \times \text{EEPO SES} \times \text{Test Period} \times \text{BISO Multiplier})/2$ $\text{S1 Limit SES} = \text{BISO SES} - 2 \times \text{sqrt}(\text{BISO SES})$ $\text{S2 Limit SES} = \text{BISO SES} + 2 \times \text{sqrt}(\text{BISO SES})$

Table TB-35 "BISO" formulae for measurements on patterns (TSE)

The measurement results are compared with the threshold values S1 and S2 as follows when determining the section status (Verdict).

Measured value of ES [SES, BBE, SEP] > S2 or EFS = 0: Path status = rejected
 Measured value of ES [SES, BBE, SEP] between S1 and S2: Path status = uncertain
 Measured value of ES [SES, BBE, SEP] ≤ S1: Path status = accepted

Meas. value UAS may also be taken into account, cf. switch UAS-limit (see Tab. TB-30).



3.7.2.4 BIS[P]O, S1 und S2: Threshold definition and computing for M.2101 (6/2000)

The BISO value is internally computed for ES, SES, BBE and SEP. The threshold values S1 and S2 are also determined from BISO. The values calculated for BISO, S1 and S2 are displayed on the results page.

The BISO value is computed as follows:

Path section (B3, LPBIP 2/8) and regenerator section (B1)	
	BISO ES = (Allocation x EEPO ES x Test Period x BISO Multiplier)/2 S1 Limit ES = BISO ES - 2 x sqrt(BISO ES) S2 Limit ES = BISO ES + 2 x sqrt(BISO ES)
	BISO SES = (Allocation x EEPO SES x Test Period x BISO Multiplier)/2 S1 Limit SES = BISO SES - 2 x sqrt(BISO SES) S2 Limit SES = BISO SES + 2 x sqrt(BISO SES)
	BISO SEP = (Allocation x EEPO SEP x Test Period x BISO Multiplier)/2 S1 Limit SEP = BISO SEP - 2 x sqrt(BISO SEP) S2 Limit SEP = BISO SEP + 2 x sqrt(BISO SEP)
	VC-1/VC-2 BISO BBE = (Allocation x EEPO BBE x Test Period x 2000 x BISO Multiplier)/2 S1 Limit BBE = BISO BBE - 2 x sqrt(BISO BBE) S2 Limit BBE = BISO BBE + 2 x sqrt(BISO BBE)
	VC-3/VC-4/VC-4-XC BISO BBE = (Allocation x EEPO BBE x Test Period x 8000 x BISO Multiplier)/2 S1 Limit BBE = BISO BBE - 2 x sqrt(BISO BBE) S2 Limit BBE = BISO BBE + 2 x sqrt(BISO BBE)

Table TB-36 "BISO" formulae for the path section (B3, LPBIP 2/8) and regenerator section (B1)



Multiplex section (B2SUM)	
	$\text{BISO ES} = (\text{Allocation} \times \text{EEPO ES} \times \text{Test Period} \times \text{BISO Multiplier})/10$ $\text{S1 Limit ES} = \text{BISO ES} - 2 \times \text{sqrt}(\text{BISO ES})$ $\text{S2 Limit ES} = \text{BISO ES} + 2 \times \text{sqrt}(\text{BISO ES})$
	$\text{BISO SES} = (\text{Allocation} \times \text{EEPO SES} \times \text{Test Period} \times \text{BISO Multiplier})/2$ $\text{S1 Limit SES} = \text{BISO SES} - 2 \times \text{sqrt}(\text{BISO SES})$ $\text{S2 Limit SES} = \text{BISO SES} + 2 \times \text{sqrt}(\text{BISO SES})$
	$\text{BISO SEP} = (\text{Allocation} \times \text{EEPO SEP} \times \text{Test Period} \times \text{BISO Multiplier})/2$ $\text{S1 Limit SEP} = \text{BISO SEP} - 2 \times \text{sqrt}(\text{BISO SEP})$ $\text{S2 Limit SEP} = \text{BISO SEP} + 2 \times \text{sqrt}(\text{BISO SEP})$
	<p>STM-0</p> $\text{BISO BBE} = (\text{Allocation} \times \text{EEPO BBE} \times \text{Test Period} \times 64000 \times \text{BISO Multiplier})/10$ $\text{S1 Limit BBE} = \text{BISO BBE} - 2 \times \text{sqrt}(\text{BISO BBE})$ $\text{S2 Limit BBE} = \text{BISO BBE} + 2 \times \text{sqrt}(\text{BISO BBE})$
	<p>STM-1</p> $\text{BISO BBE} = (\text{Allocation} \times \text{EEPO BBE} \times \text{Test Period} \times 192000 \times \text{BISO Multiplier})/10$ $\text{S1 Limit BBE} = \text{BISO BBE} - 2 \times \text{sqrt}(\text{BISO BBE})$ $\text{S2 Limit BBE} = \text{BISO BBE} + 2 \times \text{sqrt}(\text{BISO BBE})$
	<p>STM-4</p> $\text{BISO BBE} = (\text{Allocation} \times \text{EEPO BBE} \times \text{Test Period} \times 768000 \times \text{BISO Multiplier})/10$ $\text{S1 Limit BBE} = \text{BISO BBE} - 2 \times \text{sqrt}(\text{BISO BBE})$ $\text{S2 Limit BBE} = \text{BISO BBE} + 2 \times \text{sqrt}(\text{BISO BBE})$
	<p>STM-16</p> $\text{BISO BBE} = (\text{Allocation} \times \text{EEPO BBE} \times \text{Test Period} \times 3072000 \times \text{BISO Multiplier})/10$ $\text{S1 Limit BBE} = \text{BISO BBE} - 2 \times \text{sqrt}(\text{BISO BBE})$ $\text{S2 Limit BBE} = \text{BISO BBE} + 2 \times \text{sqrt}(\text{BISO BBE})$
	<p>STM-64</p> $\text{BISO BBE} = (\text{Allocation} \times \text{EEPO BBE} \times \text{Test Period} \times 12288000 \times \text{BISO Multiplier})/10$ $\text{S1 Limit BBE} = \text{BISO BBE} - 2 \times \text{sqrt}(\text{BISO BBE})$ $\text{S2 Limit BBE} = \text{BISO BBE} + 2 \times \text{sqrt}(\text{BISO BBE})$

Table TB-37 "BISO" formulae for the multiplex section (B2SUM)



Measurements on patterns (TSE)	
	BISO ES = (Allocation x EEPO ES x Test Period x BISO Multiplier)/2 S1 Limit ES = BISO ES - 2 x sqrt(BISO ES) S2 Limit ES = BISO ES + 2 x sqrt(BISO ES)
	BISO SES = (Allocation x EEPO SES x Test Period x BISO Multiplier)/2 S1 Limit SES = BISO SES - 2 x sqrt(BISO SES) S2 Limit SES = BISO SES + 2 x sqrt(BISO SES)
	BISO BBE = (Allocation x EEPO BBE x Test Period x no. of blocks per sec. ¹ x BISO Multiplier)/2 S1 Limit BBE = BISO BBE - 2 x sqrt(BISO BBE) S2 Limit BBE = BISO BBE + 2 x sqrt(BISO BBE)
	BISO SEP = (Allocation x EEPO SEP x Test Period x BISO Multiplier)/2 S1 Limit SEP = BISO SEP - 2 x sqrt(BISO SEP) S2 Limit SEP = BISO SEP + 2 x sqrt(BISO SEP)
1	Number of blocks per second: see G.826/G.828/M.2101 block lengths

Table TB-38 "BISO" formulae for measurements on patterns (TSE)

The measurement results are compared with the threshold values S1 and S2 as follows when determining the section status (Verdict).

Measured value of ES [SES, BBE, SEP] > S2 or EFS = 0: Path status = rejected
 Measured value of ES [SES, BBE, SEP] between S1 and S2: Path status = uncertain
 Measured value of ES [SES, BBE, SEP] ≤ S1: Path status = accepted

Meas. value UAS may also be taken into account, cf. switch UAS-limit (see Tab. TB-30).



3.7.2.5 SES thresholds

The SES thresholds are defined in the following tables of the Recommendation M.2101 (06/2000):

- Table B.1/M.2101: LO Path Layer
- Table B.2/M.2101: HO Path Layer
- Table B.3/M.2101: Section Layer

A SES threshold of 30% of all evaluated blocks per second is used for all measurement points except B2SUM.

The recommendation does not define all the values for the Section Layer. These undefined values have been selected as follows:

Bit rate	Measurement point	Threshold value
STM-0 ¹	B2-SES MS-REI-SES	9 600 BIP-1 9 600 MS-REI
STM-1	B2-SES MS-REI-SES	28 800 BIP-1 28 800 MS-REI
STM-4	B2-SES MS-REI-SES	192 000 BIP-1 192 000 MS-REI
STM-16 ¹	B2-SES MS-REI-SES	921 600 BIP-1 921 600 MS-REI
STM-64 ¹	B2-SES MS-REI-SES	3 686 400 BIP-1 612 000 MS-REI
1 Values not defined for the Section Layer		

Table TB-39 SES thresholds

Maintenance



Contents

Maintenance

1	Cleaning the instrument	M-1
2	Tools	M-1
3	Exchanging Versacon inserts	M-2
4	Replacing the fuse	M-3
5	Replacing the air filter pad	M-4



Notes:



Maintenance

1 Cleaning the instrument

First disconnect the ANT-20SE from the AC line and all measurement circuits.

Simply turning the instrument off using the AC power switch is not sufficiently safe.

To clean the housing of the ANT-20SE, use warm water to which a little detergent has been added.

Never use cleaning fluids which contain solvents such as methylated spirits or petroleum. Such solvents may attack the lettering on the instrument. Cleansers for plastic or furniture should also be avoided as these often contain polishing agents which may damage the lettering or leave shiny patches on the instrument finish.

Simply dampen a cloth with the warm water and detergent solution and wipe the instrument clean. Make sure that drops of water do not enter the instrument. Wipe off excess moisture using a clean, dry cloth to ensure that no spots or drying marks are left on the housing.

Always use a damp cloth to clean the screen in order to prevent scratching and electrostatic charges.

2 Tools

The following tools are included with your instrument. These tools are required for maintenance operations, e.g. opening the instrument in order to replace the air filter.

- Hexagon key wrench (Allen key)
for the hex socket head screws holding the housing together.
- Fitting wrench
for the Versacon[®] 9 system connector inserts.



3 Exchanging Versacon inserts

Some of the inputs and outputs are equipped with Versacon[®] 9 system connectors. These inputs and outputs will be fitted with the inserts which you ordered (standard fitting is BNC inserts).

The inserts can be replaced at any time with other inserts from the Versacon[®] 9 system (see Fig. M-1). The fitting wrench is required for this job.

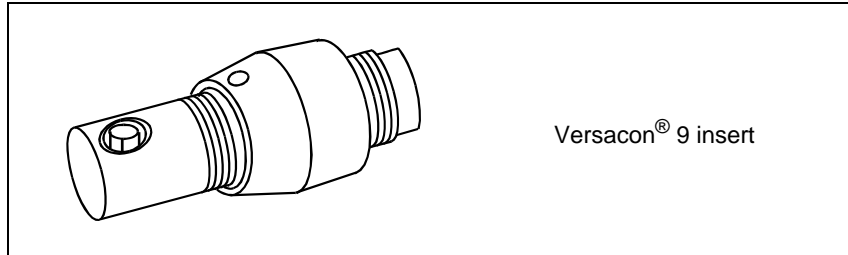

Fig. M-1 Versacon[®] 9 insert for BNC socket

Removing the socket

1. Loosen the lock nut by turning it anticlockwise with the fitting wrench.
2. Screw the lock nut forward by hand as far as it will go.
3. If the insert cannot now be removed by unscrewing it by hand, use the fitting wrench to loosen it.

Fitting the socket

1. Screw the lock nut onto the insert as far as it will go.
2. Screw the insert as far as it will go into the basic socket on the instrument.
3. Screw the lock nut down by hand (clockwise) and tighten it using the fitting wrench.



4 Replacing the fuse

If the instrument does not work when it is switched on and the AC line cord is OK, the fuse may have blown.

To replace the fuse, proceed as follows (see Fig. M-2):

1. **First disconnect the ANT-20SE from the AC line and all measurement circuits.**
2. Pull out the fuse holder using a small screwdriver.
3. Check the fuse for continuity.
4. If the fuse is faulty, replace it with a new one (two spare fuses are supplied with the instrument).
5. Put the fuse holder back into the instrument.
6. Connect the instrument to the AC line and switch on.

If the replacement fuse also blows, contact your nearest Wavetek Wandel Goltermann Service Center for advice.

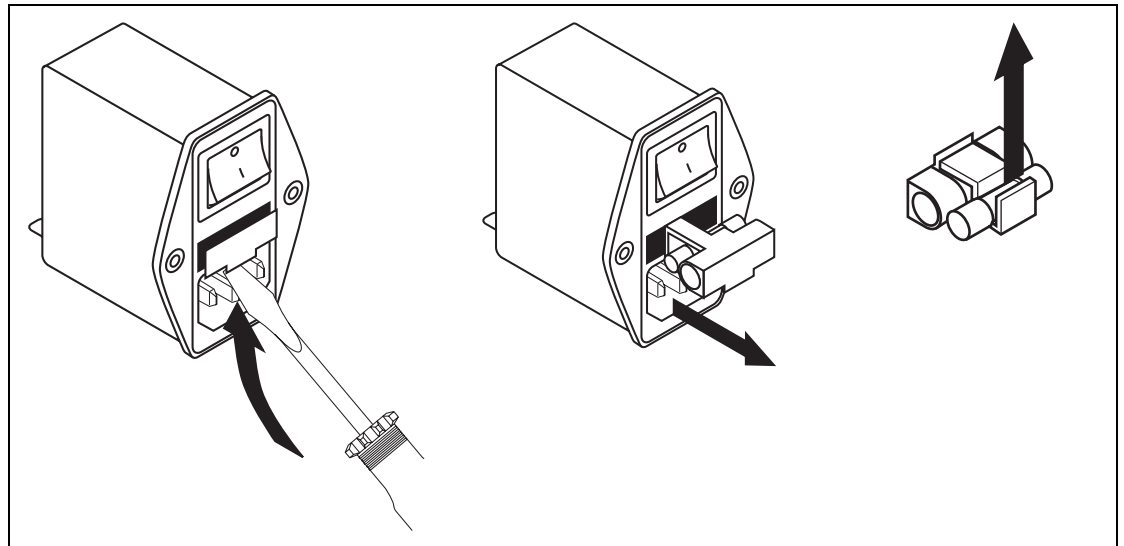

Fig. M-2 AC power connector with voltage selector and fuse



5 Replacing the air filter pad

Air for cooling the ANT-20SE is sucked in mainly through the left-hand half of the instrument housing. An air filter pad behind the left-hand side panel cleans this air flow.

The air filter should be cleaned at regular intervals. The frequency of cleaning will depend on the use and operating conditions of the instrument. If the filter is not cleaned or if the instrument is operated without the filter, the dust and dirt deposited may damage the instrument.

To replace the air filter, proceed as follows:

1. **First disconnect the ANT-20SE from the AC line and all measurement circuits.**
2. Remove the nine hex socket screws shown in the figure below.

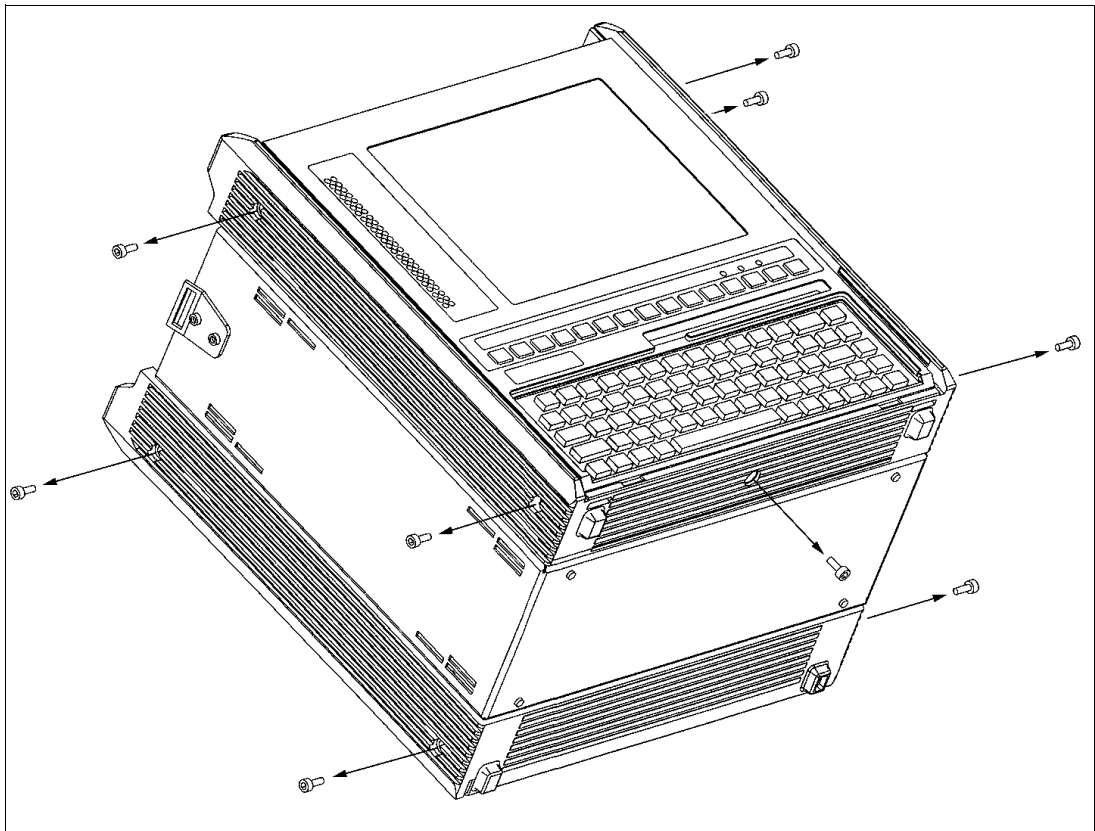

Fig. M-3 Removing the housing covers

3. Remove the housing covers of the ANT-20SE (see Fig. M-4).
4. Replace the filter pad.
5. Replace the housing covers.
6. Replace and tighten the nine hex socket screws.

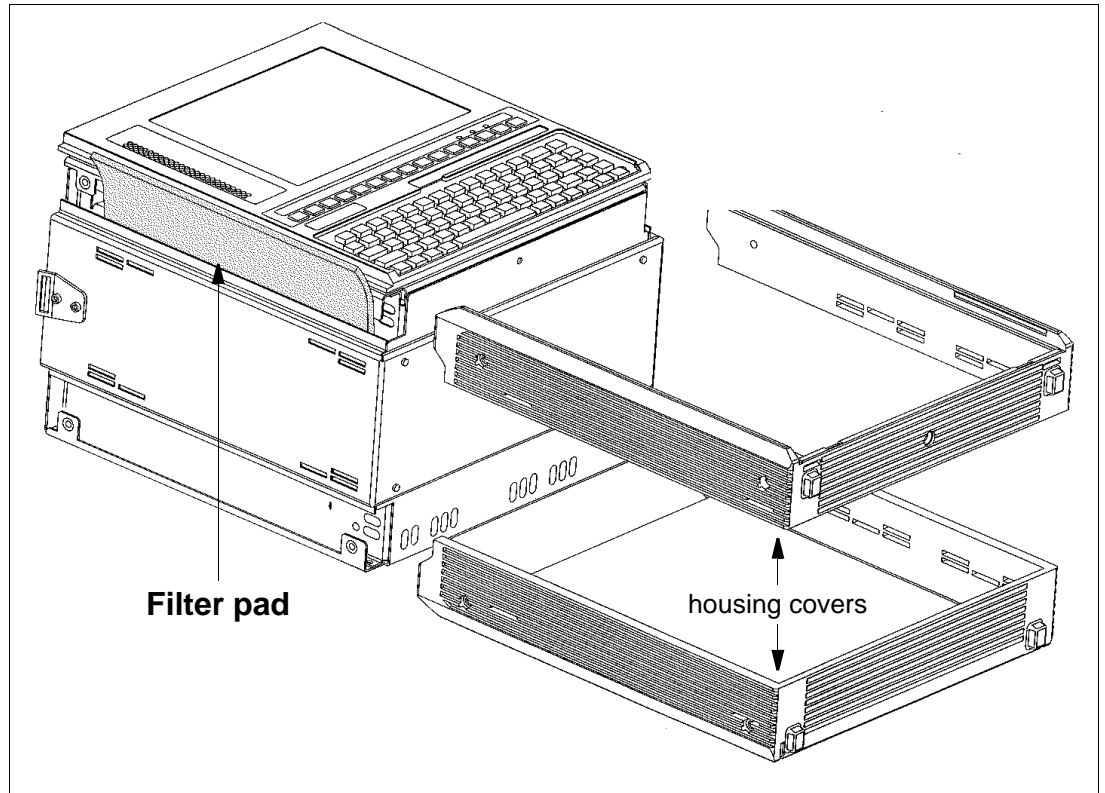

Fig. M-4 Replacing the ANT-20SE filter pad



Notes:

Remote Operation



Contents

Remote operation

1	Introduction	RO-1
2	Remote Operation via Modems	RO-2
2.1	Overview	RO-2
2.2	Items included in delivery	RO-2
2.3	Installation	RO-2
2.3.1	Hardware installation	RO-2
2.3.2	Software installation	RO-3
3	Remote Operation via Ethernet (IEEE 802.3)	RO-4
3.1	Overview	RO-4
3.2	Items included in delivery	RO-4
3.3	Installation	RO-4
3.3.1	Hardware installation	RO-4
3.3.2	Software installation	RO-4



Notes:



Remote operation

With options BN 3035/95.30 and BN 3035/95.31 only.

1 Introduction

The remote operation options allow you to access a distant ANT-20SE from any Windows PC over a dial-up link via modems or over an Ethernet LAN.

Here are just some of the things you can do:

Remote control

Once connected to the distant ANT-20SE, you can use your mouse and keyboard to operate the ANT-20SE just as if you were sitting in front of it.

File transfer

Move or copy files quickly and reliably between ANT-20SE and PC.

Chat between ANT-20SE and PC

Type messages that appear instantaneously at the other side.

Remote printing

Redirect print jobs, e.g. from the distant ANT-20SE to your local printer.

All this is accomplished with the remote access software called ReachOut from Stac Electronics Inc.

In terms of ReachOut, the controlling PC is the Viewer and the distant ANT-20SE is the Host.

For detailed information refer to the ReachOut user's guide.



2 Remote Operation via Modems

2.1 Overview

The Remote Operation Option 3035/95.30 includes the software required to operate a distant ANT-20SE from a Windows PC over a dial-up link via modems or over a direct connection via a null modem cable. The direct connection may be used for testing purposes over short distances.

A null modem cable (3 meters long) with both 9-way and 25-way SUB-D female connectors on each end is included.

The remote access software used, ReachOut (from Stac Electronics Inc.), handles hundreds of different modem types, including ISDN modems and cellular modems. You can even define a new modem if yours isn't listed. For detailed information refer to the ReachOut user's guide.

The modems should be purchased in the country where they are to be operated, to conform to national regulations.

2.2 Items included in delivery

The Remote Operation Option 3035/95.30 comprises:

- ReachOut User's Guide
- ReachOut installation disks (Host & Viewer, Modem & Network, 1 Node)
- Null modem cable, 3 meters long (part number K 764)

2.3 Installation

2.3.1 Hardware installation

PCMCIA card modem

Insert the PCMCIA card modem into a free PCMCIA socket just like you insert a disk into a floppy drive.

You do not need to power down the ANT-20SE when you insert or remove the card.

External modem or null modem cable

Connect the modem (or null modem cable) to the V.24 interface connector of the ANT-20SE (serial port COM1 of the built in PC-AT).



2.3.2 Software installation

If you ordered the Remote Operation Option BN 3035/95.30 together with your ANT-20SE, the ReachOut software is already installed on the ANT-20SE (in the directory C:\REACHOUT) and the ReachOut program icon is shown in the Windows95 file folder "Programs".

The ReachOut security options are pre-configured as follows:

The ReachOut "Password List" contains an entry with the "User Name" ANT-20SE and the accompanying password ANT-20SE. The option "Passwords Required" is set to "No". For detailed information about configuration options refer to the ReachOut user's guide.

If you ordered the Remote Operation Option 3035/95.30 separately, install the ReachOut software as follows:

Querying the assigned COM port of the PCMCIA card modem

(only if you use a PCMCIA card modem)

1. Start or return to Windows95.
2. Click the Windows95 "Start" button, choose "Settings" and then choose "Control Panel".
3. Double-click "Modems", select your PCMCIA modem type on the "General" tab, and then click "Properties". You need the assigned COM port (usually COM3) for configuring ReachOut.

Installing the ReachOut software

1. Start or return to Windows95.
2. Insert the ReachOut for Windows & DOS installation disk 1 into drive A:.
3. Click the Windows95 "Start" button, choose "Run ..." and type the following command into the dialog box:
A:\install
4. Follow the on-screen instructions to complete the installation. For detailed information refer to the ReachOut user's guide.
If you are installing ReachOut on a DominoCOM ANT-20SE, answer the on-screen question "Would you like ReachOut Host to be started automatically when you start Windows?" with "Yes".
All configuration parameters can be changed after installation by configuring ReachOut.
5. After complete installation exit Windows95, remove the installation disk from drive A:, and reboot the ANT-20SE.

After this installation procedure on the ANT-20SE (the "Host" in terms of ReachOut) you can start the ReachOut Host and configure it as required.

To prevent a Viewer from accidentally tying up the Host, it is recommended setting the Host configuration parameter "Inactivity Timeout" to a non zero value (in "Preferences .../Host Options" menu).

After installing ReachOut on the controlling PC (the "Viewer" in terms of ReachOut) and configuring the ReachOut Viewer as required, you can start remote access to the ANT-20SE.

For detailed information refer to the ReachOut user's guide.



3 Remote Operation via Ethernet (IEEE 802.3)

3.1 Overview

The Remote Operation Option 3035/95.31 includes the software required to operate a distant ANT-20SE from a Windows PC over an Ethernet LAN using the Internet protocol TCP/IP.

The PCMCIA Ethernet card required (with 10Base2 and 10BaseT connectors) for the ANT-20SE is also included.

The remote access software used is ReachOut (from Stac Electronics Inc.). For detailed information refer to the ReachOut user's guide.

3.2 Items included in delivery

The Remote Operation Option BN 3035/95.31 comprises:

- ReachOut User's Guide
- ReachOut installation disks (Host & Viewer, Modem & Network, 1 Node)
- SCM Ethernet LAN card (SCM Microsystem GmbH) including:
 - Media Coupler for 10Base2 and 10BaseT
 - Distribution disk
 - Installation Guide

3.3 Installation

3.3.1 Hardware installation

Insert the SCM Ethernet LAN card into a free PCMCIA socket just like you insert a disk into a floppy drive.

You do not need to power down the ANT-20SE when you insert or remove the card.

Connect the SCM Ethernet LAN card to your LAN using the Media Coupler cable included.

3.3.2 Software installation

If you ordered the Remote Operation Option BN 3035/95.31 together with your ANT-20SE, the required software packages are already installed on the ANT-20SE (ReachOut in the directory C:\REACHOUT) and the ReachOut icon is shown in the Windows95 file folder "Programs".

The ReachOut security options are pre-configured as follows:

The ReachOut "Password List" contains an entry with the "User Name" and the accompanying password "ANT-20". The option "Passwords Required" is set to "No".

For detailed information about configuration options refer to the ReachOut user's guide.



You now have to modify the pre-configured network setup to meet the specific requirements of your network:

Modify the C:\WINDOWS\hosts file

The C:\WINDOWS\hosts file is merely an example. It must be modified to adapt to your network:

The hosts file must contain the IP addresses of all network nodes with which you want to communicate, including the IP address of the ANT-20SE itself and the IP address of the gateway (if any) between the ANT-20SE and the controlling PC. The first entry in the file is the mapping for "localhost" and must be left unchanged (see sample hosts file C:\WINDOWS\hosts.sam).

Ask your network administrator for the required entries for the hosts file to adapt to your network.

Modify the network configuration

1. Start or return to Windows95.
2. Click the Windows95 "Start" button, choose "Settings" and then choose "Control Panel". In the "Control Panel" window, double-click the "Network" icon.
3. In the "Configuration" tab of the "Network" window, double-click "TCP/IP":
In the "IP Address" tab of the "TCP/IP Properties" window set the "IP Address" of the ANT-20SE and the "Subnet Mask".
In the "Gateway" tab of the "TCP/IP Properties" window set the address of the default gateway.
Ask your network administrator for the required entries to adapt to your network.
Confirm with OK.
4. Back in the "Network" window, choose "Identification" tab, and then set "Computer Name" (must be unique in the network), "Workgroup" etc. to suit your requirements.
Confirm with "OK".
5. Reboot the ANT-20SE.

If you ordered the Remote Operation Option 3035/95.31 separately, install the software packages as follows:

Installing the driver software for the SCM Ethernet LAN card

1. Start or return to Windows95.
2. Insert the SCM Ethernet LAN card into a free PCMCIA socket.
3. Follow the on-screen instructions of the "Update Device Driver Wizard" to install the driver software:
 - Insert the SCM distribution disk into drive A:
 - Click "Other Locations ...", and then type the following folder name into the dialog box:
A:\WIN95
 - Confirm with "OK".
 - Back in the Update Device Driver Wizard" window, click "Finish".
4. After complete installation, remove the SCM distribution disk from drive A:, and answer the question "Do you want to restart your computer now?" with "Yes".



Verify the driver installation

To show the “SCM Ethernet Combo card Properties” window

1. Start or return to Windows95.
2. Click the Windows95 “Start” button, choose “Settings” and then choose “Control Panel”. In the “Control Panel” window, double-click the “System” icon.
3. In the “Device Manager” tab of the “System Properties” window, choose “View devices by type”, double-click “Network adapters” in the list, and then double-click “SCM Ethernet Combo card”.

Modify the C:\WINDOWS\hosts file

The C:\WINDOWS\hosts file is merely an example. It must be modified to adapt to your network:

The hosts file must contain the IP addresses of all network nodes with which you want to communicate, including the IP address of the ANT-20SE itself and the IP address of the gateway (if any) between the ANT-20SE and the controlling PC. The first entry in the file is the mapping for “localhost” and must be left unchanged (see sample hosts file C:\WINDOWS\hosts.sam).

Ask your network administrator for the required entries for the hosts file to adapt to your network.

Configure the network setup

1. Start or return to Windows95.
2. Click the Windows95 “Start” button, choose “Settings” and then choose “Control Panel”. In the “Control Panel” window, double-click the “Network” icon.
3. In the “Configuration” tab of the “Network” window, click “Add ...”.
4. In the “Select Network Component Type” window, double-click “Protocol”.
5. In the “Manufacturers” list of the “Select Network Protocol” window click on “Microsoft”, and in the “Network Protocols” list click on “TCP/IP”. Confirm with “OK”.
6. Back in the “Configuration” tab of the “Network” window, remove all other protocol entries (except TCP/IP) from the list, and then double-click on “TCP/IP”.
7. In the “IP Address” tab of the “TCP/IP Properties” window choose “Specify an IP address” and set the “IP Address” of the ANT-20SE and the “Subnet Mask”.
In the “Gateway” tab of the “TCP/IP Properties” window type the address of the default gateway into the dialog box “New gateway”, then click “Add ...”.
Ask your network administrator for the required entries to adapt to your network.
Confirm with “OK”.
8. Back in the “Network” window, choose “Identification” tab, and then set “Computer Name” (must be unique in the network), “Workgroup” etc. to suit your requirements.
Confirm with “OK”.
9. Reboot the ANT-20SE now.



Select the startup mode

When using the ANT-20SE in remote operating mode, it is not normally desirable to receive a log-on request during startup.

To disable the log-on request:

1. Start or return to Windows95.
2. Click the Windows95 "Start" button, choose "Settings" and then choose "Control Panel". In the "Control Panel" window, double-click the "Network" icon.
3. In the "Configuration" tab of the "Network" window, select "Windows Logon" in the "Primary Network Logon" list and confirm with "OK".
4. Reboot the ANT-20SE now.

Verify the network installation

Test the connection to the controlling PC:

1. Start or return to Windows95.
2. Click the Windows95 "Start" button, choose "Programs" and then choose "MS-DOS Prompt".
3. Execute `C:\ping <ip_address>`, where `<ip_address>` is the IP address of the controlling PC.

If no connection can be established,

- the `C:\WINDOWS\hosts` file may have incorrect or missing entries or
- the "Gateway" tab in the "TCP/IP Properties" window of the "Network" setup may have incorrect or missing entries.

Installing the ReachOut software

1. Start or return to Windows95.
2. Insert the ReachOut for Windows & DOS installation disk 1 into drive A:.
3. Click the Windows95 "Start" button, choose "Run ..." and type the following command into the dialog box:
`A:\install`
4. Follow the on-screen instructions to complete the installation. Select connection type Internet (using Windows Sockets). For detailed information refer to the ReachOut user's guide.
If you are installing ReachOut on a DominoCOM ANT-20SE, answer the on-screen question "Would you like ReachOut Host to be started automatically when you start Windows?" with "Yes".
All configuration parameters can be changed after installation by configuring ReachOut.
5. After complete installation exit Windows95, remove the installation disk from drive A:, and reboot the ANT-20SE.

After this installation procedure on the ANT-20SE (the "Host" in terms of ReachOut) you can start the ReachOut Host and configure it as required.

To prevent a Viewer from accidentally tying up the Host, it is recommended setting the Host configuration parameter "Inactivity Timeout" to a non zero value (in "Preferences .../Host Options" menu).

After installing ReachOut on the controlling PC (the "Viewer" in terms of ReachOut) and configuring the ReachOut Viewer as required, you can start remote access to the ANT-20SE.

For detailed information refer to the ReachOut user's guide.



Notes:

Specifications



Contents

Specifications

1	Generator section	S-2
1.1	Digital signal outputs	S-2
1.1.1	LINE signal output [15], electrical	S-2
1.1.2	LINE/AUXILIARY signal output [13], electrical	S-3
1.2	Clock generation and bit rates	S-3
1.2.1	Internal clock generation	S-3
1.2.2	Synchronization to external signals	S-4
2	Receiver section	S-5
2.1	Digital signal inputs	S-5
2.1.1	LINE signal input [14], electrical	S-5
2.2	LINE/AUXILIARY signal input [12], electrical	S-7
2.2.1	Clock recovery	S-8
3	DS1 and DS3 signals	S-9
3.1	Error insertion and alarm generation (TX)	S-10
3.1.1	Error insertion (anomalies)	S-10
3.1.2	Alarm generation (defects)	S-11
3.2	Error measurement and alarm detection (RX)	S-12
3.2.1	Error measurement (anomalies)	S-12
3.2.2	Alarm detection (defects)	S-13
3.3	Drop&Insert / Through Mode	S-14
3.3.1	Functions	S-14
3.3.2	Clock generator	S-15
3.3.3	Anomaly insertion	S-15
3.3.4	Defect generation	S-15
3.3.5	Measurements	S-15
4	E1 to E4 signals	S-16
4.1	Error insertion and alarm generation (TX)	S-17
4.1.1	Error insertion (anomalies)	S-17
4.1.2	Alarm generation (defects)	S-17



- 4.2 Error measurement and alarm detection (RX) S-18
 - 4.2.1 Error measurement (anomalies) S-18
 - 4.2.2 Alarm detection (defects) S-19
- 4.3 Drop&Insert / Through Mode S-20
 - 4.3.1 Functions S-20
 - 4.3.2 Clock generator. S-21
 - 4.3.3 Anomaly insertion S-21
 - 4.3.4 Defect generation S-21
 - 4.3.5 Measurements S-21
- 5 Measurement modes S-22**
 - 5.1 Evaluation to ANSI/BELL S-22
 - 5.2 Evaluation to ITU-T G.821 S-22
 - 5.3 Evaluation to ITU-T G.826 S-23
 - 5.4 Evaluation to ITU-T G.828 S-23
 - 5.5 Evaluation to ITU-T G.829 S-24
 - 5.6 Evaluation to ITU-T M.2100 S-25
 - 5.7 Evaluation to ITU-T M.2101 S-26
- 6 Automatic measurements S-27**
 - 6.1 Auto configuration S-27
 - 6.1.1 Check Interface S-27
 - 6.1.2 Check Mapping S-27
 - 6.1.3 Check Payload S-28
 - 6.1.3.1 PDH signals S-28
 - 6.1.3.2 ATM signals S-28
 - 6.1.4 Structure and results. S-29
 - 6.2 Automatic “Scan” function. S-30
 - 6.3 Automatic “Search” function S-31
 - 6.4 Automatic “Trouble Scan” function S-32
 - 6.5 Automatic “Signal Delay” measurement S-34
- 7 Other inputs and outputs S-36**
 - 7.1 DCC/ECC [21]. S-36
 - 7.2 TRIGGER [26]. S-37
 - 7.3 REF CLOCK IN [25] S-37
 - 7.4 CLOCK [22]. S-38



8	Built-in operation and control computer (PC)	S-39
9	General specifications	S-41
9.1	Power supply	S-41
9.2	Climatic and mechanical ambient conditions	S-41
9.2.1	Climatic and mechanical data	S-42
9.3	EC conformance declaration/CE mark	S-42
9.3.1	EMC interference suppression	S-42
9.3.2	EMC interference immunity	S-43
9.4	Noise emission	S-44
9.5	Calibration/Maintenance	S-44
9.6	Dimensions/Weight	S-44
9.7	Ordering information	S-45
9.7.1	Mainframe ANT-20SE	S-45
9.7.2	Options	S-46
9.7.3	Remote control	S-48
9.7.4	Remote operation	S-49
9.7.5	Test automation	S-49
9.7.6	Calibration	S-49
9.7.7	Accessories	S-49
9.7.8	Retrofitting of options	S-49
9.7.9	Note for ANT-20SE users	S-50



Notes:



Specifications

The numbers in square brackets [...] correspond to the numbers printed on the instrument.

Calibrated specifications for the SDH Version ANT-20SE 3060/01 are marked ***.

Calibrated specifications for the SONET Version ANT-20SE 3060/02 are marked **.



1 Generator section

1.1 Digital signal outputs

1.1.1 LINE signal output [15], electrical

Connector unbalanced (coaxial)
 Socket UNI 9 (Versacon®)
 Output impedance 75 Ω
 Max. applied peak voltage ± 5 V

Interface ³	Bit rate (Mbit/s)	Line code	Output voltage	Output voltage tolerance	Reflexion coefficient
STS-3 STM-1	155.520 *** **	CMI	± 0.5 V	± 0.05 V	≥ 15 dB 100 kHz to 240 MHz
STM-0	51.840 **	HDB3	± 1.0 V	± 0.1 V	≥ 18 dB 50 kHz to 52 MHz
STS-1		B3ZS	DS High: ± 0.909 V		
DS3	44.736 ²	B3ZS	DSX3: High + Sim 450 feet 728A cable ⁴ DS Low: High -13.8 dB ⁴		
DS2	6.312 ²	B8ZS	± 2 V ⁴	± 0.2 V	
DS1	1.544 ²	B8ZS, AMI	± 2.37 V	± 0.237 V	
E4	139.264 ¹	CMI	± 0.5 V	± 0.05 V	≥ 15 dB 100 kHz to 240 MHz
E3	34.368 ¹ ***	HDB3	± 1.0 V	± 0.1 V	≥ 18 dB 50 kHz to 52 MHz
E2	8.448 ¹	HDB3	± 2.37 V	± 0.2 V	
E1	2.048 ¹	HDB3			

1 3035/02 requires option 3035/90.33
 2 3035/01 requires option 3035/90.34
 3 depends on ANT-20SE versions and options
 4 from H series onwards

Table S-1 LINE output [15] signal specifications, electrical



1.1.2 LINE/AUXILIARY signal output [13], electrical

Connector	balanced
Socket: 3035/01	Lemo SA
Socket: 3035/02	Bantam
Output impedance	
2.048 Mbit/s	120 Ω
1.544 Mbit/s	100 Ω
Max. applied peak voltage	± 5 V

Bit rate (Mbit/s)	Line code	Output voltage	Output voltage tolerance	Reflexion coefficient
2.048 ¹ ***	HDB3	± 3.0 V	± 0.3 V	≥ 18 dB 50 kHz to 3 MHz
1.544 ² **	B8ZS, AMI	DSX-1 compatible		
1 3035/02 requires option 3035/90.33				
2 3035/01 requires option 3035/90.34				

Table S-2 LINE/AUXILIARY output [13] signal specifications, electrical

1.2 Clock generation and bit rates

1.2.1 Internal clock generation

Bit rate range	1.544 Mbit/s to 155.52 Mbit/s
Frequency deviation ***, **	± 2 ppm ± 1 ppm/year
Settable offset	± 500 ppm
Minimum setting step width	0.001 ppm (1 ppb)
Intrinsic jitter (clock)	0.010 UI



1.2.2 Synchronization to external signals

Derived from RX clock

The TX bit rate is derived from the RX clock. The jitter of the incoming signal is suppressed.

TX side offset setting ± 500 ppm

Minimum setting step width 0.001 ppm (1 ppb)

Limit frequency above which jitter is suppressed approx. 100 Hz

Max. permissible receive clock (receive signal) offset:

TX bit rate ≥ 51.84 Mbit/s ± 10 ppm

TX bit rate < 51.84 Mbit/s 50 ppm

No TX offset is possible for DROP&INSERT operation (Option 3035/90.20).

Derived from reference clock

The TX bit rate is derived from:

- reference clock T3 (2.048 MHz)
- data signal 2.048 Mbit/s
- reference clock DS1 (1.544 MHz)
- data signal 1.544 Mbit/s

The jitter in the incoming signal is suppressed (see Sec. 7.3, Page S-37).

Settable offset, referred to 1.544 MHz or 2.048 MHz ± 500 ppm

Minimum setting step width 0.001 ppm (1 ppb)

Limit frequency above which jitter is suppressed approx. 1 Hz

Max. permissible reference signal offset ≤ 10 ppm



2 Receiver section

2.1 Digital signal inputs

2.1.1 LINE signal input [14], electrical

Connector	unbalanced (coaxial)
Socket	UNI 9 (Versacon [®])
Input impedance	75 Ω
Max. permissible frequency offset	± 500 ppm
Max. number of consecutive zeros for code = AMI	15
Switchable input voltage ranges ^{***} , ^{**}	
“ITU-T” (“High”)	0 dB attenuation referred to nominal level
“PMP” (“Low”) CMI	15 to 23 dB attenuation referred to nominal level
“PMP” (“Low”) B3ZS, B8ZS, HDB3, AMI	15 to 26 dB attenuation referred to nominal level
Max. peak input voltage	± 5 V



Interface ³	Bit rate (Mbit/s)	Line code	Signal equalization (adaptive)	Reflexion coefficient
STS-3 STM-1	155.520	CMI	max. 12.7 dB/78 MHz	≥ 15 dB 100 kHz to 240 MHz
STM-0	51.840	HDB3	max. 12 dB/17 MHz ⁴	≥ 18 dB 50 kHz to 52 MHz
STS-1		B3ZS		
DS3		B3ZS		
DS1	1.544 ²	B8ZS, AMI	max. 6 dB/0.772 MHz ⁵	
DS2	6.312 ²	B8ZS	max. 6 dB/3 MHz	≥ 18 dB 100 kHz to 52 MHz
E4	139.264 ¹	CMI	max. 12 dB/70 MHz	≥ 15 dB 100 kHz to 240 MHz
E3	34.368 ¹	HDB3	max. 12 dB/17 MHz	≥ 18 dB 50 kHz to 52 MHz
E2	8.448 ¹	HDB3	max. 6 dB/4 MHz	
E1	2.048 ¹	HDB3	max. 6 dB/1 MHz	

1 3035/02 requires option 3035/90.33
2 3035/01 requires option 3035/90.34
3 depends on ANT-20SE versions and options
4 Adaptive equalizer allows ≥ 450 ft 728A cable (DSX3 level)
5 Adaptive equalizer allows ≥ 655 ft 22AWG cable

Table S-3 LINE input [14] signal specifications, electrical

Tolerance to jitter

Measured using PRBS 15 (≥ 8 Mbit/s) and PRBS 23 (> 8 Mbit/s) with "ITU-T" and "PMP" receive levels attenuated by 20 dB referred to the nominal level.

Jitter amplitude

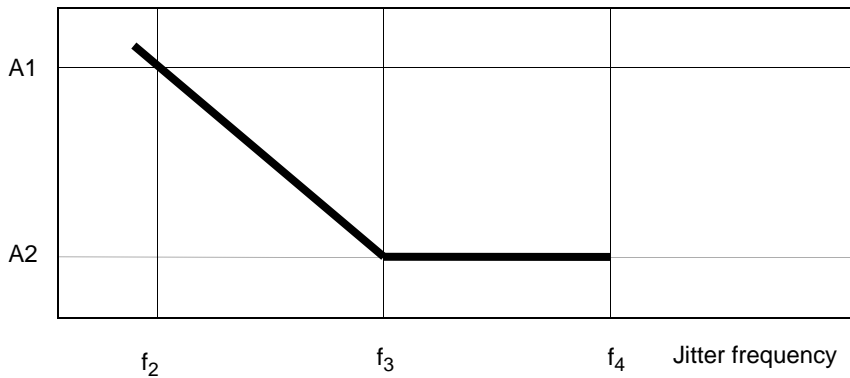

Fig. S-1 Relationship between jitter amplitude and jitter frequency



Bit rate Mbit/s	Line code	A1 UIpp	f ₂ kHz	A2 UIpp	f ₃ kHz	f ₄ kHz
1.544 ²	B8ZS	5	0.5	0.25	20	200
2.048 ¹	HDB3	10	0.5	0.25	20	200
6.312	B8ZS	10	1.5	0.25	60	600
8.448 ¹	HDB3	10	2	0.25	80	800
34.368 ¹	HDB3	10	6	0.25	240	2000
44.736 ²	B3ZS	10	6	0.25	240	2000
51.840	B3ZS	10	6	0.25	240	2000
139.264 ¹	CMI	10	20	0.25	800	3500
155.520	CMI	10	22	0.25	880	3500

1 3035/02 requires option 3035/90.33
 2 3035/01 requires option 3035/90.34

Table S-4 ANT-20SE tolerance to jitter at system bit rates

LOS (Loss of Signal) status display

LED is on if the signal input is active but no signal is present.

2.2 LINE/AUXILIARY signal input [12], electrical

- Connector balanced
- Socket: 3035/01 Lemo SA
- Socket: 3035/02 Bantam
- Input impedance
- 2.048 Mbit/s 120 Ω
- 1.544 Mbit/s 100 Ω
- Max. permissible frequency offset ± 500 ppm
- Max. number of consecutive zeros for code = AMI 15
- Switchable input voltage ranges
- “ITU-T” (“High”) 0 dB attenuation referred to nominal level
- “PMP” (“Low”) 15 to 26 dB attenuation referred to nominal level
- Max. peak input voltage ± 5 V



Bit rate (Mbit/s)	Line code	Reflection coefficient
2.048 ¹	HDB3	≥ 18 dB 50 kHz to 3 MHz
1.544 ²	B8ZS, AMI	
1 3035/02 requires option 3035/90.33 2 3035/01 requires option 3035/90.34		

Table S-5 Input signal specifications "LINE/AUXILIARY" [12], electrical

Tolerance to jitter

As per Tab. S-4, Page S-7

LOS (Loss of Signal) status display

LED is on if the signal input is active but no signal is present.

2.2.1 Clock recovery

The appropriate bit clock is derived from the input signal and the offset from the nominal clock rate is measured.

Offset display, in ppm 3-digit

Display resolution 1 ppm

No offset measurement is possible for "Through Mode" and "TX clock from RX".

The recovered clock can be used for synchronizing the TX bit rate (see Sec. 1.2.2, Page S-4).



3 DS1 and DS3 signals

Available with ANT-20SE version 3060/02 or
with ANT-20SE version 3060/01 and option 3035/90.34.

Test signals for bit error measurements.

Signal structure for all bit rates

- unframed test pattern
- framed test pattern (except DS2)

Test pattern

Digital word. length 16 bits

Pseudo-random bit sequences. PRBS 11, PRBS 11 invers, PRBS 15, PRBS 15 invers,
PRBS 20, PRBS 23, PRBS 23 invers,
QRSS 20 (QRSS 20 with max. 14 zeros)

Frames

DS3 M13 frame, C-Parity

DS2 unframed only

DS1 D4 (SF), ESF (ANSI T1.107)



3.1 Error insertion and alarm generation (TX)

3.1.1 Error insertion (anomalies)

Error insertion (anomalies) bit errors in test pattern (TSE),
code errors (single errors only)

Trigger types Single
or Rate

Tip: When Rate triggering is selected a bit error rate is inserted.

Anomaly	Single	Rate ¹
FE-DS1	yes	2E-3 to 1E-8
CRC6	yes	2E-3 to 1E-8
FE-DS3	yes	2E-3 to 1E-8
P-Parity-DS3	yes	2E-3 to 1E-8
CP-Parity-DS3	yes	2E-3 to 1E-8
FEBE-DS3 (REI 45)	yes	2E-3 to 1E-8
TSE	yes	1E-2 to 1E-8
BPV	yes	-

¹ Mantissa: 1 to 9 (only 1 for TSE), exponent: -1 to -8 (whole numbers)

Table S-6 Available anomalies and trigger modes

The insertion of **errors** (anomalies) **and alarms** (defects) is mutually exclusive. The first action selected is active. The second action is rejected.



3.1.2 Alarm generation (defects)

Defect	Test sensor function	Test sensor threshold
AIS-DS1, AIS-DS3, IDLE-DS3, FEAC-DS3	On/Off	-
LOF-DS1	On/Off	2/4, 2/5, 2/6 ¹
LOF-DS3	On/Off	2/2, 2/3, 3/3, 3/15, 3/16, 3/17 ¹
YELLOW-DS1, YELLOW-DS3 (RDI)	On/Off	-
1 (see Tab. S-8)		

Table S-7 Available defects

The insertion of **errors** (anomalies) **and alarms** (defects) is mutually exclusive. The first action selected is active. The second action is rejected.

DS1	DS3	Insertion
2 in 4	-	1st and 4th Ft bit in every second (E)SF inverted
2 in 5	-	1st and 5th Ft bit in every second (E)SF inverted
2 in 6	-	1st and 6th Ft bit in every second (E)SF inverted
-	2 in 2	1st and 2nd F bit in every multiframe inverted
-	2 in 3	1st and 3rd F bit in every multiframe inverted
-	3 in 3	1st, 2nd and 3rd F bit in every multiframe inverted
-	3 in 15	1st, 8th and 15th F bit in every multiframe inverted
-	3 in 16	1st, 9th and 16th F bit in every multiframe inverted
-	3 in 17	1st, 9th and 17th F bit in every multiframe inverted

Table S-8 DS1/DS3 alarm generation



3.2 Error measurement and alarm detection (RX)

3.2.1 Error measurement (anomalies)

Evaluation

All errors (anomalies) are counted simultaneously and stored.

Gate times 1 to 99 seconds
or 1 to 99 minutes
or 1 to 99 hours
or 1 to 99 days

Intermediate results 1 to 99 seconds
or 1 to 99 minutes

Display

of anomalies via LEDs:

CURRENT LED (red) is on when the anomaly is present

HISTORY LED (yellow) is on if the anomaly occurred at least once or is active within the started measurement interval.

Anomaly	LED
FE-DS1, FE-DS3, MFE-DS3	FAS/CRC
CRC6	FAS/CRC
P-DS3, CP-DS3	-
TSE	TSE
BPV	-
DS3-REI	-

Table S-9 LED display of available anomalies



3.2.2 Alarm detection (defects)

Evaluation

All alarms (defects) which occur are evaluated simultaneously where possible and stored. Storage takes place only within a started measurement interval

Time resolution of defects100 ms

Display

of defects via LEDs:

CURRENT LED (red) is on when the defect is present.

HISTORY LED (yellow) is on if the defect occurred at least once or is active within the started measurement interval.

Defect	LED
AIS-DS1, AIS-DS3	AIS
LOF-DS3, OOF-DS3 LOF-DS1, OOF-DS1	LOF/LCD
DS1-YELLOW, DS3-YELLOW	RDI(AIS-)/YELLOW
IDLE-DS3, FEAC-DS3	-

Table S-10 LED display of available defects

Tip: DS3-AIC is used for autoconfiguring the instrument and can only be read out via remote control.



3.3 Drop&Insert / Through Mode

Option: BN 3035/90.20

3.3.1 Functions

This Option provides the following functions for all PDH multiplex options fitted to the ANT-20SE.

Drop&Insert

This function is only available in conjunction with the following options:

- PDH MUX/DEMUX chain: BN 3035/90.30 to BN 3035/90.31
 M13 MUX/DEMUX chain: BN 3035/90.32

– or –

- STM-1 mappings: BN 3035/90.01 to BN 3035/90.05
 STS-1 mappings: BN 3035/90.10 to BN 3035/90.13

– or –

- Optical interfaces: BN 3035/90.40 to BN 3035/90.48
 BN 3035/90.50 and BN 3035/90.51

The characteristics and specifications for the Drop&Insert function are given in the descriptions for the various options.

Through Mode

The received signal is looped through the ANT-20SE and re-transmitted by the generator. The ANT-20SE operates in Through Mode as a signal monitor without affecting the signal.

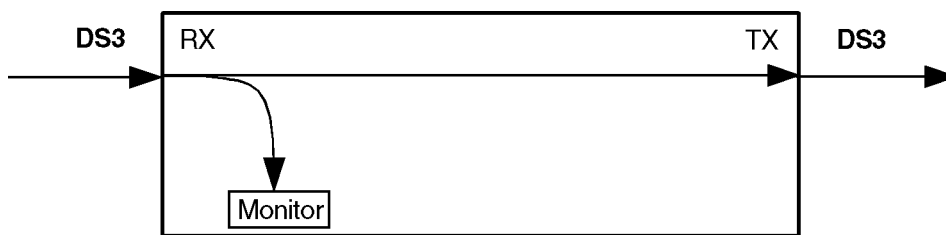

Fig. S-2 Through Mode: Generator and receiver coupled

The ANT-20SE provides access to the tributary channels within the “MUX/DEMUX” chain when used in conjunction with the “PDH MUX/DEMUX” and “M13 MUX/DEMUX” options, BN 3035/90.30 to BN 3035/90.32. This also applies if the PDH signal is transmitted in a container.

The looped-through signal can also be jittered using the Jitter Generator options (Jitter Generator up to 155 or 622 Mbit/s, BN 3035/90.60 to 61). This function is available for all bit rates fitted to the instrument.

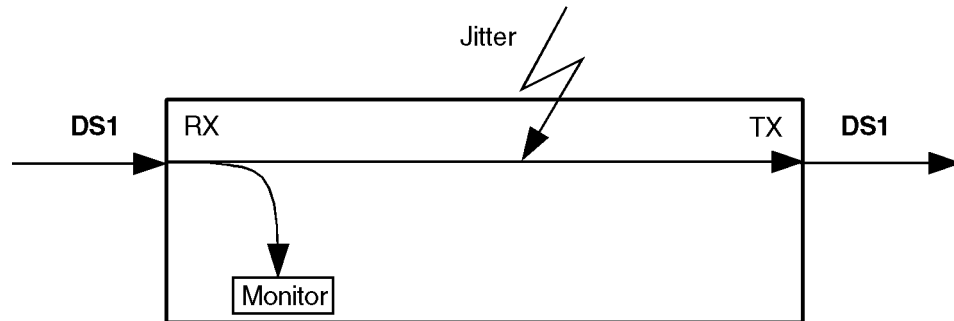

Fig. S-3 Through Mode: Adding jitter to the looped-through signal

3.3.2 Clock generator

Through Mode

In Through Mode, clock generation is always derived from the receive signal clock. No offset is possible in this operating mode (see Sec. 1.2.2, Page S-4).

3.3.3 Anomaly insertion

Through Mode

Anomaly insertion BPV, B1, B2 and REI-L

3.3.4 Defect generation

Through Mode

Defect generation is not possible.

3.3.5 Measurements

There are no restrictions on measurements (see Sec. 3.2, Page S-12).



4 E1 to E4 signals

Available with ANT-20SE version 3060/01 or with ANT-20SE version 3060/02 and option 3035/90.33.

Test signals for bit error measurements.

Signal structure for all bit rates

- unframed test pattern
- framed test pattern

Test pattern

Digital word length 16 bits

Pseudo-random bit sequences PRBS 11, PRBS11 invers, PRBS 15, PRBS 20, PRBS 23, PRBS 23 invers

Frames

E1 (2.048 Mbit/s; G.704/706) PCM 30/31 with and without CRC

E2 (8.448 Mbit/s; G.742) PCM 120

E3 (34.368 Mbit/s; G.751) PCM 480

E4 (139.264 Mbit/s; G.751) PCM 1920



4.1 Error insertion and alarm generation (TX)

4.1.1 Error insertion (anomalies)

Error insertion (anomalies) bit errors in test pattern (TSE),
code errors (single errors only)

Trigger typesSingle
or Rate

Tip: When Rate triggering is selected a bit error rate is inserted.

Anomaly	Single	Rate ¹
FAS-140, FAS-3, FAS-8, FAS-2	yes	2E-3 to 1E-8
TSE	yes	1E-2 to 1E-8
BPV	yes	-
1 Mantissa: 1 to 9 (only 1 for TSE), exponent: -1 to -10 (whole numbers)		

Table S-11 Available anomalies and trigger modes

The insertion of **errors** (anomalies) **and alarms** (defects) is mutually exclusive. The first action selected is active. The second action is rejected.

4.1.2 Alarm generation (defects)

Defect	Test sensor function	Test sensor thresholds
-	On/Off	M in N
AIS-140, AIS-34, AIS-8, AIS-2	yes	-
LOF-140, LOF-34, LOF-8, LOF-2	yes	M = 1 to N-1 N = 1 to 1000
RDI -140, RDI-34, RDI-8, RDI-2	yes	M = 1 to N-1 N = 1 to 1000

Table S-12 Available defects

The insertion of **alarms** (defects) **and errors** (anomalies) is mutually exclusive. The first action selected is active. The second action is rejected.



4.2 Error measurement and alarm detection (RX)

4.2.1 Error measurement (anomalies)

Evaluation

All errors (anomalies) are counted simultaneously and stored.

Gate times 1 to 99 seconds
or 1 to 99 minutes
or 1 to 99 hours
or 1 to 99 days

Intermediate results 1 to 99 seconds
or 1 to 99 minutes

Display

of anomalies via LEDs:

CURRENT LED (red) is on when the anomaly is present

HISTORY LED (yellow) is on if the anomaly occurred at least once or is active within the started measurement interval.

Anomaly	LED
FAS-140, FAS-34, FAS-8, FAS-2	FAS/CRC
CRC-4 ¹	FAS/CRC
E bit ¹	-
TSE	TSE
BPV	-
1 Requires option 3035/90.30 or 3035/90.31	

Table S-13 LED display of available anomalies



4.2.2 Alarm detection (defects)

Evaluation

All alarms (defects) which occur are evaluated simultaneously where possible and stored. Storage takes place only within a started measurement interval.

Time resolution of defects100 ms

Display

of defects via LEDs:

CURRENT LED (red) is on when the defect is present.

HISTORY LED (yellow) is on if the defect occurred at least once or is active within the started measurement interval.

Defect	LED
AIS-140, AIS-34, AIS-8, AIS-2, AIS-64k	AIS
LOF-140, LOF-34, LOF-8, LOF-2	LOF/LCD
LSS	LSS
RDI-140, RDI-34, RDI-8, RDI-2	RDI(AIS-)/YELLOW

Table S-14 LED display of available defects



4.3 Drop&Insert / Through Mode

Option: BN 3035/90.20

4.3.1 Functions

This Option provides the following functions for all PDH multiplex options fitted to the ANT-20SE.

Drop&Insert

This function is only available in conjunction with the following options:

- PDH MUX/DEMUX
M13 MUX/DEMUX: BN 3035/90.30 to BN 3035/90.32

– or –

- STM-1 mappings: BN 3035/90.01 to BN 3035/90.05
STS-1 mappings: BN 3035/90.10 to BN 3035/90.13

– or –

- Optical interfaces BN 3035/90.40 to BN 3035/90.48
BN 3035/90.50 and BN 3035/90.51

The characteristics and specifications for the Drop&Insert function are given in the descriptions for the various options.

Through Mode

The received signal is looped through the ANT-20SE and re-transmitted by the generator. The ANT-20SE operates in Through Mode as a signal monitor without affecting the signal.

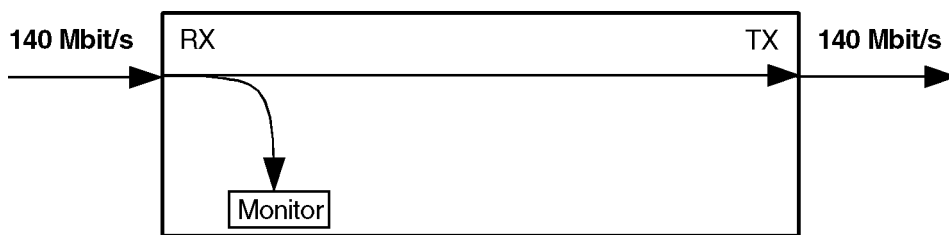

Fig. S-4 Through Mode: Generator and receiver coupled

The ANT-20SE provides access to the tributary channels within the “MUX/DEMUX” chain when used in conjunction with the “PDH MUX/DEMUX” and “M13 MUX/DEMUX” options, BN 3035/90.30 to BN 3035/90.32. This also applies if the PDH signal is transmitted in a container.

The looped-through signal can also be jittered using the Jitter Generator options (Jitter Generator up to 155 or 622 Mbit/s, BN 3035/90.60 to 61). This function is available for all bit rates fitted to the instrument.

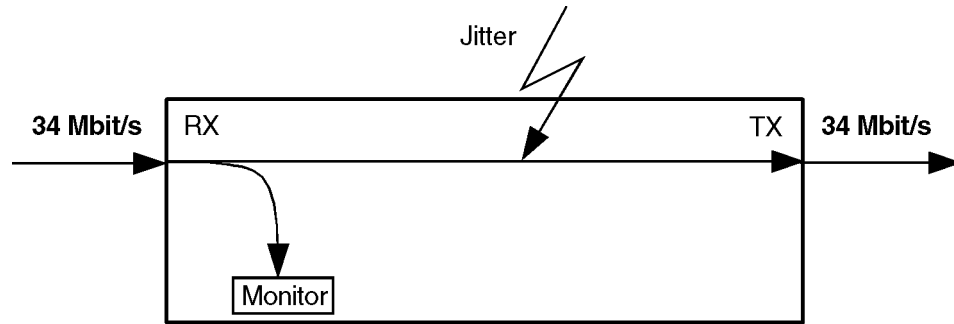

Fig. S-5 Through Mode: Adding jitter to the looped-through signal

4.3.2 Clock generator

Through Mode

In Through Mode, clock generation is always derived from the receive signal clock. No offset is possible in this operating mode (see Sec. 1.2.2, Page S-4).

4.3.3 Anomaly insertion

Through Mode

Anomaly insertion BPV, B1, B2 and MS-REI

4.3.4 Defect generation

Through Mode

Defect generation is not possible.

4.3.5 Measurements

There are no restrictions on measurements (see Sec. 4.2, Page S-18).



5 Measurement modes

5.1 Evaluation to ANSI/BELL

Evaluations can be performed on the following levels (alternatives):

- SONET: Section, line, STS path, VT path
- DS3: Line, path
- DS1: Line, path
- Bit

“Near End” and “Far End” analyses are performed simultaneously if available.

ES, SES, EFS, SEFS and UAS are evaluated.

The SES and UAS threshold settings correspond to GR-253 (Performance Monitoring) and T1.231.

5.2 Evaluation to ITU-T G.821

ES, EFS, SES and UAS are evaluated; DM (degraded minutes) are also evaluated. The multiplex factor used in older versions of Recommendation G.821 (Annex D) can be applied if required.

G.821 evaluation can be performed on the following events:

- FAS bit errors (FAS 2, FAS 8, FAS 34, FAS 140)
- CRC errors
- E bit errors
- Bit errors (TSE, Test Sequence Error)

The following signals can be measured when performing G.821 evaluation of bit errors (TSE):

- unframed patterns
- $n \times 64$ kbit/s
- framed patterns and bulk signals
- Overhead bytes E1, E2, F1, F2, D1 to D3 and D4 to D12

Pass/fail assessment in conjunction with path allocation of between 0.1 and 100%.

The SES threshold can be set as required.

Since G.821 evaluation requires evaluation of bit errors, facilities for evaluating block errors are disabled.

Display

of defects via LEDs:

CURRENT LED (red) is on when the defect is present.

HISTORY LED (yellow) is on if the defect occurred at least once or is active within the started measurement interval.



5.3 Evaluation to ITU-T G.826

The following are evaluated: EB, BBE, ES, EFS, SES and UAS.
 Pass/Fail assessment depending on path allocation of 0.1 to 100%.
 The thresholds for SES and UAS can be set by the user.

In-service measurement (ISM)

Simultaneous in-service measurement of "near end" and "far end" of a selected path:

Near end: HP-B3, LP-B3, BIP2, FAS bei 140/34/8 oder 2M, CRC 4, DS3FAS,
 DS3-P-Parity, DS3-C-Parity, DS1FAS, D1-CRC6

Far end: HP-REI, LP-REI, E-Bit bei 2M, DS3-FEBE

Out-of-service measurement (OOS)

Out-of-service measurement using bit errors in a test pattern (for PDH and SDH).

Display

of defects via LEDs:

CURRENT LED (red) is on when the defect is present.

HISTORY LED (yellow) is on if the defect occurred at least once or is active within the started measurement interval.

5.4 Evaluation to ITU-T G.828

ES, EFS, SES, UAS, BBE and SEP are evaluated.

Pass/fail assessment in conjunction with path allocation of between 0.1 and 100%.

The thresholds for SES and UAS can be set by the user.

G.828 evaluation can be performed on the following events:

- B1
- B2SUM
- MS-REI
- B3
- HP-REI
- LP-BIP 2/8
- LP-REI
- Bit errors (TSE)

Evaluation of the near end and the far end is simultaneous as soon as the signal structure set allows a far end measurement.

Far end evaluations can only be made if REI is available.



Bit errors can be evaluated for:

- unframed patterns
- framed patterns and bulk signals
- Overhead bytes E1, E2, F1, F2, F2L, D1 through D3 and D4 through D12 in the SOH/POH of SDH signals

As the G.828 evaluation measures block errors, bit error evaluation cannot be activated.

Display

of defects using LED indicators

(also in the Anomaly/Defect Analyzer – Summary display window):

CURRENT LED (red) is on when the defect is present.

HISTORY LED (yellow) is on if the defect occurred at least once or is active within the started measurement interval.

5.5 Evaluation to ITU-T G.829

ES, EFS, SES, UAS and BBE are evaluated..

The SES threshold can be set as required.

G.829 evaluation can be performed on the following events:

- B1
- B2SUM
- MS-REI
- Bit errors (TSE)

Evaluation of the near end and the far end is simultaneous as soon as the signal structure set allows a far end measurement.

Far end evaluations can only be made if REI is available.

Bit errors can be evaluated for:

- unframed patterns
- framed patterns and bulk signals
- Overhead bytes E1, E2, F1, F2, F2L, D1 through D3 and D4 through D12 in the SOH/POH of SDH signals

The special block error evaluation using BIP-1 blocks means that the instrument is run in bit error evaluation mode. It is therefore not possible to switch to block error evaluation. This does not apply to the TSE meas. point, for which real block errors are evaluated. Therefore you cannot switch to bit error evaluation when making a G.829 evaluation on TSEs.



Display

of defects using LED indicators
(also in the Anomaly/Defect Analyzer – Summary display window):

CURRENT LED (red) is on when the defect is present.

HISTORY LED (yellow) is on if the defect occurred at least once or is active within the started measurement interval.

5.6 Evaluation to ITU-T M.2100

ES, EFS, SES and UAS are evaluated.

Pass/Unknown/Fail assessment based on the threshold values S1 and S2 for ES and SES. The threshold values are calculated internally as per M.2100 and displayed in the results window.

Settings for S1 and S2:

Path allocation0.1 to 100%

BISO (“Bringing into Service Objectives”) multiplication factor.0.1 to 100

The M.2100 evaluation can be performed on the following events:

- FAS bit errors (FAS1.5, FAS2, FAS8, FAS34, FAS45 and FAS140)
- CRC-4 errors
- CRC-6 errors
- EBIT errors
- PBIT errors
- Bit errors (TSE)

For PCM30CRC signals, evaluation is made at the “Near End” and at the “Far End” simultaneously.

Bit errors can be evaluated for:

- unframed patterns
- framed patterns and bulk signals
- n x 64 kbit/s
- Overhead bytes E1, E2, F1, F2, D1 to D3 and D4 to D12

Since M.2100 evaluation requires evaluation of bit errors, facilities for evaluating block errors are disabled.

Display

of defects using LED indicators
(also in the Anomaly/Defect Analyzer – Summary display window):

CURRENT LED (red) is on when the defect is present.

HISTORY LED (yellow) is on if the defect occurred at least once or is active within the started measurement interval.



5.7 Evaluation to ITU-T M.2101

ES, EFS, SES, UAS, BBE and SEP are evaluated.

Pass/Unknown/Fail assessment based on the threshold values S1 and S2 for ES, SES, BBE and SEP. The threshold values are calculated internally as per M.2101 and displayed in the results window.

Settings for S1 and S2:

Path allocation 0.1 to 100%

BISO (“Bringing into Service Objectives”) multiplication factor 0.1 to 100

The M.2101 evaluation can be performed on the following events:

- B1
- B2SUM
- MS-REI
- B3
- HP-REI
- LP-BIP 2/8
- LP-REI
- Bit errors (TSE)

Evaluation of the near end and the far end is simultaneous as soon as the signal structure set allows a far end measurement.

Far end evaluations can only be made if REI is available.

Bit errors can be evaluated for:

- unframed patterns
- framed patterns and bulk signals
- Overhead bytes E1, E2, F1, F2, F2L, D1 through D3 and D4 through D12 in the SOH/POH of SDH signals

As the M.2101 evaluation measures block errors, bit error evaluation cannot be activated. Exception: B2SUM. BIP-1 blocks are used for this. These are only accessible in the instrument via a bit error measurement. For this reason, block error evaluation is not available for a M.2101 evaluation on B2SUM.

Display

of defects via LEDs
(also in the Anomaly/Defect Analyzer – Summary display window):

CURRENT LED (red) is on when the defect is present.

HISTORY LED (yellow) is on if the defect occurred at least once or is active within the started measurement interval.



6 Automatic measurements

6.1 Auto configuration

The auto configuration function sets the ANT-20SE receiver automatically. The routine searches for the presence of standard SDH, SONET, PDH or ATM signals at the electrical inputs (for the input level ranges “ITU-T”/“High” or “PMP”/“Low”), or at the optical inputs. The instrument version and options fitted are taken into account. The main emphasis is placed on detecting the signal structure. Detailed matching to the signal contents can be carried out manually if desired.

The sequence is divided into three parts:

- Check Interface
- Check Mapping
- Check Payload

6.1.1 Check Interface

Matching to the physical parameters (bit rate/code)

Allowed-for defects LOS

Other factors. input bit rate frequency offset > 150 ppm

6.1.2 Check Mapping

A check is made for the mapping structure using the Signal Label and the pointer bytes (to differentiate between AU-4 and AU-3). The check is always made in channel #1.

With STM-16 / OC-48 signals, a check is made for an AU-4 structure only in “ITU-T” mode or for an AU-3 structure only in “ANSI” mode.

OC-12c/STM-4c Virtual Concatenation is not recognized by the autoconfiguration function.

Allowed-for defects:

Defect (SDH)	Defect (SONET)
LOF/OOF	LOF/OOF
AU-AIS	AIS-P
MS-AIS	AIS-L
TU-AIS	AIS-V
AU-LOP	LOP-P
TU-LOP	LOP-V
LOM	LOM

Table S-15 Defects allowed for during auto configuration



If UNEQuipped is detected, the mapping previously selected or a default mapping will be set. Auto configuration recognizes "C-11 via TU-12" mapping as "C-12" mapping.

6.1.3 Check Payload

The check only takes account of the test patterns recommended in the relevant standards.

6.1.3.1 PDH signals

Checks for unframed or framed payload signals on all hierarchy levels

Allowed-for defects LOF/(OOF)
AIS

6.1.3.2 ATM signals

Checks for ATM signals

Allowed-for defects LOF/(OOF), AIS, LCD
LOF PLCP, AIC, IDLE DS3



6.1.4 Structure and results

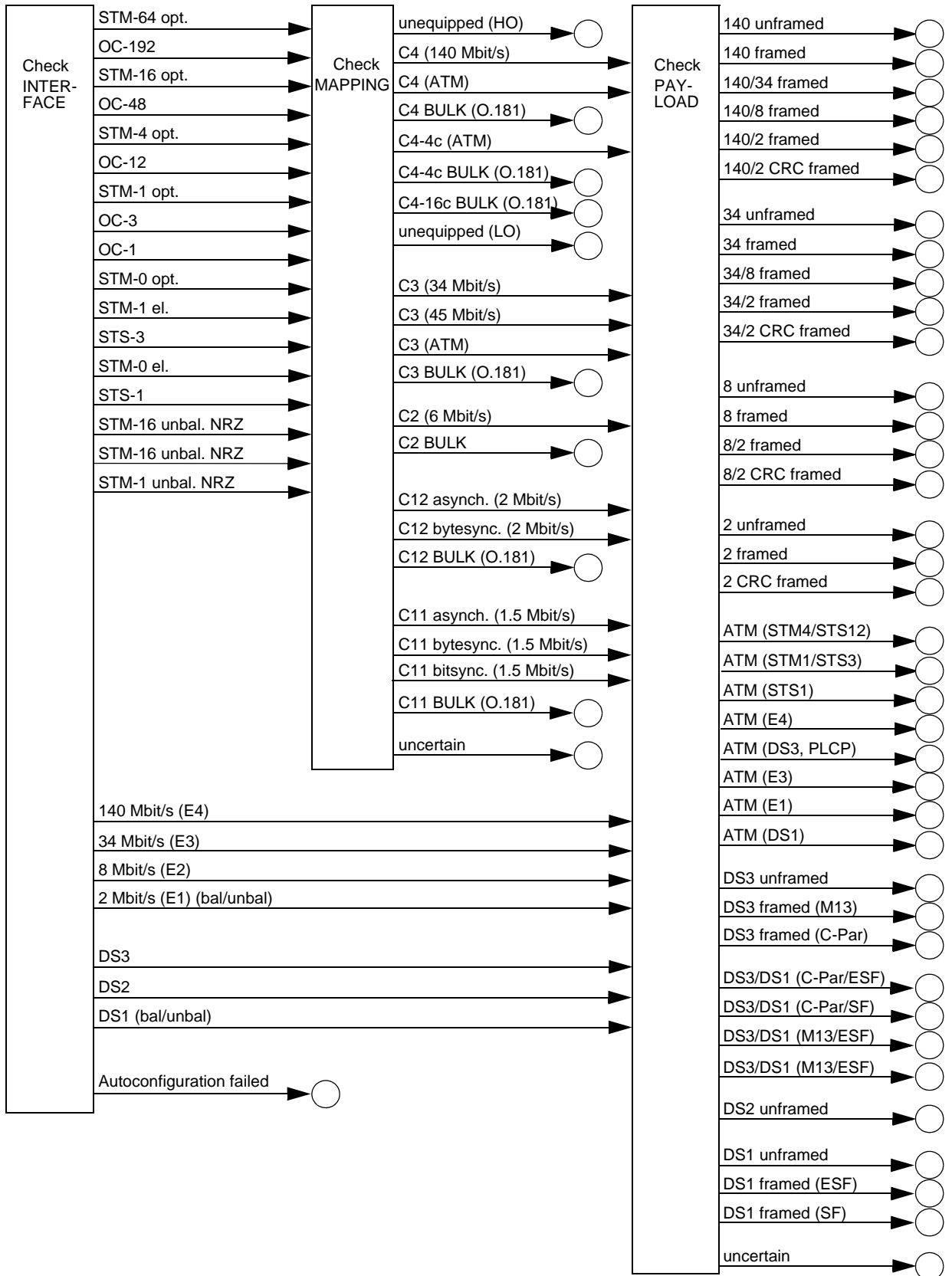

Fig. S-6 Structure and results



6.2 Automatic “Scan” function

The “Scan” function permits sequential testing of all tributary channels in an SDH or SONET signal. The appropriate mapping options are needed for this.

- SDH signals C-12 mapping
 - C-11 mapping
 - C-11/TU-12 mapping
 - C2 mapping

- SONET signals VT1.5 mapping
 - VT2 mapping
 - VT6 mapping

The test is performed within an AU (SDH version) or a SPE (SONET version). Selection of the various AUs / SPEs for signals with higher bit rates is done manually.

The settings for the generator and receiver must be matched for loop measurements.

The channel scan takes place synchronously on the transmit and receive sides. If the signal structure settings differ, only the receive channel settings will be altered.

The ANT-20SE receiver checks the receive signal defects and those of the corresponding SDH or SONET structure and of the channel and enters the results of the single channels in a matrix.

Allowed-for defects:

Defect (SDH)	Defect (SONET)
LOS	LOS
LOF/OOF (SDH)	LOF/OOF (SONET)
AU-AIS	AIS-P
MS-AIS	AIS-L
TU-AIS	AIS-V
AU-LOP	LOP-P
TU-LOP	LOP-V
HP-UNEQ	UNEQ-P
LP-UNEQ	UNEQ-V
TU-LOM	LOM
AIS (2 Mbit/s)	AIS (E1)
LOF (2 Mbit/s)	LOF (E1)
AIS (1.5 Mbit/s)	AIS (DS1)
LOF (1.5 Mbit/s)	LOF (DS1)
OOF (1.5 Mbit/s)	OOF (DS1)
AIS (64 kbit/s)	AIS (64 kbit/s)
LSS	LSS

Table S-16 Defects allowed for during the “Scan” function



6.3 Automatic “Search” function

The “Search” function allows you to search for a tributary channel in a SDH or SONET signal. The appropriate mapping options are needed for this.

SDH signals	C-12 mapping
	C-11 mapping
	C-11/TU-12 mapping
	C2 mapping
SONET signals	VT1.5 mapping
	VT2 mapping
	VT6 mapping

The test is performed within an AU (SDH version) or a SPE (SONET version). Selection of the various AUs / SPEs for signals with higher bit rates is done manually.

During the search, only the receive channels are altered.

The ANT-20SE receiver checks the receive signal defects and those of the corresponding SDH or SONET structure and of the channel and enters the results of the single channels in a matrix.

Allowed-for defects:

Defect (SDH)	Defect (SONET)
LOS	LOS
LOF/OOF (SDH)	LOF/OOF (SONET)
AU-AIS	AIS-P
MS-AIS	AIS-L
TU-AIS	AIS-V
AU-LOP	LOP-P
TU-LOP	LOP-V
HP-UNEQ	UNEQ-P
LP-UNEQ	UNEQ-V
TU-LOM	LOM
AIS (2 Mbit/s)	AIS (E1)
LOF (2 Mbit/s)	LOF (E1)
AIS (1.5 Mbit/s)	AIS (DS1)
LOF (1.5 Mbit/s)	LOF (DS1)
OOF (1.5 Mbit/s)	OOF (DS1)
AIS (64 kbit/s)	AIS (64 kbit/s)
LSS	LSS

Table S-17 Defects allowed for in the “Search” function



6.4 Automatic "Trouble Scan" function

The "Trouble Scan" function permits sequential testing of all tributary channels in an SDH or SONET signal. The appropriate mapping options are needed for this.

- SDH signals C-12 mapping
 - C-11 mapping
 - C-11/TU-12 mapping
 - C2 mapping

- SONET signals VT1.5 mapping
 - VT2 mapping
 - VT6 mapping

The test is performed within an AU (SDH version) or a SPE (SONET version). Selection of the various AUs / SPEs for signals with higher bit rates is done manually.

During the "Trouble Scan", only the receive channels are altered.

The ANT-20SE receiver checks the receive signal defects and those of the corresponding SDH or SONET structure and of the channel and enters the results of the single channels in a matrix. You can display a detailed alarm history by selecting an individual channel from within the matrix.

Allowed-for defects:

Defect (SDH)	Defect (SONET)
LOS	LOS
LOF/OOF (SDH)	LOF/OOF (SONET)
AU-AIS	AIS-P
MS-AIS	AIS-L
TU-AIS	AIS-V
AU-LOP	LOP-P
TU-LOP	LOP-V
MS-RDI	RDI-L
HP-RDI	RDI-P
LP-RDI	RDI-V
HP-UNEQ	UNEQ-P
LP-UNEQ	UNEQ-V
TU-LOM	LOM
HP-PDI	PDI-P
LP-PDI	PDI-V
AIS (2 Mbit/s)	AIS (E1)
LOF (2 Mbit/s)	LOF (E1)
RDI (2 Mbit/s)	RDI (E1)

Table S-18 Defects allowed for in the "Trouble Scan" function



Defect (SDH)	Defect (SONET)
AIS (1.5 Mbit/s)	AIS (DS1)
LOF (1.5 Mbit/s)	LOF (DS1)
OOF (1.5 Mbit/s)	OOF (DS1)
YELLOW (1.5 Mbit/s)	YELLOW (DS1)

Table S-18 Defects allowed for in the "Trouble Scan" function (*continued*)



6.5 Automatic “Signal Delay” measurement

The ANT-20SE measures the signal delay between the generator and receiver using characteristic sequences in the selected PRBS. The signal delay measurement is automatic and continuous, i.e. individual measurements are repeatedly performed. Practically any signal structure that can be set on the ANT-20SE can be used for the measurement.

Exceptions:

- ATM signal structures
- Overhead measurements
- Through Mode
- ADM test

The measurement range and measurement time depend on the pattern bit rate and the selected pattern.

The maximum possible measurement value depends on the length of the PRBS. The maximum value is calculated and shown in the results window. This value can be influenced by selecting a shorter or a longer test pattern.

Signal structure	Short test pattern	Max. measured value, in ms	Long test pattern	Max. measured value, in ms
C4 Bulk	PRBS23 ¹	56	-	56
C3 Bulk	PRBS23 ¹	173	-	173
C2 Bulk	PRBS20	154	PRBS23	1236
C12 Bulk	PRBS20	481	PRBS23	3855
C11 Bulk	PRBS20	655	PRBS23	5242
140M unframed	PRBS23 ¹	60	-	60
140M framed	PRBS23 ¹	60	-	60
45M unframed	PRBS23 ¹	187	-	187
45M framed	PRBS23 ¹	189	-	189
34M unframed	PRBS23 ¹	244	-	244
34M framed	PRBS23 ¹	246	-	246
8M unframed	PRBS20	124	PRBS23	992
8M framed	PRBS20	125	PRBS23	985
6M unframed	PRBS20	166	PRBS23	1328
6M framed	PRBS20	169	PRBS23	1356
2M unframed	PRBS20	512	PRBS23	4096
2M framed PCM30	PRBS20	546	PRBS23	4369
2M framed PCM31	PRBS20	528	PRBS23	4228
1.5M unframed	PRBS20	679	PRBS23	5433
1.5M framed	PRBS20	682	PRBS23	5461
1 Measurement only possible with this test pattern				
2 depending on n				

Table S-19 Max. measurement values as a function of signal structure and test pattern



Signal structure	Short test pattern	Max. measured value, in ms	Long test pattern	Max. measured value, in ms
n x 64 k unframed (25 ≤ n ≤ 32)	PRBS20	511 to 655 ²	PRBS23	4095 to 5242 ²
n x 64 k unframed (17 ≤ n ≤ 24)	PRBS20	682 to 963 ²	PRBS23	5461 to 7710 ²
n x 64 k unframed (9 ≤ n ≤ 16)	PRBS15	31 to 56 ²	PRBS23	8191 to 14563 ²
n x 64 k unframed (2 ≤ n ≤ 8)	PRBS15	255 to 63 ²	PRBS20	2047 to 8191 ²
64k unframed	PRBS15	511	PRBS20	16383
1 Measurement only possible with this test pattern 2 depending on n				

Table S-19 Max. measurement values as a function of signal structure and test pattern (*continued*)

The accuracy and display resolution also depend on the pattern bit rate.

Pattern bit rate	Accuracy	Resolution
64 kbit/s < 1.544 Mbit/s	± 200 μsec	100 μsec
1.544 Mbit/s ≤ 8.448 Mbit/s	± 10 μsec	10 μsec
> 8.448 Mbit/s	± 1 μsec	1 μsec

Table S-20 Delay measurement accuracy as a function of pattern bit rate



7 Other inputs and outputs

7.1 DCC/ECC [21]

Interface for inserting/outputting TOH/POH bytes.

The bytes are filled dynamically in real-time with a contradirectional clock and synchronization signal for n x 64 kbit/s channels per frame.

The clock signal is smoothed. The RX data signal is sampled on the falling edge of the RX clock. Exchange of TX data takes place on the rising edge of the TX clock.

- 64 kbit/s: 1 byte/frame
- 128 kbit/s: 2 bytes/frame
- 192 kbit/s: 3 bytes/frame
- 576 kbit/s: 9 bytes/frame

Interface to..... V.11 (ITU-T X.24 and X.27)

Socket [21].....MINI DELTA RIBBON, 20-pole

Pin no.	Signal	Input/Output
1	Ground	
2	Ground	
3	RX data	Input
4	RX data (inv)	Input
5	RX control	Output
6	RX control (inv)	Output
7	RX clock	Input/Output
8	RX clock (inv)	Input/Output
9	RX synch	Input/Output
10	RX synch (inv)	Input/Output
11	TX data	Output
12	TX data (inv)	Output
13	TX control	Output
14	TX control (inv)	Output
15	TX clock	Output
16	TX clock (inv)	Output
17	TX synch	Output
18	TX synch (inv)	Output
19	Ground	
20	+5 V/100 mA	

(inv): inverted signal

Table S-21 DCC/ECC interface pin signals (V.11)



7.2 TRIGGER [26]

Socket BNC

Input

Input impedance 75 Ω

Permitted pulse amplitude range HCMOS level

Max. peak input voltage ± 6 V

Output

Reference clock 2.048 MHz
(derived from internal reference or from
external reference clock [25])

TSE (Test Sequence Error) RZ pulses

TX frame trigger (SDH and SONET signal) RZ pulses

TX pattern trigger RZ pulses
(not for "140 Mbit/s unframed/framed" with digital word)

Input impedance 75 Ω

Pulse amplitude HCMOS level

Max. permitted peak applied voltage level ± 6 V

7.3 REF CLOCK IN [25]

Reference clock input

SDH version 3035/01

Socket BNC

Input impedance 75 Ω

Max. permitted peak input voltage ± 6 V



Input signal	Line code, pulse shape	Amplitude	Coupling	Max. permitted offset
2.048 Mbit/s	HDB3	2.34 V ± 10%	DC	± 10 ppm
2.048 MHz (clock)	square, sinewave	1 Vpp to 5 Vpp	AC	± 10 ppm
1.544 Mbit/s	B8ZS	2.34 V ± 10%	DC	± 10 ppm
1.544 MHz (clock)	square, sinewave	1 Vpp to 5 Vpp	AC	± 10 ppm

Table S-22 Specifications for reference clock signals

SONET Version BN 3035/02

Socket Bantam

Input impedance 110 Ω

Max. permitted peak input voltage..... ± 6 V

Input signal	Line code, pulse shape	Amplitude	Coupling	Max. permitted offset
2.048 Mbit/s	HDB3	3.0 V ± 10%	DC	± 10 ppm
2.048 MHz (Clock)	square, sinewave	1 Vpp to 5 Vpp	AC	± 10 ppm
1.544 Mbit/s	B8ZS	3.0 V ± 10%	DC	± 10 ppm
1.544 MHz (Clock)	square, sinewave	1 Vpp to 5 Vpp	AC	± 10 ppm

Table S-23 Specifications for reference clock signals

LTI (Loss of Timing Interval) status display

The LED is on when TX clock generation is set to “Derived from reference clock [25]” and no clock or signal is present. The LED is also on if the clock or signal has a frequency offset of more than 10 ppm (trigger threshold is between 10 and 30 ppm).

7.4 CLOCK [22]

Clock output with unjittered TX clock

Socket BNC

Bit rate range 1.544 MHz to 155.52 MHz
at STM-4/OC-12, STM-16/OC-48, STM-64/OC-192 155.52 MHz

Output impedance approx. 10 Ω

Pulse amplitude ≥ 400 mV into 75 Ω, AC coupled

Max. permitted peak applied voltage..... ± 6 V



8 Built-in operation and control computer (PC)

Operating system

ANT-20SE Windows95™

The relevant copyright conditions must be observed.

CPU

The CPU is constantly being updated. The current CPU and hard disk characteristics are displayed after switching on the instrument during the boot-up screen display.

CPU 486/DX 4-100 or better
3.3 V technology

Memory

DRAM 32 MB, PS/2 module

expandable to max. 64 Mbyte

Hard disk at least 540 Mbyte

Floppy drive

Disk drive 3.5"; 1.44 Mbyte

PCMCIA interface [02]

Controller conforms to PCMCIA 2.1

Drive A PCMCIA Type I + II + III cards

Drive B PCMCIA Type I + II cards

The PCMCIA interface provides access to a wide range of remote-control interfaces:

- IEEE bus remote control, BN 3035/92.10
- For using other PCMCIA cards, "Card and Socket Services" are required. These are included with the remote-control options.

Display

Color TFT screen 9.5"; 512 colors

Resolution 640 x 480 pixels (standard VGA)



Connector for external display [04]

The built-in and external displays can be operated simultaneously

- Interface standard VGA
- Resolution 640 x 480 pixels
- Refresh rate approx. 60 Hz
- Socket 15-way 3-row submin. D socket

Keyboard

Built-in

- Standard PC keyboard US-ASCII

External keyboard connector [03]

The PC configuration must be matched to the type of external keyboard used.

- Interface IBM-AT/PS/2
- Connector 6-pole Mini-DIN socket

Mouse connector [01]

- Interface PS/2 mouse interface
- Connector 6-pole Mini-DIN socket

Parallel interface [05]

- Interface IEEE 1284
- Socket 25-way 2-row submin. D socket

Serial interface [06]

- Interface V.24/RS 232
- Socket 9-way 2-row submin. D socket

Battery

- Type Lithium
- Life time >5 years

The battery serves as the buffer for the PC clock's supply voltage and for saving the CMOS setup.



9 General specifications

9.1 Power supply

Nominal voltage (automatic range switching) 100 to 127 V and 200 to 240 V

Operating range 90 to 140 V and 193 to 264 V

AC line frequency 50 or 60 Hz ±5%

Power consumption ANT-20SE < 600 VA

Safety class to IEC 1010-1 1

9.2 Climatic and mechanical ambient conditions

	IEC 721-3	ETS 300 019-1
Storage	Class IE 12	Class 1.1
Transport	Class IE 23 ¹	Class 2.3 ¹
Operation	Class IE 72	Class 7.1
1 With temperature range restrictions (see Tab. S-25)		

Table S-24 Applicable IEC and ETS classes



9.2.1 Climatic and mechanical data

	Storage: IE 12 (1K3, 1M2) ETS 1.1	Transport: IE 23 (2K4, 2M3) ETS 2.3	Operation: IE 72 (7K1, 7M2) ETS 7.1
Temperature	-5 to +45 °C	-40 to +70 °C (limited to -25 to +70 °C)	+5 to +40 °C (limits operating range: 0 to +50 °C)
Humidity: < 30 °C Humidity: > 30 °C	5 to 95% 1 to 29 g/m ³	5 to 95% 1 to 29 g/m ³	5 to 85% 1 to 25 g/m ³
Condensation	yes	yes	yes
Precipitation	no	6 mm/min	no
Water	no	1 m/s	no
Ice formation	yes	yes	no
Damp	-	damp loading surface	-
Sinusoidal vibration	9 to 200 Hz: 5 m/s ²	8 to 200 Hz: 20 m/s ² 200 to 500 Hz: 40 m/s ²	9 to 200 Hz: 10 m/s ² 200 to 500 Hz: 15 m/s ²
Shock: 11 ms duration Shock: 6 ms duration	- -	300 m/s ² 1000 m/s ²	100 m/s ² 300 m/s ²
Free drop	-	1.0 m	0.1 m
Toppling	-	all edges	all edges

Table S-25 Major parameters for the classes (see Fig. S-24)

9.3 EC conformance declaration/CE mark

Interference generation to EN 50 081-1

Interference immunity to EN 50 082-1

9.3.1 EMC interference suppression

Interference suppression

This instrument meets the requirements of EN 50 081-1 and hence limit value class B of EN 55 022 (identical with CISPR 22:1985 modif., DIN VDE 0878 part 3) and FCC Rules Part 15 Subpart J Class A. The instrument conforms to the safety aims of European regulation 89/336/EWG of 03.05.89 in respect of interference suppression. A special permit for operation is not required.

The instrument has been tested such that the requirements in respect of interference suppression for this instrument will also be met if it is operated in a system.

This is conditional upon the correct construction of the system and the use of the specified connecting cables, with particular attention being paid to adequate screening.



If the device under test connected to this instrument is in itself capable of generating interfering radiation, e.g. when the screening to the device under test is not continuous, the user must ensure that any interference generated remains within the prescribed limits. Suitable screening precautions may be additionally required.

Interference suppression corresponds to EN 55022/CISPR 22 class B

Intrinsic magnetic scatter field

at AC line frequency and a distance of 30 cm < 3 A/m

9.3.2 EMC interference immunity

Tip: Reduced functionality, self-recovering:

During the presence of interference, the signal received by the instrument can be affected to such an extent that an error is detected. This may, for example, be a code error, and depending on the time of occurrence may be a bit, FAS or parity error. Error bursts may lead to alarms.

Such errors and alarms only occur when interference is present.

To keep the effects of interference as small as possible, the system must be correctly constructed using the prescribed cables, with particular attention being paid to adequate screening.

When using standard PC accessories, make sure that these meet the requirements of the EMC regulations (CE mark).

Immunity to electrostatic discharge

to IEC 1000-4-2 or IEC 801 - 2

Reduced functionality (self-recovering) up to 4 kV direct contact discharge
or up to 8 kV air path discharge

Immunity to radiated interference

to IEC 1000-4-3 or IEC 801-3

Full functionality up to 3 V/m

in the frequency range 27 MHz to 1000 MHz
and at 1890 MHz

Rapid transient interference immunity

to IEC 1000-4-4 or IEC 801-4

on signal circuits

Reduced functionality (self-recovering) up to 500 V

on AC line circuits

Reduced functionality (self-recovering) up to 1kV



External magnetic field immunity

to IEC 1000-4-8

Full functionality 3 A/m at 50 or 60 Hz

9.4 Noise emission

A-weighted noise pressure level at 1 m distance approx. 48 dB (A)

9.5 Calibration/Maintenance

Recommended confirmation interval 2 years

9.6 Dimensions/Weight

Weight

including protective cover approx. 15 kg

Dimensions (w x h x d) in mm

including protective cover approx. 360 x 370 x 290



9.7 Ordering information

9.7.1 Mainframe ANT-20SE

Advanced Network Tester ANT-20SE

SDH version **BN 3060/01**

One STM-1 mapping is included in the price; select the mapping option you require.

The following options are included:

Touchscreen. BN 3035/93.11

CPU-RAM-Erweiterung 32 MB. BN 3035/92.15

Advanced Network Tester ANT-20SE

SONET version **BN 3060/02**

One STS-1 mapping is included in the price; select the mapping option you require.

The following options are included:

Touchscreen. BN 3035/93.11

CPU-RAM-Erweiterung 32 MB. BN 3035/92.15



9.7.2 Options

Touchscreen	BN 3035/93.11
CPU RAM expansion to 32 MB	BN 3035/93.15

SONET mappings

STS-1 mappings for ANSI tributaries

VT1.5 SPE/STM-0 (1.5 Mbit/s in STS-1)	BN 3035/90.10
VT6 SPE (6 Mbit/s, unframed in STS-1)	BN 3035/90.11
STS-1 SPE (45 Mbit/s in STS-1)	BN 3035/90.12

STS-1 mappings for ETSI tributaries

VT2 SPE/STM-0 (2 Mbit/s in STS-1)	BN 3035/90.13
---	---------------

DS1 and DS3 interface

Bit error rate tests 1.5 /45 Mbit/s (included in SONET version 3035/02)	BN 3035/90.34
--	---------------

STM-1 mappings

for ETSI tributaries

C-12 (2 Mbit/s in STM-1, AU-3/AU-4)	BN 3035/90.01
C-3 (34 Mbit/s in STM-1, AU-3/AU-4)	BN 3035/90.02
C-4 (140 Mbit/s in STM-1)	BN 3035/90.03

for ANSI tributaries

C-11 (1.5 Mbit/s in STM-1, AU-3/AU-4, TU-11/TU-12)	BN 3035/90.04
C-3 (45 Mbit/s in STM-1, AU-3/AU-4)	BN 3035/90.05
C-2 (6 Mbit/s, unframed in STM-1, AU-3/AU-4)	BN 3035/90.06

Extended Overhead Analysis	BN 3035/90.15
---	----------------------

Drop&Insert	BN 3035/90.20
------------------------------	----------------------

PDH functions

PDH MUX/DEMUX chain 64k/140M	BN 3035/90.30
PDH DEMUX chain 64k/140M	BN 3035/90.31
M13 MUX/DEMUX chain	BN 3035/90.32
Bit error rate tests 2/8/34/140 Mbit/s (included in SDH version 3035/01)	BN 3035/90.33



Optical interfaces

Optical STM-1, OC-1/3, 1310 nmBN 3035/90.43
Optical STM-1, OC-1/3, 1550 nmBN 3035/90.44
Optical STM-1, OC-1/3, 1310 and 1550 nmBN 3035/90.45
Optical STM-1/4, OC-1/3/12, 1310 nmBN 3035/90.46
Optical STM-1/4, OC-1/3/12, 1550 nmBN 3035/90.47
Optical STM-1/4, OC-1/3/12, 1310 and 1550 nmBN 3035/90.48
STM-16/OC-48 1550 nmBN 3035/90.53
STM-16/OC-48 1310 nmBN 3035/90.54
STM-16/OC-48 1310 and 1550 nmBN 3035/90.59
STM-64/OC-192 1550 nm Generator/AnalyzerBN 3035/91.40
STM-64/OC-192 1550 nm GeneratorBN 3035/91.41
STM-64/OC-192 1550 nm AnalyzerBN 3035/91.42
Optical power splitter (90/10%)BN 3035/90.49
Optical Attenuator (plug in)	
SC-PC, 1310 nm, 15 dBBN 3035/90.61

OC-12c/STM-4c Options

OC-12c/STM-4c Bit Error Tester	
(requires Optical Module BN 3035/90.46, 90.47 or 90.48)BN 3035/90.90
OC-12c/STM-4c ATM Testing	
(requires Optical Module BN 3035/90.46, 90.47 or 90.48 and	
ATM-Modul BN 3035/90.70)BN 3035/90.91
OC-12c/STM-4c Virtual Concatenation	
(requires Optical Module BN 3035/90.90 oder 90.91;	
the optiones BN 3035/90.38, 91.53, 91.54, 91.59 are alternatives)BN 3035/90.92
Optical STM-16/OC-48, 15... nm	
(Select a wavelength between 1530,33 nm and	
1560,61 nm to G.692.)BN 3035/90.38
OC-48c/STM-16c Bit Error Tester (Bulk)	
(requires Optical Module BN 3035/90.46, 90.47 or 90.48)BN 3035/90.93

Optical test adapters

ST Type (AT&T)BN 2060/00.32
HMS-10/A, HFS-13/A (Diamond)BN 2060/00.34
HMS-10, HFS-13 (Diamond)BN 2060/00.35
"KEYED BICONIC", with anti-twist device (AT&T)BN 2060/00.37
D4 (NEC)BN 2060/00.40
DIN 47256BN 2060/00.50
FC, FC-PC (NTT)BN 2060/00.51
SC, SC-PC (NTT)BN 2060/00.58
E 2000 (Diamond)BN 2060/00.61

Wavetek Wandel Goltermann can supply a wide selection of optical power level meters, sources, attenuators and accessories. Please ask your local sales office for information.

**O.172 Jitter and wander**

O.172 Jitter Generator up to 155 Mbit/s	BN 3035/90.81
O.172 Jitter Meter up to 155 Mbit/s	BN 3035/90.82
O.172 Jitter Generator 622 Mbit/s (requires BN 3035/90.81)	BN 3035/90.83
O.172 Jitter Meter 622 Mbit/s (requires BN 3035/90.82)	BN 3035/90.84
O.172 Wander Generator up to 622 Mbit/s (requires BN 3035/90.81 for up to 155 Mbit/s and 90.83 for 622 Mbit/s)	BN 3035/90.85
O.172 Wander Analysator up to 622 Mbit/s (requires BN 3035/90.82 for up to 155 Mbit/s and 90.84 for 622 Mbit/s)	BN 3035/90.86
O.172 Wander Generator 2488 Mbit/s (requires ANT-20E and BN 3035/90.81 and BN 3035/90.88)	BN 3035/90.87
O.172 Jitter Generator/Analysator 2488 Mbit/s (requires ANT-20E)	BN 3035/90.88
O.172 Wander Analysator 2488 Mbit/s (requires ANT-20E and BN 3035/90.88)	BN 3035/90.89
O.172 MTIE/TDEV Analysis (requires BN 3035/90.86 for up to 622 Mbit/s and BN 3035/90.89 for 2488 Mbit/s)	BN 3035/95.21

ATM functions

ATM module	
Includes ATM mapping STM-1/STS-3c	BN 3035/90.70
ATM Broadband Analyzer/Generator	BN 3035/90.80

Additional ATM-Mappings

requires ATM-Module 3035/90.70 or BN 3035/90.80

STS-1 (51 Mbit/s)	BN 3035/90.71
E4 (140 Mbit/s) ¹	BN 3035/90.72
DS3 (45 Mbit/s) ²	BN 3035/90.73
E3 (34 Mbit/s) ¹	BN 3035/90.74
E1 (2 Mbit/s) ¹	BN 3035/90.75
DS1 (1,5 Mbit/s) ²	BN 3035/90.76
VC-3 in STM-1 (AU-3/AU-4)	BN 3035/90.77

1 For SONET versions BN 3035/42, BN 3035/22 and BN 3038/12, option BN 3035/90.33 is required.

2 For SDH versions BN 3035/41, BN 3035/21 and BN 3038/11, option BN 3035/90.34 is required.

9.7.3 Remote control

V.24 remote control	BN 3035/91.01
GPIB remote control	BN 3035/92.10
LabWindows/CVI Driver	BN 3038/95.99



9.7.4 Remote operation

Remote operation via modem	BN 3035/95.30
Remote operation via LAN (TCP/IP)	BN 3035/95.31

9.7.5 Test automation

CATS Test Sequencer and test case library	BN 3035/95.90
---	---------------

9.7.6 Calibration

Calibration report	BN 3035/94.01
--------------------------	---------------

9.7.7 Accessories

Included with instrument

- Filter pads
- AC line cord
- 2 cables
- Operating manual

Optional accessories

Carry bag for ANT-20SE	BN 3035/92.02
External keyboard (US/English)	BN 3035/92.04
Decoupler, -20 dB, m-f 1.6/5.6	BN 3903/63
TKD-1 probe, 48 to 8500 kbit/s	BN 882/01
WG PenBERT Mini-PCM-Monitor (E1)	BN 4555/11

9.7.8 Retrofitting of options

All options can be retrofitted by the Wavetek Wandel Goltermann worldwide service network.



9.7.9 Note for ANT-20SE users

The following hardware and software bundles have been formed for the ANT-20SE.

Assignments of modules and software ANT-20SE – ANT-20/ANT-20E:

	Module / Software	BN number ANT-20SE	Equivalent BN number
ANT-20SE Mainframe	Mainframe, SDH	3060/01	3035/41 or 3035/21 + 3035/92.15 + 3035/93.11 + 3035/90.01
	Mainframe, SONET	3060/02	3035/42 or 3035/22 + 3035/92.15 + 3035/93.11 + 3035/90.10
	Extended SDH Testing	3060/90.01	3035/90.02, 3035/90.03, 3035/90.04, 3035/90.05, 3035/90.06, 3035/90.15
	Extended SONET Testing	3060/90.02	3035/90.11, 3035/90.12, 3035/90.13, 3035/90.03, 3035/90.15
	Add SONET (SONET expansion for SDH mainframe)	3060/90.03	3035/90.10, 3035/90.11, 3035/90.12, 3035/90.13, 3035/90.34
	Add SDH (SDH expansion for SONET mainframe)	3060/90.04	3035/90.01, 3035/90.02, 3035/90.04, 3035/90.05, 3035/90.06, 3035/90.33
	Drop&Insert (Through mode, Block&Replace)	3060/90.10	3035/90.20
	PDH MUX/DEMUX (64/140)	3060/90.11	3035/90.30
	M13 MUX/DEMUX	3060/90.12	3035/90.32
Optics STM-1/4, OC-1/3/12	STM-1, OC-1/3 1310 nm	3060/91.01	3035/90.43 + 2 Adapters
	STM-1, OC-1/3 1310 nm & 1550 nm	3060/91.02	3035/90.45 + 2 Adapters
	STM-1/4, OC-1/3/12 1310 nm	3060/91.11	3035/90.46 + 2 Adapters
	STM-1/4, OC-1/3/12 1310 nm & 1550 nm	3060/91.12	3035/90.48 + 2 Adapters
	Optical power splitter	3060/91.05	3035/90.49 + 3 Adapters
	OC-12c BULK	3060/90.90	3035/90.90
	OC-12c Virtual concatenation	3060/90.92	3035/90.92

Table S-26 Assignments of modules and software



	Module / Software	BN number ANT-20SE	Equivalent BN number
Optics STM-16, OC-48	STM-16, OC-48 1550 nm	3060/91.50	3035/91.53 + 2 Adapters
	STM-16, OC-48 1310 nm	3060/91.51	3035/91.54 + 2 Adapters
	STM-16, OC-48 1310 nm & 1550 nm	3060/91.52	3035/91.59 + 2 Adapters
	STM-16, OC-48 15... nm, special	3060/91.53	3035/90.38 + 2 Adapters
	OC-48c BULK	3060/90.93	3035/90.93
	Package: STM-0/1/4/16 1310 nm + Concatenation	3060/90.55	3035/90.46, 3035/91.54, 3035/90.90, 3035/90.93, + 4 Adapters
	Package: STM-0/1/4/16 1550 nm + Concatenation	3060/90.56	3035/90.47, 3035/91.53, 3035/90.90, 3035/90.93, + 4 Adapters
	Package: STM-0/1/4/16 1310 nm & 1550 nm + Concatenation	3060/90.57	3035/90.48, 3035/91.59, 3035/90.90, 3035/90.93, + 4 Adapters
Jitter O.172	Package: STM-0/1/4 1310 nm STM-16 1550 nm + Concatenation	3060/90.58	3035/90.46, 3035/91.53, 3035/90.90, 3035/90.93, + 4 Adapters
	Package: O.172 Jitter/Wander up to 155 Mbit/s	3060/91.30	3035/90.81, 3035/90.85, 3035/90.82, 3035/90.86
	Package: O.172 Jitter/Wander up to 622 Mbit/s	3060/91.31	3035/91.31
	Package: O.172 Jitter/Wander up to 2488 Mbit/s	3060/91.32	3035/91.32
	MTIE/TDEV Analysis Part of 3060/91.30 to 91.32	-	3035/95.21
ATM	ATM Basic	3060/90.50	3035/90.70
	ATM Comprehensive	3060/90.51	3035/91.80
	Add ATM SDH	3060/90.52	3035/90.72, 3035/90.74, 3035/90.75, 3035/90.77, 3035/90.33
	Add ATM SONET	3060/90.53	3035/90.71, 3035/90.73, 3035/90.76, 3035/90.34,
	OC-12c ATM Testing	3060/90.91	3035/90.91
Accessories	Remote control, V.24	3035/91.01	
	Remote control, GPIB	3035/92.10	
	Remote Operation Modem	3035/95.30	
	Remote Operation LAN/PCMCIA	3035/95.31	
	PDH/SDH NEXT Expert	3035/95.40	
	Test Sequencer	3035/95.90	
	LabWindows/CVI drivers	3035/95.99	
	Calibration report	3035/94.01	
	Transport case	3035/92.03	

Table S-26 Assignments of modules and software (continued)



Notes:



Index

Symbols

"43-44" sequence (double pointer) TB-4
 "F3" APPL O-7
 "86-4" sequence (pointer) TB-4
 "87-3" sequence (pointer) TB-3

Numerics

2-point cell delay variation A-74

A

AAL layer A-64
 AAL-0 A-65
 AAL-1 A-65
 Abbreviations SA-12
 AC line operation G-8
 AC line voltage G-1
 Action buttons O-33
 Add & Remove O-19, O-20
 ADM Test VI-5
 Air filter pad replacing M-4
 Alarm messages SA-9
 Allocation TB-20
 Allocation (Performance analysis) TB-13, TB-15,
 TB-24, TB-27
 Anomaly insertion VI-12
 Anomaly/Defect Analyzer A-17
 Anomaly/Defect Insertion A-17
 ANSI (Performance analysis) VI-41
 ANSI standards SA-4
 ANSI T1.101 A-56
 ANSI T1.105-1995 (SONET Multiplexing Structure)
 TB-1
 ANSI/BELL (Performance analysis) TB-6
 ANT-20/ANT-20E concept I-1
 Application Manager O-11, A-1
 Application menu O-15
 APS VI-10
 APS commands VI-25
 APS switching time measurement A-14
 Arranging windows O-32
 ATM Advanced O-12
 ATM Background Generator A-75
 ATM bit error test A-66
 ATM Forum recommendations SA-6
 ATM latency test A-71
 ATM layer A-64
 ATM Signal Structure A-63
 ATM Standard O-12

ATM Traffic Analyzer A-71
 ATM-BERT A-66
 Autoconfiguration VI-8, A-4
 Automatic Protection Switching A-14
 Automatic Scan function A-10
 Automatic Search function A-12
 Automatic Trouble Scan function A-7

B

Background load A-75
 Backup data O-42
 Bellcore standards SA-4
 BIS[P]O (Thresholds, M.2101, 6/2000) TB-31
 BIS[P]O (Thresholds, M.2101,1, 4/1997) TB-30
 BIS[P]O (Thresholds, performance analysis) TB-25
 BISO Multiplier TB-24, TB-27
 Bit error rate test (BERT) A-17

C

Calibration measurement (JTF) A-43, A-45
 Cancel button O-34
 CBR (constant bit rate) A-65
 CDV A-74
 Cell delay variation A-74
 Cell loss ratio A-81
 Cell Transfer Delay A-65
 Cell transfer delay A-72, A-74
 Channel VI-7, A-4
 Check boxes O-33
 Cleaning the instrument M-1
 Clock source VI-7
 CLOSE button O-34
 Close program button O-18
 CLR A-81
 CONCAT. VI-5
 Configure menu O-17
 Connector panel O-2, O-3
 Connectors O-3
 Consecutive Identical Digit (CID) Test A-61
 Control elements O-1, O-3
 Count (anomaly result) VI-17

D

DCC bit error test A-34
 Defect insertion VI-12
 Delay VI-9
 Descriptor A-31
 Descriptor (Overhead Generator) VI-25



Disabling entries O-14
DM Threshold (Performance analysis) TB-13
Double pointer TB-2

E

ECC bit error test A-34
Edit TCM Sequence VI-26
EN 302084 A-56
Enabling entries O-14
Entry boxes O-34
Error Free Seconds (Performance analysis)
TB-6 to TB-34
Error Related Performance A-65
Errored Seconds (Performance analysis)
TB-6 to TB-34
ETSI EN 302084 A-50, A-58
ETSI ETS 300462 A-56
ETSI standards SA-5
Export Format O-40

F

F3 O-7
F-MTJ (Fast MTJ) A-40
Front panel O-1
Function key "F3" APPL O-7
Fuse replacing M-3

G

G.811 A-53, A-56
G.812 A-53, A-56
G.813 A-53, A-56
G.821 A-22
G.821 (Performance analysis) VI-41
G.823 A-37, A-43, A-50, A-53, A-58
G.824 A-50, A-53, A-58
G.825 A-37, A-50, A-53, A-58
G.826 A-22
G.826 ISM (Performance analysis) VI-41
G.826 OOS (Performance analysis) VI-41
G.828 A-22
G.828 (Performance analysis) VI-41, TB-19
G.829 A-22
G.829 (Performance analysis) VI-41, TB-21
G.958 A-37, A-43
GR 253 A-23

H

Help menu O-17
Histogram (Anomaly/Defect Analyzer) VI-14
HUNC error A-67

I

I.356 A-74
Idle VI-3
Installing a printer O-36
Instruments menu O-16
Interface VI-7, A-4
Interpreter A-32
Interpreter (Overhead Analyzer) VI-28
ITU-T G.707 (SDH Multiplexing Structure) TB-1
ITU-T G.821 (Performance analysis) TB-12
ITU-T recommendations SA-1

J

Jitter amplitude A-40
Jitter frequency A-40, A-42
JTF (Jitter Transfer Function) A-43

K

Keyboard O-34

L

LED array O-5
Linear APS VI-28
List boxes O-33
Loading an application O-23
Loss of cell delineation (LCD) A-78

M

M.2100 A-22
M.2100 (Performance analysis) VI-41, TB-23
M.2101 A-22
M.2101 (Performance analysis) TB-26
M.2101-Version TB-28
Manually triggered measurements O-43
Maximize button O-18
Mean cell rate A-83
Measurement duration O-25, A-2
Measurement menu O-16
Measuring O-25
Minibar O-13
Minimize button O-18
Modulation period A-52
MTIE A-54, A-55
MTIE/TDEV Analysis A-56
MTJ (Maximum Tolerable Jitter) A-37
MTW (Maximum Tolerable Wander) A-58
Multiplexing structures TB-1
MUX Factor (Performance analysis) TB-13

**N**

NFD VI-33

O

O.172 A-37, A-43, A-50, A-53, A-58
 Offset VI-3
 OK button O-34
 On-line help O-31
 Optical power splitter A-6
 Option buttons O-33
 Overhead Analyzer A-29
 Overhead Generator VI-23, A-29

P

Packing G-6
 Path Overhead A-29
 PDH Generator/Analyzer VI-38, VI-40
 Peak cell rate A-83
 Peak-to-peak CDV A-74
 Performance Analysis A-22
 Performance analysis VI-41, TB-6
 Performance monitoring (SONET) TB-7
 Periodic pointer TB-2
 Phase hits A-47
 Physical layer O-12, A-63
 POH A-29
 Pointer action generation TB-2
 Pointer Analyzer VI-35, A-26
 Pointer burst VI-33, TB-3
 Pointer Generator VI-32, A-26
 Pointer sequence VI-33, A-25
 Pointer sequences parameter TB-5
 Pointer stress test A-25
 Print dialog O-38
 Print Header O-37, O-39
 Print menu – Application manager O-17, O-37
 Print menu – Virtual instruments O-38
 Printer Setup O-39

R

Ratio (anomaly result) VI-17
 Receiver section
 Specifications
 Reference clock input[25] (REF CLOCK IN)
 S-37
 Trigger input/output [26] S-37
 Recovery time G-7
 Remote operation RO-1

Repair instructions G-2
 Result display (Anomaly/Defect Analyzer) VI-14
 Ring APS VI-28

S

Safety class G-1
 Save as dialog O-40
 Saving an application O-23
 Selecting instruments O-19
 Sensor test A-78
 SEP used in Verdict TB-20, TB-28
 SES-Threshold (Performance analysis) TB-13,
 TB-20, TB-22
 Setting a new pointer TB-4
 Severely Errored Frame Seconds (Performance
 analysis) TB-6 to TB-34
 Severely Errored Seconds (Performance analysis)
 TB-6 to TB-34
 Signal input [12] S-7
 Signal input [14] S-5
 Signal output [13] S-3
 Signal output [15] S-2
 Signal Structure O-21, A-3
 SOH VI-23
 Standard sequence TB-3
 Start/stop measurement O-27
 Storage under damp conditions G-6

T

T1.231 A-23
 TCM Sequence VI-26
 TDEV (Time Deviation) A-56
 Testcell A-65
 Through mode VI-4, A-5
 TIE A-55
 TIM A-33
 Timer O-28
 Timer-controlled measurements O-44
 Title bar O-18
 TOH VI-23, A-29
 Trace Identifier VI-29
 Trace identifier A-31
 Trace Identifier Mismatch A-33
 Traffic signal icon O-27
 Transport Overhead A-29
 Trigger VI-3



U

UAS-Limit TB-20, TB-24, TB-27
UAS-Mode TB-20, TB-24, TB-27
Unavailable Seconds (Performance analysis)
TB-6 to TB-34
Unpacking G-6

V

VBR A-82
Ventilation G-7
Versacon inserts M-2
Virtual instruments O-12, A-1
VPI/VCI parameters A-72

W

Wander A-53, A-55
Wander analysis (MTIE/TDEV) A-55
Wander Generator A-50
Wander modulation period A-52