

R3261/3361 SERIES SPECTRUM ANALYZER

INSTRUCTION MANUAL

MANUAL NUMBER OEL00 9510Ⓐ

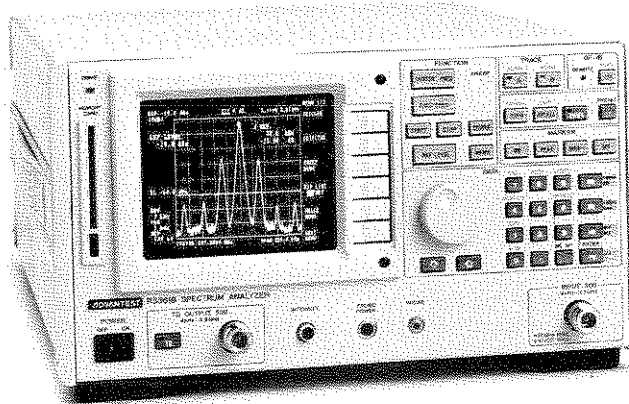

OPERATIONS

The product is a Strategic Commodity subject to
COCOM regulations.

It should not be exported without the proper
authorization from Japanese government.

ADVANTEST CORPORATION

Safety Summary

To ensure thorough understanding of all functions and to ensure efficient use of this equipment, please read the Instruction Manual carefully before using. Note that Advantest bears absolutely no responsibility for the result of operations caused due to incorrect or inappropriate use of this equipment.

Careful attention to personal safety should be paid when operating and servicing this equipment. Please be sure to always use this equipment correctly and safely.

■ Warning Labels

Warning labels such as shown below are applied to Advantest products in locations where specific dangers exist. Pay careful attention to these labels during handling. Do not remove or tear these labels. If you have any questions regarding warning labels, please ask your nearest Advantest dealer. Our address and phone number are listed at the end of this manual.

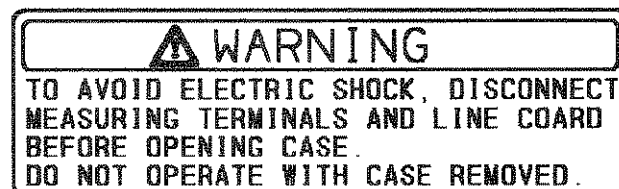
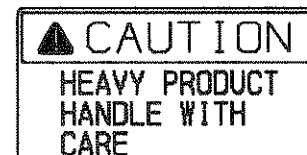
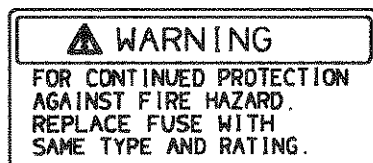
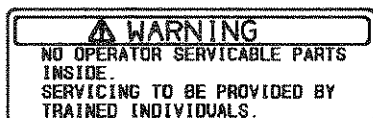

■ Basic Precautions

Please observe the following precautions to prevent fire, burn, electric shock, and personal injury.

- Use a power cable rated for the voltage in question. Be sure however to use a power cable conforming to safety standards of your nation when using a product overseas. Do not place anything heavy on top of the power cable.
- When inserting the plug into the electrical outlet, first turn the power switch OFF and then insert the plug as far as it will go.
- When removing the plug from the electrical outlet, first turn the power switch OFF and then pull it out by gripping the plug. Do not pull on the power cable itself. Make sure your hands are dry at this time.
- Before turning on the power, be sure to check that the supply voltage matches the voltage requirements of the equipment.
- Be sure to plug the power cable into an electrical outlet which has a safety ground terminal. Grounding will be defeated if you use an extension cord which does not include a safety ground terminal.
- Be sure to use fuses rated for the voltage in question.
- Do not use this equipment with the case open.
- Do not place any heavy objects on top of this equipment. Also, do not place flower pots or other containers containing liquid such as chemicals on top of or near this equipment.
- Do not stick or drop metal or easily flammable objects into the ventilation outlets of this equipment.
- In the case of products which emit laser light, do not look directly at the output connector edge or the connected fiber output edge.

■ Caution Symbols Used Within the Instruction Manual

Symbols indicating items requiring caution which are used in this instruction manual are shown below together with their meaning.

DANGER: Indicates an item where there is a danger of serious personal injury (death or serious injury)

WARNING: Indicates an item relating to personal safety or health

CAUTION: Indicates an item relating to possible damage to the product or equipment or relating to a restriction on operation

■ Safety Marks on the Product

The following safety marks can be found on Advantest products.



: Indicates that care in handling is required. A reference to the appropriate pages in the instruction manual is given to protect yourself and the product.



: Represents a ground symbol. This indicates field wiring terminals which must be grounded before using the equipment to prevent electric shock.



: Indicates dangerous high voltage. This is placed at locations where 1000 volts or more is input or output.



: Indicates a frame (or case) terminal. This is placed on terminals connected to the outside frame (or case) of the product.



: Indicates alternating current (current or voltage).



: Indicates direct current (current or voltage).



: Indicates alternating current (current or voltage) and direct current (current or voltage).

■ Precautions when Disposing of this Equipment

Be aware of the following harmful substances when disposing of this product and be sure they are disposed of properly. If you have questions on how to dispose of this product, please contact your nearest Advantest dealer. Our address and phone number are listed at the end of this manual.

- Harmful substances:**
- (1) PCB (polycarbon biphenyl)
 - (2) Mercury
 - (3) Ni-Cd (nickel cadmium)
 - (4) Other





Items possessing cyan, organic phosphorous and hexadic chromium and items which may leak cadmium or arsenic (excluding lead in solder).

■ Replacement Parts

Some parts used in this equipment are expected to wear out over time due to friction or other causes. Please replace these parts periodically to ensure a set level of performance. If you have questions about replacement parts, please ask your nearest Advantest dealer. Our address and phone number are listed at the end of this manual.

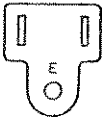
NOTICE

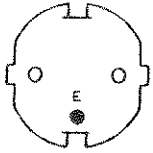
ADVANTEST provides the following power cables for each country.
If there was any inconvenience on your use, please contact our subsidiaries or ADVANTEST representatives.

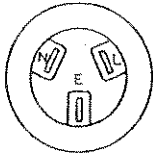
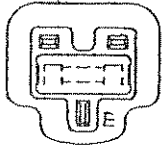
	Plugs	Standards/Countries	Ratings/Color/ Length	Accessory Codes
1		JIS : JAPAN	Rating :125V 7A Color :Black Length :2m	A01402 A01412
2		UL : USA CSA : CANADA	Rating :125V 7A Color :Black Length :2m	A01403 (Opt.95) A01413
3		CEE : EUROPE VDE : FRG OVE : AUSTRIA SEMKO : SWEDEN DEMKO : DENMARK KEMA : NETHERLANDS FIMKO : FINLAND NEMKO : NORWAY CEBEC : BELGIUM	Rating :250V 6A Color :Gray Length :2m	A01404 (Opt.96) A01414
4		SEV : SWITZERLAND	Rating :250V 6A Color :Gray Length :2m	A01405 (Opt.97) A01415
5		SAA : AUSTRALIA NEWZELAND	Rating :250V 6A Color :Gray Length :2m	A01406 (Opt.98)
6		BS : UK	Rating :250V 6A Color :Black Length :2m	A01407 (Opt.99) A01417

Note : "E" shows earth (ground).

R3261/3361
SPECTRUM ANALYZER
INSTRUCTION MANUAL

Preface

PREFACE

This manual covers operations of the R3261C, R3261CN, R3261D, R3361C, R3361CN, R3361D, R3361NK and R3361K.

The text of this manual uses the R3261D/3361D data, but the panel diagrams and screen drawings use the R3361C data.

In the following explanations, a panel key is enclosed by a solid line (e.g., **REF LEVEL**) and a softkey menu is enclosed by a dotted line (e.g., **XdB/DIV**) as required to prevent confusion of them.

When a softkey menu enclosed by a dotted line is followed by **[]**, this symbol indicates the softkey corresponding to this softkey menu.

This instruction manual consists of the following two parts.

- OPERATION
- PERFORMANCE TEST

TABLE OF CONTENTS

1. GENERAL
 2. PANELS
 3. BASIC OPERATIONS
 4. FUNCTIONS
 5. TRACKING GENERATOR FUNCTION
 6. EXAMPLES OF MEASUREMENTS
 7. GPIB : REMOTE PROGRAMMING
 8. CHECK
 9. R3361NK/3361K
 10. SPECIFICATIONS
 11. OPERATION DESCRIPTION
- APPENDIX

R3261/3361
SPECTRUM ANALYZER
INSTRUCTION MANUAL

How to Use This Manual

● How to Use This Manual

Information and notes necessary to use the R3261/3361 for Operating Manual safely are written. Read before the R3261/3361 is used.

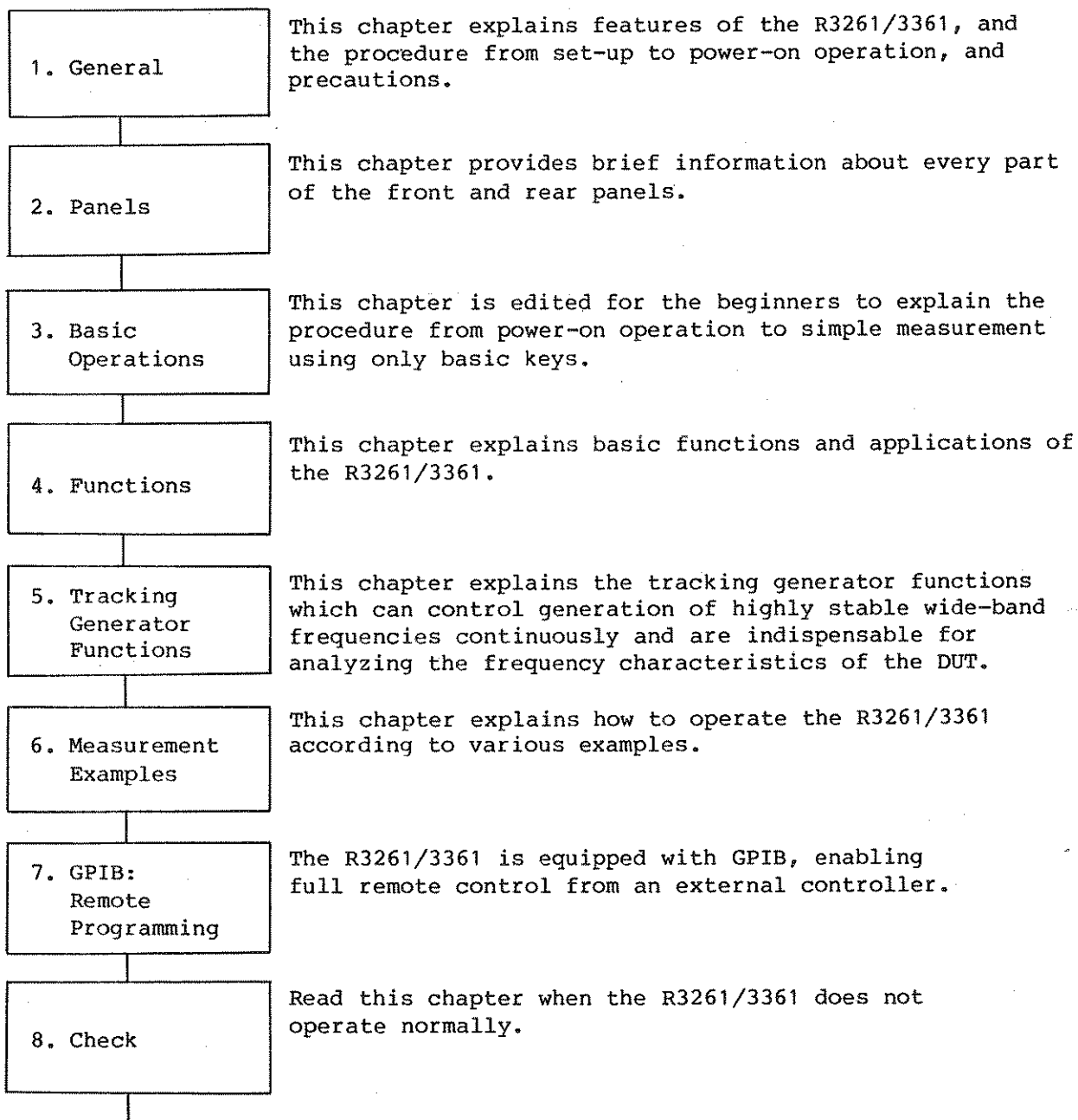

R3261/3361
SPECTRUM ANALYZER
INSTRUCTION MANUAL

How to Use This Manual

9. R3361NK/3361K	This chapter explains the R3361NK/3361K.
10. Specifications	This chapter explains specifications and accessories of the R3261/3361.
11. Operations	This chapter explains basic operations of the R3261/3361.
APPENDIX	The appendix lists softkey menus corresponding to panel keys and glossary.
INDEX	
EXTERNAL VIEW	The outside dimensional drawing, front panel drawing, and rear panel drawing are listed.

R3261/3361
SPECTRUM ANALYZER
INSTRUCTION MANUAL

Table of Contents

TABLE OF CONTENTS

1. GENERAL	
1.1 Overview	1 - 2
1.2 Before Using This Spectrum Analyzer	1 - 3
1.2.1 Checking Accessories	1 - 3
1.2.2 Environmental Conditions	1 - 4
1.2.3 Storage, Cleaning and Transport	1 - 5
1.2.4 Before Turning This Analyzer On	1 - 6
2. PANELS	
2.1 Front Panel	2 - 2
2.2 Rear Panel	2 - 5
3. BASIC OPERATIONS	
3.1 Turning This Analyzer On and Inputting Signals	3 - 2
3.2 Initialization	3 - 4
3.3 Keys for Basic Operations	3 - 6
3.4 Basic Operations	3 - 7
4. FUNCTIONS	
4.1 Functions of FUNCTION Section	4 - 2
4.1.1 Center Frequency	4 - 3
4.1.2 Frequency Span	4 - 6
4.1.3 Start and Stop Frequencies	4 - 9
4.1.4 Couple	4 - 13
4.1.5 Reference Level	4 - 18
4.1.6 Menu	4 - 23
4.2 TRACE Section Functions	4 - 32
4.3 MARKER Section Functions	4 - 38
4.3.1 Marker	4 - 38
4.3.2 Peak Search	4 - 44
4.3.3 Marker →	4 - 50
4.3.4 Multi-marker	4 - 52
4.4 Save and Recall Functions	4 - 77
4.4.1 Save Function	4 - 77
4.4.2 Recall Function	4 - 80
4.5 User-Defined Function	4 - 83
4.6 Calibration Function	4 - 86
4.7 Plot Output Function	4 - 89
4.8 Label Function	4 - 93
4.9 Memory Card Function	4 - 95
4.9.1 Specification of Memory Card	4 - 95
4.9.2 Names of Parts of Memory Card	4 - 96
4.9.3 Life of Back-up Battery	4 - 97
4.9.4 Replacing the Battery	4 - 98
4.9.5 Cautions on Memory Card	4 - 98
4.9.6 Method of Inserting and Removing Memory Card	4 - 99
4.9.7 Memory Card Function	4 - 100

R3261/3361
SPECTRUM ANALYZER
INSTRUCTION MANUAL

Table of Contents

4.10 Measuring Window	4 - 102
4.10.1 Window Setting	4 - 102
4.10.2 Window Measurement	4 - 106
4.11 Tracking Generator Function (R3361C/CN/D only)	4 - 109
4.12 EMC Function	4 - 111
4.12.1 Panel Keys and the Corresponding Softkey Menu	4 - 111
4.12.2 Antenna Correction Function	4 - 111
4.12.3 QP Measurement	4 - 113
4.12.4 Limit Line Function	4 - 116
4.13 Occupied Bandwidth Measurement (OBW) and Adjacent Channel Leakage Power Measurement (ADJ)	4 - 120
4.13.1 Occupied Bandwidth Measurement (OBW)	4 - 120
4.13.2 Adjust Channel Leakage Power Measurement (ADJ)	4 - 122
4.13.3 GPIB Remote Programming	4 - 126
4.14 Printer Interface	4 - 130
4.15 Option 80	4 - 135
4.15.1 RS-232 Inerface	4 - 135
4.15.2 Gated Sweep Function	4 - 136
4.16 Option 81	4 - 137
4.16.1 Internal controller	4 - 137
4.16.2 Gated Sweep Function	4 - 143
 5. TRACKING GENERATOR FUNCTION	 5 - 2
5.1 How to Use Tracking Generator	5 - 2
5.2 How to Correct Frequency Characteristics Using Display Line	5 - 4
5.3 Examples of Measurements	5 - 7
5.4 Notes on Handling	5 - 13
5.4.1 Dynamic Range	5 - 13
5.4.2 Time Response	5 - 14
5.4.3 Precautions on Using Low Output Level	5 - 14
5.4.4 Limit Voltage Value Applying to the TG OUTPUT Connector	5 - 15
5.4.5 Measurement of low frequency number area	5 - 15
 6. EXAMPLES OF MEASUREMENTS	 6 - 3
6.1 Example of Measuring the Deviation: Example of Deviation Analysis of the 200MHz Band Transmitter	6 - 3
6.2 Measurement of Modulation Frequency and Modulation Index of AM Signal	6 - 5
6.2.1 Example of Measuring when the Modulation Frequency of AM Wave is Low and the Modulation Index is Large	6 - 6
6.2.2 Measuring Example of AM Wave when the Modulated Frequency is High and the Modulation Index is Small	6 - 7
6.3 Measurement of FM Wave	6 - 9
6.3.1 Example of Measuring FM Wave with Low Modulated Frequency	6 - 10
6.3.2 Example of Measuring the FM Wave with a High Modulated Frequency and a Small "m"	6 - 11
6.3.3 Measurement Example of FM Wave Frequency Deviation (Δf peak)	6 - 11
6.3.4 Obtaining Small FM Modulation Exponent m	6 - 13

R3261/3361
SPECTRUM ANALYZER
INSTRUCTION MANUAL

Table of Contents

6.4 Measurement of Pulse Modulation Wave	6 - 14
6.5 Noise Level Measurement	6 - 16
6.5.1 Measurement Example of Noise Level Absolute Value (dBm/Hz, dBμV/ Hz)	6 - 16
7. GPIB : REMOTE PROGRAMMING	
7.1 Outline	7 - 2
7.2 GPIB Standards & Main Unit GPIB Specifications	7 - 4
7.3 List of GPIB Codes	7 - 8
7.4 Introduction	7 - 21
7.4.1 GPIB Address Setting	7 - 21
7.4.2 Delimiters	7 - 21
7.4.3 Input/Output Format	7 - 21
7.5 Input Format (Listener)	7 - 22
7.6 Output Format (Talker)	7 - 25
7.7 Input and Output of Trace Data	7 - 28
7.8 Service Request (SRQ)	7 - 31
8. CHECK	
8.1 Check and Brief Diagnosis	8 - 2
8.2 Defects and Abnormal Stresses	8 - 3
9. R3361NK/3361K	9 - 1
9.1 Overview	9 - 2
9.1.1 Features of R3361NK/3361K	9 - 2
9.1.2 Checking Accessories	9 - 2
9.2 Front Panel	9 - 3
9.3 Audio Monitor Function	9 - 4
9.3.1 Using Audio Monitor Function	9 - 4
9.3.2 Using User Define Function	9 - 5
9.4 Channel Setup Function	9 - 6
9.4.1 Description of the Function	9 - 6
9.4.2 Feature of the Channel of the Each Country	9 - 6
9.4.3 Operation	9 - 6
9.4.4 List of Softkey Menu of the CH Key	9 - 13
9.4.5 GPIB Command	9 - 14
9.5 Auto Function	9 - 17
10. SPECIFICATIONS	
10.1 R3261C Specifications	10 - 2
10.2 R3261CN Specifications	10 - 7
10.3 R3261D Specifications	10 - 12
10.4 R3361C Specifications	10 - 17
10.5 R3361CN Specifications	10 - 22
10.6 R3361D Specifications	10 - 27
10.7 R3361NK Specifications	10 - 32
10.8 R3361K Specifications	10 - 37
10.9 Options and Accessories	10 - 42
11. OPERATION DESCRIPTION	
11.1 Description of Operations	11 - 2
11.2 Block Diagram	11 - 4

R3261/3361
SPECTRUM ANALYZER
INSTRUCTION MANUAL

Table of Contents

APPENDIX

A.1 List of Softkey Menus for Panel Keys	A - 2
(1) Center Frequency	A - 3
(2) Frequency Span	A - 3
(3) Start Frequency	A - 3
(4) Stop Frequency	A - 4
(5) Couple	A - 4
(6) Reference Level	A - 5
(7) Menu	A - 6
(8) A or B	A - 7
(9) GPIB Address	A - 7
(10) Save	A - 8
(11) Recall	A - 8
(12) User Define	A - 8
(13) Marker on	A - 9
(14) Peak Search	A - 10
(15) Marker	A - 10
(16) Multi-marker	A - 11
(17) Calibration	A - 12
(18) Plot	A - 13
(19) Label	A - 13
(20) Memory Card	A - 14
(21) Tracking Generator	A - 14
(22) EMC	A - 15
(23) MEAS WINDOW	A - 17
(24) FUNCTION	A - 18
A.2 Glossary	A - 19
A.3 Level Conversion Table	A - 27

EXTERNAL VIEW

● R3261C EXTERNAL VIEW	EXT1
R3261CN EXTERNAL VIEW	EXT2
R3261D EXTERNAL VIEW	EXT3
R3361C EXTERNAL VIEW	EXT4
R3361CN EXTERNAL VIEW	EXT5
R3361D EXTERNAL VIEW	EXT6
R3361K EXTERNAL VIEW	EXT7
R3361NK EXTERNAL VIEW	EXT8
● R3261C FRONT VIEW	EXT9
R3261CN FRONT VIEW	EXT10
R3261D FRONT VIEW	EXT11
R3361C FRONT VIEW	EXT12
R3361CN FRONT VIEW	EXT13
R3361D FRONT VIEW	EXT14
R3361K FRONT VIEW	EXT15
R3361NK FRONT VIEW	EXT16
● R3261/3361 SERIES REAR VIEW (Standard)	EXT17
R3261/3361 SERIES REAR VIEW (When option is installed)	EXT18

R3261/3361
SPECTRUM ANALYZER
INSTRUCTION MANUAL

1. General

1. GENERAL

R3261/3361
SPECTRUM ANALYZER
INSTRUCTION MANUAL

1.1 Overview

1.1 Overview

The R3261/3361 spectrum analyzer, which employs a synthesized local oscillator for assuring highly stable spectrum analyzer, features wide frequency range from 9kHz to 2.6GHz (R3261C/CN, R3361C/CN R3361NK/K), 9kHz to 3.6GHz (R3261D, R3361D), wide input range from -130dBm to +25dBm (R3261C/D, R3361C/D R3361NK/K), -19dBu to +132dBu (R3261CN, R3361CN), wide measurement display range of 115dB and high resolution of 30Hz, low residual FM of 20Hz_{p-p}, less noise sideband of -105dBc/Hz (20kHz output from carrier) as well as full remote-control GPIB, and the memory card function for saving/recalling data and panel settings. The R3361C/CN/D contains a tracking generator that facilitates frequency characteristic measurement.

Features

- ① This analyzer permits sweeping over a wide frequency range from 9kHz to 3.6GHz (R3261D, R3361D).
- ② A maximum frequency resolution of 30Hz enables analysis of adjacent signals and spurious response.
- ③ High-precision frequency measurement
A reference crystal oscillator with an aging rate of 2×10^{-8} /day is mounted to measure very weak signals (which cannot be measured by any counter) at a resolution of 1Hz in the counter mode.
- ④ Use of a memory card permits saving/recalling of panel settings.
- ⑤ The field strength can be viewed and read directly after compensating the antenna calibration coefficient and that the QP value based on the CISPR standard can be observed directly.
- ⑥ Various enhanced functions supported by digital indications
Whole information needed for spectrum analysis is displayed on the CRT together with signal traces. The digital memory screen realizes flickerless display. Various marker functions assures accurate and easy reading even in the manual mode.
- ⑦ Two channels of completely independent digital memories enable simultaneous display of two screens.
- ⑧ A full-remote-control GPIB is used as a powerful system component.
- ⑨ The built-in tracking generator of the R3361C/CN/D enables direct viewing of frequency attenuation of 115dB or more.
- ⑩ The R3261/3361 suits safety Class I of the IEC Publication 348 (safety Publication of the electronic measurement instrument).
- ⑪ R3361NK/3361K allows easy measurement concerning CATV.
(Refer to Chapter 9.)

R3261/3361
SPECTRUM ANALYZER
INSTRUCTION MANUAL

1.2 Before Using This Spectrum Analyzer

1.2 Before Using This Spectrum Analyzer

1.2.1 Checking Accessories

Upon receipt of the R3261/3361, run checks thereon as shown below.

- ① Run visual checks against any and all damages or imperfections.
- ② Check the quantity and rating of standard accessories to assure their conformance with Table 1 - 1.

Should there be any flaw, or damage, or missing or insufficient part, contact dealer or the sales and support offices.

Table 1 - 1 Standard Accessories

Accessory name	Standard		Quantity				Remarks
	Model name	Stock No.	R3261C/D	R3361C/D	R3261CN	R3361CN	
Power cable	A01402	DCB-DD2428X01	1	1	1	1	
Input cable	MI-02	DCB-FF0386	1	2	/	/	
	D3S015(Black)	DCB-FF2987X01	/	/	1	2	
N-BNC conversion adapter	JUG-201A/V	JCF-AF001EX03	1	2	/	/	
	BA-A165	JCF-AF001EX04	/	/	1	2	
Power fuse	TMF51NR5(250)	DFN-AA5A	2	2	2	2	
Memory card	—	SEE-MAC1101BAB	1	1	1	1	
Instruction manual	—	JR3261/3361					Japanese Version
	—	ER3261/3361	1	1	1	1	English Version

Note:When ordering an accessory, let us know its type (or stock No.).

R3261/3361
SPECTRUM ANALYZER
INSTRUCTION MANUAL

1.2 Before Using This Spectrum Analyzer

1.2.2 Environmental Conditions

- (1) Do not use the R3261/3361 in a place exposed to direct sunlight or corrosive gas. Do not use this unit in a place exposed to dust or vibration. The ambient temperature must be 0 to 50°C and the relative humidity must be 85% or less. The R3261/3361 is designed for indoor use. Safety can be kept for -10°C or more in the temperature.
- (2) A cooling fan is provided on the back panel of this unit to prevent abnormal temperature rises in it. Since this fan blows air outside, give attention to the ventilation around the R3261/3361. Place this unit within 10cm from the rear wall. Do not place any obstruction close to the rear panel of the R3261/3361.
- (3) The R3261/3361 is designed with the effect of AC power supply line noise taken into consideration. However, it is recommended that it be used in a place where there is minimum noise. If the noise is unavoidable, use a noise suppresser or the equivalent.

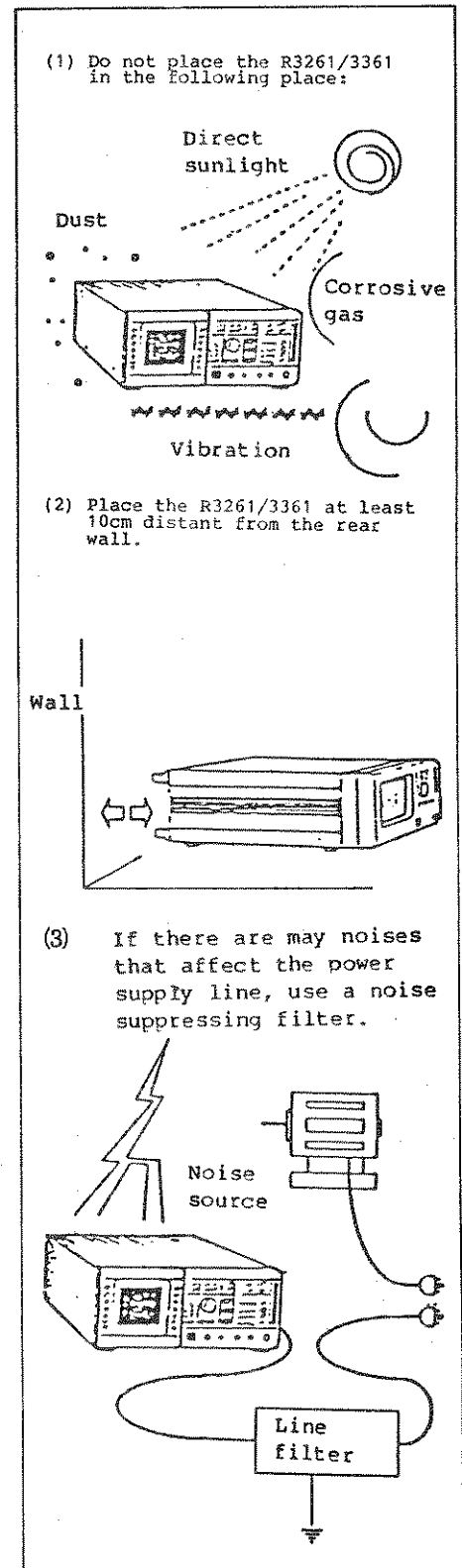

Figure 1 - 1 Environmental Conditions

R3261/3361
SPECTRUM ANALYZER
INSTRUCTION MANUAL

1.2 Before Using This Spectrum Analyzer

1.2.3 Storage, Cleaning and Transport

(1) Storage

The R3261/3361 must be stored at temperatures from -20°C to $+60^{\circ}\text{C}$. If the system will not be used for a long time, wrap it in a vinyl sheet or put it in a carton box, and store it in a dry place away from direct sunlight.

(2) Cleaning

The protect filter of the CRT display unit must be cleaned periodically with a soft cloth soaked with alcohol. Use alcohol only.

Usually, cleaning the surface is sufficient. If the inside of the filter or the CRT display unit itself is soiled, follow the steps below to remove the bezel and clean as above.

CAUTION

Do not use solvents such as benzene, toluene, acetone, and other organic solvents that can affect plastic.

(3) Transport

Pack the R3261/3361 in the original or similar packing materials for transport. If the original packing materials have been lost, wrap up the main unit in padding and put it in a carton box with sides at least 5mm thick. Put in the accessories, cover these with more cushioning materials, secure the box, and bind the package with a packaging strap.

R3261/3361
SPECTRUM ANALYZER
INSTRUCTION MANUAL

1.2 Before Using This Spectrum Analyzer

1.2.4 Before Turning This Analyzer on

WARNING

1. Before any other connection is made, make sure the R3261/3361 has been properly grounded through the protective conductor of the AC power cable to a socket outlet provided with protective earth contact. Any interruption of the protective (grounding) conductor, inside or outside the R3261/3361, or disconnection of the protective earth terminal can result in personal injury.
2. Before turning R3261/3361 on, make sure that it is set to the voltage of the power supply (Refer to Table 1-2.).
3. If the fuse rating is not as specified, the R3261/3361 may be broken.

(1) Power Requirement

Table 1 - 2 lists power supply conditions.

Table 1 - 2 Power Supply Conditions

Power	Condition
Input voltage	90 to 132V or 198 to 250V rms
Frequency	48 to 66Hz
Power consumption	220VAC or less

R3261/3361
SPECTRUM ANALYZER
INSTRUCTION MANUAL

1.2 Before Using This Spectrum Analyzer

(2) Checking a Fuse

The AC line fuse rating is T5A/250V whether the input voltage is 90 to 132V or 198 to 250V.

The T5A/250V fuse is contained in the power supply connector on the rear panel. Check it.

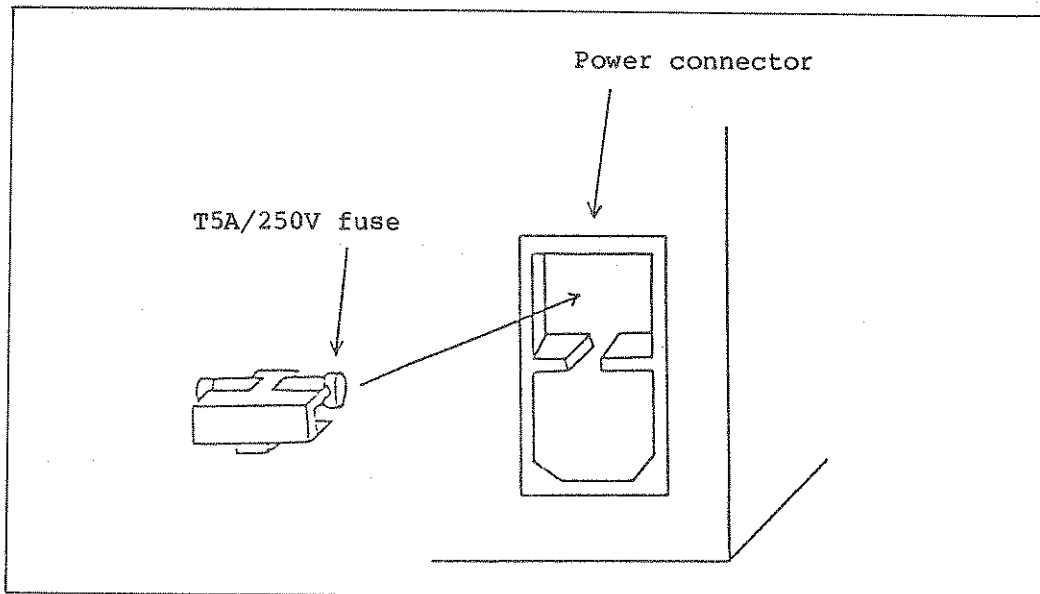

Figure 1 - 2 Checking a Fuse

R3261/3361
SPECTRUM ANALYZER
INSTRUCTION MANUAL

1.2 Before Using This Spectrum Analyzer

(3) Checking the Power Cable

The power cable plug has three pins. The round pin is used for grounding.

When using the R3261/3361, defend the following.

- Connect power plug with the outlet prepared the protective earth terminal.
- Do not use the extension cable without a protective conductor.

WARNING

Any interruption of the protective conductor inside or outside the R3261/3361 or disconnection of the protective earth terminal is likely to make the instrument dangerous. Intentional interruption is prohibited.

CAUTION

Power is supplied to the R3261/3361 when the power cable is connected to the power connector; even if the power switch is turned off. Disconnect the power cable to shut off the power.

R3261/3361
SPECTRUM ANALYZER
INSTRUCTION MANUAL

2. Panels

2. PANELS

2.1 Front Panel

This section explains the front panel components ① to ⑳ in the ascending order. See Figure 2 - 1.

Explanation of Each Component:

- ① POWER switch : Supplies or cuts power.
- ② DRIVE lamp : Goes on when the memory card operates.
- ③ Memory card insertion slot
- ④ EJECT button : Ejects the memory card.
- ⑤ TG key : Turns on/off the tracking generator.
- ⑥ TG OUTPUT connector : An N-type output connector of the tracking generator.
- ⑦ INTENSITY control : Controls intensity.
- ⑧ PROBE POWER : A probe power connector. (Power supply to an accessory such as active probe.)

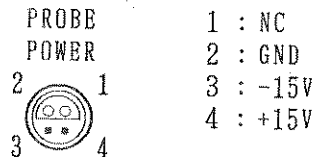

Note: Set the output current below $\pm 80\text{mA}$.

- ⑨ PHONE jack : An 8Ω phone jack.
- ⑩ INPUT connector : An N-type input connector.
- ⑪ CRT display : Displays waveforms and measured data.
- ⑫ Softkey menu display section : Displays up to six items.
- ⑬ Softkeys : There are six softkeys which correspond to the left-hand softkey menu.

R3261/3361
SPECTRUM ANALYZER
INSTRUCTION MANUAL

2.1 Front Panel

FUNCTION Section

- ⑭ CENTER FREQUENCY key : Selects a center frequency input mode.
- ⑮ FREQUENCY SPAN key : Selects a frequency span input mode.
- ⑯ START key : Selects a sweep start frequency input mode.
- ⑰ STOP key : Selects a sweep end frequency input mode.
- ⑱ COUPLE key : Sets a resolution band width, video band width, sweep time, or input attenuator.
- ⑲ REFERENCE LEVEL key : Selects a reference level input mode.
- ⑳ MENU key : Selects a trigger, detector, sweep, display line, or tracing.
- ㉑ SWEEP lamp : Goes on during sweeping.

TRACE Section

- ⑳ A-key
 - ㉑ B-key
- } Controls the trace memory.

GPIB Section

- ⑳ LCL key : Cancel external control.
- ㉑ REMOTE lamp : Goes on only when this analyzer is controlled by an external unit.
- ㉒ USER key : Assigned a function by the user.
DEFINE key : Used when the user defines a function.
- ㉓ RECALL key : Used to call a saved setting condition.
SAVE key : Used to save the current set conditions.
- ㉔ SHIFT key : Selects a shift mode (key expansion function).
(The LED goes on when this mode is selected.)
- ㉕ PRESENT key : Restores the initial state.

R3261/3361
SPECTRUM ANALYZER
INSTRUCTION MANUAL

2.1 Front Panel

MARKER Section

- ③① ON key : Displays a marker for direct reading of every part of the displayed waveform.
- ③② PEAK key : Moves the marker to the highest level (peak) on the screen.
- ③③ MKR → key : Selects a marker point operation.
- ③④ OFF key : Clears the marker.

DATA Section

- ③⑤ Data knob : Adjusts data input finely.
- ③⑥ Step key : Inputs data step by step.
- ③⑦ Ten key : Consists of numeric keys (0 to 9) and decimal point key.
- ③⑧ Back space key : Used to correct a digit input by a numeric key.
- ③⑨ Unit key : Selects a unit and enters the set value.

R3261/3361
SPECTRUM ANALYZER
INSTRUCTION MANUAL

2.2 Rear Panel

2.2 Rear Panel

This section explains the rear panel components ① to ⑳ in the ascending order. See Figure 2 - 2.

Explanation of Each Component:

- ① SERIAL I/O (Option)
- ② GPIB connector : Used to connect an external controller or connector with a GPIB cable.
- ③ Controller output terminal (Option)
- ④ Terminal for ouputting write waveform to X-Y recorder
: X.OUT : Approx. -5V to +5V
Output impedance : Approx. 10k Ω
- ⑤ Terminal for ouputting write waveform to X-Y recorder
: Y.OUT : Approx. 0 to 4V
Output impedance : Approx. 220 Ω
- ⑥ Terminal to external CRT display, video plotter, etc.
: Includes output impedance of approx. 75 Ω ,
1Vp-p, and composite signal.
- ⑦ 2V/nGHz output terminal
: Outputs 2V per 1GHz tuning frequency.
- ⑧ Gated sweep control terminal
: Stops sweeping and measurement at the low TTL
level or performs sweeping and measurement at
the high TTL level.
- ⑨ External trigger : Triggers at the leading edge.
- ⑩ Reference frequency signal input/output terminal
: Output : Approx. -5dBm
Input : Approx. 0dBm min.
- ⑪ Input/output selector switch
: Selects input or output of a reference frequency
signal.
- ⑫ IF monitor output terminal (option)
: An IF output for supplying a 226MHz frequency.
- ⑬ PARALLEL I/O (Option)

Note: Not provided for R3551.

- ⑭ VIDEO Output (Option)

R3261/3361
SPECTRUM ANALYZER
INSTRUCTION MANUAL

2.2 Rear Panel

- ⑮ ————— CAUTION —————
- For continued protection against fire hazard, replace a fuse with the same type and rating.
- ⑯ Indication of installed options
- ⑰ ————— CAUTION —————
- Inside entry by trained service personnel only.
- ⑱ Cooling fan : A cooling fan that blows air out.
- ⑲ Connector for AC power : An connector having three pins. The lower central pin is used for grounding. To remove the power fuse, remove the upper lid.
- ⑳ ————— Japan Only —————
- Ground terminal : Used to connect the unit frame to the ground when neither 3-pin nor 2-pin power cable connector cannot be used.

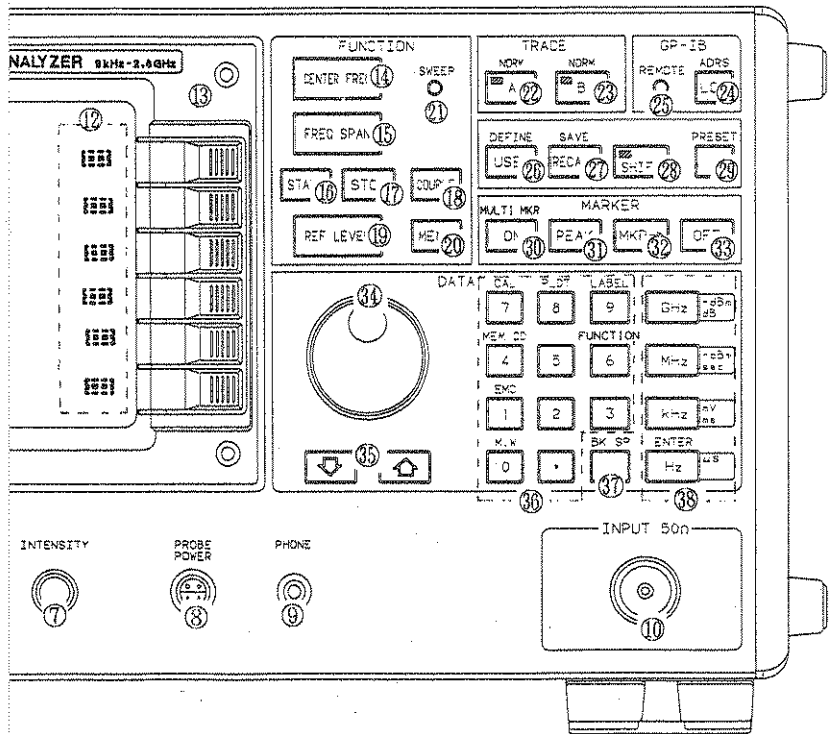

Figure 2 - 1 Front Panel

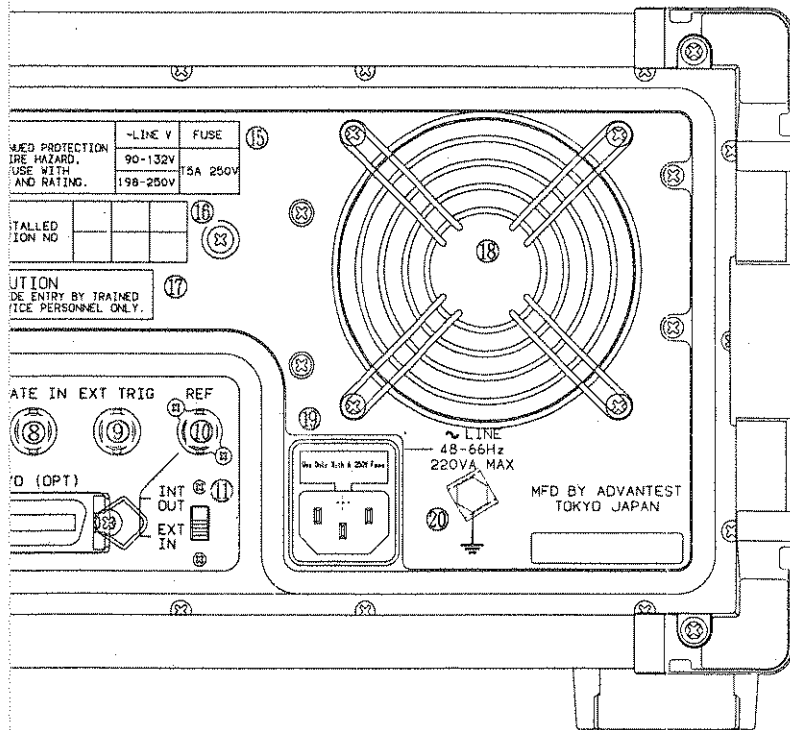

Figure 2 - 2 Rear Panel

R3261/3361
SPECTRUM ANALYZER
INSTRUCTION MANUAL

3. Basic Operations

3. BASIC OPERATIONS

R3261/3361
SPECTRUM ANALYZER
INSTRUCTION MANUAL

3.1 Turning This Analyzer on and Inputting Signals

(1) Power-On Operation Warm-Up

Set the POWER switch to ON.

Warm the R3261/3361 up for about 30 minutes to attain the designed performance.

(2) Input

The N-type connector is used for signal input. When inputting signals through the BNC connector, use an attached N-BNC conversion adapter. Take care not to break fine connector pins. The maximum input level is +25dBm (R3261C/D, R3361C/D), +132dBμ (R3261CN, R3361CN) and the AC couple is ±50Vdc when the input attenuation level is 30dB or more.

The input impedance is about 50Ω (R3261C/D, R3361C/D), about +75Ω (R3261CN, R3361CN). When input impedance must be matched, insert a suitable matching circuit.

R3261/3361
SPECTRUM ANALYZER
INSTRUCTION MANUAL

3.2 Initialization

3.2 Initialization

(1) Initialization

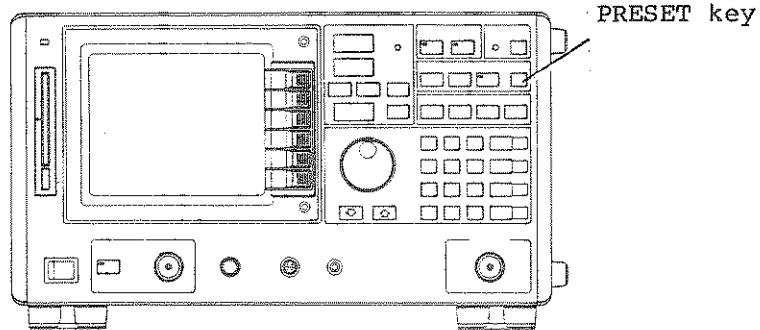

The measuring parameters of the R3261/3361 have been set to the initial status as follows:

Table 3 - 1 Initial Settings (Parameters)

Measurement parameter	Initial value	
	R3261C/D, R3361C/D	R3261CN, R3361CN
Center frequency	1.8GHz (1.3GHz)	1.3GHz
Frequency span	3600MHz (2600MHz)	2600MHz
Reference level	0dBm	110dBμV
Sweep time	AUTO (50ms)	AUTO (50ms)
Resolution band width	AUTO (1MHz)	AUTO (1MHz)
Video band width	AUTO (1MHz)	AUTO (1MHz)
Step size	AUTO	AUTO
Input attenuator	AUTO (10dB)	AUTO (10dB)
Trigger mode	FREE RUN	FREE RUN
Trace mode	A WRITE	A WRITE
Detection mode	Normal mode	Normal mode
Marker	OFF	OFF
Display line	OFF	OFF
Label function	OFF	OFF
Vertical calibration	10dB/div.	10dB/div

R3261/3361
SPECTRUM ANALYZER
INSTRUCTION MANUAL

3.2 Initialization

To initialize the measuring parameters, press the PRESET key.
When the R3261/3361 power switch is turned off, the last setting status of the instrument is kept in memory.
When the power switch is turned on again, the R3261/3361 is set to the same status.

R3261/3361
SPECTRUM ANALYZER
INSTRUCTION MANUAL

3.3 Keys for Basic Operations

3.3 Keys for Basic Operations

This section explains only basic keys for the users who have no experience in using this kind of analyzer. If you used to operate such an analyzer, you may skip this section.

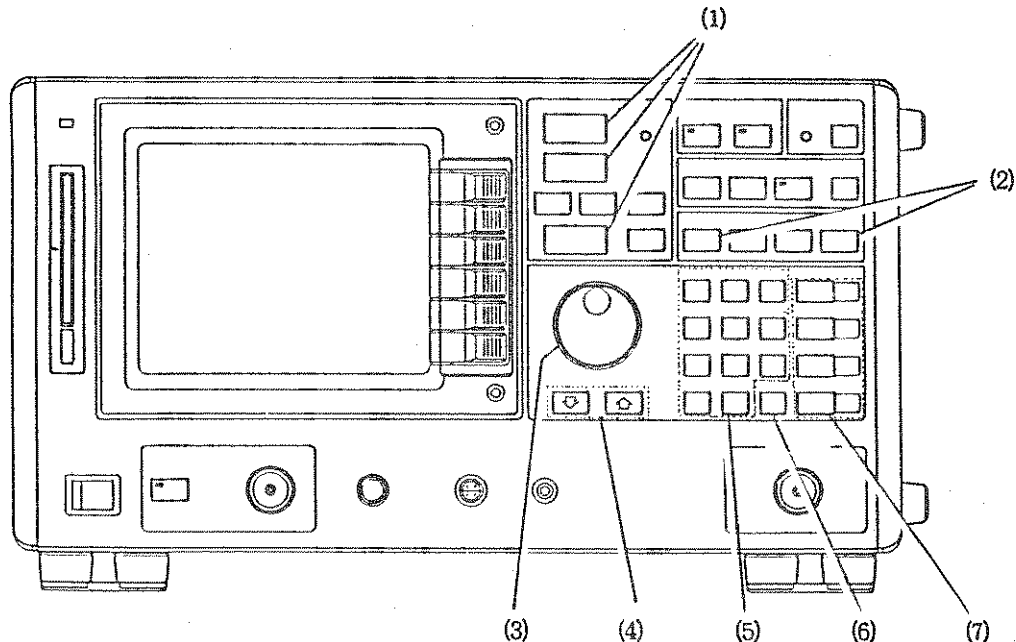

(1) Keys for Basic Settings

CENTER FREQ key: Use this key to select a center frequency input mode.

FREQ SPAN key : Use this key to select a frequency span input mode.

REF LEVEL key : Use this to select a reference level input mode.

(2) Marker

ON key } : Use this key to display or clear the marker for
OFF key } : direct reading of every part of waveform data.

(3) Data knob : Use this key for fine adjustment of data input.

(4) Step key : Use this key to input data step by step.

(5) Numeric keys : Use these keys to input digits and decimal points.

(6) Back space key : Use this key to correct digits input with the numeric keys.

(7) Unit key : Use this key to set the unit and enter the setting.

R3261/3361
SPECTRUM ANALYZER
INSTRUCTION MANUAL

3.4 Basic Operations

3.4 Basic Operations

The R3261/3361 can measure both the signal frequency and level. The following gives an example to explain the basic procedure to measure the 200MHz signal frequency and level.

(1) Inputting a Signal to be Measured

Set the POWER switch to ON and input the signal to be measured. For example, input a 200MHz signal (10dBm) to the INPUT terminal of the R3261/3361 using connection cable MI-02 and conversion adapter N-BNC.

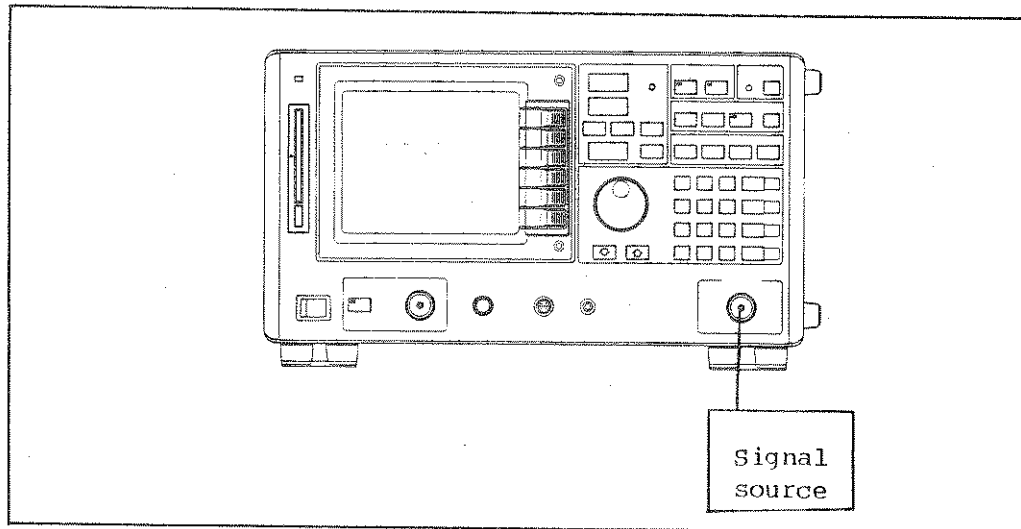

Figure 3 - 2 Inputting a Signal to be Measured

R3261/3361
SPECTRUM ANALYZER
INSTRUCTION MANUAL

3.4 Basic Operations

(2) Reading the Frequency and Level of the Signal to be Measured 1

(2-1) Set the center frequency to 200MHz.

- ① Press **CENTER FREQ**. "CENTER" is displayed at the upper left corner of the screen.
- ② Press **2 0 0 MHz**.
Thus, the center frequency is set to 200MHz and the signal subject to measurement moves to the center of the screen. (In this case, the frequency span becomes 800MHz.)

The center frequency may be set with the data knob or step key instead of the ten keys.

Data knob: Turning this knob clockwise will move the waveform to the left; that is, the center frequency is raised.

Step key : Pressing this key once will raise or lower the center frequency initially set on the horizontal axis.

(2-2) Change the very wide frequency span of 3600MHz (initial value) to 100MHz.

- ① Press **FREQ SPAN**.
"SPAN ..Hz" is displayed at the upper left corner of the screen.
- ② Press **1 0 0 MHz**. Thus, the horizontal scale will be 100MHz and 1 div. will be reduced by 1/10 (10MHz).

The frequency span is displayed at the lower right corner of the screen.

- ③ If the signal waveforms shift from the center of the screen, press **CENTER FREQ** and turn the data knob (for fine adjustment) to move the waveform to the center.

When a frequency span is changed, the 200MHz signal waveform displayed at the center of the screen may be shifted because the set resolution values differ between frequency spans.

If the frequency is known, just enter it by pressing the ten keys. In this case, the spectrum does not deviate from the center of the screen at the time of frequency span setting.

R3261/3361
SPECTRUM ANALYZER
INSTRUCTION MANUAL

3.4 Basic Operations

(2-3) Set the 200MHz signal to REFERENCE LEVEL (reference level: top level on the screen scale) to measure the level.

- ① The initial reference level is 0dBm. Change it to -10dBm and set the calibration signal to the reference level.

Press . "REF LEVEL xx dBm" is displayed at the upper left corner of the screen.

Press (-dBu). Thus, the reference level change to -10dBm.

Step keys may be used instead of the above keys.

- ② If the calibration signal cannot be set to the reference level, the level indication must be changed, that is, calibration is required.

(3) Reading the Frequency and Level of the Signal to be Measured 2

If a marker (bright spot) is used, a center frequency and reference level can be displayed as marker frequency and marker level directly.

- ① To display a marker, press .
- ② Using the data knob and step keys, move the marker to the peak of the signal.

The marker frequency and its level are displayed in the upper right part of the screen, allowing direct reading of signal frequency and level.

- ③ To clear the marker, press .

R3261/3361
SPECTRUM ANALYZER
INSTRUCTION MANUAL

4. Functions

4. FUNCTIONS

R3261/3361
SPECTRUM ANALYZER
INSTRUCTION MANUAL

4.1 Functions of FUNCTION Section

4.1 Functions of FUNCTION Section

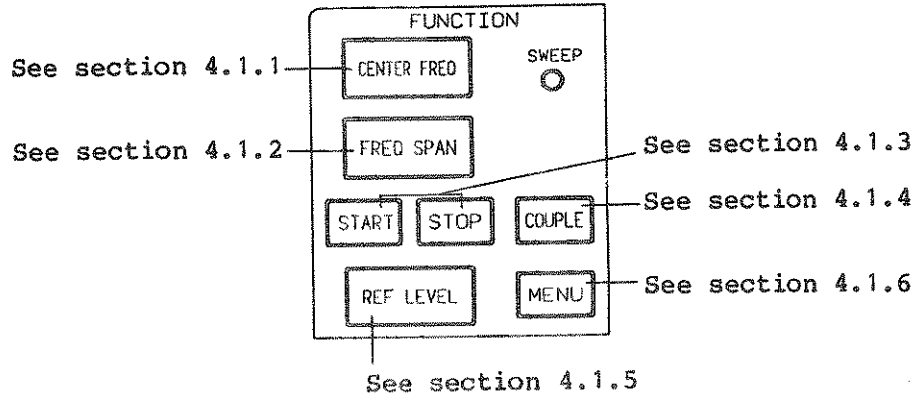

R3261/3361
SPECTRUM ANALYZER
INSTRUCTION MANUAL

4.1 Functions of FUNCTION Section

4.1.1 Center Frequency

- (1) Panel Keys and the Corresponding Softkey Menu

Refer to Section A.1 (1).

- (2) Setting the Center Frequency

The center frequency may be set within the range from 0MHz to 3600MHz. The initial value is 1800MHz.

Center frequency display resolution		
100kHz	(Span \geq 100MHz)
10kHz	(100MHz >	Span \geq 10MHz)
1kHz	(10MHz >	Span \geq 1MHz)
100Hz	(1MHz	Span \geq 100kHz)
10Hz	(100kHz >	Span \geq 10kHz)
1Hz	(10kHz >	Span \geq 1kHz)
1Hz	(Span = 0Hz)

Center frequency accuracy
<p>The center frequency depends on the frequency span and reference oscillator accuracy.</p> <p>If span > 2MHz; $\pm(2\% \text{ of span} + \text{Center frequency} \times \text{Reference oscillator} + 100\text{Hz})$</p> <p>If span \leq 2MHz; $\pm(3\% \text{ of span} + \text{Center frequency} \times \text{Reference oscillator} + 100\text{Hz})$</p> <p>Reference oscillator accuracy: $2 \times 10^{-7}/\text{week}$, $1 \times 10^{-6}/\text{year}$</p> <p>When an external reference signal source (10MHz) is used, this accuracy applies as the reference oscillator accuracy.</p>

R3261/3361
SPECTRUM ANALYZER
INSTRUCTION MANUAL

4.1 Functions of FUNCTION Section

[Procedure and explanation]

Press .

Center frequency set mode.

Data entry is enabled and the center frequency data is displayed on the screen.

[Data Adjustment Keys]

- Data knob : Turning this knob clockwise will raise the center frequency. Turning it counterclockwise will lower the center frequency. The setting resolution is about 1/1000 of the frequency span.
- Step key : Pressing this key once will raise or lower the center frequency step by step. When the step size is set to AUTO, the step width becomes 1/10 of the frequency span (one horizontal scale).
- Ten key : The setting resolution is determined according to the frequency span.

CAUTION

The center frequency may be changed when the span mode is set to LINEAR or ZERO. It cannot be changed when the span mode is FULL or LOG SPAN.

(3) Setting the CF STEP SIZE

The center frequency step size may be set within the range from 0Hz to 3600MHz.

R3261/3361
SPECTRUM ANALYZER
INSTRUCTION MANUAL

4.1 Functions of FUNCTION Section

[Procedure and explanation]

Press

CENTER FREQ

CF STEP SIZE

Step-size set mode for the center frequency.
Data can be entered and the center frequency step-size data is displayed on the screen.

Press

CENTER FREQ

CF STEP AUTO

Step-size set mode for the center frequency.
The center frequency step-size data is set to AUTO mode, and the specified number of steps are deleted from the screen.

[Data Adjusting Keys]

- Data knob : Turning this knob clockwise will increase the center frequency step size. Turning it counterclockwise will decrease the center frequency step size. The set resolution is the same as the display resolution.
- Step key : The center frequency step size is increased or decreased by a value which is 10 times the display resolution value.
- Ten key : The set resolution is the same as the set resolution.

(4) Setting the OFFSET FREQ

The offset frequency can be set within the range from 0MHz to ± 9999 MHz. If a value less than the display resolution is entered, it is automatically replaced by the display resolution value.

$\text{Center Frequency (Display)} = \text{Center Frequency (Setting)} + \text{OFFSET}$

R3261/3361
SPECTRUM ANALYZER
INSTRUCTION MANUAL

4.1 Functions of FUNCTION Section

[Procedure and explanation]

Press , and is set to ON.

Offset frequency set mode.

Data can be entered and the offset frequency data is displayed on the screen. The center frequency and marker frequency are displayed after adding the offset value.

This key is set to ON and OFF alternately each time it is pressed.

Example: : Data can be entered and the offset is operative.

Press , and is set to + or -.

Select the sign for offset.

[Data Adjusting Keys]

Data knob : Turning this knob clockwise will increase the offset frequency. Turning it counterclockwise will decrease the offset frequency. The set resolution is the same as the display resolution.

Step key : The offset frequency is increased or decreased by 10 times the display resolution value.

Ten key : The set resolution is the same as the center frequency.

4.1.2 Frequency Span

(1) Panel Keys and the Corresponding Softkey Menu

Refer to Section A.1 (2).

R3261/3361
SPECTRUM ANALYZER
INSTRUCTION MANUAL

4.1 Functions of FUNCTION Section

(2) Setting the Frequency Span

Frequency span display resolution		
1MHz ...	(3600MHz	Span = 401MHz)
100kHz ...	(400.0MHz	Span = 40.1MHz)
10kHz ...	(40.00MHz	Span = 2.01MHz)
1kHz ...	(2.000MHz	Span = 401kHz)
100Hz ...	(400.0kHz	Span = 40.1kHz)
10Hz ...	(40.00kHz	Span = 1.0Hz)
1Hz ...	(Span = 0.0Hz)

Frequency span accuracy	
LINEAR mode:	±3%
LOG mode :	±10%

[Procedure and explanation]

Press FREQ SPAN .

Frequency span set mode.
Data can be entered and the frequency span data is displayed on the screen.

[Data Adjusting Keys]

- Data knob : Turning this knob clockwise will make the frequency span wider. Turning it counterclockwise will make the frequency span narrower. The set resolution is 1/100 of the current frequency span.
- Step key : Data is input in the 1-2-5 step in the following sequence:
3600MHz ↔ 2000MHz ↔ 1000MHz ↔ ... ↔ 5kHz ↔ 2kHz
↔ 1kHz
- Ten key : The set resolution is determined according to the frequency span.

CAUTION

The frequency span can be changed only in the LINEAR mode but it cannot be changed in the FULL, LOG, or ZERO SPAN mode.

R3261/3361
SPECTRUM ANALYZER
INSTRUCTION MANUAL

4.1 Functions of FUNCTION Section

(3) Switching Span Modes

[Procedure and explanation]

Press PREQ SPAN LINEAR
SPAN .

The frequency span scale is displayed in the linear mode (initial setting).

Press PREQ SPAN FULL
SPAN .

The center frequency is 1800MHz and the frequency span is 3600MHz. The center frequency and frequency span cannot be changed.

Press PREQ SPAN LOG
SPAN .

The frequency span scale is displayed in the log mode. Set start and stop frequencies according to the following combination table. To enter start and stop frequencies, use the START and STOP keys.

Start frequency	Stop frequency
10kHz	100kHz
	1MHz
	10MHz
100kHz	1MHz
	10MHz
	100MHz
1MHz	10MHz
	100MHz
	1000MHz
10MHz	100MHz
	1000MHz
100MHz	1000MHz
	1000MHz

Press PREQ SPAN ZERO SPAN .

The frequency is fixed to the center frequency to operate this analyzer as a tuning receiver. In this case, the horizontal axis becomes a time axis and the center frequency size is calculated according to the previous frequency span.

R3261/3361
SPECTRUM ANALYZER
INSTRUCTION MANUAL

4.1 Functions of FUNCTION Section

4.1.3 Start and Stop Frequencies

(1) Panel Keys and the Corresponding Softkey Menu

Refer to Section A.1 (3) and A.1 (4).

(2) Setting the Start Frequency

The start frequency can be set between -200MHz and +3600MHz. The initial value is 0MHz.

[Procedure and explanation]

Press

START

Start frequency mode.

Data can be entered and the start/stop data is displayed on the screen.

R3261/3361
SPECTRUM ANALYZER
INSTRUCTION MANUAL

4.1 Functions of FUNCTION Section

[Data Adjusting Keys]

- Data knob : Turning this knob clockwise will raise the start frequency. Turning it counterclockwise will lower the start frequency. The set resolution is about 1/1000 of the frequency span.
- Step key : The start frequency is increased/decreased according to the step size setting. When the step size data is cleared (AUTO), the step width becomes 1/10 of the frequency span (i.e., one horizontal scale).
- Ten key : The set resolution is determined according to the frequency span.

CAUTION

The start frequency can be changed in the LINEAR or ZERO mode but it cannot be changed in the FULL SPAN mode. When the LOG SPAN key is pressed, it is replaced with an approximate constant.

(3) Setting the Stop Frequency

The stop frequency can be set between 0Hz and 3800MHz. The initial value is 3600MHz.

[Procedure and explanation]

Press .

When the stop frequency mode is selected, data can be entered and the start/stop data is displayed on the screen.

[Data Adjusting Keys]

- Data knob : Turning this knob clockwise will raise the stop frequency. Turning it counterclockwise will lower the start frequency. The set resolution is about 1/1000 of the frequency span.
- Step key : The stop frequency is increased/reduced according to the step size setting. When the step size data is cleared (AUTO), the step width becomes 1/10 of the frequency span (i.e., one horizontal scale).
- Ten key : The set resolution is determined according to the frequency span.

R3261/3361
SPECTRUM ANALYZER
INSTRUCTION MANUAL

4.1 Functions of FUNCTION Section

CAUTION

The stop frequency can be changed in the LINEAR or ZERO mode but it cannot be changed in the FULL SPAN mode. When the LOG SPAN key is pressed, it is replaced with an approximate constant.

(4) Setting of Frequency Offset (FREQ OFFSET)

The offset frequency can be set within the range of 0 to +9999MHz. If data having the resolution less than the display resolution is entered, the display resolution is used automatically.

Start or stop frequency (display)
= Start or stop frequency (setting) + Offset

[Procedure and explanation]

Press or , and is set to ON.

Offset frequency setting mode.

This key allows data entry and it displays the offset frequency data on the screen. The offset is added to the start (or stop) frequency and marker frequency, and the resulting frequency is displayed.

When this key is pressed, the ON and OFF states are switched. The selected status is displayed in reverse display on the software menu.

Example : /OFF : Data can be entered and the offset ON mode has been selected.

Press or , and is set to + or -.

Selects the positive (+) or negative (-) sign for offset frequency setup.

[Data Adjusting Keys]

Data knob : Turning this knob clockwise will increase the offset frequency. Turning it counterclockwise will decrease the offset frequency. The setting resolution is equal to the screen resolution.

R3261/3361
SPECTRUM ANALYZER
INSTRUCTION MANUAL

4.1 Functions of FUNCTION Section

- Step key : The offset frequency can be increased or decreased for ten times of the screen resolution.
- Ten key : The setting resolution is determined according to the center frequency.

R3261/3361
SPECTRUM ANALYZER
INSTRUCTION MANUAL

4.1 Functions of FUNCTION Section

4.1.4 Couple

(1) Panel Keys and the Corresponding Softkey Menu

Refer to Section A.1 (5)

(2) Setting the Resolution Band Width (RBW)

When a narrow RBW is set, the spectrum becomes thin and the resolution is improved. Accordingly, the spectrum can be separated from the neighboring noise and a spectrum can be separated from other spectrums. However, the sweep time lengthens as the resolution is enhanced. When the signal level narrows, the **UNCL** message is displayed.

The RBW can be set within the range from 30Hz to 1MHz. AUTO is set initially and an optimum RBW is set according to the frequency span.

Relationships between frequency spans and RBW values (AUTO)	
RBW	Frequency span
1MHz ↔ (Span ≥ 60MHz)
300kHz ↔ (60MHz >	Span ≥ 20MHz)
100kHz ↔ (20MHz >	Span ≥ 6MHz)
30kHz ↔ (6MHz >	Span ≥ 2MHz)
10kHz ↔ (2MHz >	Span ≥ 300kHz)
3kHz ↔ (300kHz >	Span ≥ 100kHz)
1kHz ↔ (100kHz >	Span ≥ 30kHz)
300Hz ↔ (30kHz >	Span ≥ 10kHz)
100Hz ↔ (10kHz >	Span ≥ 5kHz)
30Hz ↔ (5kHz >	Span)

R3261/3361
SPECTRUM ANALYZER
INSTRUCTION MANUAL

4.1 Functions of FUNCTION Section

[Procedure and explanation]

Press COUPLE RBW .

RBW set mode

Data can be entered and the RBW data is displayed on the screen. The softkey menu is displayed in the reverse mode.

[Data Adjusting Keys]

Data knob : Data is input by the 1-3 step in the following sequency:
1MHz ↔ 300kHz ↔ 100kHz ↔ ... ↔ 100Hz ↔ 30Hz

Step key : Data is input by the 1-3 step in the following sequency:
1MHz ↔ 300kHz ↔ 100kHz ↔ ... ↔ 100Hz ↔ 30Hz

Ten key : The frequency is replaced with an approximate constant assuming that the switching point is at 1.5 or 7.0.

(3) Setting a Video Band Width (VBW)

Noise contained in the signal waveform and bottom noise is averaged to find the hidden signal. Noise is averaged by filtering the detected signal waveform with a low pass filter, which improves the S/N ratio by about 10dB. To make the averaging process effective, the band width of this low pass filter must be changed according to RBW.

If VBW is narrowed, the measurement level may be lowered and the LXAL message may be displayed because of the constant when a low pass filter is inserted. If this is the case, the sweep time must be prolonged.

The VBW may be set within the range from 1Hz to 1MHz. Initially, AUTO is set and the optimum VBW is set according to the RBW.

Relationships between RBWs and VBW values (AUTO)	
VBW	RBW
1MHz	↔ 1MHz
100kHz	↔ 300kHz or 100MHz
10kHz	↔ 30kHz or 10kHz
1kHz	↔ 3kHz or 1kHz
100Hz	↔ 300Hz or 100Hz
10Hz	↔ 30Hz

R3261/3361
SPECTRUM ANALYZER
INSTRUCTION MANUAL

4.1 Functions of FUNCTION Section

[Procedure and explanation]

Press

COUPLE

VBW

 .

VBW set mode.

Data can be entered and the VBW data is displayed on the screen. The softkey menu is displayed in reverse.

[Data Adjusting Keys]

Data knob : Data is set in the following sequence:
1MHz ↔ 100kHz ↔ 10kHz ↔ 1kHz ↔ 100Hz ↔ 10Hz

Step key : Data setting steps are as follows:
1MHz ↔ 100kHz ↔ 10kHz ↔ 1kHz ↔ 100Hz ↔ 10Hz

Ten key : Data is replaced with the approximate constant after counting fractions over 6/10 as one and disregarding the rest. Moreover, 1Hz may be set.

(4) Setting the Sweep Time (SWP)

If the sweep speed is too fast to display the signal waveform, the displayed level is erroneous and the **NOISE** message is displayed. If this is the case, the sweep time must be prolonged.

The SWP may be set within the range from 50ms to 1000s. Initially AUTO is set. The SWP is set according to the frequency span, RBW, and VBW, so that the displayed level is not correct.

Relationships between frequency span, RBW, VBW, and AUTO setting

$\text{Frequency span} / \{ \text{RBW} * \text{Min} (\text{RBW}, \text{VBW}) * 0.5 \} = \text{SWP}$

[Procedure and explanation]

Press

COUPLE

SWP

 .

SWP set mode.

Data can be entered and the SWP data is displayed on the screen. The softkey menu is displayed in the reverse mode.

R3261/3361
SPECTRUM ANALYZER
INSTRUCTION MANUAL

4.1 Functions of FUNCTION Section

[Data Adjusting Keys]

- Data knob : Use the display resolution.
- Step key : Data is set in the 1-2-5 step in the following sequence:
1000s ↔ 500s ↔ 200s ↔ ... ↔ 200ms ↔ 100ms ↔ 50ms
- Ten key : Use the display resolution.

(5) Input Attenuator (ATT)

The ATT is used to prevent the input section from destruction, attenuate the input signal amplitude up to the easy-to-observe level, and prevent distortion during signal analysis.

The attenuation level may be set within the range from 0dB to 50dB. Initially, it is set to AUTO (10dB). The optimum attenuation level is set according to the reference level.

[Procedure and explanation]

Press .

ATT set mode.

Data can be entered and the ATT data is displayed on the screen. The softkey menu is displayed in the reverse mode.

[Data Adjusting Keys]

- Data knob : 10, 20, 30, 40, or 50dB is set.
- Step key : 10, 20, 30, 40, or 50dB is set.
- Ten key : Data is replaced with the approximate constant after rounding off. 0dB may be set only with these keys.

R3261/3361
SPECTRUM ANALYZER
INSTRUCTION MANUAL

4.1 Functions of FUNCTION Section

(6) Selecting AUTO

[Procedure and explanation]

Press

COUPLE

AUTO

Select the COUPLE function key to be set in the AUTO state from the softkey menu, then press this key. The softkey menu corresponding to the function in the data entry state is displayed in reverse, and other functions are framed.

Example:

 : Indicates that both data entry state and manual state are set.

 : Indicates that the manual state is set. RBW displayed in the lower left of the screen is underlined.

RBW : Indicates that the AUTO state is set.

Press

COUPLE

ALL AUTO

All COUPLE functions are set in the AUTO state.

R3261/3361
SPECTRUM ANALYZER
INSTRUCTION MANUAL

4.1 Functions of FUNCTION Section

4.1.5 Reference Level

(1) Panel Keys and the Corresponding Softkey Menu

Refer to Section A.1 (6)

(2) Setting the Reference Level

The reference level can be set within the range from -109.9dBm to +40.0dBm(R3261C/D, R3361C/D), +0.1dBμ to +150dBμ(R3261CN, R3361CN). The initial value is 0.0dBm(R3261C/D, R3361C/D), 110dBμ(R3261CN, R3361CN) and the vertical axis is graduated to eight 10dB scales.

Reference level accuracy
±1dB or less when measured at 200MHz within the reference level from 0dBm to -109.9dBm (R3261C/D, R3361C/D), +110dBμ to +0.1dBμ (R3261CN, R3361CN) and calibrated by the 10dB input attenuator.

[Procedure and explanation]

Press

REF LEVEL

Reference level set mode.
Data can be entered and the reference level data is displayed on the screen.

[Data Adjusting Keys]

Data knob : Turning this knob clockwise will raise the reference level and turning it counterclockwise will lower the reference level. The set resolution is 0.1dB.

Step key : Data can be set in 10dB steps.

Ten key : The set resolution is 0.1dB.

CAUTION

When the input attenuator is in the manual mode, the reference level is affected by the manually set attenuation value, that is, its range may be narrower than -109.9dBm to +40.0dBm(R3261C/D, R3361C/D), +0.1dBμ to +150dBμ(R3261CN, R3361CN).

(3) Setting the dB/div

dB/div may be set to 10, 5, 2, 0.5, 0.2, or 0.1dB. If it is set to a value other than fixed values, the set value is replaced with the nearest fixed value. The LINEAR mode is automatically switched to the LOG mode.

[Caution when applying 120dB measuring function]

120dB measuring function has a measuring range of more than 110dB, by changing the measuring sensitivity near -60dB point. Therefore, change-over time is required when the measuring sensitivity is changed. This change-over time is variable according to the resolution bandwidth and video bandwidth.

When the operator measures a signal at a noise level near -60dB, the measuring time will be longer than the set value of the sweep time. In this case, select 8div display, and short time measurement is available.

In the 120dB measuring function, noise may occur near the change-over point when resolution bandwidth, video bandwidth and sweep time are combined. When noise occurs, change the sweep time and use the range under conditions where the noise does not occur.

When the operator selects 120dB measuring function during measurement of the line spectrum, the spectrum may not have been indicated. In this case, select 8div mode to measure the spectrum.

[Procedure and explanation]

Press .

dB/div set mode.

Data can be entered and the dB/div data is displayed on the screen.

Press .

This menu is effective only when the 10dB/div is set. In other cases, the softkey menu is cleared.

R3261/3361
SPECTRUM ANALYZER
INSTRUCTION MANUAL

4.1 Functions of FUNCTION Section

[Data Adjusting Keys]

- Data knob : Data is set in the 1-2-5 step in the following sequence:
10dB ↔ 5dB ↔ 2dB ↔ 1dB ↔ 0.5dB ↔ 0.2dB ↔ 0.1dB
- Step key : Data is set by the 1-2-5 step in the following sequence:
10dB ↔ 5dB ↔ 2dB ↔ 1dB ↔ 0.5dB ↔ 0.2dB ↔ 0.1dB
- Ten key : When a numeric key is pressed, its value is replaced with the nearest prefixed value.

(4) Selecting a LINEAR Mode

Switch the LOG mode to the LINEAR mode. The vertical axis is calibrated to 10 scales; the highest level indicates the reference level and the lowest level depends on the scale factor.

[Procedure and explanation]

Press REF LEVEL LINEAR .

LINEAR set mode.

Data can be entered and the reference level data is displayed in voltage units.

Since the unit of voltage is converted from the unit of dBm, some error may be caused.

[Data Adjusting Key]

- Data knob : Turning this knob clockwise will raise the reference level and turning it counterclockwise will lower the reference level. The set resolution is represented by a voltage value converted from 0.1dB.
- Step key : Data can be set in 10dB steps.
- Ten key : The set resolution is the fourth decimal place.

R3261/3361
SPECTRUM ANALYZER
INSTRUCTION MANUAL

4.1 Functions of FUNCTION Section

(5) Setting DISPLAY UNIT

The DISPLAY UNIT is the display units for the reference level, display line and marker level. The following are selectable:

Level display unit	
R3261C/D, R3361C/D	R3261CN, R3361CN
dBm	dBμV
dBmV (dBm + 47dB)	dBμVemf (dBμ + 6dB)
dBμV (dBm + 107dB)	dBmV (dBμ - 60dB)
dBμVemf (dBm + 113dB)	dBm (dBμ - 108.8dB)
dBpW (dBm + 90dB)	dBpW (dBμ - 18.8dB)

(6) Setting REF OFFSET

The REF OFFSET key toggles ON and OFF. The mode displayed in reverse is operative.

Example: REF OFS: Indicates that the OFF mode is operative.
ON/

The offset level of the reference level can be set within the range from -99.9dB to +99.9dB. It is ineffective in the LINEAR mode.

$$\text{Reference level (Display)} = \text{Reference level (Setting)} + \text{OFFSET}$$

[Procedure and explanation]

Press REF LEVEL, and REF OFS
ON/OFF is set to ON.

Reference level offset level set mode.
Data can be entered and the reference level offset level data is displayed on the screen. The reference level and marker level are displayed after adding an offset value.

R3261/3361
SPECTRUM ANALYZER
INSTRUCTION MANUAL

4.1 Functions of FUNCTION Section

[Data Adjusting Keys]

- Data knob : Turning this knob clockwise will raise the reference level offset level and turning it counterclockwise will lower the reference level offset level.
- Step key : Data can be set in 10dB steps.
- Ten key : The set resolution is 0.1dB.

CAUTION

The REF OFFSET mode cannot be set even when REF OFS ON/OFF is set to ON, if the mode is LINEAR. Firstly select LOG mode, then REF OFS ON/OFF is set to ON. The LINEAR mode cannot be set while REF OFS is on. REF OFS ON/OFF

R3261/3361
SPECTRUM ANALYZER
INSTRUCTION MANUAL

4.1 Functions of FUNCTION Section

4.1.6 Menu

(1) Panel Keys and the Corresponding Softkey Menu

Refer to Section A.1 (7).

(2) Setting Trigger

[Procedure and explanation]

Press .

Trigger condition set mode.
The trigger mode softkey menu is displayed.

Press .

Internal sweep operation is repeated automatically.
(Initial setting)

Press .

Trigger is caused by the TV's vertical signal.

Press .

Sweep operation is repeated in synchronization with
the AC power frequency.

Press .

Trigger is caused by the waveform displayed on the
screen.

Press .

Sweep operation is controlled by external trigger.
Trigger occurs when TTL-level signal is applied to the
EXT TRIG terminal on the rear panel to set the signal
level from high to low.

R3261/3361
SPECTRUM ANALYZER
INSTRUCTION MANUAL

4.1 Functions of FUNCTION Section

Press

MENU

TRIGGER

SINGLE

 .

Single sweep mode. Sweep operation can be controlled by pressing this key. If this key is pressed when the trigger mode is SINGLE, sweep operation is performed once. If this key is released during sweep operation, sweep operation is interrupted in any trigger mode and it is restarted from the beginning. Therefore, this key is used to retry sweep operation during rewriting of screen data when it takes a long time to complete the whole sweep operation.

(3) Setting a Detector

[Procedure and explanation]

Press

MENU

DETECTOR

 .

Trace detection set mode.
The DET mode softkey menu is displayed.

Press

MENU

DETECTOR

NORMAL DET

 .

Normal detection is set. (Initially, NORMAL is set.)

Press

MENU

DETECTOR

POSI DET

 .

A POSI peak is set. Since the peak of a spectrum is seized without fail, this mode is effective for measuring the level of the thin spectrum or PULSED RF signal.

Press

MENU

DETECTOR

NEGA DET

 .

A NEGA peak is set.

Press

MENU

DETECTOR

SAMPLE DET

 .

Sample detection is set.

(4) Setting the Sweep Mode

[Procedure and explanation]



Sweep mode.
The SWEEP mode softkey menu is displayed.

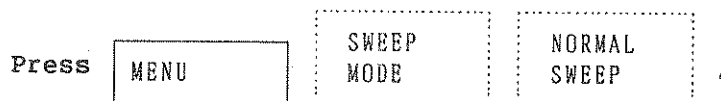

Normal sweep mode.

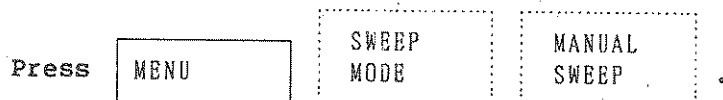

Manual sweep mode.
The frequency and level of the current sweep point are displayed.
To move the sweep point, turn the data knob clockwise or counterclockwise or press step keys.



Sweeping between two markers. The Δ marker size may be changed like the ordinary Δ marker.

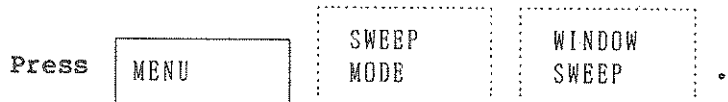

Sweeping within the measurement window.
See section 4.10.

R3261/3361
SPECTRUM ANALYZER
INSTRUCTION MANUAL

4.1 Functions of FUNCTION Section

Press MENU SWEEP
MODE, and MK PAUSE
ON/OFF is set to ON.

Pause time setting mode.

If this key is pressed, data can be entered and the pause time is displayed on the screen. Sweep operation stops at the marker for the period of pause time. The key is used for audio monitor at the marker. The pause time can be set within the range from 1ms to 1000s. The initial value is 1ms.

This key is set to the ON and OFF positions alternately each time it is pressed. The mode displayed in the reverse mode is active.

Example: MK PAUSE
ON/OFF : Indicates that data was entered and the ON mode is active.

[Data Adjusting Key]

Data knob : Turning this knob clockwise will increase the pause time and turning it counterclockwise will reduce the pause time. The set resolution is 1ms.

Step key : The pause time is increased/decreased in 100ms units.

Ten key : The set resolution is 1ms.

(5) Setting a Display Line

The display line is a horizontal cursor line which is used for waveform level comparison. It can be set within the range from reference level to the lowest level. The initial level is -40dBm.

The lowest level is { REF + (dB/scale) * scale }.

X dB/div	Display resolution (dB)
10	0.1
5	0.01
2	0.01
1	0.01
0.5	0.001
0.2	0.001
0.1	0.001

R3261/3361
SPECTRUM ANALYZER
INSTRUCTION MANUAL

4.1 Functions of FUNCTION Section

[Procedure and explanation]

Press , and is set to ON.

Display line set mode.

Data can be entered and the display line data is displayed on the screen.

If data has previously been entered, press the display line ON/OFF key for switching modes; otherwise, the data entry state is set then the display line ON mode is set.

Example: OFF state

: DISPLINE
ON/OFF

Data entry state and ON state:

[Data Adjusting Key]

- Data knob : Turn this knob clockwise will raise the display line and turn it counterclockwise will lower the display line. The set resolution is 1/400 the dynamic range.
- Step key : The display line is moved 1 scale up/down.
- Ten key : The set resolution is 0.1dB.

(6) Selecting a Trace Mode

[Procedure and explanation]

Press .

Selection and setting are enabled only for the following functions. (A trace function is selected by the A-key or B-key.)

Press .

Contents of memories A and B are exchanged. Contents of trace A are exchanged with those of trace B.

R3261/3361
SPECTRUM ANALYZER
INSTRUCTION MANUAL

4.1 Functions of FUNCTION Section

Press

MENU

TRACE MENU

A-B → A

 .

The value obtained by subtracting the memory B value from the memory A value is indicated for each point. The contents of memory B are subtracted from those of memory A or sweep result and the subtraction result is stored in memory A.

When VIEW A or BLANK B are selected, contents of memory B are subtracted from the contents of memory A and the result is stored in memory A.

When neither VIEW nor BLANK is selected for trace A, the contents of memory B are subtracted from the sweep result and the result is stored in memory A.

When neither VIEW nor BLANK is selected for trace B, VIEW B is selected automatically.

Press

MENU

TRACE MENU

B-A → A

 .

The value obtained by subtracting the memory A value from the memory B value is indicated for each point. The contents of memory A are subtracted from those of memory B or sweep result and the subtraction result is stored in memory A.

When VIEW A or BLANK B are selected, contents of memory A are subtracted from contents of memory B and the result is stored in contents A.

When neither VIEW nor BLANK is selected for trace A, the sweep result is subtracted from the contents of memory B and the result is stored in memory A.

When neither VIEW nor BLANK is selected for trace B, VIEW B is selected automatically.

Press

MENU

TRACE MENU

A-DL → A

 .

The value obtained by subtracting the display line value the memory A value is displayed for each point. The display line level is subtracted from the contents of memory A or sweep result, and the subtraction result is stored in memory A.

When VIEW A or BLANK A are selected, the display line level is subtracted from the contents of memory A, and the result is stored in memory A.

When neither VIEW nor BLANK is selected for trace B, the display line level is subtracted from the sweep result and the result is stored in memory A.

R3261/3361
SPECTRUM ANALYZER
INSTRUCTION MANUAL

4.1 Functions of FUNCTION Section

Press .

The value obtained by subtracting the display line value the memory B value is displayed for each point. The display line level is subtracted from the contents of memory B or sweep result, and the subtraction result is stored in memory B.

When VIEW B or BLANK B are selected, the display line level is subtracted from the contents of memory B, and the result is stored in memory B.

When neither VIEW nor BLANK is selected for trace B, the display line level is subtracted from the sweep result and the result is stored in memory B.

(7) Setting a Sound (Audio Monitor)

[Procedure and explanation]

Press .

AM wavelength signals are received.

Press .

FM wavelength signals are received.

Press .

The sound volume is set to the maximum level.

Press .

The sound volume is set to the medium level.

Press .

The sound volume is set to the minimum level.

Press , and is set

to ON or OFF.

A sound monitor mode is turned on or off.

R3261/3361
SPECTRUM ANALYZER
INSTRUCTION MANUAL

4.1 Functions of FUNCTION Section

[Procedure to generate the sound]

- ① Place the marker to the spectrum to be monitored.
- ② PAUSE Time Setting

Press , and set the to ON.

Then, set the PAUSE time.

For example, press to set the PAUSE time to ten seconds.

- ③ Sound Output

Press , and set the to ON.

- ④ Selection in Demodulating Format

Press or .

- ⑤ Volume Adjustment

Press , , or .

By the above operation, SOUND is generated for the specified PAUSE time at every sweeping.

(8) Changing the Graticule

[Procedure and explanation]

Press , and is set to ON or OFF.

When this key is set to ON, the graticule is displayed on the screen (normal mode). When this key is set to OFF, only a waveform and character data are displayed.

R3261/3361
SPECTRUM ANALYZER
INSTRUCTION MANUAL

4.1 Functions of FUNCTION Section

(9) Selection of SSB PHASE NOISE characteristics

[Procedure and explanation]

Press MENU NEXT MBNU , and SSB NOI
CLOSE/BD is set to CLOSE or
BD(Broad).

Note: This softkey menu appears only when a frequency span is set at 10kHz or less.

To measure spurious signals or noise, the Dynamic Range can be expanded when the Broad Mode is selected at a frequency span of 10kHz or less, whose frequency is separated from the carrier's frequency more than 5kHz. Usually, the CLOSE-IN Mode is selected. To measure the carrier frequency or near it, you do not have to select the Broad Mode.

4.2 TRACE Section Functions (Waveform display function)

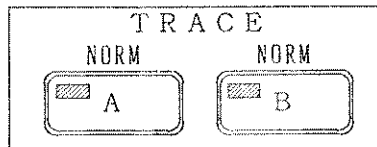

The CRT display consists of 701 horizontal points and 401 vertical points. By displaying level data at horizontal points, trace data (signal waveform) can be displayed.

An input signal passes through the RF/IF section, its waveform is detected by the LOG/LIN amplifier, then A/D conversion is performed. This data is stored in the trace memory and displayed on the CRT display under the control of the CPU. Two trace memories, A and B, are provided and each memory can be rewritten after sweeping or it can store and display an arbitrary waveform.

CAUTION

1. Note that if the limit line is executed, the trace data stored is deleted, since the trace memory B is used.
2. Do not execute the AVERAGING measurement (SAMPLE mode) in the MAX HOLD measurement mode (POSI mode.) Also, do not execute the MAX HOLD measurement (POSI mode) in the AVERAGING measurement mode (SAMPLE mode.) They have different trace detection modes respectively.

R3261/3361
SPECTRUM ANALYZER
INSTRUCTION MANUAL



4.2 TRACE Section Functions

(1) Panel Keys and the Corresponding Softkey Menu

Refer to Section A.1 (8).

(2) WRITE Mode

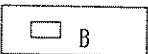
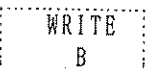

[Procedure and explanation]

Press  or press  or press  or press .

New data is written in memory A or B after each sweep operation and it is displayed on the screen.

(3) VIEW Mode

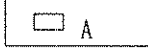
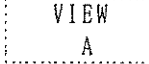
[Procedure and explanation]

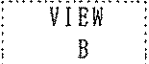
Press  or press  or press  or press .

If a VIEW mode is selected in the BLANK mode (explained later), trace A or B is displayed again. If the VIEW mode is selected in a mode other than BLANK mode, rewriting of memory A or B and display of waveform stop.

(4) BLANK Mode

[Procedure and explanation]

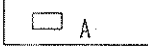
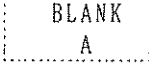
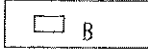
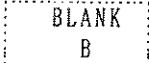
Press  or press  or press  or press .

Trace A or B disappears from the screen. Memory A or B holds the trace data stored at BLANK mode selection. When the VIEW mode is selected, contents of memory A or B are displayed.

(5) MAX HOLD Mode

[Procedure and explanation]

Press A MAX HOLD A or press B MAX HOLD B .

Each point data on the frequency axis is compared with new data after each sweep operation, then the greater data is stored in the memory and displayed on the screen at the same time. That is, the waveform becomes the trace of the maximum values (time series). In this mode, the trace detection mode is automatically set to POSI.

(6) AVERAGING Mode

[Procedure and explanation]

Press A AVG A or press B AVG B .

Averaging mode.

The S/N ratio can be improved easily as compared with the noise suppression in the VIDEO BW mode, thus enabling quantitative estimation of random elements and measurement of signals contained in noises. When this mode is selected, the trace detection mode is automatically set to SAMPLE. The averaging count can be set between 2 and 1000 step by step.

Press A AVG A AVG A ST/SP or press B AVG B AVG B ST/SP .

If this key is pressed during averaging, the average mode is canceled and the previous trace mode is set again. If this key is pressed again, averaging is restarted from the beginning.

Press A AVG A A PAUSE /CONT or press B AVG B B PAUSE /CONT .

If this key is pressed during averaging, the averaging mode is canceled temporarily. If this key is pressed again, operation is restarted from the operation step in which the averaging mode was canceled temporarily.

R3261/3361
SPECTRUM ANALYZER
INSTRUCTION MANUAL

4.2 TRACE Section Functions

Press A

AVG	A 1 TIME
A	/CONT

 or press B

AVG	B 1 TIME
B	/CONT

When CONTINUE is active, averaging is continued according to arithmetic operation method 2 if the averaging count reaches the specified limit.
When 1 TIME is active, the VIEW mode is selected automatically after the averaging count reaches the specified limit (the averaging mode is canceled).

Averaging Method

[When $N \geq n$] ... Operation method 1
 $Y_n = \text{Sigma}/n$

[When $N < n$] ... Operation method 2
 $Y_n = ((N - 1) \times Y_{n-1})/N + Y_n/N$

n : Present averaging count
Y : Specified averaging count
 Y_n : nth trace data
 Y_n : nth averaged data
 Y_{n-1} : (n-1)th averaged data
Sigma: Sum of data including the nth data

[Data Adjusting Key]

The averaging count can be set with ten keys, data knob or step key.
After inputting a desired averaging count, press the unit key.

(7) NORMALIZE Mode

CAUTION

R3361C/CN/D only

When the tracking generator is used, it is recommended that the cable frequency characteristics be modified together with those of the R3361C/CN/D itself and filter. (See Section 5.2 for further details.)

R3261/3361
SPECTRUM ANALYZER
INSTRUCTION MANUAL

4.2 TRACE Section Functions

[Procedure and explanation]

Press A NORM A or press B NORM B .

The signal stored in the memory is subtracted from the input signal and the result is displayed, that is, the difference between the signal stored in the memory and the input signal is displayed. Actually, the DISP LINE value is added to the difference to be displayed.

Input signal - CORRECTION DATA + DISP LINE → Display

Press A NORM A ON/OFF or press B NORM B ON/OFF .
 NORM A ON/OFF or NORM B ON/OFF is set to ON and OFF alternately

each time it is pressed. The mode displayed in the reverse mode is active. Before setting this key to ON, press the CORRECTION DATA SAVE key.

Press A NORM A CORRECT SAVE or press B NORM B CORRECT SAVE .

The current trace A or B is stored in the memory as the correction data. This data is not cleared if the power is switched off.

Press A NORM A DSP LINE ON/OFF or press B NORM B DSP LINE ON/OFF .

The display line is a horizontal line used for waveform level comparison. DSP LINE ON/OFF is set to ON and OFF alternately each time it is pressed.

Press A NORM A INSTANT NORM A or press B NORM B INSTANT NORM B .

Normalize mode.

When this key is pressed, the following procedure is executed.

- ① The display line is displayed near the middle point between the maximum and minimum points of the signal.
- ② The current trace A or B is stored in the memory as the correction data. (Correction data saving)
- ③ Normalize ON.

R3261/3361
SPECTRUM ANALYZER
INSTRUCTION MANUAL

4.2 TRACE Section Functions

[Data Adjusting Keys]

Data knob : Turning this knob clockwise will raise the display line and turning it counterclockwise will lower the display line.
The set resolution is 1 point.

Step key : The display line is moved 1div up/down.

Ten key : The set resolution is 1 point.

(8) TRACE Mode

See Section 4.1.6-(6) for further details.

4.3 MARKER Section Functions

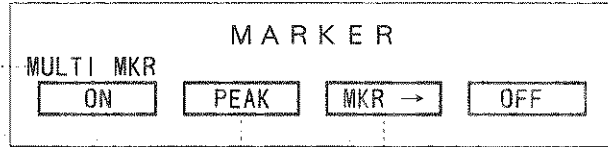

- See section 4.3.4
 - See section 4.3.1
 - See section 4.3.2
 - See section 4.3.3
- 4.3.1 Marker

[Functions]

Displays the normal marker and Δ marker on the waveform, its frequency, and level data.

- (1) Panel Keys and the Corresponding Softkey Menu

Refer to Section A.1 (13).

- (2) Setting the Normal Marker Frequency

The normal marker frequency can be set within the range from 0 to 3600MHz. The initial value is 1800MHz.

[Procedure and explanation]

Press

Normal marker frequency set mode. Data entry is enabled and the normal marker frequency level data are displayed on the screen if the marker is off. If the marker is on, either the normal marker or the Δ marker which is active is selected, and data entry is enabled.

Press

Normal marker frequency set mode. Data entry is enabled, and the normal marker frequency and level data are displayed on the screen.

R3261/3361
SPECTRUM ANALYZER
INSTRUCTION MANUAL

4.3 MARKER Section Functions

[Data Adjusting Keys]

- Data knob : Turning this knob clockwise will move the marker to the right and turning it counterclockwise will move the Δ marker to the left. The set resolution is 1/700 point.
- Step key : The marker is moved horizontally step by step according to the step size setting. If the step size is set to AUTO, it becomes 1/10 of the frequency span (horizontal 1 scale = step width).
- Ten key : The set resolution is determined according to the frequency span.

(3) Setting the Δ Marker

The Δ marker can be set within the range from 0 to ± 3600 MHz. If the start/stop frequency is exceeded, it is replaced with the start/stop frequency.

[Procedure and explanation]

Press ON Δ MKR .

Δ marker set mode. This key allows data entry. Two markers are displayed at the normal marker positions, The normal marker can shift while the other marker is fixed. The frequency or signal level between these two markers is displayed on the screen.

Press ON Δ MKR FIXED MK ON/OFF .

The fixed marker is displayed at the normal marker position together with the Δ marker, then the Δ marker is fixed at this position as a reference marker. When an active marker is moved, the distance from the reference marker is displayed as the marker data. This key is set to ON and OFF each time it is pressed, The mode displayed in the reverse mode is active.

Example: FIXED MK : Indicates that ON is active.
 /OFF

R3261/3361
SPECTRUM ANALYZER
INSTRUCTION MANUAL

4.3 MARKER Section Functions

[Data Adjusting Keys]

- Data knob : Turning this knob clockwise will move the active marker to the right and turning it counterclockwise will move the marker to the left. The set resolution is 1/700 point.
- Step key : The marker is moved horizontally step by step according to the step size setting. If the step size is set to AUTO, it becomes 1/10 of the frequency span (horizontal 1 scale = step width).
- Ten key : The set resolution is the same as that of the normal marker.

(4) Selecting the Counter Mode

[Procedure and explanation]

Press ON COUNTER .

The frequency counter function is selected. If the marker point is 15dB or more higher than the noise level, the frequency of the signal at the marker position is measured with high accuracy. Since the frequency of the marker is not measured but the frequency of the signal at the marker position is measured, the marker need not be set to the peak of the spectrum. However, the amplitude displayed is that at the marker point.

In the normal marker mode, the marker position on the frequency axis is calculated with reference to the center frequency to display the marker frequency. In the counter mode, however, it is directly measured according to the reference oscillator accuracy and

~~MKR COUNTER~~ ~~AMKR COUNTER~~
~~100.017~~ or ~~100.017~~

is displayed. On the other hand, a maximum resolution of 1Hz may be set with the softkey menu. The gating time lengthens and the sweep speed is reduced as the counter resolution is enhanced. This mode must not be set together with the SIGNAL TRACK (signal track mode).

R3261/3361
SPECTRUM ANALYZER
INSTRUCTION MANUAL

4.3 MARKER Section Functions

Press ON COUNTER, and FORWARD / BACK is set to FORWARD or BACK.

This device supports the following two counter modes.
Forward mode: Operates the counter at the marker point during sweep.

Back mode: Operates the counter for sweep blanking.

In forward mode, RBW or SPAN sometimes causes an error in waveforms while the counter is operating. In this case, change the mode to back mode. This allows the counter to stop. However, measuring time is longer than in forward mode.

CAUTION

Readouts may not be correct on the frequency counter mode if SPAN is set to 100MHz or more.

[Data Adjusting Keys]

- Data knob : Turning this knob clockwise will move the marker to the right and turning it counterclockwise will move the marker to the left. The set resolution is 1/700 point.
- Step key : The marker is moved horizontal step by step according to the step size setting. If the step size is set to AUTO, it becomes 1/10 of the frequency span (horizontal 1 scale = step width).
- Ten key : The set resolution is determined according to the frequency span.

(5) Setting the Signal Track Mode

[Procedure and explanation]

Press ON, and SIG TRK ON/OFF is set to ON or OFF.

If a signal drifts, the marker follows it and the center frequency change at the same time, enabling constant display of the signal at the center of the screen. This does not apply if the signal once disappears from the screen. This key is set to ON and OFF each time it is pressed. The mode displayed in the reverse mode is active.

Example: SIG TRK: Indicates that ON is active.
/OFF

(6) Selecting the Noise/Hz Mode

[Procedure and explanation]

Press .

When the marker is in the noise, the noise level measurement mode is set and the rms value of the noise normalized according to the 1Hz to 27MHz noise power band width can be measured. The marker level on the screen becomes XX dBm/Hz or XX dB μ V/ $\sqrt{\text{Hz}}$ to indicate that the noise level measurement mode is now selected.

Data can be entered.

(7) Setting X dB Down

Differences between frequencies and levels of two markers at the level which is xx.x dB lower (higher) than the normal marker level are displayed, or these frequencies and levels themselves are displayed.

The down-width can be set within 0 to \pm (the screen dynamic range). The initial value is 3dB.

Note: Be sure to turn the counter mode off before using the function of XdB down.

[Procedure and explanation]

Press .

Differences between frequencies and levels of two markers at the level which is xx.x dB lower than the normal marker level are displayed, or these frequencies and levels themselves are displayed.

Press .

Differences between frequencies and levels of two markers at the level which is xx.x dB lower than the normal marker level (only on the left side) are displayed, or these frequencies and levels themselves are displayed.

R3261/3361
SPECTRUM ANALYZER
INSTRUCTION MANUAL

4.3 MARKER Section Functions

Press .

Differences between frequencies and levels of two markers at the level which is xx.x dB lower than the normal marker level (only on the right side) are displayed, or these frequencies and levels themselves are displayed.

Press , and is set to REL or ABS1 or ABS2.

The following marker data to be displayed in the X dB DOWN mode is selected:

REL (relative display) : Δ marker
ABS1 (absolute display): Marker on the right
ABS2 (absolute display): Marker on the left

[Data Adjusting Keys]

- Data knob : Turning this knob clockwise will increase the down-width and turning it counterclockwise will reduce the down-width. The set resolution is 0.1dB (10dB, 5dB) or 0.01dB (2dB, 1dB). Negative values are X dB higher than positive value.
- Step key : The down-width is increased/decreased in 1dB units.
- Ten key : The set resolution is 0.1dB (10dB) or 0.01dB (5dB, 2dB, 1dB).

4.3.2 Peak Search

[Functions]

The maximum waveform level is searched, the marker is moved to that position, some peak levels are found in the waveform, and their frequencies and levels are displayed in a list format.

(1) Panel Keys and the Corresponding Softkey Menu

Refer to Section A.1 (14).

(2) Executing PEAK SEARCH

[Procedure and explanation]

Press .

The maximum level of the current waveform is searched, the marker (normal) is moved to this position, and the frequency and level are displayed on the screen. If the marker is not on, the peak level must be searched after the marker is displayed automatically.

If the measurement window is active, the peak is searched in this window first.

(3) Executing NEXT PEAK SEARCH

[Procedure]

Press .

Search the peak level in the current waveform from the higher level to 256 points (maximum) and display each frequency and level.

A VIEW waveform or a waveform after single sweep becomes valid. No valid result is obtained for NEXT PEAK during sweep.

Press: . The marker is sequentially shifted from the point with higher amplitude.

R3261/3361
SPECTRUM ANALYZER
INSTRUCTION MANUAL

4.3 MARKER Section Functions

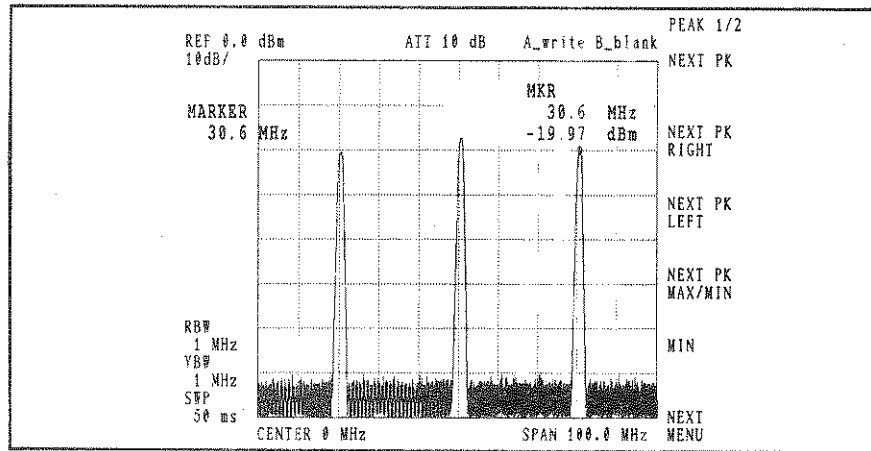

Figure 4 - 1 Execution of NEXT PK

(4) Executing NEXT PEAK RIGHT

[Procedure and explanation]

Press .

Up to 256 peak level points are searched rightward from the current peak level point and their frequencies and levels are displayed. Others are the same as those of item (3) above.

(5) Executing NEXT PEAK LEFT

[Procedure and explanation]

Press .

Up to 256 peak level points are searched leftward from the current peak level point and their frequencies and levels are displayed. Others are the same as those of item (3) above.

(6) Executing NEXT PEAK MAX & MIN

[Procedure and explanation]

Press .

Up to 256 maximum and minimum peak level points are alternately searched from the left of the current waveform and their frequencies and levels are displayed. Others are the same as those of item (3) above.

(7) Executing MIN SEARCH

[Procedure and explanation]



The minimum level of the current waveform is searched, the marker (normal) is moves to this point, and its frequencies and level are displayed on the screen.

(8) Executing NEXT MIN

[Procedure and explanation]



Up to 256 lower level points are searched from the minimum point and their frequencies and levels are displayed. Others are the same as those of item (3) above.

CAUTION

The searched peak data becomes invalid when the PEAK search and MIN search keys are pressed or when the set data is changed. The subsequent NEXT PK (including other operations) is thus repeated from the beginning.
If no peak data exists or the next peak data does not exist, the error message below is displayed.

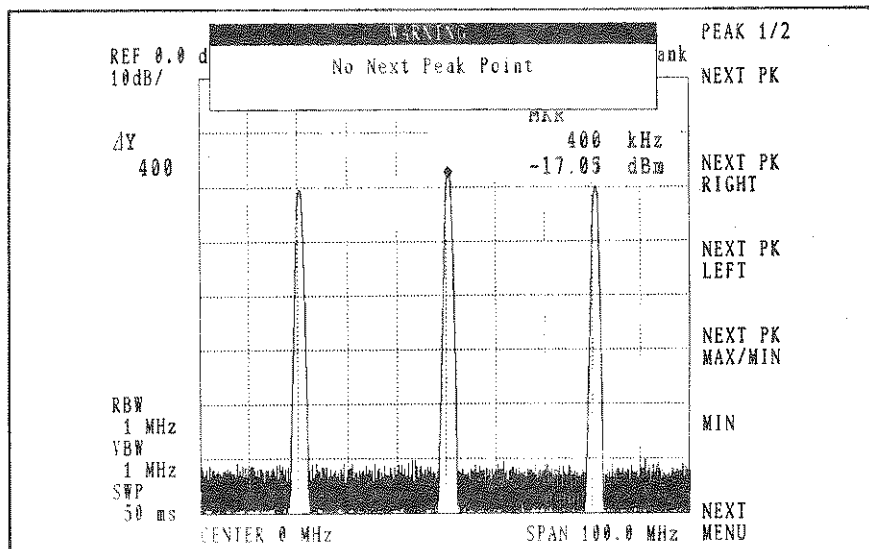

Figure 4 - 2 Error Message of Execution of NEXT PK

(9) Executing PK CONT

[Procedure and explanation]

Press PEAK NEXT MENU, and PK CONT ON/OFF is set to ON..

Starts continuous peak search. The peak of the waveforms is calculated for each sweep, and the marker can shift.

(10) Setting ΔX and ΔY

To search the peaks (maximum and minimum) or a waveform, set the point value indicating the inclination in the X and Y directions. Directions X and Y on the screen indicates the resolution shown in the figure below.

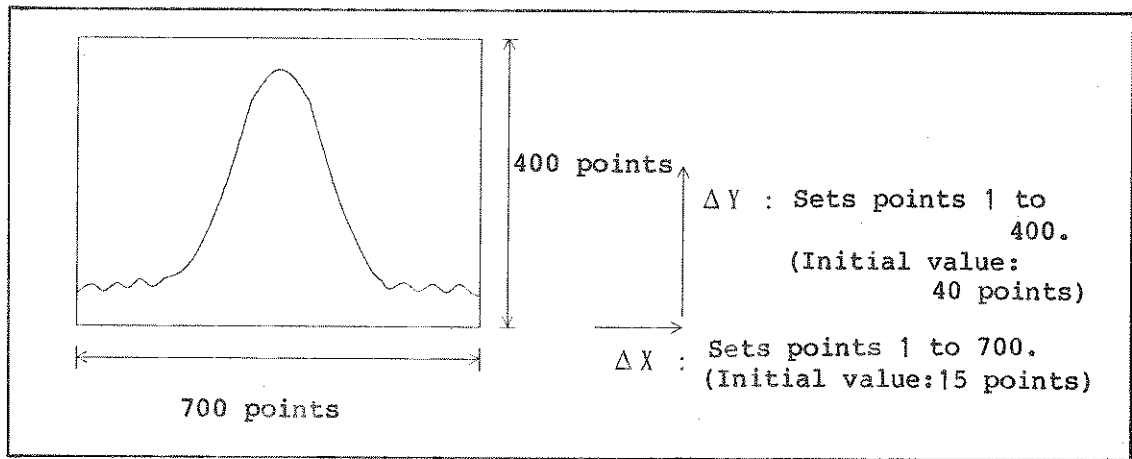

Figure 4 - 3 Resolution of ΔX and ΔY

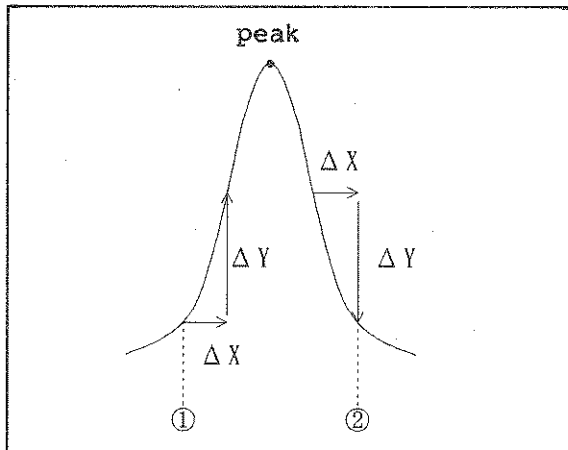

Figure 4 - 4 Setting of ΔX and ΔY

The point at which the waveform data at the tip of the ΔX point increases more than the ΔY point is defined as a rising edge (point ①).

The point at which the waveform data at the tip of the ΔX point decreases more than the ΔY point is defined as a falling edge (point ②).

The point where is a maximum value in the period of ① and ② is defined as peak.

(11) Alteration of peak search level

The reference level of the peak search can be altered using a display line.

[Procedure]

Press PEAK NEXT MENU and set the PK RANGE UP/FULL to UP.
 The level exceeding the display line is searched when the PK RANGE UP/FULL is set to UP. (Initial setting)

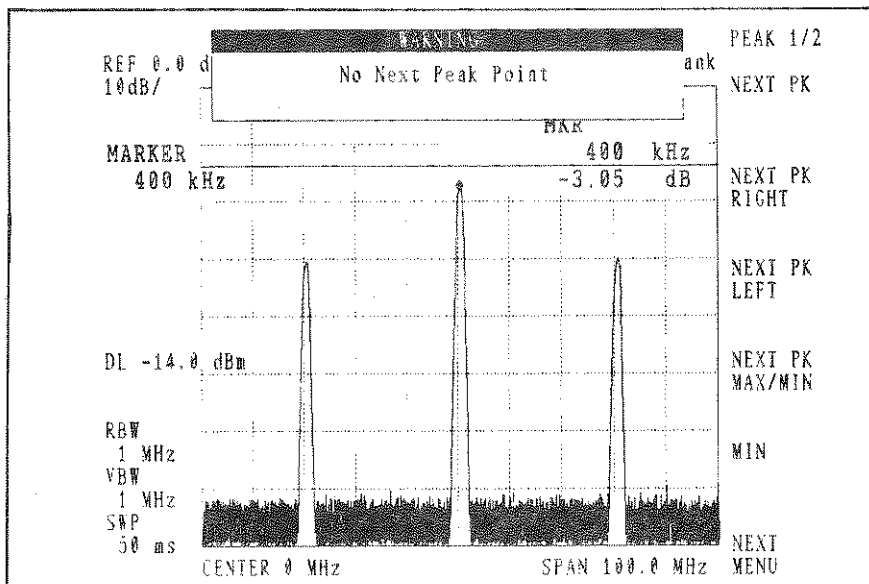

Figure 4 - 5 Execution of PK RANGE UP

R3261/3361
 SPECTRUM ANALYZER
 INSTRUCTION MANUAL

4.3 MARKER Section Functions

Press PEAK NEXT MENU and set the PK RANGE UP/FULL to FULL.

All the waveforms are searched irrespective of the display line when PK RANGE UP/FULL is set to FULL.

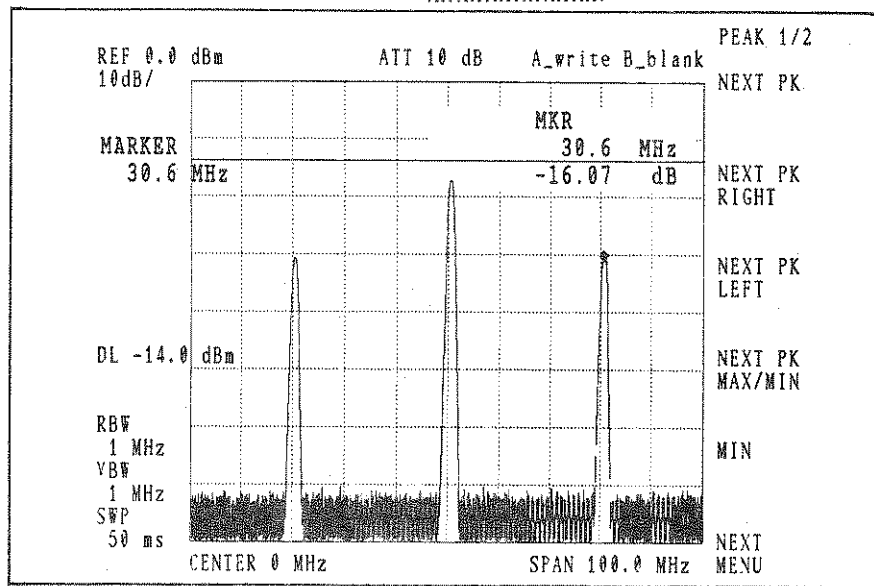

Figure 4 - 6 Execution of PK RANGE FULL

4.3.3 Marker →

[Functions]

The current marker data (frequency, level, Δ , etc.) is set as the data of another function.

(1) Panel Keys and the Corresponding Softkey Menu

Refer to Section A.1 (15).

(2) Execution of MKR →

[Procedure and explanation]

Press

MKR →

MKR → CF

 .

The active marker frequency is set as the center frequency.

Press

MKR →

MKR → REF

 .

The active marker level is set as the reference level.

Press

MKR →

MKR Δ → SPAN

 .

The Δ marker frequency is set as the frequency span.

Press

MKR →

MKR → CF STEP

 .

The active marker frequency is set as the CF STEP frequency.

Press

MKR →

MKR Δ → CF STEP

 .

The Δ marker frequency is set as the CF STEP frequency.

Press

MKR →

NEXT MENU

MKR → MK STEP

 .

The active marker frequency is set as the marker step frequency.

R3261/3361
SPECTRUM ANALYZER
INSTRUCTION MANUAL

4.3 MARKER Section Functions

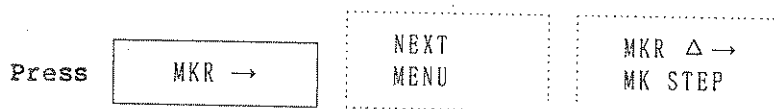

The Δ marker frequency is set as the marker step frequency.

(3) Setting the Marker Step Size

The marker step can be set within the range from 1Hz to 3600MHz. Initially, it is about 1/10 of the frequency span.

[Procedure and explanation]

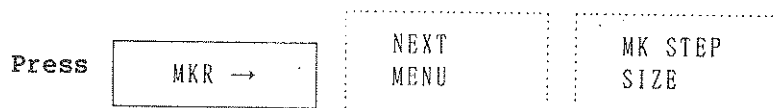

Marker step size set mode.
Data entry is enabled and data is displayed on the screen.



Marker frequency or marker frequency Δ set mode.
The marker step data is deleted from the screen.

[Data Adjusting Keys]

- Data knob : Turning this knob clockwise will raise the marker step size. Turning it counterclockwise will lower the center frequency. The setting resolution is about 1/1000 of the frequency span.

- Step key : Pressing this key once will raise or lower the center frequency step by step. When the step size is set to AUTO, the step width becomes 1/10 of the frequency span (one horizontal scale).

- Ten key : The setting resolution is determined according to the frequency span.

4.3.4 Multi-marker

[Function]

The multi-marker of R3261/3361 can display up to eight markers to trace A and B. This makes it possible to measure the frequency or level at many points simultaneously. This marker can be turned on and off independently. You can select whether the marker is displayed to trace A or B.

One of eight markers must be the active marker (the normal marker is displayed with o, while the active marker is displayed with ●).

The active marker can be moved optionally by numeric key, step key, and data knob.

When the multi-marker is on

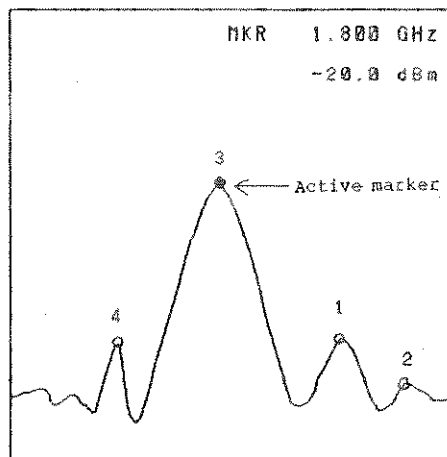

The R3261/3361 has a Δ marker in addition to the above eight markers. The Δ marker detects the difference between the Δ marker and active marker or among the other markers (during marker list display only) to display.

Basically, the Δ marker is displayed at the same position as the active marker. If the active marker, for example, is moved from trace A to B, the Δ marker also moves similarly.

Note: If the active marker is changed to another marker, the Δ marker may not move to the same position as the active marker.

The setting of multi-marker can be saved or recalled, so resetting for the same measurement is not required.

(1) Marker

① Single marker

The state where the active marker and Δ marker can be used is called single marker. All of traditional markers is a single marker.

② Multi-marker

The state where up to eight markers including the active marker and the Δ marker can be used is called multi-marker. For each marker, marker No. is displayed on the marker pattern.

③ Active marker

The active marker can be moved optionally by single marker and multi-marker. Data for active marker is displayed on the upper right or lower right of the screen. When the active marker is moved by multi-marker, it is displayed with \bullet and the other markers are displayed with \circ .

④ Δ marker

The Δ marker is displayed when the difference between the Δ marker and active marker is measured. When the Δ marker is on, it displays the difference between the Δ marker and active marker. When it is off, it is displayed by absolute value (an exception such as a counter is excluded).

⑤ Normal marker

When the Δ marker is off, the marker is called normal marker.

⑥ Active trace

Either trace A or B changing the trace state finally is called active trace.

Note: When the state of trace is blank, active trace is disabled.

(2) Panel Key

[Function]

Press the SHIFT and ON keys in order.

The multi-marker is turned on.

Press the ON key.

When the marker is OFF:

The single marker is turned on.

When the single marker is used:

The active marker can move.

When the multi-marker is used:

One of multi-markers is changed to the multi-marker and can move.

Press the OFF key.

Turn all markers off. If the multi-marker list is being displayed, the list is also erased.

Press the A or B key.

The active marker and Δ marker move between trace A and B. The other markers remains.



R3261/3361
 SPECTRUM ANALYZER
 INSTRUCTION MANUAL

4.3 MARKER Section Functions

(3) Soft Key

[Procedure and explanation]

<input type="checkbox"/> SHIFT <hr/> ON	MKR *		
	ON /OFF		
	MKR No.		
	ACTIVE MKR		
	MKR DISP ON /LOW		
	NEXT MENU	MKR LIST ON/ OFF	
		MKR LIST PLOT	PLOT OUT OVER
			PLOT OUT SEPARATE
			PLOT OUT ONLY
			PLOT CANCEL
			PREV MENU
		PREV MENU	

① Press the  and  keys to turn the  key on or off.

Turn each marker on or off to move.
An asterisk (*) indicates marker No.
For example, marker No. 1 is explained below.

. Active marker state



This key indicates that marker No. 1 is an active marker and can be moved. The marker can be moved using the numeric key, step key, and data knob.

If the key is pressed in this state, the marker is turned off. But, the final marker (except the Δ marker) cannot be turned off by this key.

. ON state

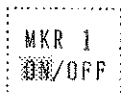

This key indicates that marker No. 1 is on. If the key is pressed in this state, the marker is changed to the active marker and can be moved.

. OFF state

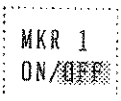

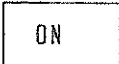
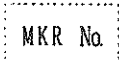

This key indicates that marker No. 1 is off. If the key is pressed in this state, marker No. 1 is turned on and is changed to the active marker. The marker can be moved. Marker No. 1 is displayed on the active trace waveform.

② Press the   and  keys in order.

Select multi-marker No. in order. Use the numeric key, step key, and data knob to select an arbitrary marker. If a numeric key is used for output, the unit key need not be pressed.

R3261/3361
SPECTRUM ANALYZER
INSTRUCTION MANUAL

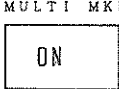

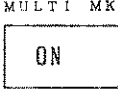
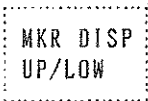

4.3 MARKER Section Functions

- ③ Press the   and  keys in order.

Select the active marker in order. Whenever this key is pressed, select the marker with a large number as an active marker. If there is no marker with a large number, select the marker with small number. The frequency and level of active marker are displayed on the screen. When this key is pressed, data for marker points can be measured simply.

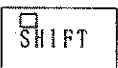
- ④ Press the   keys to set the  key to UP or LOW.

Select the marker to be displayed on the upper right or lower right of the screen. The initial value is displayed on the upper right. When the waveform and the marker are overlapped, press the key and relocate the marker to the lower right. Changed marker position is enabled when the plotter is output. It is not initialized for preset.

- ⑤ Press the   and  keys to turn on or off the  key.

Display all multi-marker lists. The window opens on the screen, and the frequencies and levels of up to eight markers are displayed in the window. Data for these markers is always an absolute value. The Δ marker mode displays the difference between the multi-marker and Δ marker.

While the list is displayed, sweep is stopped. Press the key other than the key related to list plot, the window is closed and displayed list is erased.



- ⑥ Press the     and  keys.

Plot the current state and marker list in the overwrite mode.

After plotting the waveform and data, overlap the marker lists in ruled line to plot.



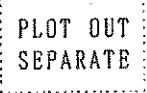

R3261/3361
SPECTRUM ANALYZER
INSTRUCTION MANUAL

4.3 MARKER Section Functions

- ⑦ Press the     and  keys.

Plot the current state and marker list in the division mode.

After plotting the waveform and data, plot the marker list to the next plot position.

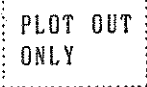
- ⑧ Press the     and  keys.

Plot the marker list only.

- ⑨ Press the     and  keys.

Interrupt plot.

- ⑩ Press the  key to return to the previous menu.

(4) Basic Operation

(4-1) Registering the Multi-marker

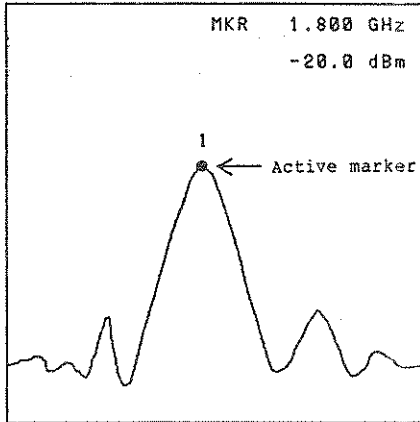

- (1) MKR 2
ON/OFF
- (2) MKR No.

At present, marker No. 1 is an active marker. When marker No. 2 is turned on where the active marker is, select marker No. 2 with soft menu (2) to press soft menu (1).

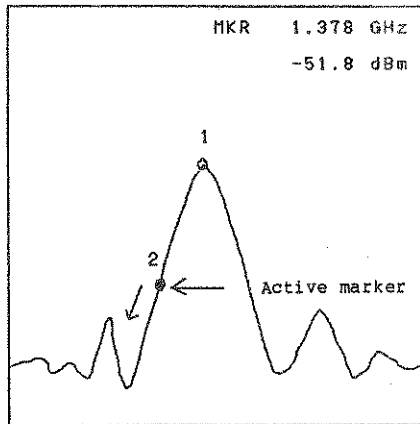

- (1) MKR 2
ON/OFF
- (2) MKR No.

Directly after the MKR 2 ON/OFF key is turned on, marker No. 2 is changed to the active marker. So, markers No. 1 and No. 2 are overlapped. The active marker can be moved as shown in figure.

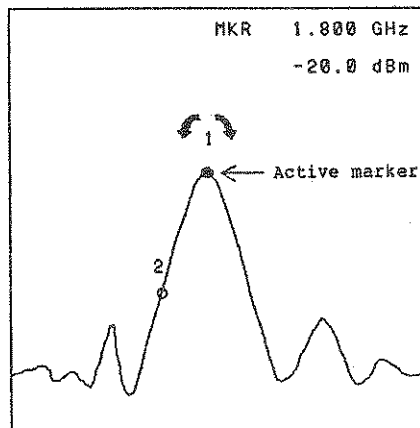

- (1) MKR 1
ON/OFF
- (2) MKR No.

When the active marker is returned from marker No. 2 to No. 1, press soft menu (2), select marker No. 1, press soft menu (1). As shown in figure, displayed data is changed. So, up to eight markers can be registered.

4.3 MARKER Section Functions

(4-2) Erasing the Marker

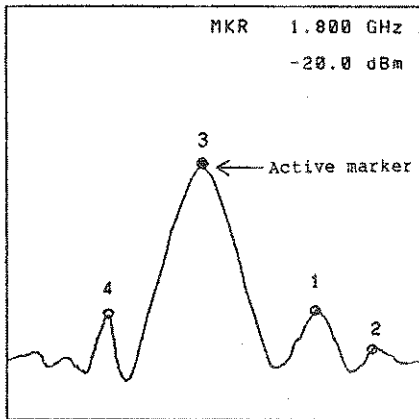

(1) ~~MKR 3~~
 ON/OFF

(2) MKR No.

When the multi-markers are erased one by one, use soft menu (2) to select the marker to be erased. If the marker is an active marker, press soft menu (1) to erase. If not, change the marker to the active marker to press soft menu (1).

In figure, marker No. 3 is the active marker. If this marker is erased, marker No. 4 is automatically changed to the active marker.

Note: It is only the marker changed to the active marker that can erase the multi-marker.

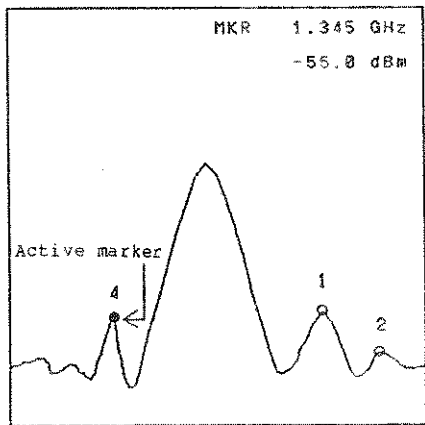

(1) ~~MKR 4~~
 ON/OFF

(2) MKR No.

If marker No. 3 is erased, marker No. 4 is automatically changed to the active marker.

If marker No. 4 is erased, marker No. 1 is automatically changed to the active marker.

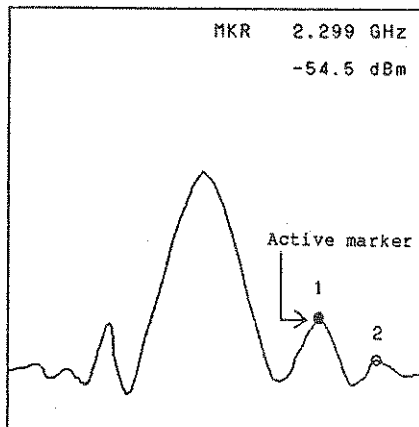

(1) ~~MKR 1~~
 ON/OFF

(2) MKR No.

As described above, there must be the active marker. If the active marker is erased, the next marker with a large number is the active marker. If there is no marker with a large number, the marker with a small number is the active marker.

If there is only one marker, it cannot be erased.

4.3 MARKER Section Functions

(4-3) Moving the Multi-marker

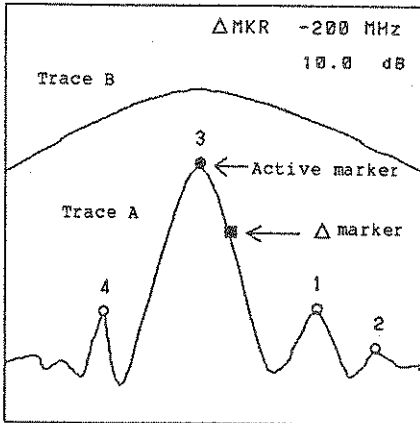

(1) MKR 3
ON/OFF

The multi-marker can be displayed to traces A and B.

When the multi-marker is moved between waveforms, press key A or B.

(2) MKR No

In figure, all markers are installed on A at present. When the B key is pressed, the active marker and Δ marker move to trace B.

The marker is always installed on the active trace.

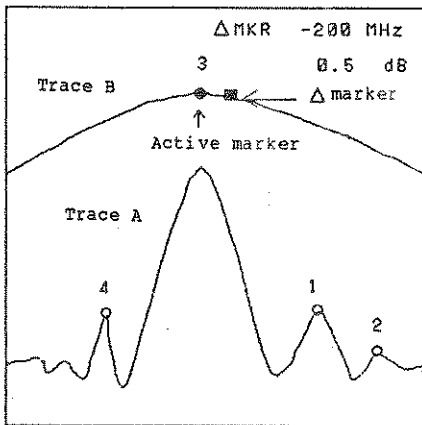

(1) MKR 5
ON/OFF

After marker No. 3 (that is, active marker) and Δ marker are moved to trace B,

select the marker by soft menu (2) and press soft menu (1) to install marker No. 5 on the active marker.

(2) MKR No

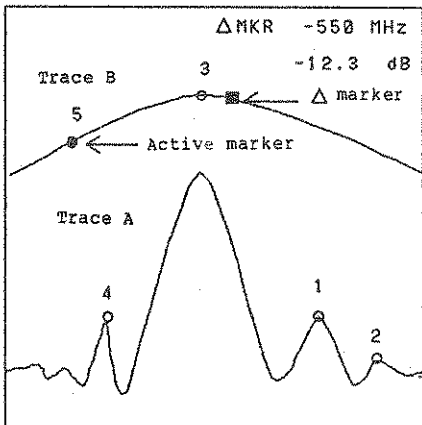

(1) MKR 5
ON/OFF

When the active marker is changed by soft menu (3), the difference between different waveforms can be measured easily.

(2) MKR No

(3) ACTIVE
MKR

(4-4) Changing the Active Marker

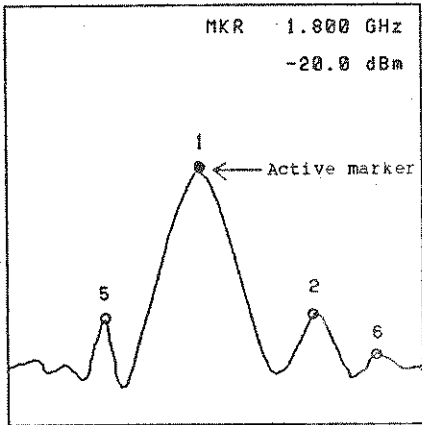

(1) MKR 1
 ON/OFF

Whenever soft menu (3) is pressed, the active marker is changed in order.

(2) MKR No

(3) ACTIVE
 MKR No

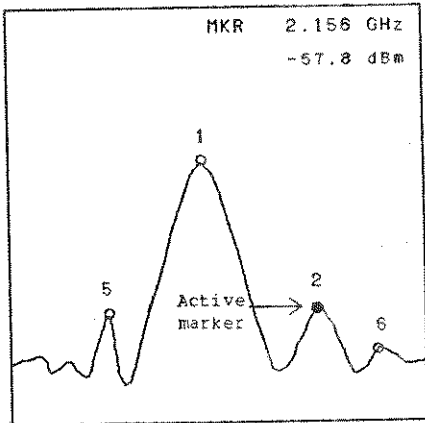

(1) MKR 2
 ON/OFF

The frequency and level of the active marker are displayed on the CRT. This function can measure data for marker points easily.

(2) MKR No

(3) ACTIVE
 MKR No

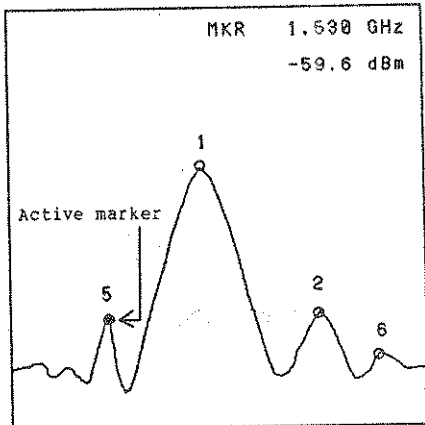

(1) MKR 5
 ON/OFF

When the active marker is changed, turned-on marker is automatically selected. In figure, marker No. 5 is changed to the active marker after marker No. 2.

(2) MKR No

(3) ACTIVE
 MKR No

(4-5) Multi-marker List

When soft menu (1) is turned on, the frequencies and levels of all markers are listed as follows.

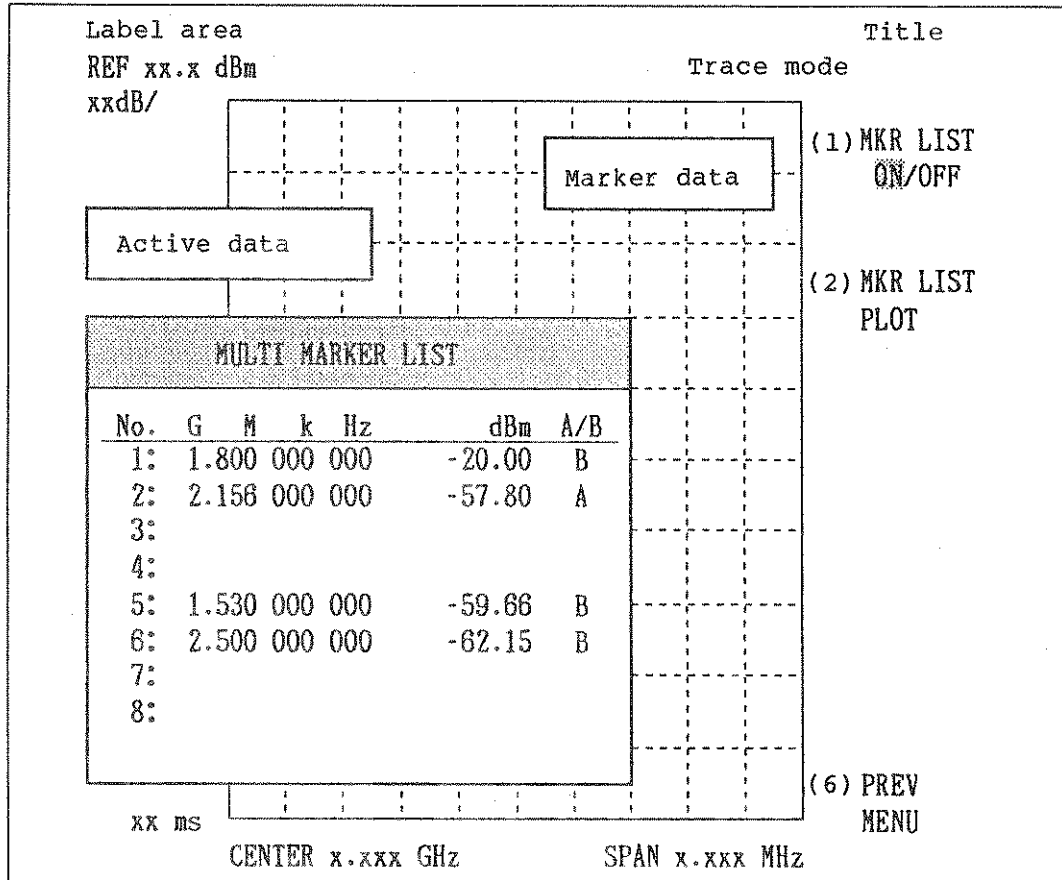

Data in list is converted from the marker position, and is not measured by frequency counter and in the noise level mode. So, the data is sometimes different from the marker data on the screen.

In the normal marker mode, each frequency and level are displayed by absolute value. In the marker mode, they are displayed by relative value.

Note: The Δ marker is displayed by absolute value.

The symbol of the last string in the list indicates the trace where each marker is installed. If the symbol is space, it is indicated that the state of trace is blank.

If other than the key for plot is pressed, displayed list is erased.

(4-6) Plotting the Marker List

When the multi-marker list is being displayed, it can be plotted. There are three types of output format. They can be selected optionally.

Output formats

- (1) Overlapping the waveform and list: See plot plan (1).
- (2) Separating the list from waveform: See plot plan (2).
- (3) Outputting the list only : See plot plan (3).

Unless the multi-marker list is displayed, the configuration of screen depends on the above output formats and list data is not plotted.

Press soft menu (2) in figure, the following soft menu appears. Select each output format.

Note: During plot, the key other than the cancel key is not acceptable.

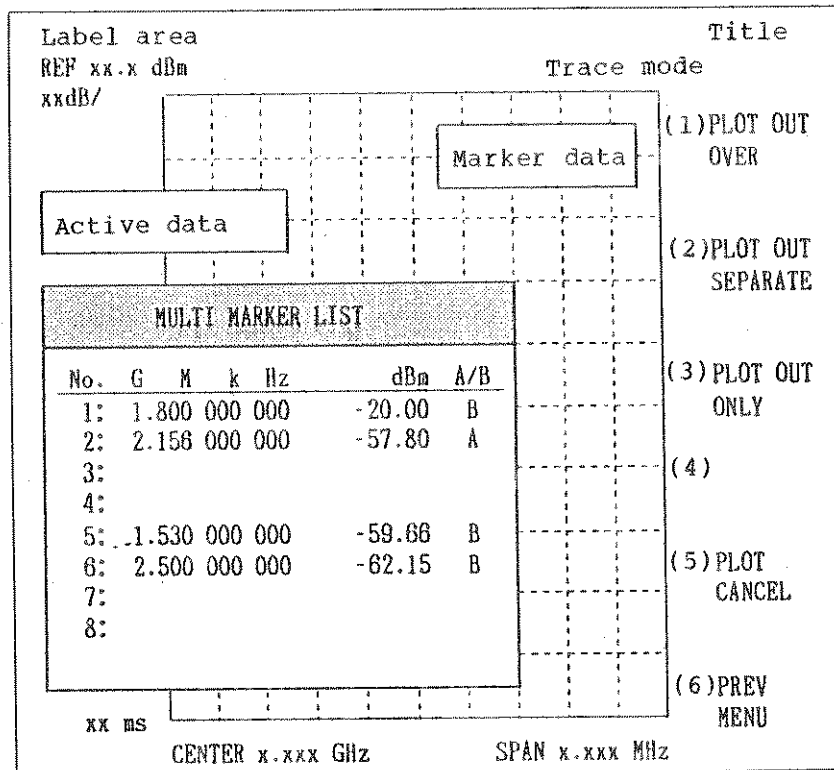

R3261/3361
SPECTRUM ANALYZER
INSTRUCTION MANUAL

4.3 MARKER Section Functions

After plotting ends, the soft menu (previous page) is redisplayed and any key is acceptable.

To interrupt plotting, press soft menu (5). Data transfer from the R3261/3361 to the plotter is interrupted. After plotting data that is already transferred to the plotter, end plotting and return to the soft menu (previous page). So, any key is acceptable.

For the setting of plotter, see Section 4.7 Plotting.

R3261/3361
 SPECTRUM ANALYZER
 INSTRUCTION MANUAL

4.3 MARKER Section Functions

Plot plan (1): Plotting in the overwrite mode

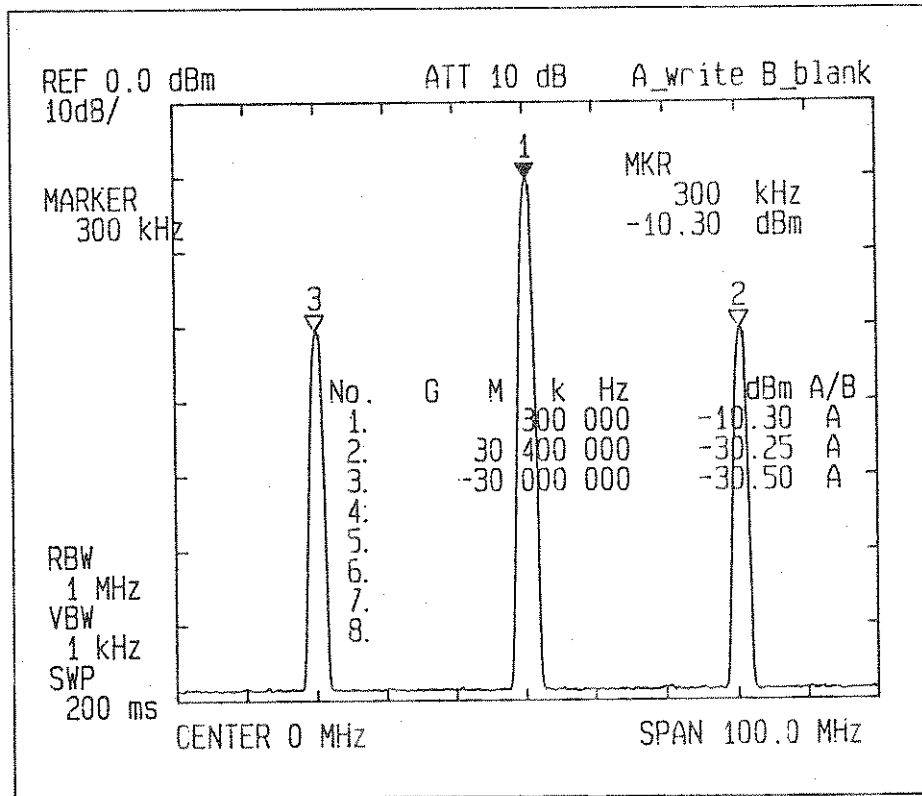

R3261/3361
 SPECTRUM ANALYZER
 INSTRUCTION MANUAL

4.3 MARKER Section Functions

Plot plan (2): Plotting to the R9833 plotter in the division mode under one division specification

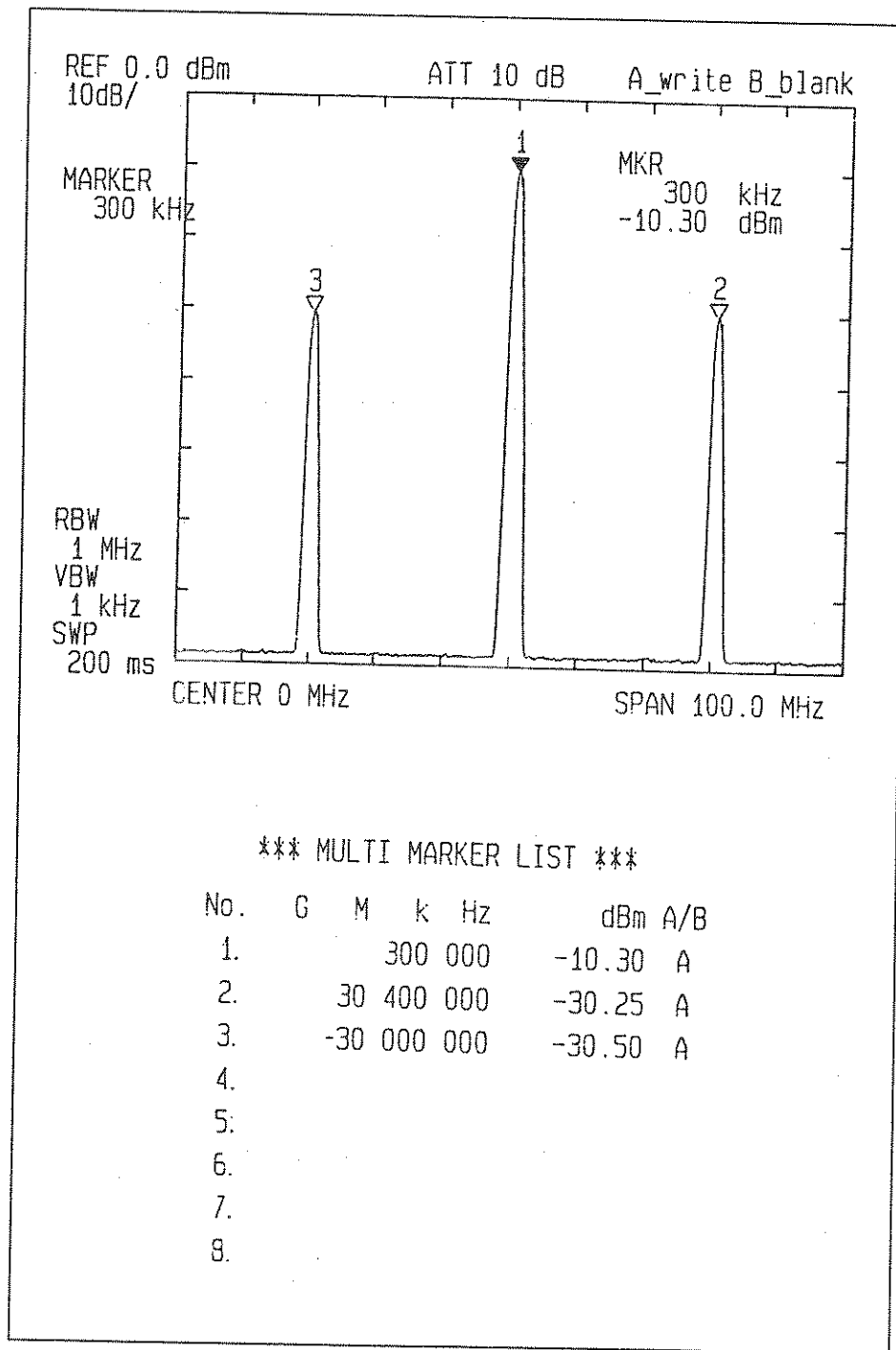

Plot plan (3): Plotting the list only

```
*** MULTI MARKER LIST ***
```

No.	G	M	k	Hz	dBm	A/B
1.			300	000	-10.30	A
2.		30	400	000	-30.25	A
3.		-30	000	000	-30.50	A
4.						
5.						
6.						
7.						
8.						

R3261/3361
SPECTRUM ANALYZER
INSTRUCTION MANUAL

4.3 MARKER Section Functions

(5) GPIB Remote Programming

(5-1) GPIB Code

Table 4 - 1 GPIB Code

Function	Listener code	Talker request			Remarks
		Code	Output format	Header	
Multi-marker ON	MLT	MLT?	ON/OFF	-	
Multi-marker OFF	MF or MO	-	-	-	
Moving the Active-marker	MN or MK	-	-	-	Data input
Multi-marker No. 1 ON	MLN1	-	-	-	Data input
Multi-marker No. 1 OFF	MLF1	-	-	-	
Multi-marker No. 2 ON	MLN2	-	-	-	Data input
Multi-marker No. 2 OFF	MLF2	-	-	-	
Multi-marker No. 3 ON	MLN3	-	-	-	Data input
Multi-marker No. 3 OFF	MLF3	-	-	-	
Multi-marker No. 4 ON	MLN4	-	-	-	Data input
Multi-marker No. 4 OFF	MLF4	-	-	-	
Multi-marker No. 5 ON	MLN5	-	-	-	Data input
Multi-marker No. 5 OFF	MLF5	-	-	-	
Multi-marker No. 6 ON	MLN6	-	-	-	Data input
Multi-marker No. 6 OFF	MLF6	-	-	-	
Multi-marker No. 7 ON	MLN7	-	-	-	Data input
Multi-marker No. 7 OFF	MLF7	-	-	-	
Multi-marker No. 8 ON	MLN8	-	-	-	Data input
Multi-marker No. 8 OFF	MLF8	-	-	-	
Active marker frequency?	-	MF?	Frequency	MF	
Active marker level?	-	ML?	Level	Unit: Header	
				dB : MLD	
				dBm : MLB	
				dBmV: MLM	
				dBμV: MLU	
				dBμVemf	
				: MLE	
				dBpW: MLW	
				V : MLV	
				dBm/Hz	
				: MLH	
				dBμV/√Hz	
				: MLL	

Table 4 - 1 GPIB Code (Cont'd)

Function	Listener code	Talker request			Remarks
		Code	Output format	Header	
Frequency + level?	-	MFL?	Frequency + level	Similar to MF and ML	8-marker output 8-marker output
All multi-marker frequencies?	-	MLSF?	Frequency	Similar to MF	
All multi-marker levels?	-	MLSL?	Level	Similar to ML	

For the code other than the multi-marker code, see Chapter 6 GPIB Remote Programming.

(5-2) GPIB Command

(a) Turning the multi-marker on or off

[Format]

```

PRINT @8;"MLT"          ..... (1)  ' Turns the multi-marker on.
PRINT @8;"MLT 1GZ"     ..... (2)  ' Turns the multi-marker on and
                                move it to 1GHz.

PRINT @8;"MF"          ..... (3)  ' Turns the multi-marker off.
PRINT @8;"MO"          ..... (4)  ' Turns the multi-marker off.

PRINT @8;"MLT?"       ..... (5)  ' Outputs the state of multi-marker.
INPUT @8;ISMLT

```

[Function]

This command turns the multi-marker on or off. When the marker is off or the single marker is used, execute (1). The multi-marker is turned on, and one of up to eight markers is changed to the active marker, then it can move freely. The frequency and level of the active marker are displayed on the screen.

If (2) is executed similarly, the multi-marker is turned on and the active marker is moved to the position equivalent to specified frequency. If the output format is (2), the active marker is moved to the position equivalent to frequency of 1GHz.

If (3) and (4) are executed, the single marker and multi-marker erase all of displayed markers.

R3261/3361
SPECTRUM ANALYZER
INSTRUCTION MANUAL

4.3 MARKER Section Functions

Note: The multi-marker can turn off the markers individually, but this command erases all markers. If (1) and (2) are re-executed, the marker is recovered.

To see the present state of the multi-marker, execute (5). When the multi-marker is on, 1 is output. If it is off, 0 is output. Judge these values.

(b) Turning the markers on or off individually

[Format]

```
PRINT @8;"MLN1"      ..... (1)  ' Turns multi-marker No. 1 on.
PRINT @8;"MLN1 1GZ"  ..... (2)  ' Turns multi-marker No. 1 on and
                               move it to 1GHz.

PRINT @8;"MLF5"      ..... (3)  ' Turns multi-marker No. 5 off.
```

[Function]

The command turns the markers on or off individually. The number at the end of the command indicates marker No. If (1) is executed, marker No. 1 is turned on and is changed to the active marker. So, the marker can move freely.

If (2) is executed similarly, marker No. 1 is turned on and is moved to the position equivalent to specified frequency. If the output format is (2), frequency moves marker No. 1 to the position equivalent to 1GHz.

If (3) is executed, marker No. 5 is erased. The marker can be erased by the active marker only. After specified marker is changed to the active marker once, erase the marker. So, the active marker is automatically changed to the next marker with a large number. Even if marker No. 5 is not an active marker, execute (3) and erase the marker. The active marker is automatically changed.

- (c) Outputting the frequencies and levels of markers individually

[Format]

[Format]

```
PRINT @8;"HDO MLN1 MF?" .. (1) ' Turns marker No. 1 on to output
                                the frequency.
INPUT @8;F1                      ' Reads the frequency to variable
                                F1.

PRINT @8;"MLN5 1GZ" ..... (2) ' Turns on multi-marker No. 5 to
PRINT @8;"HDO ML?"           frequency of 1GHz to output the
                                level.
INPUT @8;L5                     ' Reads the level to variable L5.
```

[Function]

The command outputs the frequencies and levels of markers individually. To read data, be sure to change the marker to the active marker. As described above, change the marker to be read to the active marker, then read the value of the active marker.

If (1) is executed, marker No. 1 is changed to the active marker and the frequency is read to variable F1.

If (2) is executed similarly, marker No. 5 is moved to the position equivalent to specified frequency and the level is read to variable L5.

When the markers are read individually, the active marker is read actually and there is no difference between the single marker and multi-marker. When the multi-markers are read together, the values measured by counter and noise level cannot be read. Because the marker point is read by converted value.

R3261/3361
SPECTRUM ANALYZER
INSTRUCTION MANUAL

4.3 MARKER Section Functions

(d) Outputting the frequencies and levels of all markers together

[Format]

```
PRINT @8;"MLSF?"          ..... (1)  ' Outputs the frequencies of
                                all markers.
INPUT @8;F1,F2,F3,F4,F5,F6,F7,F8,F9  ' Reads the frequency to the
                                variable.

PRINT @8;"MLN5 1GZ"      ..... (2)  ' Outputs all marker levels.
INPUT @8;L1,L2,L3,L4,L5,L6,L7,L8,L9  ' Reads the level to the
                                variable.
```

[Function]

The command outputs the frequencies and levels of all markers together. A total of nine pieces of data containing eight multi-markers and marker can be output regardless of displayed list on the screen.

Turned off data outputs zero to the frequency and level. When the markers are read individually, the active marker is read actually. There is no difference between the single marker and multi-marker. When the multi-markers are read together, the value measured by counter or noise level cannot be read. Because the marker point is read by converted value.

R3261/3361
SPECTRUM ANALYZER
INSTRUCTION MANUAL

4.3 MARKER Section Functions

[Sample program]

MLSF command

```
10 '*****
20 '* R3261/3361 MULTI marker list check *
30 '* file: MLTLIST *
40 '*****
50 ISET IFC: ISET REN
60 *TEST
70 'GOSUB *SWEEP
80 GOSUB *STROUT ' string output
90 GOSUB *VALOUT ' value output
100 'GOTO *TEST
110 STOP
120 '
130 *STROUT
140 PRINT @8;"HD1 MLSF?"
150 INPUT @8;F1$,F2$,F3$,F4$,F5$,F6$,F7$,F8$,F9$
160 PRINT @8;"MLSL?"
170 INPUT @8;L1$,L2$,L3$,L4$,L5$,L6$,L7$,L8$,L9$
180 PRINT "***** STR out *****"
190 PRINT 1,F1$,L1$: PRINT 2,F2$,L2$: PRINT 3,F3$,L3$: PRINT 4,F4$,L4$
200 PRINT 5,F5$,L5$: PRINT 6,F6$,L6$: PRINT 7,F7$,L7$: PRINT 8,F8$,L8$
210 PRINT 9,F9$,L9$: PRINT ""
220 RETURN
230 '
240 *VALOUT
250 PRINT @8;"HDO MLSF?"
260 INPUT @8;F1,F2,F3,F4,F5,F6,F7,F8,F9
270 PRINT @8;"MLSL?"
280 INPUT @8;L1,L2,L3,L4,L5,L6,L7,L8,L9
290 PRINT "***** VAL out *****"
300 PRINT 1,F1,L1: PRINT 2,F2,L2: PRINT 3,F3,L3: PRINT 4,F4,L4
310 PRINT 5,F5,L5: PRINT 6,F6,L6: PRINT 7,F7,L7: PRINT 8,F8,L8
320 PRINT 9,F9,L9: PRINT ""
330 RETURN
340 '
350 *SWEEP
360 PRINT @8;"S2"
370 PRINT @8;"S1"
380 POLL 8,S
390 IF (S AND 4)=0 THEN GOTO 380
400 RETURN
```

R3261/3361
 SPECTRUM ANALYZER
 INSTRUCTION MANUAL

4.3 MARKER Section Functions

[Result of output]

When the Δ marker is off

```

***** STR out *****
1      MF  0000000100.0E+6      MLB -00090.47E+0
2      MF  0000000200.0E+6      MLB -00090.75E+0
3      MF  0000000300.0E+6      MLB -00088.42E+0
4      MF  0000000400.0E+6      MLB -00075.62E+0
5      MF  0000000500.0E+6      MLB -00073.90E+0
6      MF  0000000600.0E+6      MLB -00089.57E+0
7      0      0
8      0      0
9      0      0

***** UAL out *****
1      1E+08      -90.47
2      2E+08      -90.75
3      3E+08      -88.42
4      4E+08      -75.62
5      5E+08      -73.9
6      6E+08      -89.57
7      0      0
8      0      0
9      0      0

Ok

load  auto  go to  list  run  save  key  print  edit  cont
  
```

When the Δ marker is on

```

***** STR out *****
1      MF -0000000250.0E+6      MLD -00000.87E+0
2      MF -0000000150.0E+6      MLD -00001.15E+0
3      MF -0000000050.0E+6      MLD 00001.17E+0
4      MF 0000000050.0E+6      MLD 00013.97E+0
5      MF 0000000150.0E+6      MLD 00015.70E+0
6      MF 0000000250.0E+6      MLD 00000.02E+0
7      0      0
8      0      0
9      MF 0000000350.0E+6      MLD -00089.60E+0

***** UAL out *****
1      -2.5E+08      -.87
2      -1.5E+08      -1.15
3      -5E+07      1.17
4      5E+07      13.97
5      1.5E+08      15.7
6      2.5E+08      .02
7      0      0
8      0      0
9      3.5E+08      -89.6

Ok

load  auto  go to  list  run  save  key  print  edit  cont
  
```

(6) Cautions

① Difference between the single marker and multi-marker.

There is several differences between the specification of processing for single marker and that of processing for multi-marker.

● Upper and lower limit for the next peak

When the single marker turns on the display line or window, the upper display line or the upper/lower limit of window is executed as effective vertical axis data. The multi-marker enables every vertical axis data to execute.

● List display for multi-marker and batch output by GPIB

When the active marker is displayed for single marker and multi-marker and is output by GPIB, data operated for counter measurement or noise level measurement can be displayed and output. When the lists are displayed for multi-marker and are output together, the marker point can be displayed and output by converted value only. So, the value measured by counter or noise level cannot be displayed and output. When the display line is on, the value converted by the marker point is displayed and output.

② Supporting the user define function

The soft menu of multi-marker cannot be moved to the other menu by user define function. To the contrary, the other menu cannot be moved to the soft menu of the multi-marker.

4.4 Save and Recall Functions

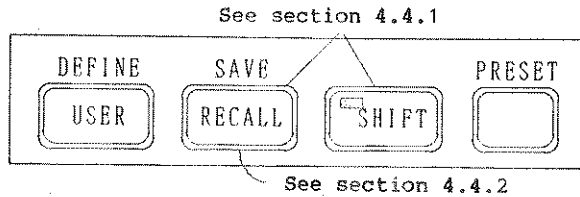

4.4.1 Save Function

[Function]

The current set conditions are stored in the internal memory or memory card.

(1) Panel Keys and the Corresponding Softkey Menu

Refer to Section A.1 (10).

(2) Specifying a Channel

① Internal Memory

A channel, 0 to 9, may be specified. Channel 0 is for recall-on-power, channels 1 and 2 are for set condition and waveform data, and channels 3 to 9 are for set condition.

Specify a channel directly with the numeric keys, or indirectly with the data knob or step key.

For the specified channel, → is displayed on the list.

② Memory Card

Any channel from 10 onward may be specified. The number of channels depends on the relationship between the memory card capacity and how much data is saved.

Specify the channel directly with the numeric keys, or indirectly with the data knob or step key.

(3) Saving

After specifying a channel as mentioned above, the current set condition and waveform data are saved in the specified channel.

R3261/3361
SPECTRUM ANALYZER
INSTRUCTION MANUAL

4.4 Save and Recall Functions

[Procedure and explanation]

Press SHIFT RECALL .

Displays the currently saved file status. The channel number, title (header), and write-protection are listed for each channel. The saved channel information is displayed in the reverse mode.

Press SHIFT RECALL SAVE EXECUTE .

If a numeric key has already been input, it is judged as a channel number and data is saved in this channel. If it has not been input, data is saved on the channel pointed by → on the list.

Press SHIFT RECALL SAVE TITLE .

When saving data, a title can be input with up to 30 characters. The input method is the same as that for the label function. (See Section 4.8.)

Press SHIFT RECALL WRITE PROTECT .

Data write into the specified is inhibited so that the previously saved information is not deleted or overwritten by mistake.

For the protected channel, ON is displayed at the end of the displayed list.

To cancel write protection, press this key again. (This key is effective for the internal memory.)

Press SHIFT RECALL , and TRACE A/B is set to A or B.

Select the waveform data to be saved. Pressing this memory will select memories A and B alternately. (This key is effective only when saving waveform data to internal memory, channel 1 or channel 2.)

(4) Saving into Memory Card

Setting conditions, waveform data, antenna correction coefficient or limit line data can be saved into the memory card.

Saving Method

① Saving Trace Data (The waveform data)

To save the trace data into the memory card, set the softkey mode of the TRACE section to VIEW mode.

If not saving the data, set to BLANK mode.

② Saving Normalize Data

To save the normalize data into the memory card, switch on the softkey NORMALIZE mode of the TRACE section.

If NORMALIZE mode is OFF, saving cannot be made.

③ Saving Limit Line Data , Antenna Correction Coefficient or Marker

To save the limit line data, antenna correction coefficient, or marker, switch on the softkey mode of each section.

If softkey mode is OFF, saving cannot be made.

④ Saving User Defined Key

To save the user defined key, press the softkey MENU STORE of memory card section. (Refer to subsection 4.9.7.)

CAUTION

If new datas are stored, the previous data such as set conditions in the channel will be erased.

To protect the stored datas, turn on the WRITE PROTECT switch of the memory card.

R3261/3361
SPECTRUM ANALYZER
INSTRUCTION MANUAL

4.4 Save and Recall Functions

4.4.2 Recall Function

[Function]

The data (set condition and waveform) saved in the internal memory or memory card is called for restoration.

(1) Panel Keys and the Corresponding Softkey Menu

Refer to Section A.1 (11).

(2) Specifying a Channel

① Internal Memory

A channel, 0 to 9, may be specified. Channel 0 is for call-on-power, channels 1 and 2 are for set condition and waveform data, and channels 3 to 9 are for set condition.

Specify a channel with a numeric key directly or with the data knob or step key indirectly.
For the specified channel, → is displayed on the list.

② Memory Card

A channel, 10 and on, may be specified. The channel number depends on the relationship between the memory card capacity and data save state.

Specify a channel with a numeric key directly or with the data knob or step key indirectly.

CAUTION

If the waveform is recalled from internal memory, A memory is firstly recalled.

(3) Displaying the List

[Procedure and explanation]

Press RECALL .

The currently saved information such as channel number, title, data combination, and write enabled/inhibited state are displayed within the window for each channel.

The channel number corresponding to the channel in which data is saved is displayed in the reserve mode. If no title has been input, the first 30 characters in the label line are displayed as a title.

Display the currently saved file status for each channel.

(4) Recalling

After specifying a channel as mentioned above, the data saved in this channel is called and restored.

[Procedure and explanation]

Press RECALL RECALL EXECUTE .

If a numeric key has already been input, it is judged as a channel number and data is restored in this channel. If it has not been input, the channel pointed by → on the list is recalled.

RECALL		
CHANNEL :	9	
TITLE :	test data	
PROTECT :	OFF	
CHANNEL	TITLE	PROTECT
0	recall on power !!	OFF
1	for Antenna !!	OFF
2		OFF
3	for EMC !!	ON
→ 9	test data	OFF

(5) High-speed/Normal RECALL Mode

In the normal mode, the user can check the list displayed in the window, specify the desired channel, and can recall data by pressing

RECALL
 EXECUTE

In the high-speed mode, no list is displayed in the window and the

user need not press RECALL EXECUTE . When the numeric key is pressed, the data is recalled from memory.

Note: The high-speed mode is valid for internal memory only.
 Therefore, data cannot be recalled from the memory card even if the memory card is inserted.

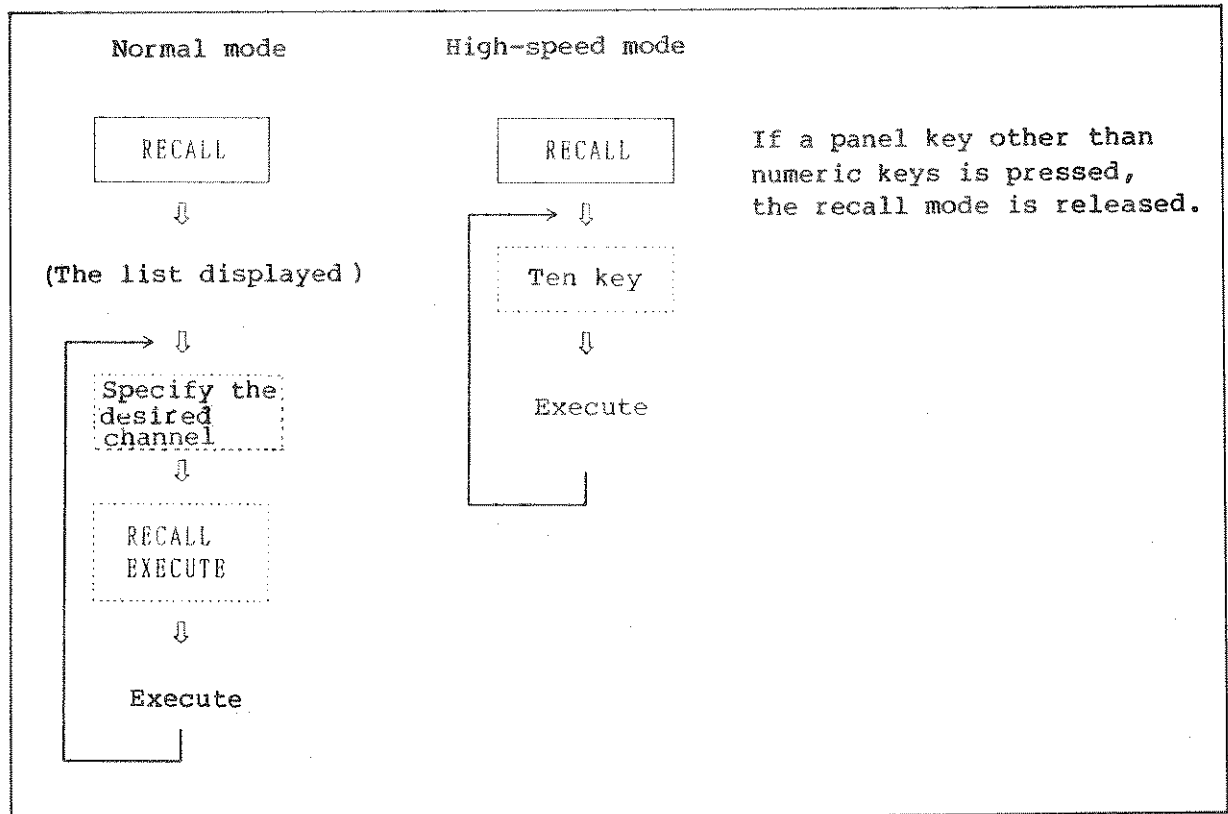

4.5 User-Defined Function

[Function]

The order of the softkey menus corresponding to the function keys can be changed around so that the user can get to the most frequency used menu without pressing the same key many times.

(1) Panel Keys and the Corresponding Softkey Menu

Refer to Section A.1 (12).

(2) Changing Softkey Menus

Press SHIFT USER . The following display will appear:

On this screen, up to six soft menus (K1 through K6) can be selected as the user-defined function (Other soft menus can be modified.) If more than one pattern are required, save the data in the memory card.

(Only one set of data (soft menu (K1 through K6) and other soft menus) can be saved in one memory card.)

(Refer to subsection 4.9.7.)

```

*** R3261/3361 Soft Menu Change Mode ***      MENU CHG
GROUP USER                                     GROUP
K1 :                                           ACTIVE
K2 :
K3 :
K4 :                                           MEMBER
K5 :                                           ACTIVE
→ K6 :

GROUP                                           ENTER
/*** Center ***/
→ 1 : Step Size of Center
   2 : Step Size is auto
   3 : Offset of Center
   4 : +/- (offset's sign)                       INITIAL
                                                MEMBER
/*** Span ***/
1 : Linear Span                                ALL
2 : Full Span                                  INITIAL
3 : Log Span
4 : Zero Span                                  RETURN
  
```

①

②

[Explanation of the Above Screen]

- ① The upper half of this screen displays the current assignment of softkey menus. This is called a softkey menu group.
- ② The lower half of this screen displays the contents (functions) of each softkey menu group. This is called a softkey menu member.

[Procedure and explanation]

Find the softkey menu group to be changed and select its member.

Press

SHIFT

USER

GROUP ACTIVE

 .

Press the panel key or the step key to select the desired softkey menu group. The member to be exchanged can be searched by turning the data knob. An arrow is displayed on the left of the member to be exchanged.

Press

SHIFT

USER

MEMBER ACTIVE

 .

Select a softkey member to be incorporated. To select a softkey member, find the corresponding group by pressing the panel key or step key. Then turn the data knob to find the member to be incorporated. When the data knob is turned continuously, the screen is scrolled so that the desired member can be searched easily.

Press

SHIFT

USER

ENTER

 .

After the member to be exchanged is selected, press this key. If the softkey menu number (K1, K2, ...) is displayed in the reverse mode, members cannot be exchanged.

Press

SHIFT

USER

INITIAL MEMBER

 .

Initial members are displayed on the soft group display screen.

R3261/3361
SPECTRUM ANALYZER
INSTRUCTION MANUAL

4.5 User-Defined Function

Press SHIFT USER ALL
INITIAL

All the changed members are replaced with the initial members.

Press SHIFT USER RETURN

This mode is canceled and the previous soft groups are restored.

CAUTION

The new menu setting is held after the power is turned off. Save the new menu setting in the memory card, if necessary, and initialize before using the GPIB remote controller.

4.6 Calibration Function

[Function]

This device can improve measuring accuracy by running the calibration function and correcting the obtained calibration factor at the time of real measurement.

The following items can be measured with the calibration function:

- Absolute errors in 300kHz resolution bandwidth, -20dBm internal reference oscillator and 1dB/DIV
- IF filter switching level error in 30Hz to 1MHz resolution bandwidth
- Vertical axis linearity on the screen at LOG 10dB/DIV, 5dB/DIV, 2dB/DIV, and 1dB/DIV
- Switching error in IF STEP AMP
- Switching error in the input attenuator
- TG frequency errors in 30Hz to 1kHz RBW

(1) Panel Keys and the Corresponding Softkey Menu

Refer to Section A.1 (16).

[Procedure and explanation]

Press SHIFT 7 CAL ALL .

Measure all calibration items. Becomes error correction mode after the calibration is completed.

Press SHIFT 7 TOTAL GAIN .

Measure the absolute error in 300kHz resolution bandwidth, -20dBm internal reference oscillator, and 1dB/DIV.

Press SHIFT 7 EACH ITEM .

EACH ITEM mode.

R3261/3361
SPECTRUM ANALYZER
INSTRUCTION MANUAL

4.6 Calibration Function

Press SHIFT 7 EACH ITEM INPUT ATT

Measure the switching error in input attenuator.

Press SHIFT 7 EACH ITEM IF STEP AMPTD

Measure the switching error in IF STEP AMP.

Press SHIFT 7 EACH ITEM RBW SWITCH

Measure the switching level error of IF filter of resolution bandwidth in 30Hz to 1MHz.

Press SHIFT 7 EACH ITEM LOG LINEAR

Measure vertical axis linearity on the screen at LOG 10dB/DIV, 5dB/DIV, 2dB/DIV and 1dB/DIV.

Press SHIFT 7 EACH ITEM AMPTD MAG

Measure the switching error in LOG 10dB/DIV, 5dB/DIV, 2dB/DIV and 1dB/DIV.

Press SHIFT 7 EACH ITEM TG TRACKING

Note: R3361C/D only

Measure level error caused from the difference between the output frequency of the tracking generator at PBW 30Hz to 1kHz and synchronized frequency of the spectrum analyzer.

Press SHIFT 7 , and CAL SIG ON/OFF is set to ON or OFF.

Connect internally the internal basic transmitter (30MHz, -20dBm to -30dBm) with the input circuit. At this time, the signal level can be set at -20dBm to -30dBm (0.5dB steps) using either the ten-keys, data knob or step keys.

R3261/3361
SPECTRUM ANALYZER
INSTRUCTION MANUAL

4.6 Calibration Function

Press SHIFT 7 , and FRQ CORR ON/OFF is set to ON or OFF.

The frequency characteristics measured at the factory are stored in the analyzer and it is shipped. When the analyzer is used in the field, its frequency characteristics are corrected if necessary for on. The frequency characteristics are turned on and off

if FRQ CORR ON/OFF is pressed.

Press SHIFT 7 , and CAL CORR ON/OFF is set to ON or OFF.

Uses (ON) or does not use (OFF) the calibration factor which has been obtained during calibration. The ON

and OFF state are switched whenever CAL CORR ON/OFF is pressed.

CAUTION

Start the calibration function only after the specified time of warm-up.

4.7 Plot Output Function

[Function]

Set the necessary condition to output to the Plotter before being output.

(1) Panel Keys and the Corresponding Softkey Menu

Refer to Section A.1 (17).

(2) Setting the Plotter Output Conditions

Carry out effectively the operations to set various conditions for plotter output utilizing the window screen.

[Procedure and explanation]

Press SHIFT 8 .

The following instruction appears on the window screen; set the conditions according to this instruction.

PLOT	
TYPE	: R9833
MODE	: ALL
PAPER	: A4
DIV	: 2 PICTURE
PEN	: 6 PENS
LOCATE	: LEFT
PEN	
1 PEN	
2 PENS	
4 PENS	
→ 6 PENS	

Press SHIFT 8 PLOTTER TYPE .

Specifies plotter type. Types of plotters available are shown as follows:

- (1) TR9832
- (2) R9833
- (3) HP7470
- (4) HP7440
- (5) HP7475
- (6) HP7550

R3261/3361
SPECTRUM ANALYZER
INSTRUCTION MANUAL

4.7 Plot Output Function

Press SHIFT 8 PLOT
MODE .

Specifies mode of plotter. Modes that can be selected are as follows:

- (1) Waveform, grid, all character data
- (2) Only waveform
- (3) Only character data
- (4) Only grid

Press SHIFT 8 PLOT
FORM PAPER
SIZE .

Specifies the size of paper. Sizes of selectable paper are as follows:

- (1) A4
- (2) A3

Press SHIFT 8 PLOT
FORM PLOT
DIVISION .

Specifies the size of the screen divisions. Sizes of the screen divisions are as follows:

- (1) Single
- (2) Divided into two sections, left and right
- (3) Divided into four-left, right, upper and lower.

Press SHIFT 8 PLOT
FORM LOCATION .

Specifies the output screen. Selectable locations are as follows:

- | | |
|-----------------|--------------------------|
| (1) Left side | } When divided into two |
| (2) Right side | |
| (1) Upper left | } When divided into four |
| (2) Upper right | |
| (3) Lower left | |
| (4) Lower right | |

Press SHIFT 8 PLOT
FORM PEN .

Specifies the number of pens. The number of selectable pens are shown as follows:

- (1) One
- (2) Two
- (3) Four
- (4) Six

R3261/3361
SPECTRUM ANALYZER
INSTRUCTION MANUAL

4.7 Plot Output Function

Press SHIFT 8 PLOT FORM, and PLOT AUTO/MNL is set to AUTO or MNL.

Specifies whether all the divided screens are to be plotted automatically.

Press SHIFT 8 TALK/ADRS 05 to set TALK.

This outputs TALK ONLY. Set the plotter to LISTEN ONLY.

Press SHIFT 8 TALK/ADRS 05 to set ADRS 05.

This outputs addressing. Specify the plotter address with the numeric, step keys and data knob. Also, set the plotter to the same address.

Press SHIFT 8 PLOT CANCEL.

Cancels the plot output.

Press SHIFT 8 PLOT EXECUTE.

Executes plot output according to the set conditions.

CAUTION

1. Refer to the separate plotter instruction manual for operating the plotter.
2. This equipment supports plotter types that comply with HP-GL standards only. Note that the screen of the HP7470 plotter cannot be divided into two sections.

R3261/3361
SPECTRUM ANALYZER
INSTRUCTION MANUAL

4.7 Plot Output Function

(3) Assigning the Plotter Pens

1 pen specification :	Everything pen 1	frame, marker, character, D-line, waveform A, waveform B
2 pen specification :	pen 1	frame, marker
	pen 2	waveform A, waveform B, character, D-line
4 pen specification :	pen 1	frame, marker
	pen 2	character, D-line
	pen 3	waveform A
	pen 4	waveform B
6 pen specification :	pen 1	frame
	pen 2	character
	pen 3	waveform A
	pen 4	waveform B
	pen 5	D-line
	pen 6	marker

CAUTION

Output to the plotter is done in TALK ONLY mode, so the plotter must be set to LISTEN ONLY mode.
Do not connect the controller.

4.8 Label Function

[Function]

This function is used to input the title of waveform screen and the title at the time of save/recall, and the file name at the time of operating memory card, etc.

(1) Panel Keys and the Corresponding Softkey Menu



Refer to Section A.1 (18).

(2) Selection of Character

In general, the label function can be used to input the comment on the most significant line on the screen, but it also can be used to input such title characters as save/recall.

In label input, input is made by selecting characters one by one. Characters are selected from the operation window screen displaying upper and lower case letters and symbols. One character is selected and the ENTER key pressed. Numeric values can also be entered from the ten keys.

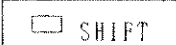
[Procedure and explanation]



Press   .

The following operation window screen appears. Select any character from the screen.

```

L A B E L
BCDEFGHIJKLMNOPQRSTUVWXYZ
0123456789

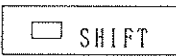
```

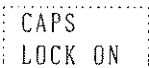
Press    .

Select uppercase letters.

Press    .

Select lowercase letters.

R3261/3361
SPECTRUM ANALYZER
INSTRUCTION MANUAL

4.8 Label Function

Press SHIFT 9 MARK .

Select symbols.

Press SHIFT 9 LABEL
CLEAR .

Deletes all labels.

Press SHIFT 9 RETURN .

Return to the softkey menu when the label function is started.

(3) Operation Procedure

① Press SHIFT 9 .

② Use the step keys to move the cursor to the right and left. Press ↑ to move the cursor to the right, and press ↓ to move the cursor to the left. Press SHIFT and then the up key to move the cursor to the beginning of the label, and press the shift key and then the down key to move the cursor to the end of the label.

③ Turn the data knob to find the desired character and press ENTER to input that character.

④ The backspace key deletes the input character. Press SHIFT and then BK SP to delete the character under the cursor and the subsequent characters.

R3261/3361
SPECTRUM ANALYZER
INSTRUCTION MANUAL

4.9 Memory Card Function

4.9 Memory Card Function

4.9.1 Specification of Memory Card

Memory capacity	:	32K bytes, standard
Connector	:	20 poles and 2 pieces (connecting/disconnecting cycle: more than 5000 times)
Interface	:	I/O bus method (in accordance with JEIDA)
Power for memory back-up:		CR 2016 (One unit, changeable)
Memory retention period	:	5 years (at room temperature)
Outline dimension	:	54(W) x 86(L) x 2.2(T) mm
Environmental condition	:	Dewing should be prohibited. Working temp. 0 to 40°C Memory storing temp. -20 to 60°C Relative humidity 10 to 90%
Write protection	:	The on or off status can be selected by the switch. When the write-protection switch is on, data cannot be written on the disk (that is, the disk is write-disabled).

4.9.2 Names of Parts of Memory Card

(1) Surface



(2) Surface

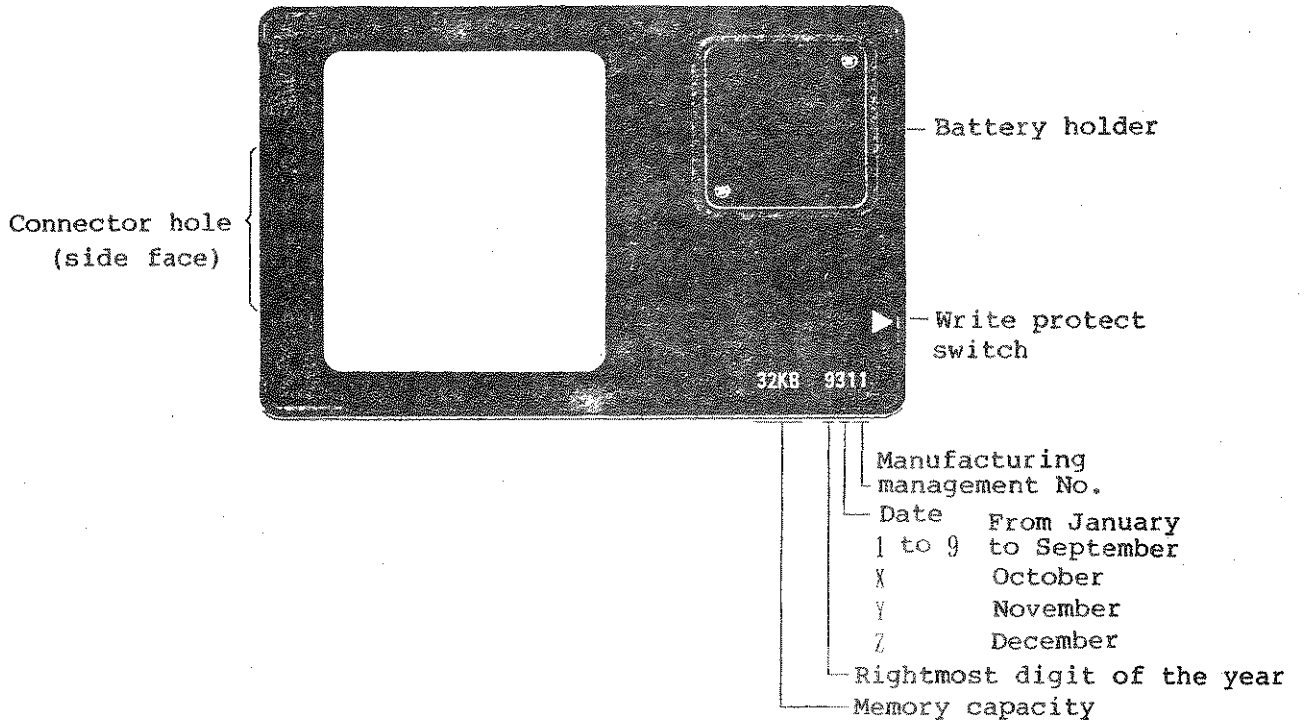

R3261/3361
SPECTRUM ANALYZER
INSTRUCTION MANUAL

4.9 Memory Card Function

4.9.3 Life of Back-up Battery

Memory store time of memory card is five years. The period is from setting the new battery to storing under normal temperature. When the battery is replaced at the first time, refer to the number stamped on the rear face of the memory card.

Example: When 32 kB 9206 is stamped

It means the manufacture in February of 1989, therefore it is replaced in February of 1994.

CAUTION

If the memory card is left under high temperature, the life of the battery is shortened considerably. When the memory card is not used, it is removed from this unit.

4.9.4 Replacing the Battery

Procedure for replacing

- ① Remove two screws from the rear face of memory card using a Phillips driver, and remove the cover.
- ② Remove the battery, and replace it with a new battery.

Set the battery so that its ⊕ side is seen.

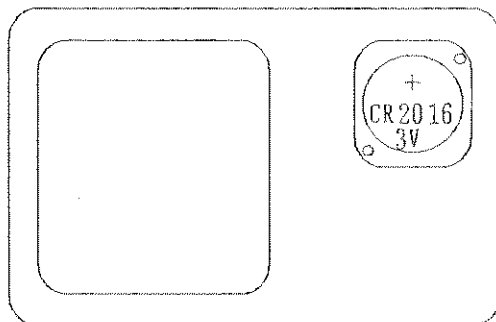

Battery type
CR2616

- ③ Install the cover.

CAUTION

When the battery is replaced, all data saved on the memory card are erased. Copy necessary data on another memory card, then the replace the battery.

Optional memory cards

A09505: 32K byte SRAM card ---- Set of five cards

A09506: 128K byte SRAM card --- Set of five cards

4.9.5 Cautions on Memory Card

- (1) Do not insert dust in the connector hole as it may cause imperfect contact or connector damage.
- (2) Do not attach the metallic needle to the connector. If it is attached, the static electricity may explored.
- (3) Do not bend or apply strong shock.
- (4) Keep this unit dry.

R3261/3361
SPECTRUM ANALYZER
INSTRUCTION MANUAL

4.9 Memory Card Function

4.9.6 Method of Inserting and Removing Memory Card

Operation Procedure

- ① Insert the memory card with the printed side kept to the left.
- ② Normal READ/WRITE operation can be made while the protect switch is turned to "OFF". When the switch is turned to "ON", the write operation is prohibited.
- ③ Before taking out the card, push the eject button.

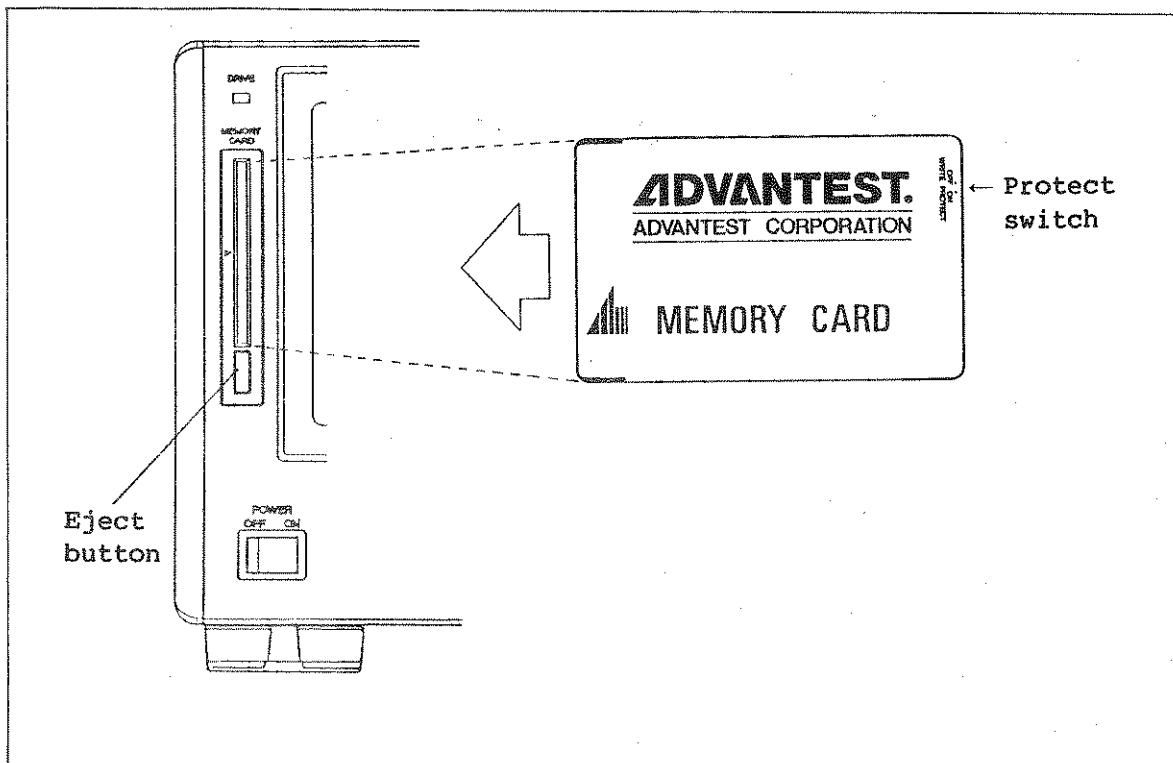

Figure 4 - 7 How to Insert Memory Card

CAUTION

The drive lamp should be lit during the card access. Do not push the ejection button to take out the memory card while the lamp is lit.

If the card is taken out while the lamp is lit, data in the card cannot be guaranteed.

4.9.7 Memory Card Function

[Function]

This function is for initializing the memory card and storing and recalling the softkey menu. For storing the setting conditions, restoration, etc. see the save and recall functions in Chapter 4.4.

(1) Panel Keys and the Corresponding Softkey Menu

Refer to Section A.1 (19).

(2) Initializing the Memory Card

Format the memory card.

Press SHIFT 4 VOLUME INIT to execute initialization.

CAUTION

The unused memory card won't function unless this initialization menu is run. Notice that all data in the card will be erased when the memory card storing the data is reinitialized.

(3) Storing Softkey Menu

One softkey menu programmed by the user-defined function Section 4.5 can be stored as data in the memory card.

Press SHIFT 4 MENU STORE to execute storing.

CAUTION

1. If the MENU STORE key is pressed again after storing the softkey menu, that softkey menu data will be deleted.
2. To protect the softkey menu data, turn on the WRITE PROTECT switch of the memory card.

(4) Recalling Softkey Menu

The softkey menu stored in the memory card can be recalled.

Press SHIFT 4 MENU LOAD to recall the softkey menu data.

CAUTION

When storing both the softkey menu and the setting conditions on a single memory card, store the softkey menu first.

The number of files to be stored depends on the memory card size and the execution conditions.

Example:

Softkey menu + setting conditions	: up to 15 files
Setting conditions + trace data A	: up to 12 files
Softkey menu + setting conditions + trace data A	: up to 11 files
Setting conditions + trace data A & B	: up to 7 files
Softkey menu + setting conditions + trace data A & B	: up to 6 files
Setting conditions + trace data A + normalize data A & B + antenna correction data + limit line data A	: up to 4 files

4.10 Measuring Window

4.10.1 Window Setting

[Function]

This window for measuring is useful in the sweeping and marker peak search functions. The dynamic window sizes range from 0.2div (1/5 the grid size) to full scale.

(1) Panel Keys and the Corresponding Softkey Menu

Refer to Section A.1 (22).

(2) Window Setting

① Window ON

Press **SHIFT** **0**^{M. W}, and display the window on the screen. (The figure below shows initial setting sizes.) The new sizes are retained until reset.

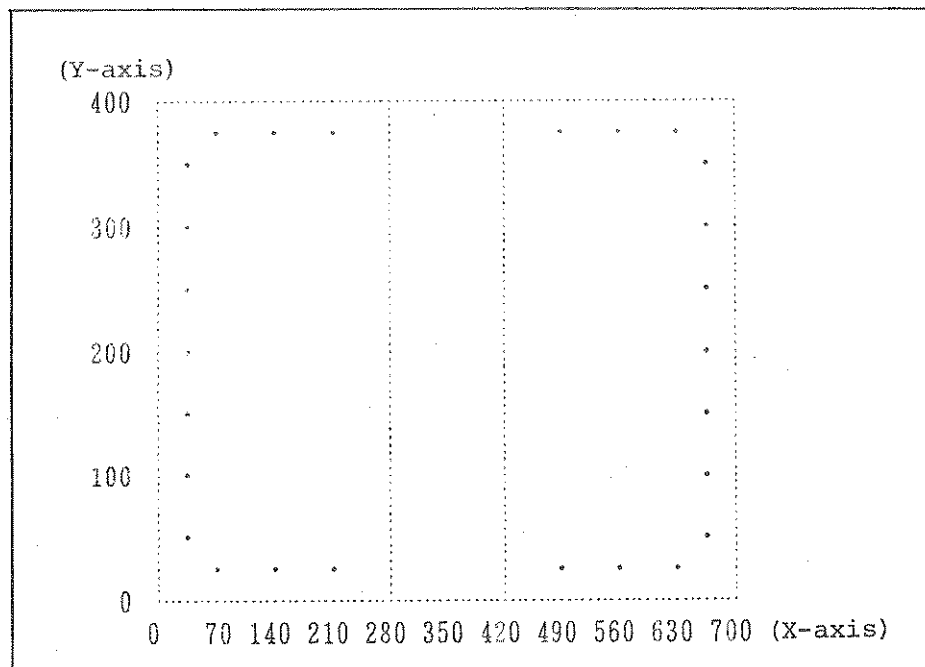

Window start frequency = X-axis 280th point
Window stop frequency = X-axis 420th point
Window high level = Y-axis highest level
Window low level = Y-axis lowest level

R3261/3361
SPECTRUM ANALYZER
INSTRUCTION MANUAL

4.10 Measuring Window

② Window OFF

Press M. W. SHIFT 0 WINDOW OFF, and clears the window display.

③ LOCATION

Press M. W. SHIFT 0 NEXT MENU.
Moves the center of the window (X, Y) at LOCATE X or LOCATE Y.

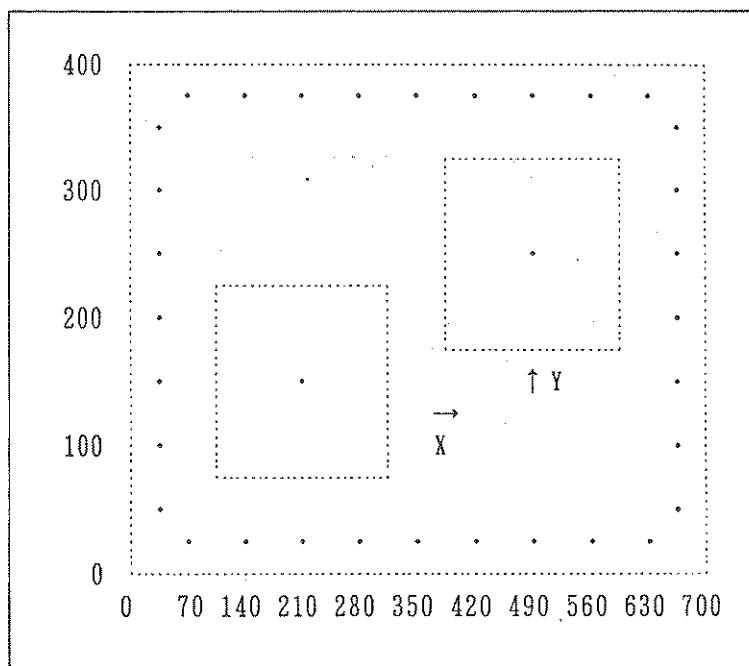

[keys for adjusting data]

To increase the center frequency, turn the data knob clockwise or press the step up arrow key. (X or Y)

To decrease the center frequency, turn the data knob counterclockwise or press the step down arrow key. (X or Y)

R3261/3361
SPECTRUM ANALYZER
INSTRUCTION MANUAL

4.10 Measuring Window

④ DELTA

Press SHIFT 0 NEXT MENU .

Increases and decreases frequency width (ΔX), level difference (ΔY) at

ΔX or ΔY .

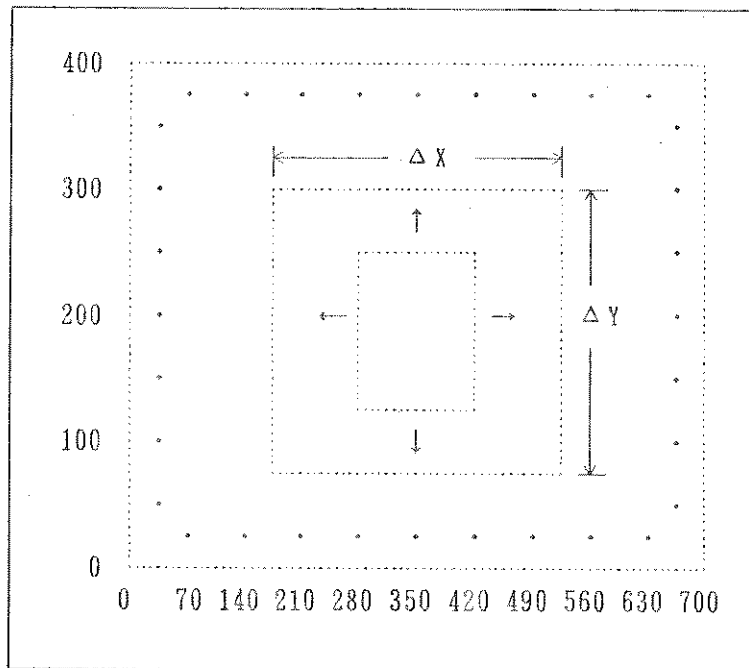

[Keys for adjusting data]



To increase the delta value, turn the data knob clockwise or press the step up arrow key. (X or Y)

To decrease the delta value, turn the data knob counterclockwise or press the step down arrow key. (X or Y)

R3261/3361
SPECTRUM ANALYZER
INSTRUCTION MANUAL

4.10 Measuring Window

⑤ ABSOLUTE

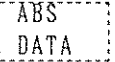
Press     .

Pressing the  key allows start frequency (START F) to be set with absolute value.

Pressing the  key allows stop frequency (STOP F) to be set with absolute value.

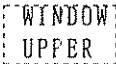
Pressing the  key allows upper level (UPPER L) to be set with absolute value.

Pressing the  key allows lower level (LOWER L) to be set with absolute value.

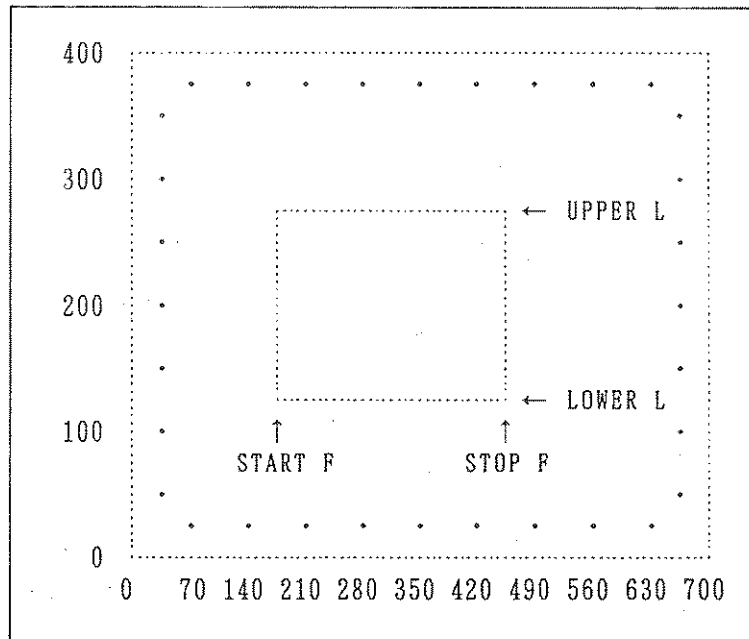

[Keys for Adjusting Data]

To increase the most active of the above four data, turn the data knob clockwise or press the step up arrow key.

To decrease the most active of the above four data, turn the data knob counterclockwise or press the step down arrow key.

To specify the most active of the above four data with the absolute value, use the numeric keys.

R3261/3361
SPECTRUM ANALYZER
INSTRUCTION MANUAL

4.10 Measuring Window

4.10.2 WINDOW MEASUREMENT

(1) Measuring Function

When the window is on, the following measurement can be executed. The user can change the window setup or measuring conditions during measurement. When the window is turned off, the window measurement is released.

① Partial sweep

Signals are swept within the window (see Item (4) of Section 4.1.6).

[Operation procedure]

After window setup, press

MENU

SWEEP
MODE

WINDOW
SWEEP

in this

NORMAL
SWEEP

and

MANUAL
SWEEP

mode can be switched.

Press

NORMAL
SWEEP

continuously to release it.

② Peak search by marker

The peak can be searched in the window.

[Operation procedure]

After window setup, press

PEAK

.

③ Continuous peak search by marker

The peak can be searched in the window.

The marker will remain in the window even after the window setting is changed.

[Operation procedure]

After window setup, press

PEAK

NEXT
MENU

PK CONT
ON/OFF

in this

④ Next peak search by marker

The next peak can be searched in the window.

[Operation procedure]

After window setup, press

PEAK

NEXT PK

in succession.

R3261/3361
SPECTRUM ANALYZER
INSTRUCTION MANUAL

4.10 Measuring Window

⑤ x dB down of marker

The signal level can be reduced for "x dB" within the window.

[Operation procedure]

After window setup, press this order.

ON

NEXT
MENU

X dB
DOWN

in

(2) GO or NG Judgment Function

[Functions]

- This function is enabled only when the GPIB is controlled remotely.
- In properly-set MEAS and measuring data in the window, this function determines the upper or lower limit from the UPPER to the LOWER level of the window.
- The function outputs 0 for GO (all of measured data in the window range from UPPER to LOWER) and outputs the number of points for NG (up to 100 points from the left). It can also output not-good frequency.
- A resolution of Y-axis level in the window is up to 0.1 dB.

[GPIB command]

Command	Description
CMA	Determines GO or NG with trace A.
CMB	Determines GO or NG with trace B.
CM?	Specifies the output of GO or NG result (NG point number: GO=0, NG=1 to 100).
CMP?	Specifies the output of frequency data for NG (for NG point).

R3261/3361
SPECTRUM ANALYZER
INSTRUCTION MANUAL

4.10 Measuring Window

[Example of program] (PC9801)

```
10 ISET IFC:ISET REN
20 PRINT @8;"WTF1MZ WPF2MZ"      'Set window frequency.
30 PRINT @8;"WUL-10DB WLL-20DB"  'Sets the upper and lower limits of window.
40 PRINT @8;"CM?"                'Specifies the output of GO or NG result.
50 PRINT @8;"CMA"                'Determine GO or NG in trace A.
60 INPUT @8;P                    'Reads data.
70 PRINT "NG = ";P;" point"      'Display
80 IF P=0 THEN GOTO 140          'Terminates for GO.
90 PRINT @8;"CMF?"              'Specifies the output of NG frequency data.
100 FOR N=1 TO P                 'Counts the NG point number.
110   INPUT @8;NGF$              'Reads data.
120   PRINT N,NGF$               'Display
130 NEXT N
140 END
```

4.11 Tracking Generator Function (R3361C/CN/D only)

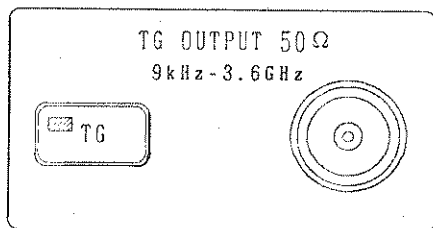

R3361D

For details, see Section 5.

[Function]

Tracking generator

(1) Panel Keys and the Corresponding Softkey Menu

Refer to Section A.1 (20).

(2) Setting TG Level

TG level can be set within the range of 0 to -50dBm. The initial setting value is -10dBm.

[Procedure and explanation]

Press

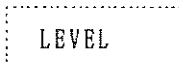
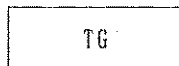

Selects the TG level mode and displays the current TG level at the left upper end of the screen. This key input allows data entry.

R3261/3361
SPECTRUM ANALYZER
INSTRUCTION MANUAL

4.11 Tracking Generator Function

[Data Adjusting Key]

- Data knob : TG level rises when the knob is turned clockwise and lowers when the knob is turned counterclockwise. The set resolution is 1dB.
- Step key : Increases or decreases the TG level by 5dB.
- Ten key : The set resolution is 1dB.

(3) Setting FREQ CAL AUTO

[Procedure and explanation]

Press

TG

FREQ CAL AUTO

 .

Causes an automatic setup of appropriate TG FREQ D/A signal conversion level for the current RBW.

(4) Setting TG Frequency

The TG FREQ D/A value can be set within the range of 0 to 0xffff. The initial set value is 0x800.

[Procedure and explanation]

Press

TG

FREQ CAL MANUAL

 .

TG FREQ D/A value setting mode.
Data entry becomes possible, and the current TG FREQ D/A value is displayed at the upper left corner of the screen.

[Data Adjusting Key]

- Data knob : The TG FREQ D/A value increases when the knob is turned clockwise and decreases when turned counterclockwise. The set resolution is one point.
- Step key : Increases or decreases the TG FREQ D/A value by one point.
- Ten key : The set resolution is one point.

(5) TG OFF

To turn off the TG, press OFF in the softkey menu or press the TG key in the front panel again. The TG mode is released and the instrumentation mode is enabled.

4.12 EMC Function

[Function]

This function is for measuring interfering waves.

4.12.1 Panel Keys and the Corresponding Softkey Menu

Refer to Section A.1 (21).

4.12.2 Antenna Correction Function

This function is for correcting antenna coefficients and measuring electric field strength.

[Procedure and explanation]

Press SHIFT 1 FIELD STR ANTENNA DIPOLE .

Sets electric field strength measuring conditions when using the Advantest half wavelength dipole antenna TR1722.

Press SHIFT 1 FIELD STR ANTENNA LOG PERD .

Sets electric field strength measuring conditions when using the Advantest logarithm cycle dipole antenna TR1711.

Press SHIFT 1 FIELD STR ANTENNA TR17203 .

Sets electric field strength measuring conditions when using the Advantest active antenna TR17203.

Press SHIFT 1 FIELD STR ANTENNA ANTENNA OFF .

Cancels the electric field strength measuring conditions of the above three.

Press SHIFT 1 FIELD STR ANTENNA CORR .

Creates the user-defined antenna coefficients. The limit line section (4) contains further explanations.

R3261/3361
SPECTRUM ANALYZER
INSTRUCTION MANUAL

4.12 EMC Function

Press SHIFT 1 FIELD STR ANTENNA CORR, and CORRECT ON/OFF is set to ON or OFF.

Either cancels or executes WRITE waveform adjustment of the user-defined antenna coefficients.

Press SHIFT 1 FIELD STR ANTENNA CORR NEXT MENU, and INPUT/MODIFY is set to INPUT or MODIFY.

Selects new input or modification for the user-defined antenna coefficients.

Press SHIFT 1 FIELD STR ANTENNA CORR NEXT MENU, and FREQ/LEVEL is set FREQ or LEVEL.

Selects frequency value or level value for the input of the user-defined antenna coefficients.

Press SHIFT 1 FIELD STR ANTENNA CORR NEXT MENU TABLE INIT.

Initializes the user-defined antenna coefficient input area, erasing all current values.

Note: Software menu TABLE INIT is displayed only when software menu INPUT/MODIFY is set to MODIFY.

Press SHIFT 1 FIELD STR ANTENNA CORR NEXT MENU TABLE DELETE.

Erases one set (frequency and level values) of user-defined antenna coefficient inputs. Section (4) Limit Line contains further explanation.

Note: Software menu TABLE DELETE is displayed only when software menu INPUT/MODIFY is set to MODIFY.

4.12.3 QP Measurement

- ① This function is for measuring pulse noises. Measuring constants are set as follows according to the CISPR standard.

Table 4 - 2 QP Measurement Basic Characteristics of CISPR Standard

	Measuring band	6 dB Bandwidth	Waved time constant		
			Recharging constant	Discharging constant	Mechanical constant
A	10kHz to 150kHz	200Hz	45ms	500ms	160ms
B	150kHz to 30MHz	9kHz	1ms	160ms	160ms
C	30MHz to 300MHz	120kHz	1ms	550ms	100ms
D	300MHz to 1GHz	120kHz	1ms	550ms	100ms

- ② Since time constant with large number is counted on the measurement of QP value as shown in Table 4-2, set the sweep time for long enough. See Table 4-3 for the sweep time value.

Table 4 - 3 Reference Value of the Sweep Time

Bandwidth to be measured		Target value of sweep time
A	10kHz to 150kHz	1 second per frequency span of 200Hz
B	150kHz to 30MHz	1 second per frequency span of 10kHz
C	30MHz to 300MHz	1 second per frequency span of 100kHz
D	300MHz to 1GHz	

- ③ Example of measurement of interfering terminal voltage in dummy power supply circuit.

Operating procedure

- ③-1 Connect this spectrum analyzer with signal (to be measured supplier (DUT) and dummy power supply circuit as shown in Figure 4-8.

R3261/3361
SPECTRUM ANALYZER
INSTRUCTION MANUAL

4.12 EMC Function

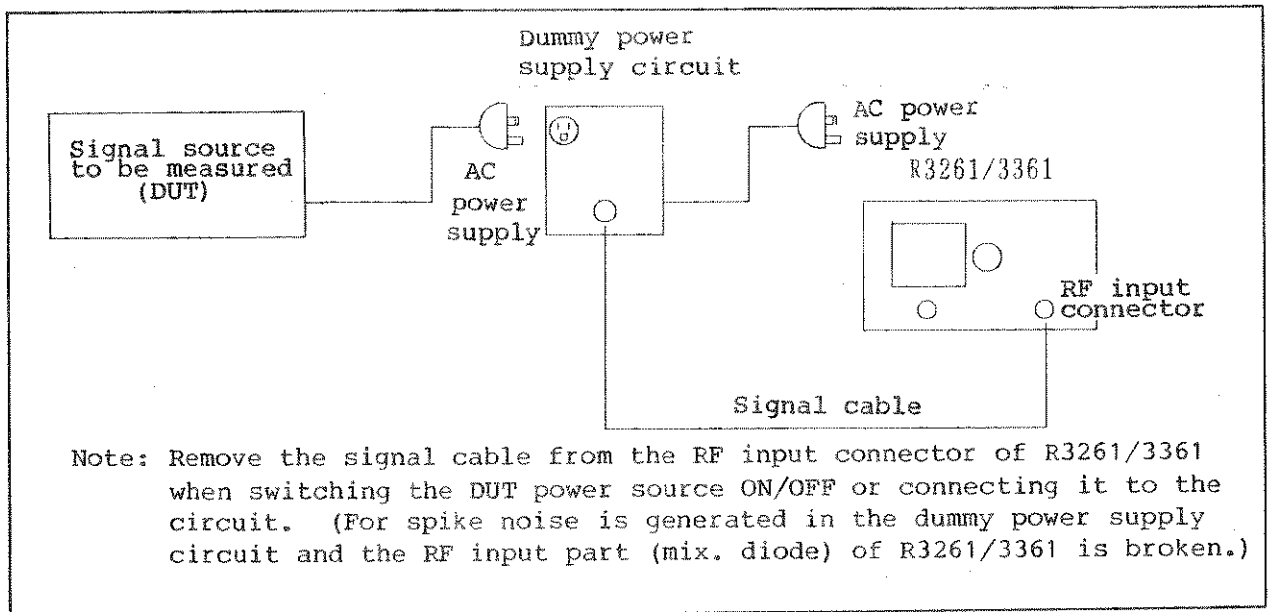

Figure 4 - 8 Measurement of Interfering Terminal Voltage

- ③-2 Set START and STOP frequencies which are to be measured.

Press .

Press .

- ③-3 Set QP resolution bandwidth.

Press , and is set to ON.

By this setting, this spectrum analyzer automatically selects the resolution bandwidth (9kHz) and charging/discharging time constant.

Note: If START and STOP frequencies exist in more than two frequency bands, the resolution bandwidth is automatically selected by the STOP frequency.

- ③-4 Set the sweep time in accordance with Table 4-3.

Press , and adjust a data with

or .

Set the sweep time for long enough.

Note: In procedures ③-1 through ③-3, the sweep time is settled 1000 seconds.

- ③-5 Increase and decrease frequency by 10dB bandwidths on the operating attenuator and ensure there is no waveform change. If the waveform changes, increase the attenuator gain or attach a band pass filter in the input side, because the input capacity of this spectrum analyzer has been saturated.

Press , and adjust a data with
or .

Check that the level does not change.

- ③-6 Switch on the marker lamp and read the data, then compensate for error by the correction factor, as according to the dummy power supply circuit.

Press , and adjust a data with .

- ③-7 Since QP dynamic range has two ranges, 40dB and 80dB, select the appropriate range as occasion calls.

Press , and adjust a data with
or .

10dB/div=80dB D. Range
5dB/div=40dB D. Range

- ③-8 In releasing the QP value measuring mode, this spectrum analyzer sets the REF mode, where the QP value measuring mode is not set.

Press , and is set to OFF.

[Procedure and explanation]

Press SHIFT 1 QP , and QP ON/OFF is set to ON or OFF.

Switches the QP measurement on or off.

QP BW AUTO is automatically selected when QP BW is not selected.

Press SHIFT 1 QP QP BW AUTO .

Automatically selects the appropriate QP bandwidth to match the measuring band in Table 4-2.

Press SHIFT 1 QP QP BW 200 Hz .

Manual selection of the QP bandwidth 200Hz.

Press SHIFT 1 QP QP BW 9 kHz .

Manual selection of the QP bandwidth 9kHz.

Press SHIFT 1 QP QP BW 120 kHz .

Manual selection of the QP bandwidth 120kHz.

4.12.4 Limit Line Function

The Limit Line function allows display of spectrum upper or lower limit on the screen. The measured data can easily be compared with the limit value on the screen.

(1) Data Table Input Procedure

Up to 51 points of frequencies and up to 51 points of levels can be input for the limit line data. The frequency data inputs range from 0GHz to 3.6GHz and the level data inputs range from -200dBm to +50dBm. The REF level unit may be used for the level data inputs. Ordinary data inputs are executed in the input mode. Use the modify mode to modify the data already input.

[Operating procedure]

- ① Press SHIFT 1 LIMIT LINE A to display the following data input window.

LIMIT LINE A						
FREQ :						
LEVEL :						
No.	G	M	k	Hz	dBm	
1	:	1	000	000	000	-20.0
2	:	1	100	000	000	-30.0
3	:	1	200	000	000	-40.0
4	:	1	300	000	000	-50.0
5	:	1	400	000	000	-60.0
→ 6	:					
7	:					
8	:					
9	:					
10	:					

The above is the window with 5 points data input.

The window is divided into upper and lower parts and the upper is called the active area and the lower is called the list area. The active area displays the currently input data (input mode) or the data to be modified (modify mode).

- ② Selecting Input Mode

Press NEXT MENU INPUT/MODIFY .

Press INPUT/MODIFY to switch between the input and the modify mode.

The input mode accepts frequency data and level data alternately.

The frequency and level input together are considered one-point data. Input data is sorted in the ascending order of frequencies.

The modify mode accepts modification and sorting of data already input

according to the frequency or level. Press TABLE INIT to delete all

data. Press TABLE DELETE to delete the data to which the arrow points.

③ Selecting Data

Press FREQ/
 LEVEL to select frequency data or level data.
Ordinarily, the two data inputs are accepted alternately. Press this key to modify the desired data.

④ Displaying List

Input data is displayed in the list area (lower part of the window). This data is not displayed in the active area (upper part of the window) while in input mode, but currently active data. Turn the data knob to scroll the data display up or down.

LIMIT LINE A					
FREQ :		1 200 000 000 Hz			
LEVEL :		-40.0 dBm			
No.	G	M	K	Hz	dBm
1 :	1	000	000	000	-20.0
2 :	1	100	000	000	-30.0
→ 3 :	1	200	000	000	-40.0
4 :	1	300	000	000	-50.0
5 :	1	400	000	000	-60.0
6 :					
7 :					
8 :					
9 :					
10 :					

(2) Executing Limit Line Function

ON closes the currently open window and displays the limit lines in the B memory. OFF erases the limit lines.

[Procedure and explanation]

Press SHIFT 1 LIMIT LINE A, and LIMIT A ON/OFF is set to ON or OFF.

Turns the user-defined limit line display in the VIEW B waveform area on or off.

R3261/3361
SPECTRUM ANALYZER
INSTRUCTION MANUAL

4.12 EMC Function

Press SHIFT 1 LIMIT LINE A NEXT MENU , and INPUT/MODIFY is set to INPUT or MODIFY.

Selects new input or modification for the user-defined limit line.

Press SHIFT 1 LIMIT LINE A NEXT MENU , and FREQ/LEVEL is set to FREQ or LEVEL.

Selects the frequency value or level value for the user-defined limit line inputs.

Press SHIFT 1 LIMIT LINE A NEXT MENU TABLE INIT .

Initializes the user-defined limit line input area, erasing all current values.

Note: Software menu TABLE INIT is displayed only when software menu INPUT/MODIFY is set to MODIFY.

Press SHIFT 1 LIMIT LINE A NEXT MENU TABLE DELETE .

Erases one set (frequency and level values) of user-defined limit line to which the arrow points.

Note: Software menu TABLE DELETE is displayed only when software menu INPUT/MODIFY is set to MODIFY.

4.13 Occupied Bandwidth Measurement (OBW) and Adjacent Channel Leakage Power Measurement (ADJ)

4.13.1 Occupied Bandwidth Measurement (OBW)

[Function]

Calculates the occupied bandwidth by using the on-screen measured data that is stored in the trace A memory of the tester. In this calculation, the rate of the bandwidth to the total power can be specified within the range of 10% to 99.8%.

(1) Procedure and explanation

Refer to A.1 (23).

(2) Calculation

The tester screen shows 701 points of data on the frequency axis. If one of these points has the voltage of "Vn", the total power of P on the screen can be determined by the following equation:

$$P (W) = \sum_{n=1}^{701} \frac{V_n^2}{R} \quad (\text{R is the input impedance.})$$

If the sum of the power is calculated as the amount from the left end of the screen. If the 0.5% position of the total power of P is point X from the left end of the frequency axis, the following equation is satisfied:

$$0.005P = \sum_{n=1}^X \frac{V_n^2}{R} \quad (\text{If the rate is 99.0%})$$

If the some of the power is calculated as the amount from the left end of the screen. If the 99.5% position of the total power of P is point Y from the left end of the frequency axis, the following equation is satisfied.

$$0.995P = \sum_{n=1}^Y \frac{V_n^2}{R} \quad (\text{If the rate is 99.0%})$$

Values X and Y can be determined, and the occupied bandwidth can be determined by the following equation:

$$\text{OBW (Hz)} = \frac{f_{\text{SPAN}}(Y-X)}{701} \quad (f_{\text{SPAN}} \text{ is the frequency span.})$$

R3261/3361
SPECTRUM ANALYZER
INSTRUCTION MANUAL

4.13 OBW and ADJ

(3) Operation Procedure

The following explains how to determined the occupied bandwidth.

CAUTION

1. If the amplitude of a signal is below 40dB, the calculation error may increase. Adjust the reference level of the signal to have 40dB or higher amplitude.
2. If the resolution bandwidth of the tester is set to approximately 1/200 or less than the frequency span, the measurement error can be minimized.
3. If a signal has excessive noise components (for example, the modulated waves of artificial voice signals), set the trace det. mode to SAMPLE to minimize the error.

Operating Procedure:

- ① Set the vertical axis scale to 10dB/div on the screen, select the "Normal" sweep mode, and set the frequency span to "Linear" as follows:

Press .
(dB)

Press .

Press .
(excluded)

- ② Adjust the center frequency so that the signal waveforms of trace A are displayed at the center of the screen, and specify the measurement frequency span and resolution bandwidth.

Press .

Press , and adjust a data.

Press , and adjust a data.

Press , and adjust a data.

Press .

- ③ Set the trace det. mode to "SAMPLE" as follows:

Press .

- ④ Measure the occupied bandwidth by entering the following keys:

Press SHIFT 6 OBW .

The occupied bandwidth will be displayed at the left upper end of the screen. The marker points to the rate to the total power (indicated in a pair of parentheses).

If this rate is 99.0%, for example, the marker points to the 0.5% position of the total power from the both ends of the screen.

- ⑤ To change the rate to the total power, change the occupied bandwidth displayed in Step ④ as follows:

Example:

If the SHIFT 6 OBW keys are pressed in succession, the occupied bandwidth is displayed.

Then, press the 8 0 GHz keys in this order to set the rate to 80%.

4.13.2 Adjust Channel Leakage Power Measurement (ADJ)

[Function]

Calculates the integration of the power whose width is specified by the delta marker by using the on-screen measured data that is stored in the trace A memory of the tester. Then, ADJ determines the rate of this power to the total power.

- (1) Procedure and explanation

Refer to A.1 (23).

- (2) Explanation of Software Menu

Press SHIFT 6 ADJ .

Calculates the leakage power at the specified point.

Press SHIFT 6 ADJ GRAPH .

Calculates the leakage power of all points, stores the results in the trace B memory, and displays them on the screen.

(3) Calculation

The tester screen shows 701 points of the data on the frequency axis. If one of these points has the voltage of "Pn", the total power of P on the screen can be determined by the following equation:

$$P [W] = \sum_{n=1}^{701} P_n$$

If the integration width specified by the delta marker is " ΔX ", the adjacent channel leakage power at the n-th point from the left end of the screen can be calculated by the following equation:

$$P_{ADJ} [dB] = 10 \log_{10} \frac{\sum_{n-\Delta X/2}^{n+\Delta X/2} P_n}{P}$$

where:

- $n-\Delta X/2 \geq$ Start frequency
- $n+\Delta X/2 \leq$ Stop frequency

(4) Operation Procedure

The following explains how to determine the adjacent channel leakage power.

CAUTION

1. As the dynamic range of the measured signal depends on the display amplitude of the signal, the reference level must be adjusted so that the signal amplitude reaches the highest scale on the screen.
2. If the resolution bandwidth of the tester is set to approximately 1/200 or less than the frequency span, the measurement error can be minimized.
3. If a signal has excessive noise components (for example, the modulated waves of artificial voice signals), set the trace det. mode to SAMPLE to minimize the error.

R3261/3361
SPECTRUM ANALYZER
INSTRUCTION MANUAL

4.13 OBW and ADJ

Operating Procedure:

- ① Set the vertical axis scale to 10dB/div (8th or 12th scale position) on the screen, select the "Normal" sweep mode, and set the frequency span to "Linear" as follows:

Press ().
(dB)

Press .

Press .

(excluded)

- ② Adjust the center frequency so that the signal waveforms, of trace A are displayed at the center of the screen, and specify the measurement frequency span and resolution bandwidth.

Press .

Press , and adjust a data.

Press , and adjust a data.

Press , and adjust a data.

Press .

- ③ Set the trace det. mode to "SAMPLE" as follows:

Press .

- ④ Note: The further operation procedure differs between the ADJ and ADJ GRAPH modes.

Go to (a) in the ADJ mode or (b) in the ADJ GRAPH mode.

(a) ADJ mode

- (a-1) Set the normal marker to the leakage power measuring point.

Press , and adjust a data.

- (a-2) Specify the measuring point by using the delta marker and specify the integration width.

Press , and adjust a data.

The point identified by the delta marker (X) is measured, and the difference from the normal marker position (◇) is the integration width (ΔX).

In the actual calculation, the sum of the power of both ends $\pm\Delta X/2$ from the center of delta marker is determined and the rate to the total power.

R3261/3361
SPECTRUM ANALYZER
INSTRUCTION MANUAL

4.13 OBW and ADJ

(a-3) Measure the adjacent channel leakage power

Press SHIFT 6 ADJ .

The adjacent channel leakage power will be displayed at the left upper end of the screen.

(b) ADJ GRAPH Mode

(b-1) Specify the integration width by using the delta marker. (The marker can be set in any position.)

Press ON ΔMKR , and adjust a data.

If the integration width is "ΔX", the value of [start frequency +Δx/2] is multiplied by the value of [stop frequency -ΔX/2] and the leakage power of each point is determined.

(b-2) The leakage power is calculated and the results are stored in trace B memory. Also, the calculation results are displayed on the screen.

Press SHIFT 6 ADJ GRAPH .

When the calculation is complete, trace B is displayed in the dual screen mode. The graphs are displayed with the reference level of 0dB.

(b-3) To read the graphic data of trace B directly by using the marker, set the offset so that the reference level reaches 0dB.

Press REF LEVEL REF OPST , and adjust a data.

Set the normal marker (↔) to the graphic data readout point and read the level value of the marker.

4.13.3 GPIB Remote Programming

The following gives a programming example where the Hewlett-Packard HP200 series computer is used. For the GPIB general information, see Section 7.

(1) GPIB Codes

GPIB code	Function
OBW OBW?	Executes OBW of the softkey menu. Requests OBW for data output.
ADJ ADJ?	Executes ADJ of the softkey menu. Requests ADJ for data output.
ADG	Executes the ADJ GRAPH of the softkey menu.

(2) Programming Examples (on HP200 series computer)

R3261/3361
SPECTRUM ANALYZER
INSTRUCTION MANUAL

4.13 OBW and ADJ

Example 4 - 1 OBW Measurement at Each End of Sweep

```
10 DIM A$ [25] : Declares the OBW data as
                character string variables.
20 OUTPUT 701;"IP" : Presets the tester.
30 OUTPUT 701;"CLN" : Turns on the (30MHz) CAL
                    signal of the tester.
40 OUTPUT 701;"CF30MZ SP500KZ RE-10DB DTS" : Adjust the center frequency
                    and other data.
50 FOR I=1 TO 30 : Repeats measurement 30 times.
60 OUTPUT 701;"SR" : Sweeps the signals from the
                    most beginning.
70 GOSUB Swpend : Waits for the end of sweep.
80 OUTPUT 701;"OBW?" : Specifies the output data to
                    OBW.
90 OUTPUT 701;"OBW" : Starts OBW calculation.
100 ENTER 701;A$ : Reads the OBW data.
110 PRINT "I=";I,A$ : Displayes the data on the
                    screen.
120 NEXT I
130 STOP
140 !
150 Swpend: !
160 OUTPUT 701;"S2" : Clears the status byte.
170 S=SPOLL (701) : Performs serial polling.
180 IF BIT(S,2)=1 THEN RETURN : Returns control after sweep.
190 GOTO 170
200 !
210 END
```

R3261/3361
SPECTRUM ANALYZER
INSTRUCTION MANUAL

4.13 OBW and ADJ

Example 4 - 2 ADJ Measurement at Each End of Sweep

```
10 DIM A$ [25] ! Declares the ADJ data as
                ! character string variables.
20 OUTPUT 701;"IP" ! Presets the tester.
30 OUTPUT 701;"CLN" ! Turns on the (30MHz) CAL
                    ! signal of the tester.
40 OUTPUT 701;"CF30MZ SP200KZ RE-10DB DTS" ! Adjust the center frequency
                    ! and other data.
50 OUTPUT 701;"PS MT 15KZ MT" ! Determines the ADJ measuring
                               ! point that is 15kHz away from
                               ! the maximum signal level.
60 OUTPUT 701;"20KZ" ! Sets the delta frequency
                     ! (integration width) to 20kHz.
70 FOR I=1 TO 30 ! Repeats measurement 30 times.
80 OUTPUT 701;"SR" ! Sweeps the signals from the
                   ! most beginning.
90 GOSUB Swpend ! Waits for the end of sweep.
100 OUTPUT 701;"ADJ?" ! Specifies the output data to
                      ! ADJ.
110 OUTPUT 701;"ADJ" ! Starts ADJ calculation.
120 ENTER 701;A$ ! Reads the ADJ data.
130 PRINT "I=";I,A$ ! Displays the data on the
                   ! screen.
140 NEXT I
150 STOP
160 !
170 Swpend: !
180 OUTPUT 701;"S2" ! Clears the status byte.
190 S=SPOLL (701) ! Performs serial polling.
200 IF BIT(S,2)=1 THEN RETURN ! Returns control after sweep.
210 GOTO 190
220 !
230 END
```

R3261/3361
SPECTRUM ANALYZER
INSTRUCTION MANUAL

4.13 OBW and ADJ

Example 4 - 3 ADJ Graphics Measurement and Direct Read by Marker

```
10  OUTPUT 701;"IP"           ! Presets the tester.
20  OUTPUT 701;"CLN"         ! Turns on the (30MHz) CAL
                               ! signal of the tester.
30  OUTPUT 701;"CF30MZ SP200KZ RE-10DB DTS" ! Adjust the center frequency
                               ! and other data.
40  OUTPUT 701;"MT 20KZ"     ! Sets the delta frequency
                               ! (integration width) to 20kHz.
50  OUTPUT 701;"SR"         ! Sweeps the signals from the
                               ! most beginning.
60  GOSUB Swpend            ! Waits for the end of sweep.
70  OUTPUT 701;"ADG"       ! Starts ADJ GRAPH calculation.
80  OUTPUT 701;"MK 30.020MZ" ! Sets the marker (to determine
                               ! the measuring point) at the
                               ! point 20kHz away from the
                               ! maximum signal level.

90  OUTPUT 701;"ML?"       ! Specifies the output data at
                               ! the marker level.
100 ENTER 701;A           ! Reads the data at the marker
                               ! level.
110 PRINT "ADJ=",A-(-10)   ! Displays the data on the
                               ! screen. (The value at the
                               ! marker level subtracted by
                               ! the reference level is the
                               ! ADJ value.)

120 GOTO 200
130 !
140 Swpend!
150 OUTPUT 701;"S2"       ! Clears the status byte.
160 S=SPOLL (701)         ! Performs serial polling.
170 IF BIT(S,2)=1 THEN RETURN ! Returns control after sweep.
180 GOTO 160
190 !
200 END
```

4.14 Printer Interface

[Function]

The information on the R3261/3361 screen can be output to the printer, using the printer interface.

Printer which can be connected :

Maker	Printer
Hewlett Packard	HP2225AJ

(1) Connection with the Printer

Connect the printer with the R3261/3361, using the GPIB cable between the GPIB connectors.

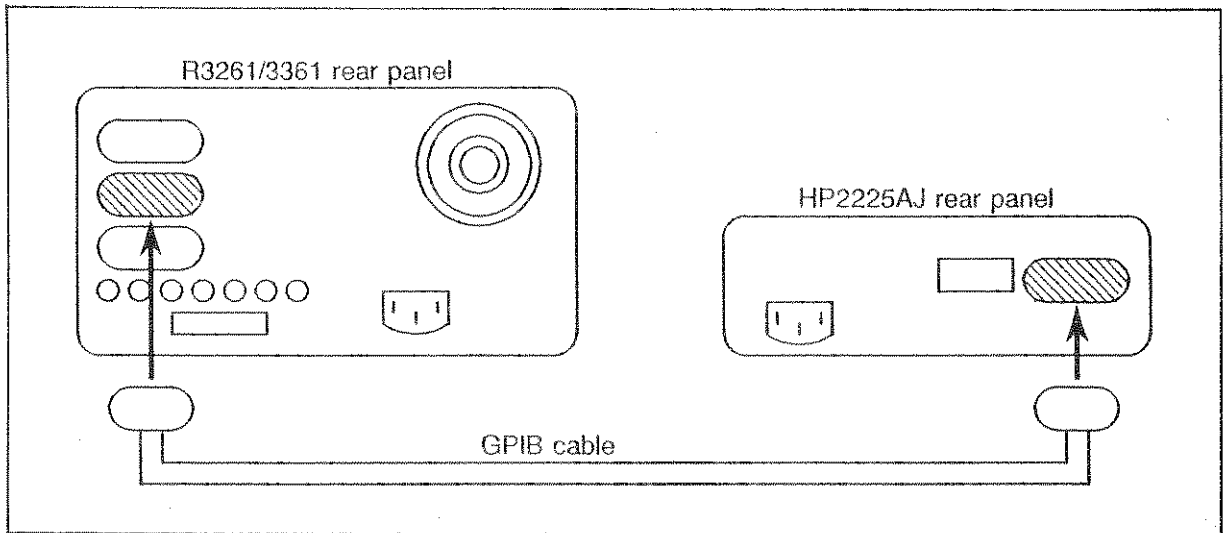

Figure 4 - 9 Connection between the R3261/3361 and the Printer

(2) Printer Address Setting

Set the printer address with the dip switch. Figure 4-10 shows an example of address setting. (Address 1)

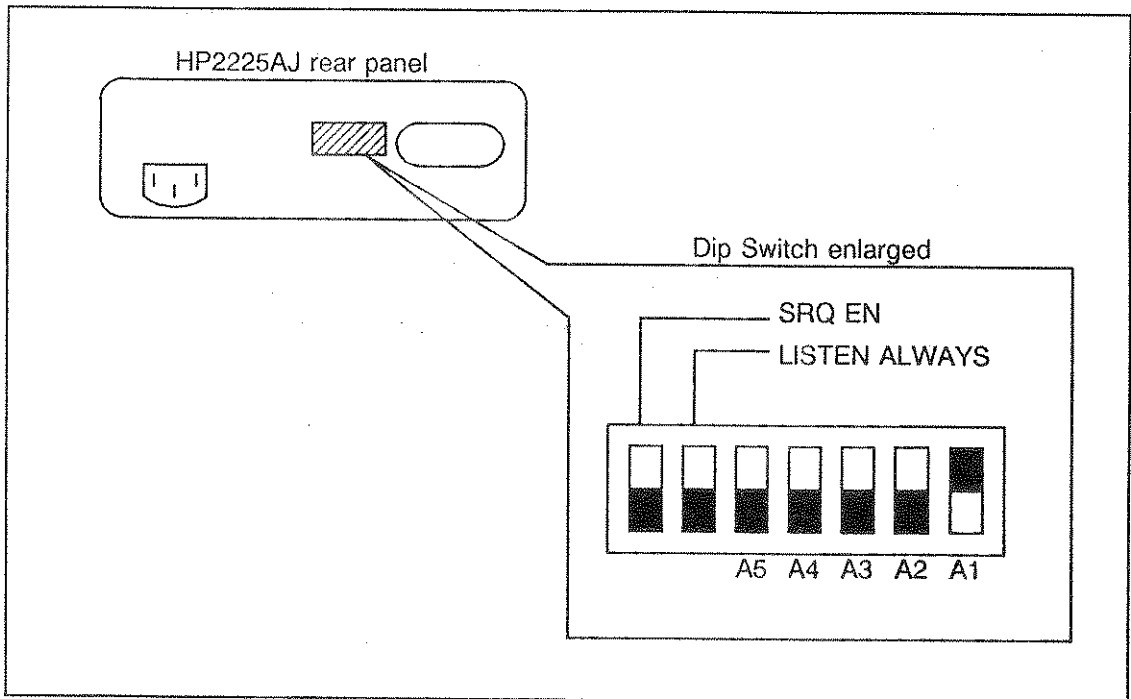

Figure 4 - 10 Dip Switch for Address Setting

Note 1: For the GPIB details, see section 7.

Note 2: For the printer usage, see the Printer instruction Manual.

(3) Printer Output Setting

① Printer output setting menu

Specify the conditions necessary for printer output.

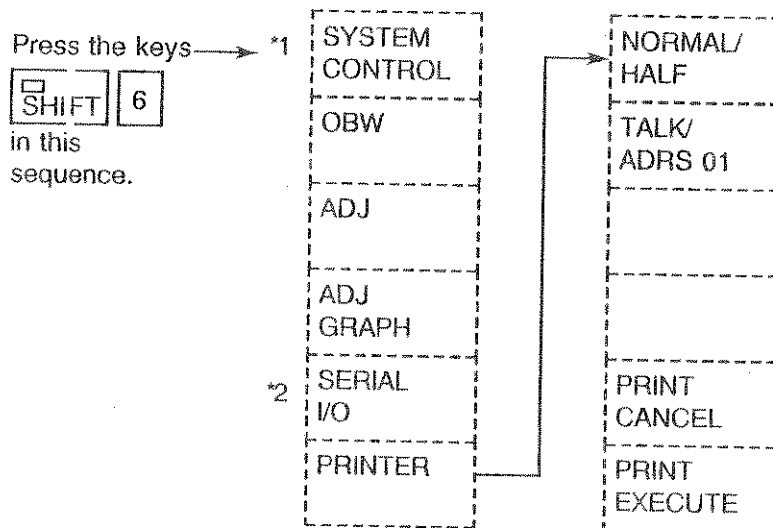



Explanation on the above menu is given in item (3) ②.

*1 : Indicated if option 81 is mounted.

*2 : Indicated if option 80 is mounted.

② Explanation on the printer output setting menu

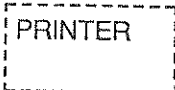
Press    in this sequence.

The screen is set for printer output specification to set various conditions.



*1 Select the print size.
Default : Normal



Cancel the output during printer output.



Output to the printer starts with the specified size.

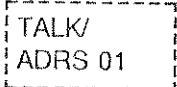

*2 TALK : All the Listeners are subject to Printer output.
ADRS XX: Any of the Listeners (address 0 to 30) are subject to printer output.
Specify the listener address with the data knob or the step key.
Default: TALK

CAUTION

*1: If the print size is set tot Half, more time is required for output, because the printer is set to HIGH DENSITY mode and the print head travels along the same line twice.

*2: When the print output is set to TALK (TALK ONLY mode), the printer should be set to LISTEN ONLY mode.
When the print output is set to ADRS XX (Address specified mode), the printer should specify the address.

③ Printer output example

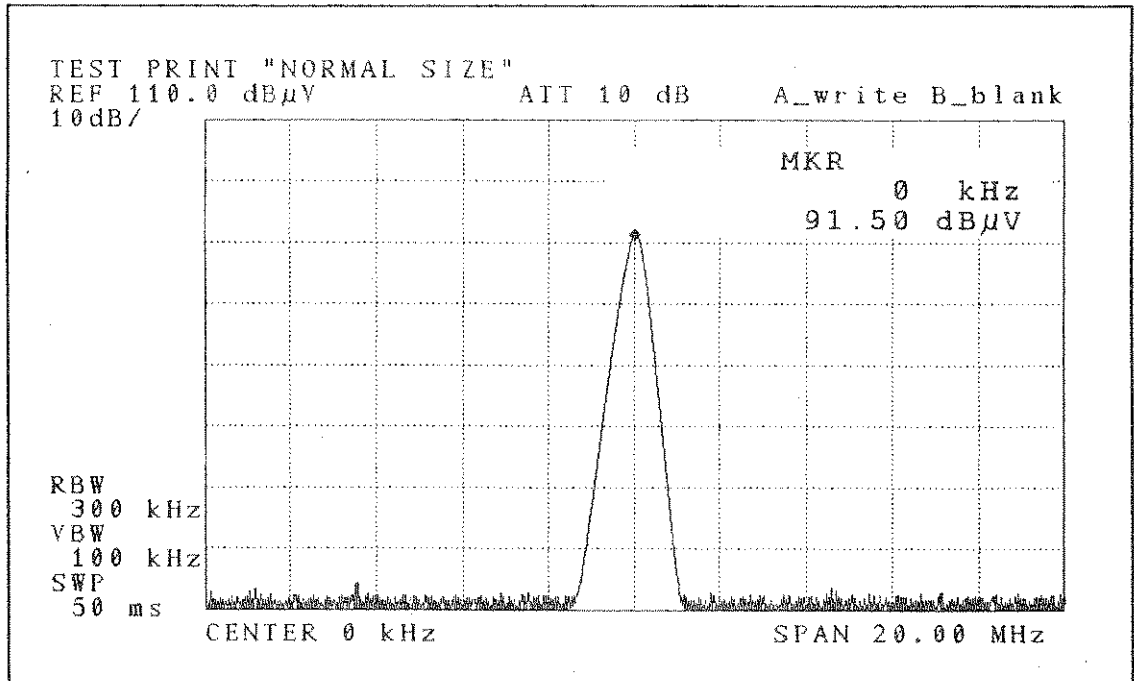

Figure 4 - 11 Print in Normal Size

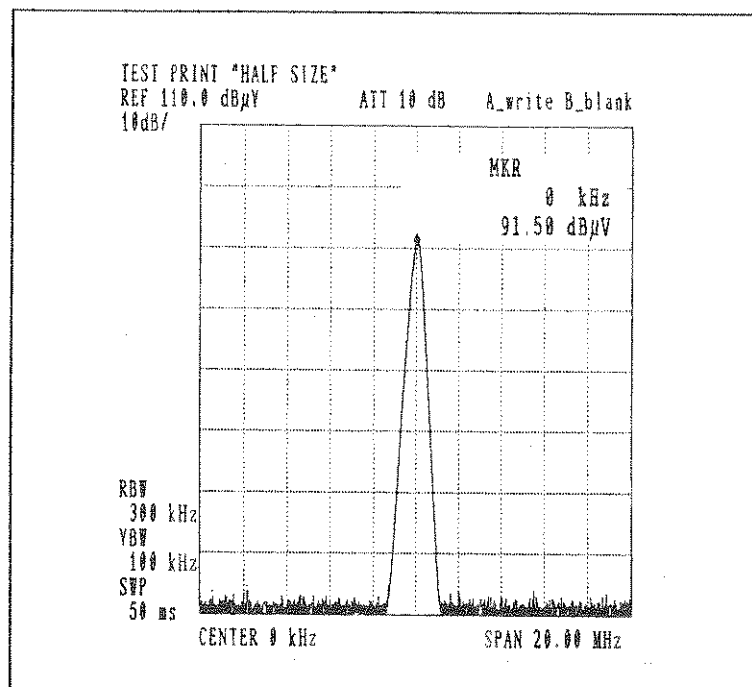

Figure 4 - 12 Print in Half Size

4.15 Option 80

Option 80 consists of two functions: a RS-232 interface and a gated sweep function.

4.15.1 RS-232 Interface

[Function]

A controller such as a personal computer having no GPIB interface can also offer a simple measurement system, using the RS-232 interface. Remote control which is normally carried out, using the GPIB interface, can also be obtained, using the RS-232 interface..

(1) Compatibility with the GPIB remote control codes:

The control codes which can be used by the RS-232 interface are identical to the GPIB codes of the R3261/3361, excluding some of the codes/functions inherent to the GPIB.

(2) Functions which can externally be controlled

The following functions can be controlled with the RS-232 interface:

- ① Measurement condition setting: Conditions entry through panel key operation
- ② Set states output: Set states and data call
- ③ I/O of measurement data: Screen trace data write-in and read-out
- ④ Status output: Data on the current instrument status can be read output in the same way as the GPIB status byte.

For the details, see an instruction manual attached to Option 80.

4.15.2 Gated Sweep Function

[Function]

When the Gated sweep function is applied, the spectrums of burst signals are analyzed and recorded on magnetic tapes used for VTRs, 8mm videos, and digital audio tapes (DAT).

(1) How to Measure

Sweep the spectrum at TTL level "Hi" (or opened) by using the BNC connector at the gated sweep control terminal (Gate in terminal), and stop at "LO" level.

Input signals and gate control signals shall be specified as follows:

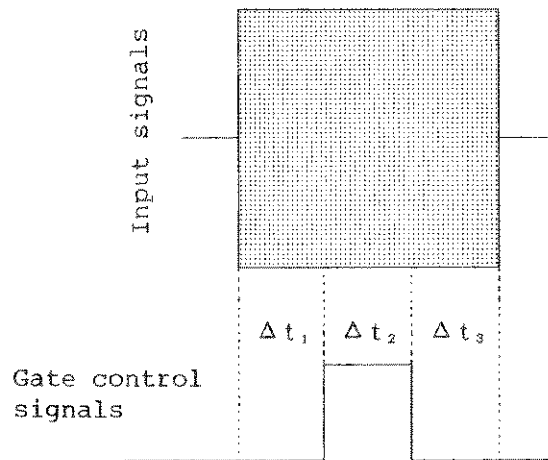

	RBW				
	1MHz	300kHz	100kHz	30kHz	10kHz
t_1	10 μ s or more	15 μ s or more	20 μ s or more	50 μ s or more	180 μ s or more
t_2	15 μ s or more				
t_3	1 μ s or more				

Note: Video BW 300kHz or more

Select "SAMPLE" mode for noise measurement.

4.16 Option 81

Option 81 consists of two functions: an internal controller function and a gated sweep function.

4.16.1 Internal controller

[Function]

An internal controller function of Option 81 has a serial I/O (RS-232) and a parallel I/O.

For the details of the controller function, see an instruction manual attached to R3261/3361 Option 81.

CAUTION

To prevent malfunction due to electromagnetic interference when a serial I/O (RS-232) terminal and a parallel I/O terminal are used, use shielded cables for connecting with an external terminal. Do not bundle connection cables with AC lines.

(1) RS-232 Port Setting

Set the RS-232 port when the external terminal is connected to the unit.

① Procedure and explanation

Refer to A.1 (7).

② RS-232 Port setting

Set the RS-232 port effectively using the window screen.

[Procedure and explanation]

Press .

The following screen is displayed.

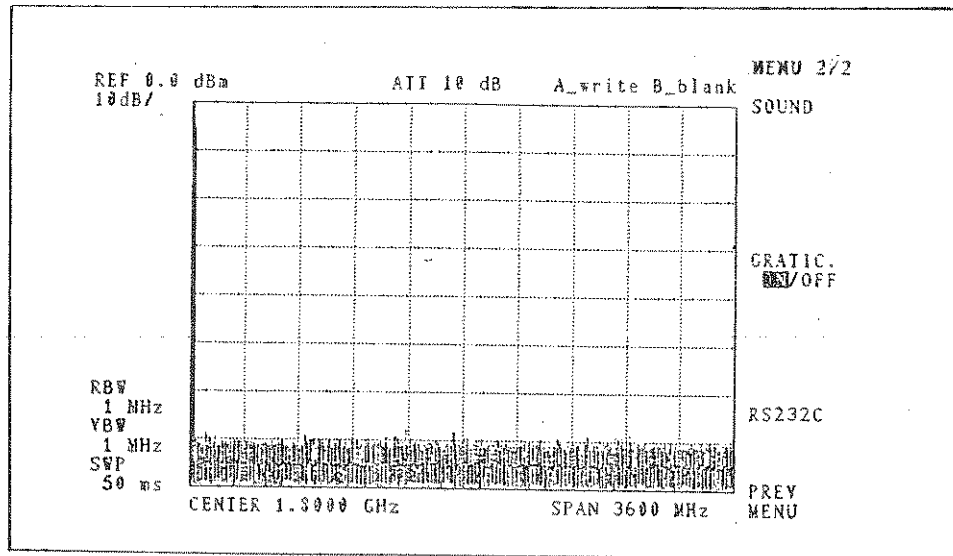

Press .

The following operating window screen is displayed (See next page), then set the conditions.

R3261/3361
SPECTRUM ANALYZER
INSTRUCTION MANUAL

4.16 Option 81

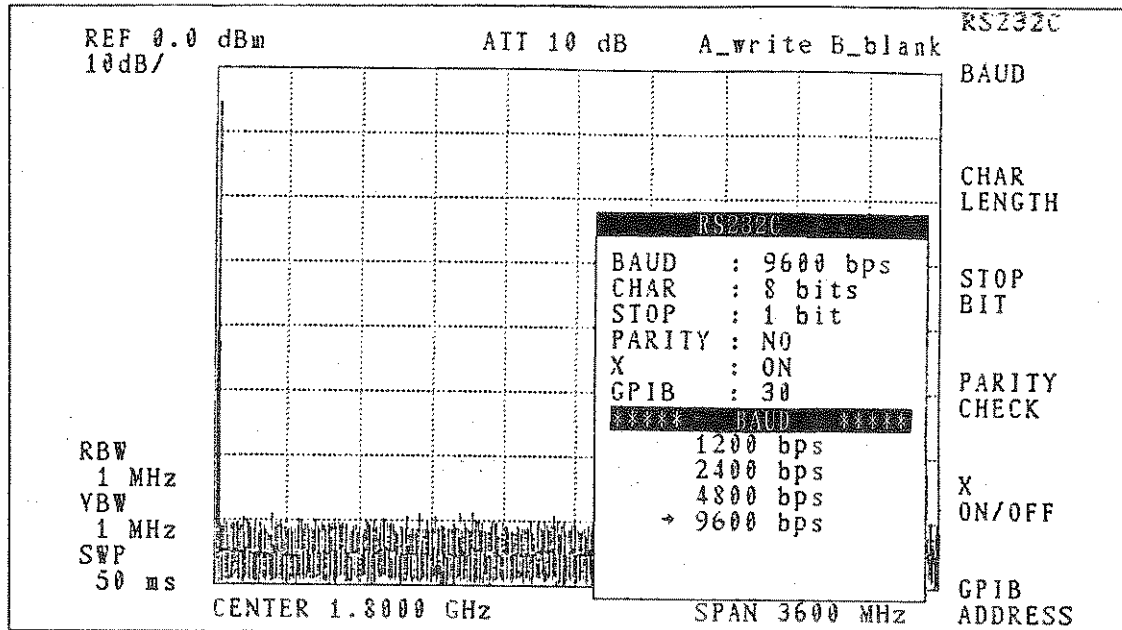

BAUD

Specify the transfer rate (baud rate). The transferable rates are as follows:

- (1) 1200bps
- (2) 2400bps
- (3) 4800bps
- (4) 9600bps ⇐ Initial value

CHAR LENGTH

Specify the data length. The data lengths selective are as follows:

- (1) 5bits
- (2) 6bits
- (3) 7bits
- (4) 8bits ⇐ Initial value

STOP BIT

Specify the stop bit. The stop bits selective are as follows:

- (1) Not approved
- (2) 1bit ⇐ Initial value
- (3) 1.5bits
- (4) 2bits

R3261/3361
SPECTRUM ANALYZER
INSTRUCTION MANUAL

4.16 Option 81

PARITY
CHECK

Specify the parity bit. The parity bits selective are as follows:

- (1) No parity ⇐ Initial value
- (2) Odd number parity
- (3) Even number parity

X
ON/OFF

Specify the data flow control. The conditions selective are as follows:

- (1) OFF (ignored)
- (2) ON

GPIB
ADDRESS

Set the controller GPIB address.

(2) Arrangement of Pin Connector

① Arrangement of SIO 25 pin D-sub connector terminal

Table 4 - 4 Arrangement of SIO 25-pin D-sub connector terminal

Terminal name	Signal name	Signal direction
1	GND	○→
2	TxD Transferring data	○←
3	RxD Receiving data	○→
4	RTS Request for transfer	○←
5	CTS Enable transfer	○←
6	DSR Data set ready	○←
7	GND	
8		
9		
10		
11		
12		
13		
14		
15		
16		
17		
18		
19		
20	DTR Data terminal ready	○→
21		
22		
23		
24		
25		

R3261/3361
SPECTRUM ANALYZER
INSTRUCTION MANUAL

4.16 Option 81

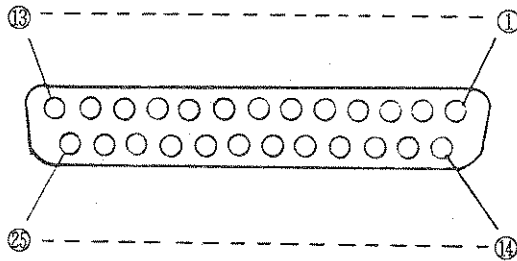

② Arrangement of PIO 36-pin connector terminal

Table 4 - 5 Arrangement of PIO 36-pin connector terminal

Terminal name	Signal name	Terminal name	Signal name
1	GND	19	*OE
2	IN0	20	OUT0
3	IN1	21	OUT1
4	IN2	22	OUT2
5	IN3	23	OUT3
6	IN4	24	OUT4
7	IN5	25	OUT5
8	IN6	26	OUT6
9	IN7	27	OUT7
10	IN8	28	OUT8
11	IN9	29	OUT9
12	IN10	30	OUT10
13	IN11	31	OUT11
14	IN12	32	OUT12
15	IN13	33	OUT13
16	IN14	34	OUT14
17	IN15	35	OUT15
18		36	

IN0 to IN15 : Input (TTL)

OUT0 to OUT15: Output (TTL open collector output and external pull-up resistor are required)

*OE : Input output enable negative logic

R3261/3361
 SPECTRUM ANALYZER
 INSTRUCTION MANUAL

4.16 Option 81

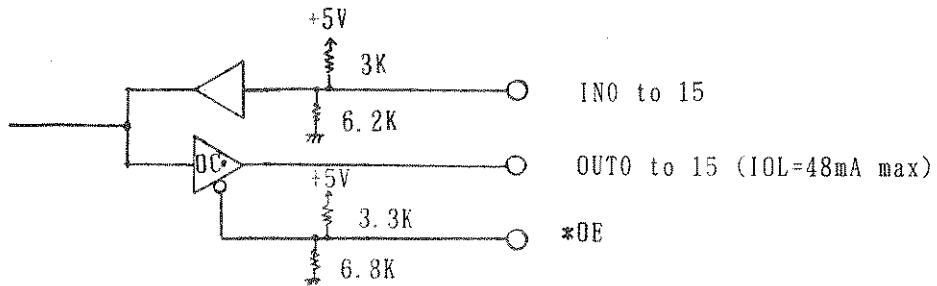
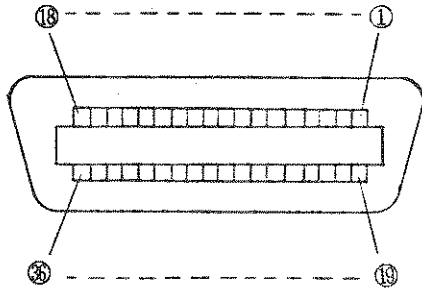

4.16.2 Gated Sweep Function

[Function]

When the Gated sweep function is applied, the spectrums of burst signals are analyzed and recorded on magnetic tapes used for VTRs, 8mm videos, and digital audio tapes (DAT).

(1) How to Measure

Sweep the spectrum at TTL level "Hi" (or opened) by using the BNC connector at the gated sweep control terminal (Gate in terminal), and stop at "LO" level.

Input signals and gate control signals shall be specified as follows:

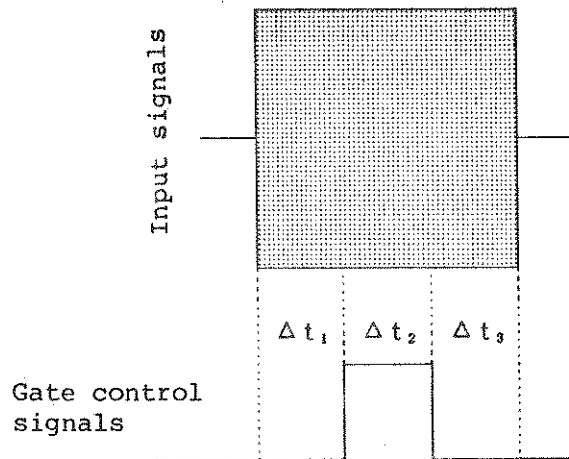

	RBW				
	1MHz	300kHz	100kHz	30kHz	10kHz
Δt_1	10 μ s or more	15 μ s or more	20 μ s or more	50 μ s or more	180 μ s or more
Δt_2	15 μ s or more				
Δt_3	1 μ s or more				

Note: Video BW 300kHz or more

Select "SAMPLE" mode for noise measurement.

R3261/3361
SPECTRUM ANALYZER
INSTRUCTION MANUAL

5. Tracking Generator Function

5. TRACKING GENERATOR FUNCTION

5.1 How to Use Tracking Generator

Operating procedure:

- ① Turn the tracking generator on and set the output level.

Press and set the output level using the ten keys, step key and data knob. (It can be set in 1 dB step.)

- ② Set the center frequency, frequency span and reference level.

Press and adjust using the ten key, step key or data knob.

Press and adjust using the ten key, step key or data knob.

Press and adjust either the ten key, step key or data knob.

CAUTION

If the tracking generator is used under the resolution bandwidth of 300Hz or less, the tracking error (a level error caused by a deviation between the output frequency of the tracking generator and the tuned frequency of the spectrum analyzer) may be occurred. Therefore, press

to make a tracking error minimum if the tracking generator is used under the resolution bandwidth of 300Hz or less. If the resolution bandwidth is 30Hz or 100Hz, the signal frequency is calibrated again approximately every 3 minutes. Therefore, the operation temporarily stop.

The signal frequency can be calibrated by pressing and by using the ten key, step key, or data knob.

- ③ Connect the TG OUTPUT connector with the INPUT connector with a cable. The frequency characteristics of the through current should appear on the display.

R3261/3361
SPECTRUM ANALYZER
INSTRUCTION MANUAL

5.1 How to Use Tracking Generator

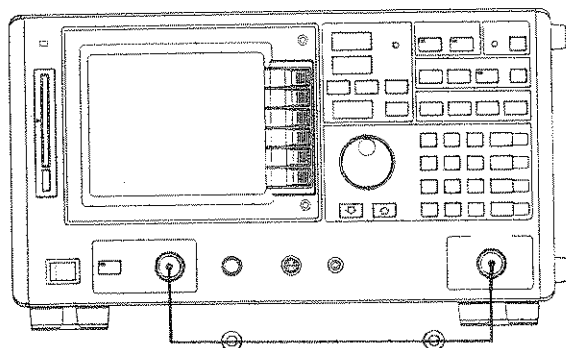

Through condition

- ④ Correct the error by the method described in Section 5.2 if the error due to the frequency characteristics of the output is large.
- ⑤ Connect the device to be measured (DUT).

CAUTION

If the input impedance and output impedance of the DUT are not 50Ω (R3261C/D, R3361C/D), 75Ω (R3261CN, R3361CN), match the impedances at the input and output side of the DUT.

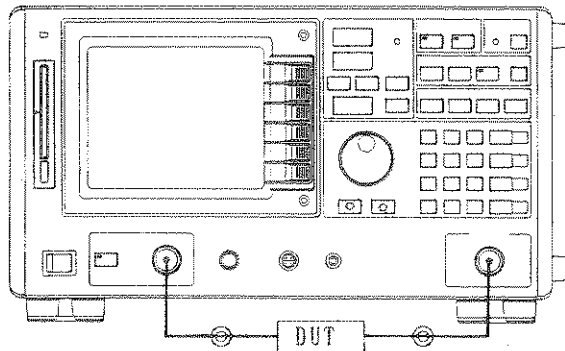

- ⑥ Start measurement.
See Section 5.3.

R3261/3361
SPECTRUM ANALYZER
INSTRUCTION MANUAL

5.2 How to Correct Frequency
Characteristics Using Display Line

5.2 How to Correct Frequency Characteristics Using Display Line

This section describes how to correct the cable's frequency characteristics when the frequency characteristics of the spectrum analyzer itself are corrected and the frequency characteristics of the filter utilizing the trace and display line are measured.

CAUTION

It the function data that changes the standard of normalization, such as center frequency, frequency span and reference level, is changed during operation of normalization, the proper normalization often cannot be made subsequently. Therefore, if the function data is changed, repeat the normalization sequence from the beginning.

Operating procedure:

- ① Set trace A mode (or B mode).

Press A (or B).

- ② Connect the TG OUTPUT connector directly with the INPUT connector by a cable.

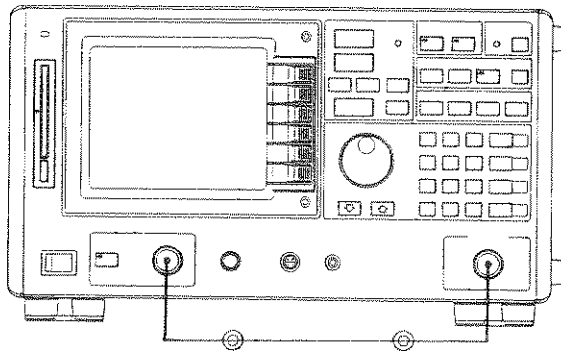

Through condition

R3261/3361
SPECTRUM ANALYZER
INSTRUCTION MANUAL

5.2 How to Correct Frequency
Characteristics Using Display Line

- ③ Change the reference level and lower the frequency characteristics of through current to the location where the waveform does not extend beyond the grid on the upper portion of the display.

Press and adjust, using either the step key or the data knob.

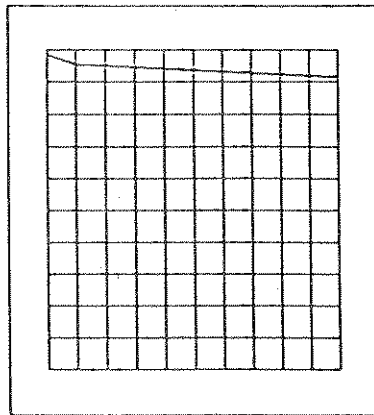

(Waveform Image)

- ④ Have the display line appear on the screen and adjust so that the display line comes close to the waveform of the through current. The closer the display line is to the waveform of the through current, the wider the dynamic range can be gained when measuring.

Press (or) (or) and adjust using either the step key or the data knob.

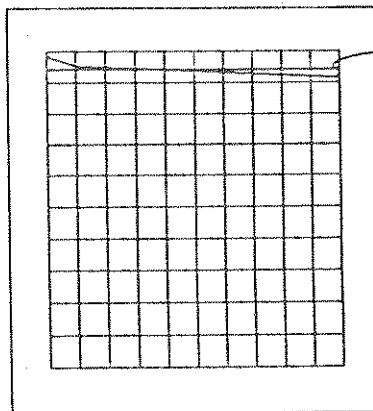

Display line

(Waveform Image)

R3261/3361
SPECTRUM ANALYZER
INSTRUCTION MANUAL

5.2 How to Correct Frequency
Characteristics Using Display Line

- ⑤ Correct the frequency characteristics.

Press

CORRECT
SAVE

NORM A
ON/OFF

 .

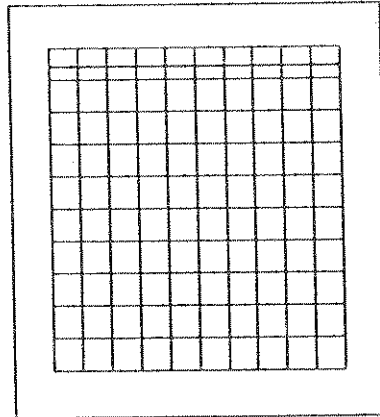

(Waveform Image)

- ⑥ To release the correction mode, press

NORM A
ON/OFF

 .

R3261/3361
SPECTRUM ANALYZER
INSTRUCTION MANUAL

5.3 Examples of Measurements

5.3 Examples of Measurements

This section presents examples of methods of measuring the insertion loss of the crystal filter, ripple, normal bandwidth and the amount of attenuation using the tracking generator. Read Sections 5.1 and 5.2 if you have not done so already.

(1) Preliminary condition

Condition of filter:	Center Frequency	:	10.7MHz
	Normal bandwidth (3dB)	:	15kHz
	Insertion loss (constant loss)	:	Less than 5dB
	Ripple	:	Less than ± 1 dB
	Attenuation	:	More than 60dB
Input impedance		:	50 Ω

Measurement should be done in the above condition.

(2) Start of measurement

Operating procedure:

- ① Connect the TG OUTPUT connector directly with the INPUT connector.

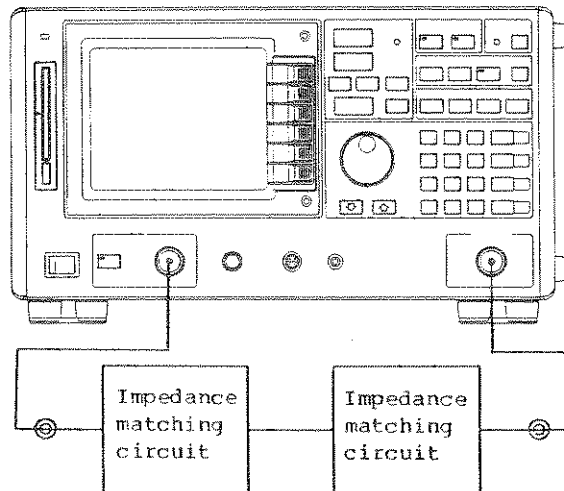

- ② Turn the tracking generator "ON".

Press TG . (The LED lamp on the key will light.)

- ③ Set the output level at -5dBm.

Press LEVEL 5 MHz .

- ④ Adjust the waveform peak value at the upper part of the display.

Press REF LEVEL and adjust using the step key or the data knob.

R3261/3361
SPECTRUM ANALYZER
INSTRUCTION MANUAL

5.3 Examples of Measurements

- ⑤ Lower the noise of the spectrum analyzer to a level where the measurement of the attenuation can be made adequately.

Press and adjust using the step key.

Press and adjust using the step key.

- ⑥ Set the frequency span at 50kHz, the center frequency at 10.7MHz and the vertical axis scale at 2dB/DIV.

Press .

Press .

Press .

- ⑦ Have the display line on the screen and match the display line to the reference level line.

Press (or) and adjust using the step key or the data knob.

- ⑧ If the normalize mode is set, the waveform of through current is normalized and matched to the reference level line.

This level is used as a reference for measuring the insertion loss.

Press (or).

CAUTION

If the function data regarding normalization is changed, such as center frequency, frequency span, and reference level, is changed during normalizing operation, the proper normalization often cannot be made subsequently. Therefore, if the function data is changed, repeat the normalization sequence from the beginning.

- ⑨ Connect DUT and set the sweep time so that the waveform will not vary.

See Section 5.4.2.

CAUTION

If the insertion loss of the filter is too great, sufficient dynamic range often cannot be obtained. When this happens, use the preamp for the input.

R3261/3361
SPECTRUM ANALYZER
INSTRUCTION MANUAL

5.3 Examples of Measurements

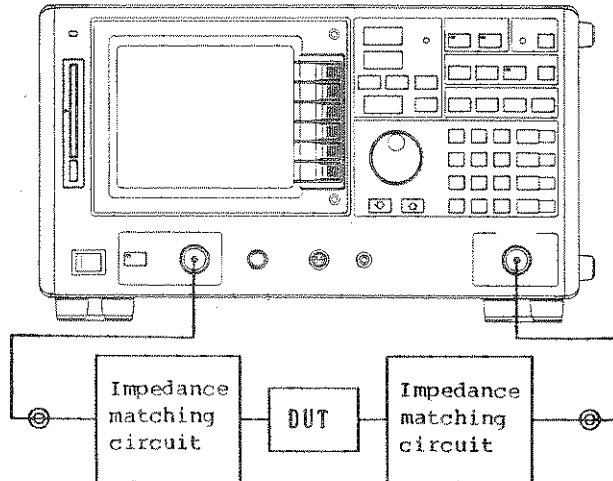

⑩ Start each measurement.

Shown below are four examples of measurements.

- a) Measurement of insertion loss (constant loss)
- b) Measurement of pass bandwidth (3dB)
- c) Measurement of ripple
- d) Measurement of attenuation

a) Measurement of insertion loss (constant loss)

Operating procedure:

① With the display line on the display, adjust the marker point to 10.7MHz.

Press .

② The difference of the level between the display line and the marker point is shown on the screen, and the insertion loss (constant loss) can be directly read.

R3261/3361
SPECTRUM ANALYZER
INSTRUCTION MANUAL

5.3 Examples of Measurements

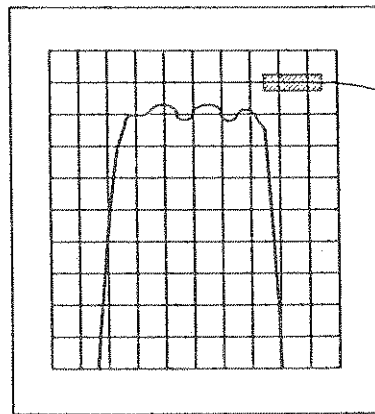

Wave-form image

Display of
level difference

b) Measurement of pass bandwidth (3dB)

Operating procedure:

- ① When measuring the insertion loss, set the xdB DOWN mode.

Press

NEXT	X dB
MENU	DOWN

.

- ② Input the attenuation level.

Press

3	GHz
---	-----

.

- ③ On the waveform, two marker frequencies are shown at points 3dB below and to the left and right of the marker point (10.7MHz), and 3dB of pass band can be read directly.

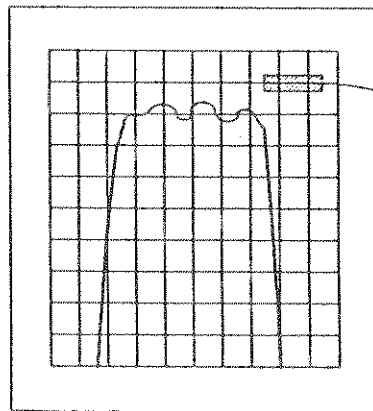

(Waveform Image)

Frequency difference
is displayed

R3261/3361
SPECTRUM ANALYZER
INSTRUCTION MANUAL

5.3 Examples of Measurements

c) Measurement of ripple

Operating procedure:

- ① Move the marker point to the lowest loss point.

Press .

- ② Move the marker point to the lowest level of the ripple.

Press

- ③ The level difference between the two marker points will appear on the screen, and this will become the ripple.

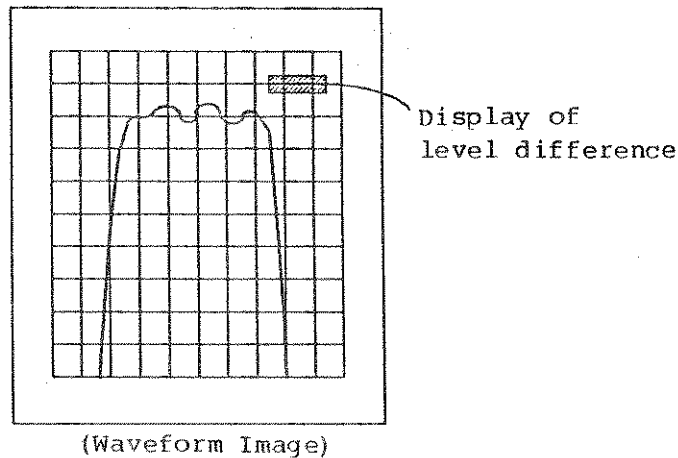

d) Measurement of attenuation

Operating procedure:

- ① Release the normalize mode.

Press

- ② Set the vertical axis on the screen at 10dB/DIV.

Press .

- ③ Set the optimum frequency span.

- ④ If the attenuation from the lowest loss is measured, press

.

R3261/3361
SPECTRUM ANALYZER
INSTRUCTION MANUAL

5.3 Examples of Measurements

If the attenuation from the nominal frequency is measured,

press .

- ⑤ Move the marker point to the point where the measurement is required.

Press and adjust using the data knob.

- ⑥ The level difference between the two markers is shown on the screen, this is the attenuation.

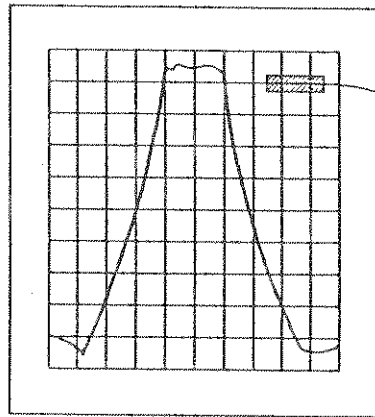

Display of
level difference

(Waveform Image)

5.4 Notes on Handling

5.4.1 Dynamic Range

The measured dynamic range is restricted by the maximum output level of this device and white noise level of the analyzer. To widen the dynamic range, it is necessary to narrow the resolution bandwidth (RBW) of the analyzer and to lower the noise level. (See the figure below.)

Because of the tracking signal into the analyzer (T.G. leak), the required noise level cannot be obtained from time to time even if the analyzer is set to the resolution bandwidth.

Since the T.G. leak is less than -110dBm, the measurement can be made using a filter having about 110dB of attenuation in the stop bank.

To prevent the T.G. leakage in the measurement system, the device under test (DUT) should be connected by using the well shielded cables.

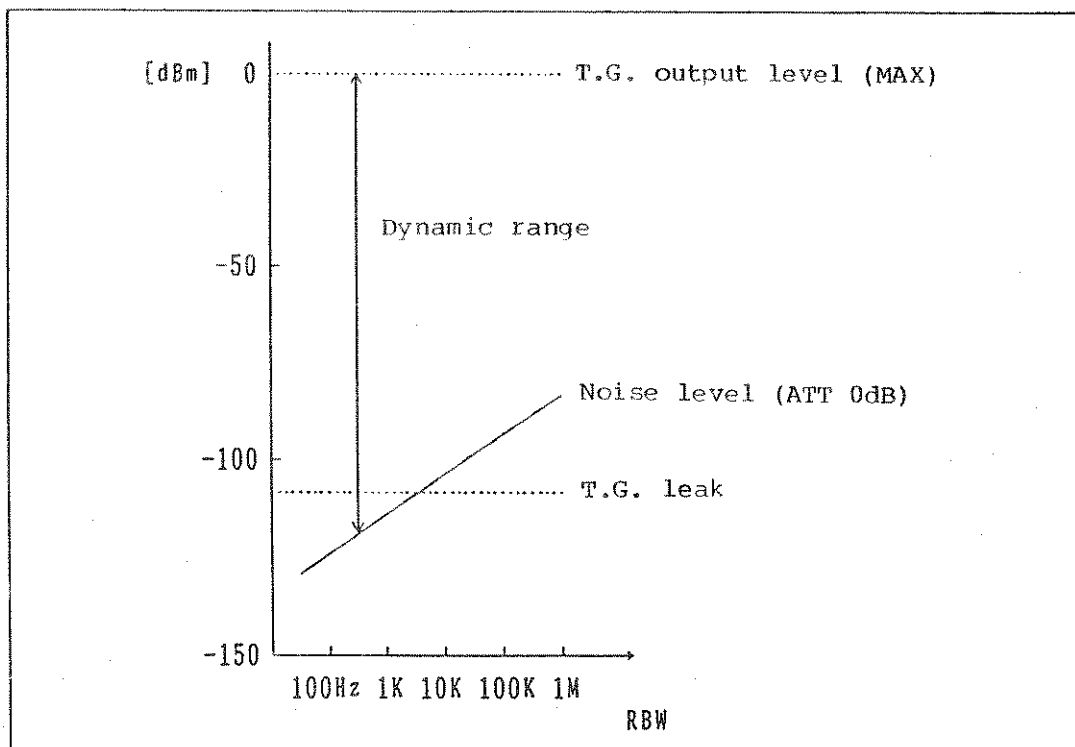

R3261/3361
SPECTRUM ANALYZER
INSTRUCTION MANUAL

5.4 Notes on Handling

CAUTION

1. The larger the insertion loss (including the loss of matching circuit) of DUT, the smaller the dynamic range measured. To avoid this, if the pre-amp is used for output, the measurement that does not impair the dynamic range measured can be made.
2. The selection of the output is determined depending on the DUT. At this time, the characteristics of the pre-amp must be identified also. When the output level of the tracking generator (such as amplification degree, frequency response, noise figure, maximum input, VSWR and input impedance) is too large, change the setting before using.
(A maximum attenuation of -50dBm can be achieved. (for R3361C/D))
(A maximum attenuation of +55dBμ can be achieved. (for R3361CN))

5.4.2 Time Response

Time response is shown on the CRT display and indicates if the level is correct. Sometimes the **LEVEL** message appears, but this has no effect on the operation when the frequency characteristics are measured using the analyzer.

This message indicates if the IF filter responds correctly to the time, and indicates the level correctly by the set combination of **FREQ SPAN**, **SWP** and **RBW** of the analyzer proper.

If the signal level change supplied from the output terminal of the measured device to the spectrum analyzer is small, if the **LEVEL** display appears, it is often correct.

When there are sharp fluctuations in the signal level supplied from the output terminal of the device to be measured to the spectrum analyzer, pay attention to the time response of the device to be measured, because the IF filter of the analyzer stops to respond.

When inspecting this time response, both the IF filter and the device to be measured respond sufficiently even if SWP is shifted, as long as the characteristics displayed on the screen remain unchanged. If the characteristics vary by shifting the SWEEP/DIV, delay the SWP or narrow the SPAN (sweep width of frequency) until the characteristics displayed on the screen stop changing.

5.4.3 Precautions on Using Low Output Level

If the output level is low (less than -49dBm or less than 56dBm), the TG frequency characteristic may be drastically varied according to the setting conditions of **FREQ SPAN** and **SWP**.
When this occurs, select the lower SWP condition (more than 100ms).

R3261/3361
SPECTRUM ANALYZER
INSTRUCTION MANUAL

5.4 Notes on Handling

5.4.4 Limit Voltage Value Applying to the TG OUTPUT Connector

- (1) Do not apply the voltage of $\pm 10V$ or more or the power of $+15dBm$ or more when the output level of the T.G is $0dBm$.

When such voltage or power is applied, there is a fear that the output part may be damaged.

- (2) To protect the output part against any damage, the output level of the T.G would be better to set to $-10dBm$ or less. In this case, each limit value of the voltage and the power to be applied becomes $\pm 29V$ and $+24dBm$.

5.4.5 Measurement of low frequency area.

The best waveform will occur in the vicinity of local field through (ZERO waveform) when the low frequency area is measured.

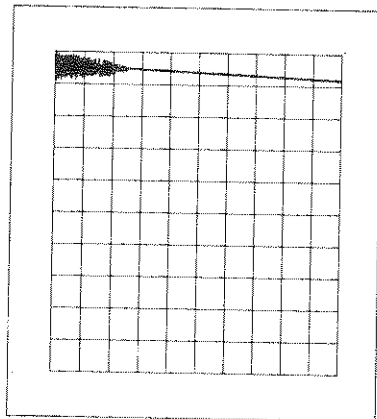

(Waveform Image)

Narrowly set at this time.

R3261/3361
SPECTRUM ANALYZER
INSTRUCTION MANUAL

6. Examples of Measurements

6. EXAMPLES OF MEASUREMENTS

R3261/3361
SPECTRUM ANALYZER
INSTRUCTION MANUAL

6. Examples of Measurements

NOTE

The measurement examples are based on the initial settings of the analyzer. Input the signal to be measured through a device such as an attenuator when necessary so that the signal is low enough below the maximum allowable input of the analyzer.

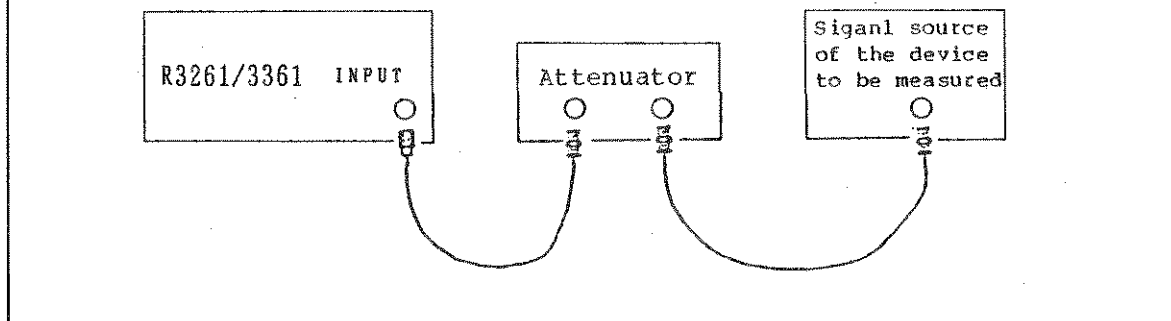

R3261/3361
SPECTRUM ANALYZER
INSTRUCTION MANUAL

6.1 Example of Measuring the Deviation

6.1 Example of Measuring the Deviation:

Example of Deviation Analysis of the 200MHz Band Transmitter

Operating procedure:

- ① Connect the transmitter with the analyzer after attenuating its output through RF coupler or the like. Since the maximum input level of the analyzer is +25dB when the attenuator is more than 10dB, select the coupler's value so that the RF coupler's output becomes less than +25dBm.

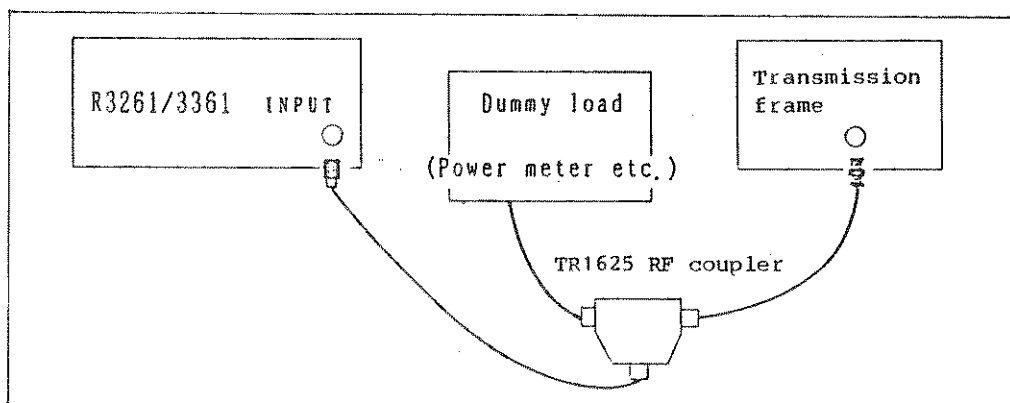

Figure 6 - 1 Measuring the Deviation of the Signal

- ② Display the fundamental wave so that it can be observed well and adjust the peak to the reference level.

Press .

Press .

Press .

- ③ Store the fundamental wave into the memory and display two screens including the new WRITE memory.

Press .

- ④ Set the step size of the step key at the frequency of the fundamental wave.

Press .

- ⑤ Observation of secondary high frequency wave

Press .

R3261/3361
SPECTRUM ANALYZER
INSTRUCTION MANUAL

6.1 Example of Measuring the Deviation

- ⑥ Display the marker at the peak of the secondary high frequency. The Marker's level display indicates the absolute level of the secondary high frequency wave.

Press PEAK.

- ⑦ Similarly, observe the tertiary high frequency wave.

Press B WRITE CENTER FREQ ↑ B VIEW PEAK.

[MEASUREMENT OF DEVIATION RATE OF HIGH HARMONIC WAVE]

In the low high-frequency area the deviation rate gauge is well known for measuring exclusively the deviation of the high harmonic waves. The high harmonic wave and micro wave must be measured similarly. This is often expressed as spurious modulation. In the High band amplifier it is measured as the high harmonic wave's deviation, as in the case for low frequency wave measurement. In general, the degree of deviation of a certain waveform from the pure sinusoidal wave is called the deviation rate and expressed in the equation.

$$\text{Deviation rate } K (\%) = \frac{\text{RSM value of high harmonic wave}}{\text{RSM value of fundamental wave}} \times 100$$

$$= \frac{\sqrt{A_2^2 + A_3^2 + \dots + A_n^2}}{A_1} \times 100$$

A_1 : RSM value of fundamental wave component

A_n : RSM value of n-th high harmonic wave component

The high harmonic wave's deviation rate is expressed by the ratio between the signal's high harmonic wave and the fundamental wave's (A_1). In the spectrum analyzer, the fundamental wave (A_1), secondary high harmonic wave (A_2) and the n-th high harmonic wave (A_n) can be directly seen separately. Hence, the measurement of the deviation rate to the secondary high harmonic wave (A_2/A_1) and the deviation rate (A_n/A_1) to the n-th high harmonic wave can be separately measured. Therefore, the measurement to find the degree of deviation from the odd or even number high harmonic wave or can be made based on the more fundamental principal of the deviation rate measurement.

The spectrum analyzer expresses a wider dynamic range, and indication is made in log (dB). As the deviation rate of the n-th high harmonic wave is $20 \log (A_n/a_1)$, if a_n is 40dB, it is found that $(A_2/A_1) \times 100 (\%)$ is 1%.

Usually decibel indication is made reading the a_2 (20dB).

R3261/3361
SPECTRUM ANALYZER
INSTRUCTION MANUAL

6.2 Measurement of Modulation
Frequency and Modulation Index of AM Signal

6.2 Measurement of Modulation Frequency AM Signal and Modulation Index AM Signal

Performance of the spectrum analyzer is superior to that of the time domain oscilloscope for measuring low degrees of modulation as in residual AM or residual FM.

The modulation index "m" of the AM wave is obtained from the equation $m = (E_{max} - E_{min}) / (E_{max} + E_{min})$ in the time domain. (See Figure 6 - 2 (a).)

If the same value is calculated using the spectrum analyzer, the measurement can show how many decibels lower the side band is than the carrier wave. (See Figure 6 - 2 (b).)

At the same time, the degree of modulation of the modulation wave compared to the high harmonic wave can be obtained. Especially, when the modulation is shallow, the spectrum analyzer can read degrees down to 0.02% while the time domain can read only down to 2%.

The measurement accuracy can be increased if the LINEAR mode is used when the modulation index is more than 10% and if the LOG mode is used when the index is less than 10%.

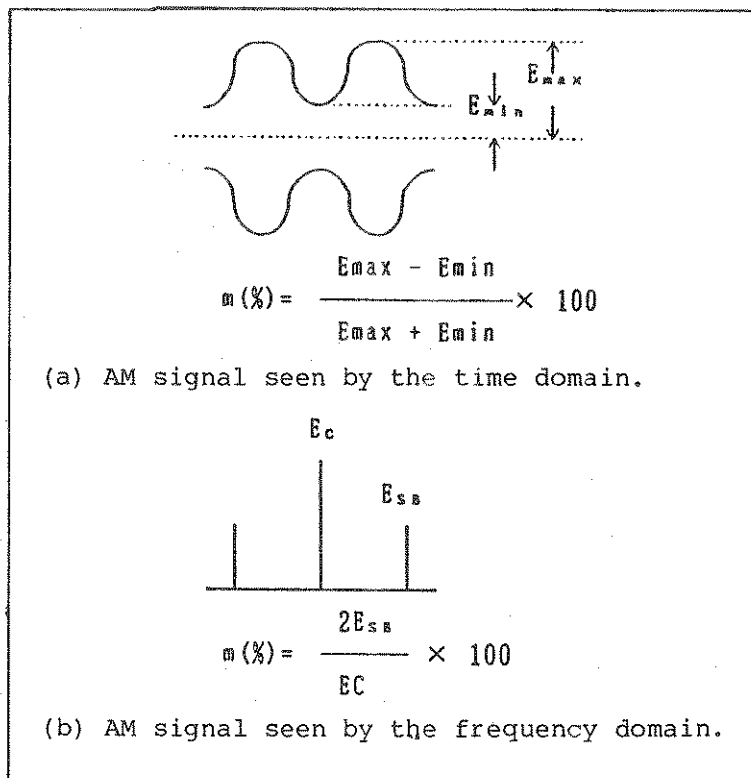

Figure 6 - 2 AM Signal Wave

R3261/3361
SPECTRUM ANALYZER
INSTRUCTION MANUAL

6.2 Measurement of Modulation
Frequency and Modulation Index of AM Signal

6.2.1 Example of Measuring when the Modulation Frequency of AM Wave is Low
and the Modulation Index is Large

Operating procedure:

- ① Display the signal to be measured and adjust its peak to the reference level. In this example the carrier wave is 903MHz.

Press **CENTER FREQ** **9** **0** **3** **MHz** .

Press **FREQ SPAN** **2** **0** **MHz** .

Press **PEAK** **MKR →** **MKR → REF** .

- ② Set the resolution bandwidth three times wider than the modulation frequency value.

Press **COUPLE** **RBW** **↑** .

- ③ Set the vertical scale as LINEAR.

Press **REF LEVEL** **LIN** .

- ④ Set in the ZERO SPAN mode.

Press **FREQ SPAN** **ZERO SPN** .

- ⑤ Make the trace detection mode SAMPLE.

Press **MENU** **DETECTOR** **SAMPLE** .

- ⑥ Press **CENTER FREQ** and adjust using the data knob. Adjust so that the signal level is at a maximum.

- ⑦ Make the TRIGGER mode VIDEO.

Press **MENU** **TRIGGER** **VIDEO** .

- ⑧ Set the sweep time to a value that is easy to observe.

Press **COUPLE** **SWEEP TIME** and adjust using the step key.

- ⑨ Measure the intervals between the peaks of the modulation signals, namely frequency of the modulated waves $T(S)$, using the marker. Set the Δ marker to the subsequent peak.

Press **PEAK** **ON** **DELTA MKR** , and adjust using the data knob.

The frequency of the modulation signal can be obtained from the following equation.

R3261/3361
SPECTRUM ANALYZER
INSTRUCTION MANUAL

6.2 Measurement of Modulation
Frequency and Modulation Index of AM Signal

$$f_m = \frac{1}{T(S)}$$

- ⑩ Align the marker to the maximum value of the waves and read the level E_{max} .

Press

- ⑪ Align the marker to the lowest value of the waves and read the level E_{min} . Align the marker to the lowest level line of the waves using the data knob.

- ⑫ Assign appropriate values to the following equation and determine modulation index of "m".

$$m (\%) = \frac{E_{max} - E_{min}}{E_{max} + E_{min}} \times 100 (\%)$$

6.2.2 Measuring Example of AM Wave when the Modulated Frequency is High and the Modulation Index is Small

Operating procedure:

- ① Set the frequency span at less than 10 times the modulated frequency.

Press and adjust using the step key.

- ② Set the central frequency at the frequency of the carrier waves.

Press and adjust using the data knob.

- ③ Align the marker to the peak of the carrier waves.

Press .

- ④ Align the Δ marker to the peak of the modulated signal spectrum.

Press and adjust using the data knob.

- ⑤ From the Δ marker frequency and level display at this time, the modulated frequency f_m and modulation index m can be obtained using the equation below.

$f_m = \Delta$ marker frequency

$$m = \log^{-1} \frac{E_{SB} - E/C + 6}{20}$$

Figure 6 - 3 shows the relationship between the value of $\langle E_{SB} - E_C \rangle$ and $m (\%)$.

R3261/3361
SPECTRUM ANALYZER
INSTRUCTION MANUAL

6.2 Measurement of Modulation
Frequency and Modulation Index of AM Signal

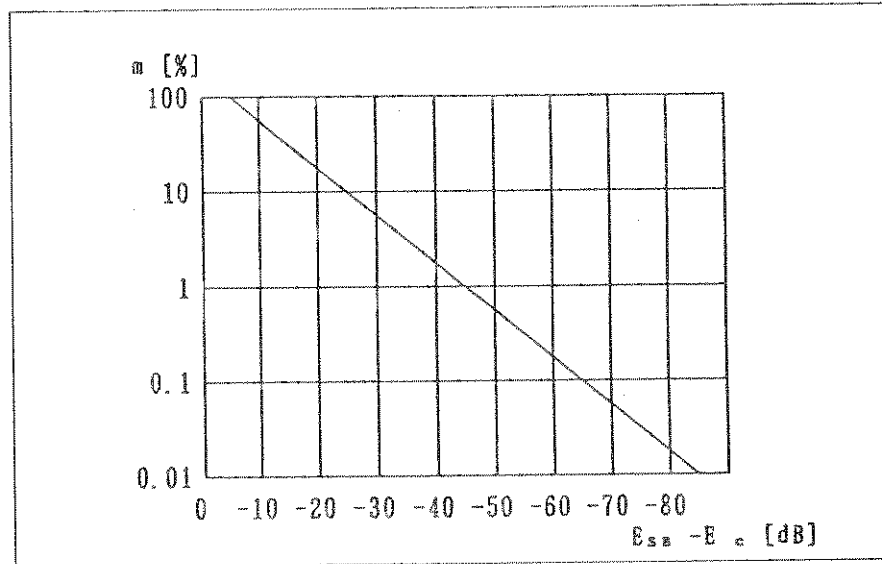

Figure 6 - 3 Relationship between the Value of Side Wave Band Level - Carrier Wave Level ($E_{sb} - E_c$) and Modulation Index m (%)

6.3 Measurement of FM Wave

6.3 Measurement of FM Wave

Generally, when observing FM waves, frequency of the carrier wave f_c , the frequency of modulated wave f_m , the deviation of the frequency Δf_{peak} , modulation index m , occupied bandwidth, etc. are measured.

The modulation index m of FM waves is expressed as: $\Delta f_{peak}/f_m$.

By obtaining the relationship when the carrier wave becomes smallest and the modulation indexes are at 2.4, 5.5, 8.6, the modulation index m or the frequency deviation Δf_{peak} can be obtained. (See Figures 6 - 4(a) and 6 - 4(b).)

Sometimes, the modulation cannot be read only through the FM wave spectrum. It can be easily read if the FM of the exterior signal is displayed after converting into the form of fluctuation of the amplitude. In this case the discriminator is additionally needed. However, in the spectrum analyzer, it can be detected utilizing the slope of IF, B.P.F. The detected modulated wave is displayed. (See Figure 6 - 4(c).)

When the modulated frequency is low, set the horizontal axis of the analyzer as ZERO SPAN, operate as a fixed tuning receiver, and set in the time axis. When the modulated frequency is high, measure on the frequency axis and obtain the modulated frequency from the frequency of the side wave band. When the modulation index is small (less than about 0.8), m can be obtained from the relationship between the carrier wave and the first side wave band level.

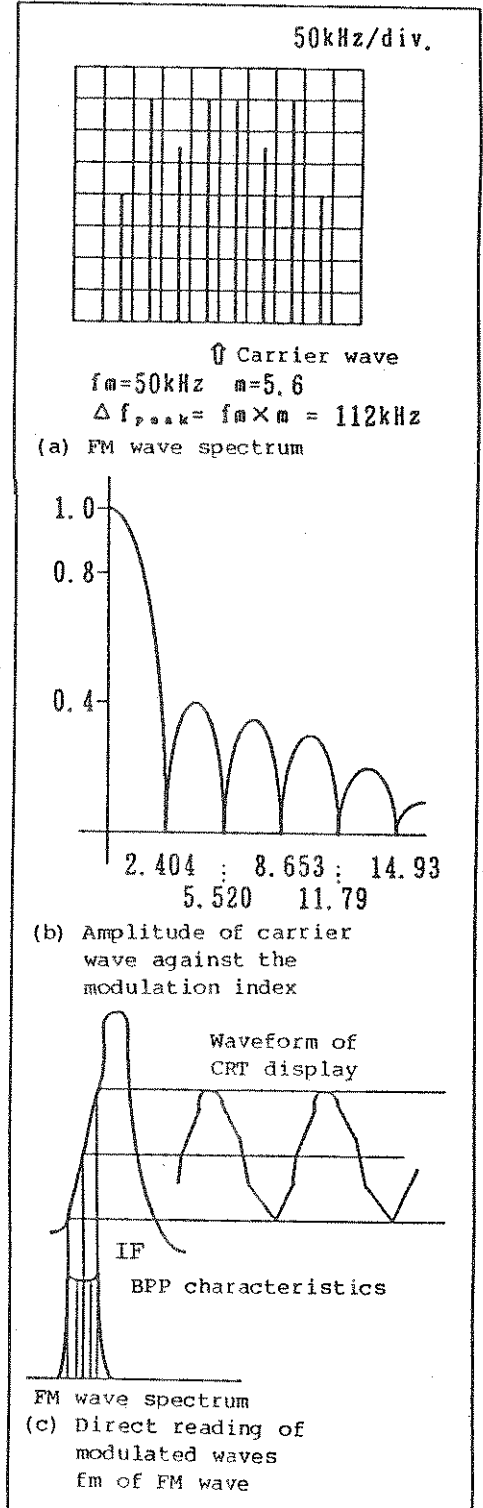

Figure 6 - 4 FM Signal

6.3.1 Example of Measuring FM Wave with Low Modulated Frequency

Operating procedure:

- ① Set so that the carrier wave of the signal becomes the center frequency.

Press **CENTER FREQ** and adjust using either the step key or the data knob.

- ② Take the signal's peak as the reference level.

Press **PEAK** **MKR →** **MKR → REF**.

- ③ Select the ZERO SPAN mode.

Press **FREQ SPAN** **ZERO SPAN**.

- ④ Change the central frequency so that the demodulation wave appears at the center of the screen.

Press **CENTER FREQ** and adjust using either the step key or the data knob.

- ⑤ Make the resolution bandwidth more than three times the modulated frequency so that the demodulation wave can be readily seen.

Press **COUPLE** **RBW** and adjust using the step key.

- ⑥ Set the trigger mode at VIDEO.

Press **MENU** **TRIGGER** **VIDEO**.

- ⑦ Select the sweep time so that the demodulation wave can be readily seen.

Press **COUPLE** **SWEEP TIME** and adjust using the step key.

- ⑧ Set the marker at the peak of the demodulation wave.

Press **PEAK**.

- ⑨ Align the marker to the adjacent peak.

Press **ON** **DELTA MKR** and adjust using the data knob.

R3261/3361
SPECTRUM ANALYZER
INSTRUCTION MANUAL

6.3 Measurement of FM Wave

- ⑩ If the time interval of the demodulation wave's peak is taken as $T(S)$ from the Δ marker, f_m can be obtained using the equation:

$$f_m = \frac{1}{T(S)}$$

6.3.2 Example of Measuring the FM Wave with a High Modulated Frequency and a Small "m"

Operating procedure:

- ① Set the frequency span at the value lower than ten times the modulated frequency.

Press and adjust using the step key.

- ② Set the carrier wave at the center frequency.

Press and adjust using the data knob.

- ③ Set the marker at the peak of the carrier wave.

Press .

- ④ Place the Δ marker at the peak of the adjacent side wave band.

Press and adjust using the data knob.

Display of the Δ marker's frequency becomes the modulated frequency f_m .

6.3.3 Measurement Example of FM Wave Frequency Deviation (Δf peak)

Operating procedure:

- ① Set the resolution bandwidth to the value that includes the main side wave band, or five times greater than the modulated frequency.

Press and adjust using the step key.

- ② Set the center frequency at the carrier wave frequency.

Press and adjust using the data knob.

- ③ Set the frequency span, in accordance with peak deviation, at the value easiest to measure.

Press and adjust using the step key.

- ④ Measure Δf_{peak} . Use the equations below to obtain the Δf_{peak} and modulation exponent.

$$\Delta f_{\text{peak}} = \frac{1}{2} \Delta f_{\text{peak peak}}$$

$$m = \frac{\Delta f_{\text{peak}}}{f_m}$$

- When Δf_{peak} is small: See Figure 6 - 5

In this example, $\Delta f_{\text{peak peak}}$
 = (Δf marker frequency)/2
 = 2.31kHz

$$\Delta f_{\text{peak}} = \frac{1}{2} \Delta f_{\text{peak peak}}$$

$$= 1.155\text{kHz}$$

- When Δf_{peak} is large: See Figure 6 - 6

In this example, $\Delta f_{\text{peak peak}}$
 = (Δf marker frequency)/2
 = 580kHz

$$\Delta f_{\text{peak}} = \frac{1}{2} \Delta f_{\text{peak peak}}$$

$$= 290\text{kHz}$$

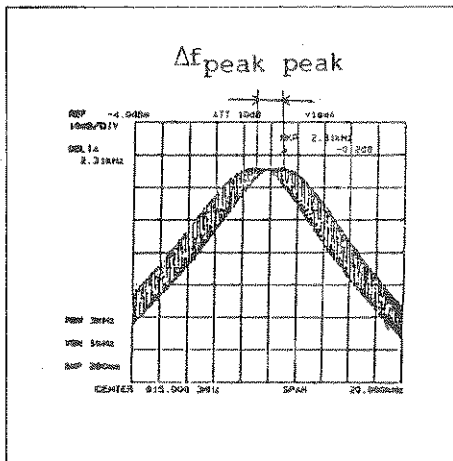

Figure 6 - 5 When Δf_{peak} is small

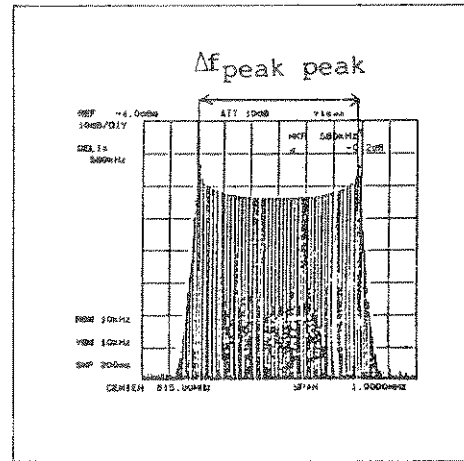

Figure 6 - 6 When Δf_{peak} is large

6.3.4 Obtaining Small FM Modulation Exponent m

When m, the FM modulation exponent of FM waves, is lower than 0.8, using the following equation.

$$m = \frac{2E_{SB}}{E_C}$$

E_{SB} : first side band wave level

E_C : carrier wave level

Operating procedure:

- ① Set the center frequency and frequency span where the carrier wave is easiest to measure, then adjust the carrier wave level to the reference level.

Press and adjust using the data knob.

Press and adjust using the step key.

Press and adjust using the data knob.

- ② Find carrier wave frequency (f_C) in the center frequency display and carrier wave level (E_C) in the reference level frequency. (See Figure 6 - 7.)

- ③ Place the Δ marker on the first side band wave and find the frequency (f_{SB}) and level (E_{SB}) in the Δ marker display.

Press and adjust using the data knob.

- ④ Obtain FM modulation exponent (m) using the equation:

$$m = 2 \times \frac{E_{SB}}{E_C} = \log^{-1} \frac{E_{SB} - E_C + 6}{20}$$

- ⑤ Obtain modulation frequency (f_m) using the equation:

$$f_m = |f_{SB} - f_C|$$

- ⑥ Obtain frequency deviation (Δf_{peak}) using the equation:

$$\Delta f_{\text{peak}} = m \times f_m$$

R3261/3361
SPECTRUM ANALYZER
INSTRUCTION MANUAL

6.4 Measurement of Pulse Modulation Wave

6.4 Measurement of Pulse Modulation Wave

The spectrum analyzer equivalently analyzes waveforms and displays high frequency basic waves. Spectrum distribution (See Figure 6 - 7(b).) with its envelope centered around the carrier wave frequency can be obtained by converting the time axis waveform of pulse modulation wave to frequency axis as illustrated in Figure 6 - 7(a).

The following can be easily obtained if such pulse modulation waves as radar are measured through the spectrum analyzer.

- Pulse repetition frequency (PRF)
- Pulse width (τ)*
- Carrier frequency (f_c)**
- Peak power (P_{peak})
- Average power (P_{ave})

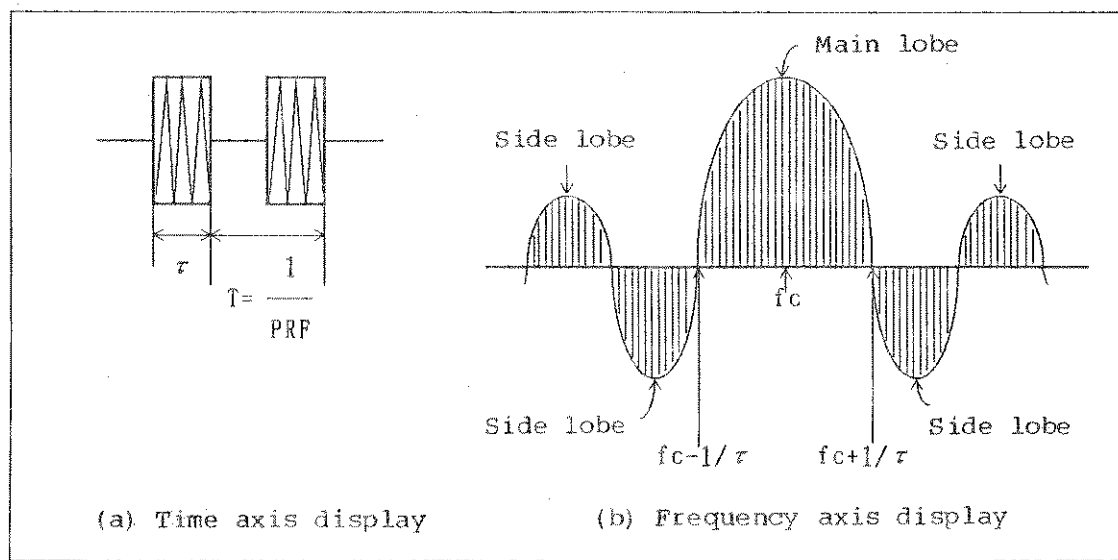

Figure 6 - 7 Pulse Modulation Wave

CAUTION

1. The maximum input level of the main unit is +25dBm, +50VDC, with the input attenuator set at 10dB or higher. Radar and other pulse modulation waves having a very high peak power must be attenuated through a coupler before inputting to the main unit connector.
2. The input level of the main unit mixer is -10dBm. The input attenuator must be set at $P_{\text{peak}} \leq -10\text{dBm}$. To prevent mixer saturation, find the lowest possible attenuator value, where the signal level does not decline, by starting with 50dB and lowering in 10dB steps.

R3261/3361
SPECTRUM ANALYZER
INSTRUCTION MANUAL

6.4 Measurement of Pulse Modulation Wave

(1) Pulse Width (τ)

Pulse width (τ) is obtained from the reciprocal of half the lobe width or the reciprocal of the side lobe width. In order to get the envelope having sufficient resolution, set the resolution bandwidth in the following range.

$$\text{Pulse repetition frequency (PRF)} \times 1.7 \leq \text{resolution bandwidth} \leq 0.1/\tau$$

(2) Carrier Frequency (τ)

Measurement accuracy of the carrier frequency (f_c) is determined by the pulse width (τ). A small r broadens the main lobe and makes recognition of the center difficult. So set the SPAN/DIV broader than $1/r$ to easily recognize the center. The measurement frequency accuracy will be the center frequency accuracy of the specified SPAN/DIV.

(3) Peak Power (P_{peak})

Only when the spectrum analyzer bandwidth satisfies the following condition, amplitude display becomes proportional to resolution bandwidth.

$$\text{Pulse Repetition Frequency (PRF)} \times 1.7 \leq \text{resolution bandwidth} \leq 0.2/\tau$$

When the amplitude display is proportional to the resolution bandwidth, the relationship between the peak power (P_{peak}) (dBm) and the amplitude display (P'_{peak}) (dBm) is shown in the following equations.

$$P_{\text{peak}} = P'_{\text{peak}} + \alpha \text{ (dB)}$$
$$\alpha \text{ (dB)} = 20 \log (r \times 1.5 \times \text{RBW}) \quad \alpha : \text{ pulse attenuation factor}$$

(4) Average Power (P_{ave}) (dBm)

P_{ave} (dBm) is obtained using the following equation.

$$P_{\text{ave}} = P_{\text{peak}} \times \text{PRF} \times \tau$$

PRF: pulse repetition frequency (Hz)
 τ : pulse width (s)

6.5 Noise Level Measurement

6.5.1 Measurement Example of Noise Level Absolute Value (dBm/Hz, dB μ V/ \sqrt Hz)

When measuring the noise by regulating in the noise power 1Hz bandwidth, first average the noise using the video bandwidth or the averaging function, then measure the noise level, and obtain the noise level absolute value with the following equation.

$$N \text{ dBm/Hz} = P + 10\log\left(\frac{1}{\text{RBW} \times 1.2}\right) + K_n$$

N : 1Hz bandwidth conversion noise level

P : Measured noise level

RBW: Resolution bandwidth (Hz) set in the main unit

K_n : Value adjusted in log mode (dB) = 2.5dB

These calculations can be internally carried out in the main unit.

Operating procedure:

- ① Place the marker on the noise signal (145MHz) to be measured.

Press .

- ② Set the video bandwidth (VID BW) to 1/30 the specified resolution bandwidth. Press .

- ③ Marker

When is set, appear on the screen.

Press for the level display unit dBm, and press for the dB μ .

When is set, the marker level display appears on the upper right-hand corner of the screen, showing 1Hz band conversion noise level in "XX dBm/Hz".

- ④ Press to cancel the noise measuring mode. To convert the noise power bandwidth to another one, add the following to the value displayed.

$$K_B = 10\log_{10} \left(\frac{\text{Band width to be converted}}{1\text{Hz}} \right)$$

R3261/3361
SPECTRUM ANALYZER
INSTRUCTION MANUAL

7. GPIB : Remote Programming

7. GPIB : REMOTE PROGRAMMING

R3261/3361
SPECTRUM ANALYZER
INSTRUCTION MANUAL

7.1 Outline

7.1 Outline

CAUTION

To prevent malfunction due to electromagnetic interference when a GPIB is used, use shielded cables for connecting with an external terminal.

Do not bundle connection cables with AC lines.

The main unit, loaded with the IEEE 489-1978 general purpose interface bus (GPIB), enables full remote control from the external controller.

(1) GPIB Extensibility and Compatibility

The GPIB is an interface system connected via cables (sub lines) to a measuring apparatus, controller, and peripheral devices. This system is far more extensible than the conventional systems and is electrically, mechanically, and functionally compatible with other manufacturers' devices. System configuration may be as simple as a single bus line or a high-grade automatic measuring system.

(2) Talker, Listener, Controller

In GPIB systems, devices on the other end of the bus lines are assigned with addresses. Each device can take one or more of the following roles: talker, listener, controller. During system operation, only one talker can transmit data on the bus line, but two or more listeners receive the data. A controller specifies the talker and listener addresses to transfer data from the talker to the listener, and lets the talker assign listener measuring conditions.

(3) GPIB Panels

Front panel

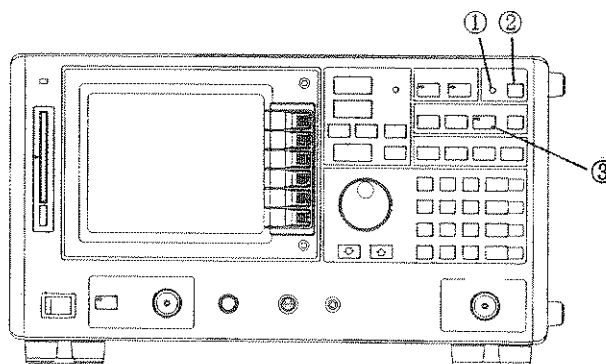

R3261/3361
SPECTRUM ANALYZER
INSTRUCTION MANUAL

7.1 Outline

Rear panel

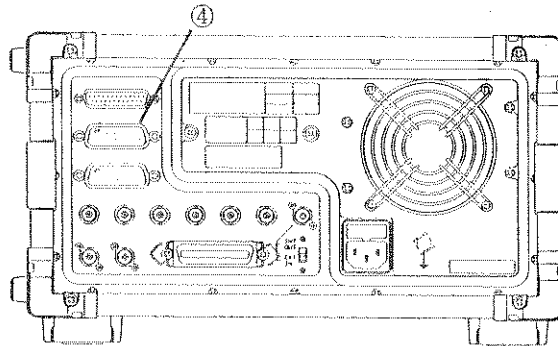

- ① REMOTE lamp:
Lights while the main unit is in external control mode.
- ② LCL key:
Remote/local switch. Interrupts external control and enables on-panel input.
- ③ SHIFT key:
Press this key and ② LCL key to start GPIB address setting.
- ④ GPIB connector:
Insert the GPIB cable here to connect to the external controller or plotter.

(4) Externally Controlled Functions

- ① Measuring condition setting:
Inputs measuring condition in the same manner as key entries on the panel.
- ② Measuring set condition output:
Calls data and set conditions from the main unit.
- ③ Measurement input/output:
Writes and reads screen trace data.
- ④ Service request to controller:
Requests the controller to interrupt processing and to output status bytes.

(5) Option 81 (system control with internal BASIC)

If the Option 81 is equipped to the spectrum analyzer, the unit is remote-controlled with the external controller or carries out the following operations:

- Control the analyzer using the internal BASIC.
- Control the external devices connected to the analyzer using the internal BASIC.

(For the details, see an instruction manual attached to Option 81.)

7.2 GPIB Standards & Main Unit GPIB Specifications

7.2 GPIB Standards & Main Unit GPIB Specifications

(1) Bus Line

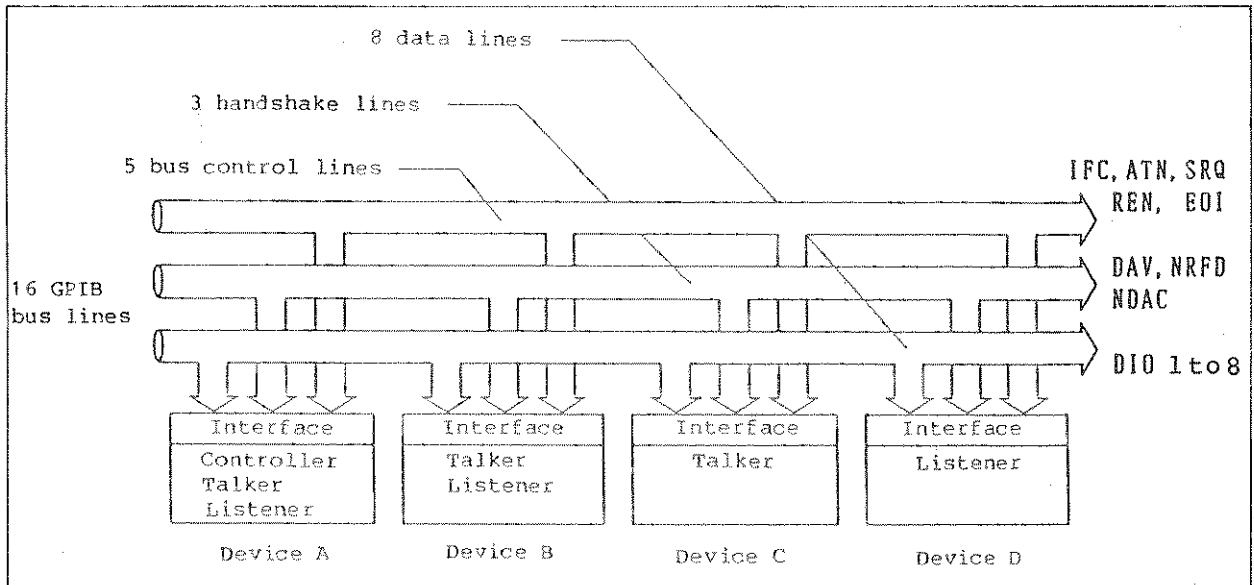

Figure 7 - 1 GPIB Bus Line Configuration

GPIB bus lines include eight data lines, three handshake lines for controlling asynchronous data transmission between devices, and five control lines.

- Data lines:

Eight bit-parallel-byte-serial data lines are used for bi-directional data transmissions between devices. The asynchronous feature permits simultaneous connection of both high and low speed devices. Data (message) transmitted between devices includes measurements, measuring conditions (programs), and commands in ASCII code.

- Handshake lines:

The following signals are used.

- DAV (Data Valid) : Indicates that the data is valid.
- NRFD (Not Ready For Data): Indicates that it is ready to receive data.
- NDAC (Not Data Accepted) : Indicates the end of data reception.

- Control lines:

The following signals are used.

- ATN (Attention) : Discriminates addresses and commands on the data line from other information.
- IFC (Interface Clear) : Clears interface.
- EOI (End of Identify) : Used at the end of data transmission.

R3261/3361
SPECTRUM ANALYZER
INSTRUCTION MANUAL

7.2 GPIB Standards & Main Unit GPIB Specifications

- SRQ (Service Request) : Requests controller service to a certain device.
- REN (Remote Enable) : Used to remote control remote programmable devices.

(2) Connector: 24 pin GPIB connector, 57-20240-D35A (an Amphenor or its equivalent)

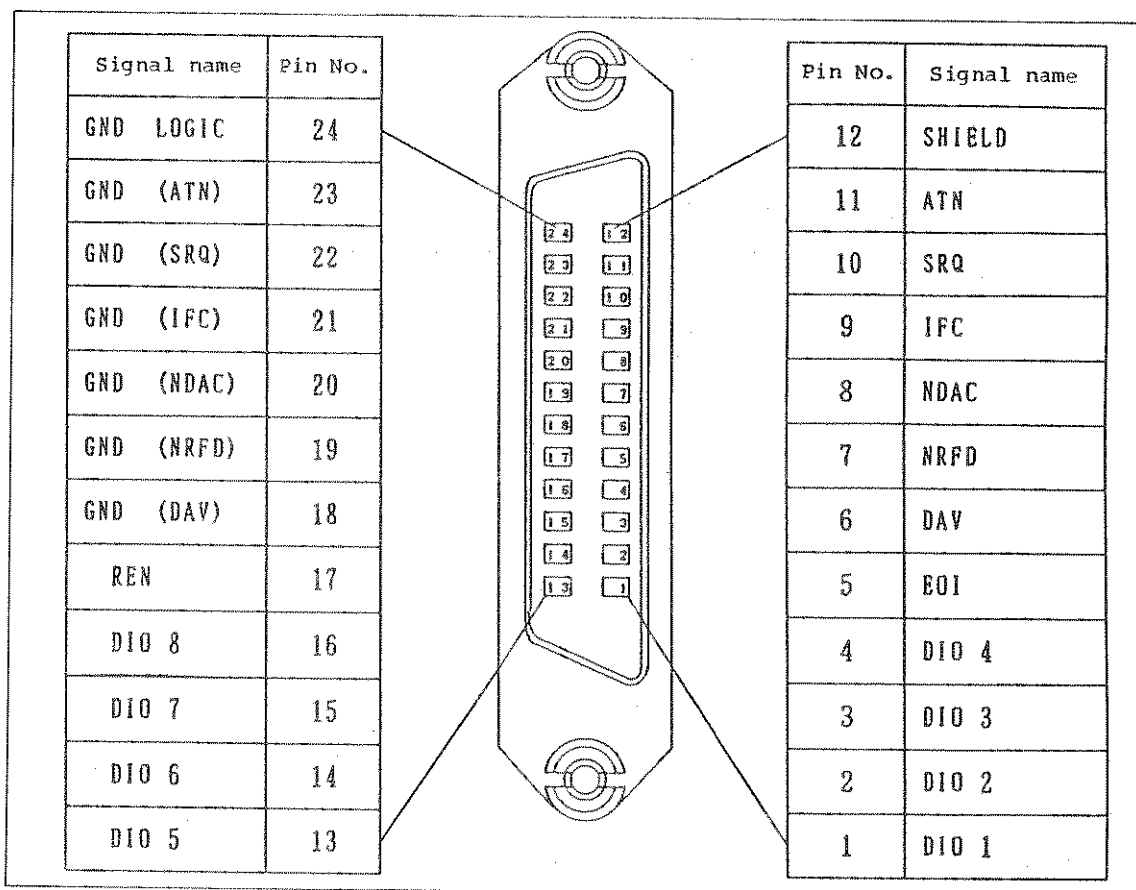

Figure 7 - 2 GPIB Connector Pin Configuration

7.2 GPIB Standards & Main Unit GPIB Specifications

(3) Specifications

Code : ASCII code, except at packed formatting when binary codes are used.

Logical level : Logic 0 "high" +2.4V or greater
Logic 1 "low" +0.4V or less

Signal line end : 16 bus lines terminate as illustrated in Figure 7 - 3.

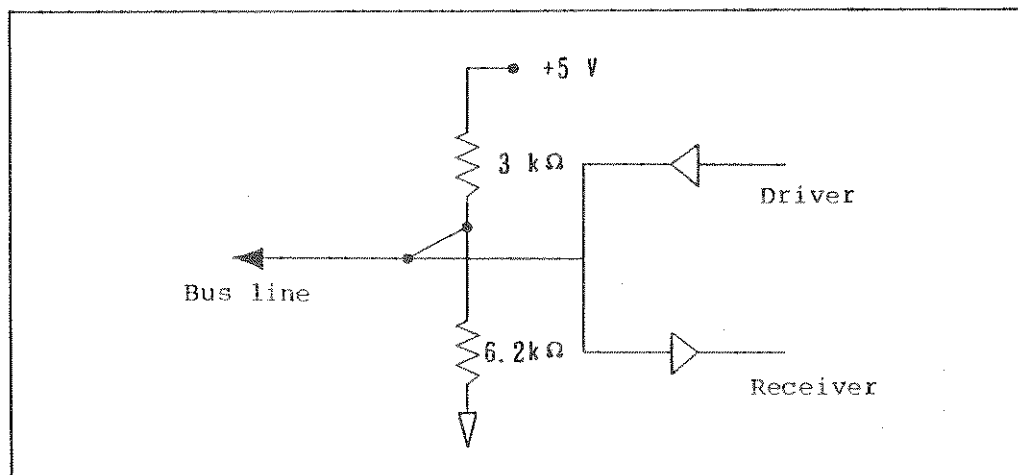

Figure 7 - 3 End of Signal Line

- Driver specifications : Open collector type
Voltage output at "low" : +0.4V or less, 48mA
Voltage output at "high" : +2.4V or greater, -6.2mA
- Receiver specifications : "low" if less than +0.6V
"high" if greater than +2.0V
- Bus cable length : Individual cable should be less than four meters long, and the sum of all cables, i.e., twice the number of devices connected to buses, should not exceed twenty meters.
- Address setting : Up to 31 talk/listen addresses are entered through keys on the front panel.

R3261/3361
SPECTRUM ANALYZER
INSTRUCTION MANUAL

7.2 GPIB Standards & Main Unit GPIB Specifications

(4) Interface Function: See Table 7-1.

Table 7 - 1 GPIB Interface Functions

Code	Function & description
SH1	Source handshake function
AH1	Acceptor handshake function
T6	Basic talker function, serial poll function, talker cancel function by listener specification
L4	Basic listener function, listener cancel function by talker specification
SR1	Service request function
RL1	Remote function
PR0	Parallel function
DC1	Device clear function provided
DT1	Device trigger function provided
C0	Controller function not provided, except when the plotter comes into use.
E1	Open collector bus driver is in use. EO1, DAV means E2 (three state bus driver) is in use.

R3261/3361
SPECTRUM ANALYZER
INSTRUCTION MANUAL

7.3 List of GPIB Codes

7.3 List of GPIB Codes

The following list is commonly applicable to the R3261C, R3261CN, R3261D, R3361C, R3361CN, and R3361D spectrum analyzers. Also, it is applicable to the Option 81.

[Note regarding Table 7 - 2]

- * : Function used to input data (such as ten-key, step key, data knob) Examples for use is listed in Table 7 - 3.
- F : Frequency
- L : Level
- T : Time
- N : Data output in the constant-specified format
- + : Indicates that multiple data is output.
- AU : Denotes AUTO
- MA : Denotes MANUAL
- ☆ : Denotes initial values set when the power is turned on.
- Δ : Subsequent codes will be ignored due to processing convenience.
- : Inapplicable

Table 7 - 2 List of GPIB Codes

No.	Function	Code	Talker request			Remarks
			Code	Output format	Header	
1.	CENTER FREQ	* CF	CF?	F	CF	
	CF step size	* CS	CS?	F	CS	
	CF step AUTO	CA	CA?	1=AU/0=MA	-	
	freq offset (ON/OFF)	*FON/FOF	FO?	1=ON/0=OFF + F	FO	
	sign (+/-)	Δ, +/-	-	-	-	
2.	FREQ SPAN	* SP	SP?	F	SP	
	linear	* LS	-	-	-	
	full	FS	-	-	-	
	log	LG	-	-	-	
	-- start	* LGA	LGA?	F	LGA	
	-- stop	* LGB	LGB?	F	LGB	
	zero	ZS	-	-	-	
	Span mode	-	SPM?	0=lin / 1=full 2=log / 3=zero	-	

R3261/3361
SPECTRUM ANALYZER
INSTRUCTION MANUAL

7.3 List of GPIB Codes

Table 7 - 2 List of GPIB Codes (Cont'd)

No.	Function	Code	Talker request			Remarks
			Code	Output format	Header	
3.	START FREQ	*FA, *FT	FA?, FT?	F	FA	
	freq offset (ON/OFF) sign (+/-)	*FON/FOF Δ , +/-	FO? -	1=ON/0=OFF + F -	FO -	
	STOP FREQ	*FB, *FP	FB?, FP?	F	FB	
	freq offset (ON/OFF) sign (+/-)	*FON/FOF Δ , +/-	FO? -	1=ON/0=OFF + F -	FO -	
4.	REF LEVEL	*RE, *RL	RE?, RL?	L	(UNIT) dBm =REB dBmV=REM dBuV=REU EMF =REE dBpW=REW V =REV	
	dB/div	* DD	DD?	0=10dB/, 1=5dB/ 2= 2dB/, 3=1dB/ 4=0.5dB/ 5=0.2dB/ 6=0.1dB/	-	
	8/12 div (at 10dB/)	DV0/DV1	DV?	0=8div/1=12div 2=Others	-	
	linear -- x 1	LL1	-	-	-	
	-- x 1.6	LL2	-	-	-	
	-- x 4	LL4	-	-	-	
	-- x 8	LL8	-	-	-	
	Linear magnification	-	LL?	0=x1, 1=x1.6 2=x4, 3=x8	-	
	disp unit					
	-- dBm	UB	-	-	-	
	-- dBmV	UM	-	-	-	
	-- dBuV	UU	-	-	-	
	-- dBuV (EMF)	UE	-	-	-	
-- dBpW	UW	-	-	-		
REF. offset (ON/OFF)	*RON/ROF	RO?	1=ON/0=OFF + L	RO		
Vertical axis unit	-	UN?	0=dBm / 1=dBmV 2=dBuV / 3=EMF 4=dBpW / 5=dB 6=V	-		

R3261/3361
SPECTRUM ANALYZER
INSTRUCTION MANUAL

7.3 List of GPIB Codes

Table 7 - 2 List of GPIB Codes (Cont'd)

No.	Function	Code	Talker request			Remarks
			Code	Output format	Header	
5.	COUPLE	CO	-	-	-	
		auto	auto			
	RBW	*RB (BA)	RB?(BA?)	F (1=AU/0=MA)	RB	
	VBW	*VB (VA)	VB?(VA?)	F (1=AU/0=MA)	VB	
	SWP	*SW (AS)	SW?(AS?)	T (1=AU/0=MA)	SW	
	ATT	*AT (AA)	AT?(AA?)	L (1=AU/0=MA)	AT	
	AUTO	AC	-	-	-	
	all AUTO	AL	AL?	1=YES/0=NO	-	
6.	MENU	ME	-	-	-	
	trigger -- free run	FR	-	-	-	
	-- line	LI	-	-	-	
	-- video	VI	-	-	-	
	-- TV_V	TV	-	-	-	
	-- EXT	EX	-	-	-	
	-- single	SI	-	-	-	
	(ST/RST)					
	Trigger mode	-	TM?	0=free / 1=line 2=video/ 3=TV 4=EXT / 5=singl	-	
	SWEEP start	SR	-	-	-	free, single only
	detector -- normal	DTN	-	-	-	
	-- posi	DTP	-	-	-	
	-- nega	DTG	-	-	-	
	-- sample	DTS	-	-	-	
	Detector mode	-	DM?	0=norm/ 1=posi 2=nega/ 3=sampl	-	
	SWEEP -- normal	SN	-	-	-	
	-- manual	SM	-	-	-	
	-- Δ marker	SDM	-	-	-	
	-- window	SDW	-	-	-	
	-- mkr PAUSE	*PUN/PUF	PU?	1=ON/0=OFF + T	PU	
(ON/OFF)						
Sweep mode	-	SWM?	0=norm./1>manual 2= Δ mkr/ 3=window	-		
display line	*DLN/DLF	DL?	1=ON/0=OFF + L	(unit)		
(ON/OFF)				dBm =DLB dBmV=DLM dBuV=DLU EMF =DLE dBpW=DLW V =DLV		

R3261/3361
SPECTRUM ANALYZER
INSTRUCTION MANUAL

7.3 List of GPIB Codes

Table 7 - 2 List of GPIB Codes (Cont'd)

No.	Function	Code	Talker request			Remarks
			Code	Output format	Header	
(6)	display line point	-	G2?	Y (Y axis= 0 to 400 point)	-	
	TRACE -- A <-> B	CH	-	-	-	
	-- A - B → A	TR0	-	-	-	
	-- B - A → A	TR1	-	-	-	
	-- A - DL → A	TR2	-	-	-	
	-- B - DL → B	TR3	-	-	-	
	(next) -- sound		-	-	-	
	-- AM	SAM	-	-	-	
	-- FM	SFM	-	-	-	
	-- vol.MAX	VX	-	-	-	
	-- vol.MID	VD	-	-	-	
	-- vol.MIN	VN	-	-	-	
	-- ON/OFF	SON/SOF	-	-	-	
-- gratical (ON/OFF)	GN/GF	-	-	-		
7.	MARKER ON	* MN	MN?	0=OFF / 1=norm 2=Δ	-	
	Marker frequency	-	MF?	F	MF	
	Marker level	-	ML?	L	(unit) dB =MLD dBm =MLB dBmV=MLM dBμV=MLU EMF =MLE dBpW=MLW V =MLV dBm/Hz =MLH dBμV/√Hz =MLL	
	Marker frequency, level	-	MFL?	F + L	MF (unit) dB =MLD dBm =MLB dBmV=MLM dBμV=MLU EMF =MLE dBpW=MLW V =MLV dBm/Hz =MLH dBμV/√Hz =MLL	

R3261/3361
SPECTRUM ANALYZER
INSTRUCTION MANUAL

7.3 List of GPIB Codes

Table 7 - 2 List of GPIB Codes (Cont'd)

No.	Function	Code	Talker request			Remarks
			Code	Output format	Header	
(7)	normal mkr point	-	G0?	X + Y	-	
	Δ mkr point	-	G1?	X + Y	-	
				(X axis= 0 to 700 point) (Y axis= 0 to 400 point)		
	normal mkr	* MK	-	-	-	
	Δ mkr	* MT	-	-	-	
	-- normal mkr	* MK	-	-	-	
	-- Δ mkr	* MT	-	-	-	
	-- counter	-	CN?	1=ON / 0=OFF	-	
	- 1kHz	CN0	-	-	-	
	- 100Hz	CN1	-	-	-	
	- 10Hz	CN2	-	-	-	
	- 1Hz	CN3	-	-	-	
	- FORWARD/BACK	FW/BK	-	-	-	
	- OFF	CNF	-	-	-	
	-- fixed (ON/OFF)	FXN/FXF	FX?	1=ON / 0=OFF	-	
	-- sign (+/-)	Δ, +/-	-	-	-	
	counter	-	CN?	1=ON / 0=OFF	-	
	-- 1kHz	CN0	-	-	-	
	-- 100Hz	CN1	-	-	-	
	-- 10Hz	CN2	-	-	-	
	-- 1Hz	CN3	-	-	-	
	-- FORWARD/BACK	FW/BK	-	-	-	
	-- OFF	CNF	-	-	-	
	sig.track (ON/OFF)	SGN/SGF	SG?	1=ON / 0=OFF	-	
	noise/Hz	-	NI?	1=ON / 0=OFF + F (xHz)	NI	
	-- dBm/Hz	* NIM	-	-	-	
	-- dBμV/√Hz	* NIU	-	-	-	
	-- OFF	NIF	-	-	-	
	(next)					
	X dB down	* XDB	-	-	-	
X dB left	* XDL	-	-	-		
X dB right	* XDR	-	-	-		
X dB REL/ ABS1/	DC0	-	-	-		
ABS2	DC1	-	-	-		
	DC2	-	-	-		
	-	DC?	0=REL/ 1=ABS1/2=ABS2	-		
8.	MARKER OFF	MO, MF	-	-	-	

R3261/3361
SPECTRUM ANALYZER
INSTRUCTION MANUAL

7.3 List of GPIB Codes

Table 7 - 2 List of GPIB Codes (Cont'd)

No.	Function	Code	Talker request			Remarks
			Code	Output format	Header	
9.	PEAK	PS	-	-	-	
	next pk	NXP	-	-	-	
	next pk right	NXR	-	-	-	
	next pk left	NXL	-	-	-	
	next pk max/min	NMM	-	-	-	
	min.	MIS	-	-	-	
	(next)					
	next min.	NXM	-	-	-	
pk cont. ON/OFF	CPN/CPF	CP?	1=ON/0=OFF	-		
$\Delta X/\Delta Y$	*DX/*DY	-	-	-		
10.	MARKER -->	MG	-	-	-	
	mkr →CF	MC	-	-	-	
	mkr →REF	MR	-	-	-	
	mkr Δ →SPAN	DS	-	-	-	
	mkr →CF step size	M0	-	-	-	
	mkr Δ →CF step size	M1	-	-	-	
	(next)					
	mkr → mkr step size	M2	-	-	-	
	mkr Δ → mkr step size	M3	-	-	-	
	mkr step size	* MPM	MPM?	F	MPM	
mkr step AUTO	MPA	MPA?	1=AU/0=MA	-		
11.	TRACE A, B	TA, TB	TA?, TB?	(A #1) (B #1) 0=write 0=write 1=view 1=view 2=blank 2=blank 3=norm. 3=norm. 4= 4= A-DL->A B-DL->B 5=A-B->A 6=B-A->A (A #2) (B #2) 0= 0= nothing nothing 1=+max 1=+max 2=+avg. 2=+avg.	-	
	write	AW, BW	-	-	-	
	view	AV, BV	-	-	-	
	blank	AB, BB	-	-	-	
	max hold	AM, BM	-	-	-	

R3261/3361
SPECTRUM ANALYZER
INSTRUCTION MANUAL

7.3 List of GPIB Codes

Table 7 - 2 List of GPIB Codes (Cont'd)

No.	Function	Code	Talker request			Remarks
			Code	Output format	Header	
(11)	avg.	*AG, *BG	AG?, BG?	N (Number of times set)	-	
	-- start/stop	AGR, BGR	-	-	-	
	-- pause/cont	AGS, BGS	-	-	-	
	-- 1 time cont/normalize	AGP, BGP	-	-	-	
	-- ON/OFF	AGC, BGC	-	-	-	
	-- corr. data save	AGL, BGL	-	-	-	
	-- disp L (ON/OFF)	AGO, BGO	-	-	-	
	-- instant norm.	ANN, BNN	-	-	-	
	clear the data by 0	ANF, BNF	-	-	-	
		AR, BR	-	-	-	
		*DLN/DLF	DL?	1=ON / 0=OFF + L	(unit) dBm=DLB dBmV=DLM dBuV=DLU EMF =DLE dBpW=DLW V =DLV	
	AI, BI	-	-	-		
	CWA, CWB	-	-	-		
12.	DATA					
	0 to 9	0 to 9	-	-	-	
	. (point)	.	-	-	-	
	back space	BS	-	-	-	
	step UP	UP	-	-	-	
	step DOWN	DN	-	-	-	
	nob UP	(co/fin) CU/FU	-	-	-	
	nob DOWN	CD/FD	-	-	-	
	GHZ	GZ	-	-	-	
	MHz	MZ	-	-	-	
	kHz	KZ	-	-	-	
	Hz	HZ	-	-	-	
	mV	MV	-	-	-	
	+/-dBm, dB (Add polarity)	DB	-	-	-	
	sec	SC	-	-	-	
	msec	MS	-	-	-	
	usec	US	-	-	-	

R3261/3361
SPECTRUM ANALYZER
INSTRUCTION MANUAL

7.3 List of GPIB Codes

Table 7 - 2 List of GPIB Codes (Cont'd)

No.	Function	Code	Talker request			Remarks
			Code	Output format	Header	
13.	RECALL	*RC	-	-	-	
	NORMAL/FAST mode	RN/RF	-	-	-	
14.	SOFTKEY	-	-	-	-	
	softkey 1	SF1	-	-	-	
	softkey 2	SF2	-	-	-	
	softkey 3	SF3	-	-	-	
	softkey 4	SF4	-	-	-	
	softkey 5	SF5	-	-	-	
	softkey 6	SF6	-	-	-	
15.	LOCAL	LC	-	-	-	
16.	MASTER RESET	IP	-	-	-	
17.	USER	UR	-	-	-	
	user key 1	UR1	-	-	-	
	user key 2	UR2	-	-	-	
	user key 3	UR3	-	-	-	
	user key 4	UR4	-	-	-	
	user key 5	UR5	-	-	-	
	user key 6	UR6	-	-	-	
18.	SHIFT	SH	SH?	1=ON / 0=OFF	-	
	GPIB address(+LOCAL)	* AD (SHLC)	AD?	N (Address)	-	
	NORMALIZE A (+A)	SHTA (AI)	-	-	-	
	NORMALIZE B (+B)	SHTB (BI)	-	-	-	
	EMC (+1)	SH1	-	-	-	
	-- field str.					
	- antenna					
	- dipole	AN0	-	-	-	
	- log perd	AN1	-	-	-	
	- TR17203	AN2	-	-	-	
	- OFF	AF	-	-	-	
- correct ON/OFF	CRN/CRF	CR?	1=ON / 0=OFF	-		

R3261/3361
SPECTRUM ANALYZER
INSTRUCTION MANUAL

7.3 List of GPIB Codes

Table 7 - 2 List of GPIB Codes (Cont'd)

No.	Function	Code	Talker request			Remarks
			Code	Output format	Header	
(18)	-- QP					
	- ON/OFF	QN/QF	QP?	1=ON / 0=OFF	-	
	- BW AUTO	QA	-	-	-	
	- BW 200Hz	QP0	-	-	-	
	- BW 9kHz	QP1	-	-	-	
	- BW 120kHz	QP2	-	-	-	
	-- limit A					
	- ON/OFF	LAN/LAF	-	-	-	
	MEMORY CARD (+4)	SH4				
	-- volume init.	MMI	-	-	-	
	-- menu load	MML	-	-	-	
	-- menu store	MMS	-	-	-	
	meas. WINDOW (+5)	WN(SH5)	WN?	1=ON / 0=OFF	-	
	-- OFF	WF	-	-	-	
	(next)					
	-- location (X)	* WLX	WLX?	F (center)	WLX	
	-- location (Y)	* WLY	WLY?	L (center)	WLY	
	-- delta (X)	* WDX	WDX?	F (Δ)	WDX	
	-- delta (Y)	* WDY	WDY?	L (Δ)	WDY	
	-- ABS data					
	-- start freq.	* WTF	WTF?	F (start)	WTF	
	-- stop freq.	* WPF	WPF?	F (stop)	WPF	
	-- upper level	* WUL	WUL?	L (upper)	WUL	
	-- lower level	* WLL	WLL?	L (lower)	WLL	
	Executing judgment A of GO or NG	CMA	-	-	-	See 4.10.2
	Executing judgment B of GO or NG	CMB	-	-	-	
	Result output (NG point)	-	CM?	GO=0/NG=1 to 100	-	
	NG frequency output	-	CMF?	F	CMF	
	CALIBRATION (+7)	SH7				
	-- call all	CLA	-	-	-	
	-- total gain	CLG	-	-	-	
	-- itmes					
	- input ATT	IT0	-	-	-	
- IF step AMPTD	IT1	-	-	-		
- RBW switch	IT2	-	-	-		
- LOG linearity	IT3	-	-	-		
- AMPTD MAG	IT4	-	-	-		
- TG tracking	IT5	-	-	-		

R3261/3361
SPECTRUM ANALYZER
INSTRUCTION MANUAL

7.3 List of GPIB Codes

Table 7 - 2 List of GPIB Codes (Cont'd)

No.	Function	Code	Talker request			Remarks
			Code	Output format	Header	
(18)	-- cal. sig. ON/OFF	*CLN/CLF	CL?	1=ON / 0=OFF	-	up to 49 letters in LABEL
	-- frq corr. ON/OFF	FCN/FCF	FC?	1=ON / 0=OFF	-	
	-- cal. corr. ON/OFF	CCN/CCF	CC?	1=ON / 0=OFF	-	
	SAVE (+RECALL)	*SHRC				
	PLOT (+8)	SH8				
	LABEL (+9)					
	--ON (write)	LON/	-	-	-	
	--OFF (clear)	LABEL/	-	-	-	
	FUNCTION (+6)	LOF				
	-- OBW	SH6				
-- ADJ	OBW	OBW?	F (Hz)	OBW		
-- ADJ graph	ADJ	ADJ?	L (dB)	ADJ		
		ADG	-	-		
19.	Trace data					Option 81 only
	A memory					
	ASCII output	-	TAA?	ASCII format	-	
	Binary output	-	TBA?	Binary format	-	
	B memory					
	ASCII output	-	TAB?	ASCII format	-	
	Binary output	-	TBA?	Binary format	-	
	A memory					
	ASCII input	TAA	-		-	
	Binary input	TBA	-		-	
B memory						
ASCII input	TAB	-		-		
Binary input	TBB	-		-		
20.	Others					☆ Option 81 only
	Header OFF	HD0	-	-	-	
	ON	HD1	-	-	-	
	Delimiter					
	CR LF EOI	DL0	-	-	-	
	LF	DL1	-	-	-	
	EOI	DL2	-	-	-	
	CR LF	DL3	-	-	-	
	LF EOI	DL4	-	-	-	

R3261/3361
SPECTRUM ANALYZER
INSTRUCTION MANUAL

7.3 List of GPIB Codes

Table 7 - 2 List of GPIB Codes (Cont'd)

No.	Function	Code	Talker request			Remarks
			Code	Output format	Header	
(20)	SRQ interrupt ON	S0	-	-	-	☆
	SRQ interrupt OFF	S1	-	-	-	
	SRQ status clear	S2	-	-	-	
	Output of product type (numeral)	-	VER?	1=B3261C 2=R3261D 3=R3361C 4=R3361D 5=R3261CN 6=R3361CN	- - - - -	
Output of unit type (character string)	-	TYP?	Output the unit name by character string	-		
Output of displayed character (64x24)	-	GPL?	DDDD..03=1 line 24 set continue (D=1 character/ 03=CR)	- - -		
21.	TG	TG	TG?	1=ON / 0=OFF	-	R3361 only
	TG level	*TGL	TGL?	L	(unit) dBm=TGB dBmV=TGM dBuV=TGU EMF =TGE dBpW=TGW V =TGV	
	freq. cal AUTO	TGA	-	-	-	
	freq. cal MANUAL OFF	*TGM TGF	- -	- -	- -	
22.	Preselector		PR?	1=ON / 0=OFF	-	Option
	ATT 0dB	A0	-	-	-	-
	ATT 10dB	A1	-	-	-	-
	ATT 20dB	A2	-	-	-	-
	ATT 30dB	A3	-	-	-	-
	ATT 40dB	A4	-	-	-	-
	ATT 50dB	A5	-	-	-	-
	pre amp ON/OFF	PO/PF	-	-	-	-
	bypass ON/OFF	BO/BF	-	-	-	-
	linearity check ON/OFF	LO/LF	-	-	-	-
	REF. offset	-	PRO?	L	PRO	-

R3261/3361
SPECTRUM ANALYZER
INSTRUCTION MANUAL

7.3 List of GPIB Codes

Table 7 - 3 Example of Data Input Function to be Used
(Asterisk of GPIB Codes)

Command name	Description
CF100MZ	Sets center frequency to 100MHz.
CS100KZ	Sets frequency step size to 100kHz.
FON10MZ	Turns on the frequency offset, and sets it to 10MHz.
SP500MZ or LS500MZ	Sets frequency span to 500MHz.
LGA100MZ	Sets log start frequency to 100MHz.
LGB1000MZ	Sets log stop frequency to 1GHz.
FA100KZ or FT100KZ	Sets start frequency to 100kHz.
FB400KZ or FP400KZ	Sets stop frequency to 400kHz.
RE-25DB or RL-25DB	Sets reference level to -25dBm (when dBm is set).
DD5DB	Sets 5dB/div.
RON30DB	Turns on level offset, and set it to 30dB.
RB300KZ	Sets RBW to 300kHz.
VB100KZ	Sets VBW to 100kHz.
SW200MS	Sets sweep time to 200msec.
AT20DB	Sets attenuator to 20dB.
PUN100MS	Turns on the marker pause, and sets time to 100msec.
DLN87DB	Turns on Disp. line, and sets it to 87dB μ V (when dB μ V is set).
MK1.8GZ	Turns on the normal marker, and sets it to 1.8GHz.
MT2MZ	Turns on the delta marker, and display the normal marker at 2MHz.
MN100KZ	Sets 100kHz to the active marker.
NIM50HZ	Sets to dBm/50Hz.
NIU70HZ	Sets to dB μ V/ $\sqrt{70}$ Hz.
XDB6DB	Sets XdB-down width to 6dB (this is enabled with the XDL and XDR commands).
DX10GZ	Sets increased X points to 10 when retrieving the Next peak (GZ is ENTRY).
DY50GZ	Sets increased Y points to 50 when retrieving the Next peak (GZ is ENTRY).
MPM100KZ	Sets the marker step size to 100 for execution (GZ is ENTRY).

R3261/3361
SPECTRUM ANALYZER
INSTRUCTION MANUAL

7.3 List of GPIB Codes

Table 7 - 3 Example of Data Input Function to be Used
(Asterisk of GPIB Codes) (Cont'd)

Command name	Description
AG 200GZ	Sets average A number to 200 for execution (GZ is ENTRY).
BG 300GZ	Sets average B number to 300 for execution (GZ is ENTRY).
AD8GZ	Sets the GPIB address of this device to 8 (GZ is ENTRY).
WTF1MZ	Sets window start frequency to 1MHz.
WPF2MZ	Sets window stop frequency to 2MHz.
WUL-20DB	Sets window high-order level to -20dBm (when dBm is set).
WLL-40DB	Sets window low-order level to -40dBm (when dBm is set).
CLN-25DB	Turns on the CAL signal, and sets level to -25dBm (when dBm is set).
SHRC5SF1	Saves channel No. 5 (SF1 is the first softkey).
RC5SF1/RC5	Recall channel No. 5 (normal/high-speed mode).
TGL-25DB	Sets TG output level to -25dBm (when dBm is set).

7.4 Introduction

This chapter gives programming examples using the Hewlett-Packard manufactured HP 200, 300 series.

7.4.1 GPIB Address Setting

Addresses are set with keys on the panel.

Example: Setting address 01

Press SHIFT LCL 1 GHZ .

Address 00 to 30 are acceptable.

7.4.2 Delimiters

When sending data from the GPIB controller to the main unit (listener), the main unit GPIB does not work normally unless the controller delimiters are one of the following. This rule also applies when the main unit is acting as a talker.

GPIB code	Function
DL0	Simultaneously outputs CR and LF. LF is accompanied by EOI signals.
DL1	Outputs LF.
DL2	Outputs EOI signals with the data final byte.
DL3	Outputs CR and LF (initial value).
DL4	Outputs LF accompanied by EOI signals.

7.4.3 Input/Output Format

Such input/output commands as GPIB code transmission to connected devices, data reception, bus command execution, and serial polling are programmable in GPIB. Other operational calculations are defined by the active controller.

[Statement format]

Input/output statement device address; data

7.5 Input Format (Listener)

Measurement parameters and setting conditions can be entered by remote control, similarly to operating the panel keys.

To set the center frequency to 300MHz, enter as follows:

<u>OUTPUT</u>	<u>7</u>	<u>01</u>	;	<u>"CF</u>	<u>300MZ"</u>	*1	Specifies the controller as the talker.
↑	↑	↑		↑	↑	*2	GPIB interface selector
*1	*2	*3		*4	*5	*3	Specifies the spectrum analyzer (GPIB address 01) to the listener.
						*4	Activates the center frequency.
						*5	Set value

'CF', '3', '0', and 'MZ' in the program are the GPIB codes used to remote control the spectrum analyzer. (See Section 7.3 GPIB Codes List.)

The following are the restrictions on entry data:

- Lowercase is converted internally into uppercase, and assumed as having been uppercase from the outset.
- Spaces and commas are ignored.
- A minus sign is ignored except when used as the sign of a negative value.
- No exponent can be entered.
- No binary digits can be entered. (Excluding trace binary input)
- Carriage returns (CR) and line feeds (LF) are recognized as data delimiters only.
- Nothing can be entered unless it is defined as a GPIB code.

R3261/3361
SPECTRUM ANALYZER
INSTRUCTION MANUAL

7.5 Input Format (Listener)

Programming examples (GPIB address = 1)

<p>Example 7-1 : Reset the analyzer master key and turn on the CAL signal (30 MHz).</p>	
<pre>10 OUTPUT 701;"IP" 20 OUTPUT 701;"CLN" 30 END</pre>	
<p>Example 7-2 : Setting start and stop frequencies to 300kHz and 800kHz respectively, and adding 50kHz to the frequency offset</p>	
<pre>10 OUTPUT 701;"FA300KZ" 20 OUTPUT 701;"FB800KZ" 30 OUTPUT 701;"FON50KZ" 40 END</pre>	
<p>Example 7-3 : Setting the reference level to -20dBm (5dB/div), resolution bandwidth to 100kHz, and detector mode to positive</p>	
<pre>10 OUTPUT 701;"RE-20DB" 20 OUTPUT 701;"DD5DB" 30 OUTPUT 701;"RB100KZ" 40 OUTPUT 701;"DTP" 50 END</pre>	
<p>Example 7-4 : Setting the trigger mode to single, sweep time to 2 seconds, and putting on a marker on the maximum level during repeated sweeping</p>	
<pre>10 OUTPUT 701;"SI" 20 OUTPUT 701;"SW2SC" 30 OUTPUT 701;"SR" 40 WAIT 2.5 50 OUTPUT 701;"PS" 60 GOTO 30 70 STOP 80 END</pre>	<pre>! Start of sweeping ! Wait for the end of sweeping (or use the service request) ! Marker peak search</pre>
<p>Example 7-5 : Setting to MAX HOLD (A)</p>	
<pre>OUTPUT 701;"AM" or OUTPUT 701;"TA SF4"</pre>	<pre>! Direct setting ! Setting by softkey operation</pre>

R3261/3361
SPECTRUM ANALYZER
INSTRUCTION MANUAL

7.5 Input Format (Listener)

Programming examples (GPIB address = 1)

Example 7-6 : Execute of Recall (for channel 5)

OUTPUT 701;"RN"	! (Normal mode)
OUTPUT 701;"RC 5 SFl"	! RC is the RECALL key.
	! 5 is channel 5 plus unit key.
	! SFl is the EXECUTE software key.
or	
OUTPUT 701;"RF"	! (FAST mode)
OUTPUT 701;"RC 5"	! RC is the EXECUTE software key.
	! SFl is the EXECUTE software key.

Note : The main unit recognizes GPIB codes by the length. Because the longer codes have the priority, use a space " " to avoid misunderstanding of the codes beginning with the same letter.

For example, the main unit mistakes the marker frequency level output ("MFL") for OUTPUT 701; "MFLC", the program that turns off the marker ("MF") and sets to local ("LC"), and flags an error claiming that "?" is missing.

It correctly should be input OUTPUT 701; "MF LC".

R3261/3361
SPECTRUM ANALYZER
INSTRUCTION MANUAL

7.6 Output Format (Talker)

7.6 Output Format (Talker)

To internal data on such as measuring data or set state, specify data to be output with xx? command. When this device is a talker, specified data is read. The output format is explained below. The header listing kinds of output data is attached to the beginning of characters (can be abbreviated), and five kinds of delimiters to be final data can be used (see GPIB code No. 20). Once the xx? command is set, it is enabled until it is changed.

	Description	
Frequency format	$\begin{array}{cccccc} \text{HHH}\Delta\text{+DDDDDDDDDDDE+D} & \text{CR} & \text{LF} \\ \uparrow\uparrow\uparrow & \uparrow & \uparrow \\ *1*2*3 & *4 & *5 & *6 \end{array}$	<ul style="list-style-type: none"> *1 = Header (2 or 3 characters when set to on) *2 = Separate (space) *3 = Sign (space for positive, - for negative) *4 = Mantissa data *5 = Exponential data *6 = Delimiter (Initialization) <p>Data length is 20 bytes. The unit is Hz. Example: Specify "CF?" and output the center frequency of 123.456MHz (at header ON) CF 00000123.456E+6</p>
Level format	$\begin{array}{cccccc} \text{HHH}\Delta\text{+DDDDDDDDDE+D} & \text{CR} & \text{LF} \\ \uparrow\uparrow\uparrow & \uparrow & \uparrow \\ *1*2*3 & *4 & *5 & *6 \end{array}$	<ul style="list-style-type: none"> *1 = Header (2 or 3 characters when set to on) *2 = Separate (space) *3 = Sign (space for positive, - for negative) *4 = Mantissa data *5 = Exponential data *6 = Delimiter (Initialization) <p>Data length is 16 bytes. The unit varies for each item. Example: Specify "ML?" and output the marker level of -56.23dBm (at header ON) MLB -00056.23E+0</p>
Time format	$\begin{array}{cccccc} \text{HH}\Delta\text{+DDDDDE+D} & \text{CR} & \text{LF} \\ \uparrow\uparrow & \uparrow & \uparrow \\ *1*2*3*4*5 & *6 \end{array}$	<ul style="list-style-type: none"> *1 = Header (2 characters when set to on) *2 = Separate (space) *3 = Sign (space for positive, - for negative) *4 = Mantissa data *5 = Exponential data *6 = Delimiter (Initialization) <p>Data length is 11 bytes. The unit is second. Example: Specify "SW?" and output the sweep time of 500msec (at header ON) SW 0500E-3</p>

R3261/3361
SPECTRUM ANALYZER
INSTRUCTION MANUAL

7.6 Output Format (Talker)

	Description						
Constant format	<p> DDDD CR LF ↑ ↑ *1 *2 (Variable length) </p> <p> Example: On/off : 1/0 Average number of switching: 128 </p> <p> *1 = Mantissa data *2 = Delimiter (Initialization) </p>						
Header	<p>When set to on, a header is put on the beginning of data. To output the header with data, modify the strings constant.</p> <table border="1" style="margin-left: auto; margin-right: auto; border-collapse: collapse;"> <thead> <tr> <th style="padding: 2px;"> GPIB code </th> <th style="padding: 2px;"> Meanings </th> </tr> </thead> <tbody> <tr> <td style="padding: 2px; text-align: center;"> HD0 </td> <td style="padding: 2px; text-align: center;"> OFF </td> </tr> <tr> <td style="padding: 2px; text-align: center;"> HD1 </td> <td style="padding: 2px; text-align: center;"> ON </td> </tr> </tbody> </table>	GPIB code	Meanings	HD0	OFF	HD1	ON
GPIB code	Meanings						
HD0	OFF						
HD1	ON						
Delimiter	<p>Delimiters are added to the final data during the process of data output. A choice of 5 types described in Section 7.4.2 is available.</p>						

Programming examples (GPIB address = 1)

<p>Example 7-7 : Outputting the marker frequency (integer)</p>
<pre> 10 OUTPUT 701;"MF?" 20 ENTER 701:A 30 END </pre> <p style="text-align: right;">Result (example): A=1.8E+9</p>
<p>Example 7-8 : Outputting the center frequency (strings)</p>
<pre> 10 DIM A\${30} 20 OUTPUT 701;"HD1" 30 OUTPUT 701;"CF?" 40 ENTER 701:A\$ 50 END </pre> <p style="text-align: right;">Result (example); A&=CF 00001.234567E+9</p>

R3261/3361
SPECTRUM ANALYZER
INSTRUCTION MANUAL

7.6 Output Format (Talker)

Programming examples (GPIB address = 1)

Example 7-9 : Outputting the status of the unit	
10 OUTPUT 701;"UN?" 20 ENTER 701;A 30 END	Result (example): A=2 (dBuV)
Example 7-10: Outputting the marker frequency and the level (multiple output items)	
10 OUTPUT 701;"MFL?" 20 ENTER 701;Mf, Ml 30 END	Result (example): Mf=1.8E+9 Ml=-65.15
Example 7-11: Outputting the frequency offset (multiple output items)	
10 OUTPUT 701;"FO?" 20 ENTER 701;On, Frq 30 END	Result (example): On=1 Frq=1.23E+6
Example 7-12: Reading out the levels of ten subsequent peaks after the first peak of the signal by using the next peak function	
10 DIM M1 (9) 20 OUTPUT 701;"PS" 30 FOR I=0 TO 9 40 OUTPUT 701;"NXP" 50 OUTPUT 701;"ML?" 60 ENTER 701;M1 (I) 70 NEXT I 80 END	Result (example): M1(0)=-55.01 M1(1)=-58.22 M1(9)=-70.26

7.7 Input and Output of Trace Data

Trace data displayed on the screen comprises 701 points of data, each representing the trace data at the corresponding frequency value at one of the 701 points. To input or output this trace data, transfer data of 701 points sequentially from the left (start frequency). The level on each point is represented by an integer from 0 to 400.

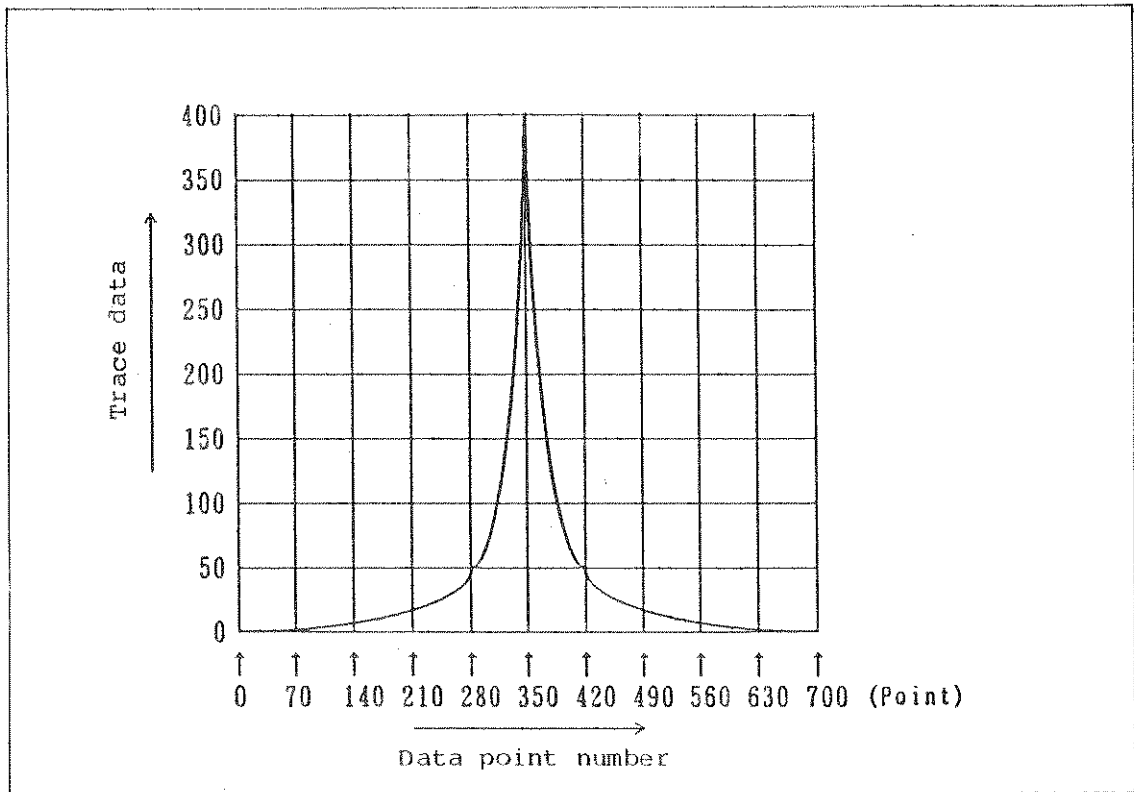

Figure 7 - 4 Relation Between the Screen Grid and Trace Data

Trace data can be input or output in the form of ASCII data or binary data.

7.7 Input and Output of Trace Data

Input/output format	Details									
ASCII format	<p> DDDD CR LF ↑ ↑ Delimiter Data for a point Four-byte data without a header </p> <table border="1" style="margin-left: auto; margin-right: auto;"> <thead> <tr> <th style="width: 10%;"></th> <th style="width: 40%;">Input GPIB code</th> <th style="width: 50%;">Output GPIB code</th> </tr> </thead> <tbody> <tr> <td>Memory A</td> <td>TAA</td> <td>TAA?</td> </tr> <tr> <td>Memory B</td> <td>TAB</td> <td>TAB?</td> </tr> </tbody> </table>		Input GPIB code	Output GPIB code	Memory A	TAA	TAA?	Memory B	TAB	TAB?
	Input GPIB code	Output GPIB code								
Memory A	TAA	TAA?								
Memory B	TAB	TAB?								
Binary format	<p> DD DD DD DD + EOI ↑ ↑ ↑ ↑ ↑ Low order byte of the first point data Low order byte of the 701st point data High order byte of the first point data High order byte of the 701st point data Delimiter </p> <p>The binary digits of the first point data is divided into two bytes, the upper and the lower. The consecutive data for 701 points is followed by an EOI signal code.</p> <table border="1" style="margin-left: auto; margin-right: auto;"> <thead> <tr> <th style="width: 10%;"></th> <th style="width: 40%;">Input GPIB code</th> <th style="width: 50%;">Output GPIB code</th> </tr> </thead> <tbody> <tr> <td>Memory A</td> <td>TBA</td> <td>TBA?</td> </tr> <tr> <td>Memory B</td> <td>TBB</td> <td>TBB?</td> </tr> </tbody> </table>		Input GPIB code	Output GPIB code	Memory A	TBA	TBA?	Memory B	TBB	TBB?
	Input GPIB code	Output GPIB code								
Memory A	TBA	TBA?								
Memory B	TBB	TBB?								

Programming examples (GPIB address = 1)

<p>Example 7-13: Outputting data in Memory A in ASCII code</p>	
<pre> 10 DIM Tr(700) 20 OUTPUT 701;"DL3" 30 OUTPUT 701;"TAA?" 40 FOR I=0 TO 700 50 ENTER 701;Tr(I) 60 NEXT I 70 END </pre>	<pre> ! Reserves 701 variables. ! Designates the delimiter as CR ! LF. ! Specifies ASCII code in Memory A ! Repeats data fetching for 701 ! times. </pre>
<p>Result (example): Tr(0)=208 Tr(1)=210 ... Tr(699)=311 Tr(700)=298</p>	
<p>Example 7-14: Outputting data in Memory B in binary code</p>	
<pre> 10 DIM Tr(700) 20 OUTPUT 701;"DL2" 30 OUTPUT 701;"TBB?" 40 ENTER 701 USING "%,W";Tr(*) 50 END </pre>	<pre> ! Reserves 701 variables. ! Designates the delimiter as EOI. ! Specifies binary code in Memory B ! Fetches data through word ! conversion until detecting EOI </pre>
<p>Result (example): Tr(0)=312 Tr(1)=319 ... Tr(699)=208 Tr(700)=211</p>	
<p>Example 7-15: Inputting data in Memory A in ASCII code</p>	
<pre> 10 OUTPUT 701;"TAA" 20 FOR I=0 TO 700 30 OUTPUT 701;Tr(I) 40 NEXT I 50 END </pre>	<pre> ! Specifies ASCII code in Memory A ! Repeats inputting the 701 ! reserved variables Tr. </pre>
<p>Note: The system must be in the view mode before running this program. After executing the program, press the view key again to check the result of the entry.</p>	
<p>Example 7-16: Inputting data in Memory B in binary code</p>	
<pre> 10 OUTPUT 701;"TBB" 20 OUTPUT 701 USING "#,B";Tr(*),END 30 END </pre>	<pre> ! Specifies binary code in Memory B ! Inputs data of 1402 bytes in ! units of byte, and puts EOI at ! the last. </pre>
<p>Note: The system must be in the view mode before running this program. After executing the program, press the view key again to check the result of the entry.</p>	

Note: To input or output data in the form of ASCII code, specify 701 times of inputting or outputting. Even for data in binary format, secure 701 data values and specify EOI by a delimiter.

R3261/3361
SPECTRUM ANALYZER
INSTRUCTION MANUAL

7.8 Service Request (SRQ)

7.8 Service Request (SRQ)

The GPIB service request function enables the external devices to detect main unit conditions. When one of the following event occurs, 1 is set to all the bits of the main unit status bytes enabling the controller to read status bytes by serial polling. Status bytes are cleared as soon as they are read by the controller.

Table 7 - 4 SRQ ON/OFF Specification Codes

GPIB code	Function
S0	Transmits SRQ (interrupt) signals to the controller.
S1	Does not transmit SRQ (interrupt) signals to the controller. (initial setting)
S2	Clears the status byte.

Table 7 - 5 Status Bytes

Bit	Hexa- decimal	Meaning
0	1	Set to 1 when UNCAL error occurs.
1	2	Set to 1 when calibration is completed.
2	4	Set to 1 when sweeping is completed.
3	8	Set to 1 when averaging is completed within the number of times set.
4	16	
5	32	Set to 1 when a GPIB code error occurs. (SYNTAX ERR)
6	64	Set to 1 when bit 0, 1, 2, 3, 4, 5, or 7 has been set to 1 at service request transmission (S0).
7	128	

R3261/3361
SPECTRUM ANALYZER
INSTRUCTION MANUAL

7.8 Service Request (SRQ)

Programming examples (GPIB address = 1)

Example 7-17: Reading end of averaging (interrupts are not transmitted)	
10 OUTPUT 701;"S2"	! Clear the status byte
20 OUTPUT 701;"AG 30GZ"	! Start averaging (A)
30 S=SPOLL(701)	! Output status byte to S
40 IF BIT(S,3) <> 1 THEN 30	! Wait until the third bit becomes 1
50 DISP "AVG.END"	! Indicates completed
60 END	
Example 7-18: Continuously reading single sweep termination (interrupts are not transmitted)	
10 OUTPUT 701;"SI"	! Set to single
20 OUTPUT 701;"S2"	! Clear the status byte
30 OUTPUT 701;"SR"	! Start sweeping
40 S=SPOLL(701)	! Output status byte to S
50 IF BIT(S,2)<>1 THEN 40	! Wait until the second bit becomes 1
60 PRINT "SWEEP END"	! Indicates completed
70 GOTO 20	! Start next sweeping
80 END	
Example 7-19: Reading end of averaging (interrupts are transmitted)	
10 OUTPUT 701;"S0"	! Transmit
20 OUTPUT 701;"S2"	! Clear the status byte
30 OUTPUT 701;"AG"	! Start averaging (A)
40 ON INTR 7 GOTO 70	! Jump to line 70 if interrupted
50 ENABLE INTR 7;2	! Set the mode that accepts interrupt
60 GOTO 50	! Wait until an interrupt occurs
70 S=SPOLL(701)	! Output status byte to S
80 IF BIT(S,3)=1 THEN 110	! Jump to line 110 if the third bit is 1
90 OUTPUT 701;"S2"	! Clear the status byte
100 GOTO 40	! Repeat
110 DISP "AVG. END"	! Indicates completed
120 END	

Note 1: To start sweep, SR and SI commands can be used.

Command	Function
"SR"	Resets sweep, and starts it forcibly (always).
"SI"	Sets trigger to single, and stops sweep (during non-single). Resets sweep (on the way of single sweep). Starts sweep (when single sweep stops).

R3261/3361
SPECTRUM ANALYZER
INSTRUCTION MANUAL

8. Check

8. CHECK

R3261/3361
SPECTRUM ANALYZER
INSTRUCTION MANUAL

8.1 Check and Brief Diagnosis

8.1 Check and Brief Diagnosis

Should a problem occur, check the following items before requesting repair. If the problem persists in spite of the prescribed procedures below, contact the nearest dealer or the sales and support offices. The addresses and telephone numbers are listed at the end of the manual. The user will be charged for any repairing done by our engineers, even for the procedures prescribed below.

Condition	Cause	Prescription
The system cannot be powered up.	The power cable is not properly inserted in the connector.	Turn off the power and connect the power cable properly.
	The power fuse is blown.	Replace the power fuse. (See 1.2.4 (2).)
The sweep lamp is lit but no waveform is displayed on the screen.	The intensity volume is kept too low.	Adjust the intensity by turning the volume knob.
	The input cable and the connector are not connected properly.	Connect the input cable and the connector properly.
Sweeping cannot be carried out.	The trigger is set to 'Single'	Press the menu key and select 'FREE-RUN'.
	The lamp corresponding to key A or key B is not lit.	Press the A or B key of 'Trace', and select 'Write'.
The signal level is inaccurate.	The AMPTD CAL is not adjusted.	Perform calibration.
The keys do not function.	The system is in the GPIB remote control mode.	If a program is being executed, halt it and press the LCL key.

WARNING

To remove the main unit case is allowed only for the trained service personnel because there is danger of the electric shock.

R3261/3361
SPECTRUM ANALYZER
INSTRUCTION MANUAL

8.2 Defects and Abnormal Stresses

8.2 Defects and Abnormal Stresses

When the R3261/3361 is impaired as undermentioned, it is thought that the protective function is damaged.

Before the R3261/3361 is used, make sure to find the damage and ensure the safety of this equipment at your nearest support office.

The instruments:

- shows visible damage,
- fails to perform the intended measurements,
- has been subjected to prolonged storage under unfavourable conditions,
- has been subjected to severe transport stresses.

R3261/3361
SPECTRUM ANALYZER
INSTRUCTION MANUAL

9. R3361NK/3361K

9. R3361NK/3361K

R3261/3361
SPECTRUM ANALYZER
INSTRUCTION MANUAL

9.1 Overview

R3361NK/3361K is the analyzer which allows easy measurement concerning CATV.

9.1.1 Features of R3361NK/3361K

- (1) Frequency can be set by specifying the channel number of the television.
- (2) Programs in the memory card can be executed easily.
- (3) Audio can be monitored through the built-in speaker.
- (4) Good visual recognition in the outdoors is provided by adopting the high brightness green CRT.

9.1.2 Checking Accessories

Upon receipt of the R3261/3361, run checks thereon as shown below.

- ① Run visual checks against any and all damages or imperfections.
- ② Check the quantity and rating of standard accessories to assure their conformance with Table 9 - 1.

Should there be any flaw, or damage, or missing or insufficient part, contact dealer or the sales and support offices.

Table 9 - 1 Standard Accessories (R3361NK/3361K)

Accessory name	Standard		Quantity		Remarks
	Model name	Stock No.	R3361NK	R3361K	
Power cable	A01412	DCB-DD3130×01	1	1	
Input cable	MI-02	DCB-FF0386		2	
	D3S015 (Black)	DCB-FF2987×01	2		
N-BNC conversion adapter	JUG-201A/V	JCF-AF001E×03		2	
	BA-A165	JCF-AF001E×04	2		
C15 conversion adapter	NCP-NFJ	JCF-AF001E×06	2		
Power fuse	218005	DFT-AA5A	2	2	
Memory card	--	SEE-MAC1101BAB	1	1	
Instruction manual *	--	JR3261/3361			Japanese Version
	--	ER3261/3361	1	1	English Version

* :One of the Japanese and the English instruction manuals.

Note:When ordering an accessory, let us know its type (or stock No.).

R3261/3361
SPECTRUM ANALYZER
INSTRUCTION MANUAL

9.2 Front Panel

9.2 Front Panel

- ① AUTO switch : Executes programs automatically.
- ② CH switch : Changes the unit of the frequency. CH/xHz
- ③ AUDIO VOLUME knob : Adjusts volume of the speaker.

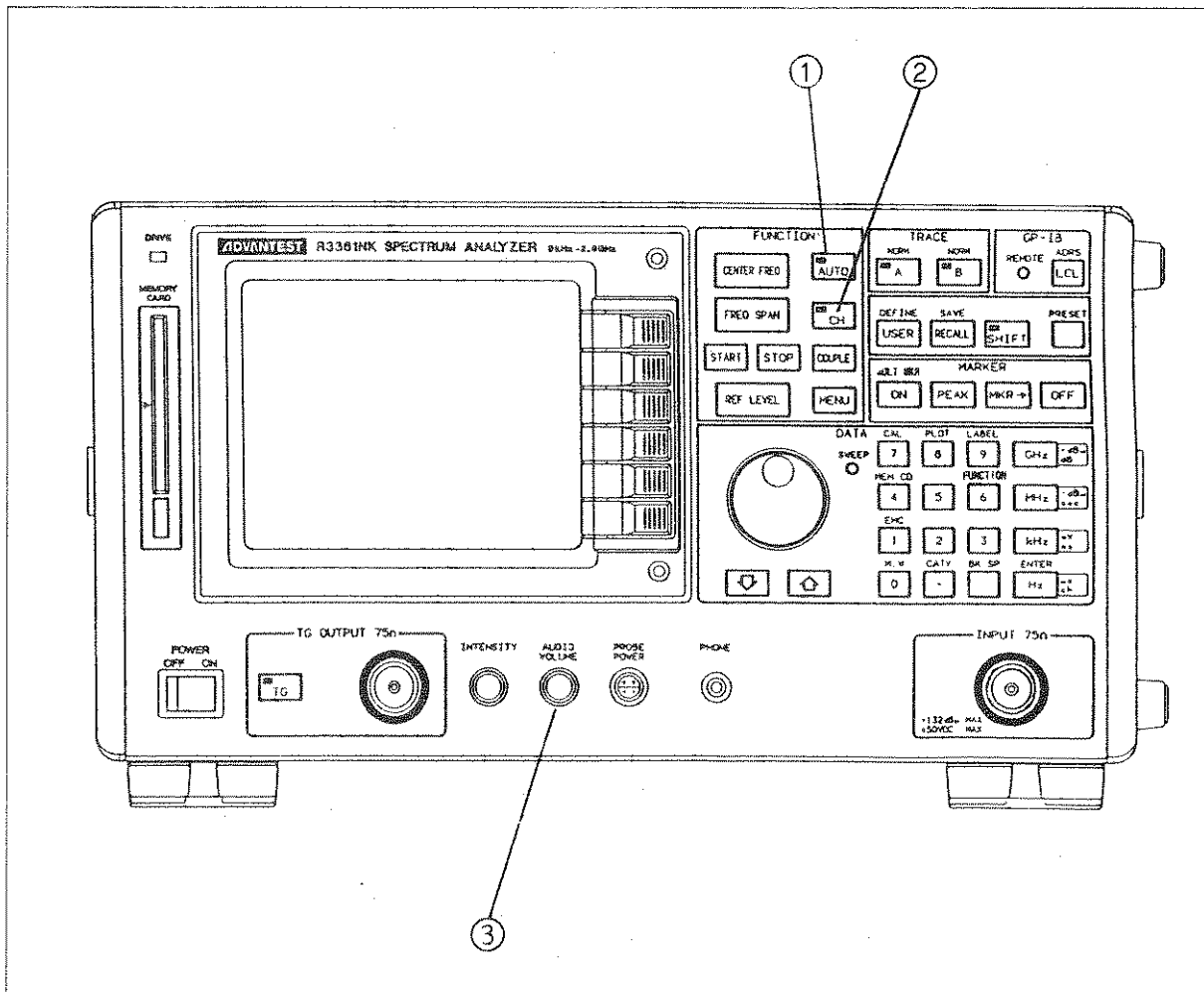

Figure 9 - 1 Front Panel (R3361NK/3361K)

9.3 Audio Monitor Function

In R3361NK/3361K, audio can be monitored by the built-in speaker. The volume is increased by turning the AUDIO VOLUME knob on the front panel clockwise and is decreased by turning it counterclockwise.

Audio output is available only when softkey menu SOUND
ON/OFF is ON .

Refer to "(7) SOUND (audio monitor) Setting" in Subsection 4.1.6 "Menu" for the details on SOUND setting.

9.3.1 Using Audio Monitor Function

Operating Procedure:

- ① Set "SOUND" of the soft key menu to ON.
Select the volume or the demodulation mode as necessary.

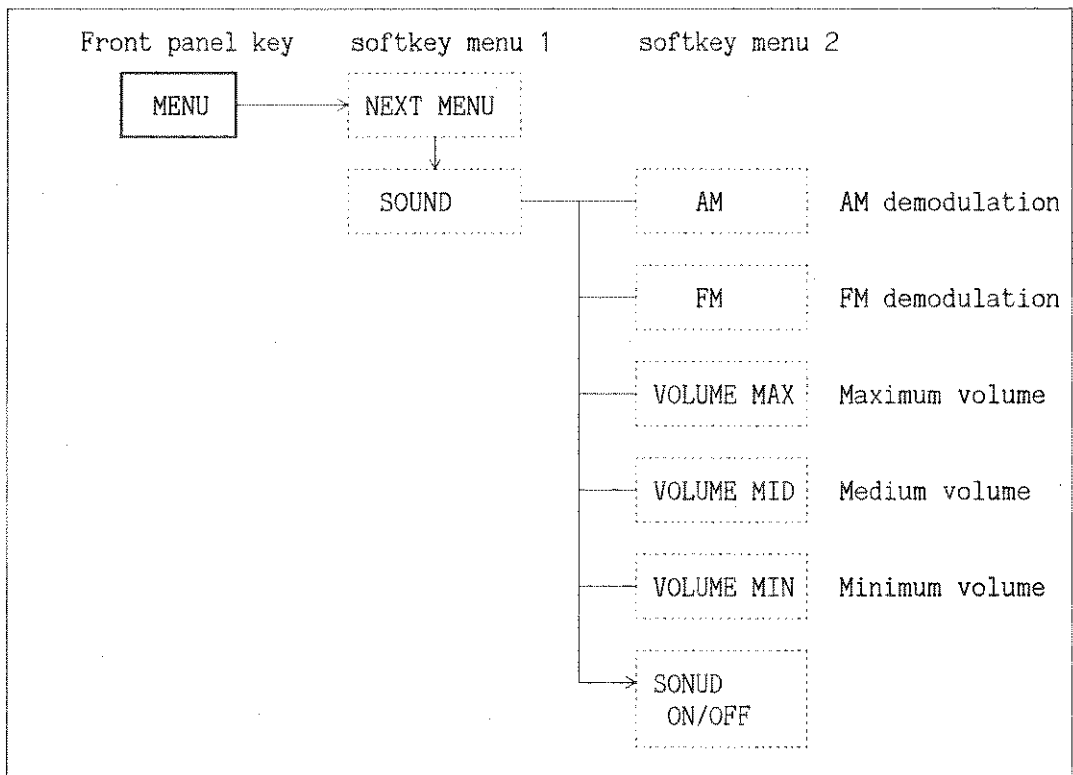

Figure 9 - 2 Menu Items of SOUND

- ② When one of marker on, manual sweep and zero span is selected in the state of SOUND ON, audio output becomes available.
- ③ Adjust the volume by turning the AUDIO VOLUME knob on the front panel.

9.3.2 Using User Define Function

User Define function is useful for executing the audio monitor easily. Refer to "4.5 User Define Function" for the explanation of User Define function.

Operating Procedure:

- ① Press **SHIFT** and **USER**, then assign the sound menu to the user key by using the user define function.

```

*** R3261/3361 Soft Menu Change Mode      MENU CHG
GROUP --- USER DEF                        GROUP
  K1 : AM Receiver Mode                    ACTIVE
  K2 : FM Receiver Mode
  K3 : Volume Maximum
  K4 : Sound Control ON/OFF                MEMBER
  K5 :                                     ACTIVE
  K6 :
MEMBER                                     ENTER
/*** Sound Mode ***/
  1 : AM Receiver Mode                    INITIAL
  2 : FM Receiver Mode                    MEMBER
  3 : Volume Maximum
  4 : Volume Middle
  5 : Volume Minimum
  6 : Sound Control ON/OFF
/*** Trace ***/
  1 : Write A                             ALL
  2 : View A                              INITIAL
  3 : Blank A                             RETURN
  
```

- ② Pressing **USER** immediately calls the sound menu.

```

REF 110.0 dBµV      ATT 10 dB      A_write B_blank      USER DEF
10dB/
AM
FM
VOLUME MAX
SOUND ON/
RBW 1 MHz
YBW 1 MHz
SWP 50 ms
CENTER 1.3000 GHz      SPAN 2600 MHz
  
```

9.4 Channel Setup Function

9.4.1 Description of the Function

The channel of TV and CATV can be specified with this function.
The vision carrier of the each channel can be measured at the center in dispatch.
The measurement of the vision carrier and the sound carrier or also the measurements of the multi-channel are possible simultaneously.
The channels are available three type which are for Japan, USA and Europe.
The channels for other countries and the channels for the radio and ect can be defined arbitrary to the user table.
These channels can be selected by the softkey menu and can be easily specified.

9.4.2 Feature of the Channel of Each Country

- (1) Japan : Frequency band width.....6MHz
Vision carrier.....Start frequency 1.25MHz
Sound carrierVision carrier+ 4.5MHz
- (2) USA : Frequency band width.....6MHz
Vision carrier.....Start frequency 1.25MHz
Start frequency 1.00MHz
Sound carrierVision carrier+ 4.5MHz
- (3) Europe: Frequency band width.....6, 7 and 8MHz
Vision carrier.....Start frequency 1.25MHz
Sound carrierVision carrier+ 4.5MHz, 5.5MHz, 6.5MHz

In case of Europe, frequency band width is different in compliance with the channel. Therefore, the positions of the each sound carrier are different.

9.4.3 Operation

- (1) Setup for the input mode of the channel number.

[Operation]

Press the button then LED in the key lights and R3361K becomes to the input mode of the channel number.

Press the button again, then LED in the key lights off and the input mode of the channel number is released.

R3261/3361
SPECTRUM ANALYZER
INSTRUCTION MANUAL

9.4 Channel Setup Function

(2) Setup of the vision carrier

The center frequency is made the input vision carrier frequency of the channel number. The frequency span is not changed.

[Setup example] (Set the channel input mode beforehand.)

CRT display (in the active display area)

① Press **CENTER FREQ**

CENTER CH
#1: 91.25 MHz
└── Vision carrier
└── Channel

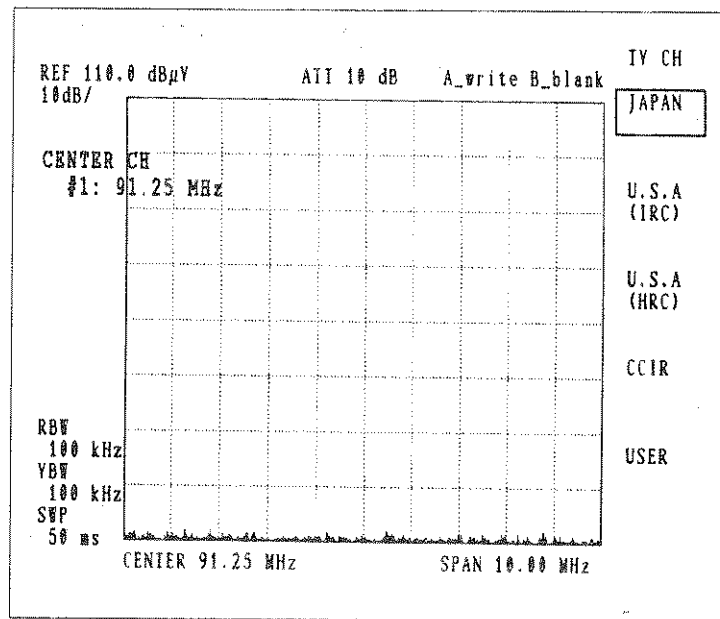

② Input the channel number

by **TEN KEY**

CENTER CH
28
└── Input of the channel number.

R3261/3361
SPECTRUM ANALYZER
INSTRUCTION MANUAL

9.4 Channel Setup Function

ENTER

③ Press

Hz

CENTER CH
#28: 561.25 MHz

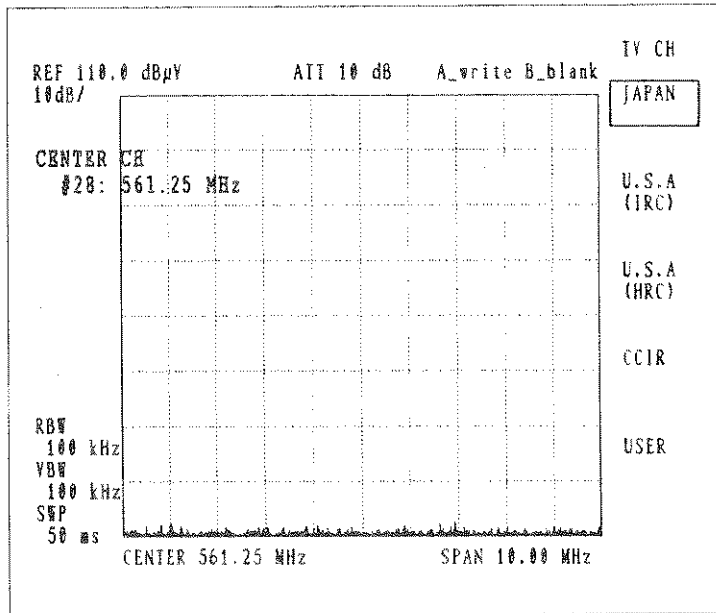

CATV

The selection of CATV channel and UHF channel can be set by

.

CATV

Press . before input of the channel number when CATV channel is specified.

.

In this case, "C" is displayed in the top of the channel number.

(3) Setup of the start frequency and the stop frequency

The start frequency is set lower limit value of frequency band of the input channel number and the stop is set upper limit value of frequency band of the input channel number.

R3261/3361
SPECTRUM ANALYZER
INSTRUCTION MANUAL

9.4 Channel Setup Function

[Setup example] (Set the channel input mode beforehand.)

CRT display (in the active display area)

① Press

```
START CH
#1: 90.00 MHz
└──┬── Lower limit of frequency
    │ band
    └── Channel
```

② Input the channel number
by

```
START CH
28
└── Input of the channel
    number
```

ENTER

③ Press

```
START CH
#28: 560.00 MHz
```

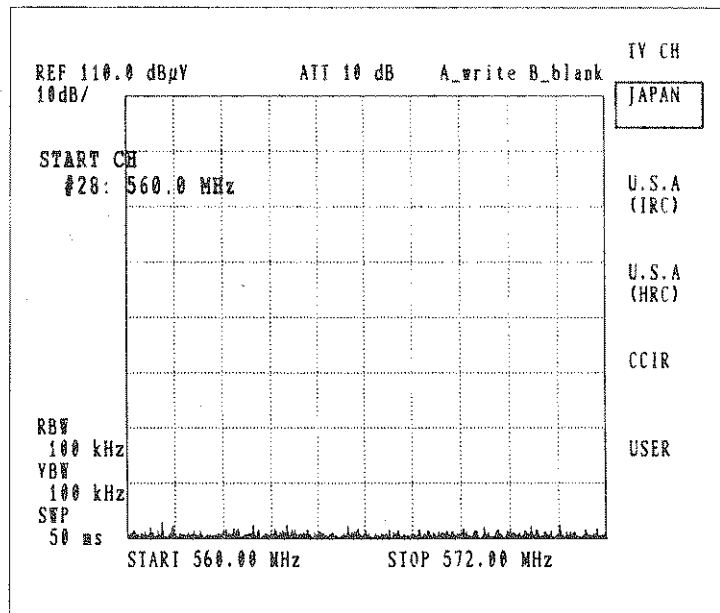

CATV

The selection of CATV channel can be set by , same as setup of the center channel.

R3261/3361
SPECTRUM ANALYZER
INSTRUCTION MANUAL

9.4 Channel Setup Function

- (4) Setup for the corresponding frequency to the specified channel in a case it differs to the current specified value.

When the vision frequency (start and stop frequency) of the specified channel and the specified current center frequencys are different, indicate a message in the active area as fillows then it shows different specified value.

[Setup example]

- ① Press CENTER FREQ . CRT display (in the active display area)
- CENTER CH
#1: Last Setup
└───┬─── Message
└───┬─── Last channel
- ② Input the channel number
by TEN KEY .
- CENTER CH
28
└──────────┬─── Input of the channel
 number
- ENTER
- ③ Press Hz .
- CENTER CH
#28: 561.25 MHz

R3261/3361
SPECTRUM ANALYZER
INSTRUCTION MANUAL

9.4 Channel Setup Function

(5) Setup for the channel by , and data knob.

Setup for the channel by , and data knob are made by increment and decrement of the one channel each.

For example, in case of Japan, following channel is specified as follows.

VHF 1ch → VHF 2ch → VHF 3ch → CATV 13ch → CATV 14ch → ... → 62ch

In case of setup for the start and stop frequency, the channel can be changed automatically keeping on a relationship between start and stop frequency.

[Setup example] (Set the channel input mode beforehand.)

		ENTER	START CH	STOP CH				
①	<input type="button" value="START"/>	<input type="text" value="4"/>	<input type="text" value="Hz"/>					
	<div style="border: 1px solid black; padding: 5px;"> <table border="0"> <tr> <td>#4: 170.00 MHz</td> <td>#8: 198.00 MHz</td> </tr> <tr> <td colspan="2" style="text-align: center;">└─ Setup to 4 ch</td> </tr> </table> </div>			#4: 170.00 MHz	#8: 198.00 MHz	└─ Setup to 4 ch		
#4: 170.00 MHz	#8: 198.00 MHz							
└─ Setup to 4 ch								

		ENTER						
②	<input type="button" value="STOP"/>	<input type="text" value="5"/>	<input type="text" value="Hz"/>					
	<div style="border: 1px solid black; padding: 5px;"> <table border="0"> <tr> <td>#4: 170.00 MHz</td> <td>#5: 182.00 MHz</td> </tr> <tr> <td colspan="2" style="text-align: center;">└─ Setup to 5 ch</td> </tr> </table> </div>			#4: 170.00 MHz	#5: 182.00 MHz	└─ Setup to 5 ch		
#4: 170.00 MHz	#5: 182.00 MHz							
└─ Setup to 5 ch								

③	Press <input type="button" value="START"/>	and change						
	<div style="border: 1px solid black; padding: 5px;"> <table border="0"> <tr> <td>#5: 176.00 MHz</td> <td>#5: 182.00 MHz</td> </tr> <tr> <td>└─ Change to 5 ch</td> <td>└─ No change</td> </tr> </table> </div>			#5: 176.00 MHz	#5: 182.00 MHz	└─ Change to 5 ch	└─ No change	
#5: 176.00 MHz	#5: 182.00 MHz							
└─ Change to 5 ch	└─ No change							

the channel by .

START, STOP CH is change at

only .

	<div style="border: 1px solid black; padding: 5px;"> <table border="0"> <tr> <td>#6: 182.00 MHz</td> <td>#6: 188.00 MHz</td> </tr> <tr> <td>└─ Change to 6 ch</td> <td>└─ Change to 6 ch automatically</td> </tr> </table> </div>			#6: 182.00 MHz	#6: 188.00 MHz	└─ Change to 6 ch	└─ Change to 6 ch automatically	
#6: 182.00 MHz	#6: 188.00 MHz							
└─ Change to 6 ch	└─ Change to 6 ch automatically							

R3261/3361
SPECTRUM ANALYZER
INSTRUCTION MANUAL

9.4 Channel Setup Function

(6) Setup for user channel

User can arbitrarily define the maximum 99 channel numbers for the countries expect Japan, USA and Europe or FM and AM radio broadcast. Editor is used for input data and the start and stop frequency and the vision carrier frequency can be input to each channel. The input data is saved in the memory which is backed up by battery.

[Setup example]

- ① is pressed then following screen display appears and data of the maximum 99 channel number can be specified.

*** USER CHANNEL TABLE ***				CH EDIT
Ch	Channel Limits		Visual Carrier	INIT
1:	48.500 MHz	~ 56.500 MHz	49.750 MHz	
2:	56.500 MHz	~ 64.500 MHz	57.750 MHz	
3:	64.500 MHz	~ 72.500 MHz	65.750 MHz	
4:	76.000 MHz	~ 84.000 MHz	77.250 MHz	
5:	84.000 MHz	~ 92.000 MHz	85.250 MHz	
6:	0 Hz	~ 0 Hz	0 Hz	DELETE
7:	0 Hz	~ 0 Hz	0 Hz	
8:	0 Hz	~ 0 Hz	0 Hz	
9:	0 Hz	~ 0 Hz	0 Hz	
10:	0 Hz	~ 0 Hz	0 Hz	
11:	0 Hz	~ 0 Hz	0 Hz	
12:	0 Hz	~ 0 Hz	0 Hz	
13:	0 Hz	~ 0 Hz	0 Hz	
14:	0 Hz	~ 0 Hz	0 Hz	
15:	0 Hz	~ 0 Hz	0 Hz	
16:	0 Hz	~ 0 Hz	0 Hz	RETURN

- ② Input the data lower limit and upper limit value of the frequency range and the vision carrier frequency in sequence from the left.

Turn the knob when the channel is skipped.

Press and key when cursor is moved.

9.4.4 List of Softkey Menu of the CH Key

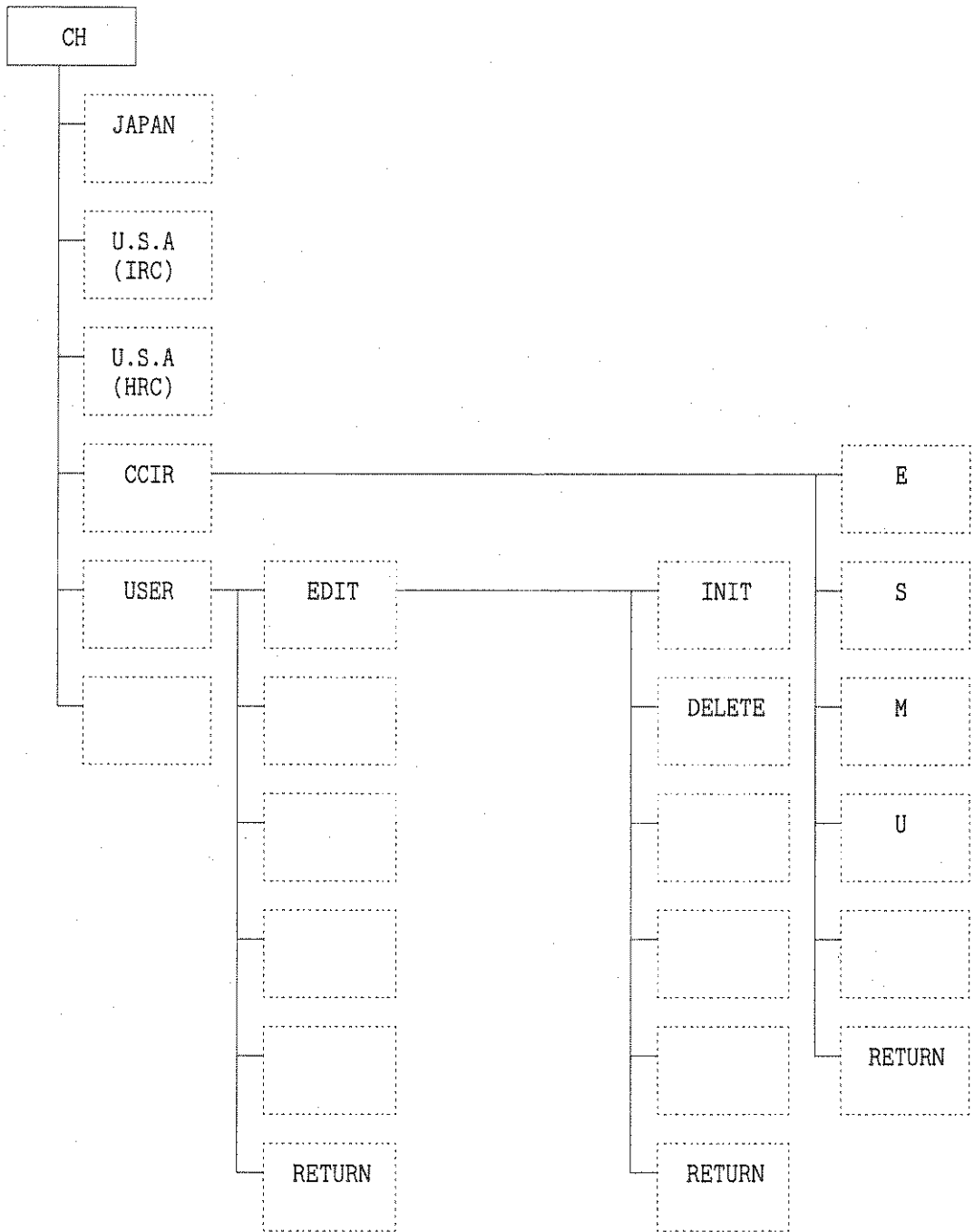

9.4.5 GPIB Command

(1) Channel setup command(TVCH)

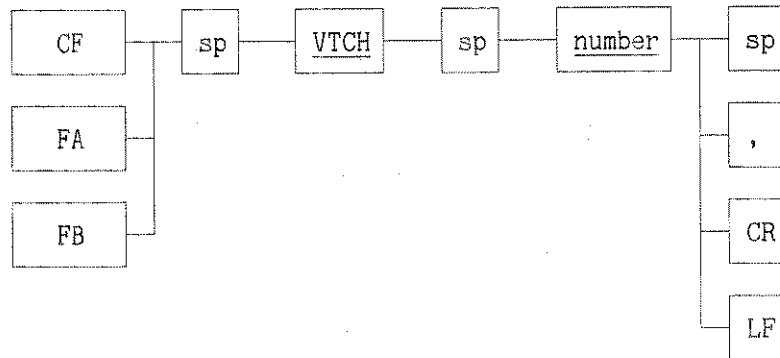

CF/FA/FB : Center/start/stop frequency
TVCH : Channel setup command
number : Channel number
1 ~ 99 → VHF, UHF channel
C1~C99 → CATV channel(Japan, USA)
E2~E12 → CATV channel(Europe)
S1~S3 → CATV channel(Europe)
M1~M10 → CATV channel(Europe)
U1~U31 → CATV channel(Europe)
0 → Channel input mode off

(a) Specify 8 channel to the center channel. (In case of internal controller)

OUTPUT 31;"CF TVCH 8"

(b) Specify the center frequency to Europe CATV"U31" channel.

OUTPUT 31;"FA TVCH U31"

(c) Turn off channel input mode.

OUTPUT 31;"TVCHO"

(2) Channel selection command(TVCHMODE)

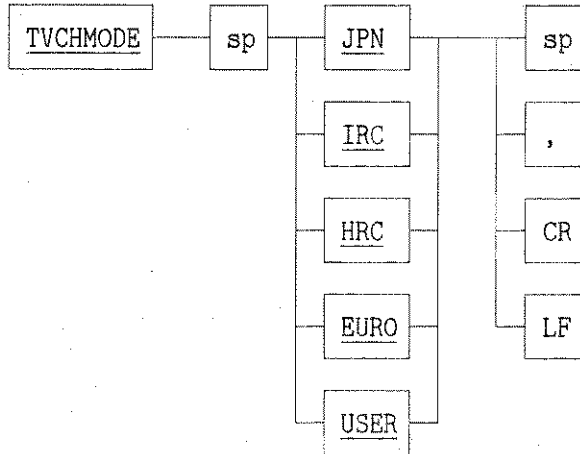

TVCHMODE: Channel selection command
JPN : Japan channel
IRC : USA channel(IRC)
HRC : USA channel(HRC)
EURO : Europe channel
USER : User channel

(a) Select Japan channel and specify 3 channel.

OUTPUT 31;"TVCHMODE JPN CF TVCH 3"

(b) Select Europe channel and specify M2 channel.

OUTPUT 31;"TVCHMODE EURO,FA TVCH M2"

9.5 AUTO Function

key was added so that the program in the memory card can be run easily.

When is pressed after turning on the spectrum analyzer, the program which has the file name "AUTOSTART" in the memory card is loaded and executed automatically.

Operating Procedure:

- ① Insert the memory card containing programs to the memory card insertion part correctly.
- ② Pressing changes the mode from the measurement mode to the controller mode, loads the program from the memory card and executes it. If the program has already existed in the internal memory of the analyzer, the program loading from the memory card is omitted.

If you want to load a program from another card after a program is executed from a card, once turn off the power.

Note: When the memory card is not inserted or the program to be loaded does not exist in the card, the process is stopped in the same state when the mode was changed to the controller mode.

- ③ Press to stop the program in the midst of the execution.
- ④ After a program is executed, if you want to execute the program again, then press .
- ⑤ After the program execution, if you want to return the mode from the controller mode to the measurement mode, then press .

R3261/3361
SPECTRUM ANALYZER
INSTRUCTION MANUAL

10. Specifications

10. SPECIFICATIONS

R3261/3361
SPECTRUM ANALYZER
INSTRUCTION MANUAL

10.1 R3261C Specifications

10.1 R3261C Specifications

(1) Frequency Specifications

Measurable bandwidth	: 9kHz to 2.6GHz
Center frequency setting increment	: 1Hz
Center frequency indication accuracy	: $\pm(3\%$ of the span + center frequency x reference oscillator accuracy + 20Hz) (span \geq 2MHz) $\pm(2\%$ of the span + center frequency x reference oscillator accuracy + 50kHz) (span $<$ 2MHz)
Reference oscillator	: Internal or external input (10MHz)
Internal reference oscillator accuracy	
Aging	: $\pm 2 \times 10^{-8}$ per day $\pm 1 \times 10^{-7}$ per year
Temperature stability	: $\pm 5 \times 10^{-8}$ (from 0 to +50°C, +25°C as a reference)
Frequency span	
LIN mode	: 1kHz to 2.6GHz, and 0
LOG mode	: 1, 2, or 3 decades of span can be selected within the range from 10kHz to 1000MHz.
Frequency span accuracy	
LIN mode	: $\pm 3\%$ of the span (span \geq 2MHz) $\pm 5\%$ of the span (span $<$ 2MHz)
Frequency stability	
Residual FM	: 50kHz p-p or less (span \geq 10MHz) 2kHz p-p or less (10MHz \geq span \geq 2MHz) 20Hz p-p or less (span $<$ 2MHz)
Frequency drift	: 300Hz/min. or less (span \geq 2MHz, at a constant temperature after an hour of warming up)
Side band noise	: -105dBc/Hz (20kHz offset)
Resolution	
3dB bandwidth	: 30Hz to 1MHz, switched at 1 to 3 steps

R3261/3361
SPECTRUM ANALYZER
INSTRUCTION MANUAL

10.1 R3261C Specifications

6dB bandwidth : 200Hz, 9kHz, 120kHz
Selectivity : 15:1 (60dB : 3dB)
Bandwidth accuracy : $\pm 20\%$

Marker accuracy
Normal mode : Center frequency indication accuracy + span accuracy
Counter mode : Indicated frequency x reference oscillator accuracy ± 1 count (SPAN 100MHz)

(2) Amplitude Specifications

Amplitude measurement range : -130dBm to +25dBm

Screen display range
LOG mode : 120dB (10dB/div)
: 80dB (10dB/div)
: 50dB (5dB/div)
: 20dB (2dB/div)
: 10dB (1dB/div)
LIN mode : 10div
QP mode : 80dB (10dB/div)
Provided the measurement range is 70dB

Linearity display
LOG mode : ± 2.0 dB/110dB, ± 1.5 dB/70dB, ± 1.0 dB/10dB,
 ± 0.2 dB/1dB
LIN mode : $\pm 5\%$ of the fullscale
QP mode : ± 2.0 dB/70dB, ± 1.0 dB/40dB

Reference level indication range : -109.9dBm to +40.0dBm
0.715 μ V to 22.4V

Reference level accuracy : ± 0.3 dB 0 to -50dBm (after automatic calibration)
 ± 0.7 dB +20 to -70dBm (after automatic calibration)

Dynamic range
Average noise level : -121dBm + 1.55f(GHz)dB
(Resolution bandwidth 300Hz, video bandwidth 1Hz, input attenuator 0dB, frequency 1MHz or more)

Secondary, tertiary distortion : -70dB -30dBm input
(Input attenuator 0dB, frequency 10MHz or more)

R3261/3361
SPECTRUM ANALYZER
INSTRUCTION MANUAL

10.1 R3261C Specifications

Frequency response : $\pm 0.5\text{dB}$ 100kHz to 2GHz
 $\pm 1.0\text{dB}$ 9kHz to 2.6GHz
(LOG mode, input attenuator 10dB, 20 to 30°C)
Residual response : -100dBm (Input attenuator 0dB, 50 Ω terminator, frequency 500kHz or more)

Resolution bandwidth switching accuracy:
: $\pm 0.3\text{dB}$ (after automatic calibration)

Video filter : 1Hz to 1MHz (switched 1 to 10 steps)

(3) Sweep Specifications

Sweep time : 30msec to 1000sec and Manual sweeping

Sweep time accuracy : $\pm 3\%$

Trigger mode : FREE RUN, LINE, VIDEO, EXT, TV-V, SINGLE

(4) Input Specifications

Input impedance : Approx. 50 Ω
VSWR ≤ 1.5 (100kHz $\leq f \leq$ 2GHz)
VSWR ≤ 2.0 (9kHz $\leq f \leq$ 2.6GHz)
(Input attenuator $\leq 10\text{dB}$)

Input connector : N connector

Maximum input level : +25dBm (input attenuator $\leq 30\text{dB}$)
 $\pm 50\text{VDC}$ max

Input attenuator : 0 to 50dB (10dB steps)

Input attenuator switching accuracy
: $\pm 1.0\text{dB}$ ($\leq 2.0\text{GHz}$)
 $\pm 1.5\text{dB}$ ($\leq 2.6\text{GHz}$)
(Input attenuator 10dB standard)

Detection mode : NORMAL, POSI, NEGA, SAMPLE

(5) Output Specifications

External memory function : IC memory card

Video output : Approx. 1Vp-p, approx 75 Ω , composite

Sound monitor output : The AM and FM sound can be monitored with an approximately 8 Ω earphone.

Power supply for probes : $\pm 15\text{V}$, 4-pin connector

R3261/3361
SPECTRUM ANALYZER
INSTRUCTION MANUAL

10.1 R3261C Specifications

Recorder output : X axis approx. -5 to +5V, output impedance approx. 10k Ω
Y axis approx. 0 to +4V, output impedance approx. 220 Ω

GPIB data output/
Remote control : The built-in GPIB interface allows data output and remote control.

Direct plot : Also, the built-in GPIB interface allows an output of on-screen data to the R9833 plotter to have a hardcopy.

Printer output : The built-in GPIB interface allows HP2225AJ to output a hard copy of on-screen data.

(6) Indication Specifications

Indicated items : Waveforms, setting conditions, grid, label

CRT display unit : 5.5 inch

Trace : Two screens of A and B

WRITE : Signal response from the analyzer is indicated at every sweeping.

VIEW : The WRITE waveform contained in the memory, or other contents in the memory are displayed.

MAX HOLD : Indication of the maximum signal level of repeat sweeping

AVG : Indication of the average of repeat sweeping

(7) Other functions

Occupied bandwidth measurement/ Adjacent channel leakage power measurement

Multi-marker measurement

R3261/3361
SPECTRUM ANALYZER
INSTRUCTION MANUAL

10.1 R3261C Specifications

(8) General Specifications

Using ambient condition : 0 to 50°C
85%RH or less

Storage temperature range : -20 to +60°C

Power supply : Line voltage range 90 to 132VAC or
198 to 250VAC is automatically selected
internally.
48 to 66Hz

Power consumption : 220VA or less

Dimensions : Approx. 330(W) x 177(H) x 450(D) mm

Mass : Approx. 15kg

R3261/3361
SPECTRUM ANALYZER
INSTRUCTION MANUAL

10.2 R3261CN Specifications

10.2 R3261CN Specifications

(1) Frequency Specifications

Measurable bandwidth	: 9kHz to 2.6GHz
Center frequency setting increment	: 1Hz
Center frequency indication accuracy	: $\pm(3\%$ of the span + center frequency x reference oscillator accuracy + 20Hz) (span \geq 2MHz) $\pm(2\%$ of the span + center frequency x reference oscillator accuracy + 50kHz) (span $<$ 2MHz)
Reference oscillator	: Internal or external input (10MHz)
Internal reference oscillator accuracy	
Aging	: $\pm 2 \times 10^{-8}$ per day $\pm 1 \times 10^{-7}$ per year
Temperature stability	: $\pm 5 \times 10^{-8}$ (from 0 to +50°C, +25°C as a reference)
Frequency span	
LIN mode	: 1kHz to 2.6GHz, and 0
LOG mode	: 1, 2, or 3 decades of span can be selected within the range from 10kHz to 1000MHz.
Frequency span accuracy	
LIN mode	: $\pm 3\%$ of the span (span \geq 2MHz) $\pm 5\%$ of the span (span $<$ 2MHz)
Frequency stability	
Residual FM	: 50kHz p-p or less (span \geq 10MHz) 2kHz p-p or less (10MHz \geq span \geq 2MHz) 20Hz p-p or less (span $<$ 2MHz)
Frequency drift	: 300Hz/min. or less (span \geq 2MHz, at a constant temperature after an hour of warming up)
Side band noise	: -105dBc/Hz (20kHz offset)
Resolution	
3dB bandwidth	: 30Hz to 1MHz, switched at 1 to 3 steps
6dB bandwidth	: 200Hz, 9kHz, 120kHz
Selectivity	: 15: 1 (60dB : 3dB)
Bandwidth accuracy	: $\pm 20\%$

R3261/3361
SPECTRUM ANALYZER
INSTRUCTION MANUAL

10.2 R3261CN Specifications

Marker accuracy
Normal mode : Center frequency indication accuracy + span accuracy
Counter mode : Indicated frequency x reference oscillator accuracy ± 1 count (SPAN 100MHz)

(2) Amplitude Specifications

Amplitude measurement range : -19dB μ to +132dB μ

Screen display range

LOG mode : 120dB (10dB/div)
: 80dB (10dB/div)
: 50dB (5dB/div)
: 20dB (2dB/div)
: 10dB (1dB/div)

LIN mode : 10div

QP mode : 80dB (10dB/div)

Provided the measurement range is 70dB

Linearity display

LOG mode : ± 2.0 dB/110dB, ± 1.5 dB/70dB, ± 1.0 dB/10dB, ± 0.2 dB/1dB

LIN mode : $\pm 5\%$ of the fullscale

QP mode : ± 2.0 dB/70dB, ± 1.0 dB/40dB

Reference level indication range

: +0.1dB μ to +150dB μ
1.01 μ V to 31.6V

Reference level accuracy : ± 0.3 dB +110 to +60dB μ (after automatic calibration)

± 0.7 dB +130 to +40dB μ (after automatic calibration)

Dynamic range

Average noise level : -10dB μ + 1.55f(GHz)dB
(Resolution bandwidth 300Hz, video bandwidth 1Hz, input attenuator 0dB, frequency 1MHz or more)

Secondary, tertiary distortion

: -70dB -30dBm input
(Input attenuator 0dB, frequency 10MHz or more)

Frequency response : ± 0.5 dB 100kHz to 2GHz

± 1.5 dB 9kHz to 2.6GHz

(LOG mode, input attenuator 10dB, 20 to 30°C)

Residual response

: -11dB μ (Input attenuator 0dB, 75 Ω terminator, frequency 500kHz or more)

R3261/3361
SPECTRUM ANALYZER
INSTRUCTION MANUAL

10.2 R3261CN Specifications

- Resolution bandwidth switching accuracy:
: $\pm 0.3\text{dB}$ (after automatic calibration)
- Video filter : 1Hz to 1MHz (switched 1 to 10 steps)
- (3) Sweep Specifications
- Sweep time : 30msec to 1000sec and Manual sweeping
- Sweep time accuracy : $\pm 3\%$
- Trigger mode : FREE RUN, LINE, VIDEO, EXT, TV-V, SINGLE
- (4) Input Specifications
- Input impedance : Approx. 75Ω
VSWR ≤ 1.5 (100kHz $\leq f \leq 2\text{GHz}$)
VSWR ≤ 2.0 (9kHz $\leq f \leq 2.6\text{GHz}$)
(Input attenuator $\leq 10\text{dB}$)
- Input connector : N connector
- Maximum input level : $+132\text{dB}\mu$ (input attenuator $\leq 30\text{dB}$)
 $\pm 50\text{VDC}$ max
- Input attenuator : 0 to 50dB (10dB steps)
- Input attenuator switching accuracy
: $\pm 1.0\text{dB}$ ($\leq 2.0\text{GHz}$)
 $\pm 1.5\text{dB}$ ($\leq 2.6\text{GHz}$)
(Input attenuator 10dB standard)
- Detection mode : NORMAL, POSI, NEGA, SAMPLE
- (5) Output Specifications
- External memory function : IC memory card
- Video output : Approx. 1Vp-p, approx 75Ω , composite
- Sound monitor output : The AM and FM sound can be monitored with
an approximately 8Ω earphone.
- Power supply for probes : $\pm 15\text{V}$, 4-pin connector
- Recorder output : X axis approx. -5 to +5V, output impedance
approx. $10\text{k}\Omega$
Y axis approx. 0 to +4V, output impedance
approx. 220Ω

R3261/3361
SPECTRUM ANALYZER
INSTRUCTION MANUAL

10.2 R3261CN Specifications

GPIB data output/
Remote control : The built-in GPIB interface allows data
output and remote control.

Direct plot : Also, the built-in GPIB interface allows
an output of on-screen data to the R9833
plotter to have a hardcopy.

Printer output : The built-in GPIB interface allows
HP2225AJ to output a hard copy of
on-screen data.

(6) Indication Specifications

Indicated items : Waveforms, setting conditions, grid, label

CRT display unit : 5.5 inch

Trace : Two screens of A and B

WRITE : Signal response from the analyzer is
indicated at every sweeping.

VIEW : The WRITE waveform contained in the
memory, or other contents in the memory
are displayed.

MAX HOLD : Indication of the maximum signal level of
repeat sweeping

AVG : Indication of the average of repeat
sweeping

(7) Other functions

Occupied bandwidth measurement/ Adjacent channel leakage power
measurement

Multi-marker measurement

R3261/3361
SPECTRUM ANALYZER
INSTRUCTION MANUAL

10.2 R3261CN Specifications

(8) General Specifications

Using ambient condition : 0 to 50°C
85%RH or less

Storage temperature range : -20 to +60°C

Power supply : Line voltage range 90 to 132VAC or
198 to 250VAC is automatically selected
internally.
48 to 66Hz

Power consumption : 220VA or less

Dimensions : Approx. 330(W) x 177(H) x 450(D) mm

Mass : Approx. 15kg

R3261/3361
SPECTRUM ANALYZER
INSTRUCTION MANUAL

10.3 R3261D Specifications

10.3 R3261D Specifications

(1) Frequency Specifications

Measurable bandwidth : 9kHz to 3.6GHz

Center frequency setting increment
: 1Hz

Center frequency indication accuracy
: $\pm(3\%$ of the span + center frequency x
reference oscillator accuracy + 20Hz)
(span \geq 2MHz)
 $\pm(2\%$ of the span + center frequency x
reference oscillator accuracy + 50kHz)
(span $<$ 2MHz)

Reference oscillator : Internal or external input (10Hz)

Internal reference oscillator accuracy
Aging : $\pm 2 \times 10^{-8}$ per day
 $\pm 1 \times 10^{-7}$ per year
Temperature stability : $\pm 5 \times 10^{-8}$ (from 0 to +50°C, +25°C as
a reference)

Frequency span
LIN mode : 1kHz to 3.6GHz and 0
LOG mode : 1, 2, or 3 decades of span can be selected
within the range from 10kHz to 1000MHz.

Frequency span accuracy
LIN mode : $\pm 3\%$ of the span (span \geq 2MHz)
 $\pm 5\%$ of the span (span $<$ 2MHz)

Frequency stability
Residual FM : 50kHz p-p or less (span \geq 10MHz)
2kHz p-p or less (10MHz \leq span $<$ 2MHz)
20Hz p-p or less (span $<$ 2MHz)
Frequency drift : 300Hz/min. or less (span \geq 2MHz, at a
constant temperature after an hour of
warming up)

Side band noise : ≤ -105 dBc/Hz f \leq 3.0GHz
 ≤ -101 dBc/Hz f \leq 3.6GHz
(20kHz offset)

Resolution
3dB bandwidth : 30Hz to 1MHz, switched 1 to 3 steps
6dB bandwidth : 200Hz, 9kHz, 120kHz
Selectivity : 15:1 (60dB : 3dB)
Bandwidth accuracy : $\pm 20\%$

R3261/3361
SPECTRUM ANALYZER
INSTRUCTION MANUAL

10.3 R3261D Specifications

Marker accuracy
Normal mode : Center frequency indication accuracy + span accuracy
Counter mode : Indicated frequency x reference oscillator accuracy ± 1 count (SPAN 100MHz)

(2) Amplitude Specifications

Amplitude measurement range : -130dBm to +25dBm

Screen display range

LOG mode : 120dB (10dB/div)
: 80dB (10dB/div)
: 50dB (5dB/div)
: 20dB (2dB/div)
: 10dB (1dB/div)

LIN mode : 10div

QP mode : 80dB (10dB/div)

Provided the measurement range is 70dB

Linearity display

LOG mode : ± 2.0 dB/110dB, ± 1.5 dB/70dB, ± 1.0 dB/10dB,
 ± 0.2 dB/1dB

LIN mode : $\pm 5\%$ of the fullscale

QP mode : ± 2.0 dB/70dB, ± 1.0 dB/40dB

Reference level indication range

: -109.9dBm to +40.0dBm
0.715 μ V to 22.4V

Reference level accuracy : ± 0.3 dB 0 to -50dBm (after automatic calibration)
 ± 0.7 dB +20 to -70dBm (after automatic calibration)

Dynamic range

Average noise level : -121dBm + 1.55f(GHz)dB
(Resolution bandwidth 300Hz, video bandwidth 1Hz, input attenuator 0dB, frequency 1MHz or more)

Secondary, tertiary distortion

: -70dB -30dBm input
(Input attenuator 0dB, frequency 10MHz or more)

Frequency response : ± 0.5 dB 100kHz to 2GHz
 ± 1.0 dB 9kHz to 3.6GHz
(LOG mode, input attenuator 10dB, 20 to 30°C)

Residual response : -100dBm (Input attenuator 0dB, 50 Ω terminator, frequency 500kHz or more)

R3261/3361
SPECTRUM ANALYZER
INSTRUCTION MANUAL

10.3 R3261D Specifications

Resolution bandwidth switching accuracy
: ± 0.3 dB (after automatic calibration)

Video filter : 1Hz to 1MHz (switched 1 to 10 steps)

(3) Sweep Specifications

Sweep time : 30msec to 1000sec and Manual sweeping

Sweep time accuracy : $\pm 3\%$

Trigger mode : FREE RUN, LINE, VIDEO, EXT, TV-V, SINGLE

(4) Input Specifications

Input impedance : Approx. 50Ω
VSWR ≤ 1.5 (100kHz $\leq f \leq$ 2GHz)
VSWR ≤ 2.0 (9kHz $\leq f \leq$ 3.6GHz)
(Input attenuator ≤ 10 dB)

Input connector : N connector

Maximum input level : +25dBm (input attenuator ≤ 30 dB)
 ± 50 VDC max

Input attenuator : 0 to 50dB (10dB steps)

Input attenuator switching accuracy
: ± 1.0 dB (≤ 2.0 GHz)
 ± 1.5 dB (≤ 3.6 GHz)
(Input attenuator 10dB standard)

Detection mode : NORMAL, POSI, NEGA, SAMPLE

(5) Output Specifications

External memory function : IC memory card

Video output : Approx. 1Vp-p, approx 75Ω , composite

Sound monitor output : The AM and FM sound can be monitored with
an approximately 8Ω earphone.

Power supply for probes : ± 15 V, 4-pin connector

Recorder output : X axis approx. -5 to +5V, output impedance
approx. $10k\Omega$
Y axis approx. 0 to +4V, output impedance
approx. 220Ω

R3261/3361
SPECTRUM ANALYZER
INSTRUCTION MANUAL

10.3 R3261D Specifications

- GPIB data output/
Remote control : The built-in GPIB interface allows data output and remote control.
- Direct plot : Also, the built-in GPIB interface allows an output of on-screen data to the R9833 plotter to have a hardcopy.
- Printer output : The built-in GPIB interface allows HP2225AJ to output a hard copy of on-screen data.

(6) Indication Specifications

- Indicated items : Waveforms, setting conditions, grid, label
- CRT display unit : 5.5 inch
- Trace : Two screens of A and B
- WRITE : Signal response from the analyzer is indicated at every sweeping.
- VIEW : The WRITE waveform contained in the memory, or other contents in the memory are displayed.
- MAX HOLD : Indication of the maximum signal level of repeat sweeping
- AVG : Indication of the average of repeat sweeping

(7) Other functions

- Occupied bandwidth measurement/ Adjacent channel leakage power measurement
- Multi-marker measurement

R3261/3361
SPECTRUM ANALYZER
INSTRUCTION MANUAL

10.3 R3261D Specifications

(8) General Specifications

Using ambient condition : 0 to 50°C
85%RH or less

Storage temperature range : -20 to +60°C

Power supply : Line voltage range 90 to 132VAC or
198 to 250VAC is automatically selected
internally.

48 to 66Hz

Power consumption : 220VA or less

Dimensions : Approx. 330(W) x 177(H) x 450(D) mm

Mass : Approx. 15kg

R3261/3361
SPECTRUM ANALYZER
INSTRUCTION MANUAL

10.4 R3361C Specifications

10.4 R3361C Specifications

(1) Frequency Specifications

Measurable bandwidth : 9kHz to 2.6GHz

Center frequency setting increment
: 1Hz

Center frequency indication accuracy
: $\pm(3\%$ of the span + center frequency x
reference oscillator accuracy + 20Hz)
(span 2MHz)
 $\pm(2\%$ of the span + center frequency x
reference oscillator accuracy + 50kHz)
(span 2MHz)

Reference oscillator : Internal or external input (10MHz)

Internal reference oscillator accuracy
Aging : $\pm 2 \times 10^{-8}$ per day
 $\pm 1 \times 10^{-7}$ per year
Temperature stability : $\pm 5 \times 10^{-8}$ (from 0 to +50°C, +25°C as
a reference)

Frequency span
LIN mode : 1kHz to 2.6GHz and 0
LOG mode : 1, 2, or 3 decades of span can be selected
within the range from 10kHz to 1000MHz.

Frequency span accuracy
LIN mode : $\pm 3\%$ of the span (span 2MHz)
 $\pm 5\%$ of the span (span 2MHz)

Frequency stability
Residual FM : 50kHz p-p or less (span 10MHz)
2kHz p-p or less (10MHz span 2MHz)
20Hz p-p or less (span 2MHz)
Frequency drift : 300Hz/min. or less (span 2MHz, at a
constant temperature after an hour of
warming up)

Side band noise : -105dBc/Hz (20kHz offset)

Resolution
3dB bandwidth : 30Hz to 1MHz, switched 1 to 3 steps
6dB bandwidth : 200Hz, 9kHz, 120kHz
Selectivity : 15: 1 (60dB : 3dB)
Bandwidth accuracy : $\pm 20\%$

R3261/3361
SPECTRUM ANALYZER
INSTRUCTION MANUAL

10.4 R3361C Specifications

Marker accuracy
Normal mode : Center frequency indication accuracy + span accuracy
Counter mode : Indicated frequency x reference oscillator accuracy ± 1 count (SPAN 100MHz)
(Excepting TG mode)

(2) Amplitude Specifications

Amplitude measurement range : -130dBm to +25dBm

Screen display range
LOG mode : 120dB (10dB/div)
: 80dB (10dB/div)
: 50dB (5dB/div)
: 20dB (2dB/div)
: 10dB (1dB/div)
LIN mode : 10div
QP mode : 80dB (10dB/div)
Provided the measurement range is 70dB

Linearity display
LOG mode : ± 2.0 dB/110dB, ± 1.5 dB/70dB, ± 1.0 dB/10dB,
 ± 0.2 dB/1dB
LIN mode : $\pm 5\%$ of the fullscale
QP mode : ± 2.0 dB/70dB, ± 1.0 dB/40dB

Reference level indication range : -109.9dBm to +40.0dBm
0.715 μ V to 22.4V

Reference level accuracy : ± 0.3 dB 0 to -50dBm (after automatic calibration)
 ± 0.7 dB +20 to -70dBm (after automatic calibration)

Dynamic range
Average noise level : -121dBm + 1.55f(GHz)dB
(Resolution bandwidth 300Hz, video bandwidth 1Hz, input attenuator 0dB, frequency 1MHz or more)

Secondary, tertiary distortion : -70dB -30dBm input
(Input attenuator 0dB, frequency 10MHz or more)

Frequency response : ± 0.5 dB 100kHz to 2GHz
 ± 1.0 dB 9kHz to 2.6GHz
(LOG mode, input attenuator 10dB, 20 to 30 $^{\circ}$ C)

Residual response : -100dBm (Input attenuator 0dB, 50 Ω terminator, frequency 500kHz or more)

R3261/3361
SPECTRUM ANALYZER
INSTRUCTION MANUAL

10.4 R3361C Specifications

Resolution bandwidth switching accuracy
: ± 0.3 dB (after automatic calibration)

Video filter : 1Hz to 1MHz (switched 1 to 10 steps)

(3) Sweep Specifications

Sweep time : 30msec to 1000sec and Manual sweeping

Sweep time accuracy : $\pm 3\%$

Trigger mode : FREE RUN, LINE, VIDEO, EXT, TV-V, SINGLE

(4) Input Specifications

Input impedance : Approx. 50Ω
VSWR ≤ 1.5 (100kHz $\leq f \leq 2$ GHz)
VSWR ≤ 2.0 (9kHz $\leq f \leq 2.6$ GHz)
(Input attenuator ≤ 10 dB)

Input connector : N connector

Maximum input level : +25dBm (input attenuator ≤ 30 dB)
 ± 50 VDC max

Input attenuator : 0 to 50dB (10dB steps)

Input attenuator switching accuracy
: ± 1.0 dB (≤ 2.0 GHz)
 ± 1.5 dB (≤ 2.6 GHz)
(Input attenuator 10dB standard)

Detection mode : NORMAL, POSI, NEGA, SAMPLE

(5) Tracking generator specifications

Frequency range : 9kHz to 2.6GHz

Output level range : 0dBm to -50dBm Setting can be done in
steps of 1dB.

Output level accuracy : ± 0.5 dB (30MHz, -10dBm, +20 to +30°C)

Output level flatness : ± 0.7 dB (100kHz to 1.0GHz)
 ± 1.5 dB (9kHz to 2.6GHz)
(-10dBm output)

R3261/3361
SPECTRUM ANALYZER
INSTRUCTION MANUAL

10.4 R3361C Specifications

Output level switching accuracy	: $\pm 1.0\text{dB}$ (100kHz to 1.0GHz) $\pm 2.0\text{dB}$ (9kHz to 2.6GHz) (-10dBm reference)
Output spuriousness	: Harmonics spurious level $__ -20\text{dB}$ Non-harmonics spurious level $__ -30\text{dB}$ (Output level 0dBm)
TG leakage	: $__ -110\text{dBm}$
Output impedance	: Approx. 50Ω
Output VSWR	: $__ 1.5$ (100kHz to 2.0GHz) $__ 2.0$ (9kHz to 2.6GHz) (At -10dBm output)
Minimum resolution bandwidth	: 300Hz
Output connector	: N-connector

(6) Output Specifications

External memory function:	IC memory card
Video output	: Approx. 1Vp-p, approx. 75Ω , composite
Sound monitor output	: The AM and FM sound can be monitored with an approximately 8Ω earphone.
Power supply for probes	: $\pm 15\text{V}$, 4-pin connector
Recorder output	: X axis approx. -5 to +5V, output impedance approx. $10\text{k}\Omega$ Y axis approx. 0 to +4V, output impedance approx. 220Ω
GPIB data output/ Remote control	: The built-in GPIB interface allows data output and remote control.
Direct plot	: Also, the built-in GPIB interface allows an output of on-screen data to the R9833 plotter to have a hardcopy.
Printer output	: The built-in GPIB interface allows HP2225AJ to output a hard copy of on-screen data.

R3261/3361
SPECTRUM ANALYZER
INSTRUCTION MANUAL

10.4 R3361C Specifications

(7) Indication Specifications

Indicated items	: Waveforms, setting conditions, grid, label
CRT display unit	: 5.5 inch
Trace	: Two screens of A and B
WRITE	: Signal response from the analyzer is indicated at every sweeping.
VIEW	: The WRITE waveform contained in the memory, or other contents in the memory are displayed.
MAX HOLD	: Indication of maximum signal level during repeated sweeping
AVG	: Indication of average signal level during repeated sweeping

(8) Other functions

Occupied bandwidth measurement/ Adjacent channel leakage power measurement

Multi-marker measurement

(9) General Specifications

Using ambient condition	: 0 to 50°C 85%RH or less
Storage temperature range	: -20 to +60°C
Power supply	: Line voltage range 90 to 132VAC or 198 to 250VAC is automatically selected internally. 48 to 66Hz
Power consumption	: 220VA or less
Dimensions	: Approx. 330(W) x 177(H) x 450(D) mm
Mass	: Approx. 17kg

R3261/3361
SPECTRUM ANALYZER
INSTRUCTION MANUAL

10.5 R3361CN Specifications

10.5 R3361CN Specifications

(1) Frequency Specifications

Measurable bandwidth	: 9kHz to 2.6GHz
Center frequency setting increment	: 1Hz
Center frequency indication accuracy	: $\pm(3\%$ of the span + center frequency x reference oscillator accuracy + 20Hz) (span \geq 2MHz) $\pm(2\%$ of the span + center frequency x reference oscillator accuracy + 50kHz) (span $<$ 2MHz)
Reference oscillator	: Internal or external input (10MHz)
Internal reference oscillator accuracy	
Aging	: $\pm 2 \times 10^{-8}$ per day $\pm 1 \times 10^{-7}$ per year
Temperature stability	: $\pm 5 \times 10^{-8}$ (from 0 to +50°C, +25°C as a reference)
Frequency span	
LIN mode	: 1kHz to 2.6GHz and 0
LOG mode	: 1, 2, or 3 decades of span can be selected within the range from 10kHz to 1000MHz.
Frequency span accuracy	
LIN mode	: $\pm 3\%$ of the span (span \geq 2MHz) $\pm 5\%$ of the span (span $<$ 2MHz)
Frequency stability	
Residual FM	: 50kHz p-p or less (span \geq 10MHz) 2kHz p-p or less (10MHz \geq span \geq 2MHz) 20Hz p-p or less (span $<$ 2MHz)
Frequency drift	: 300Hz/min. or less (span \geq 2MHz, at a constant temperature after an hour of warming up)
Side band noise	: -105dBc/Hz (20kHz offset)
Resolution	
3dB bandwidth	: 30Hz to 1MHz, switched 1 to 3 steps
6dB bandwidth	: 200Hz, 9kHz, 120kHz
Selectivity	: 15: 1 (60dB : 3dB)
Bandwidth accuracy	: $\pm 20\%$

R3261/3361
SPECTRUM ANALYZER
INSTRUCTION MANUAL

10.5 R3361CN Specifications

Marker accuracy
Normal mode : Center frequency indication accuracy + span accuracy
Counter mode : Indicated frequency x reference oscillator accuracy ± 1 count (SPAN 100MHz)
(Excepting TG mode)

(2) Amplitude Specifications

Amplitude measurement range : -19dB μ to +132dB μ

Screen display range

LOG mode : 120dB (10dB/div)
: 80dB (10dB/div)
: 50dB (5dB/div)
: 20dB (2dB/div)
: 10dB (1dB/div)

LIN mode : 10div

QP mode : 80dB (10dB/div)

Provided the measurement range is 70dB

Linearity display

LOG mode : ± 2.0 dB/110dB, ± 1.5 dB/70dB, ± 1.0 dB/10dB,
 ± 0.2 dB/1dB

LIN mode : $\pm 5\%$ of the fullscale

QP mode : ± 2.0 dB/70dB, ± 1.0 dB/40dB

Reference level indication range

: +0.1dB μ to +150dB μ
1.01 μ V to 31.6V

Reference level accuracy : ± 0.3 dB +110 to +60dB μ (after automatic calibration)
 ± 0.7 dB +130 to +40dB μ (after automatic calibration)

Dynamic range

Average noise level : -10dB μ + 1.55f(GHz)dB
(Resolution bandwidth 300Hz, video bandwidth 1Hz, input attenuator 0dB, frequency 1MHz or more)

Secondary, tertiary distortion

: -70dB -30dBm input
(Input attenuator 0dB, frequency 10MHz or more)

Frequency response : ± 0.5 dB 100kHz to 2GHz
 ± 1.5 dB 9kHz to 2.6GHz
(LOG mode, input attenuator 10dB, 20 to 30°C)

Residual response : ± 11 dB μ (Input attenuator 0dB, 75 Ω terminator, frequency 500kHz or more)

R3261/3361
SPECTRUM ANALYZER
INSTRUCTION MANUAL

10.5 R3361CN Specifications

Resolution bandwidth switching accuracy
: ± 0.3 dB (after automatic calibration)

Video filter : 1Hz to 1MHz (switched 1 to 10 steps)

(3) Sweep Specifications

Sweep time : 30msec to 1000sec and Manual sweeping

Sweep time accuracy : $\pm 3\%$

Trigger mode : FREE RUN, LINE, VIDEO, EXT, TV-V, SINGLE

(4) Input Specifications

Input impedance : Approx. 75Ω
VSWR ≤ 1.5 (100kHz $\leq f \leq 2$ GHz)
VSWR ≤ 2.0 (9kHz $\leq f \leq 2.6$ GHz)
(Input attenuator ≤ 10 dB)

Input connector : N connector

Maximum input level : $+132$ dB μ (input attenuator ≤ 30 dB)
 ± 50 VDC max

Input attenuator : 0 to 50dB (10dB steps)

Input attenuator switching accuracy
: ± 1.0 dB (≤ 2.0 GHz)
 ± 1.5 dB (≤ 2.6 GHz)
(Input attenuator 10dB standard)

Detection mode : NORMAL, POSI, NEGA, SAMPLE

(5) Tracking generator specifications

Frequency range : 9kHz to 2.6GHz

Output level range : 105dB μ to +55dB μ Setting can be done in
steps of 1dB.

Output level accuracy : ± 0.5 dB (30MHz, +95dB μ , +20 to +30°C)

Output level flatness : ± 0.7 dB (100kHz to 1.0GHz)
 ± 1.5 dB (100kHz to 2.0GHz)
 ± 2.0 dB (9kHz to 2.6GHz)
(+95dB μ output)

R3261/3361
SPECTRUM ANALYZER
INSTRUCTION MANUAL

10.5 R3361CN Specifications

Output level switching accuracy	: $\pm 1.0\text{dB}$ (100kHz to 1.0GHz) $\pm 2.0\text{dB}$ (9kHz to 2.6GHz) (+95dB μ reference)
Output spuriousness	: Harmonics spurious level $_ -20\text{dB}$ Non-harmonics spurious level $_ -30\text{dB}$ (Output level +105dB μ)
TG leakage	: $_ +1\text{dB}\mu$
Output impedance	: Approx. 75Ω
Output VSWR	: $_ 1.5$ (100kHz to 2.0GHz) $_ 2.0$ (9kHz to 2.6GHz) (At +95dB μ output)
Minimum resolution bandwidth	: 300Hz
Output connector	: N-connector

(6) Output Specifications

External memory function:	IC memory card
Video output	: Approx. 1Vp-p, approx. 75Ω , composite
Sound monitor output	: The AM and FM sound can be monitored with an approximately 8Ω earphone.
Power supply for probes	: $\pm 15\text{V}$, 4-pin connector
Recorder output	: X axis approx. -5 to +5V, output impedance approx. $10\text{k}\Omega$ Y axis approx. 0 to +4V, output impedance approx. 220Ω
GPIB data output/ Remote control	: The built-in GPIB interface allows data output and remote control.
Direct plot	: Also, the built-in GPIB interface allows an output of on-screen data to the R9833 plotter to have a hardcopy.
Printer output	: The built-in GPIB interface allows HP2225AJ to output a hard copy of on-screen data.

R3261/3361
SPECTRUM ANALYZER
INSTRUCTION MANUAL

10.5 R3361CN Specifications

(7) Indication Specifications

Indicated items	: Waveforms, setting conditions, grid, label
CRT display unit	: 5.5 inch
Trace	: Two screens of A and B
WRITE	: Signal response from the analyzer is indicated at every sweeping.
VIEW	: The WRITE waveform contained in the memory, or other contents in the memory are displayed.
MAX HOLD	: Indication of maximum signal level during repeated sweeping
AVG	: Indication of average signal level during repeated sweeping

(8) Other functions

Occupied bandwidth measurement/ Adjacent channel leakage power measurement

Multi-marker measurement

(9) General Specifications

Using ambient condition	: 0 to 50°C 85%RH or less
Storage temperature range	: -20 to +60°C
Power supply	: Line voltage range 90 to 132VAC or 198 to 250VAC is automatically selected internally. 48 to 66Hz
Power consumption	: 220VA or less
Dimensions	: Approx. 330(W) x 177(H) x 450(D) mm
Mass	: Approx. 17kg

R3261/3361
SPECTRUM ANALYZER
INSTRUCTION MANUAL

10.6 R3361D Specifications

10.6 R3361D Specifications

(1) Frequency Specifications

Measurable bandwidth	: 9kHz to 3.6GHz
Center frequency setting increment	: 1Hz
Center frequency indication accuracy:	
	$\pm(3\%$ of the span + center frequency x reference oscillator accuracy + 20Hz) (span \geq 2MHz)
	$\pm(2\%$ of the span + center frequency x reference oscillator accuracy + 50kHz) (span $<$ 2MHz)
Reference oscillator	: Internal or external input (10Hz)
Internal reference oscillator accuracy	
Aging	: $\pm 2 \times 10^{-8}$ per day $\pm 1 \times 10^{-7}$ per year
Temperature stability	: $\pm 5 \times 10^{-8}$ (from 0 to +50°C, +25°C as a reference)
Frequency span	
LIN mode	: 1kHz to 3.6GHz and 0
LOG mode	: 1, 2, or 3 decades of span can be selected within the range from 10kHz to 1000MHz.
Frequency span accuracy	
LIN mode	: $\pm 3\%$ of the span (span \geq 2MHz) $\pm 5\%$ of the span (span $<$ 2MHz)
Frequency stability	
Residual FM	: 50kHz p-p or less (span \geq 10MHz) 2kHz p-p or less (10MHz \geq span \geq 2MHz) 20Hz p-p or less (span $<$ 2MHz)
Frequency drift	: 300Hz/min. or less (span \geq 2MHz, at a constant temperature after an hour of warming up)
Side band noise	: ≤ -105 dBc/Hz f \leq 3.0GHz ≤ -101 dBc/Hz f \leq 3.6GHz (20kHz offset)
Resolution	
3dB bandwidth	: 30Hz to 1MHz, switched 1 to 3 steps
6dB bandwidth	: 200Hz, 9kHz, 120kHz
Selectivity	: $\leq 15 : 1$ (60dB : 3dB)
Bandwidth accuracy	: $\pm 20\%$

R3261/3361
SPECTRUM ANALYZER
INSTRUCTION MANUAL

10.6 R3361D Specifications

Marker accuracy
Normal mode : Center frequency indication accuracy + span accuracy
Counter mode : Indicated frequency x reference oscillator accuracy ± 1 count (SPAN 100MHz)
(Excepting TG mode)

(2) Amplitude Specifications

Amplitude measurement range : -130dBm to +25dBm

Screen display range

LOG mode : 120dB (10dB/div)
: 80dB (10dB/div)
: 50dB (5dB/div)
: 20dB (2dB/div)
: 10dB (1dB/div)

LIN mode : 10div

QP mode : 80dB (10dB/div)

Provided the measurement range is 70dB

Linearity display

LOG mode : ± 2.0 dB/110dB, ± 1.5 dB/70dB, ± 1.0 dB/10dB,
 ± 0.2 dB/1dB

LIN mode : $\pm 5\%$ of the fullscale

QP mode : ± 2.0 dB/70dB, ± 1.0 dB/40dB

Reference level indication range

: -109.9dBm to +40.0dBm
0.715 μ V to 22.4V

Reference level accuracy : ± 0.3 dB 0 to -50dBm (after automatic calibration)
 ± 0.7 dB +20 to -70dBm (after automatic calibration)

Dynamic range

Average noise level : -121dBm + 1.55f(GHz)dB
(Resolution bandwidth 300Hz, video bandwidth 1Hz, input attenuator 0dB, frequency 1MHz or more)

Secondary, tertiary distortion

: -70dB -30dBm input
(Input attenuator 0dB, frequency 10MHz or more)

Frequency response : ± 0.5 dB (100kHz to 2GHz)
 ± 1.0 dB (9kHz to 3.6GHz)
(LOG mode, input attenuator 10dB, 20 to 30°C)

Residual response : -100dBm (Input attenuator 0dB, 50 Ω terminator, frequency 500kHz or more)

R3261/3361
SPECTRUM ANALYZER
INSTRUCTION MANUAL

10.6 R3361D Specifications

Resolution bandwidth switching accuracy
: ± 0.3 dB (after automatic calibration)

Video filter : 1Hz to 1MHz (switched 1 to 10 steps)

(3) Sweep Specifications

Sweep time : 30msec to 1000sec and Manual sweeping

Sweep time accuracy : $\pm 3\%$

Trigger mode : FREE RUN, LINE, VIDEO, EXT, TV-V, SINGLE

(4) Input Specifications

Input impedance : Approx. 50Ω
: VSWR ≤ 1.5 100kHz $\leq f \leq$ 2GHz
: VSWR ≤ 2.0 9kHz $\leq f \leq$ 3.6GHz
: Input attenuator ≤ 10 dB reference

Input connector : N connector

Maximum input level : +25dBm (input attenuator ≤ 30 dB)
 ± 50 VDC max

Input attenuator : 0 to 50dB (10dB steps)

Input attenuator switching accuracy
: ± 1.0 dB (≤ 2.0 GHz)
 ± 1.5 dB (≤ 3.6 GHz)
Input attenuator 10dB standard

Detection mode : NORMAL, POSI, NEGA, SAMPLE

(5) Tracking generator specifications

Frequency range : 9kHz to 3.6GHz

Output level range : 0dBm to -50dBm Setting can be done in
steps of 1dB.

Output level accuracy : ± 0.5 dB (30MHz, -10dBm, +20 to +30°C)

Output level flatness : ± 0.7 dB (100kHz to 1.0GHz)
 ± 1.5 dB (9kHz to 2.6GHz)
 ± 2.0 dB (9kHz to 3.6GHz)
(-10dBm output)

R3261/3361
SPECTRUM ANALYZER
INSTRUCTION MANUAL

10.6 R3361D Specifications

Output level switching accuracy	: $\pm 1.0\text{dB}$ (100kHz to 1.0GHz) $\pm 2.0\text{dB}$ (9kHz to 2.6GHz) $\pm 3.0\text{dB}$ (9kHz to 3.6GHz) (-10dBm reference)
Output spuriousness	: Harmonics spurious level $__ -20\text{dB}$ Non-harmonics spurious level $__ -30\text{dB}$ (Output level 0dBm)
TG leakage	: $__ -110\text{dBm}$ (frequency $__ 3.0\text{GHz}$) $__ -100\text{dBm}$ (frequency $__ 3.6\text{GHz}$)
Output impedance	: Approx. 50Ω
Output VSWR	: $__ \pm 1.5$ (100kHz to 2.0GHz) $__ \pm 2.0$ (9kHz to 3.6GHz) (At $__ -10\text{dBm}$ output)
Minimum resolution bandwidth	: 300Hz
Output connector	: N-connector

(6) Output Specifications

External memory function:	IC memory card
Video output	: Approx. 1Vp-p, approx. 75Ω , composite
Sound monitor output	: The AM and FM sound can be monitored with an approximately 8Ω earphone.
Power supply for probes	: $\pm 15\text{V}$, 4-pin connector
Recorder output	: X axis approx. -5 to +5V, output impedance approx. $10\text{k}\Omega$ Y axis approx. 0 to +4V, output impedance approx. 220Ω
GPIB data output/ Remote control	: The built-in GPIB interface allows data output and remote control.
Direct plot	: Also, the built-in GPIB interface allows an output of on-screen data to the R9833 plotter to have a hardcopy.
Printer output	: The built-in GPIB interface allows HP2225AJ to output a hard copy of on-screen data.

R3261/3361
SPECTRUM ANALYZER
INSTRUCTION MANUAL

10.6 R3361D Specifications

(7) Indication Specifications

Indicated items	: Waveforms, setting conditions, grid, label
CRT display unit	: 5.5 inch
Trace	: Two screens of A and B
WRITE	: Signal response from the analyzer is indicated at every sweeping.
VIEW	: The WRITE waveform contained in the memory, or other contents in the memory are displayed.
MAX HOLD	: Indication of maximum signal level during repeated sweeping
AVG	: Indication of average signal level during repeated sweeping

(8) Other functions

Occupied bandwidth measurement/ Adjacent channel leakage power measurement

Multi-marker measurement

(9) General Specifications

Using ambient conditions	: 0 to 50°C 85%RH or less
Storage temperature range	: -20 to +60°C
Power supply	: Line voltage range 90 to 132VAC or 198 to 250VAC is automatically selected internally. 48 to 66Hz
Power consumption	: 220VA or less
Dimensions	: Approx. 330(W) x 177(H) x 450(D) mm
Mass	: Approx. 17kg

R3261/3361
SPECTRUM ANALYZER
INSTRUCTION MANUAL

10.7 R3361NK Specifications

10.7 R3361NK Specification

(1) Frequency specifications

Measurable bandwidth	: 9kHz to 2.6GHz
Center frequency setting increment	: 1Hz
Center frequency indication accuracy	: $\pm(3\%$ of the span + center frequency x reference oscillator accuracy + 20Hz) (span \leq 2MHz) $\pm(2\%$ of the span + center frequency x reference oscillator accuracy + 50Hz) (span $>$ 2MHz)
Reference oscillator	: Internal or external input (10MHz)
Internal reference oscillator accuracy	
Aging	: $\pm 2 \times 10^{-8}$ per day $\pm 1 \times 10^{-7}$ per year
Temperature stability	: $\pm 5 \times 10^{-8}$ (from 0 to +50°C, +25°C as a reference)
Frequency span	
LIN mode	: 1kHz to 2.6GHz, and 0
LOG mode	: 1, 2, or 3 decades of span can be selected within the range from 10kHz to 1000MHz.
Frequency span accuracy	
LIN mode	: $\pm 3\%$ of the span (span $>$ 2MHz) $\pm 5\%$ of the span (span \leq 2MHz)
Frequency stability	
Residual FM	: 50kHz p-p or less (span $>$ 10MHz) 2kHz p-p or less (10MHz \geq span $>$ 2MHz) 20Hz p-p or less (span \leq 2MHz)
Frequency drift	: 300Hz/min. or less (span \leq 2MHz, at a constant temperature after an hour of warming up)
Side band noise	: ≤ -105 dBc/Hz (20kHz offset)
Resolution	
3dB bandwidth	: 30Hz to 1MHz, switched at 1 to 3 steps
6dB bandwidth	: 200Hz, 9kHz, 120kHz
Selectivity	: $\leq 15: 1$ (60dB : 3dB)
Bandwidth accuracy	: $\pm 20\%$

R3261/3361
SPECTRUM ANALYZER
INSTRUCTION MANUAL

10.7 R3361NK Specifications

Marker accuracy
Normal mode : Center frequency indication accuracy + span accuracy
Counter mode : Indicated frequency x reference oscillator accuracy ± 1 count (span ≤ 100 MHz)
(Expect TG mode)

(2) Amplitude specifications

Amplitude measurement range : -19dB μ to +132dB μ

Screen display range
LOG mode : 120dB (10dB/div)
: 80dB (10dB/div)
: 50dB (5dB/div)
: 20dB (2dB/div)
: 10dB (1dB/div)
LIN mode : 10div
QP mode : 80dB (10dB/div)
Provided the measurement range is 70dB.

Linearity display
LOG mode : ± 2.0 dB/110dB, ± 1.5 dB/70dB, ± 1.0 dB/10dB,
 ± 0.2 dB/1dB
LIN mode : $\pm 5\%$ of the fullscale
QP mode : ± 2.0 dB/70dB, ± 1.0 dB/40dB

Reference level indication range : +1.0dB μ to +150dB μ
1.01 μ V to 31.6V

Reference level accuracy : ± 0.3 dB +110dB μ to +60dB μ (after automatic calibration)
 ± 0.7 dB +130dB μ to +40dB μ (after automatic calibration)

Dynamic range
Average noise level : -10dB μ + 1.55f(GHz)dB
(Resolution bandwidth 300Hz, video bandwidth 1Hz, input attenuator 0dB, frequency 1MHz or more)

Secondary, tertiary distortion : ≤ -70 dB -30dBm input
(Input attenuator 0dB, frequency 10MHz or more)

Frequency response : ± 0.5 dB 100kHz to 2GHz
 ± 1.5 dB 9kHz to 2.6GHz
(LOG mode, input attenuator 10dB, 20 to 30°C)

R3261/3361
SPECTRUM ANALYZER
INSTRUCTION MANUAL

10.7 R3361NK Specifications

- Residual response : $\leq +11\text{dB}\mu$ (Input attenuator 0dB, 75 Ω terminator, frequency 500kHz or more)
- Resolution bandwidth switching accuracy : $\pm 0.3\text{dB}$ (after automatic calibration)
- Video filter : 1Hz to 1MHz (switched 1 to 10 steps)
- (3) Sweep specifications
- Sweep time : 30msec to 1000sec and manual sweeping
- Sweep time accuracy : $\leq 3\%$
- Trigger mode : FREE RUN, LINE, VIDEO, EXT, TV-V, SINGLE
- (4) Input specifications
- Input impedance : Approx. 75 Ω
VSWR ≤ 1.5 (100kHz $\leq f \leq 2\text{GHz}$)
VSWR ≤ 2.0 (9kHz $\leq f \leq 2.6\text{GHz}$)
(Input attenuator $\geq 10\text{dB}$)
- Input connector : N connector
- Maximum input level : +132dB μ (input attenuator $\geq 30\text{dB}$)
 $\pm 50\text{VDC max}$
- Input attenuator : 0 to 50dB (10dB steps)
- Input attenuator switching accuracy : $\pm 1.0\text{dB}$ ($\leq 2.0\text{GHz}$)
 $\pm 1.5\text{dB}$ ($\leq 2.6\text{GHz}$)
(Input attenuator 10dB reference)
- Detection mode : NORMAL, POSI, NEGA, SAMPLE
- (5) Tracking generator specifications
- Frequency range : 9kHz to 2.6GHz
- Output level range : 105dB μ to +55dB μ Setting can be done in steps of 1dB.
- Output level accuracy : $\pm 0.5\text{dB}$ (30MHz, +95dB μ +20 to +30°C)
- Output level flatness : $\pm 0.7\text{dB}$ (100kHz to 1.0GHz)
 $\pm 1.5\text{dB}$ (100kHz to 2.0GHz)
 $\pm 2.0\text{dB}$ (9kHz to 2.6GHz)
(+95dB μ output)

R3261/3361
SPECTRUM ANALYZER
INSTRUCTION MANUAL

10.7 R3361NK Specifications

Output level switching accuracy	: $\pm 1.0\text{dB}$ (100kHz to 1.0GHz) $\pm 2.0\text{dB}$ (9kHz to 2.6GHz) (+95dB μ reference)
Output spuriousness	: Harmonics spurious level $\leq -20\text{dB}$ Non-harmonics spurious level $\leq -30\text{dB}$ (Output level +105dB μ)
TG leakage	: $\leq +1\text{dB}\mu$
Output impedance	: Approx. 75 Ω
Output VSWR	: ≤ 1.5 (100kHz to 2.0GHz) ≤ 2.0 (9kHz to 2.6GHz) (At $\leq +95\text{dB}\mu$ output)
Minimum resolution bandwidth	: 300Hz
Output connector	: N-connector

(6) Output specifications

External memory function	: IC memory card
Video output	: Approx. 1Vp-p, approx 75 Ω , composite
Sound monitor output	: The AM and FM sound can be monitored with an approximately 8 Ω earphone.
Power supply for probes	: $\pm 15\text{V}$, 4-pin connector
Recorder output	: X axis approx. -5 to +5V, output impedance approx. 10k Ω Y axis approx. 0 to +4V, output impedance approx. 220 Ω
GPIB data output/ Remote control	: The built-in GPIB interface allows data output and remote control.
Direct plot	: Also, the built-in GPIB interface allows an output of on-screen data to the R9833 plotter to have a hardcopy.
Printer output	: The built-in GPIB interface allows HP2225AJ to output a hardcopy of on-screen data.

R3261/3361
SPECTRUM ANALYZER
INSTRUCTION MANUAL

10.7 R3361NK Specifications

(7) Indication specifications

Indicated items	: Waveforms, setting conditions, grid, label
CRT display unit	: 5.5 inch
Trace	: Two screens of A and B
WRITE	: Signal response from the analyzer is indicated at every sweeping.
VIEW	: The WRITE waveform contained in the memory, or other contents in the memory are displayed.
MAX HOLD	: Indication of maximum signal level of during repeated sweeping.
AVG	: Indication of average signal level during repeated sweeping.

(8) Other functions

Occupied bandwidth measurement/Adjacent channel leakage power measurement
Multi-marker measurement

(9) General specifications

Using ambient condition	: 0 to 50°C 85%RH or less
Storage temperature range	: -20 to 60°C
Power supply	: Line voltage range 90 to 132VAC or 198 to 250VAC is automatically selected internally. 48 to 66Hz
Power consumption	: 220VA or less
Dimensions	: Approx. 330(W) x 177(H) x 450(D) mm
Mass	: Approx. 17kg

R3261/3361
SPECTRUM ANALYZER
INSTRUCTION MANUAL

10.8 R3361K Specifications

10.8 R3361K Specification

(1) Frequency Specifications

Measurable bandwidth	: 9kHz to 2.6GHz
Center frequency setting increment	: 1Hz
Center frequency indication accuracy	: $\pm(3\%$ of the span + center frequency x reference oscillator accuracy + 20Hz) (span \leq 2MHz) $\pm(2\%$ of the span + center frequency x reference oscillator accuracy + 50Hz) (span $>$ 2MHz)
Reference oscillator	: Internal or external input (10MHz)
Internal reference oscillator accuracy	
Aging	: $\pm 2 \times 10^{-8}$ per day $\pm 1 \times 10^{-7}$ per year
Temperature stability	: $\pm 5 \times 10^{-8}$ (from 0 to +50°C, +25°C as a reference)
Frequency span	
LIN mode	: 1kHz to 2.6GHz, and 0
LOG mode	: 1, 2, or 3 decades of span can be selected within the range from 10kHz to 1000MHz.
Frequency span accuracy	
LIN mode	: $\pm 3\%$ of the span (span $>$ 2MHz) $\pm 5\%$ of the span (span \leq 2MHz)
Frequency stability	
Residual FM	: 50kHz p-p or less (span $>$ 10MHz) 2kHz p-p or less (10MHz \geq span $>$ 2MHz) 20Hz p-p or less (span \leq 2MHz)
Frequency drift	: 300Hz/min. or less (span \leq 2MHz, at a constant temperature after an hour of warming up)
Side band noise	: ≤ -105 dBc/Hz (20kHz offset)
Resolution	
3dB bandwidth	: 30Hz to 1MHz, switched at 1 to 3 steps
6dB bandwidth	: 200Hz, 9kHz, 120kHz
Selectivity	: $\leq 15: 1$ (60dB : 3dB)
Bandwidth accuracy	: $\pm 20\%$

R3261/3361
SPECTRUM ANALYZER
INSTRUCTION MANUAL

10.8 R3361K Specifications

Marker accuracy
Normal mode : Center frequency indication accuracy +
span accuracy
Counter mode : Indicated frequency x reference oscillator
accuracy ± 1 count (span ≤ 100 MHz)
(Expect TG mode)

(2) Amplitude Specifications

Amplitude measurement range
: -130dBm to +25dBm

Screen display range
LOG mode : 120dB (10dB/div)
: 80dB (10dB/div)
: 50dB (5dB/div)
: 20dB (2dB/div)
: 10dB (1dB/div)
LIN mode : 10div
QP mode : 80dB (10dB/div)
Provided the measurement range is 70dB.

Linearity display
LOG mode : ± 2.0 dB/110dB, ± 1.5 dB/70dB, ± 1.0 dB/10dB,
 ± 0.2 dB/1dB
LIN mode : $\pm 5\%$ of the fullscale
QP mode : ± 0.2 dB/70dB, ± 1.0 dB/40dB

Reference level indication range
: -109.9dBm to +40.0dBm
0.715 μ V to 22.4V

Reference level accuracy : ± 0.3 dB 0dBm to -50dBm (after automatic
calibration)
 ± 0.7 dB +20dBm to -70dBm (after automatic
calibration)

Dynamic range
Average noise level : -121dBm + 1.55f(GHz)dB
(Resolution bandwidth 300Hz, video bandwidth 1Hz,
input attenuator 0dB, frequency 1MHz or more)

Secondary, tertiary distortion
: ≤ -70 dB -30dBm input
(Input attenuator 0dB, frequency 10MHz or more)

Frequency response : ± 0.5 dB 100kHz to 2GHz
 ± 1.5 dB 9kHz to 2.6GHz
(LOG mode, input attenuator 10dB, 20 to 30°C)

R3261/3361
SPECTRUM ANALYZER
INSTRUCTION MANUAL

10.8 R3361K Specifications

Residual response : $\leq -100\text{dBm}$ (Input attenuator 0dB, 75 Ω terminator,
frequency 500kHz or more)

Resolution bandwidth switching accuracy : $\pm 0.3\text{dB}$ (after automatic calibration)

Video filter : 1Hz to 1MHz (switched 1 to 10 steps)

(3) Sweep Specifications

Sweep time : 30msec to 1000sec and manual sweeping

Sweep time accuracy : $\leq 3\%$

Trigger mode : FREE RUN, LINE, VIDEO, EXT, TV-V, SINGLE

(4) Input Specifications

Input impedance : Approx. 50 Ω
VSWR ≤ 1.5 ($100\text{kHz} \leq f \leq 2\text{GHz}$)
VSWR ≤ 2.0 ($9\text{kHz} \leq f \leq 2.6\text{GHz}$)
(Input attenuator $\geq 10\text{dB}$)

Input connector : N connector

Maximum input level : +25dBm (input attenuator $\geq 30\text{dB}$)
 $\pm 50\text{VDC}$ max

Input attenuator : 0 to 50dB (10dB steps)

Input attenuator switching accuracy : $\pm 1.0\text{dB}$ ($\leq 2.0\text{GHz}$)
 $\pm 1.5\text{dB}$ ($\leq 2.6\text{GHz}$)
(Input attenuator 10dB reference)

Detection mode : NORMAL, POSI, NEGA, SAMPLE

(5) Tracking generator specifications

Frequency range : 9kHz to 2.6GHz

Output level range : 0dBm to -50dBm Setting can be done in steps of
1dB.

Output level accuracy : $\pm 0.5\text{dB}$ (30MHz, -10dBm, +20 to +30°C)

Output level flatness : $\pm 0.7\text{dB}$ (100kHz to 1.0GHz)
 $\pm 1.5\text{dB}$ (9kHz to 2.6GHz)
(-10dBm output)

R3261/3361
SPECTRUM ANALYZER
INSTRUCTION MANUAL

10.8 R3361K Specifications

Output level switching accuracy	: $\pm 1.0\text{dB}$ (100kHz to 1.0GHz) $\pm 2.0\text{dB}$ (9kHz to 2.6GHz) (-10dBm reference)
Output spuriousness	: Harmonics spurious level $\leq -20\text{dB}$ Non-harmonics spurious level $\leq -30\text{dB}$ (Output level 0dBm)
TG leakage	: $\leq -110\text{dBm}$
Output impedance	: Approx. 50Ω
Output VSWR	: ≤ 1.5 (100kHz to 2.0GHz) ≤ 2.0 (9kHz to 2.6GHz) (At $\leq -10\text{dBm}$ output)
Minimum resolution bandwidth	: 300Hz
Output connector	: N-connector
(6) Output specifications	
External memory function	: IC memory card
Video output	: Approx. 1Vp-p, approx 75Ω , composite
Sound monitor output	: The AM and FM sound can be monitored with an approximately 8Ω earphone.
Power supply for probes	: $\pm 15\text{V}$, 4-pin connector
Recorder output	: X axis approx. -5 to +5V, output impedance approx. $10\text{k}\Omega$ Y axis approx. 0 to +4V, output impedance approx. 220Ω
GPIB data output/ Remote control	: The built-in GPIB interface allows data output and remote control.
Direct plot	: Also, the built-in GPIB interface allows an output of on-screen data to the R9833 plotter to have a hardcopy.
Printer output	: The built-in GPIB interface allows HP2225AJ to output a hardcopy of on-screen data.

R3261/3361
SPECTRUM ANALYZER
INSTRUCTION MANUAL

10.8 R3361K Specifications

(7) Indication specifications

Indicated items : Waveforms, setting conditions, grid, label

CRT display unit : 5.5 inch

Trace : Two screens of A and B

WRITE : Signal response from the analyzer is indicated at every sweeping.

VIEW : The WRITE waveform contained in the memory, or other contents in the memory are displayed.

MAX HOLD : Indication of the maximum signal level of repeat sweeping.

AVG : Indication of the average of repeat sweeping

(8) Other functions

Occupied bandwidth measurement/Adjacent channel leakage power measurement

Multi-marker measurement

(9) General specifications

Using ambient condition : 0 to 50°C
85%RH or less

Storage temperature range : -20 to 60°C

Power supply : Line voltage range 90 to 132VAC or 198 to 250VAC
is automatically selected internally.
48 to 66Hz

Power consumption : 220VA or less

Dimensions : Approx. 330(W) x 177(H) x 450(D) mm

Mass : Approx. 17kg

R3261/3361
SPECTRUM ANALYZER
INSTRUCTION MANUAL

10.9 Options and Accessories

10.9 Options and Accessories

Option

- Option 80
 - RS-232 interface
 - Gated sweep function

- Option 81
 - Controller function (including an editor function of a parallel I/O and a serial I/O, Standard function for R3361NK/R3361K)
 - Gated sweep function

Separate accessory

- R3551 EMI preselector
- R16056A Transit case
- R16211A Carrying case
- A02804 Front cover
- A09505 Memory card (32k byte, 5 pieces)
- A09506 Memory card (128k byte, 5 pieces)
- A02034 Panel mount kits
- A02255 Rack mount kits (JIS)
- A02455 Rack mount kits (EIA)

R3261/3361
SPECTRUM ANALYZER
INSTRUCTION MANUAL

11. Operation Description

11. OPERATION DESCRIPTION

R3261/3361
SPECTRUM ANALYZER
INSTRUCTION MANUAL

11.1 Description of Operations

11.1 Description of Operations

See the block diagram in Figure 11 - 1.

R3261D/3361D consists of the following blocks: 'RF', which converts signals of a frequency from 9kHz to 3.6GHz (9kHz to 2.6GHz in R3261C/3361C) into IF signals with a frequency of 3.58MHz; 'IF-A/D', which determines the resolution bandwidth and converts amplitude signals from analog to digital; and the controller that controls the former two.

Adding to the above, R3361C/CN/D has 'TG', which outputs frequency synchronized to the input frequency.

(1) RF

The input signal is input to the first mixer via the input attenuator (0dB to 50dB, 10dB steps) in the RF.

The signal input in the first mixer is mixed with the synthesized signal generated by the YIG synchronized oscillator of 4GHz to 7.6GHz, and is converted to the IF signal of 4.06642GHz. The converted signal goes through the 4GHz bandpass filter to remove the undesirable signal added in the first mixer, before going to the second mixer.

The 4GHz signal input in the second mixer is then mixed with phase locked oscillator signal of 3.84GHz, converted into the secondary IF signal of 226.42MHz, and then input to the third mixer.

In the third mixer the signal is mixed with the 200MHz signal by the frequency reference source to be converted into tertiary IF signal.

Then the signal is input to the fourth mixer, mixed with the 30MHz signal from the frequency reference source, and the 3.58MHz final IF signals are output. The final IF signal of 3.58MHz is input to the IF, the next stage, where the resolution bandwidth will be determined.

(2) IF-A/D

The IF comprises the L/C filter that determines the resolution bandwidth in the range from 1MHz to 10kHz, the crystal filter for the range from 3kHz to 30Hz, and the step amplifier that determines the reference level.

Resolution bandwidth and reference level of the IF signal are determined as it passes through the IF. The signal is then input in the LOG amplifier in the display block.

R3261/3361
SPECTRUM ANALYZER
INSTRUCTION MANUAL

11.1 Description of Operations

The signal input in the LOG amplifier is compressed, detected and input to the A/D converter. The digital signal converted from analog is transferred to the controller.

(3) Controller

The controller sends necessary data from the microprocessor to RF, IF-A/D, and TG (for R3361C/CN/D only).

(4) TG (For R3361C/CN/D only)

TG in R3361C/CN/D mixes the first IF frequency of 4.066GHz and synthesized signal of 4GHz to 7.6GHz to output the signal tracing the input frequency.

R3261/3361
SPECTRUM ANALYZER
INSTRUCTION MANUAL

11.2 Block Diagram

11.2 Block Diagram

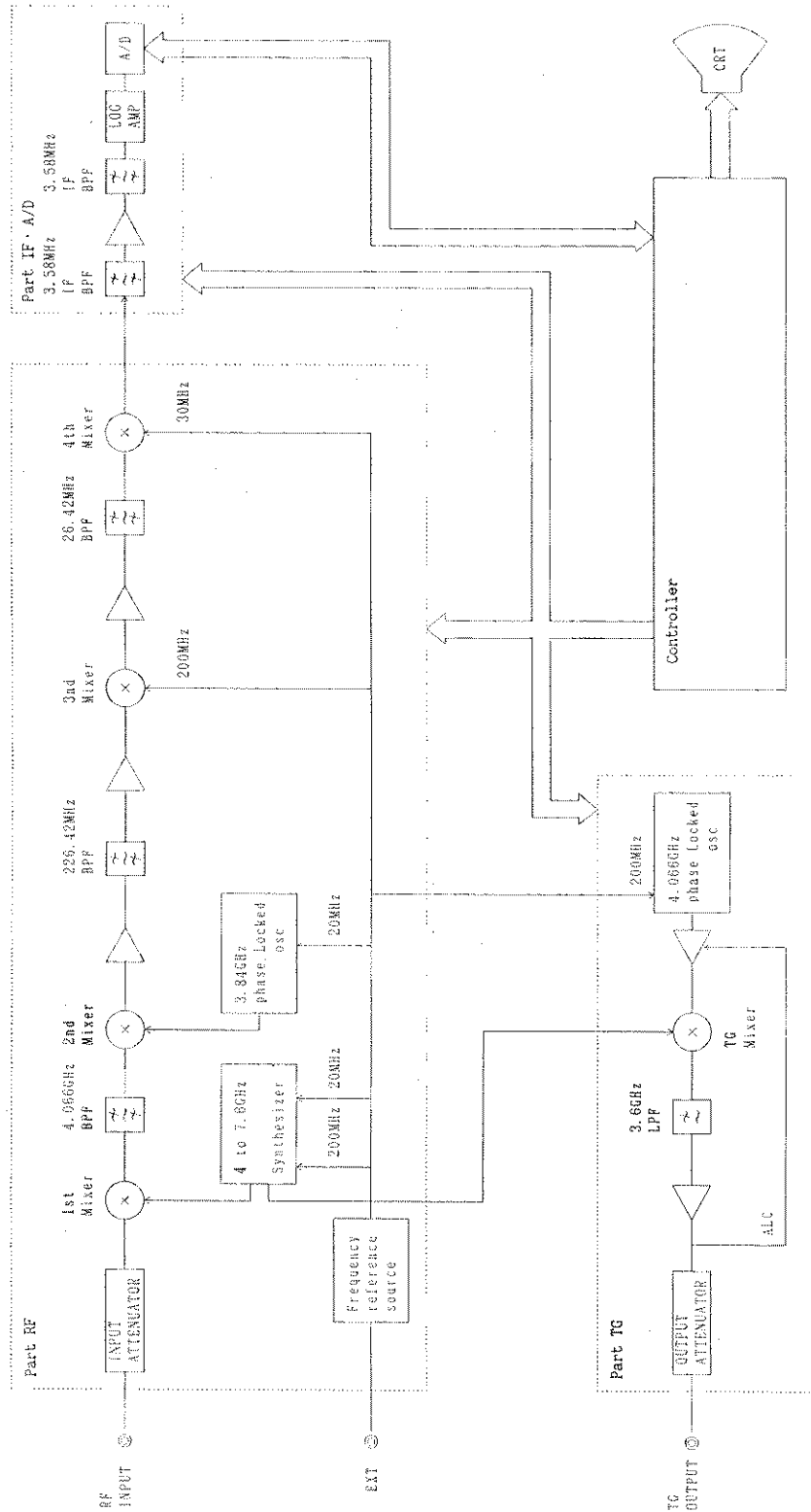

Note : The R3261 series does not contain TG.

Figure 11 - 1 R3261/3361 Block Diagram

R3261/3361
SPECTRUM ANALYZER
INSTRUCTION MANUAL

APPENDIX

APPENDIX

R3261/3361
SPECTRUM ANALYZER
INSTRUCTION MANUAL

A.1 List of Softkey Menus Corresponding to Panel Keys

A.1 List of Softkey Menus for Panel Keys

Softkey menus to be consecutively displayed by the corresponding panel key are shown in the diagrams on the following pages, in the order below:

Item number	Panel key	Remarks
(1) (2) (3) (4) (5) (6) (7)	CENTER FREQ key FREQ SPAN key START key STOP key COUPLE key REF LEVEL key MENU key	FUNCTION section
(8)	Key A or key B	TRACE section
(9)	GPIB ADRS (SHIFT + LCL) key	GPIB section
(10) (11) (12)	SAVE (SHIFT + RECALL) key RECALL key DEFINE key (SHIFT + USER) key	
(13) (14) (15) (16)	ON key PEAK key MKR key MULTI MKR (SHIFT + ON) key	MARKER section
(17) (18) (19) (20) (21) (22) (23) (24)	CAL (SHIFT + 7) key PLOT (SHIFT + 8) key LABEL (SHIFT + 9) key MEM CD (SHIFT + 4) key TG key EMC (SHIFT + 1) key M.W (SHIFT + 0) key FUNCTION (SHIFT + 6) key	DATA section

R3261/3361
SPECTRUM ANALYZER
INSTRUCTION MANUAL

A.1 List of Softkey Menus Corresponding to Panel Keys

(1) Center Frequency

CENTER FREQ	CF STEP SIZE
	CF STEP AUTO
	FREQ OFS ON/OFF
	+/-

(2) Frequency Span

FREQ SPAN	LINEAR SPAN
	FULL SPAN
	LOG SPAN
	ZERO SPAN

(3) Start Frequency

START	FREQ OFS ON/OFF
	+/-

R3261/3361
SPECTRUM ANALYZER
INSTRUCTION MANUAL

A.1 List of Softkey Menus Corresponding to Panel Keys

(4) Stop Frequency

STOP	FREQ OPS
	ON/OFF
	+/-

(5) Couple

COUPLE	RBW
	VBM
	SWP
	ATT
	AUTO
	ALL AUTO

R3261/3361
SPECTRUM ANALYZER
INSTRUCTION MANUAL

A.1 List of Softkey Menus Corresponding to Panel Keys

(6) Reference Level

REF LEVEL	X dB/div	
	8/12div	
	LINEAR	× 1
		× 1.6
		× 4
		× 8
	DISPLAY UNIT	dBm
		dBmV
		dB μ V
		dB μ Vemf
		dBpW
	REF OFS ON/OFF	

R3261/3361
 SPECTRUM ANALYZER
 INSTRUCTION MANUAL

A.1 List of Softkey Menus Corresponding to Panel Keys

(8) A or B

A	or	B	WRITE A (B)	
			VIEW A (B)	
			BLANK A (B)	
			MAX HOLD A (B)	
			AVG A (B)	AVG A (B) ST/SP
				A (B) PAUSE /CONT
				A (B) 1 TIME /CONT
			NORM A (B)	NORM A (B) ON/OFF
				CORRECT SAVE
				DSP LINE ON/OFF
				INSTANT NORM A (B)

(9) GPIB Address

SHIFT
LCL

No softkey menu provided.

R3261/3361
SPECTRUM ANALYZER
INSTRUCTION MANUAL

A.1 List of Softkey Menus Corresponding to Panel Keys

(10) Save

SHIFT	
RECALL	SAVE EXECUTE SAVE TITLE WRITE PROTECT TRACE A/B

(11) Recall

RECALL	RECALL EXECUTE FAST/ NORMAL
--------	--

(12) User Define

SHIFT	
USER	GROUP ACTIVE MEMBER ACTIVE ENTER INTIAL MEMBER ALL INITIAL RETURN

R3261/3361
SPECTRUM ANALYZER
INSTRUCTION MANUAL

A.1 List of Softkey Menus Corresponding to Panel Keys

(14) Peak Search

PEAK	NEXT PK	
	NEXT PK RIGHT	
	NEXT PK LEFT	
	NEXT PK MAX/MIN	
	MIN	
	NEXT MENU	NEXT MIN
		PK CONT ON/OFF
		PK RANGE UP/FULL
		△ X/△ Y
		PREV MENU

(15) Marker →

MKR→	MKR → CF	
	MKR → REF	
	MKR △ SPAN	
	MKR → CF STEP	
	MKR △ CF STEP	
	NEXT MENU	MKR→ MK STEP
		MKR △→ MK STEP
		MK STEP
		MK STEP
		SIZE
		MK STEP AUTO
		PREV MENU

R3261/3361
SPECTRUM ANALYZER
INSTRUCTION MANUAL

A.1 List of Softkey Menus Corresponding to Panel Keys

(17) Calibration

SHIFT		
7	CAL ALL	
	TOTAL GAIN	
	EACH ITEM	INPUT ATT
		IF STEP
		AMPTD
		RBW
		SWITCH
		LOG
		LINEAR
		AMPTD
		MAG
		TG
		TRACKING
		(R3361C/CN/D only)
	CAL SIG ON/OFF	
	FRQ CORR ON/OFF	
	CAL CORR ON/OFF	

R3261/3361
SPECTRUM ANALYZER
INSTRUCTION MANUAL

A.1 List of Softkey Menus Corresponding to Panel Keys

(18) Plot

SHIFT			
8	PLOTTER TYPE		
	PLOT MODE		
	PLOT FORM	PAPER SIZE	
		PLOT DIVISION	
		LOCATION	
		PEN	
		PLOT AUTO/MNL	
		RETURN	
	TALK/ ADRESBLE		
	PLOT CANCEL		
	PLOT EXECUTE		

(19) Label

SHIFT	
9	CAPS LOCK ON
	CAPS LOCK OFF
	MARK
	LABEL CLEAR
	RETURN

R3261/3361
SPECTRUM ANALYZER
INSTRUCTION MANUAL

A.1 List of Softkey Menus Corresponding to Panel Keys

(20) Memory Card

SHIFT	
4	VOLUME INIT
	MENU LOAD
	MENU STORE

(21) Tracking Generator

TG	LEVEL
	FREQ CAL AUTO
	FREQ CAL MANUAL
	OFF

R3261/3361
 SPECTRUM ANALYZER
 INSTRUCTION MANUAL

A.1 List of Softkey Menus Corresponding to Panel Keys

(22) EMC

SHIFT	FIELD STR	ANTENNA	DIPOLE			
1			LOG PERD			
			TR17203			
			ANTENNA OFF			
		ANTENNA CORR	CORRECT ON/OFF			
				NEXT MENU	INPUT/MODIFY	Note1
					TABLE	Note2
					INIT	Note2
					TABLE	Note2
					DELETE	
					FREQ/LEVEL	
				PREV MENU		

2

Note: "Note2" is displayed only when "Note1" is set in the MODIFY.

R3261/3361
 SPECTRUM ANALYZER
 INSTRUCTION MANUAL

A.1 List of Softkey Menus Corresponding to Panel Keys

2

QP	QP ON/OFF		
	QP BW AUTO		
	QP BW 200 Hz		
	QP BW 9 kHz		
	QP BW 120 kHz		
LIMIT LINE A	LIMIT A ON/OFF		
	NEXT MENU	INPUT/ MODIFY	Note1
		TABLE INIT	Note2
		TABLE DELETE	Note2
		FREQ/ LEVEL	
		PREV MENU	
LIMIT A ON/OFF			

Note: "Note2" is displayed only when "Note1" is set in the MODIFY.

R3261/3361
 SPECTRUM ANALYZER
 INSTRUCTION MANUAL

A.1 List of Softkey Menus Corresponding to Panel Keys

(23) MEAS WINDOW

SHIFT					
0	WINDOW OFF				
	NEXT MENU	LOCATE X			
		LOCATE Y			
		Δ X			
		Δ Y			
		ABS DATA	WINDOW START		
			WINDOW STOP		
			WINDOW UPPER		
			WINDOW LOWER		
			RETURN		
		PREV MENU			

R3261/3361
 SPECTRUM ANALYZER
 INSTRUCTION MANUAL

A.1 List of Softkey Menus Corresponding to Panel Keys

(24) FUNCTION

SHIFT			
6	SISTEM CONTRL OBW	Note 1	
	ADJ		
	ADJ GRAPH		
Note 2	SERIAL I/O	BAUD	
		DATA LENGTH	
		STOP	
		BIT PARITY	
		FLOW CONTROL	
		NEXT MENU	INTERVAL
			OPEN
			CLOSE
			PREV MENU
	PRINTER	NORMAL HALF	
		TALK/ ADRS 01	
		PRINT CANCEL	
		PRINT EXECUTE	

Note1: Display for only devices equipped with Option 81.
 Note2: Display for only devices equipped with Option 80.

A.2 Glossary

IF Bandwidth

A spectrum analyzer employs bandpass filters (BPF) to differentiate various frequency components of the input signal. IF bandwidth is the range of frequencies centered about the intermediate frequency limited by the -3dB amplitude points. (See Figure A-1 (a).) An optimum BPF characteristics must be selected according to the sweep width and sweep speed. The R3261/3361 spectrum analyzers optimize the BPF characteristics based on the sweep width. In general, the narrower the IF bandwidth is set, the finer is the selectivity (resolution) of the spectrum. Hence, sometimes the most narrow IF bandwidth possible is used as a measure of the resolution of the spectrum analyzer. (Figure A-1 (b).)

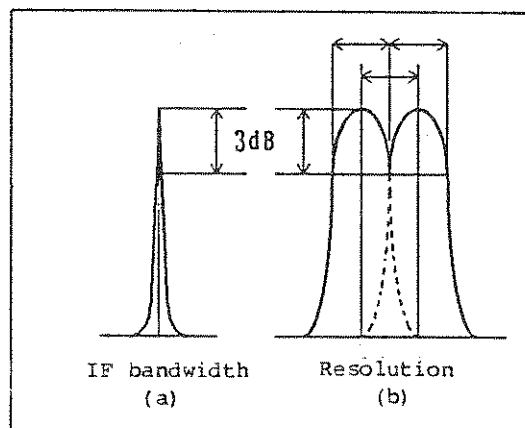

Figure A - 1 IF Bandwidth

Gain Compression

If an input signal is greater than a certain value, the CRT display cannot indicate the correct value. This causes compression of the effective indication as the input signal is increased. This process is termed the gain compression. Generally, the value of the level range within which one decibel of gain compression takes place is used to indicate the input signal range linearity.

Input Sensitivity

Input sensitivity is the minimum input signal that the spectrum analyzer is required to detect. Sensitivity is related to the noise generated by the spectrum analyzer itself, and depends on the IF bandwidth to be used. Generally, input sensitivity is taken as the average noise level at a minimum IF bandwidth of the spectrum analyzer.

Maximum Input Level

Maximum input level is the maximum level allowed in the input circuit of the spectrum analyzer. The level can be varied by an input attenuator.

Residual FM

Residual FM is the short-term jitter or undesired FM deviation of local oscillators. Residual FM in a spectrum analyzer is expressed as spectrum space of the jitter per unit time, and its symbol is p-p. This limits measurement resolution of residual FM contained in a signal to be tested.

Residual Response

Residual response is the level of spurious signal generated in the spectrum analyzer, referenced to the input level. Residual response is caused by a certain signal leakage, for instance, the output of local oscillators in the spectrum analyzer. It may disturb analysis of an input signal of very low level.

Quasi Peak Value Measurement

Interference noise in receiving radio waves often appears as an impulse. Such interference noise can be objectively represented as a function of the peak value of the pulse. The quasi peak value is measured under some specified conditions, including the measurement bandwidth and detection time constant. The Japanese JRTC and international CISPR are the two prevailing standards of this quasi peak value measurement.

Frequency Response

Generally, the term frequency response is used as a characteristic showing relative amplitudes at different frequencies (that is, the frequency characteristic). The frequency response of the spectrum analyzer is taken as the frequency characteristics (flatness) at different input frequencies in input attenuator, mixer and other units. It is expressed as \pm dB.

Zero Span

Zero span is one of the modes of operation of the R3261/3361 spectrum analyzer, where sweep over a certain frequency span is not carried out. Instead, sweep is performed on an arbitrary specified frequency, and the y coordinate represents the time parameter.

Spurious Signals

Spurious signals are undesired signals. They may be classified into the following three categories by their nature:

Harmonics: Harmonics are generated by a part of the spectrum analyzer (generally by the mixer) when an ideal non-distortion signal is applied to the analyzer. The level of the harmonics represents the harmonics distortion measurement capacity of the analyzer.

Neighborhood signals:

Small spurious signals generated at near frequencies to a single pure signal applied to the spectrum analyzer.

Non-harmonic spurious signals:

Spurious signals of a specified frequency generated by the spectrum analyzer itself. Also termed residual response.

Noise Sidebands

The noise sidebands are usually regarded as a measure of oscillation purity generated by oscillating equipment. In the spectrum analyzer, local oscillators and phase lock loop generate noise near the spectrum displayed on the CRT screen, reducing the analysis precision of the analyzer. The noise sidebands means the range of analyzable bandwidth of external signal noise, apart from the specified intrinsic side bands. Noise side band characteristic of a spectrum analyzer is defined as follows:

[Example]

In 1 kHz of IF bandwidth, -70dB apart from the carrier frequency by 20kHz. Otherwise, the noise side band characteristic may be expressed indirectly by the noise level, generally represented by the energy present within 1Hz of the bandwidth. (See Figure A-2 (b).)

In the latter form, a signal of -70dB within 1kHz of the bandwidth must have lower energy in 1Hz of bandwidth, by $10 \log 1\text{Hz}/1\text{kHz}$ [dB] = approx. 30dB. Hence, in 1kHz of IF bandwidth, -100dB/Hz apart from the carrier frequency.

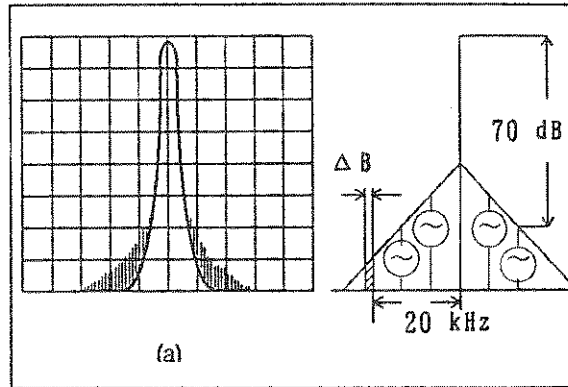

Figure A - 2 Noise Side Bands

Bandwidth Selectivity

Graphically, bandpass filter shows the attenuation characteristic of normal Gaussian distribution, instead of the rectangular shape. Therefore, a small signal may be concealed under the skirt of a nearby large signal. (See Figure A-3.) Because of this, bandwidth at the specified attenuation point needs to be specified. The ratio of 15:1 (60dB to 3dB) is used as the bandwidth selectivity for the R3261/3361 spectrum analyzer.

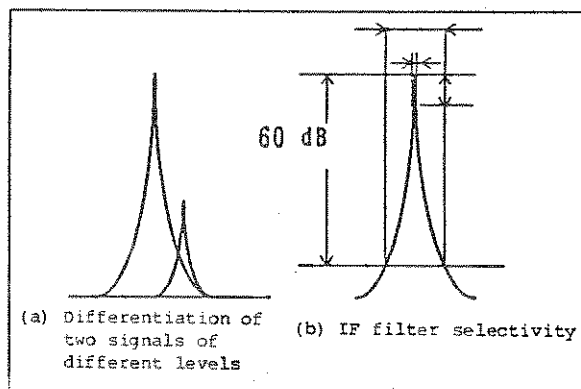

Figure A - 3 Bandwidth Selectivity

Bandwidth Accuracy

Bandwidth accuracy is the factor representing the IF filter bandwidth accuracy, expressed as the deviation from the nominal value of the -3dB amplitude points. This factor little affects level measurement of normal continuous signals, but must be taken into consideration in noise signal level measurement.

Bandwidth Switching Accuracy

For spectrum analysis of signals, a choice of multiple IF filters instead of a single one is provided for optimum resolution of a given scan width. Bandwidth switching accuracy is the maximum error in measurement that may result from analysis of an identical signal, caused by switching the IF filters and thus varying the loss.

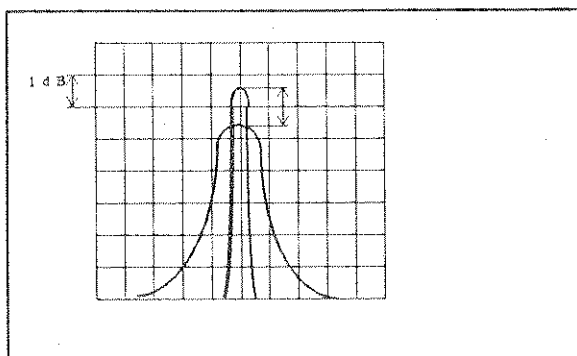

Figure A - 4 Bandwidth Switching Error

Reference Level Display Accuracy

Reference level display accuracy is the absolute accuracy of the indication expressed in dBm, or dBu, of the reference level, which is set at the uppermost scale on the CRT screen. The reference level is used to measure the absolute level of an input signal in decibels. The reference level setting can be done by using the IF GAIN key and the input attenuator.

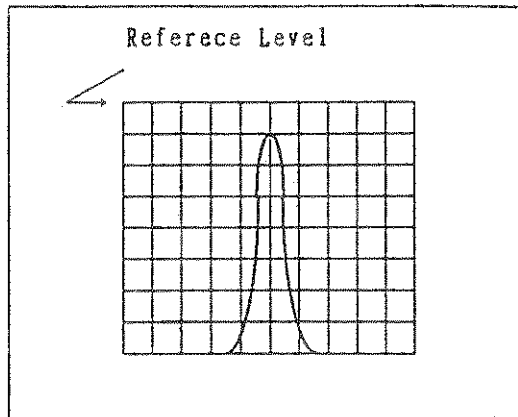

Figure A - 5 Reference Level

Voltage Standing Wave Ratio (VSWR)

Voltage standing wave ratio is the ratio of voltage at a loop (maximum) to the value at a (minimum) node in a stationary wave system, which is formed by progressive and reflected waves generated by the spectrum analyzer connected to an ideal nominal impedance source. This factor can otherwise be expressed as reflection coefficient or reflection loss.

See Figure A-6. If signal E_0 sent from the transmitting party should have been transferred to the receiving party (spectrum analyzer inlet) without any loss caused by mismatching of impedance, etc., the received signal E_1 would be equal to E_0 . Otherwise, if part of the signal is reflected and returned to the receiving party because of mismatching, the ratio of the reflected wave to the progressive wave is given by the formula

$$m = E_R/E_0$$

where m is the reflection coefficient and E_R and E_0 are the voltage levels of reflected and progressive waves, respectively. The ratio (in decibels) of the reflected wave E_R to the progressive wave E_0 is the reflection loss.

$$\begin{aligned} \text{Reflection loss} &= 20 \log E_R/E_0 \text{ [dB] VSWR} \\ &= (E_0 + E_R)/(E_0 - E_R) \end{aligned}$$

VSWR can be expressed related to reflection coefficient;

$$\text{VSWR} = (1 + |m|)/(1 - |m|)$$

where VSWR vary from 1 to infinite. VSWR approaches 1 as the impedance is equalized.

R3261/3361
 SPECTRUM ANALYZER
 INSTRUCTION MANUAL

A.2 Glossary

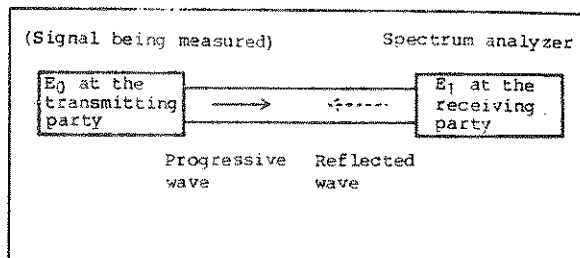

Figure A - 6 VSWR

Spurious Response

Spurious response is the harmonic distortion generated in the input mixer as the signal level is increased. The range free from spurious response varies depending on the fundamental wave input level. In the example shown in Figure A-7, -70dB display level corresponds to the input level of -30dBm. If a signal of excess level is input, the input attenuator decreases the signal to be applied to the mixer to an adequate level.

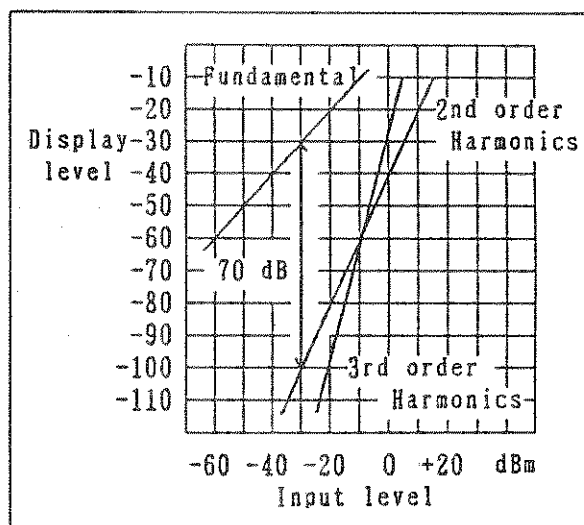

Figure A - 7 Spurious Response

YIG-tuned Oscillator

As first reported by Griffiths in 1946, ferrites of garnet group represented by Yttrium Iron Garnet (YIG) mono crystal show electron spin resonance at microwave frequencies. The resonance frequencies are linearly proportional to the direct magnetic field applied. This characteristic holds through a wide frequency band. With these properties, precise tuning in wide frequency band is accomplished by varying the exciting current of the electromagnet producing the magnetic field. This type of oscillator is widely employed as the local sweep generator in spectrum analyzers or automatic microwave frequency counters made by ADVANTEST.

R3261/3361
SPECTRUM ANALYZER
INSTRUCTION MANUAL

A.3 Level Conversion Table

A.3 Level Conversion Table

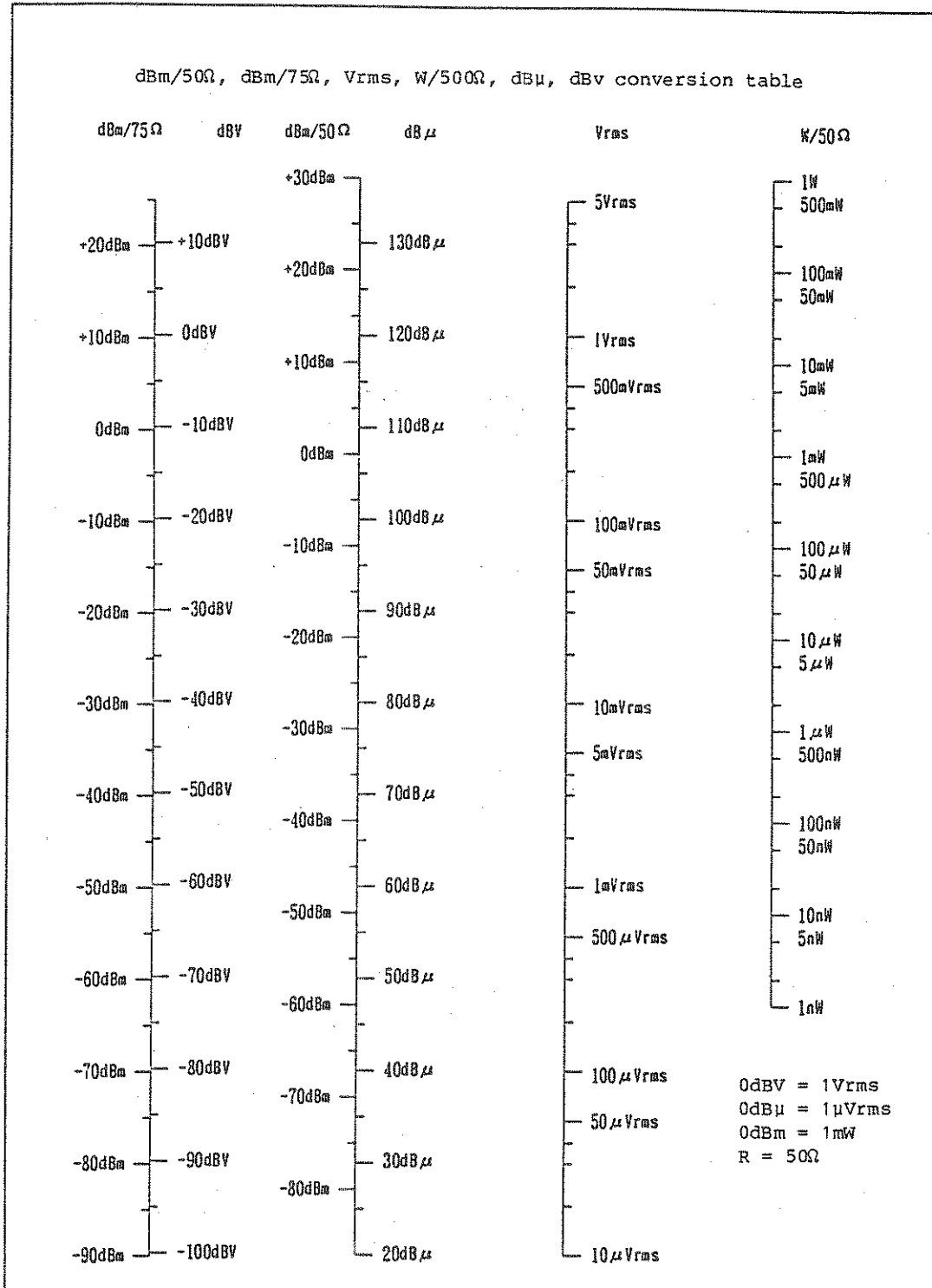

Figure A - 8 Level Conversion Table

R3261/3361
SPECTRUM ANALYZER
INSTRUCTION MANUAL

ALPHABETICAL INDEX

ALPHABETICAL INDEX

[2]	[C]
2V/nGHz output terminal 2 - 5	CENTER FREQUENCY key 2 - 3
[A]	CF STEP SIZE 4 - 4
A-key 2 - 3	COUPLE key 2 - 3
AC couple 3 - 2	CRT display 2 - 2
ADJ 4 - 122	Calibration Function 4 - 86
AM Signal 7 - 5	Carrier Frequency () 6 - 15
ASCII format 8 - 29	Cautions on Memory Card 4 - 98
ATT 4 - 16	Center Frequency 4 - 3
AUTO 4 - 17	Changing the Active Marker ... 4 - 62
AVERAGING Mode 4 - 34	Channel Selection Command ... 9 - 15
Accessories 1 - 3	Channel Setup Command 9 - 14
Active marker 4 - 53	Channel Setup Function 9 - 6
Active trace 4 - 53	Character 4 - 93
Adjust Channel Leakage Power	Check 8 - 2
Measurement 4 - 122	Checking Accessories 1 - 3
Antenna Correction Function . 4 - 111	Cleaning 1 - 5
Arrangement of PIO 36 pin	Connector for AC power 2 - 6
connector terminal 4 - 141	Constant loss 5 - 9
Arrangement of Pin Connector. 4 - 140	Controller 7 - 2
Arrangement of SIO 25 pin	Controller output terminal
D-sub connector terminal .. 4 - 140	(Optional) 2 - 5
attenuation 5 - 11	Cooling fan 2 - 6
Audio Monitor 4 - 29	Counter Mode 4 - 40
Audio Monitor Function 9 - 4	Couple 4 - 13
Auto Function 9 - 17	[D]
Average Power (Pave) (dBm) .. 6 - 15	DATA Section 2 - 4
[B]	dB/div 4 - 19
B-key 2 - 3	DEFINE key 2 - 3
BLANK Mode 4 - 33	DISPLAY UNIT 4 - 21
Back space key 2 - 4	DRIVE lamp 2 - 2
Bandwidth Accuracy A - 23	Data Input Function 7 - 19
Bandwidth Selectivity A - 22	Data knob 2 - 4
Bandwidth Switching Accuracy. A - 23	Delimiters 7 - 21
Basic Operations 3 - 7	delta X 4 - 47
Before Turning This Analyzer	delta Y 4 - 47
on 1 - 6	delta markes 4 - 39
Binary format 8 - 29	Description of Operations ... 11 - 2
	Detector 4 - 24
	Diagnosis 8 - 2
	Display Line 4 - 26
	Display Line 5 - 4
	Displaying the List 4 - 81
	Dynamic Range 5 - 13

R3261/3361
SPECTRUM ANALYZER
INSTRUCTION MANUAL

ALPHABETICAL INDEX

[E]	[I]		
EJECT button	2 - 2	IF Bandwidth	A - 19
EMC Function	4 - 111	IF monitor output terminal (option)	2 - 5
EXAMPLES OF MEASUREMENTS	6 - 1	INPUT connector	2 - 2
Environmental Conditions	1 - 4	INTENSITY control	2 - 2
Erasing the Marker	4 - 60	Indication of installed options	2 - 6
External trigger	2 - 5	Initial Setting (Parameter) .	3 - 4
		Initialization	3 - 4
[F]		Initializing the Memory Card.	4 - 100
FM Wave	6 - 9	Input	3 - 3
FREQ CAL AUTO	4 - 110	Input Attenuator	4 - 16
FREQ OFFSET	4 - 11	Input Format (Listener)	7 - 22
FREQUENCY SPAN key	2 - 3	Input Sensitivity	A - 19
FUNCTION Section	2 - 3	Input/output selector switch.	2 - 5
Frequency Offset	4 - 11	Inputting Signal	3 - 2
Frequency Response	A - 20	Inserting and Removing Memory Card	4 - 99
Frequency Span	4 - 6	insertion loss	5 - 9
Front Panel	2 - 2		
Fuse	1 - 7		
[G]	[L]		
GO or NG Judgment Function ..	4 - 107	LCL key	2 - 3
GPIB	7 - 1	LINEAR Mode	4 - 20
GPIB Bus Line Configuration .	7 - 4	Label Function	4 - 93
GPIB Connector Pin Configuration	7 - 5	Level Conversion Table	A - 27*
GPIB Interface Functions	7 - 7	Life of Back-up Battery	4 - 97
GPIB Remote Programming	4 - 69	Limit Line Function	4 - 116
GPIB Remote Programming	4 - 126	Limit Voltage Value	5 - 15
GPIB Section	2 - 3	List of Softkey Menu	A - 6
GPIB address setting	7 - 21	List of Softkey Menu A or B .	A - 7
GPIB code	4 - 69	List of Softkey Menu Calibration	A - 12
GPIB code	7 - 8	List of Softkey Menu Center Frequency	A - 3
GPIB command	4 - 70, 9 - 14	List of Softkey Menu Couple .	A - 4
GPIB connector	2 - 5	List of Softkey Menu EMC	A - 15
Gain Compression	A - 19	List of Softkey Menu Frequency Span	A - 3
Gated Sweep Function	4 - 136	List of Softkey Menu GPIB address	A - 7
Gated sweep control terminal.	2 - 5	List of Softkey Menu Label ..	A - 13
Glossary	A - 19	List of Softkey Menu MEAS WINDOW	A - 17
Graticule	4 - 30	List of Softkey Menu MKR ..	A - 10
Ground terminal	2 - 6	List of Softkey Menu Marker on	A - 9
		List of Softkey Menu Memory Card	A - 14
[H]			
High-speed/Normal RECALL Mode	4 - 82		

List of Softkey Menu		[M]	
Multi-marker	A - 11	MARKER Section	2 - 4
List of Softkey Menu		MARKER Section Functions	4 - 38
of the CH Key	9 - 13	MAX HOLD Mode	4 - 34
List of Softkey Menu ON	A - 9	MENU key	2 - 3
List of Softkey Menu OPTION .	A - 18	MIN SEARCH	4 - 46
List of Softkey Menu Plot ...	A - 13	MKR key	2 - 4
List of Softkey Menu Recall .	A - 8	Marker	4 - 38
List of Softkey Menu		Marker	4 - 53
Reference Level	A - 5	Marker Step Size	4 - 51
List of Softkey Menu SHIFT		Marker	4 - 50
+ ON	A - 11	Maximum Input Level	A - 20
List of Softkey Menu SHIFT		Maximum input level	3 - 2
+ 7	A - 12	Measuring Function	4 - 106
List of Softkey Menu SHIFT		Measuring Window	4 - 102
+ 8	A - 13	Measuring the Deviation	6 - 3
List of Softkey Menu SHIFT		Memory Card Function	4 - 95
+ 9	A - 13	Memory card insertion slot ..	2 - 2
List of Softkey Menu SHIFT		Menu	4 - 23
+ 4	A - 14	Moving the Multi-marker	4 - 61
List of Softkey Menu SHIFT		Multi-marker	4 - 53
+ 1	A - 15	Multi-marker	4 - 53
List of Softkey Menu SHIFT		Multi-marker List	4 - 63
+ 0	A - 17		
List of Softkey Menu SHIFT			
+ 6	A - 18		
List of Softkey Menu SHIFT		[N]	
+ LCL	A - 7	NEXT MIN	4 - 46
List of Softkey Menu SHIFT		NEXT PEAK LEFT	4 - 45
+ RECALL	A - 8	NEXT PEAK MAX & MIN	4 - 45
List of Softkey Menu SHIFT		NEXT PEAK RIGHT	4 - 45
+ USER	A - 8	NEXT PEAK SEARCH	4 - 44
List of Softkey Menu Save ...	A - 8	NORMALIZE Mode	4 - 35
List of Softkey Menu Start		Names of Parts of Memory	
Frequency	A - 3	Card	4 - 96
List of Softkey Menu Stop		Noise Level Measurement	6 - 16
Frequency	A - 4	Noise Sidebands	A - 21
List of Softkey Menu TG	A - 14	Noise/Hz Mode	4 - 42
List of Softkey Menu		Normal Marker Frequency	4 - 38
Tracking Generator	A - 14	Normal marker	4 - 53
List of Softkey Menu User			
Define	A - 8		
List of Softkey Menus	A - 2		
Listener	7 - 2		
Low Output Level	5 - 14		
		[O]	
		OBW	4 - 120
		OFF key	2 - 4
		OFFSET FREQ	4 - 5
		ON key	2 - 4
		Occupied Bandwidth	
		Measurement	4 - 120
		Output Format (Talker)	7 - 25
		Overview	1 - 2

R3261/3361
SPECTRUM ANALYZER
INSTRUCTION MANUAL

ALPHABETICAL INDEX

[P]			
PARALLEL I/O (Option)	2 - 5	Remote Programming	7 - 1
PEAK SEARCH	4 - 44	Replacing the Battery	4 - 98
PEAK key	2 - 4	Residual FM	A - 20
PHONE jack	2 - 2	Residual Response	A - 20
PK CONT	4 - 47	Resolution Band Width	4 - 13
POWER switch	2 - 2	ripple	5 - 11
PRESENT key	2 - 3		
PRESET key	3 - 4	[S]	
PROBE POWER	2 - 2	SAVE key	2 - 3
Pass bandwidth (3dB)	5 - 10	SERIAL I/O (Option)	2 - 5
Peak Power (P_{peak})	6 - 15	SHIFT key	2 - 3
Peak Search	4 - 44	SPECIFICATIONS	10 - 1
Plot Output Function	4 - 89	SRQ	7 - 31
Plotter Output Conditions ...	4 - 89	SSB PHASE NOISE	
Plotter Pens	4 - 92	characteristics	4 - 31
Plotting the Marker List	4 - 64	START key	2 - 3
Power Cable	1 - 8	STOP key	2 - 3
Power Supply Conditions	1 - 6	SWEEP lamp	2 - 3
Power-On	3 - 3	SWP	4 - 15
Programming Examples	4 - 126	Save Function	4 - 77
Programming examples	7 - 23	Saving into Memory Card	4 - 78
Pulse Modulation Wave	6 - 14	Service Request	7 - 31
Pulse Width ()	6 - 15	Signal Track Mode	4 - 41
		Single marker	4 - 53
		Softkey menu display section.	2 - 2
		Softkeys	2 - 2
		Sound	4 - 29
		Span Modes	4 - 8
		Specification of Memory Card.	4 - 95
		Spurious Response	A - 25
		Spurious Signals	A - 20
		Start Frequency	4 - 9
		Status Bytes	7 - 31
		Step key	2 - 4
		Stop Frequencies	4 - 10
		Stop Frequency	4 - 10
		Storage	1 - 5
		Storing Softkey Menu	4 - 101
		Sweep Mode	4 - 25
		Sweep Time	4 - 15
[Q]			
QP Measurement	4 - 113		
Quasi Peak Value Measurement.	A - 20		
[R]			
R3261/3361 Block Diagram	11 - 4		
R3361NK/3361K	9 - 1		
RBW	4 - 13		
RECALL key	2 - 3		
REF OFFSET	4 - 21		
REFERENCE LEVEL key	2 - 3		
REMOTE lamp	2 - 3		
RS-232 Port Setting	4 - 137		
Rear Panel	2 - 5		
Recall Function	4 - 80		
Recalling Softkey Menu	4 - 101		
Reference Level	4 - 18		
Reference Level Display			
Accuracy	A - 23		
Reference frequency signal			
input/output terminal	2 - 5		
Registering the			
Multi-marker	4 - 59		

R3261/3361
SPECTRUM ANALYZER
INSTRUCTION MANUAL

ALPHABETICAL INDEX

[T]	[X]
TG Frequency 4 - 110	X dB Down 4 - 42
TG Level 4 - 109	
TG OFF 4 - 110	[Y]
TG OUTPUT connector 2 - 2	
TG key 2 - 2	YIG-tuned Oscillator A - 26
TRACE Section 2 - 3	
TRACE Section Functions 4 - 32	[Z]
Talker 7 - 2	
Ten key 2 - 4	Zero Span A - 20
Terminal for ouputting write waveform to X-Y recorder ... 2 - 5	
Terminal for ouputting write waveform to X-Y recorder ... 2 - 5	
Terminal to external CRT display, video plotter 2 - 5	
Time Response 5 - 14	
Trace Mode 4 - 27	
Trace data 7 - 28	
Tracking Generator 5 - 2	
Tracking Generator Function . 4 - 109	
Transport 1 - 5	
Trigger 4 - 23	
Turning this Analyzer On 3 - 2	
[U]	
User channel setup command .. 9 - 16	
User Define Function 9 - 5	
USER key 2 - 3	
Unit key 2 - 4	
User-Defined Function 4 - 83	
[V]	
VBW 4 - 14	
VIDEO Output (Option) 2 - 5	
VIEW Mode 4 - 33	
VSWR A - 24	
Video Band Width 4 - 14	
Voltage Standing Wave Ratio . A - 24	
[W]	
WINDOW MEASUREMENT 4 - 106	
WRITE Mode 4 - 33	
Warm-Up 3 - 3	
Window Setting 4 - 102	

R3261/3361
SPECTRUM ANALYZER
INSTRUCTION MANUAL

EXTERNAL VIEW

EXTERNAL VIEW

● R3261C	EXTERNAL VIEW	EXT1
R3261CN	EXTERNAL VIEW	EXT2
R3261D	EXTERNAL VIEW	EXT3
R3361C	EXTERNAL VIEW	EXT4
R3361CN	EXTERNAL VIEW	EXT5
R3361D	EXTERNAL VIEW	EXT6
R3361K	EXTERNAL VIEW	EXT7
R3361NK	EXTERNAL VIEW	EXT8
● R3261C	FRONT VIEW	EXT9
R3261CN	FRONT VIEW	EXT10
R3261D	FRONT VIEW	EXT11
R3361C	FRONT VIEW	EXT12
R3361CN	FRONT VIEW	EXT13
R3361D	FRONT VIEW	EXT14
R3361K	FRONT VIEW	EXT15
R3361NK	FRONT VIEW	EXT16
● R3261/3361	SERIES REAR VIEW (Standard)	EXT17
R3261/3361	SERIES REAR VIEW (When option is installed)	EXT18

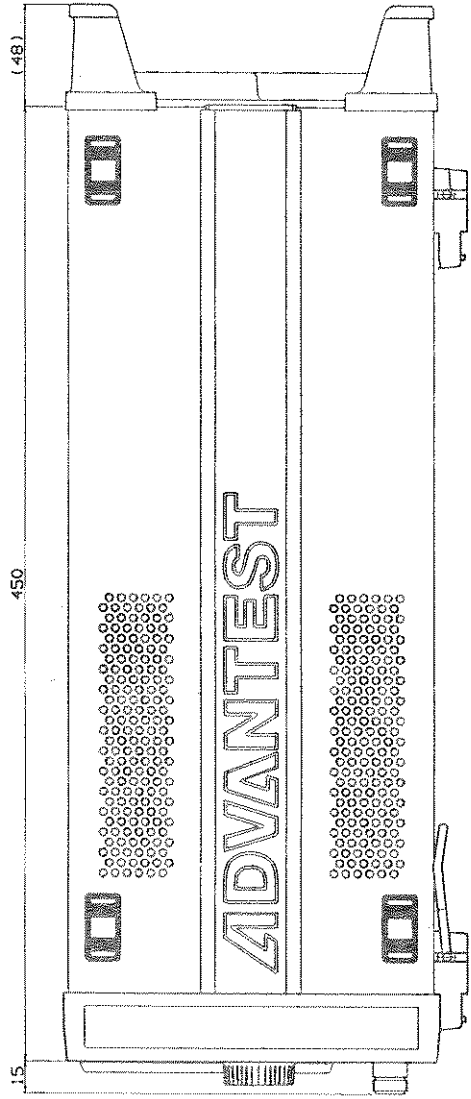

FRONT VIEW

Unit : mm

R3261C
EXTERNAL VIEW

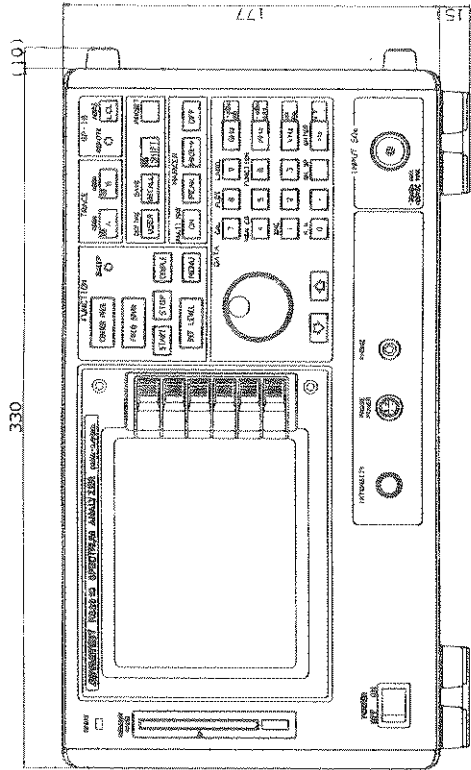

REAR VIEW

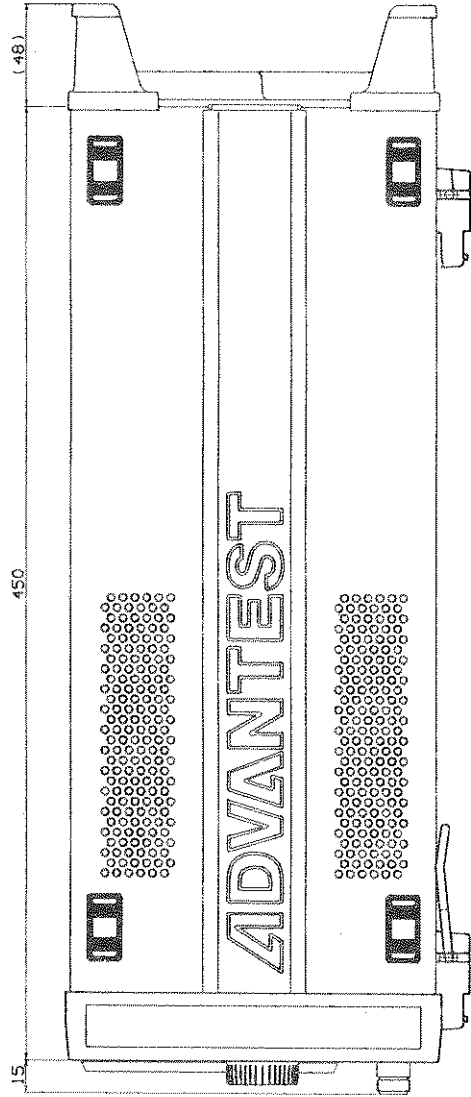
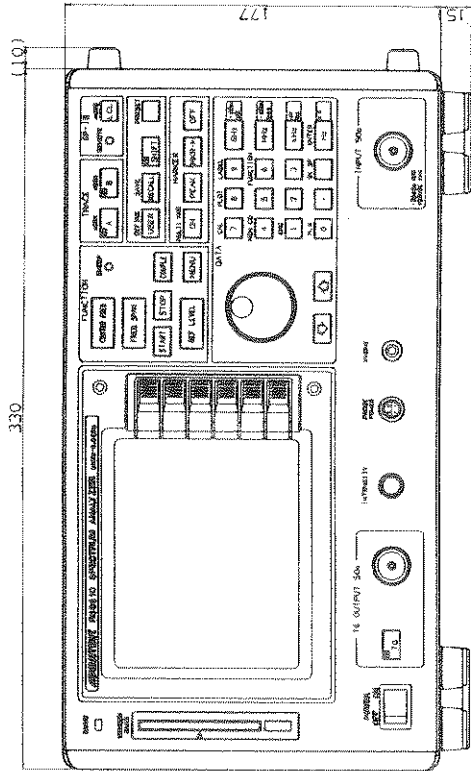

Unit : mm

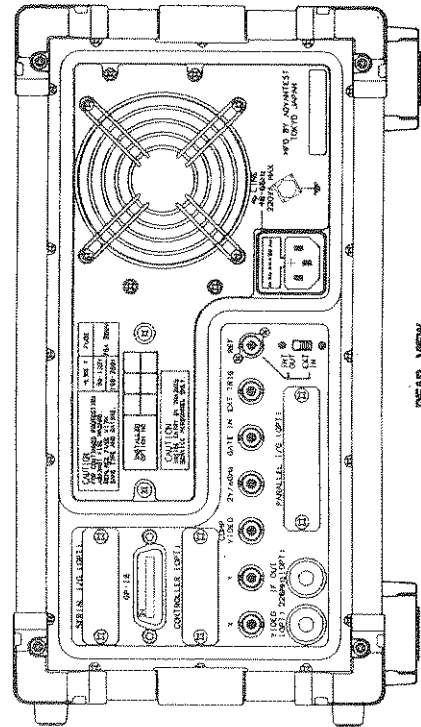

R3361C
EXTERNAL VIEW

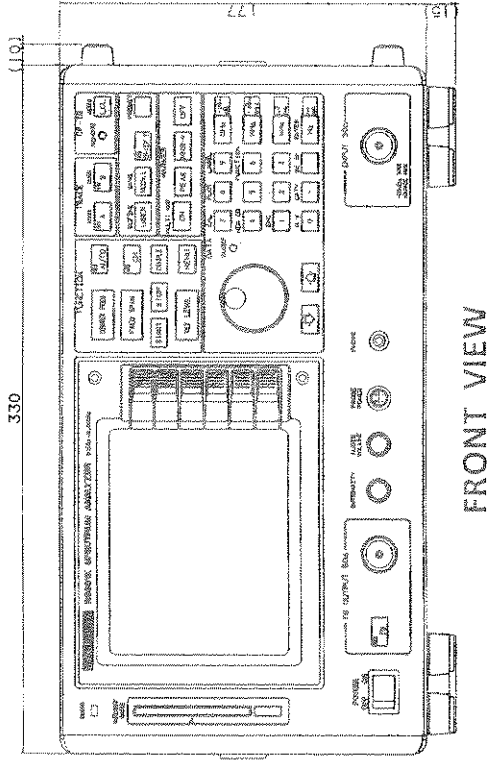

FRONT VIEW

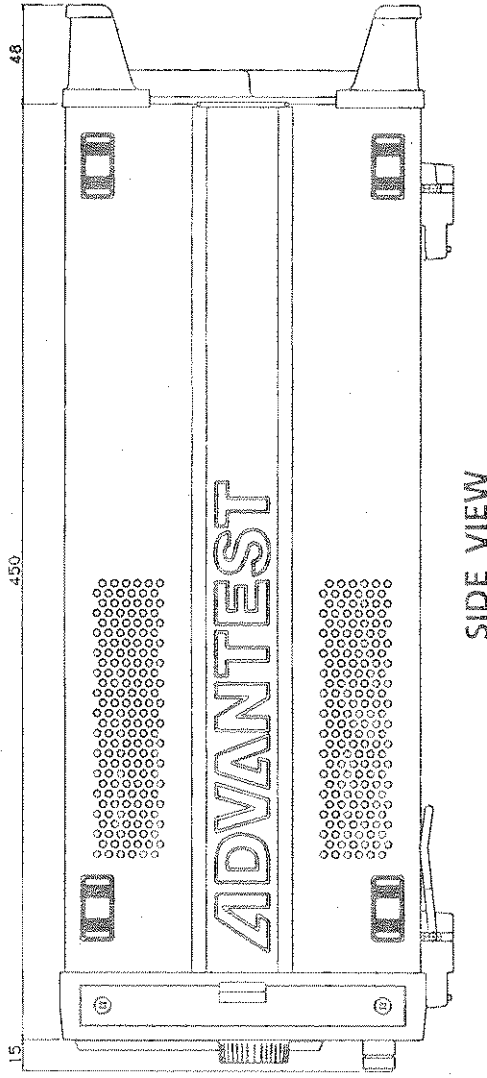

SIDE VIEW

Unit : mm

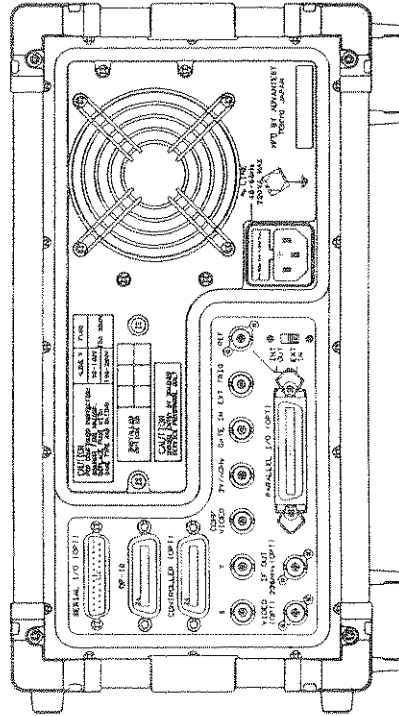

REAR VIEW

R3361K
EXTERNAL VIEW

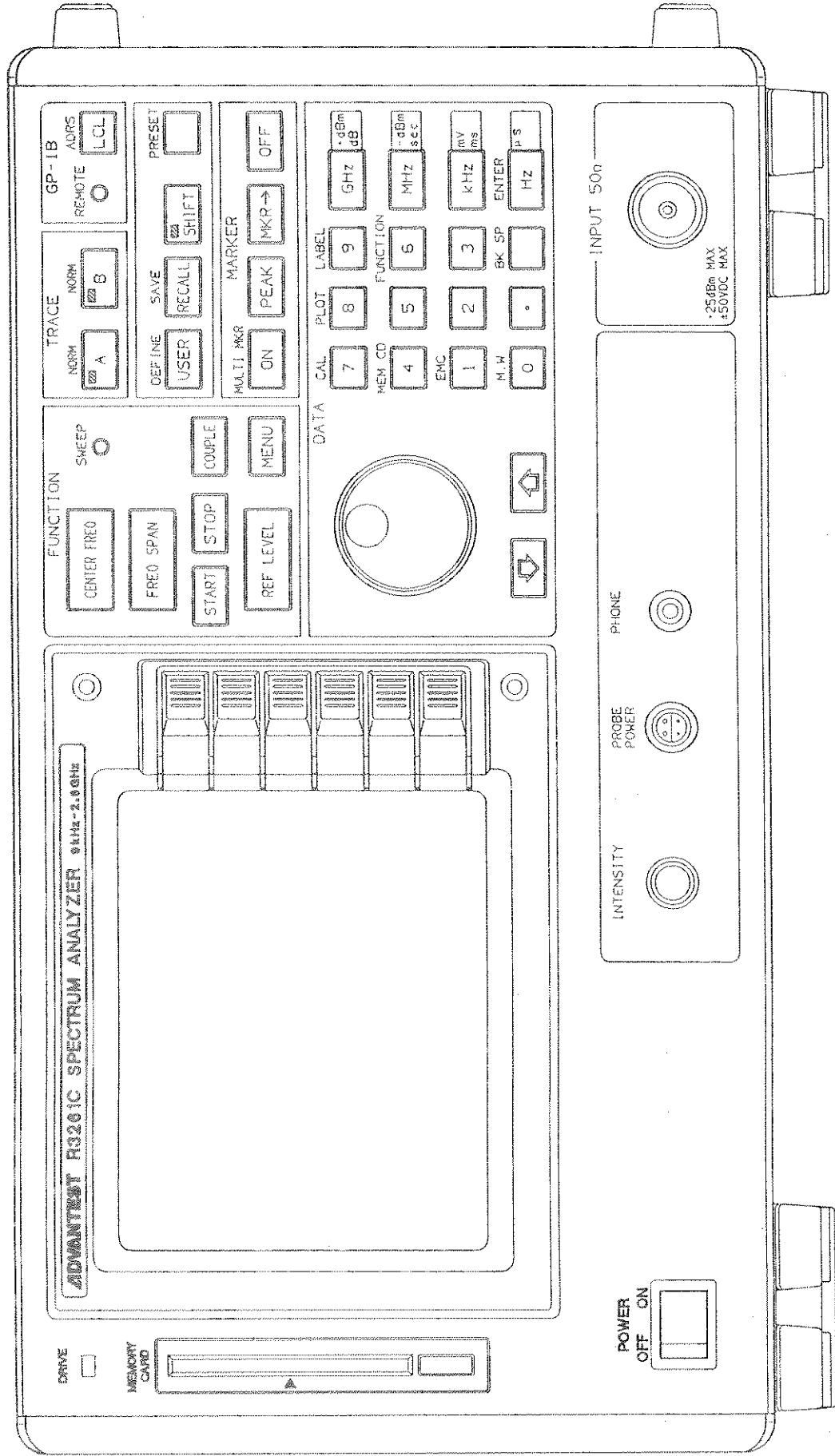

R3261C
FRONT VIEW

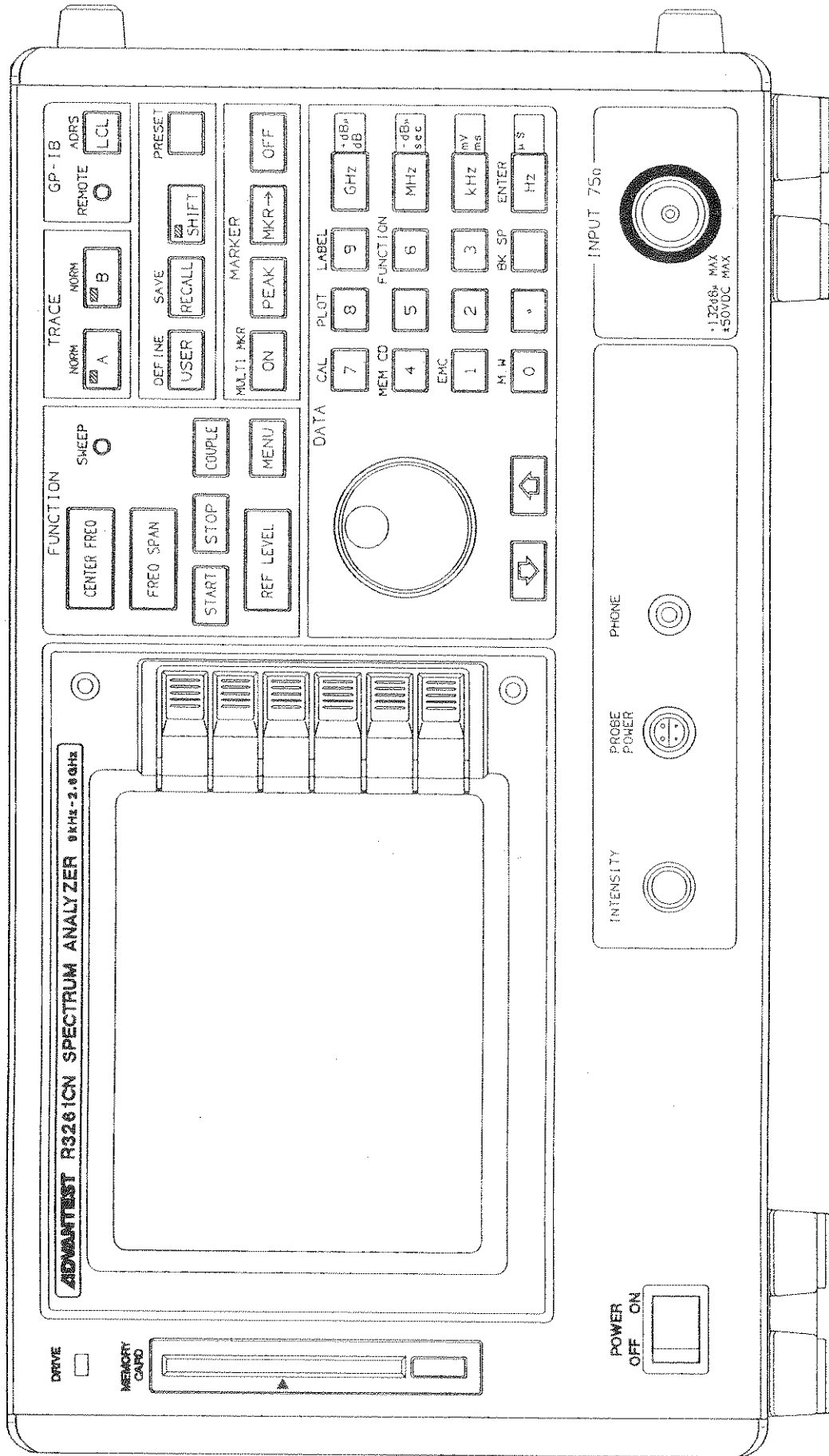

R3261CN
FRONT VIEW

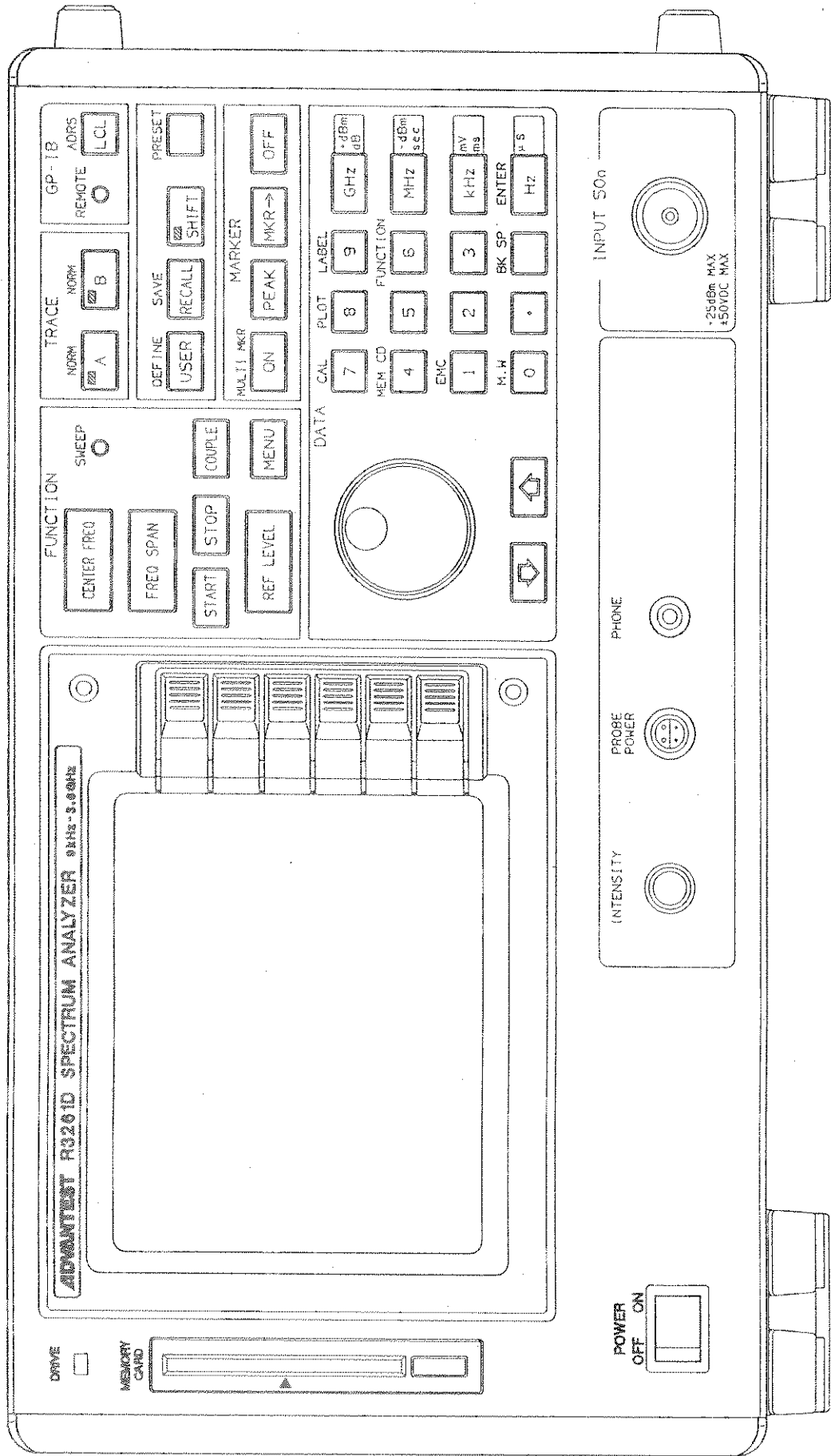

R3261D
FRONT VIEW

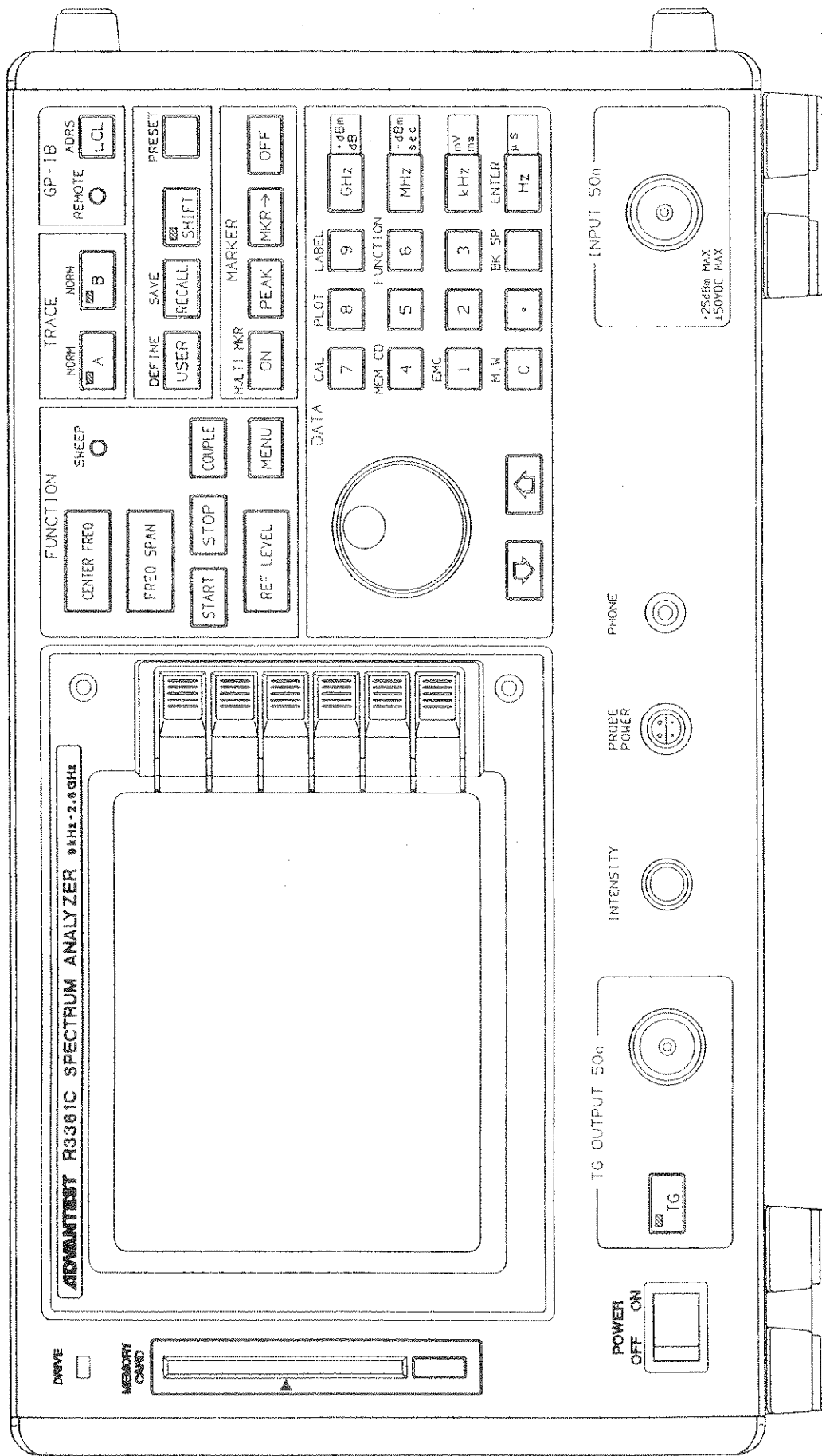

R3361C
FRONT VIEW

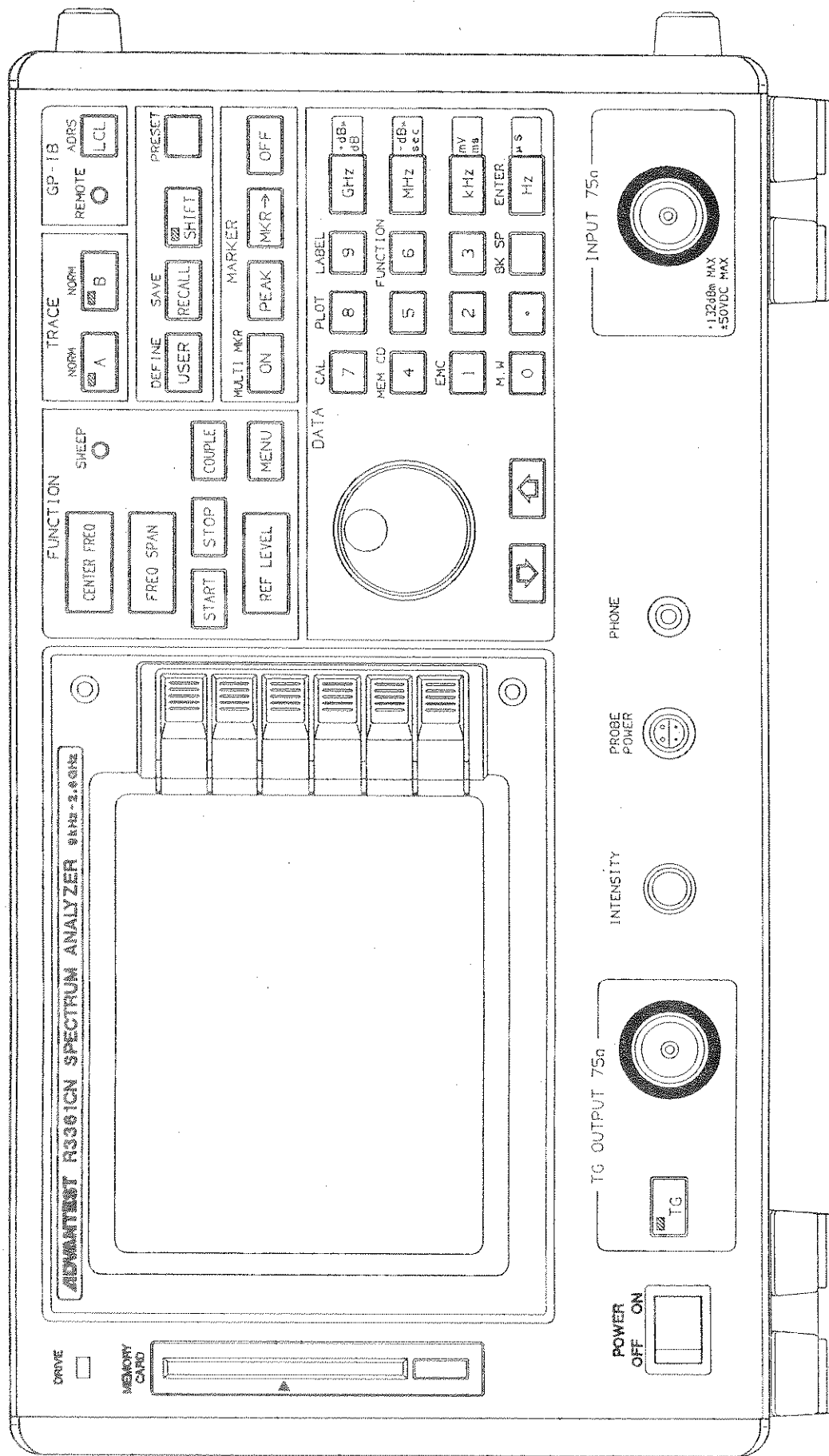

R3361CN
FRONT VIEW

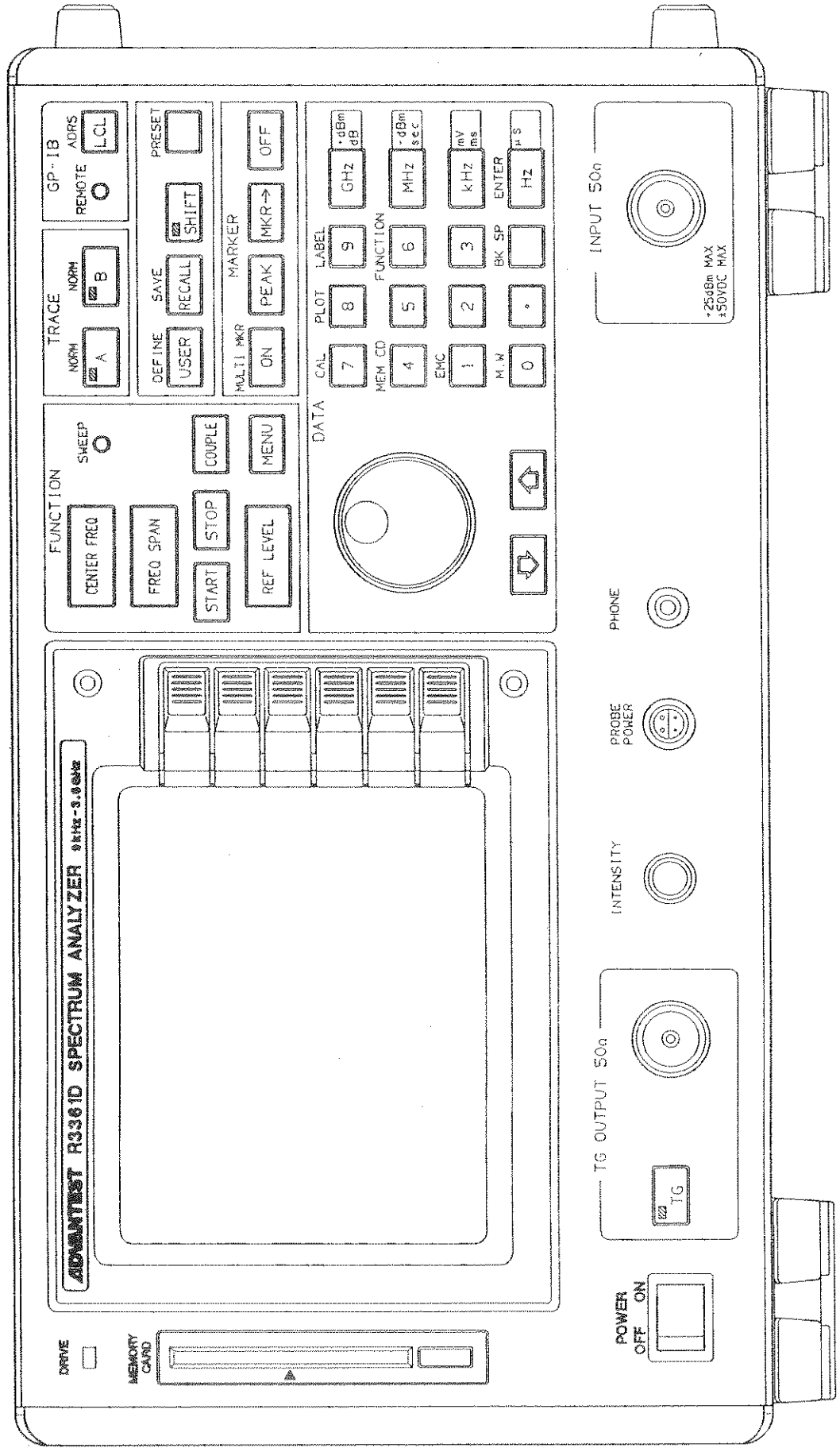

R3361D
FRONT VIEW

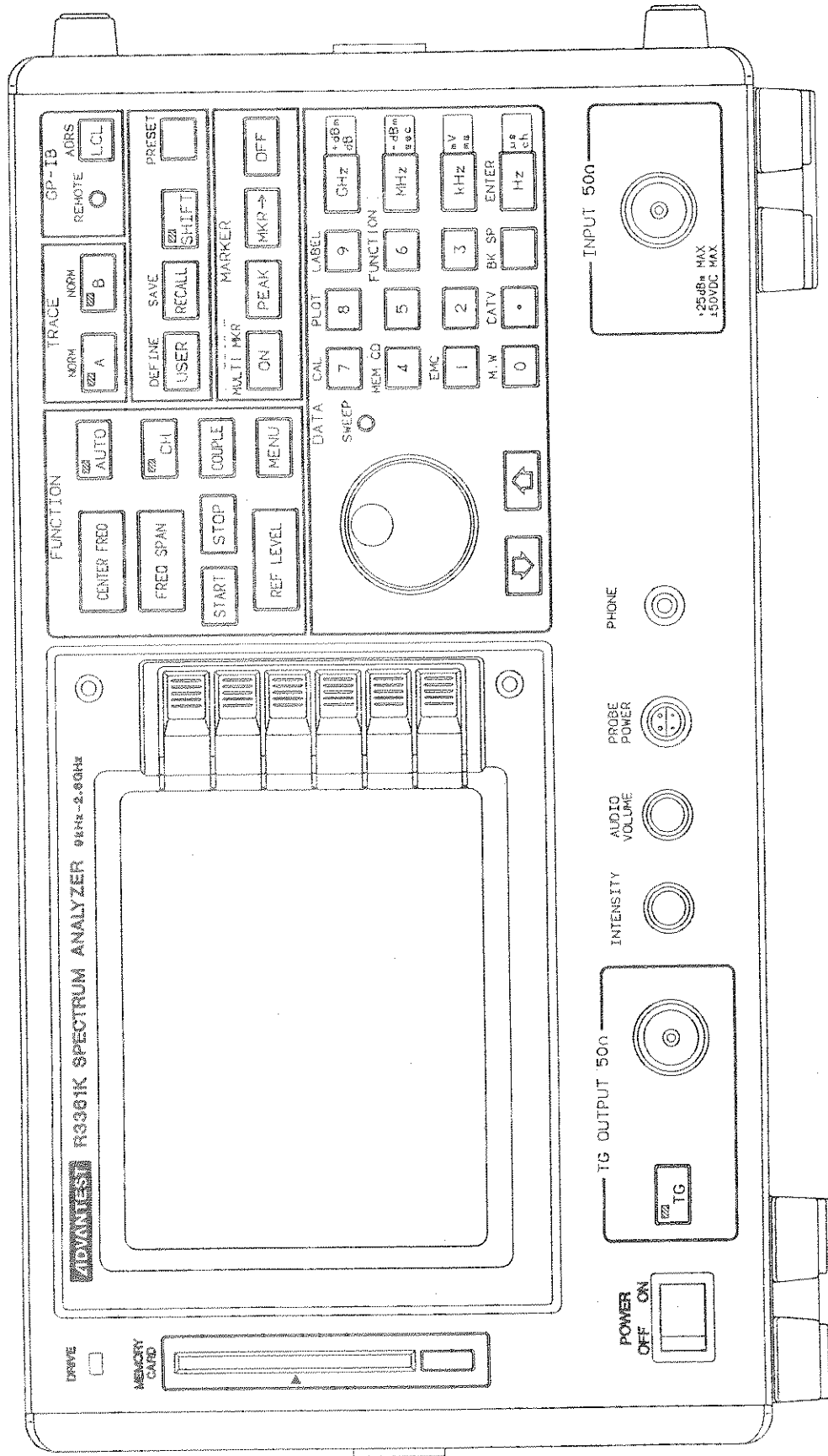

R3361K
FRONT VIEW

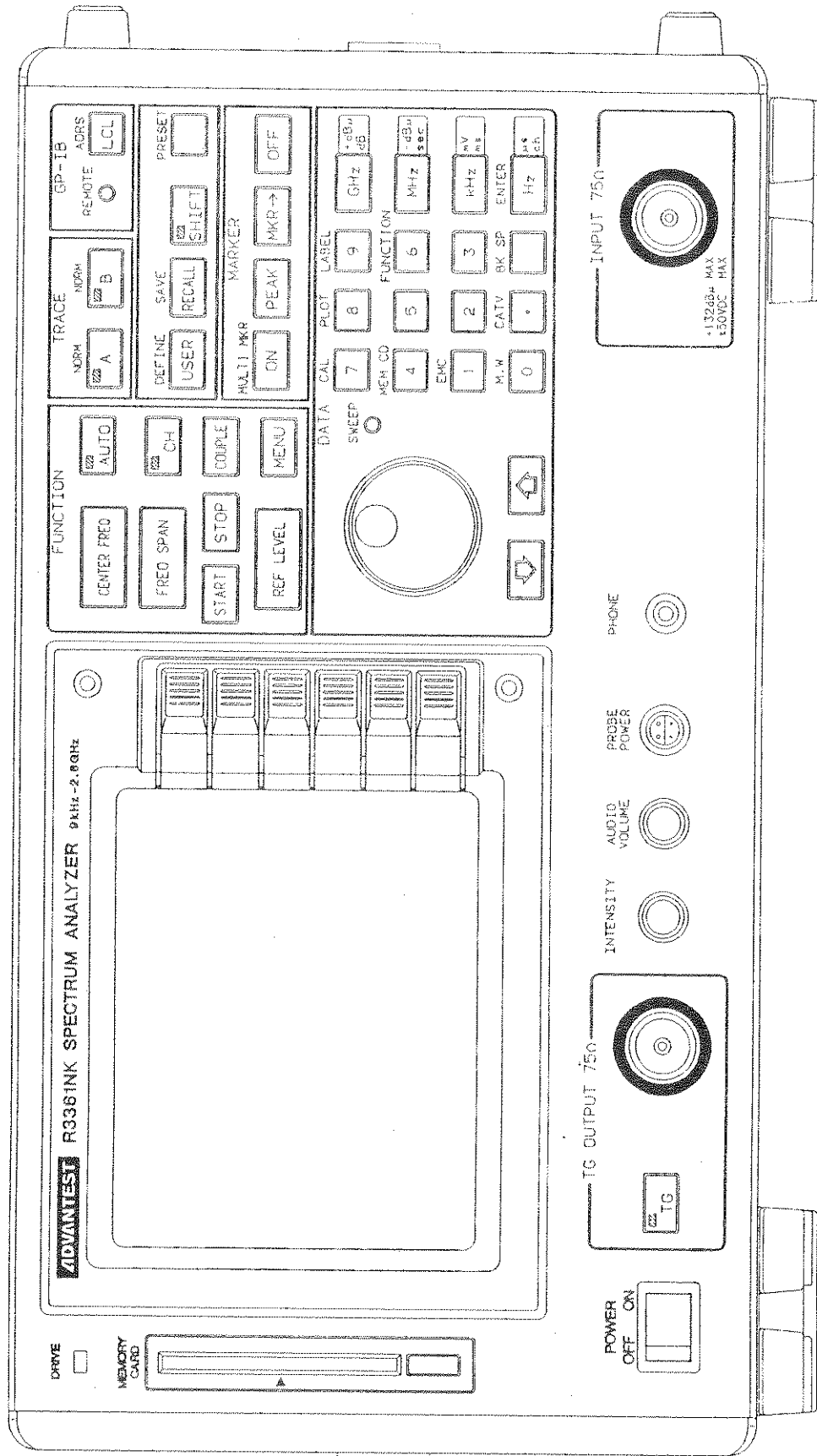

R3361NK
FRONT VIEW

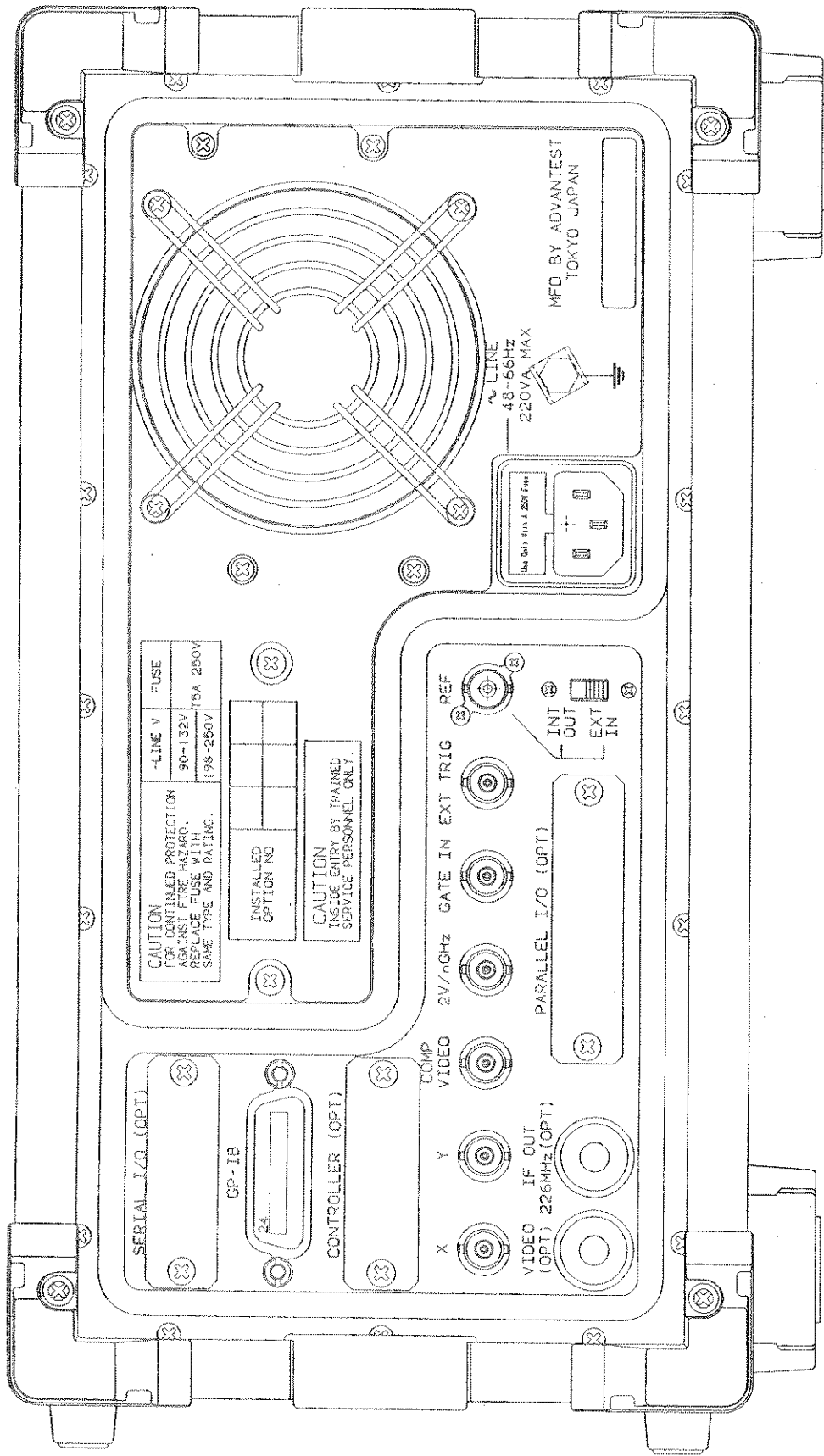

R3261/3361 SERIES
REAR VIEW (Standard)

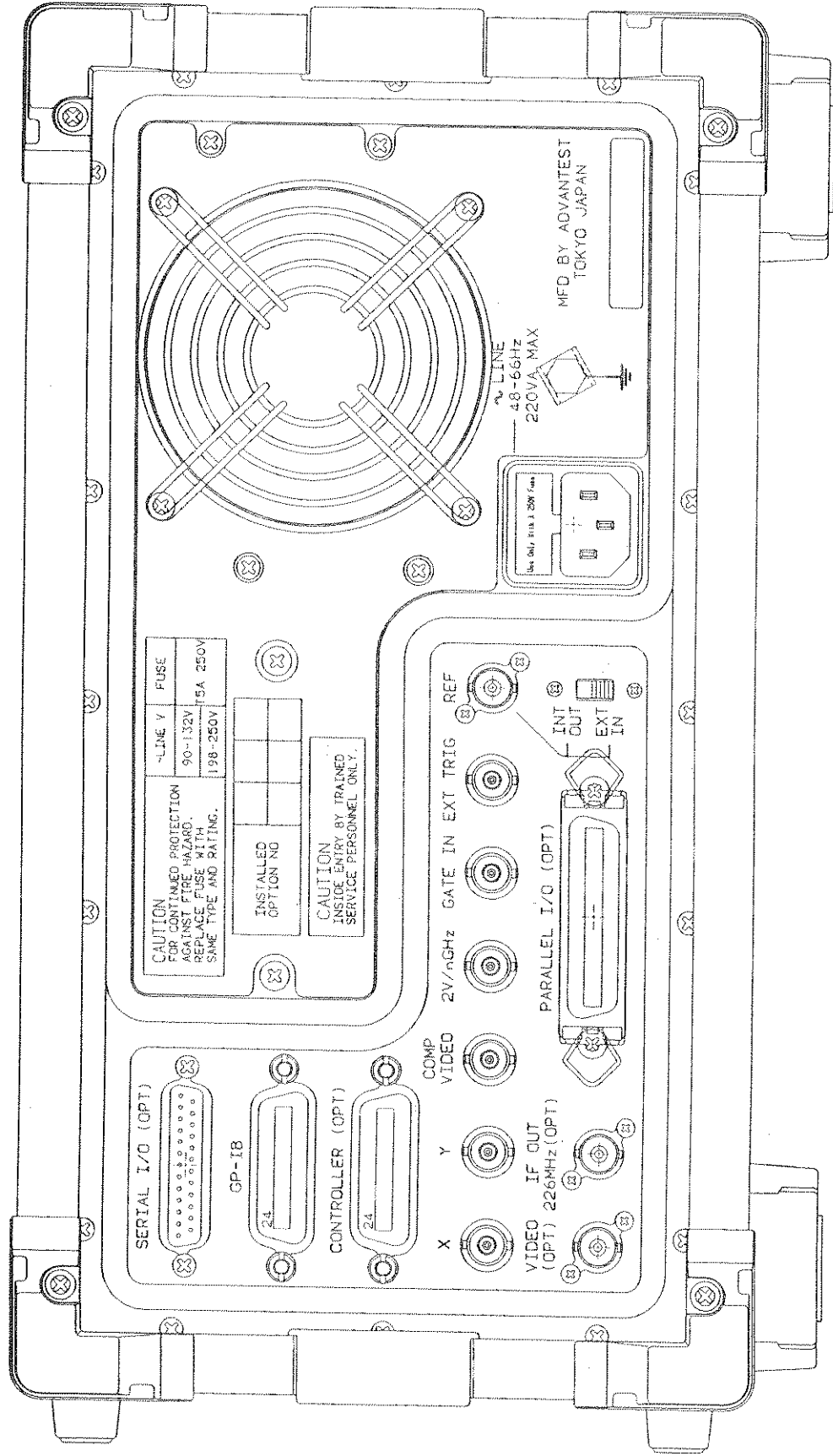

R3261/3361 SERIES
REAR VIEW (When option is installed)

P E R F O R M A N C E T E S T

TABLE OF CONTENTS

1	General	1
1.1	Testing Equipment	1
1.2	Calibration	2
2	Testing CAL Signals	3
3	Test Using Internal Signal	5
3.1	Testing Noise Sideband	5
3.2	Testing Frequency Drift	6
3.3	Testing Resolution Bandwidth (3dB bandwidth)	7
3.4	Testing Selectivity of Resolution Bandwidth	9
3.5	Testing Stability of QP Bandwidth	11
3.6	Testing Stability of Marker Indication (In normal mode)	13
3.7	Testing Stability of Marker Indication (In counter mode)	14
3.8	Testing Average Noise Level	15
3.9	Testing Residual Response	16
3.10	Testing Switchover Stability of Resolution Bandwidth	17
4	Testing Using Measuring Equipment	18
4.1	Testing Stability of Reference Oscillator	18
4.2	Testing Stability of Center Frequency	19
4.3	Testing Stability of Frequency Span	21
4.4	Testing LOG Linearity	23
4.5	Testing LIN Linearity	27
4.6	Testing Stability of Reference Level	28
4.7	Testing Stability of Input Attenuator Changeover	30
4.8	Testing Frequency Response	32
4.9	Testing Spurious Response	34
4.10	Testing Stability of Sweep Time	36
4.11	Testing Stability of TG Output Level (For R3361C/D only)	38
4.12	Testing TG Frequency Response (For R3361C/D only)	39
4.13	Testing Stability of TG Output Level Changeover (For R3361C/D only)	40
4.14	Testing Output Spurious (For R3361C/D only)	41
4.15	Testing TG Leak (For R3361C/D only)	42
5	Test Report	43

1 General

1.1 Testing Equipment

Equipment to be used for the performance test is listed in Table 1. The cables needed are listed in Table 2.

Table 1 Test Equipment

Test Equipment	Required Performance	Recommended Equipment
Synthesized Signal Generator	Frequency : to 3.6 GHz Output Level : +10 dBm to -30 dBm Output Impedance : 50Ω AM Modulation : 100 Hz with 30% Modulation (or external modulation)	Advantest R4262
Low Distortion Signal Generation (or synthesized signal generator with low pass filter)	Frequency : to 1.8 GHz Output Level : -10 dBm Output Impedance : 50Ω Second Harmonic Frequency : 60dB or less for -10dBm output	Advantest R4262 +L.P.F.
RF Power Meter	Frequency : to 3.6 GHz Sensitivity : +20 dBm to -50 dBm : ±0.2 dB	Generic
Attenuator	Frequency : to 500 MHz Attenuation : 10 dB step : 0 to 110 dB : 1 dB step : 0 to 11 dB Stability : 10dB : ±0.2 dB : 1dB : ±0.02 dB	Generic
Low-Frequency Generator	Frequency : 100 Hz Output Level : 1 Vp-p	Generic
Frequency Comparator		Generic
Frequency Standard	Stability : 2×10^{-9}	Advantest TR3110

Table 2 Cables & Adapters Required

Product Name	Model	Stock No.	Remarks
Connecting Cable (BNC-BNC)	MI-02	DCB-FF0386	
Connecting Cable (SMA-SMA)	A01002	-	
N-BNC Conversion Adapter	JUG-201A/U	JCF-AF001Ex03	
N-SMA Conversion Adapter			

1.2 Calibration

Self-calibration is an important factor for the high performance spectrum analyzer. Let the system warm up for 30 minutes and then start the self-calibration performance test. Self-calibration is started by the following keystrokes.

SHIFT 7 CAL ALL
(SOFT KEY 1)

The calibration should be made on the following items :

- (1) INPUT ATTENUATOR
- (2) IF STEP AMP
- (3) RBW SWITCHING
- (4) LOG LINEARITY
- (5) AMPLITUDE MAG
- (6) TG TRACKING

2 Testing CAL Signals

The CAL signal frequency accuracy is same as that of the reference oscillator because the CAL signal is phase-locked to the reference oscillator.

$\pm 2 \times 10^{-8}$ /day
 $\pm 1 \times 10^{-7}$ /year

Procedure

- ① Preset and then set spectrum analyzer to the following settings.

CENTER FREQ : 30MHz
FREQ SPAN : 2MHz
RBW : 300kHz
dB/div : 1dB
REF LEVEL : -15dBm

- ② Enter a 30MHz, -20.0dBm signal from an external signal generator to the system.
- ③ Adjust the REF LEVEL so that the spectrum of the signal appears at the center of the screen.
- ④ Remove the cable that is connected to the external signal generator. Make the CAL SIG (at -20.0dBm) appear on the screen.

SHIFT 7 CAL SIG
ON/OFF
(SOFT KEY 4)

- ⑤ Check that the difference is within $\pm 0.3\text{dB}$ between the levels of the signal at the input from SG and the CAL SIG. If not, make adjustments according to the chapter 5. "ADJUSTMENTS" in maintenance manual.

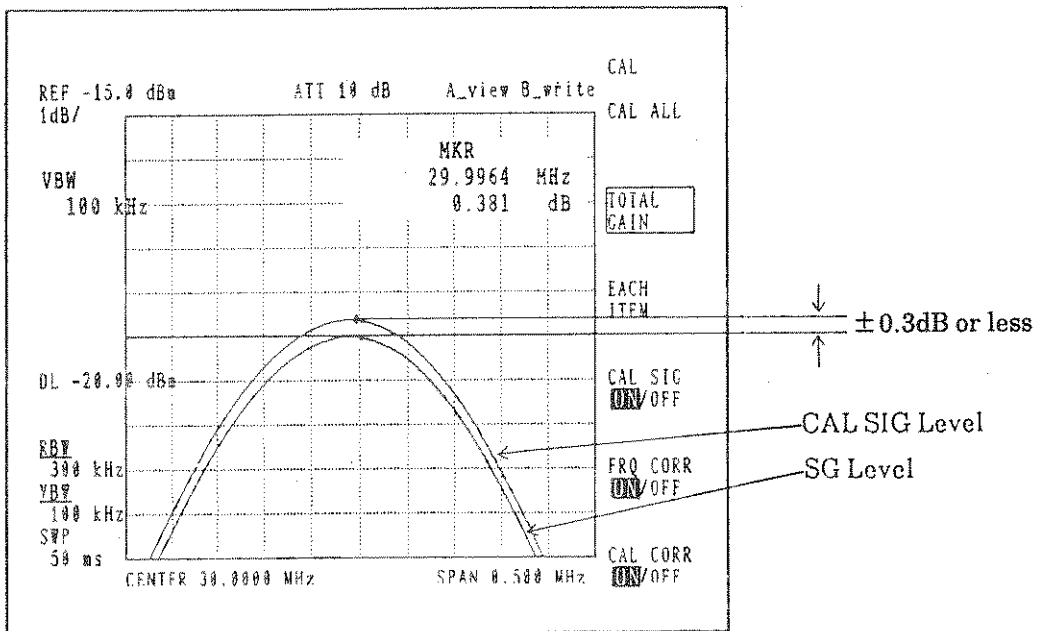
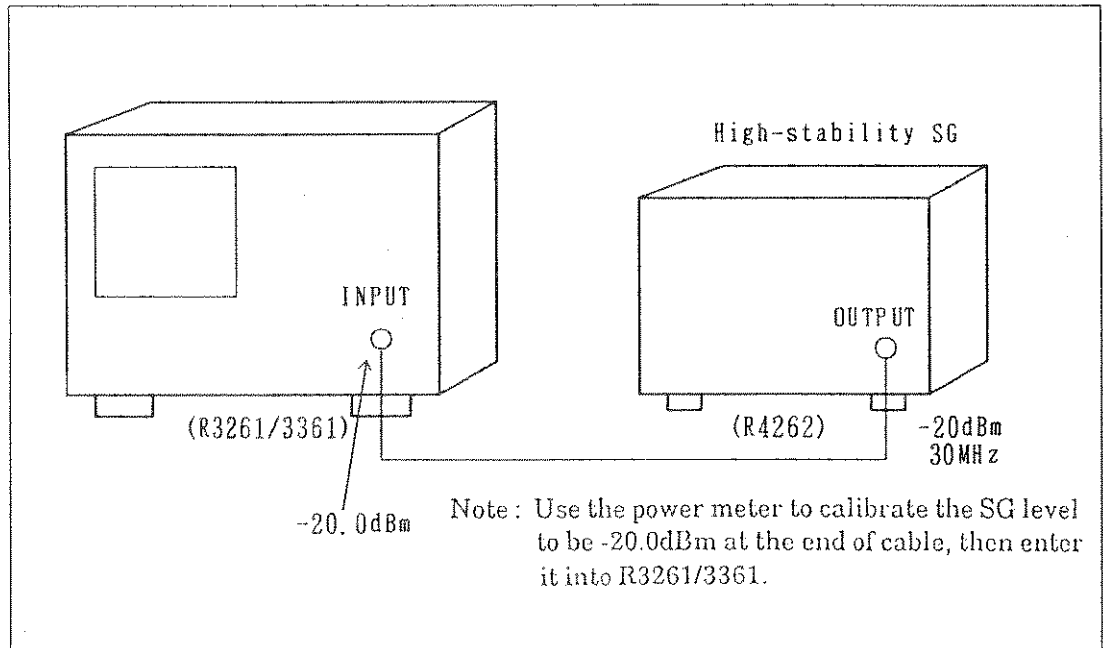

3 Test Using Internal Signal

3.1 Testing Noise Sideband

Procedure

- ① From the preset condition, set the spectrum analyzer as follows:

CENTER FREQ : 0MHz
FREQ SPAN : 40kHz
ATT : 0dB
VBW : 10Hz
RBW : 300Hz

- ② Read the peak level of the zero spectrum using the marker.

- ③ Set the spectrum analyzer as follows:

REF LEVEL : -50dBm

- ④ Read the average left end level of the noise waveform as it appears on the screen.

- ⑤ Obtain the noise sideband (with 20kHz offset) from the levels determined in steps ② and ④ above.

The formula used is:

result of ② put into XdB
result of ④ put into YdB
 $|Y| - |X| - 23\text{dBc/Hz} \leq -105\text{dBc/Hz}$

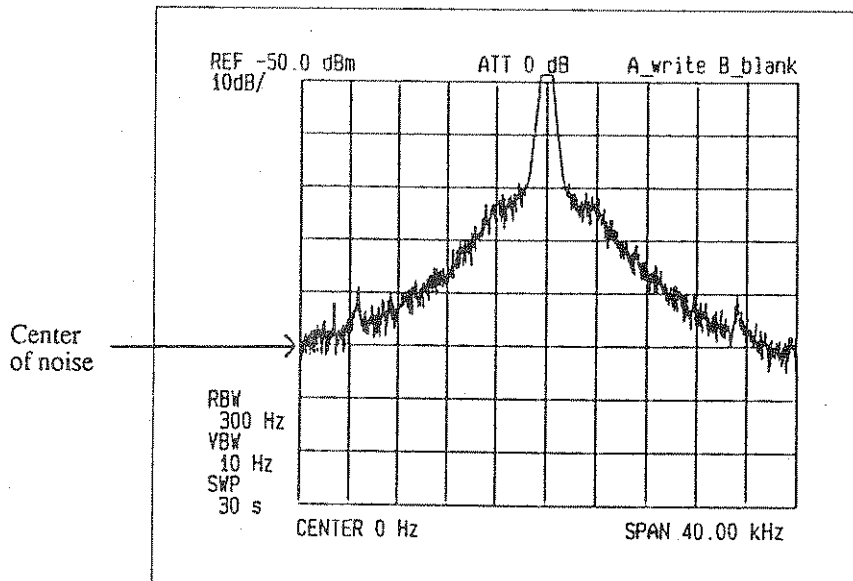

3.2 Testing Frequency Drift

Procedure

- ① Preset and then set the spectrum analyzer to the following settings:

CENTER FREQ : 0MHz
FREQ SPAN : 1kHz

- ② Confirm that the drift of the zero spectrum as measured for one minute is within 300Hz.

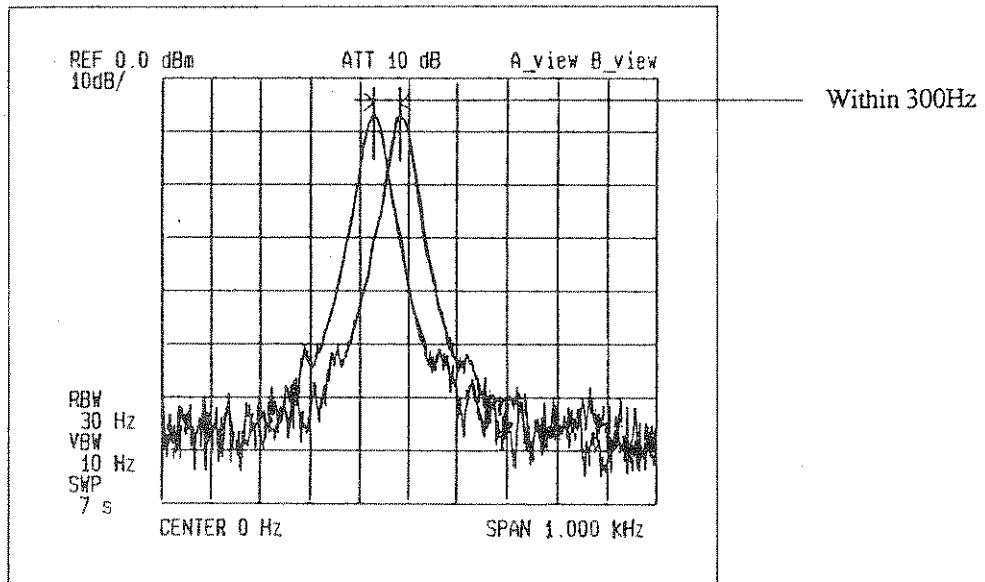

3.3 Testing Resolution Bandwidth (3dB bandwidth)

Procedure

- ① Preset and then set the spectrum analyzer to the following settings:

CENTER FREQ : 30MHz
FREQ SPAN : 2MHz
RBW : 1MHz
REF LEVEL : -18dBm
dB/div : 1dB
CAL SIG : ON

- ② Set the spectrum analyzer as follows:

PEAK
ΔMKR

- ③ By turning the data knob counterclockwise, move the marker to such a position as to give a 3dB difference between the two points indicated by the marker.

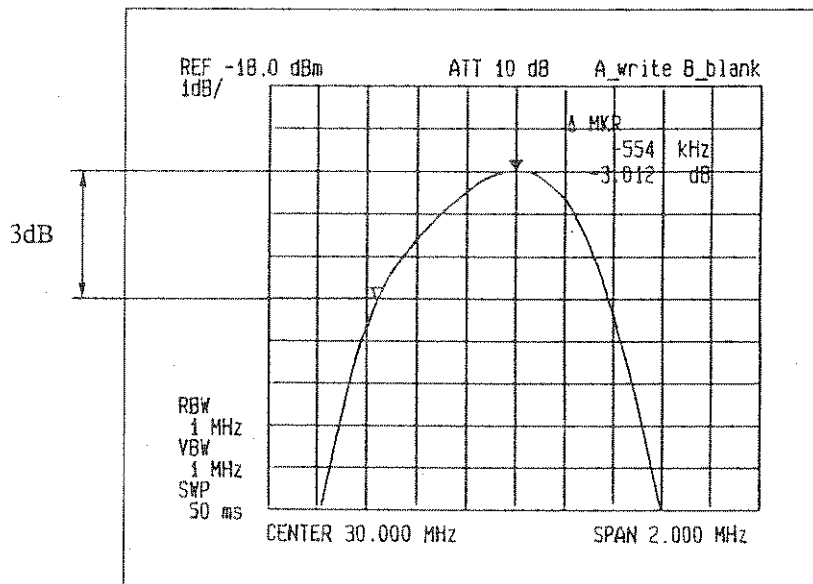

- ④ Set the spectrum analyzer as follows:

ΔMKR

- ⑤ By turning the data knob counterclockwise, move the marker to such a position as to give a 0.0dB difference between the two points indicated by the marker.

3 Test Using Internal Signal

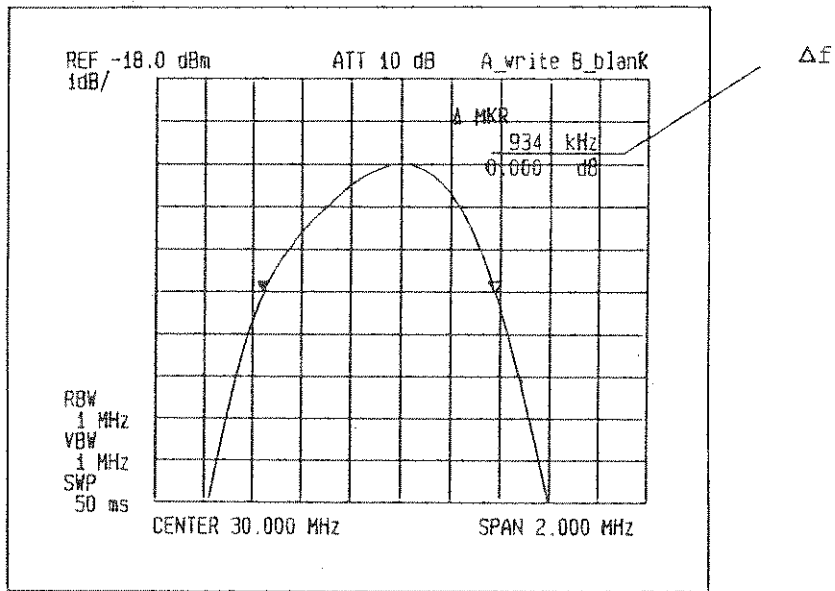

- ⑥ Confirm that the frequency difference, Δf , is within $\pm 20\%$ of the set value.
- ⑦ Check for 300kHz and 3kHz resolution bandwidths by performing steps ② through ⑥ above. Table 3 lists the span values most suitable to each resolution bandwidth. If the test result falls out of the specification, make adjustments in accordance with the chapter 5. "ADJUSTMENTS" in maintenance manual.

Table 3 Relationship Between Resolution Bandwidth and Span

RBW [Hz]	1M	300k	3k
FREQ SPAN [Hz]	2M	500k	5k

3.4 Testing Selectivity of Resolution Bandwidth

Procedure

- ① From the preset condition, set the spectrum analyzer as follows:

CENTER FREQ : 30MHz
FREQ SPAN : 5MHz
RBW : 1MHz
VBW : 10kHz
ATT : 0dB
REF LEVEL : -20dBm
CAL SIG : ON

- ② Set the spectrum analyzer as follows:

PEAK
ΔMKR

- ③ By turning the data knob counterclockwise, move the marker to such a position as to give a 60dB difference between the two points indicated by the marker.

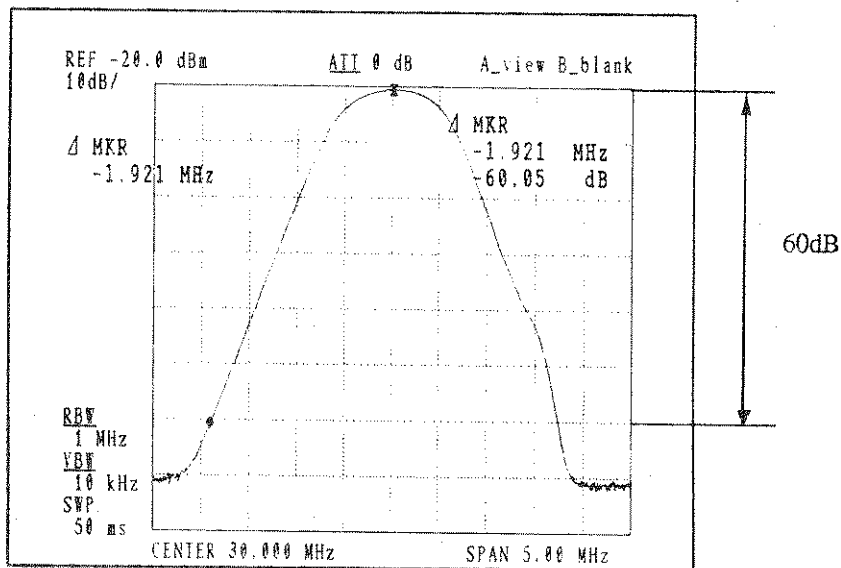

- ④ Set the spectrum analyzer as follows:

ΔMKR

Cont'd

- ⑤ By turning the data knob counterclockwise, move the marker to such a position as to give a 0.0dB difference between the two points indicated by the marker.

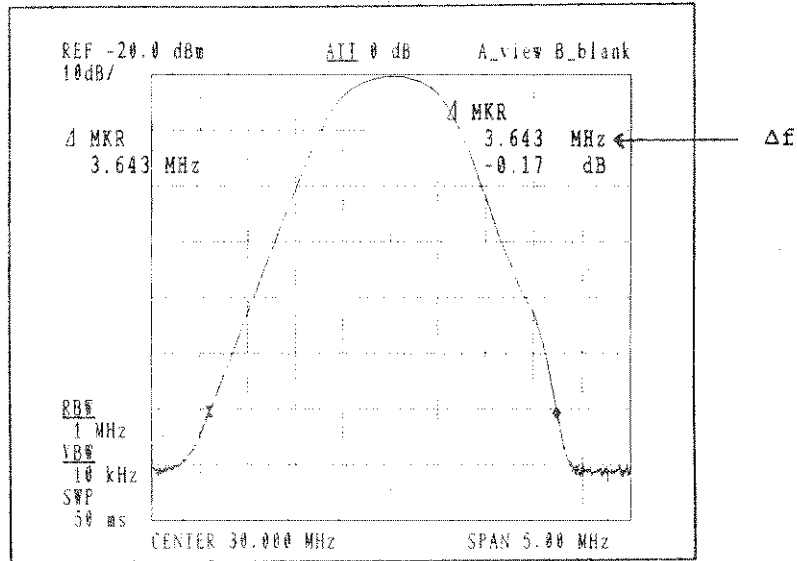

- ⑥ The 60dB bandwidth of the IF filter is given as the frequency difference, Δf , between the two points. Confirm that the ratio of this value to the value obtained in the resolution bandwidth test is 15:1 or less.
- ⑦ Check for 300kHz and 3kHz resolution bandwidths by performing steps ② through ⑥ above. Table 4 shows the relationship between resolution bandwidth and FREQ SPAN. If the test result falls out of the specification, make adjustments according to the chapter 5. "ADJUSTMENTS" in maintenance manual.

Table 4 Settings for Resolution Bandwidth Selectivity Test

RBW [Hz]	1M	300k	3k
FREQ SPAN [Hz]	5M	5M	50k
VBW [Hz]	10k	10k	1k

3.5 Testing Stability of QP Bandwidth

The QP value measurement is for measuring the pulse characteristic noise. Various constants in this measurement are defined values in the CISPR Standards as shown in Table 5.

Table 5 CISPR Standards for QP Value Measurement Basic Characteristic

Measuring band	6dB bandwidth	Charging time constant	Discharging time constant	Mechanical time constant
10kHz to 150kHz	200Hz	45ms	500ms	160ms
150kHz to 30MHz	9kHz	1ms	160ms	160ms
30MHz to 1GHz	120kHz	1ms	550ms	100ms

Procedure

- ① From the preset condition, set the spectrum analyzer as follows:

CENTER FREQ : 30MHz
 FREQ SPAN : 200kHz
 REF LEVEL : -18dBm
 dB/div : 2dB/
 QP BW : 120kHz (6dB)
 CAL SIG : ON

- ② Set the spectrum analyzer as follows:

PEAK
 ΔMKR

- ③ By turning the data knob counterclockwise, move the marker to such a position as to give a 6dB difference between the two points indicated by the marker.

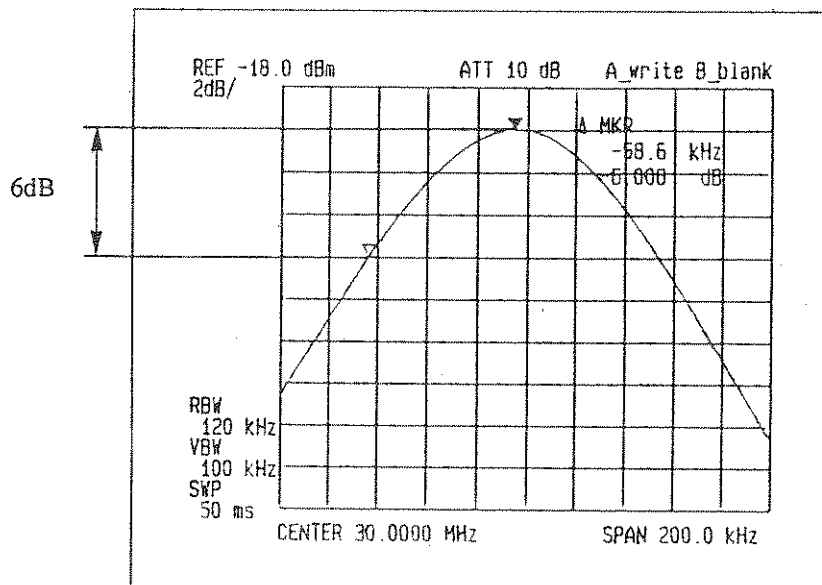

Cont'd

- ④ Set the spectrum analyzer as follows:

Δ MKR

- ⑤ By turning the data knob counterclockwise, move the marker to such a position as to give a 0.0dB difference between the two points indicated by the marker.

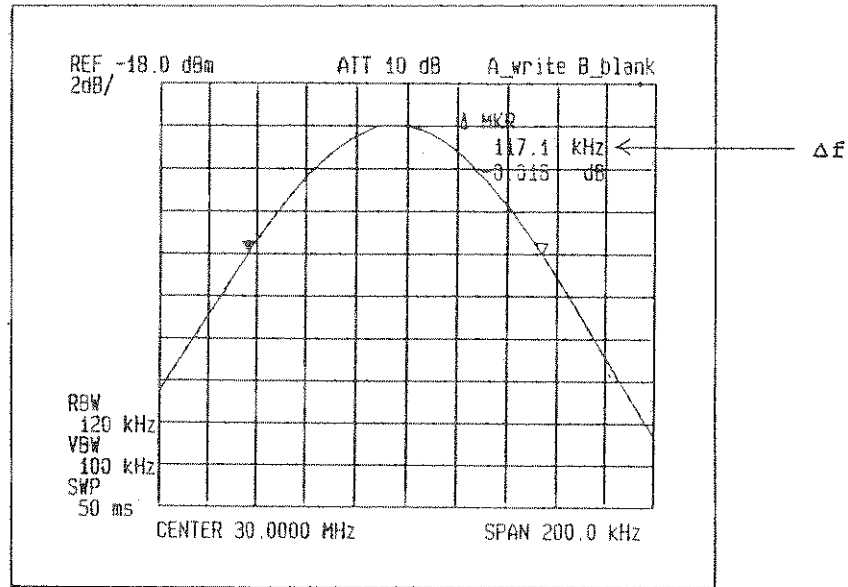

- ⑥ Confirm that the frequency difference, Δf , between the points is within 110kHz to 130kHz.
- ⑦ Check for 9kHz and 200Hz QP bandwidths by performing steps ② to ⑥ above. Table 6 shows the relationships between QP bandwidth, FREQ SPAN and sweep time.

Table 6 Setting for the QP Bandwidth Stability Test

QP bandwidth	120kHz	9kHz	200Hz
FREQ SPAN	200kHz	20kHz	2kHz
Sweep time	50ms	100ms	2sec

3.6 Testing Stability of Marker Indication (In normal mode)

Procedure

- ① From the preset condition, set the spectrum analyzer as follows:

CENTER FREQ : 30MHz
FREQ SPAN : 20MHz
CAL SIG : ON
MARKER : PEAK

- ② Confirm that the marker indication is within $30\text{MHz} \pm 1.05\text{MHz}$.

- ③ Set the spectrum analyzer as follows:

FREQ SPAN : 10MHz
MARKER : PEAK

- ④ Confirm that the marker indication is within $30\text{MHz} \pm 0.55\text{MHz}$

- ⑤ Set the spectrum analyzer as follows:

FREQ SPAN : 2MHz
MARKER : PEAK

- ⑥ Confirm that the marker indicator is within $30\text{MHz} \pm 0.16\text{MHz}$.

3.7 Testing Stability of Marker Indication (In counter mode)

Procedure

- ① From the preset condition, set the spectrum analyzer as follows:

CENTER FREQ	:	30MHz
FREQ SPAN	:	1kHz
CAL SIG	:	ON
MARKER	:	PEAK
		COUNTER
RESOLUTION	:	1Hz

- ② Confirm that the marker indication is within $30\text{MHz} \pm 1\text{Hz}$.

3.8 Testing Average Noise Level

Procedure

- ① From the preset condition, set the spectrum analyzer as follows:

ATT : 0dB
REFLEVEL : -70dBm
RBW : 1MHz
VBW : 1kHz
START FREQ : 50MHz
STOP FREQ : 3600MHz (2600MHz for R3261C/R3361C)

- ② At completion of the sweep, set the spectrum analyzer as follows:

Press the **PEAK**, **MKR→** and **MKR→**
CF keys.

SPAN : 1kHz
RBW : 300Hz
VBW : 1kHz

- ③ Confirm that the noise level at the frequency, in GHz, determined in step ② above is $-121\text{dBm} + 1.55f[\text{GHz}]$ or less.

3.9 Testing Residual Response

Procedure

- ① From the preset condition, set the spectrum analyzer as follows:

CENTER FREQ	:	250MHz
SPAN	:	500MHz
RBW	:	30kHz
VBW	:	1kHz
ATT	:	0dB
REF LEVEL	:	-60dBm

- ② Confirm that there is no residual spurious when no connection is made to the input terminal of the spectrum analyzer.
- ③ Confirm that there is no residual spurious when the frequency is changed up to 3.6GHz (2.6GHz for R3261C/R3361C) with the CENTER FREQ set to 500MHz.

3.10 Testing Switchover Stability of Resolution Bandwidth

Procedure

- ① From the preset condition, set the spectrum analyzer as follows:

CENTER FREQ : 30MHz
 FREQ SPAN : 500kHz
 RBW : 300kHz
 REF LEVEL : -15dBm
 dB/div : 1dB/
 CAL SIG : ON

- ② While changing the resolution bandwidth from 1MHz to 30Hz, confirm that the peak level of each spectrum is within ± 0.3 dB of the level at 300kHz resolution bandwidth. Table 7 shows that relationship between bandwidth and FREQ SPAN. If the test result falls out of the specification, make adjustments according to the chapter 5. "ADJUSTMENTS" in maintenance manual.

Table 7 Relationship Between Resolution Bandwidth and FREQ SPAN

RBW [Hz]	1M	300k	100k	30k	10k	3k	1k	300	100	30
FREQ SPAN [Hz]	2M	500k	200k	50k	20k	5k	2k	1k	1k	1k

4 Testing Using Measuring Equipment

4.1 Testing Stability of Reference Oscillator

Procedure

- ① Set the REF INT OUT/EXT IN switch on the rear panel of the spectrum analyzer to INT OUT. Connect frequency standard to REF socket on spectrum analyzer through a frequency comparator.

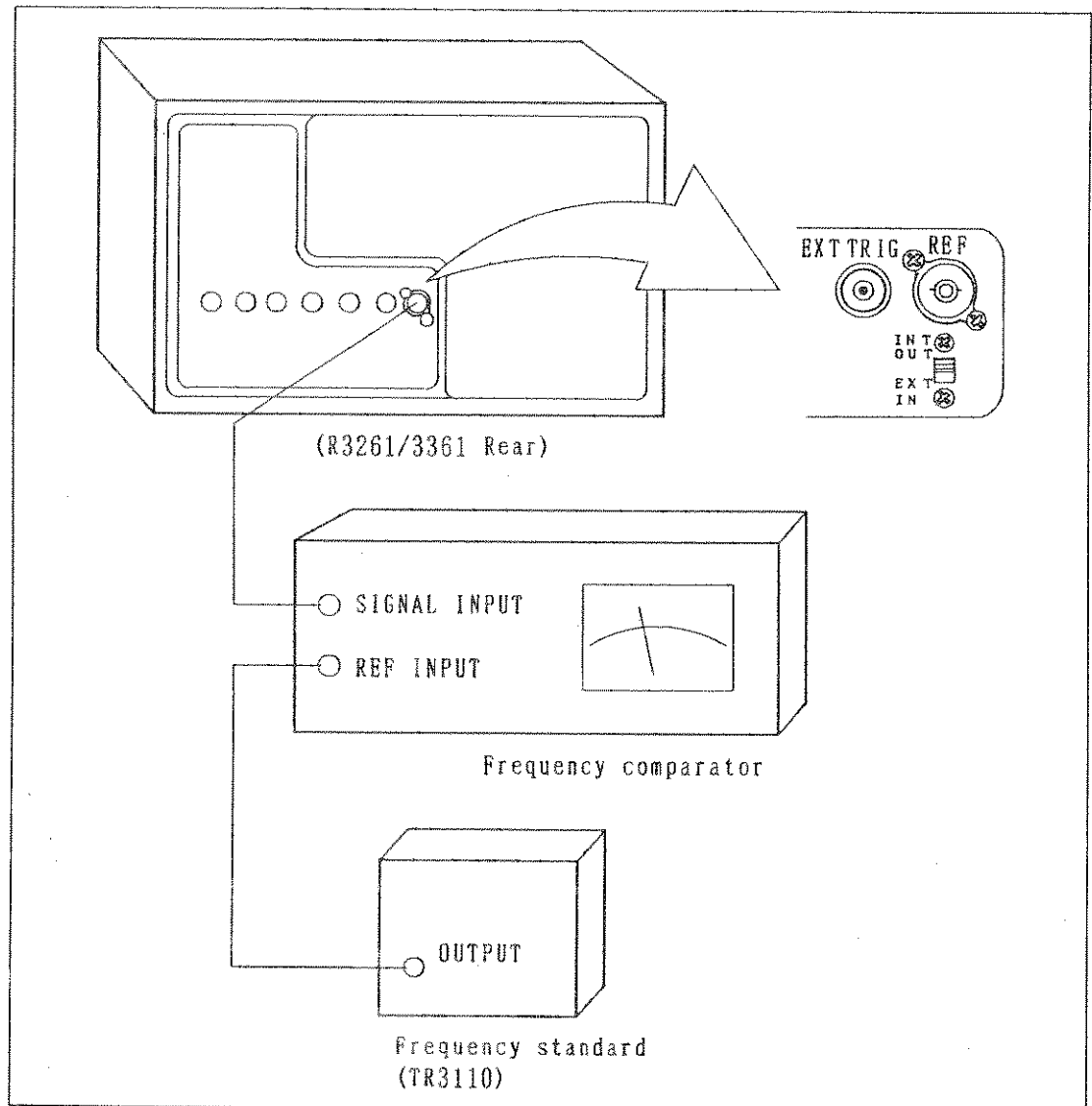

- ② Confirm that the reading on the frequency comparator is 2×10^{-8} or less.

Cont'd

4.2 Testing Stability of Center Frequency

Procedure

- ① From the preset condition, set the spectrum analyzer as follows:

CENTER FREQ : 30MHz
FREQ SPAN : 20MHz
- ② Input a 30MHz, -10dBm signal-generated signal to the spectrum analyzer. The signal generator must have stability of 2×10^{-8} or better.
- ③ Confirm that the peak of the spectrum is within $\pm 450\text{kHz}$ (± 0.2 div). of the screen center.
- ④ Set the spectrum analyzer to the following settings, and confirm that the position of the spectrum peak is still within the specification.

Table 8 FREQ SPAN and Center Frequency Stability

FREQ SPAN	20MHz	10MHz	2MHz	1 kHz
Specification	$\pm 450\text{kHz}$ ($\pm 0.2\text{div}$)	$\pm 250\text{kHz}$ ($\pm 0.2\text{div}$)	$\pm 60\text{kHz}$ ($\pm 0.3\text{div}$)	$\pm 50\text{Hz}$ ($\pm 0.5\text{div}$)

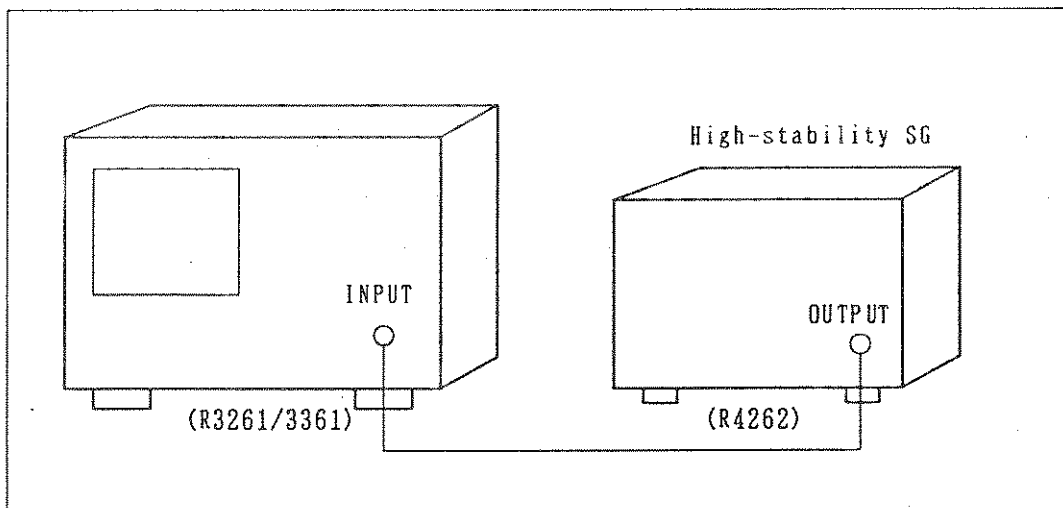

Cont'd

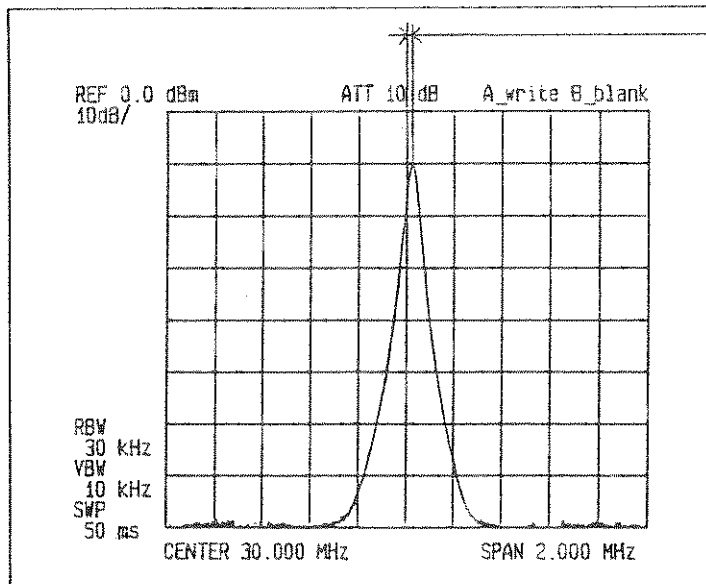

Confirm that the position of the spectrum peak is within the specification

4.3 Testing Stability of Frequency Span

Procedure

- ① From the preset condition, set the spectrum analyzer as follows:

CENTER FREQ : 1GHz
FREQ SPAN : 2GHz

- ② Input to the spectrum analyzer a 2GHz, -10dBm signal from an external signal generator.

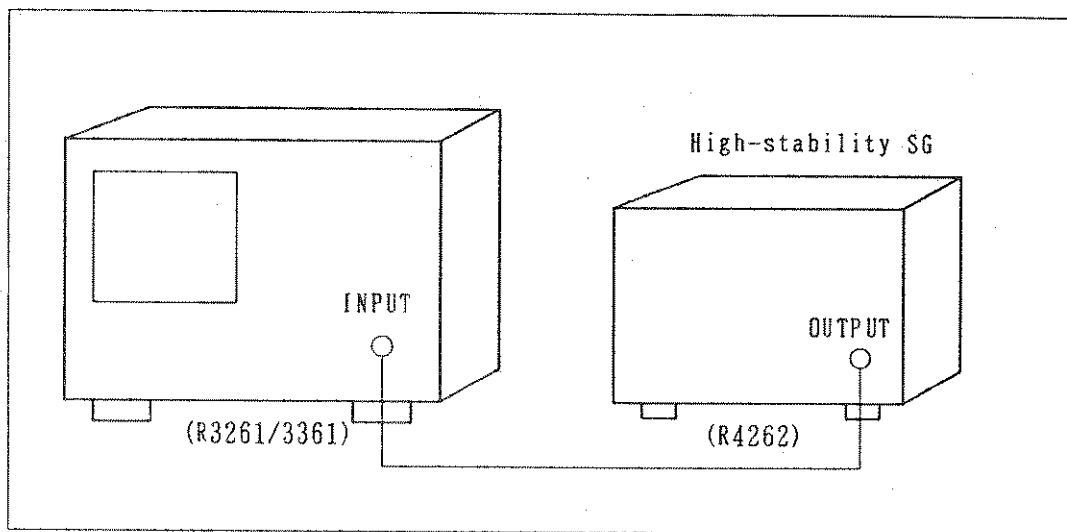

- ③ Adjust the CENTER FREQ so that the zero spectrum is at the left end of the scale.
- ④ Confirm that the difference between the 2GHz spectrum and the right scale end is within ± 0.3 div. (within $\pm 3\%$). If not, make adjustments according to the chapter 5. "ADJUSTMENTS" in maintenance manual.

Cont'd

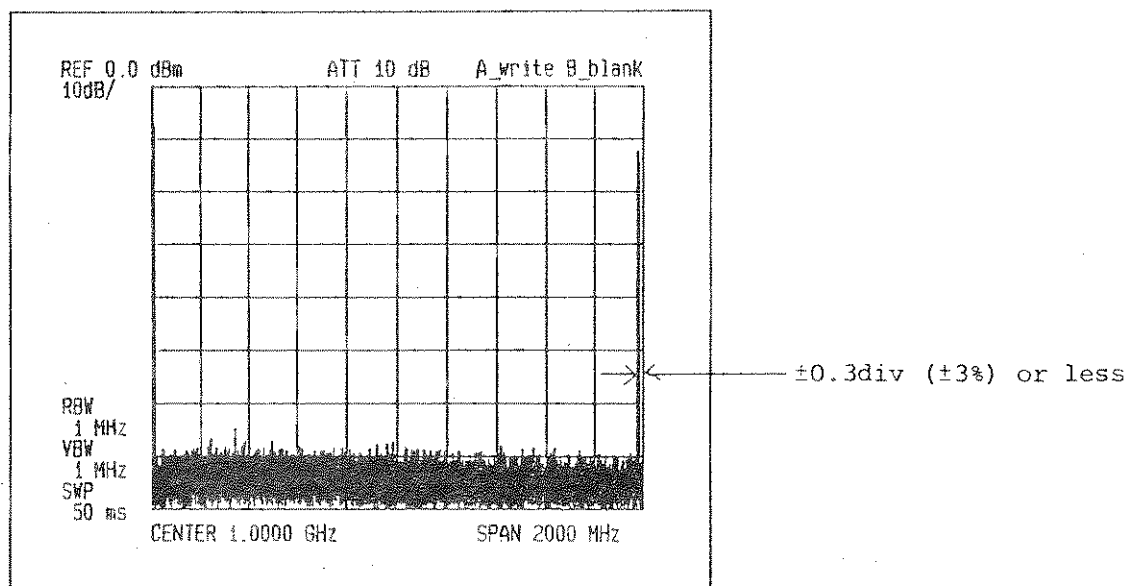

- ⑤ Set the spectrum analyzer as follows:

CENTER FREQ : 5MHz
FREQ SPAN : 10MHz

- ⑥ Adjust the CENTER FREQ so that the peak of the zero spectrum is at the left end of the scale.

- ⑦ Input a 10MHz, -10dBm signal from an external signal generator to the spectrum analyzer. Confirm that the difference between the 10MHz spectrum and the right end of the scale is within $\pm 0.3 \text{ div. } (\pm 3\%)$. If not, make adjustments according to the chapter 5. "ADJUSTMENTS" in maintenance manual.

- ⑧ Set the spectrum analyzer to the following settings:

CENTER FREQ : 1MHz
FREQ SPAN : 2MHz

Then input a 2MHz, -10dBm signal from an external signal generator to the spectrum analyzer. Confirm that the difference between the 2MHz spectrum and the right end of the scale is within $\pm 0.5 \text{ div. } (\pm 5\%)$. If not, make adjustments according to the chapter 5. "ADJUSTMENTS" in maintenance manual.

4.4 Testing LOG Linearity

Procedure

- ① From the preset condition, set the spectrum analyzer as follows:

CENTER FREQ	:	30MHz
SPAN	:	2MHz
RBW	:	300kHz
REF LEVEL	:	-10dBm
dB/div	:	1dB/div

- ② Connect a signal generator to the spectrum analyzer through an external attenuator.

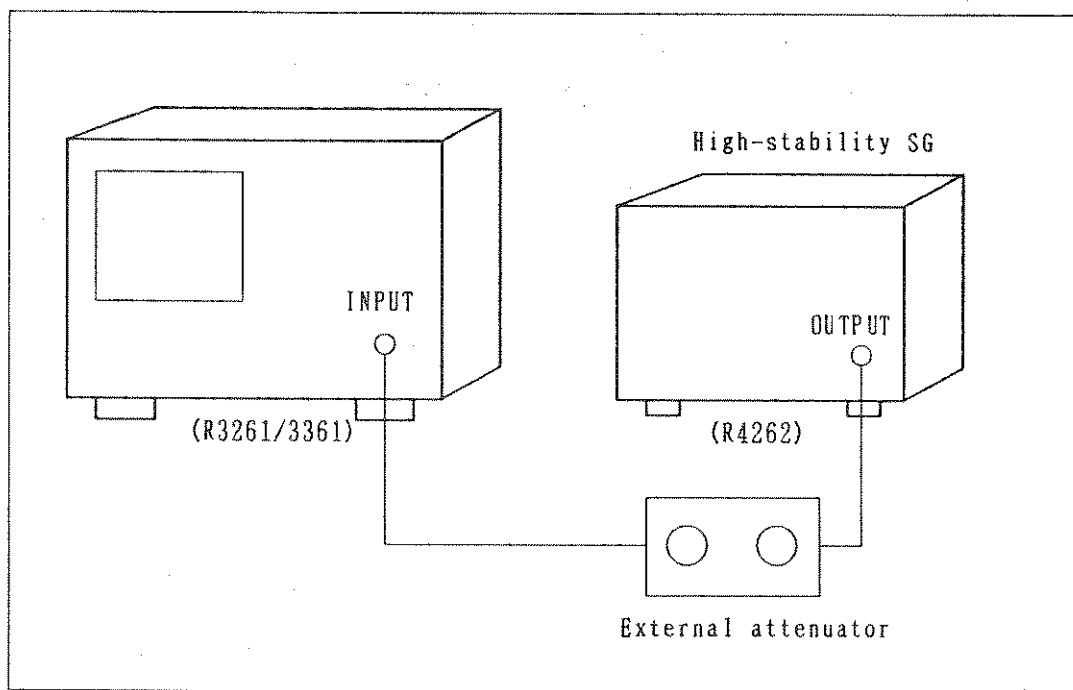

- ③ Input a 30MHz, - 10dBm signal from the signal generator to the spectrum analyzer.
- ④ Adjust the output level of the signal generator so that the spectrum peaks at -10dBm when the attenuator is set to 0dB.
- ⑤ Confirm that the deviation in peak level as read on the screen is within $\pm 0.2\text{dB}$ ($\pm 0.2\text{div}$) while the attenuator setting is incremented by 1dB.

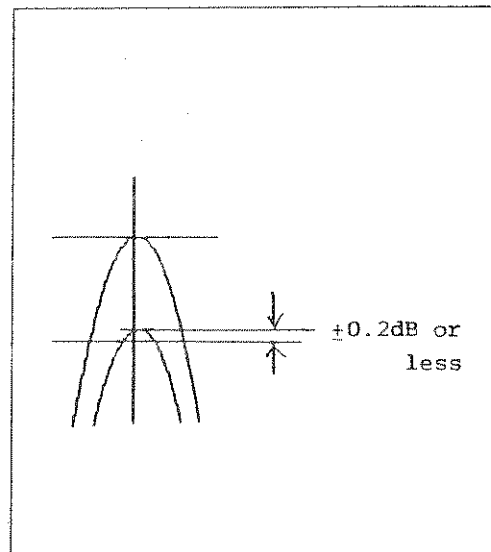
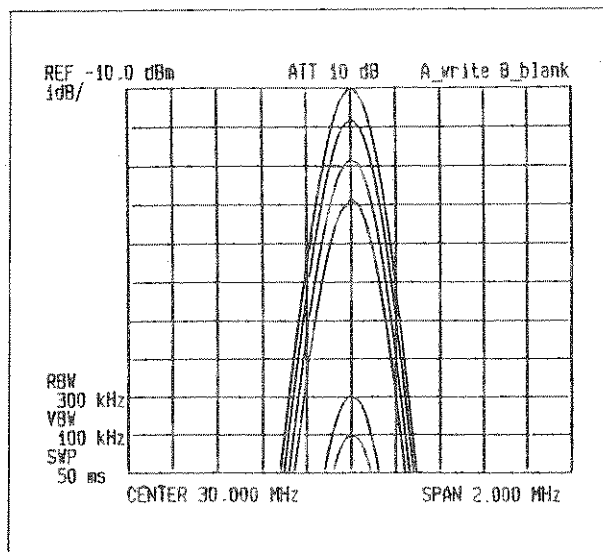

- ⑥ Set the spectrum analyzer to the following settings:

dB/div	:	10dB/
SPAN	:	50kHz
RBW	:	1kHz

- ⑦ Adjust the output level of the signal generator so that the spectrum peaks at -10dBm when the attenuator is set to 0dB.
- ⑧ Confirm that the deviation in peak level as read on the screen is within $\pm 1\text{dB}$ (± 0.1 div) while the attenuator setting is incremented by 10dB.
- ⑨ Confirm that the spectrum peaks at $-80\text{dBm} \pm 1.5\text{dB}$ when the attenuator is set to 70dB. If not, make adjustments according to the chapter 5. "ADJUSTMENTS" in maintenance manual.

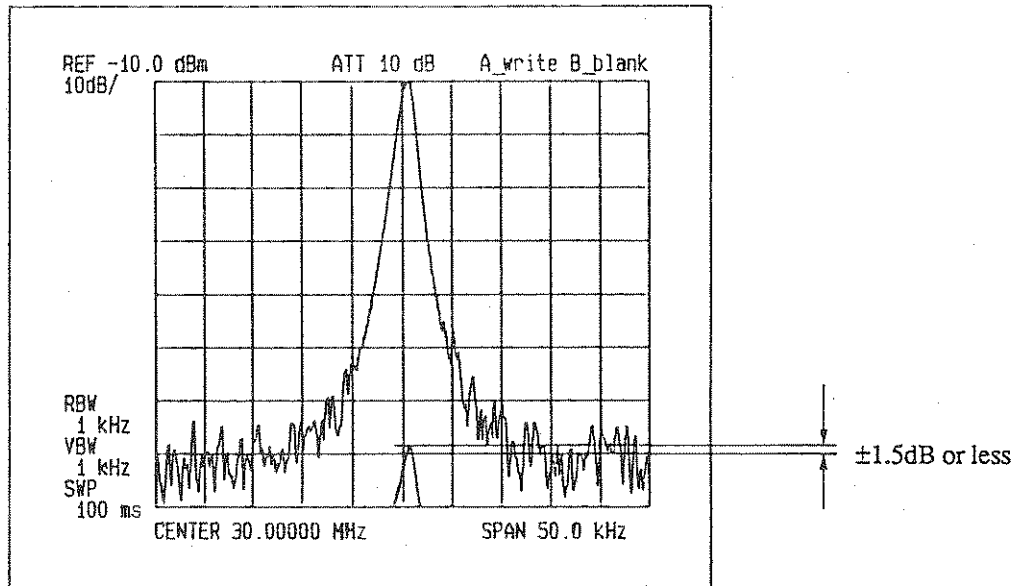

- ⑩ Set the spectrum analyzer to the following settings:

CENTER FREQ : 50MHz
FREQ SPAN : 1kHz
RBW : 30Hz
ATT : -10dBm
12div display

- ⑪ Input a 50MHz, -10dBm signal from the signal generator to the spectrum analyzer.
- ⑫ Adjust the output level of the signal generator so that the spectrum peaks at -10dBm when the attenuator is set to 0dB.
- ⑬ Confirm that the spectrum peaks at -120dBm $\pm 2\text{dB}$ when the attenuator is set to 110dB.

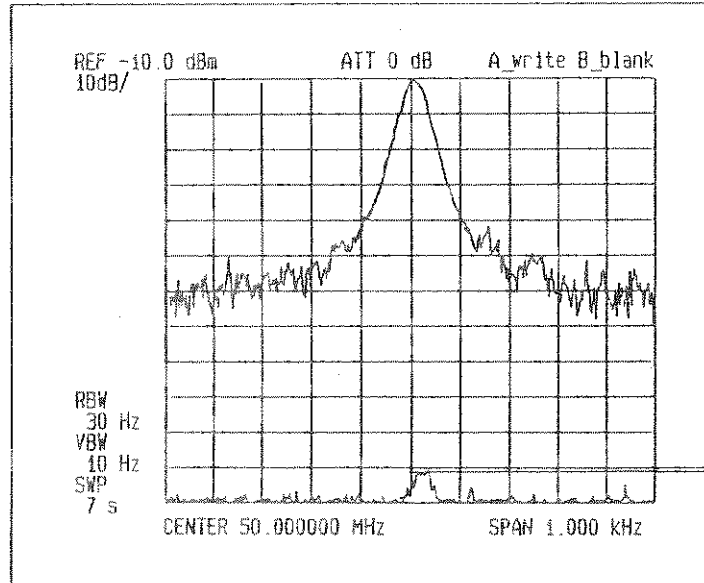

±2dB or less.

4.5 Testing LIN Linearity

Procedure

- ① Set the spectrum analyzer as follows from the preset condition.

CENTER FREQ : 30MHz
SPAN : 2MHz
RBW : 100kHz
REF LEVEL : -10dBm
LINEAR DISPLAY MODE

- ② Connect a signal generator to the spectrum analyzer through an external attenuator.

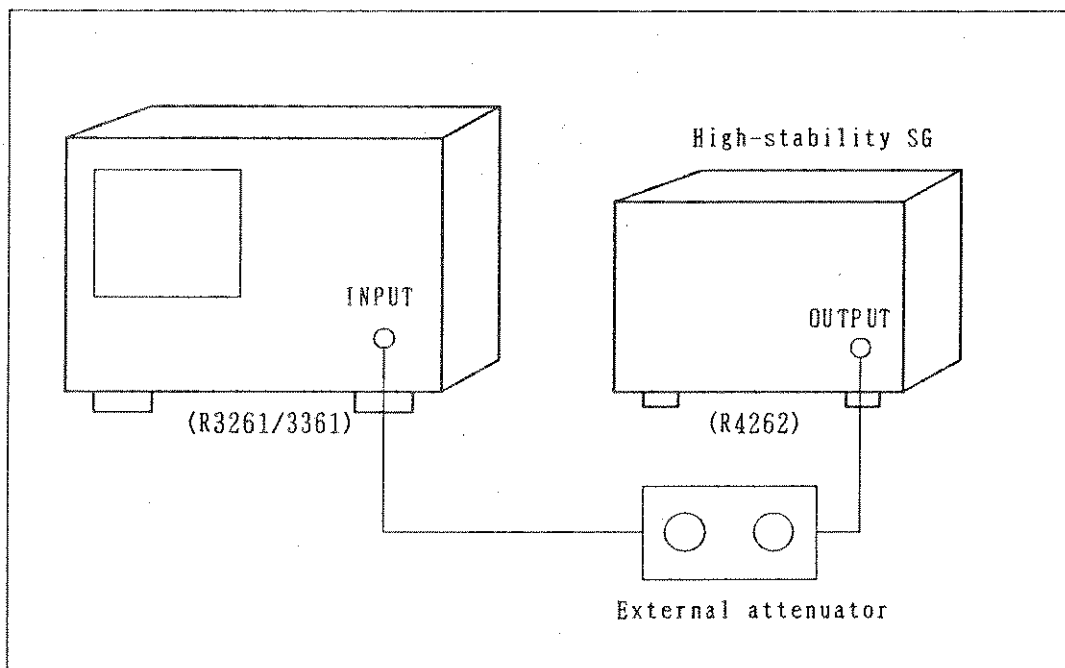

- ③ Set the signal generator so that it puts out a 30MHz, -10dBm signal.
- ④ Adjust the output level of the signal generator so that the spectrum peaks at the uppermost scale on the screen.
- ⑤ Using the marker, read the peak level of the spectrum.
- ⑥ Set the attenuator to 6dB, and read the peak level of the spectrum using the marker.
- ⑦ Obtain the LIN linearity from the values determined in steps ⑤ and ⑥ above. Confirm that the LIN linearity thus obtained is $100 \pm 5\%$.

$$\text{LIN linearity (\%)} = [(\text{value in step ⑥} - \text{value in step ⑤}) / 2] / \text{value in step ⑤} \times 100$$

If the linearity is out of specification, make adjustments according to the chapter 5. "ADJUSTMENTS" in maintenance manual.

4.6 Testing Stability of Reference Level

Procedure

- ① From the preset condition, set the spectrum analyzer as follows:

CENTER FREQ : 30MHz
FREQ SPAN : 5kHz
ATT : 10dB
REF LEVEL : 0dBm

- ② Input a 30MHz, 0dBm signal from a signal generator through an external attenuator to the spectrum analyzer.

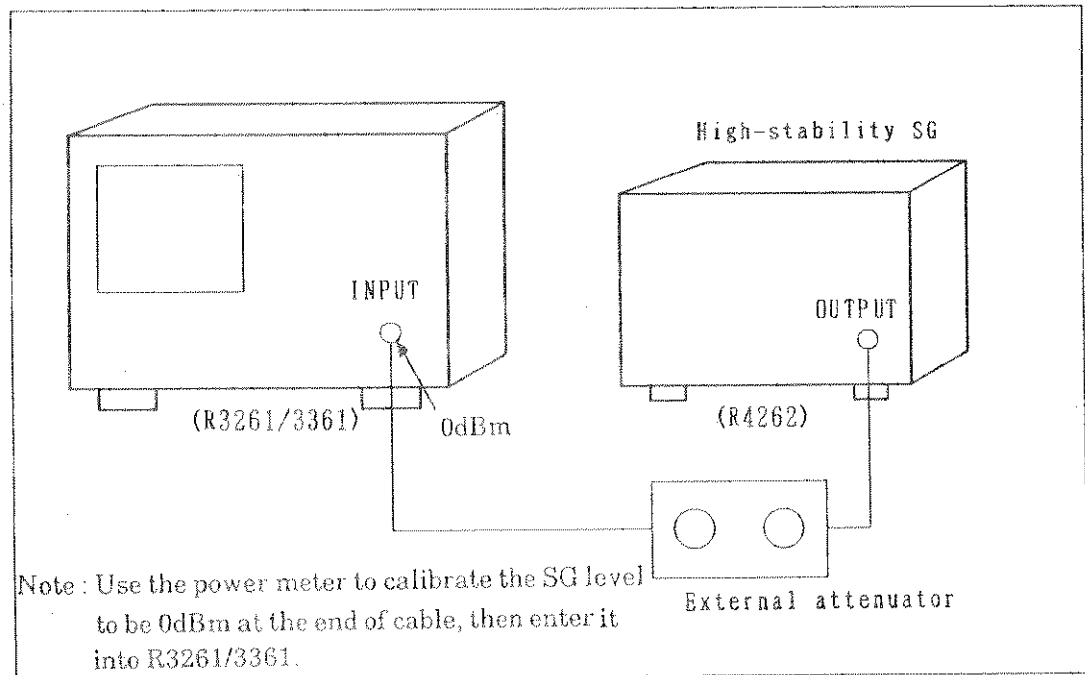

- ③ Set the attenuator to 0dB, and read the peak level of the input waveform using the marker. Confirm that this level is within ± 0.3 dB of the REF LEVEL setting.

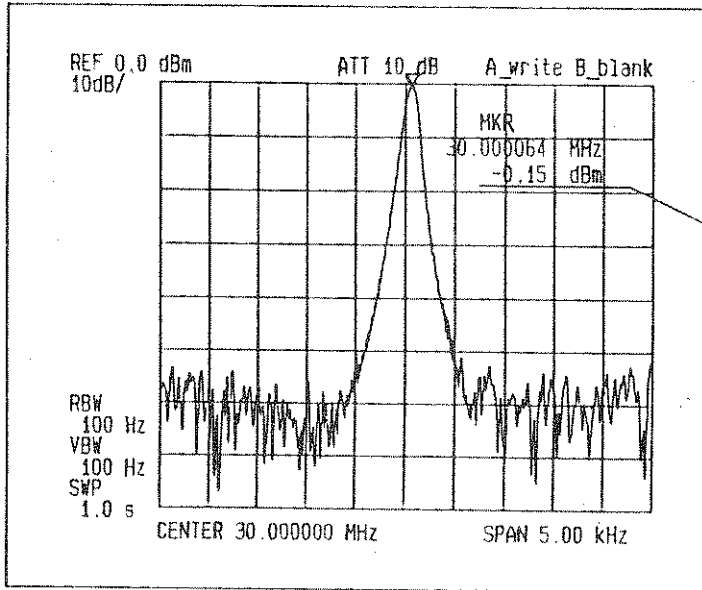

- ④ Change the REF LEVEL and attenuator settings as shown in Table 9 and confirm that the deviation from each setting is within ± 0.3 dB. If not, make adjustments according to the chapter 5. "ADJUSTMENTS" in maintenance manual.

Table 9 REF LEVEL and External Attenuator Settings

REF LEVEL [dBm]	0	-10	-20	-30	-40	-50	-60	-70
External attenuator [dB]	0	10	20	30	40	50	60	70
Specifications [dB]	± 0.3	± 0.3	± 0.3	± 0.3	± 0.3	± 0.3	± 0.7	± 0.7

4.7 Testing Stability of Input Attenuator Changeover

Procedure

- ① Input a 50MHz, -10dBm signal from a signal generator to the spectrum analyzer through an external attenuator set to 40dB.

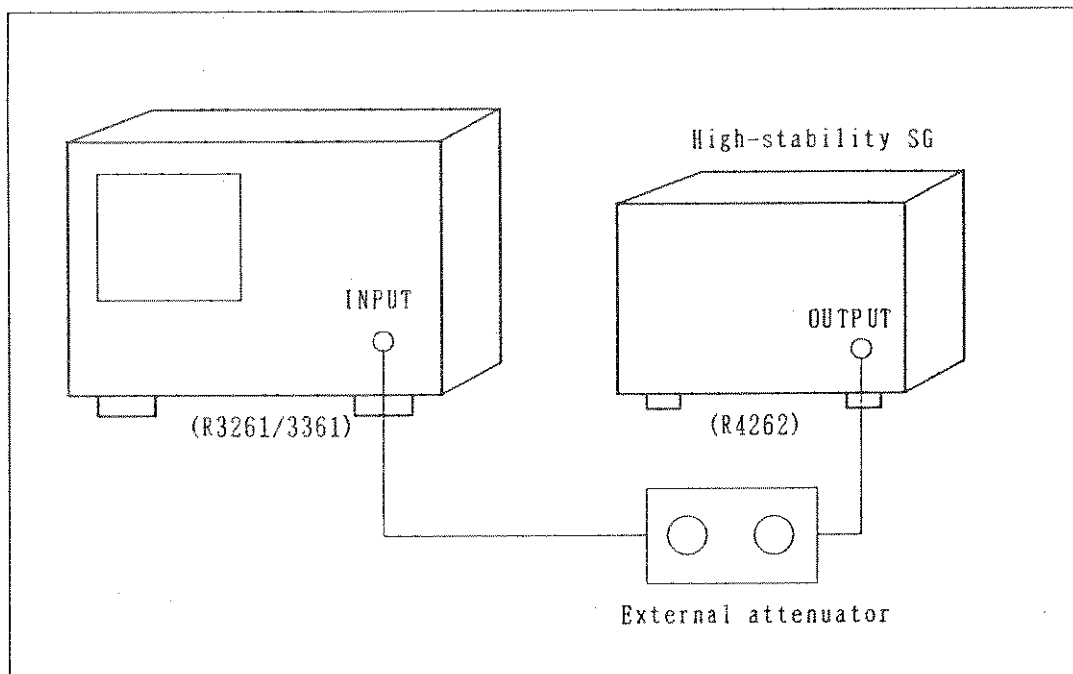

- ② From the preset condition, set the spectrum analyzer as follows:

CENTER FREQ	:	50MHz
FREQ SPAN	:	10kHz
RBW	:	3kHz
ATT	:	10dB
dB/div	:	1dB/
REF LEVEL	:	-45dBm

- ③ Adjust the output level of the signal generator so that the spectrum peaks at the center of the screen.

- ④ Set the external attenuator to 30dB, and set the spectrum analyzer to the following settings:

ATT	:	20dB
REF LEVEL	:	-35dBm

Then confirm that the difference between the current indication and the indication for the 10dB attenuation is with ± 1.0 dB.

Cont'd

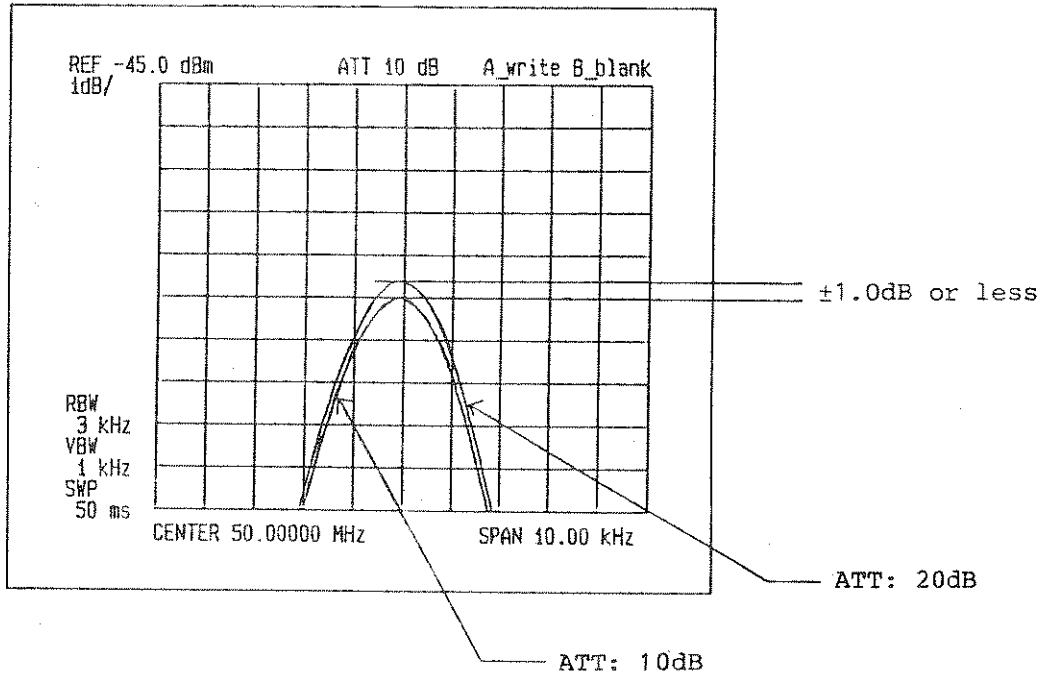

- ⑤ Change the ATT, external attenuator and REF LEVEL settings as shown in Table 10. Confirm that the stability of the input attenuator changeover is within ± 1.0 dB of the 10dB ATT setting.

Table 10 Testing Stability of Input Attenuator Changeover

ATT [dB]	10	20	30	40	50
External attenuator [dB]	40	30	20	10	0
REF LEVEL [dBm]	-45	-35	-25	-15	-5

4.8 Testing Frequency Response

Procedure

- ① Set the spectrum analyzer as follows from the preset condition:

ATT	:	10dB
dB/div	:	1dB/
CENTER FREQ	:	1GHz
SPAN	:	2GHz
REF LEVEL	:	-15dBm

- ② Input a signal of -20dBm at a frequency of between 100kHz and 2GHz to the R3261/3361 and confirm that the deviation as read on the screen for each frequency is within ± 0.5 dB.

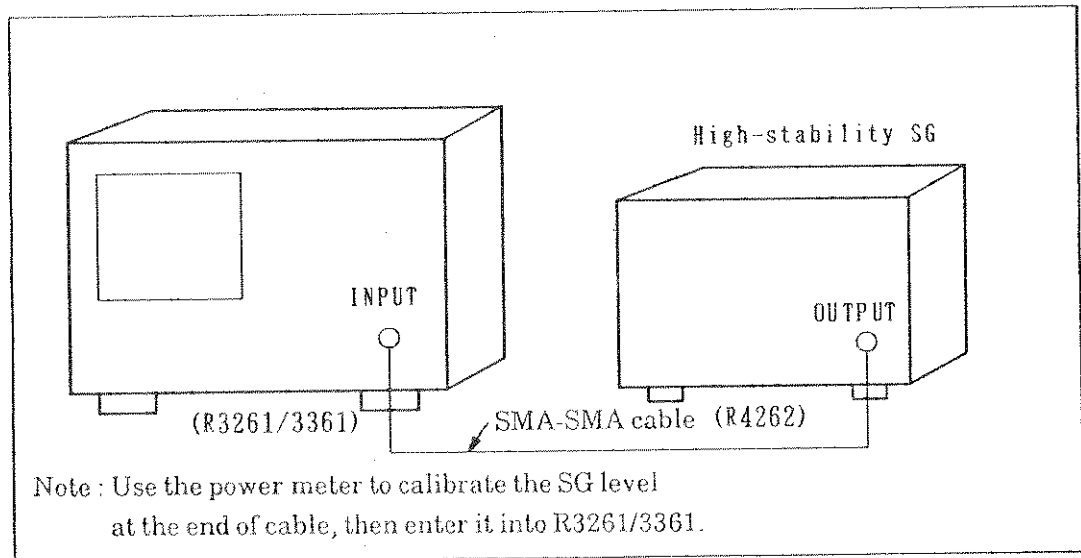

- ③ Set the spectrum analyzer to the following settings:

START FREQ	:	0MHz
STOP FREQ	:	3.6GHz (2.6GHz for R3261C/R3361C)

- ④ Input to the R3261/3361 a signal of -20dBm at a frequency between 9kHz and 3.6GHz (2.6GHz for R3261C/R3361C), and confirm that the deviation as read on the screen for each frequency is within ± 1 dB.

R3261/3361
SPECTRUM ANALYZER

4 Testing Using measuring Equipment

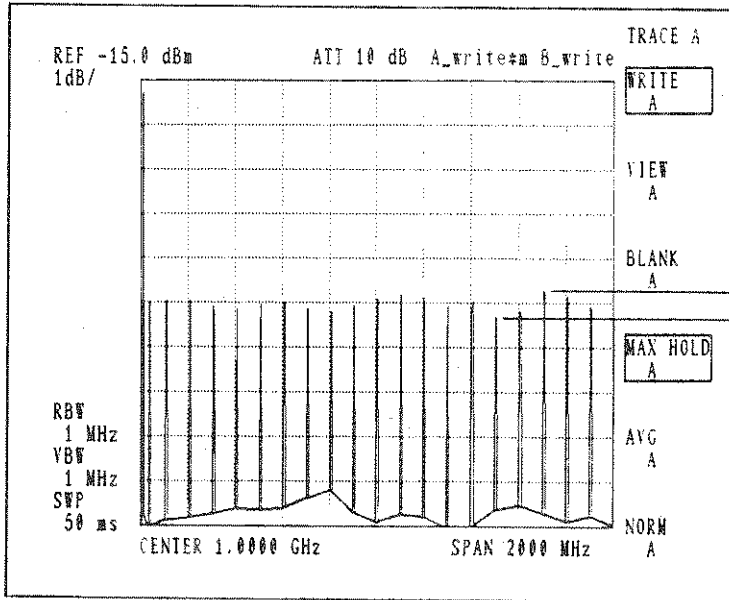

Confirm that the deviation for each frequency is within $\pm 0.5\text{dB}$

4.9 Testing Spurious Response

Procedure

- ① From the preset condition, set the spectrum analyzer as follows:

CENTER FREQ	:	500MHz
FREQ SPAN	:	1000MHz
REF LEVEL	:	-10dBm
RBW	:	1MHz
VBW	:	10kHz
ATT	:	0dB

- ② Input a signal of -10dBm from a low-distortion signal generator to the spectrum analyzer.
A signal from a signal generator with a low-pass filter capable of reducing the level of the second harmonics by at least 60dB will also work.

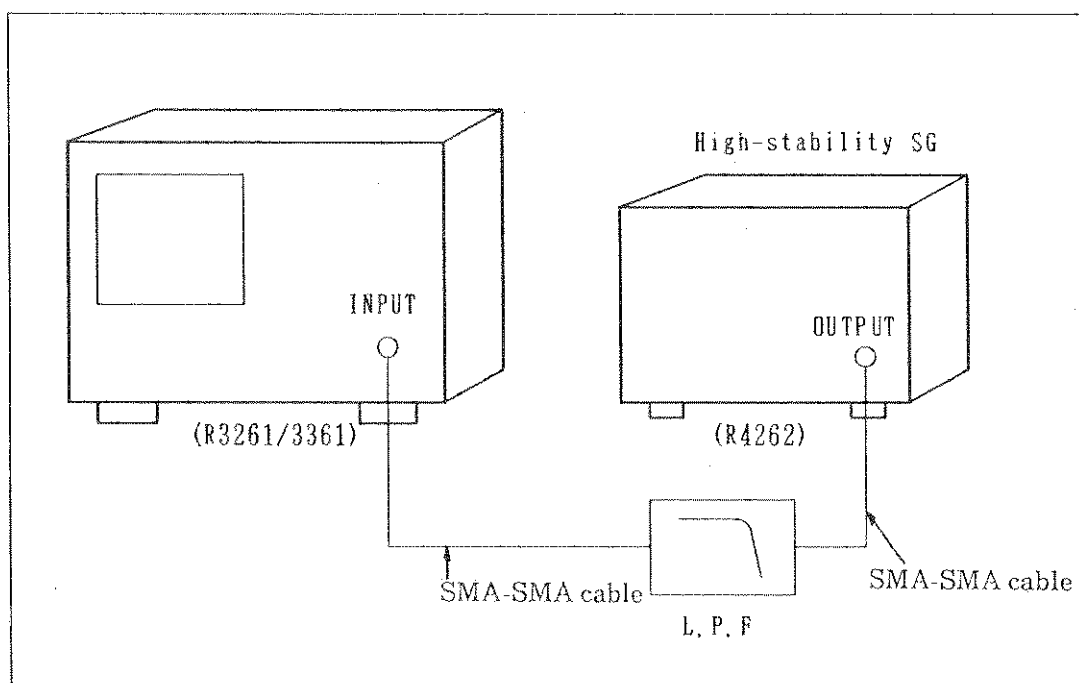

- ③ Change the output frequency of the low-distortion signal generator from 10MHz to 500MHz and confirm that the signal level of the second harmonics is lower than that of the reference waveform by at least 50dB (equivalent to 70dB for -30dBm input).

Cont'd

- ④ For low-distortion signal generator frequencies of 500MHz or over, change the setting of the spectrum analyzer as shown in Table 11.

Table 11 CENTER FREQ AND SPAN for Dynamic Range Test

Frequency [MHz] SG	R3261C/D R3361C/D Set	
	CENTER FREQ [GHz]	SPAN [GHz]
10 to 500	0.5	1
500 to 1000	1.5	1
1000 to 1500 (1300)	2.5	1
1500 to 1800	3.3	0.6

(): R3261C/R3361C

4.10 Testing Stability of Sweep Time

Procedure

- ① Input a 30MHz, -5dBm, amplitude-modulated signal (100Hz, 30% modulation) from the signal generator to the spectrum analyzer.

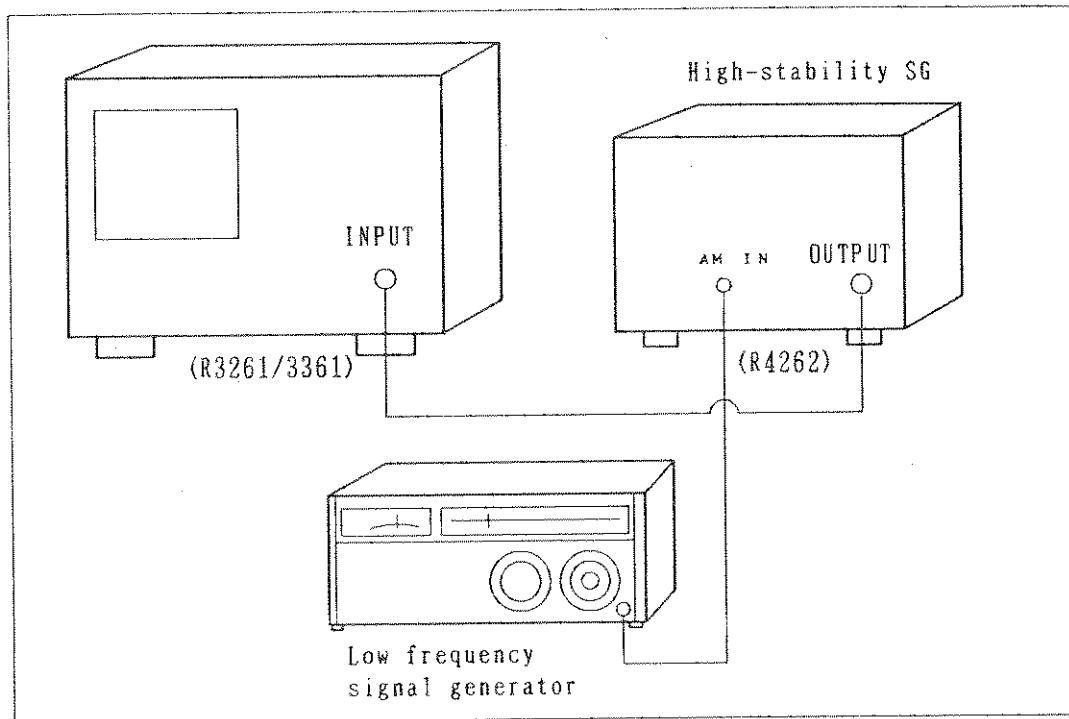

- ② From the preset condition, set the spectrum analyzer as follows:

CENTER FREQ	:	30MHz
SPAN	:	0kHz
RBW	:	30kHz
dB/div	:	1dB
TRIGGER	:	VIDEO
SWEEP TIME	:	50ms

- ③ Confirm that there are 5 cycles $\pm 3/20$ cycles ($\pm 1.5\text{ms}$, $\pm 0.3\text{div.}$) of the amplitude-modulated waveform on the screen.

Cont'd

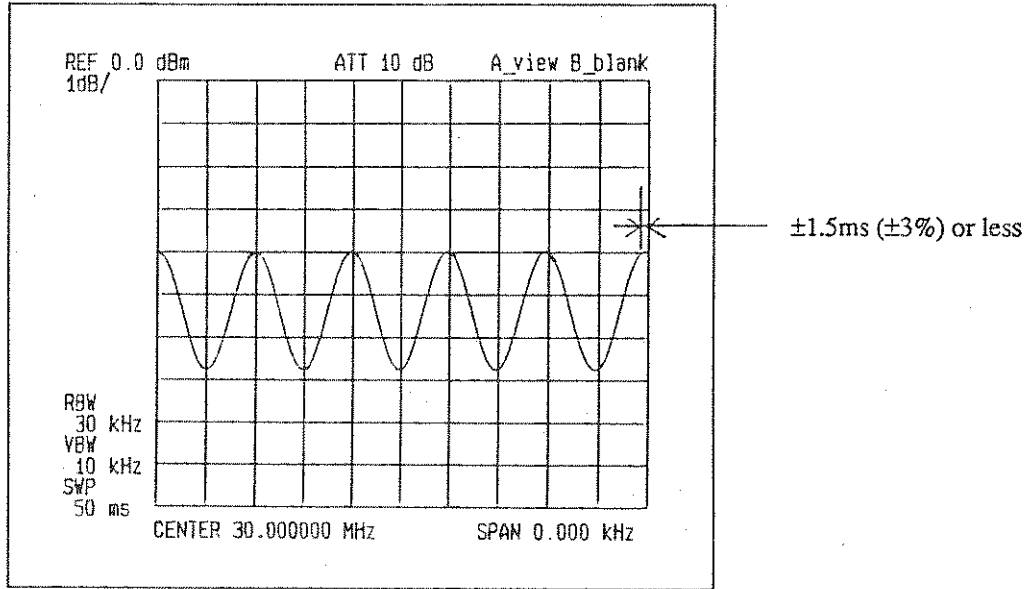

4.11 Testing Stability of TG Output Level (For R3361C/D only)

Procedure

- ① Reset and then set the spectrum analyzer (R3361C/D only) to the following settings:

CENTER FREQ : 30MHz
FREQ SPAN : 0Hz
TG : ON
TG LEVEL : -10dBm

- ② Connect an RF power meter to the spectrum analyzer at the TG OUTPUT to measure the TG output level. Confirm that the TG output level is $-10\text{dBm} \pm 0.5\text{dB}$. If not, make adjustments according to the chapter 5. "ADJUSTMENTS" in maintenance manual.

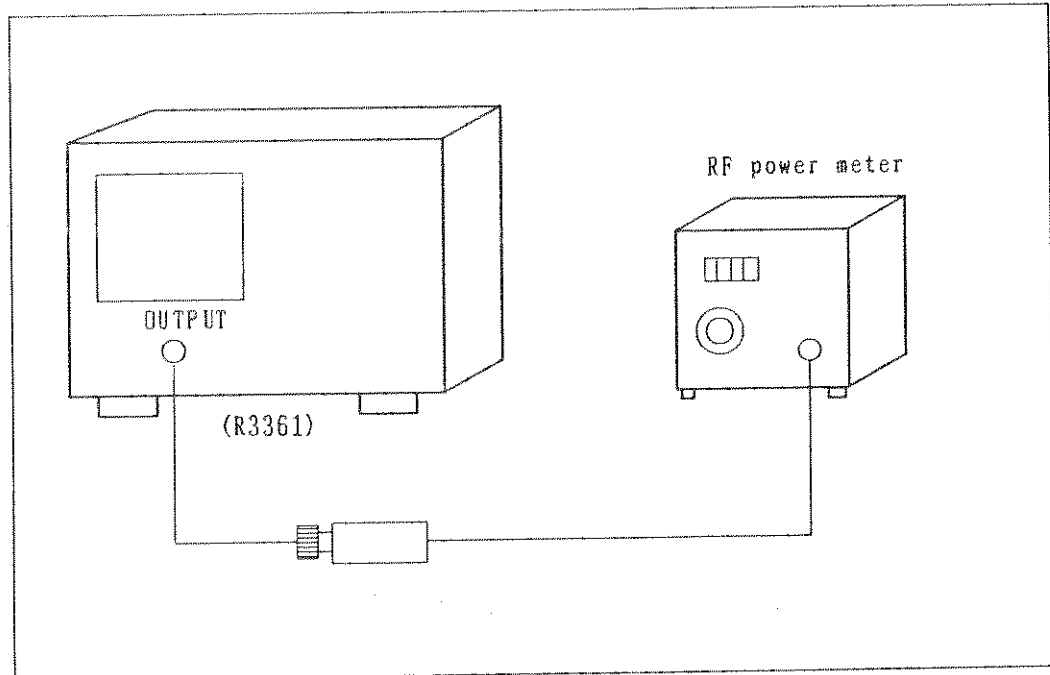

4.12 Testing TG Frequency Response (for R3361C/D only)

Procedure

- ① Reset and then set the spectrum analyzer (R3361C/D only) to the following settings:

CENTER FREQ : 30MHz
FREQ SPAN : 0Hz
TG : ON
TG LEVEL : -10dBm

- ② Connect an RF power meter with the spectrum analyzer at the TG output.
- ③ Confirm that the TG output level is $\pm 0.7\text{dB}$ for the output level in CENTER FREQ of 30MHz when the CENTER FREQ of the R3361C/D is changed in a range of 100kHz to 1.0GHz.

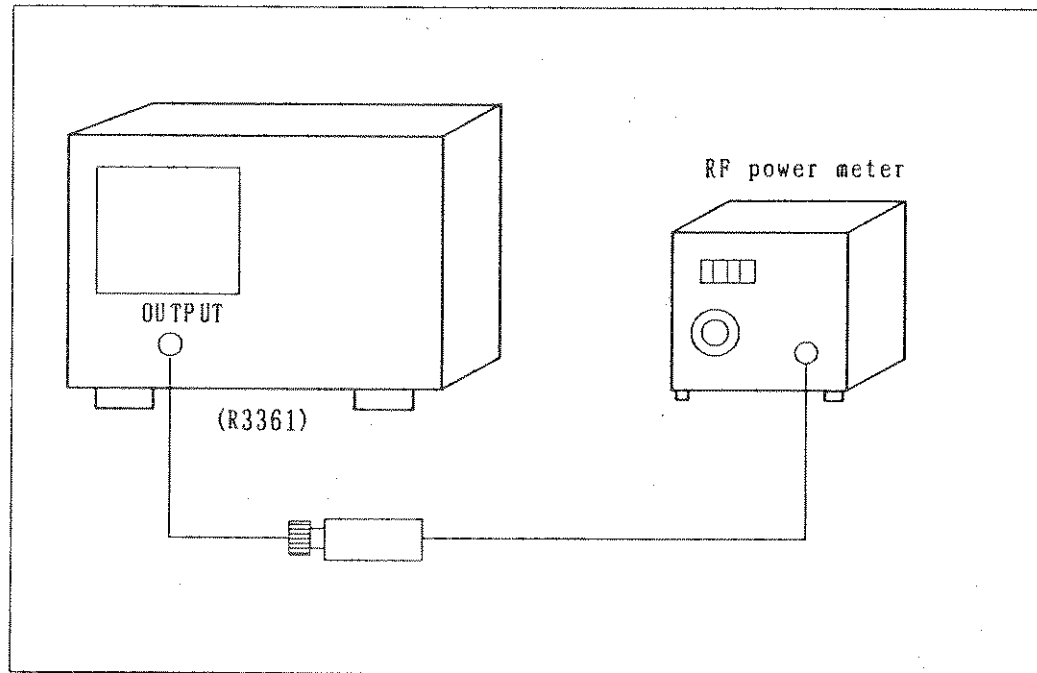

- ④ Confirm that the TG output level is $\pm 1.5\text{dB}$ for the output level in CENTER FREQ of 30MHz when the CENTER FREQ of the R3361C/D is changed in a range of 9kHz to 2.6GHz.
- ⑤ Confirm that the TG output level is $\pm 2.0\text{dB}$ for the output level in CENTER FREQ of 30MHz when the CENTER FREQ of the R3361C/D is changed in a range of 9kHz to 3.6GHz.

4.13 Testing Stability of TG Output Level Changeover (For R3361C/D only)

Procedure

① Reset and then set the spectrum analyzer (R3361C/D only) to the following settings:

CENTER FREQ : 30MHz
FREQ SPAN : 0Hz
TG : ON
TG LEVEL : -10dBm

② Connect an RF power meter to the spectrum analyzer to measure the TG output level.

③ Set the TG LEVEL to -15dBm, and take reading on power meter.

④ Confirm that the difference between the readings of steps③and④above is 5dB±1dB.

⑤ For a range from 0dBm to -50dBm of the TG output level, test according to Table 12.

Table 12 Stability of TG output Level Changeover

TG LEVEL [dBm]	0	-5	-10	-15	-20	-25	-30	-35	-40	-45	-50
Output level difference at -10dBm setting	+10 ±1	+5 ±1	0	-5 ±1	-10 ±1	-15 ±1	-20 ±1	-25 ±1	-30 ±1	-35 ±1	-40 ±1

⑥ Perform steps ② to ④ for 1.5GHz and 3.0GHz center frequencies. The deviations for 1.5GHz and 3.0GHz must be within ±2dB and ±3dB respectively.

4.14 Testing Output Spurious (For R3361C/D only)

Procedure

- ① Reset and then set the spectrum analyzer (R3361C/D only) to the following settings:

CENTER FREQ : 30MHz
FREQ SPAN : 0Hz
TG : ON
TG LEVEL : 0dBm

- ② Connect an external spectrum analyzer to the R3361C/D at the TG OUTPUT.

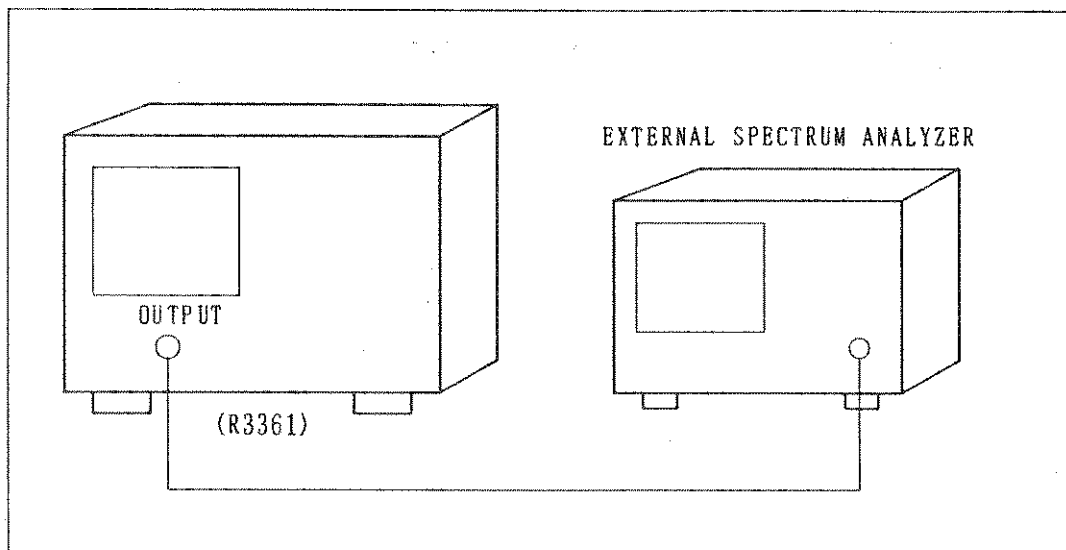

- ③ Change the center frequency to up to 3.6GHz for the R3361D, or 2.6GHz for the R3361C, and confirm that the harmonics spurious is lower than the basic waveform by at least -20dBc and that the non-harmonics spurious is lower by at least -30dBc.

4.15 Testing TG Leak (For R3361C/D only)

Procedure

- ① Reset and then set the spectrum analyzer (R3361C/D only) to the following settings:

REF LEVEL	:	-80dBm
SWP TIME	:	50sec
RBW	:	100Hz
VBW	:	1Hz
ATT	:	0dB
TG	:	ON
TG LEVEL	:	0dBm

- ② Execute the TG FREQ CAL (AUTO) to compensate for any tracking error. Make no connection to the INPUT or TG OUTPUT connector.
- ③ Confirm that TG leak is not more than -110dBm for up to 3GHz, and not more than -100dBm for up to 3.6GHz.

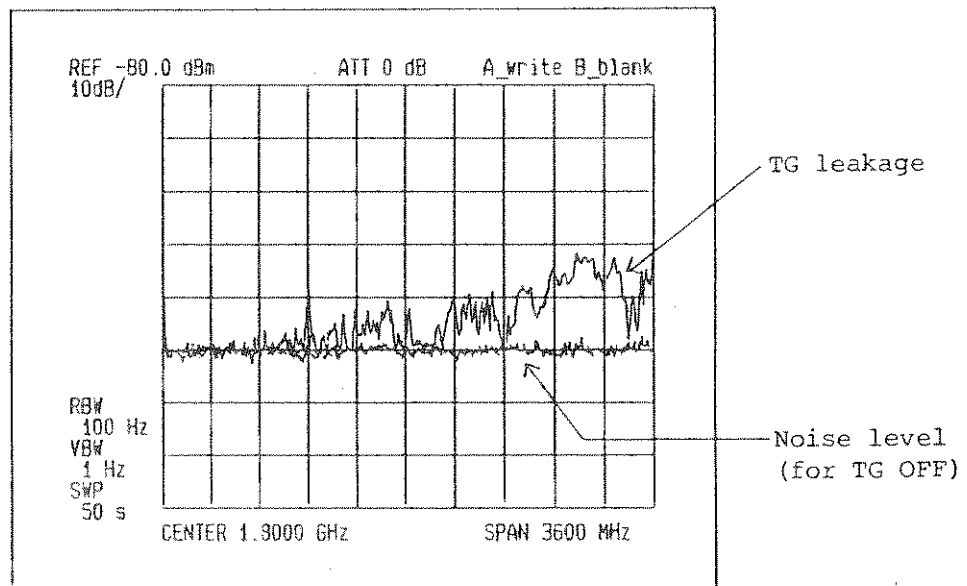

5 Test Report

The test report form for the spectrum analyzer is given below.

R3261C/D R3361C/D Test Report

Item		Specification	Measurement
1. CAL signal test			
1. CAL signal level		-20dBm ± 0.3dB	dBm
2. Test using CAL signals			
1. Noise side band	20kHz offset	-105dBc/Hz	dBc/Hz
2. Frequency drift		300Hz/min	
3. Stability of resolution bandwidth (3dB bandwidth)	RBW 1MHz	± 20%	%
	RBW 300kHz		%
	RBW 3kHz		%
4. Resolution bandwidth selectivity (60dB : 3dB)	RBW 1MHz	15 : 1	:
	RBW 300kHz		:
	RBW 3kHz		:
5. QP bandwidth stability (6dB bandwidth)	QP 120kHz	110kHz to 130kHz	kHz
	QP 9kHz	8kHz to 10kHz	kHz
	QP 200Hz	170Hz to 220Hz	Hz
6. Marker indication stability (normal mode)	SPAN 20MHz	± 1.05MHz	MHz
	SPAN 10MHz	± 550kHz	kHz
	SPAN 2MHz	± 160kHz	kHz
7. Marker indication stability (counter mode)	SPAN 20Hz	± 1Hz	Hz
8. Average noise level		-121dBm + 1.55f	dBm
9. Residual response		-100dBm	dBm
10. Switchover stability of resolution bandwidth		± 0.3dB	dB

R3261C/D R3361C/D Test Report (Cont'd)

Item		Specification	Measurement
3. Test Using measuring equipment			
1. Reference oscillator stability		$\pm 2 \times 10^{-8}$	x10
2. Center frequency stability	SPAN 20MHz	$\pm 450\text{kHz}$	kHz
	SPAN 10MHz	$\pm 250\text{kHz}$	kHz
	SPAN 2MHz	$\pm 60\text{kHz}$	kHz
	SPAN 1kHz	$\pm 50\text{Hz}$	Hz
3. Frequency span stability	SPAN 2GHz	$\pm 3\%$	%
	SPAN 10MHz	$\pm 3\%$	%
	SPAN 2MHz	$\pm 5\%$	%
4. LOG linearity		$\pm 0.2\text{dB}/1\text{dB}$	dB
		$\pm 1.0\text{dB}/10\text{dB}$	dB
		$\pm 1.5\text{dB}/70\text{dB}$	dB
		$\pm 2.0\text{dB}/110\text{dB}$	dB
5. LIN linearity		$\pm 5\%$ of Full Scale	%
6. Reference level stability	REF 0dBm to -50dBm	$\pm 0.3\text{dB}$	dB
	REF -60dBm to -70dBm	$\pm 0.7\text{dB}$	dB
7. Input attenuator changeover stability		$\pm 1.0\text{dB}$	dB
8. Frequency response	100kHz to 2GHz	$\pm 0.5\text{dB}$	dB
	9kHz to 3.6GHz	$\pm 1\text{dB}$	dB
9. Spurious response	-10dBm INPUT	-50dBc	dBc
10. Sweep time stability		$\pm 3\%$	%
11. TG output level stability		$\pm 0.5\text{dB}$	dB

R3261C/D R3361C/D Test Report (Cont'd)

Item		Specification	Measurement
12. TG output frequency response	100kHz to 1GHz	$\pm 0.7\text{dB}$	dB
	9kHz to 2.6GHz	$\pm 1.5\text{dB}$	dB
	9kHz to 3.6GHz	$\pm 2.0\text{dB}$	dB
13. Stability of TG output level changeover	100kHz to 1GHz	$\pm 1.0\text{dB}$	dB
	9kHz to 2.6GHz	$\pm 2.0\text{dB}$	dB
	9kHz to 3.6GHz	$\pm 3.0\text{dB}$	dB
14. Output spurious	Harmonics spurious	-20dB	dB
	Non-harmonic spurious	-30dB	dB
15. TG leakage	to 3.0GHz	-110dBm	dBm
	to 3.6GHz	-100dBm	dBm

WARRANTY

ADVANTEST product is warranted against defects in material and workmanship for a period of one year from the date of delivery to original buyer.

LIMITATION OF WARRANTY

The foregoing warranty shall not apply to defects resulting from improper or inadequate maintenance by buyer, unauthorized modification or misuse, accident or abnormal conditions of operations.

No other warranty is expressed or implied. ADVANTEST specifically disclaims the implied warranties of merchantability and fitness for a particular purpose.

ADVANTEST shall not be liable for any special incidental or consequential damages, whether in contract, tort or otherwise.

Any and all warranties are revoked if the product is removed from the country in which it was originally purchased.

SERVICE

During the warranty period, ADVANTEST will, at its option, either repair or replace products which prove to be defective.

When trouble occurs, buyer should contact his local supplier or ADVANTEST giving full details of the problem and the model name and serial number.

For the products returned to ADVANTEST for warranty service, buyer shall prepay shipping and transportation charges to ADVANTEST and ADVANTEST shall pay shipping and transportation charges to return the product to buyer. However, buyer shall pay all charges, duties, and taxes incurred in his country for products returned from ADVANTEST.

CLAIM FOR DAMAGE IN SHIPMENT TO ORIGINAL BUYER

The product should be thoroughly inspected immediately upon original delivery to buyer. All material in the container should be checked against the enclosed packing list or the instruction manual alternatively. ADVANTEST will not be responsible for shortage unless notified immediately.

If the product is damaged in any way, a claim should be filed by the buyer with carrier immediately. (To obtain a quotation to repair shipment damage, contact ADVANTEST or the local supplier.) Final claim and negotiations with the carrier must be completed by buyer.

SALES & SUPPORT OFFICES

Advantest America, Inc.
300 Knightsbridge Parkway Suite 200, Lincolnshire,
IL 60069 U.S.A.
Phone (708)634-2552
Facsimile (708)634-2872

Advantest UK Limited
CI Tower, St. Georges Square, High Street,
New Malden Surrey, KT3 4HH The United Kingdom
Phone (081)336-1606
Facsimile (081)336-1657

Advantest (Singapore) Pte. Ltd.
150 Beach Road, #01-00
Gateway West Singapore 0718
Phone (65)299-4268
Facsimile (65)299-4226

Advantest Giga S.A.
5, Av du Quebec Z.A. de Courtaboeuf
B.P.203-91941 Les Ulis Cedex, France
Phone (331)6918-2500
Facsimile (331)6982-9224

ADVANTEST[®]
ADVANTEST CORPORATION