ADVANTEST[®]
ADVANTEST CORPORATION

***R3267 Series OPT63
GSM/DECT
Measurement Option
Operation Manual***

MANUAL NUMBER FOE-8335241F00

Applicable models

***R3264
R3267
R3273***

Safety Summary

To ensure thorough understanding of all functions and to ensure efficient use of this instrument, please read the manual carefully before using. Note that Advantest bears absolutely no responsibility for the result of operations caused due to incorrect or inappropriate use of this instrument.

If the equipment is used in a manner not specified by Advantest, the protection provided by the equipment may be impaired.

- **Warning Labels**

Warning labels are applied to Advantest products in locations where specific dangers exist. Pay careful attention to these labels during handling. Do not remove or tear these labels. If you have any questions regarding warning labels, please ask your nearest Advantest dealer. Our address and phone number are listed at the end of this manual.

Symbols of those warning labels are shown below together with their meaning.

DANGER: Indicates an imminently hazardous situation which will result in death or serious personal injury.

WARNING: Indicates a potentially hazardous situation which will result in death or serious personal injury.

CAUTION: Indicates a potentially hazardous situation which will result in personal injury or a damage to property including the product.

- **Basic Precautions**

Please observe the following precautions to prevent fire, burn, electric shock, and personal injury.

- Use a power cable rated for the voltage in question. Be sure however to use a power cable conforming to safety standards of your nation when using a product overseas.
- When inserting the plug into the electrical outlet, first turn the power switch OFF and then insert the plug as far as it will go.
- When removing the plug from the electrical outlet, first turn the power switch OFF and then pull it out by gripping the plug. Do not pull on the power cable itself. Make sure your hands are dry at this time.
- Before turning on the power, be sure to check that the supply voltage matches the voltage requirements of the instrument.
- Be sure to plug the power cable into an electrical outlet which has a safety ground terminal. Grounding will be defeated if you use an extension cord which does not include a safety ground terminal.
- Be sure to use fuses rated for the voltage in question.
- Do not use this instrument with the case open.
- Do not place objects on top of this product. Also, do not place flower pots or other containers containing liquid such as chemicals near this product.

Safety Summary

- When the product has ventilation outlets, do not stick or drop metal or easily flammable objects into the ventilation outlets.
- When using the product on a cart, fix it with belts to avoid its drop.
- When connecting the product to peripheral equipment, turn the power off.

- **Caution Symbols Used Within this Manual**

Symbols indicating items requiring caution which are used in this manual are shown below together with their meaning.

DANGER: Indicates an item where there is a danger of serious personal injury (death or serious injury).

WARNING: Indicates an item relating to personal safety or health.

CAUTION: Indicates an item relating to possible damage to the product or instrument or relating to a restriction on operation.

- **Safety Marks on the Product**

The following safety marks can be found on Advantest products.

 : ATTENTION - Refer to manual.

 : Protective ground (earth) terminal.

 : DANGER - High voltage.

 : CAUTION - Risk of electric shock.

- **Replacing Parts with Limited Life**

The following parts used in the instrument are main parts with limited life.

Replace the parts listed below after their expected lifespan has expired.

Note that the estimated lifespan for the parts listed below may be shortened by factors such as the environment where the instrument is stored or used, and how often the instrument is used.

The parts inside are not user-replaceable. For a part replacement, please contact the Advantest sales office for servicing.

There is a possibility that each product uses different parts with limited life. For more information, refer to Chapter 1.

Main Parts with Limited Life

Part name	Life
Unit power supply	5 years
Fan motor	5 years
Electrolytic capacitor	5 years
LCD display	6 years
LCD backlight	2.5 years
Floppy disk drive	5 years

- **Hard Disk Mounted Products**

The operational warnings are listed below.

- Do not move, shock and vibrate the product while the power is turned on. Reading or writing data in the hard disk unit is performed with the memory disk turning at a high speed. It is a very delicate process.
- Store and operate the products under the following environmental conditions.
 - An area with no sudden temperature changes.
 - An area away from shock or vibrations.
 - An area free from moisture, dirt, or dust.
 - An area away from magnets or an instrument which generates a magnetic field.
- Make back-ups of important data. The data stored in the disk may become damaged if the product is mishandled. The hard disc has a limited life span which depends on the operational conditions. Note that there is no guarantee for any loss of data.

- **Precautions when Disposing of this Instrument**

When disposing of harmful substances, be sure dispose of them properly with abiding by the state-provided law.

- Harmful substances:
- (1) PCB (polycarbon biphenyl)
 - (2) Mercury
 - (3) Ni-Cd (nickel cadmium)
 - (4) Other
 - Items possessing cyan, organic phosphorous and hexadic chromium and items which may leak cadmium or arsenic (excluding lead in solder).

Example: fluorescent tubes, batteries

Environmental Conditions

This instrument should be only be used in an area which satisfies the following conditions:

- An area free from corrosive gas
- An area away from direct sunlight
- A dust-free area
- An area free from vibrations

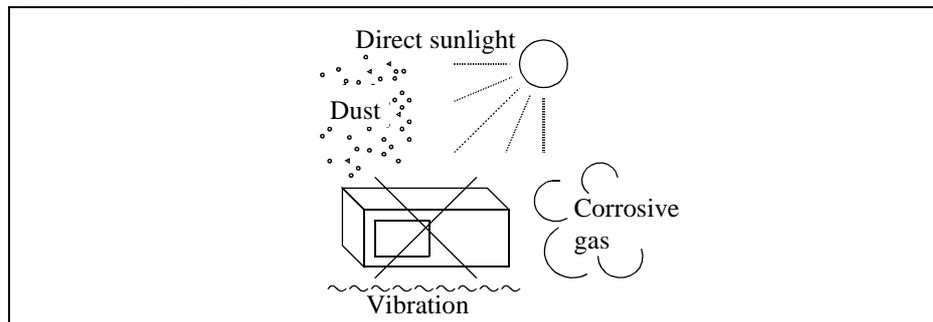

Figure-1 Environmental Conditions

- Operating position

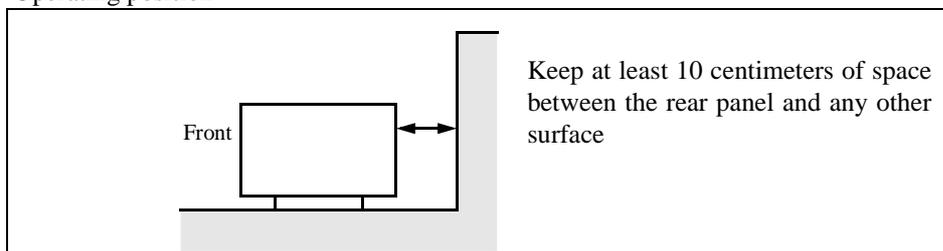

Figure-2 Operating Position

- Storage position

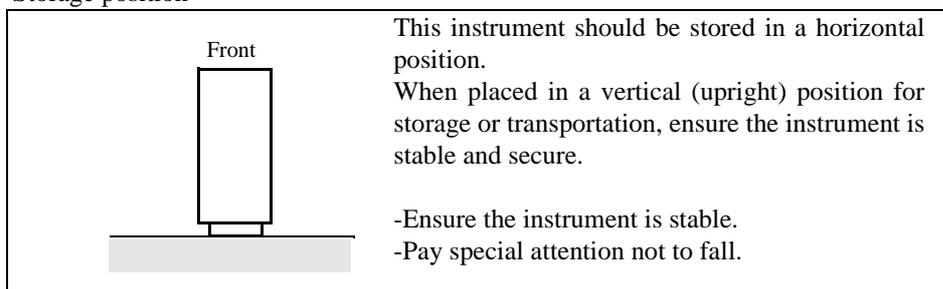

Figure-3 Storage Position

This instrument can be used safely under the following conditions:

- Altitude of up to 2000 m
- Installation Categories II
- Pollution Degree 2

PREFACE

This manual provides the information necessary to check functionality, operate and program the R3267 Series Option 63, GSM/DECT measurement.

1. Organization of this manual

This manual consists of the following chapters:

Safety Summary	To use the analyzer safely, be sure to read this manual first.
1. Introduction <ul style="list-style-type: none"> • Product Description (Option) • Standard Accessories • Self Test Error • Connectors on the rear panel 	Includes a description of the option and its' parts and a self test error.
2. Operation	You can learn the basic operations of the option through the examples shown in this chapter.
3. Reference <ul style="list-style-type: none"> • Menu Index • Menu Map • Functional Description 	Shows a list of operation keys, and describes the function of each key.
4. Remote Control <ul style="list-style-type: none"> • GPIB 	Included are a list of commands necessary for programming.
5. Technical Information <ul style="list-style-type: none"> • Filter settings on GSM/DECT. • On DECT, Bit Sequence setting and a measurement of UP/DOWN LINK Signal. • On GSM, measurements of MULTI-BURST Signal and Phase Error. • Template function • Block diagram 	Describes the principle of operation necessary for taking measurements more accurately.
6. Performance Verification Test	Describes how to test performance.
7. Specifications	Shows the specifications of the option.
APPENDIX <ul style="list-style-type: none"> • Messages 	If an error occurs during operation, an error number and its corresponding error message are displayed. The meaning of each error is explained in this section.

PREFACE

2. Typeface conventions used in this manual

- Panel keys and soft keys are printed in a contrasting typeface to make them stand out from the text as follows:

Panel keys: Boldface type

Example: **FREQ, TRANSIENT**

Soft keys: Boldface and italic type

Example: ***Center, Detector***

- When a series of key operations are described using a comma between two keys.
- There are various soft menus used to switch between two states such as ON/OFF and AUTO/MNL.
- For example, when turning off the *Average Times ON/OFF* function, the annotation “*Average Times ON/OFF*(OFF)” is used.
When switching the ***RBW AUTO/MNL*** function to MNL, the annotation “***RBW AUTO/MNL***(MNL)” is used.

TABLE OF CONTENTS

1	INTRODUCTION	1-1
1.1	Product Overview	1-1
1.2	Accessories	1-1
1.3	Self Test Function	1-1
1.4	About Calibration	1-1
1.5	Explanation of the Connectors	1-2
2	OPERATION	2-1
2.1	Measuring Multi-burst Signals (No External Triggers Available)	2-1
2.2	Measuring the Multi-Burst Signals (Using an External Trigger)	2-6
3	REFERENCE	3-1
3.1	Menu Index	3-1
3.2	Menu Map	3-7
3.3	Functional Description	3-28
3.3.1	Switching Communication Systems	3-29
3.3.2	T-Domain	3-29
3.3.2.1	Power (T-Domain)	3-30
3.3.2.2	ON/OFF Ratio	3-33
3.3.2.3	Spurious (T-Domain)	3-36
3.3.2.4	Due to Modulation (T-Domain)	3-38
3.3.3	F-Domain	3-41
3.3.3.1	Power (F-Domain)	3-41
3.3.3.2	OBW	3-45
3.3.3.3	Due to Transient	3-46
3.3.3.4	Due to Modulation	3-49
3.3.3.5	Inband Spurious	3-53
3.3.3.6	Outband Spurious	3-56
3.3.4	Modulation (When select to GSM/EDGE)	3-59
3.3.4.1	Phase Error	3-59
3.3.4.2	Modulation Accuracy	3-61
3.3.4.3	Tx Power	3-63
3.3.4.4	Power vs Time	3-64
3.3.4.5	Wave Check	3-67
3.3.5	Modulation (When select to DECT)	3-70
3.3.5.1	Freq Deviation	3-70
3.3.5.2	Timing Jitter	3-72
3.3.5.3	Tx Power	3-73
3.3.5.4	Power vs Time	3-74
3.3.5.5	Wave Check	3-76
3.3.6	STD	3-79

Table of Contents

3.3.6.1 DC CAL	3-79
3.3.6.2 Channel Setting	3-79
3.3.6.3 STD Setup	3-79
4 REMOTE CONTROL	4-1
4.1 GPIB Command Index	4-1
4.2 GPIB Command Codes	4-10
5 TECHNICAL INFORMATION	5-1
5.1 NARROW/WIDE in the GSM filter mode	5-1
5.2 NARROW/WIDE in the DECT filter mode	5-1
5.3 RANDOM/STD in the DECT bit sequence	5-1
5.4 Measurement of a Signal Containing Multiple Bursts in a Frame (IN GSM)	5-2
5.5 Measurement of a Signal Containing UP LINK/DOWN LINK Bursts in a Frame (IN DECT)	5-3
5.6 T-DOMAIN Power	5-4
5.6.1 Default values of Time Template	5-4
5.6.1.1 GSM Template	5-4
5.6.1.2 DECT Template	5-7
5.7 Phase Error Measurements Compliant With GSM	5-8
5.8 Template Edit Function	5-9
5.8.1 Template Setting in the T-Domain Measuring Mode	5-9
5.8.2 Template Setting in the F-Domain Measuring Mode	5-11
5.9 Measurement Parameter Settings in Due to Transient, Due to Modulation and Inband Spurious	5-13
5.9.1 Marker Edit Function	5-13
5.9.2 Measurement results Using Due to Modulation, Due to Transient and Inband Spurious Modes	5-14
5.9.3 Measurement Result of Inband Spurious	5-15
5.10 Phase Error	5-16
5.11 8 PSK Graph	5-17
5.12 Tx Power Peak Factor	5-18
5.13 Block Diagram	5-19
6 PERFORMANCE VERIFICATION TEST	6-1
6.1 General	6-1
6.1.1 Introduction	6-1
6.1.2 Test Equipment	6-1
6.1.3 Calibration Cycle	6-1
6.1.4 Performance Verification Test Record Sheet	6-2
6.1.5 Performance Verification Procedures	6-2
6.2 Performance Verification Test Procedure	6-3
6.2.1 Phase Error Measurement Accuracy for GSM	6-3

6.2.2	Modulation Accuracy Measurement for EDGE	6-4
6.2.3	Frequency Deviation Accuracy Measurement for DECT	6-6
6.3	Performance Verification Test Record Sheet	6-8
7	SPECIFICATIONS	7-1
	APPENDIX	A-1
A.1	Messages	A-1
	ALPHABETICAL INDEX	I-1

LIST OF ILLUSTRATIONS

No.	Title	Page
2-1	Connections for GSM Measurements	2-1
2-2	STD Measurement Parameter Set Dialog Box	2-2
2-3	Parameter Setup Dialog Box	2-3
2-4	Phase Error Measurement Results	2-4
2-5	Displaying Phase Error vs Bit Graph	2-4
2-6	Connections for GSM Measurements	2-6
2-7	STD Measurement Parameter Set Dialog Box	2-7
2-8	Parameter Setup Dialog box	2-8
2-9	Phase Error measurement results	2-9
2-10	Displaying Constellation Graph	2-9
3-1	Dialog Box Used for the Communication Systems	3-29
3-2	Trigger Setup Dialog Box	3-30
3-3	Parameter Setup Dialog Box	3-32
3-4	Trigger Setup Dialog Box	3-33
3-5	Parameter Setup Dialog Box	3-35
3-6	Trigger Setup Dialog Box	3-36
3-7	Parameter Setup Dialog Box	3-37
3-8	Trigger Setup Dialog Box	3-39
3-9	Parameter Setup Dialog Box	3-40
3-10	Trigger Setup Dialog Box	3-42
3-11	Detector Dialog Box	3-43
3-12	Parameter Setup Dialog Box	3-44
3-13	Parameter Setup Dialog Box	3-45
3-14	Parameter Setup Dialog Box	3-47
3-15	Trigger Setup Dialog Box	3-49
3-16	Detector Dialog Box	3-50
3-17	Parameter Setup Dialog Box	3-52
3-18	Parameter Setup Dialog Box	3-55
3-19	Parameter Setup Dialog Box	3-57
3-20	Select Type Dialog Box	3-59
3-21	Parameter Setup Dialog Box	3-59
3-22	Graphic Type of Analysis Dialog Box	3-61
3-23	Parameter Setup Dialog Box	3-61
3-24	Parameter Setup Dialog Box	3-63
3-25	Parameter Setup Dialog Box	3-65
3-26	Select Type Dialog Box	3-67
3-27	Parameter Setup Dialog Box	3-67
3-28	Parameter Setup Dialog Box	3-68
3-29	Select Type Dialog Box	3-70
3-30	Parameter Setup Dialog Box	3-70
3-31	Parameter Setup Dialog Box	3-72
3-32	Parameter Setup Dialog Box	3-73
3-33	Parameter Setup Dialog Box	3-75
3-34	Display Dialog Box	3-76
3-35	Parameter Setup Dialog Box	3-76

List of Illustrations

No.	Title	Page
3-36	Parameter Setup Dialog Box	3-77
5-1	A Signal Containing Multiple Bursts in a Frame	5-2
5-2	A Signal Containing Up Link/Down Link Bursts in a Frame	5-3
5-3	Relationship Between Useful Part and Graphic Display Range	5-8
5-4	Template to Be Set	5-9
5-5	Template settings	5-10
5-6	Template Shifted Using the Shift Y Function	5-10
5-7	Template with the Set Values	5-11
5-8	Template with Margin Delta X	5-11
5-9	Example of Marker Edit Setting	5-13
5-10	Marker Edit Setting	5-14
5-11	Example of Peak Marker Y Delta	5-14
5-12	Mag Error, Phase Error, E.V.M.	5-16
5-13	EDGE Signal Constellation	5-17
5-14	EDGE Signal 8 PSK Constellation	5-17
5-15	Block Diagram	5-19
6-1	Setup of Phase Error Measurement Accuracy for GSM	6-3
6-2	Setting of STD Parameter for Phase Error Accuracy Measurement (GSM)	6-4
6-3	Setup of Modulation Accuracy for EDGE	6-5
6-4	Setting of STD Parameter for Modulation Accuracy Measurement (EDGE)	6-5
6-5	Setting of Parameter Setup	6-6
6-6	Setup of Frequency Deviation Accuracy Measurement for DECT	6-6
6-7	Setting of Measurement parameter for Frequency Deviation Accuracy Measurement (DECT)	6-7

LIST OF TABLES

No.	Title	Page
4-1	Operating mode	4-10
4-2	ATT key (Attenuator)	4-10
4-3	COPY key (Hand copy)	4-10
4-4	COUPLE key (Couple function)	4-11
4-5	FREQ key (Frequency)	4-11
4-6	LEVEL key (Reference Level)	4-11
4-7	MKR key (Marker)	4-12
4-8	PRESET Key (Initialization)	4-12
4-9	RCL Key (Recall)	4-12
4-10	SAVE Key (Save)	4-13
4-11	SPAN Key (Frequency span)	4-13
4-12	TRANSIENT Key (1 of 56)	4-14
4-13	Numeric keys/Step keys/Data knob/Unit keys (Entering data)	4-70
4-14	Miscellaneous	4-71
6-1	Performance Verification Items	6-1
6-2	Equipment List	6-1

1 INTRODUCTION

1.1 Product Overview

The GSM/EDGE/DECT option (Option 63) is the software designed to measure and evaluate frequency errors in GSM/DECT as well as characteristics of burst waveform's leading and trailing edges.

This option is a factory option which is incorporated into the R3267 Series Spectrum Analyzer prior to shipment.

The key features of this option allow the user to:

- Measure the signals used in the GSM, EDGE and DECT digital wireless communication systems by simply switching between the two.
- Analyze signal characteristics compliant with GSM such as phase errors, frequency errors, and leading or trailing edges of burst signals.
- Leading and trailing burst waveforms and error vector magnitudes (EVM) can be analyzed according to the EDGE standards.
- Analyze signal characteristics compliant with DECT such as frequency deviations, frequency errors, jitters, and leading or trailing edges of burst signals.
- Make measurements compliant the communication standard with simple key operations.

1.2 Accessories

Name of accesories	Type of name	Quantity	Remarks
R3267 Series OPT63 Operation manual	ER3267/73 OPT63	1	English

1.3 Self Test Function

The self test also checks the Option 63 for correct operation when the spectrum analyzer power is turned on. The message shown below will be displayed when an error related to Option 63 occurs. Contact ADVANTEST Corp. for repair.

Error Message
Handshake error occurred to DSP

1.4 About Calibration

When you want to calibrate the R3267 Series, please contact a sales representative.

Desirable Period	One year
------------------	----------

1.5 Explanation of the Connectors

1.5 Explanation of the Connectors

Connectors used for this option are described as follows:

- ① EXT TRIG terminal Connector for inputting the external trigger signal.
- ② INPUT I channel terminal Connector for inputting the I channel signal (Baseband).
- ③ INPUT Q channel terminal Connector for inputting the Q channel signal (Baseband).

2 OPERATION

This chapter describes how to use this option using practical measurement examples.

2.1 Measuring Multi-burst Signals (No External Triggers Available)

This section describes how to measure the signals (from GSM mobile station or the base station) which contain multiple bursts in one frame. It is assumed that no external triggers are available.

Measurement specifications: Up link frequency: 945 MHz and Sync word TSC 0

Setup

1. Connect the instrument as shown in Figure 2-1.

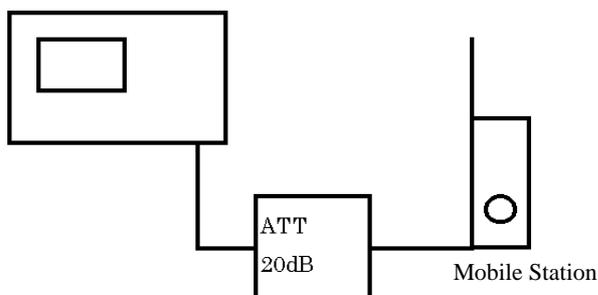

Figure 2-1 Connections for GSM Measurements

2. Press **TRANSIENT**, **STD** and **STD Setup** to open the STD Measurement Parameter Set menu.
3. Select **GMSK** from **Modulation** using the data knob, and press the data knob (or **ENTR**) to register the parameter.
4. Select **GSM900** from **Type** using the data knob, and press the data knob (or **ENTR**) to register the parameter.
5. Select **MULTI-BURST** from **Meas Mode** using the data knob, and press the data knob (or **ENTR**) to register the parameter.
6. Select **MS** from **Link** using the data knob, and press the data knob (or **ENTR**) to register the parameter.
7. Select **148 BIT** from **Burst Type** using the data knob, and press the data knob (or **ENTR**) to register the parameter.
8. Select **SYNC WORD** from **Sync Type** using the data knob, and press the data knob (or **ENTR**) to register the parameter.

2.1 Measuring Multi-burst Signals (No External Triggers Available)

9. Select **0** from **TSC** using the data knob, and press the data knob (or **ENTR**) to register the parameter.
10. Select **WIDE** from **Filter Mode** using the data knob, and press the data knob (or **ENTR**) to register the parameter. For the definition of the filter, refer to Section 5.1 “NARROW/WIDE in the GSM filter mode.”
11. Select **OTHER** from **Power Control Level** using the data knob, and press the data knob (or **ENTR**) to register the parameter.
12. Enter 20 dB for **Offset Level** using the data knob, because the RF signal is already provided with an attenuation of 20 dB.
13. To directly enter the frequency, select **FREQUENCY** from **Frequency Input** using the data knob, and press the data knob (or **ENTR**) to register the parameter.
14. To analyze signal with an RF input, select **RF** from **Input** using the data knob, and press the data knob (or **ENTR**) to register the parameter.
15. Assuming that the phase of the input signal is not inverted, select **NORMAL** in **IQ Inverse** using the data knob, and press the data knob (or **ENTR**) to register the parameter.
16. Select **OFF** from **Cont Auto Level Set** using the data knob when the auto ranging function is not used, and press the data knob (or **ENTR**) to register the parameter.
17. Press **RETURN** to close the dialog box.

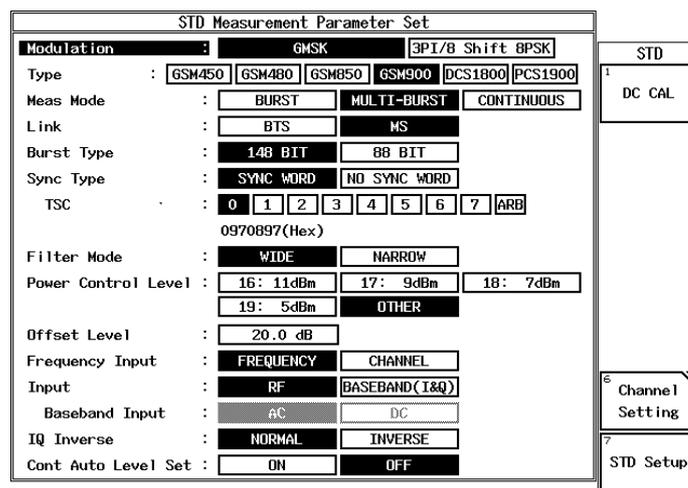

Figure 2-2 STD Measurement Parameter Set Dialog Box

18. Press **Modulation**.
19. Press **Phase Error** to open the phase error measurement menu.
20. Press **Parameter Setup** to open the Parameter Setup dialog box.

2.1 Measuring Multi-burst Signals (No External Triggers Available)

21. Select **FREE RUN** from **Trigger Source** using the data knob, and press the data knob (or **ENTR**) to register the parameter.
22. Press the arrow key↓ to shift the cursor to Search Level and enter -25 dB.
23. Select **OFF** from **Half Symbol Shift** using the data knob, and press the data knob (or **ENTR**) to determine the parameter.
24. Press **Parameter Setup** to close the dialog box.

Parameter Setup	
Trigger Source :	FREE RUN IF EXT
Burst Search :	ON OFF
Search Level :	-25.0 dB
Trigger Slope :	↕ --
Trigger Level :	
TDMA Structure :	156.25 BIT 156/157 BIT
Slot Number :	
Trigger Delay :	
Half Symbol Shift :	ON OFF

Figure 2-3 Parameter Setup Dialog Box

Setting the frequency

25. Press **FREQ, 945** and **MHz** to set the frequency.
26. Press **RETURN** to return to the measurement menu.

Executing Auto Level Set

27. Press **Auto Level Set**, and wait until the “Auto Level Completed!” is displayed.

Measuring

28. Press **SINGLE** or **REPEAT** to start the measurement.
Press **REPEAT (STOP)** again to terminate the measurement.

2.1 Measuring Multi-burst Signals (No External Triggers Available)

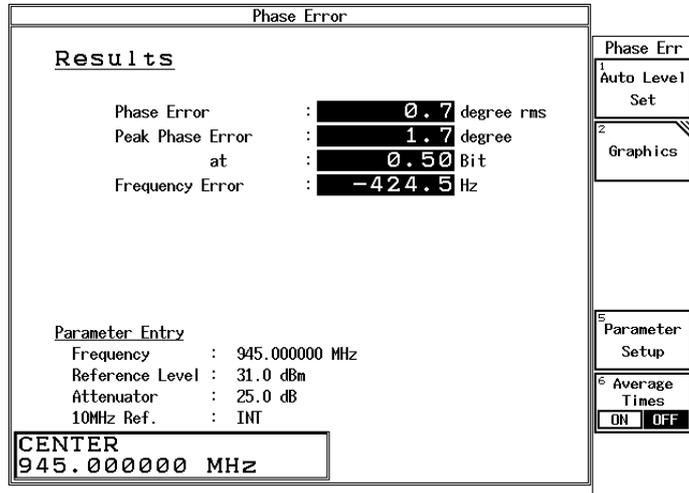

Figure 2-4 Phase Error Measurement Results

Displaying the graphics

Phase Error vs Bit graph is displayed.

29. Press **Graphics**.
30. Press **Select Type** to open Graphic Type of Analysis dialog box.
31. Select **Phase Error vs Bit** using the data knob, and press the data knob (or **ENTR**) to register the parameter.

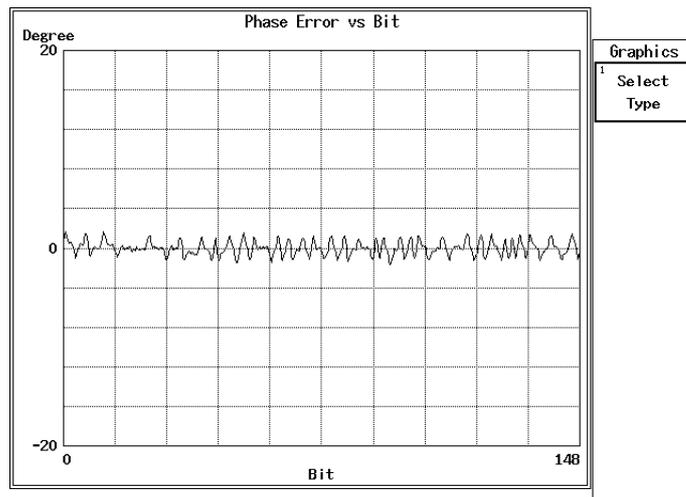

Figure 2-5 Displaying Phase Error vs Bit Graph

32. Press **MKR** to display the marker. Move the marker by turning the data knob.

2.1 Measuring Multi-burst Signals (No External Triggers Available)

33. Press **SHIFT** and **MKR** to delete the marker.
34. Press **RETURN** and **RETURN** (**RETURN** twice) to return to the measurement menu.

2.2 Measuring the Multi-Burst Signals (Using an External Trigger)

2.2 Measuring the Multi-Burst Signals (Using an External Trigger)

This section describes how to measure a MULTI-BURST signal, which consist of multiple bursts in one frame, at mobile station or the base station that are used in the GSM system. It is assumed that a frame is in sync with the trigger signal at its beginning.

Specification: Down link channel of 945 MHz, and the sync word TSC 2.

Setup

1. Connect the instruments as shown in Figure 2-6.

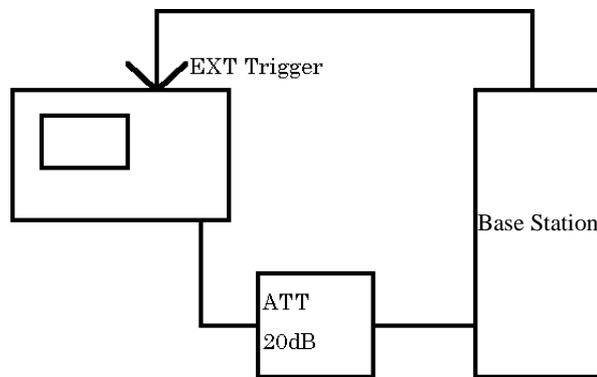

Figure 2-6 Connections for GSM Measurements

2. Press **TRANSIENT**, **STD** and **STD Setup** to open the STD Measurement Parameter Set menu.
3. Select **GMSK** from **Modulation** using the data knob, and press the data knob (or **ENTR**) to register the parameter.
4. Select **GSM900** from **Type** using the data knob, and press the data knob (or **ENTR**) to register the parameter.
5. Select **BURST** from **Meas Mode** using the data knob, and press the data knob (or **ENTR**) to register the parameter.
6. Select **BTS** from **Link** using the data knob, and press the data knob (or **ENTR**) to register the parameter.
7. Select **148 BIT** from **Burst Type** using the data knob, and press the data knob (or **ENTR**) to register the parameter.
8. Select **SYNC WORD** from **Sync Type** using the data knob, and press the data knob (or **ENTR**) to register the parameter.
9. Select **2** from **TSC** using the data knob, and press the data knob (or **ENTR**) to register the parameter.

2.2 Measuring the Multi-Burst Signals (Using an External Trigger)

10. Select **WIDE** from **Filter Mode** using the data knob, and press the data knob (or **ENTR**) to register the parameter. For the definition of the filter, refer to Section 5.1 “NARROW/WIDE in the GSM filter mode.”
11. Enter 20 dB for **Offset Level** using the data knob, because the RF signal is already provided with an attenuation of 20 dB.
12. To directly enter the frequency, select **FREQUENCY** from **Frequency Input** using the data knob, and press the data knob (or **ENTR**) to register the parameter.
13. To analyze signal with an RF input, select **RF** from **Input** using the data knob, and press the data knob (or **ENTR**) to register the parameter.
14. Assuming that the IQ signal is not inverted, select **NORMAL** in **IQ Inverse** using the data knob, and press the data knob (or **ENTR**) to register the parameter.
15. Select **OFF** from **Cont Auto Level Set** using the data knob when the auto ranging function is not used, and press the data knob (or **ENTR**) to register the parameter.
16. Press **RETURN** to close the dialog box.

STD Measurement Parameter Set		STD
Modulation	GMSK	1 STD
Type	GSM450 GSM480 GSM850 GSM900 DCS1800 PCS1900	DC CAL
Meas Mode	BURST MULTI-BURST CONTINUOUS	
Link	BTS MS	
Burst Type	148 BIT 88 BIT	
Sync Type	SYNC WORD NO SYNC WORD	
TSC	0 1 2 3 4 5 6 7 ARB	
	10EE90E(Hex)	
Filter Mode	WIDE NARROW	
Offset Level	20.0 dB	
Frequency Input	FREQUENCY CHANNEL	
Input	RF BASEBAND(I&Q)	6 Channel Setting
Baseband Input	AC DC	
IQ Inverse	NORMAL INVERSE	
Cont Auto Level Set	ON OFF	7 STD Setup

Figure 2-7 STD Measurement Parameter Set Dialog Box

17. Press **Modulation**.
18. Press **Phase Error** to open the phase error measurement menu.
19. Press **Parameter Setup** to open the Parameter Setup dialog box.
20. Select **EXT** from **Trigger Source** using the data knob, and press the data knob (or **ENTR**) to register the parameter.
21. Select **OFF** from **Burst Search** using the data knob, and press the data knob (or **ENTR**) to register the parameter.

2.2 Measuring the Multi-Burst Signals (Using an External Trigger)

22. Select **+** from *Trigger Slope* using the data knob, and press the data knob (or **ENTR**) to register the parameter.
23. Select **156.25 BIT** from *TDMA Structure* using the data knob, and press the data knob (or **ENTR**) to register the parameter. (all slots in GSM are assumed to be 156.25 bits)
24. Enter **2** in *Slot Number* using the numeric key and press **ENTR** to measure Slot 2. Trigger delay will be automatically calculated and displayed when Slot Number is set.
25. Move the cursor to *Half Symbol Shift* using the arrow key↓, and press the data knob (or **ENTR**) to determine the parameter.
26. Press *Parameter Setup* to close the dialog box.

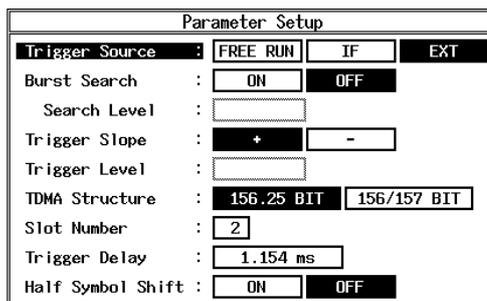

Figure 2-8 Parameter Setup Dialog box

Setting the frequency

27. Press **FREQ, 945** and **MHz** to set the frequency.
28. Press **RETURN** to return to the measurement menu.

Executing Auto Level Set

29. Press *Auto Level Set*, and wait until the “Auto Level Completed !” is displayed.

Measuring

30. Press **SINGLE** or **REPEAT** to start the measurement. Press **REPEAT(STOP)** again to terminate the measurement.

2.2 Measuring the Multi-Burst Signals (Using an External Trigger)

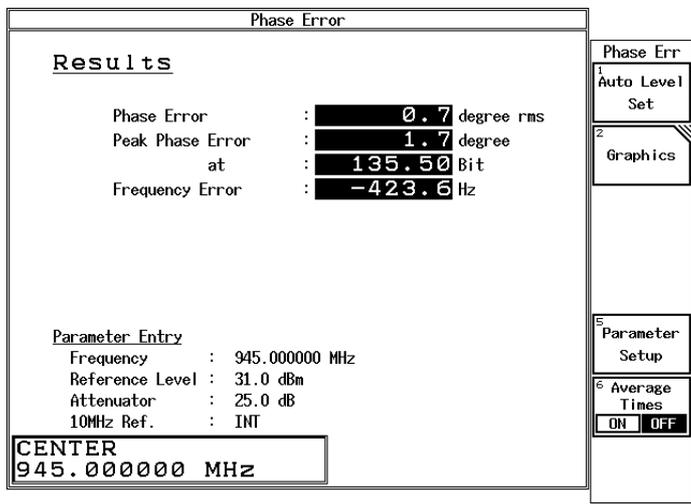

Figure 2-9 Phase Error measurement results

Displaying the graphics

Constellation graph is displayed.

31. Press *Graphics*.
32. Press *Select Type* to open Graphic Type of Analysis dialog box.
33. Select *Constellation* using the data knob, and press the data knob (or **ENTR**) to register the parameter.

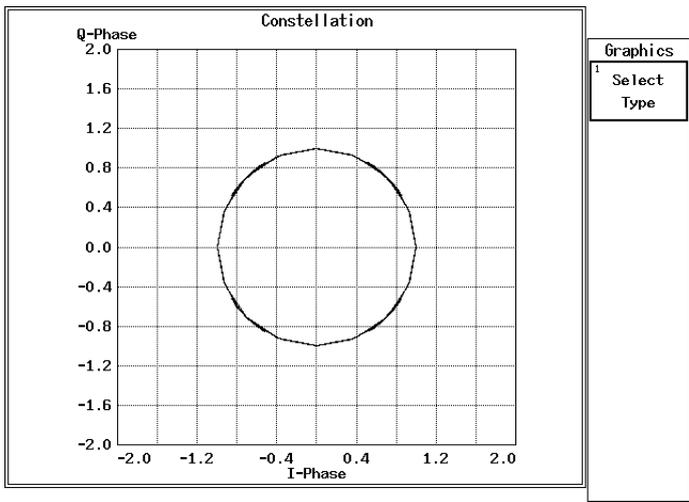

Figure 2-10 Displaying Constellation Graph

2.2 Measuring the Multi-Burst Signals (Using an External Trigger)

34. Press **MKR** to display the marker. Turn the data knob to move the marker.
35. Press **SHIFT** and **MKR** to make the marker to go out.
36. Press **RETURN** and **RETURN** to return to the measurement menu.

3 REFERENCE

This chapter describes the functions of the panel and soft keys for option 63 software.

3.1 Menu Index

This menu index is used to easily find the keys described in Chapter 3.

<u>Operation Key</u>	<u>Pages</u>	<u>Operation Key</u>	<u>Pages</u>
8PSK Constellation.....	3-20	Average Times ON/OFF.....	3-8, 3-9, 3-10, 3-12, 3-13, 3-14, 3-15, 3-17, 3-18, 3-19, 3-20, 3-21, 3-22, 3-23, 3-24, 3-25, 3-26, 3-32, 3-34, 3-37, 3-40, 3-43, 3-45, 3-47, 3-51, 3-55, 3-57, 3-60, 3-62, 3-64, 3-66, 3-68, 3-71, 3-73, 3-74, 3-75, 3-77
8PSK Constellation(Dot)	3-20	Baseband Input	3-27, 3-81, 3-84
8PSK Constellation(Line & Dot).....	3-20	Bit Sequence	3-24, 3-71
8PSK Constellation(Line).....	3-20	BTS Template1	3-22, 3-64
8PSK I EYE Diagram	3-20	BTS Template2	3-22, 3-64
8PSK I/Q EYE Diagram	3-20	Burst PREV/NEXT.....	3-22, 3-66
8PSK Q EYE Diagram	3-20	Burst Search.....	3-19, 3-20, 3-21, 3-22, 3-23, 3-24, 3-25, 3-26, 3-60, 3-62, 3-63, 3-65, 3-69, 3-71, 3-72, 3-74, 3-75, 3-78
Auto Level Set	3-8, 3-9, 3-10, 3-11, 3-12, 3-13, 3-14, 3-15, 3-17, 3-18, 3-19, 3-20, 3-21, 3-22, 3-23, 3-24, 3-25, 3-26, 3-30, 3-33, 3-36, 3-38, 3-41, 3-45, 3-46, 3-49, 3-53, 3-56, 3-59, 3-61, 3-63, 3-64, 3-67, 3-68, 3-70, 3-72, 3-73, 3-74, 3-76, 3-77	Config	3-8, 3-9,
Average Mode.....	3-8, 3-9, 3-10, 3-11, 3-12, 3-13, 3-14, 3-16, 3-17, 3-18, 3-32, 3-35, 3-38, 3-41, 3-44, 3-45, 3-48, 3-53, 3-56, 3-58		
Average Times.....	3-11		

3.1 Menu Index

	3-10, 3-11, 3-12, 3-13, 3-14, 3-15, 3-17, 3-18, 3-32, 3-34, 3-37, 3-40, 3-43, 3-45, 3-47, 3-51, 3-55, 3-57		3-52, 3-55, 3-57
Consecutive Template.....	3-22, 3-66	Display Unit.....	3-8, 3-9, 3-10, 3-11, 3-12, 3-14, 3-16, 3-17, 3-18, 3-32, 3-35, 3-37, 3-40, 3-44, 3-48, 3-52, 3-56, 3-57
Constellation	3-19, 3-20	Due to Modulation	3-7
Constellation(Dot)	3-19, 3-20	Due to Transient.....	3-7
Constellation(Line & Dot).....	3-19, 3-20	E.V.M. vs Symbol.....	3-20
Constellation(Line).....	3-19, 3-20	Ext Gate	3-12, 3-15, 3-43, 3-50
Cont Auto Level Set	3-27, 3-81, 3-84	F-Domain	3-7
Copy from STD	3-7, 3-8, 3-14, 3-15, 3-17, 3-18, 3-23, 3-26, 3-31, 3-46, 3-47, 3-51, 3-54, 3-57, 3-79	FFT of Phase Error	3-19
DC CAL.....	3-7, 3-23, 3-26	Filter Mode	3-27, 3-80, 3-83
Delay Time	3-8, 3-9, 3-10, 3-11, 3-12, 3-15, 3-30, 3-34, 3-36, 3-39, 3-42, 3-50	Freq Deviation	3-7, 3-24, 3-70
Delete Line.....	3-8, 3-10, 3-11, 3-14, 3-15, 3-17, 3-18, 3-31, 3-37, 3-40, 3-47, 3-51, 3-54, 3-57	Freq. Setting.....	3-14, 3-16, 3-17, 3-47, 3-52, 3-55
Demodulated Data	3-19, 3-20, 3-24	Frequency EYE.....	3-19, 3-24
Detector.....	3-8, 3-9, 3-10, 3-11, 3-12, 3-13, 3-14, 3-15, 3-16, 3-17, 3-18, 3-32, 3-35, 3-37, 3-40, 3-43, 3-44, 3-45, 3-47, 3-50,	Frequency Input	3-27, 3-81, 3-83
		Frequency vs Bit	3-19, 3-24
		Full Slot Number	3-24, 3-25, 3-26, 3-71, 3-73, 3-74, 3-75, 3-77, 3-78
		Gate Position.....	3-12, 3-15, 3-43, 3-50
		Gate Setup.....	3-12, 3-15, 3-42, 3-43, 3-49, 3-50
		Gate Source.....	3-12, 3-15, 3-42, 3-50
		Gate Width.....	3-12, 3-15, 3-43, 3-50
		Gated Sweep	3-12, 3-44
		Gated Sweep ON/OFF	3-12, 3-15, 3-43, 3-50
		Graphics	3-19, 3-20, 3-24, 3-59, 3-61, 3-70
		Half Slot Number.....	3-24, 3-25, 3-26, 3-71,

3.1 Menu Index

Preselector.....	3-10, 3-11, 3-18, 3-38, 3-40, 3-57	Slope	3-51, 3-54 3-8, 3-9, 3-10, 3-11, 3-12, 3-15, 3-30, 3-34, 3-36, 3-39, 3-42, 3-50
Q EYE Diagram.....	3-19, 3-20	Slot Length.....	3-22, 3-66
Qch Time & FFT	3-23, 3-26	Slot Number	3-19, 3-20, 3-21, 3-22, 3-23, 3-60, 3-62, 3-64, 3-66, 3-68, 3-69
R.C. Filter	3-20, 3-62	Sort.....	3-8, 3-14, 3-15, 3-17, 3-31, 3-47, 3-51, 3-54
Ref Power	3-11, 3-14, 3-16, 3-17, 3-40, 3-48, 3-52, 3-55	Spurious	3-7
Result	3-10, 3-11, 3-14, 3-16, 3-17, 3-37, 3-40, 3-48, 3-52, 3-55	Start Bit.....	3-24, 3-70
RFP→PP ON/OFF.....	3-24, 3-72	STD.....	3-7, 3-23, 3-26
Rolloff Factor.....	3-14, 3-16, 3-48, 3-53	STD Setup.....	3-7, 3-23, 3-26
Save Table.....	3-10, 3-11, 3-18, 3-37, 3-39, 3-57	STD Template.....	3-22, 3-25, 3-64, 3-74
Search Level	3-19, 3-20, 3-21, 3-22, 3-23, 3-60, 3-62, 3-63, 3-65, 3-69	Sweep Time	3-23, 3-26, 3-68, 3-77
Select Type	3-19, 3-20, 3-23, 3-24, 3-26, 3-59, 3-61, 3-67, 3-70, 3-76	Symbol Rate 1/T	3-14, 3-16, 3-48, 3-53
Set to Default	3-10, 3-18, 3-38, 3-58	Sync Type	3-27, 3-80, 3-82
Set to STD.....	3-8, 3-9, 3-11, 3-12, 3-13, 3-14, 3-15, 3-17, 3-31, 3-33, 3-34, 3-35, 3-39, 3-41, 3-43, 3-44, 3-46, 3-49, 3-50, 3-53, 3-56	Table Edit.....	3-10, 3-11, 3-18, 3-37, 3-39, 3-57
Shift X.....	3-8, 3-14, 3-15, 3-17, 3-31, 3-46, 3-51, 3-54	Table Init.....	3-8, 3-10, 3-11, 3-14, 3-15, 3-17, 3-18, 3-31, 3-37, 3-40, 3-47, 3-51, 3-54, 3-57
Shift Y.....	3-8, 3-14, 3-15, 3-17, 3-31, 3-46,	Table No. 1/2/3	3-10, 3-11, 3-18, 3-36, 3-37, 3-39, 3-56, 3-57
		TDMA Structure	3-19, 3-20, 3-21, 3-22, 3-23, 3-60, 3-62, 3-64, 3-66, 3-68,

T-Domain	3-7, 3-29	3-36, 3-39, 3-42, 3-50,
Template	3-8, 3-14, 3-15, 3-17, 3-31, 3-46, 3-51, 3-54	3-60, 3-62, 3-63, 3-66, 3-68, 3-69, 3-71, 3-73, 3-74, 3-75, 3-77, 3-78
Template Couple to Power	3-8, 3-14, 3-16, 3-17, 3-32, 3-48, 3-53, 3-56	Trigger Position
Template Edit.....	3-8, 3-14, 3-15, 3-17, 3-31, 3-46, 3-51, 3-54	3-8, 3-9, 3-10, 3-11, 3-12, 3-15, 3-23, 3-26, 3-30, 3-34, 3-36, 3-39, 3-42, 3-50, 3-69, 3-78
Template Entry	3-22, 3-25, 3-64, 3-74	Trigger Setup
Template Limit	3-8, 3-14, 3-16, 3-17, 3-32, 3-48, 3-53, 3-56	3-8, 3-9, 3-10, 3-11, 3-12, 3-15, 3-30, 3-33, 3-36, 3-39, 3-42, 3-49
Template ON/OFF	3-8, 3-15, 3-17, 3-31, 3-46, 3-51, 3-54	Trigger Slope
Template UP/LOW	3-8, 3-31	3-19, 3-20, 3-21, 3-22, 3-23, 3-24, 3-25, 3-26, 3-60, 3-62, 3-63, 3-65, 3-67, 3-69, 3-71, 3-72, 3-74, 3-75, 3-77, 3-78
Time	3-23, 3-26, 3-68, 3-77	Trigger Source
Time & FFT	3-23, 3-26, 3-67, 3-76	3-8, 3-9, 3-10, 3-11, 3-12, 3-15, 3-19, 3-20, 3-21, 3-22, 3-23, 3-24, 3-25, 3-26, 3-30, 3-33, 3-36, 3-39, 3-42, 3-49, 3-59, 3-61, 3-63, 3-65, 3-67, 3-69, 3-70, 3-72, 3-73, 3-75, 3-76, 3-78
Timing Jitter.....	3-7, 3-24	TSC
Trellis	3-19	3-27, 3-80
Trigger	3-12, 3-15, 3-42, 3-50	Tx Power.....
Trigger Delay	3-19, 3-20, 3-21, 3-22, 3-23, 3-24, 3-25, 3-26, 3-60, 3-62, 3-64, 3-66, 3-68, 3-69, 3-71, 3-73, 3-74, 3-75, 3-77, 3-78	3-7, 3-21, 3-25
Trigger Level	3-8, 3-9, 3-10, 3-11, 3-12, 3-15, 3-19, 3-20, 3-21, 3-22, 3-23, 3-24, 3-25, 3-26, 3-30, 3-34,	

3.1 Menu Index

Type	3-27, 3-79, 3-82
Upper Limit.....	3-8, 3-9, 3-12, 3-13, 3-32, 3-35, 3-44, 3-45
User Template1	3-25, 3-74
User Template2.....	3-25, 3-74
User Template3.....	3-25, 3-74
Wave Check.....	3-7, 3-23, 3-26
Window ON/OFF	3-8, 3-9, 3-11, 3-12, 3-31, 3-34, 3-39, 3-43
Window Position.....	3-8, 3-11, 3-12, 3-31, 3-39, 3-43
Window Setup.....	3-8, 3-9, 3-11, 3-12, 3-31, 3-34, 3-39, 3-43
Window Width.....	3-8, 3-11, 3-12, 3-31, 3-39, 3-43
Y [dB/div] 20/10/5.....	3-22, 3-25, 3-65, 3-74
Y Scale [dB/div] 10/5/2	3-8, 3-9, 3-12, 3-31, 3-34, 3-43
Z-Field	3-27, 3-82

3.2 Menu Map

This section shows the hierarchical menu configuration on a panel key basis.

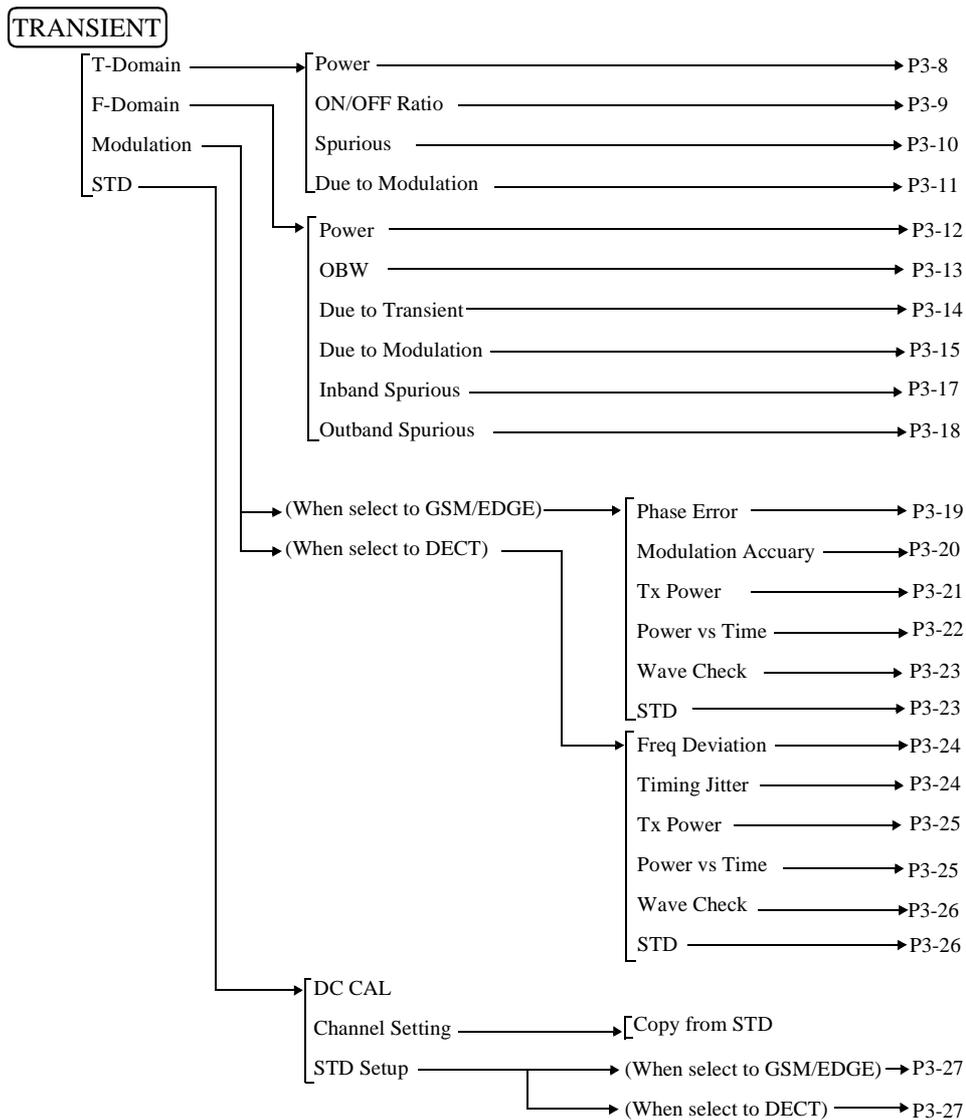

3.2 Menu Map

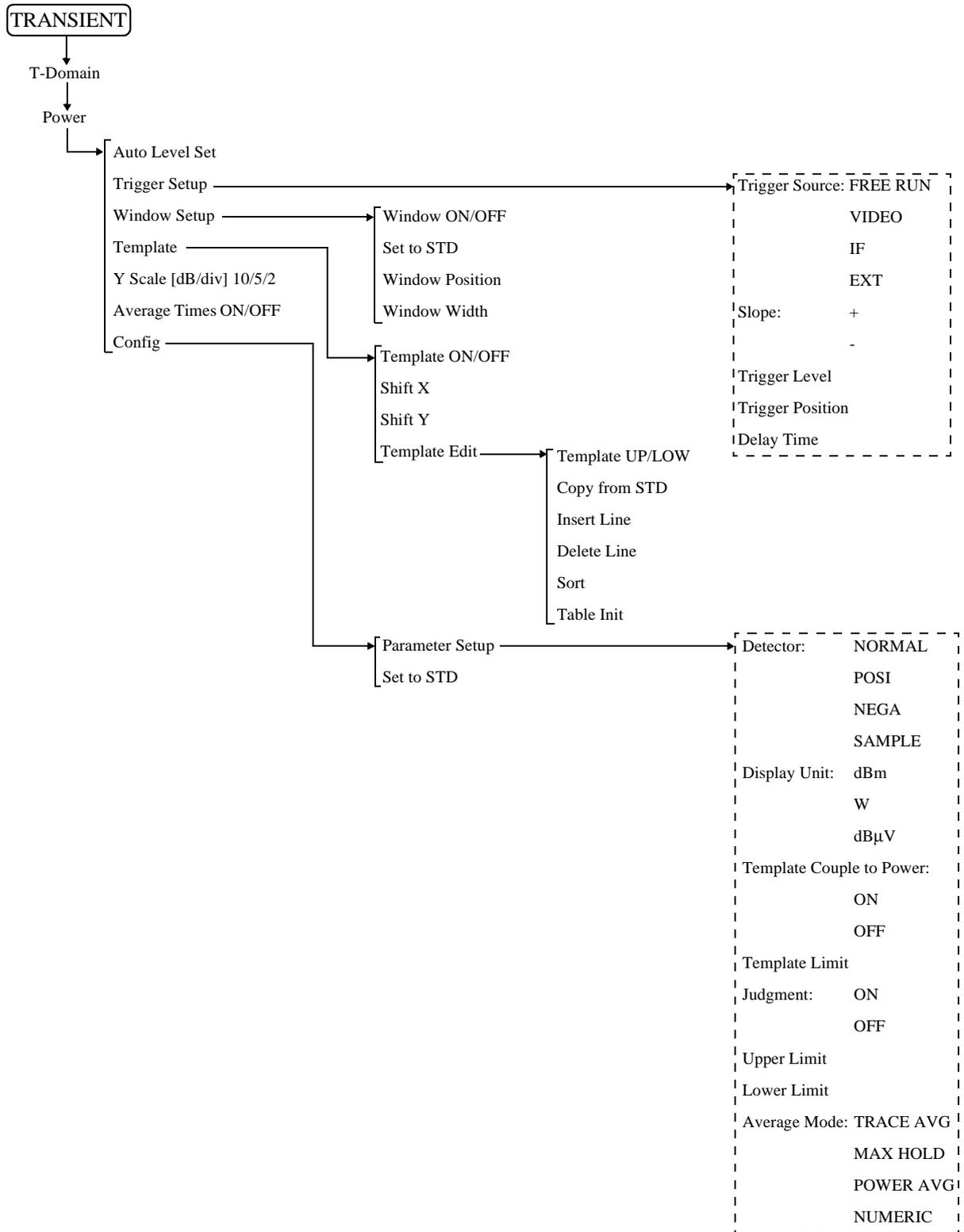

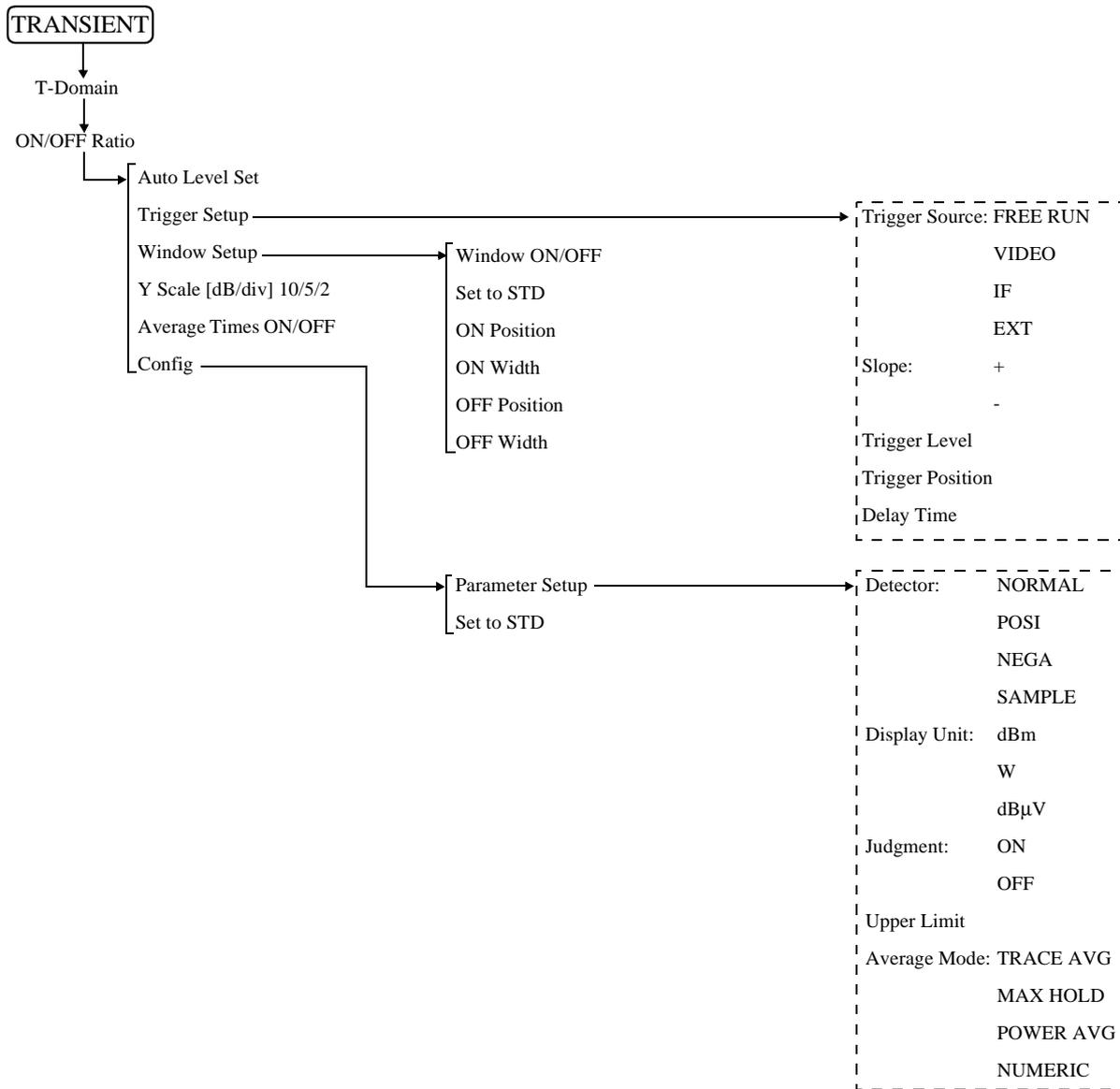

3.2 Menu Map

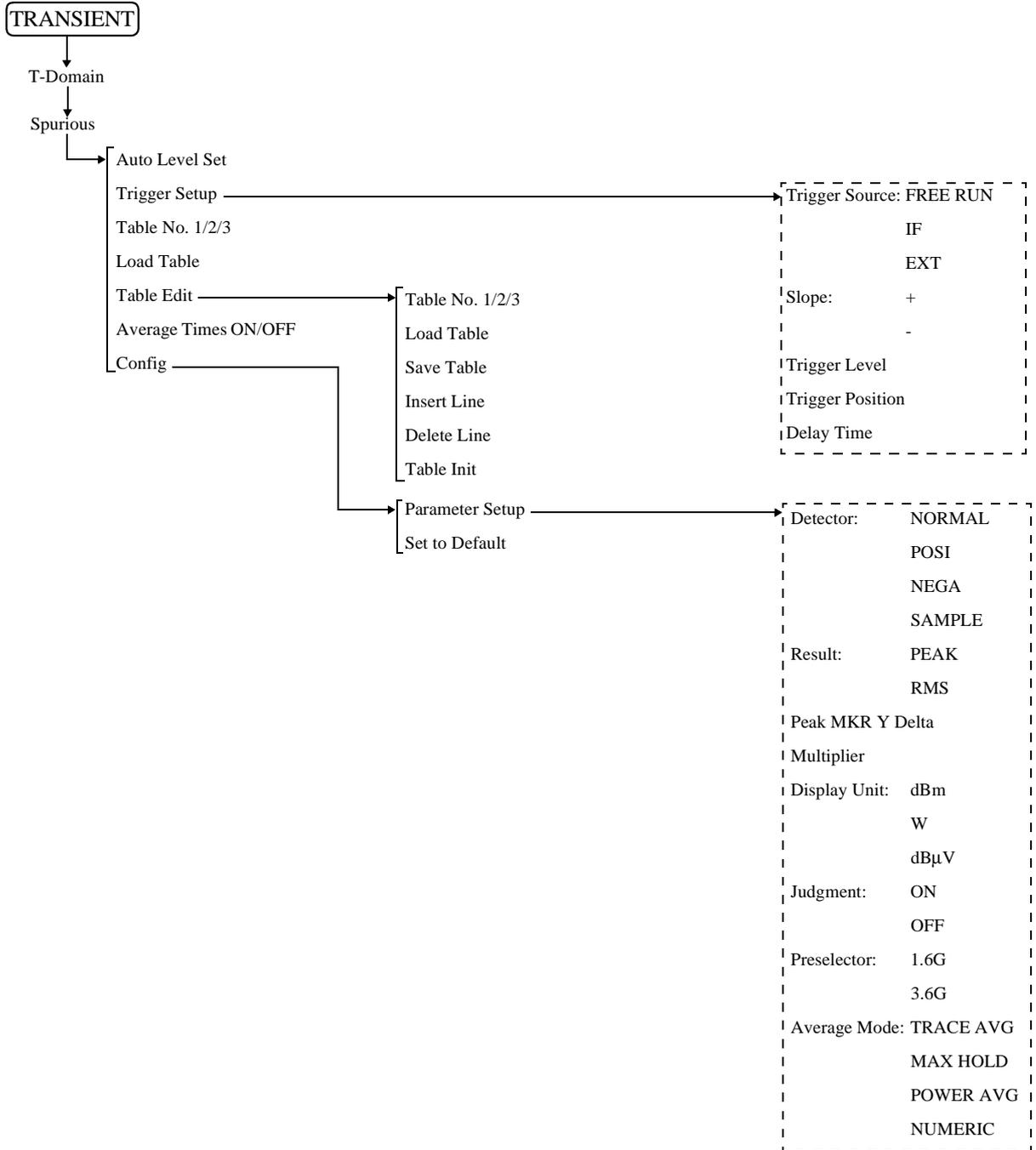

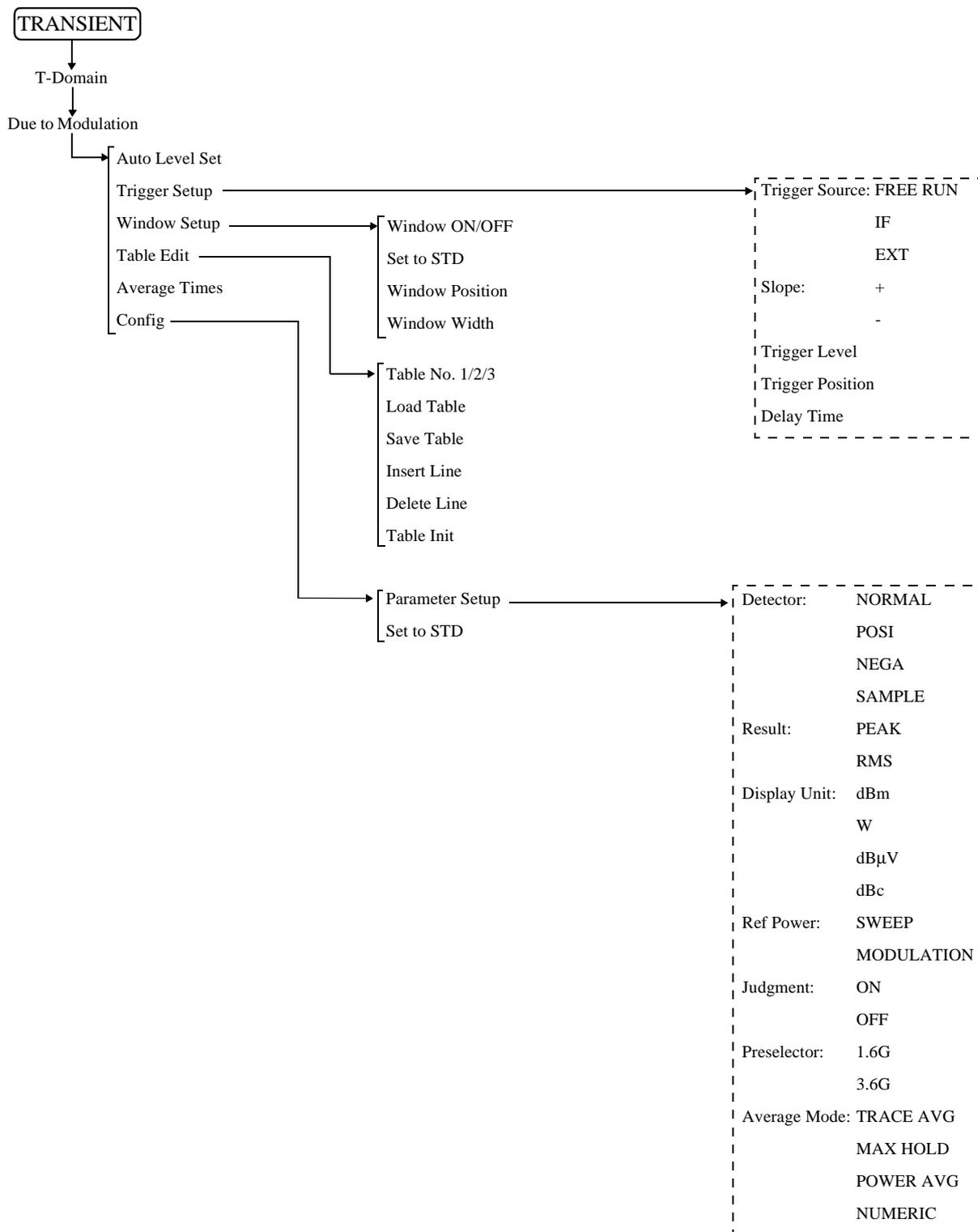

3.2 Menu Map

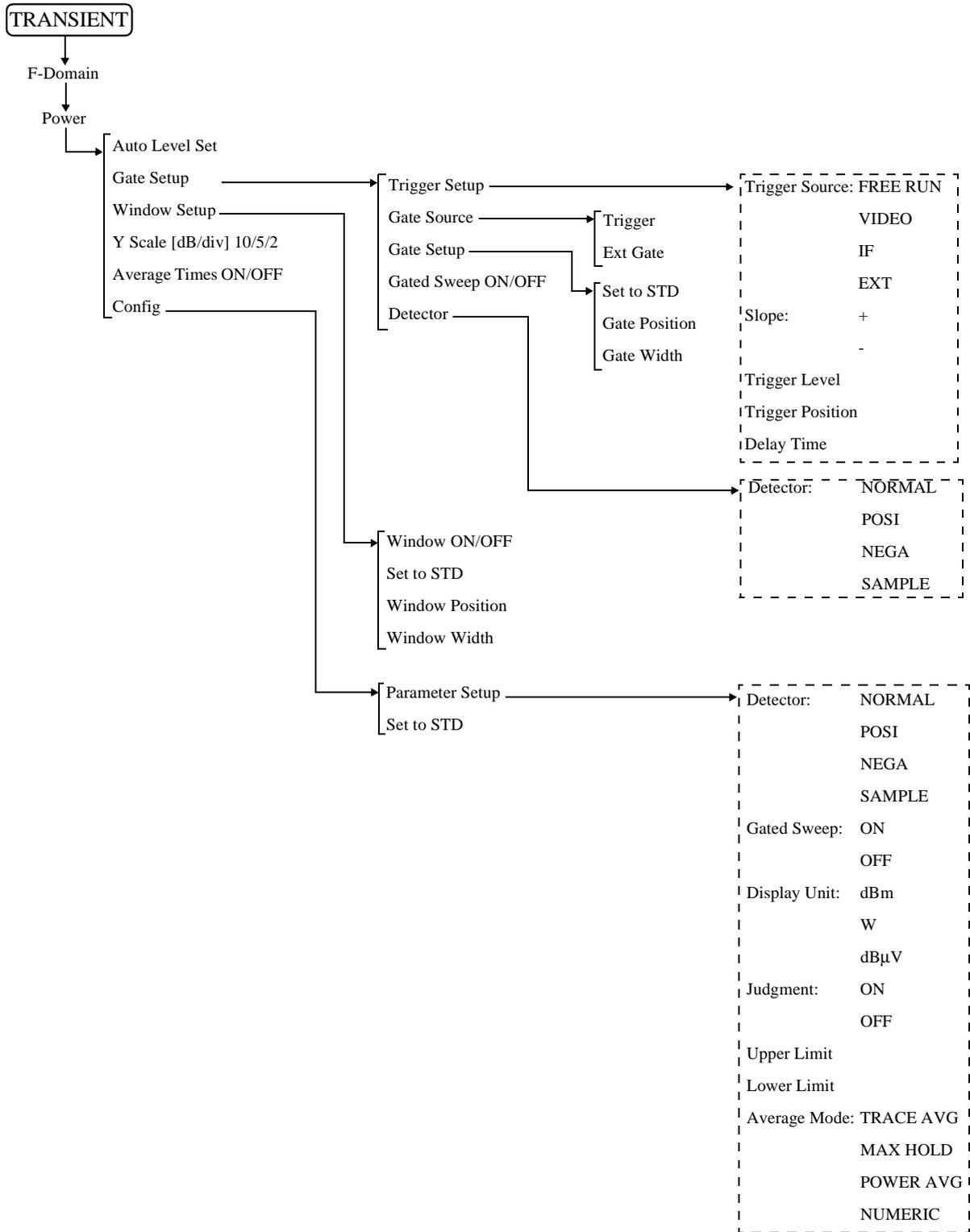

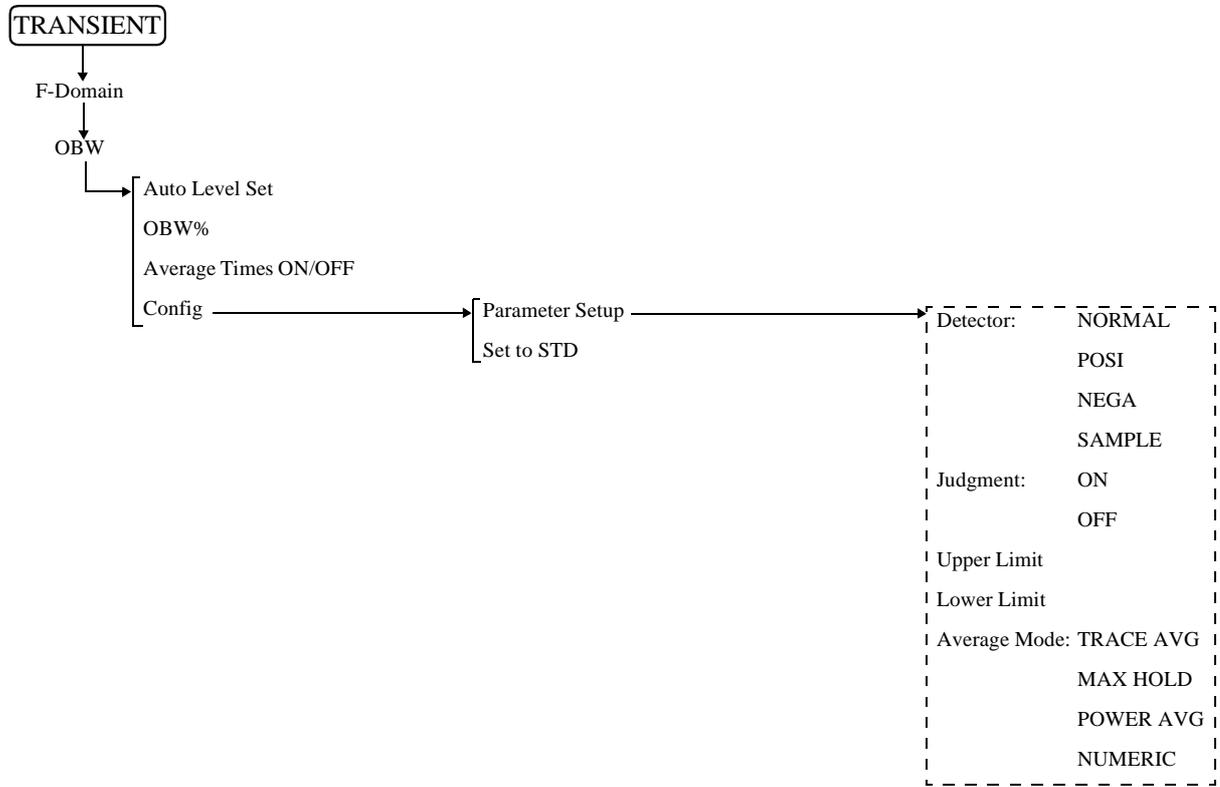

3.2 Menu Map

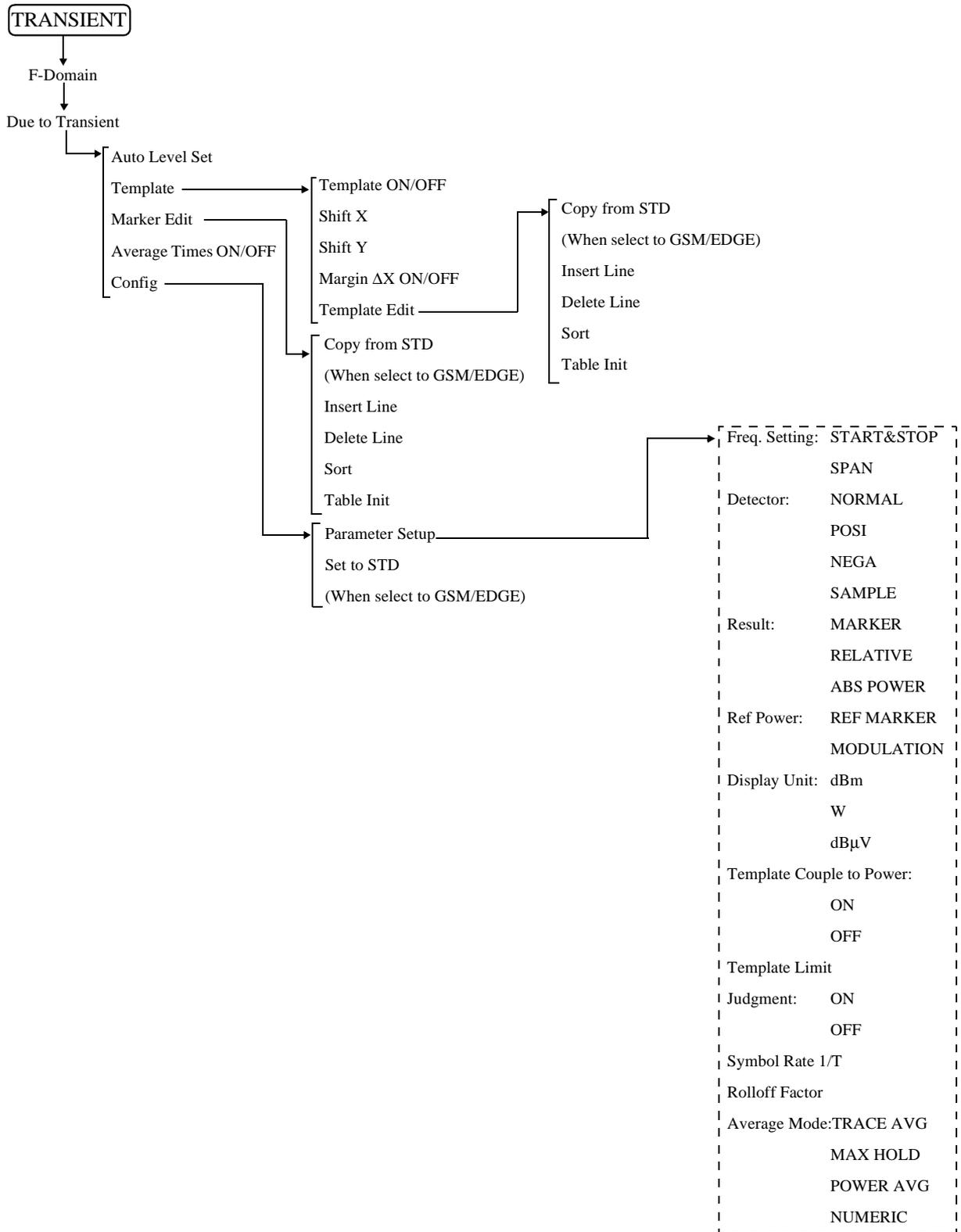

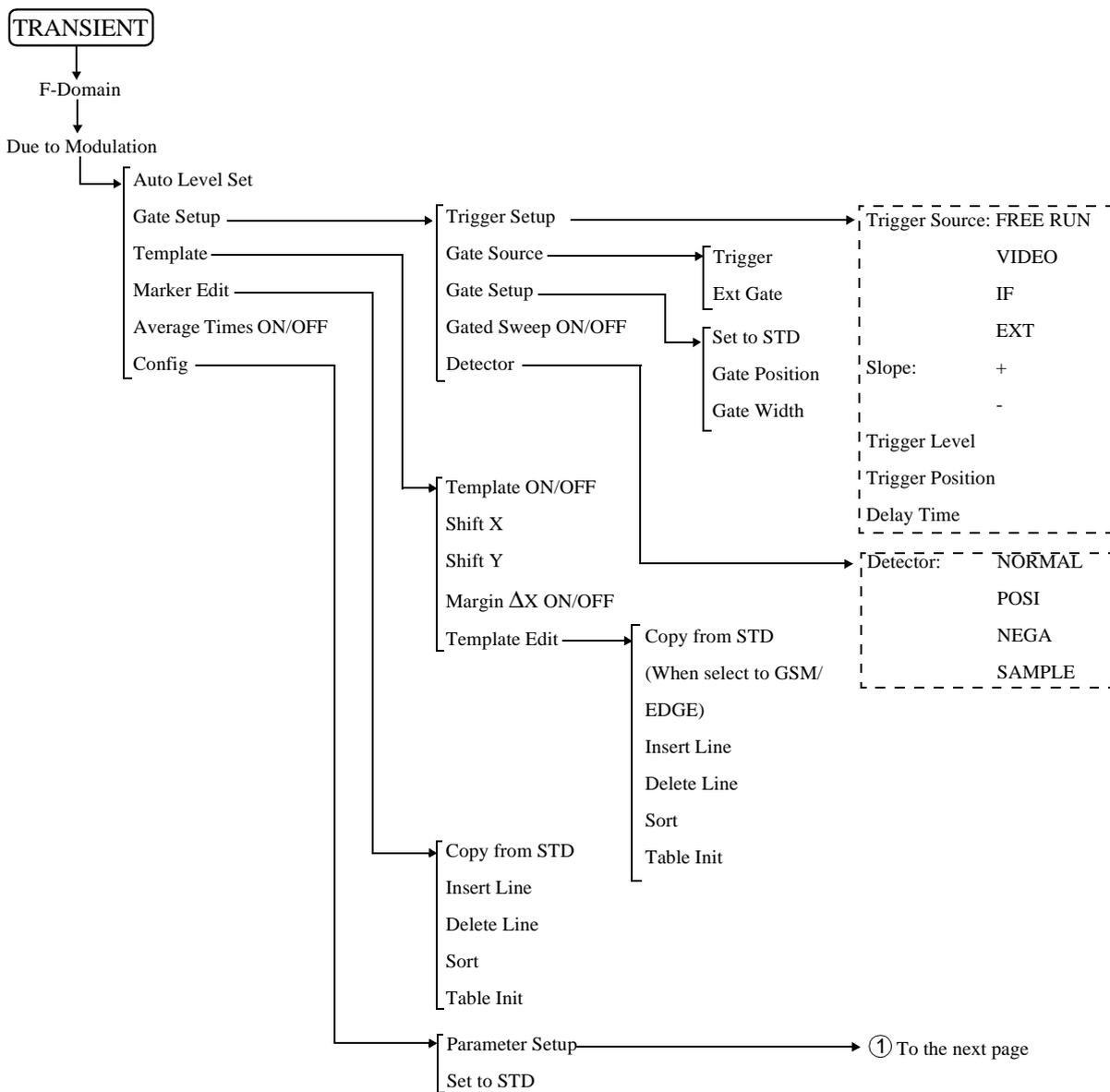

3.2 Menu Map

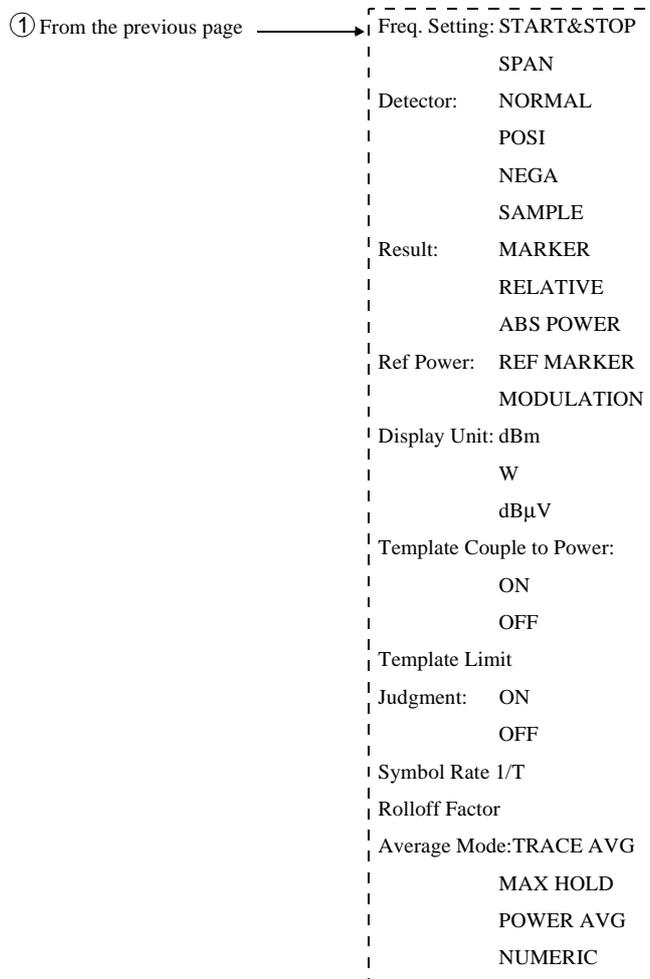

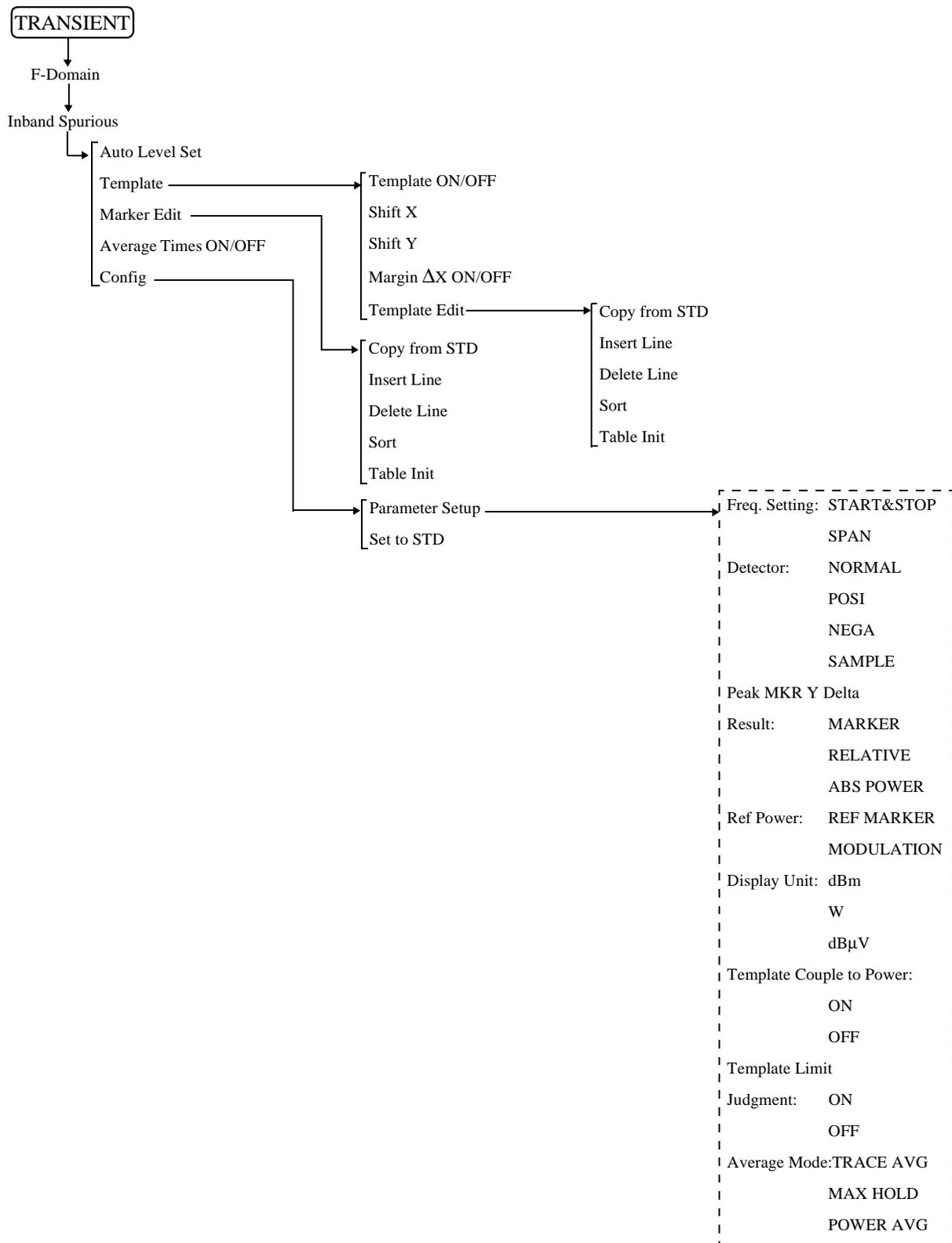

3.2 Menu Map

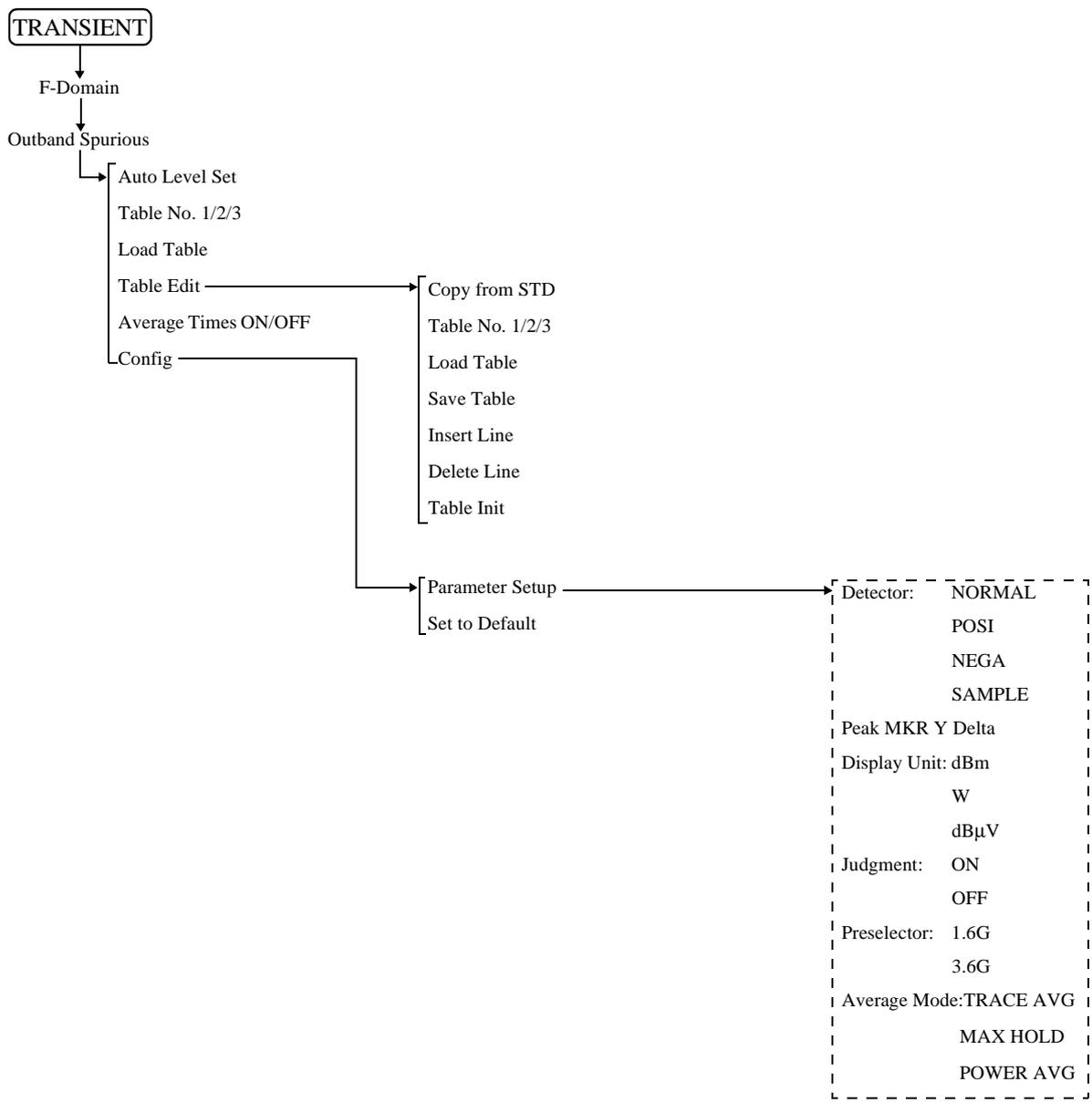

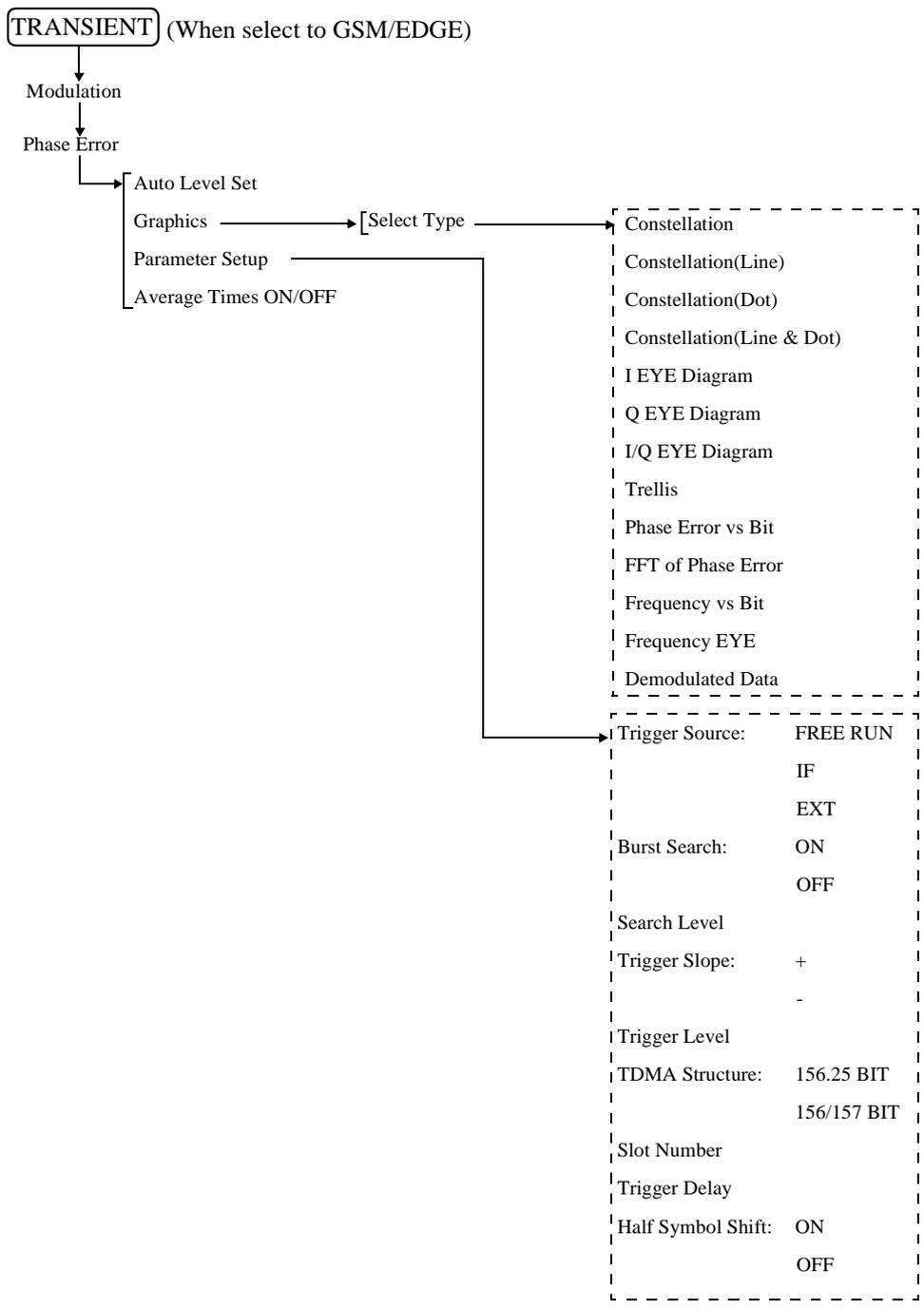

3.2 Menu Map

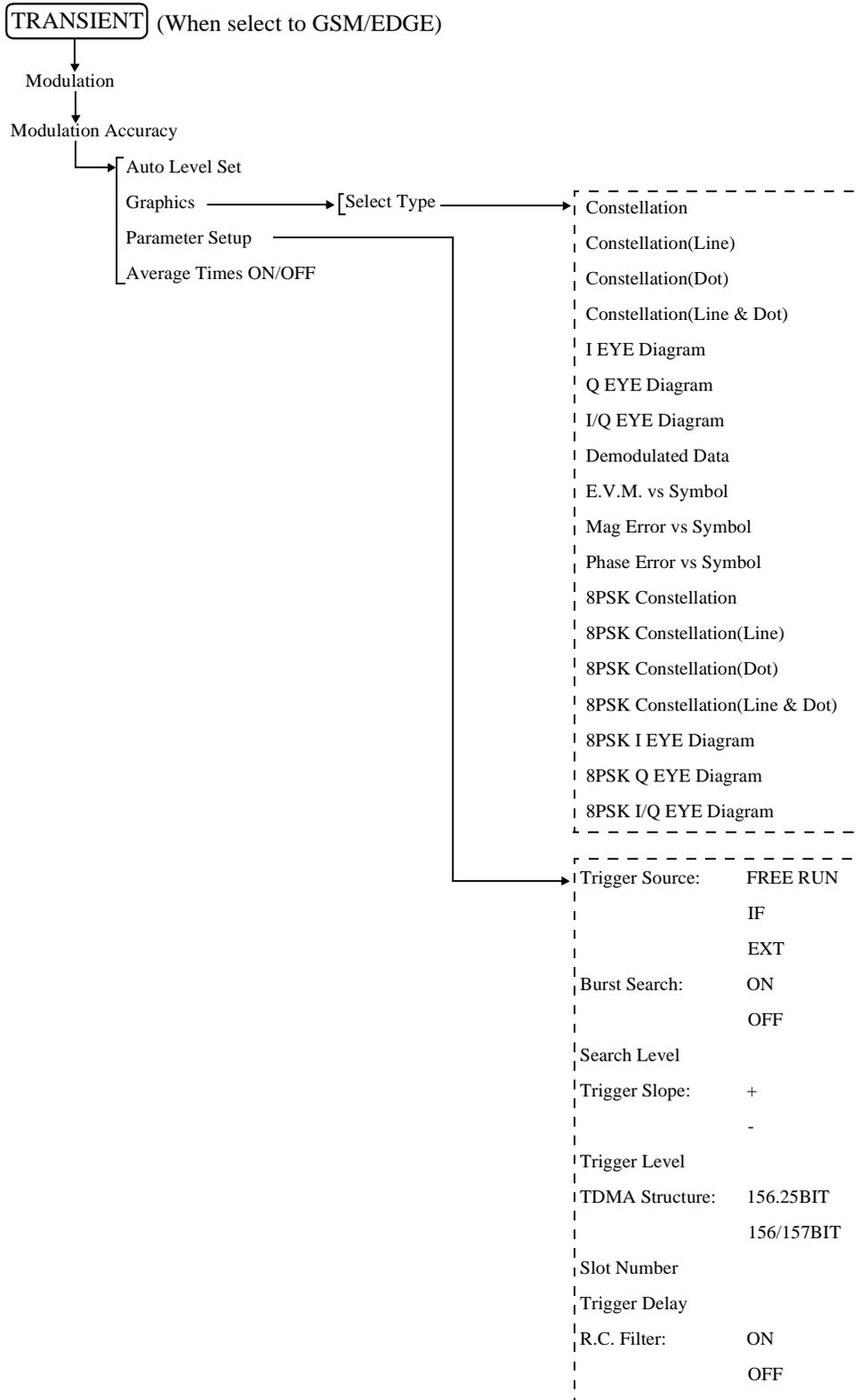

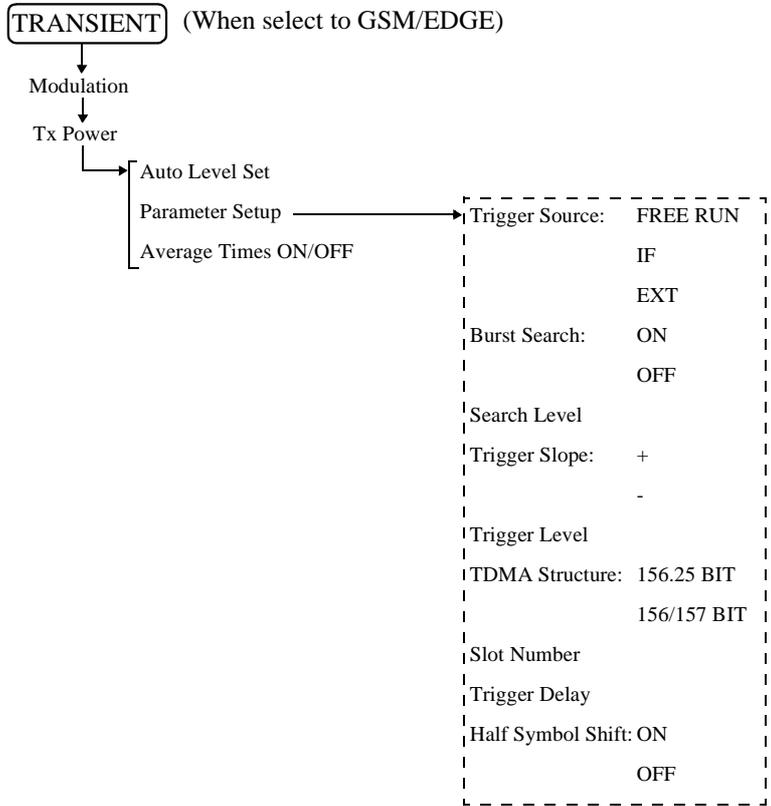

3.2 Menu Map

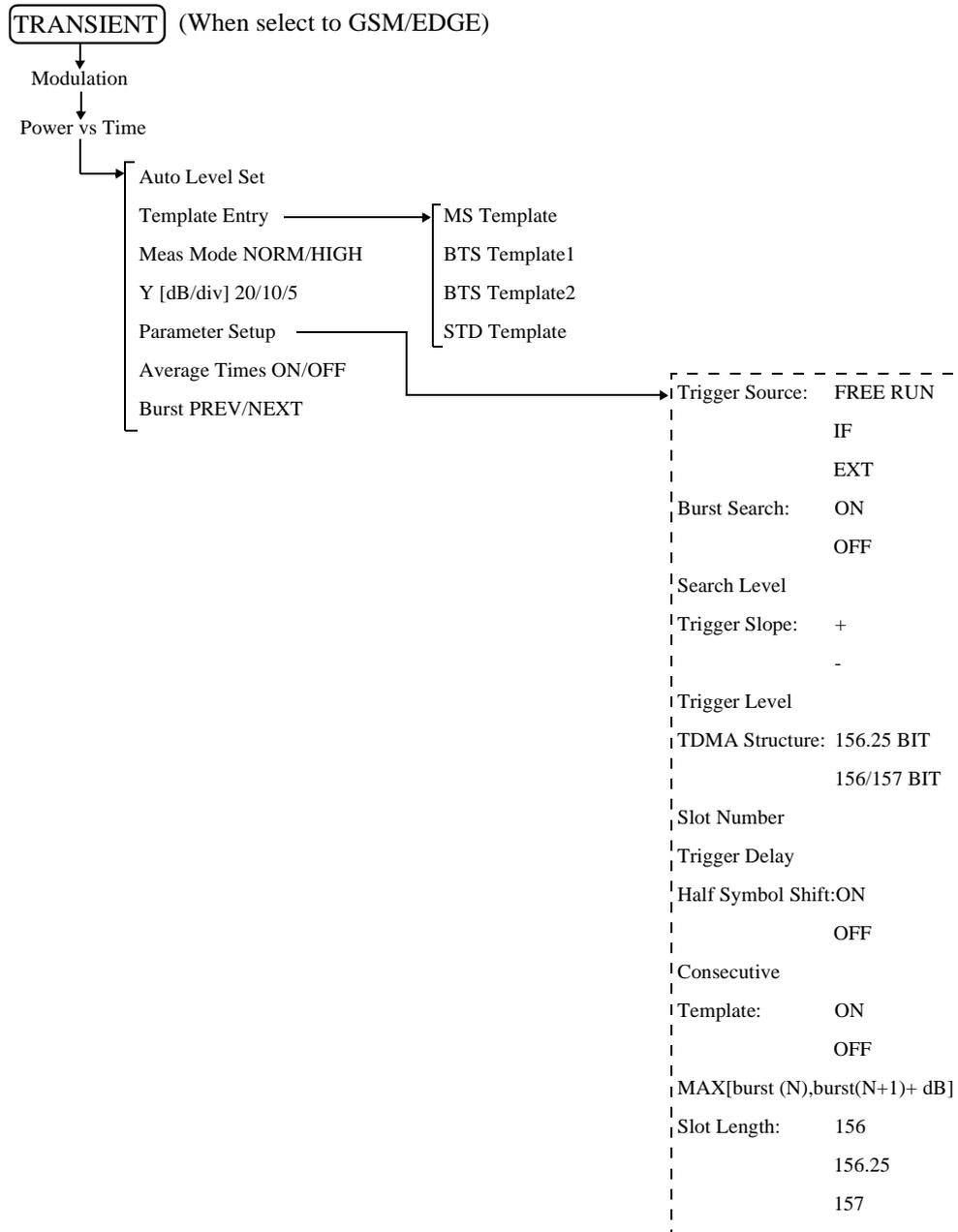

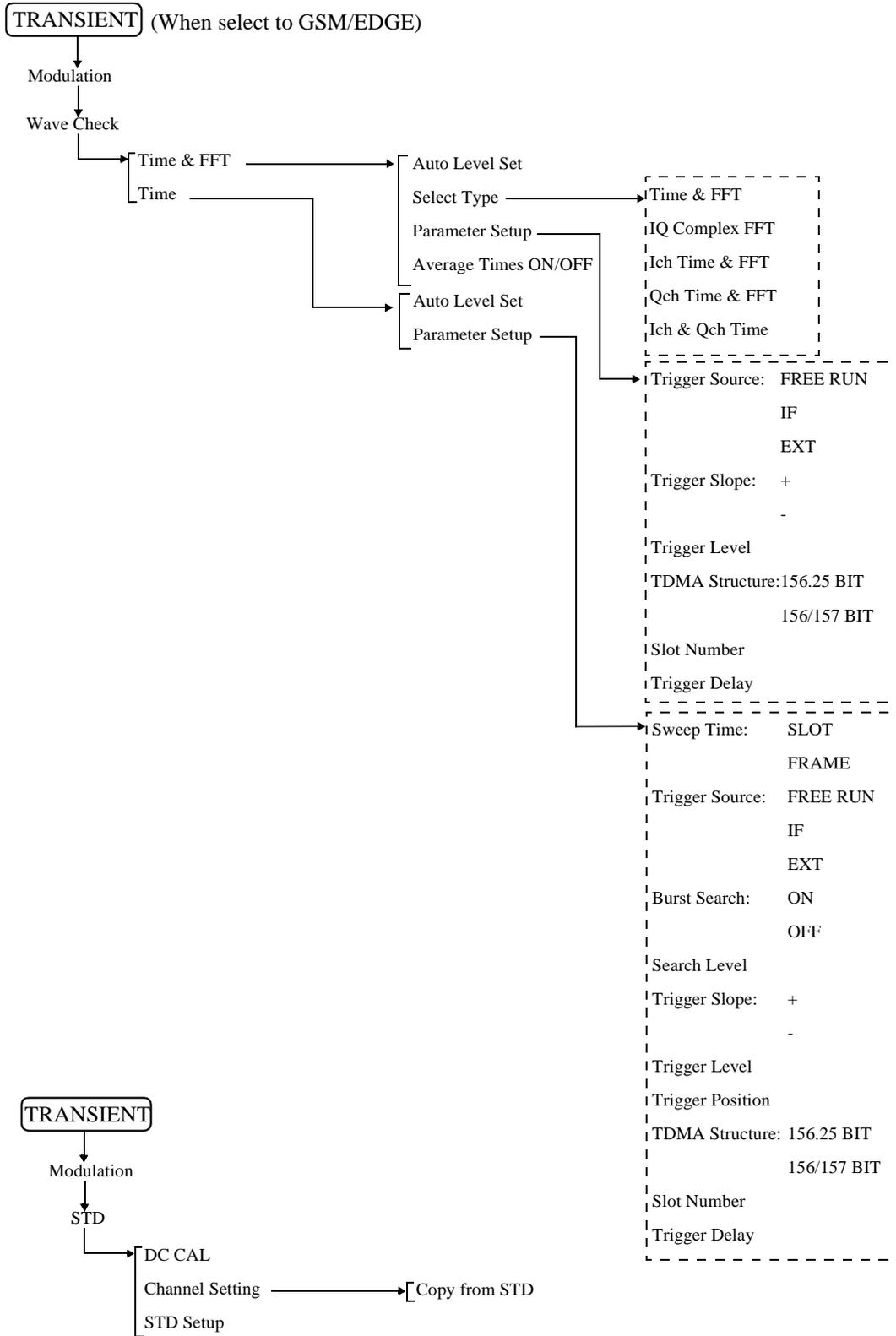

3.2 Menu Map

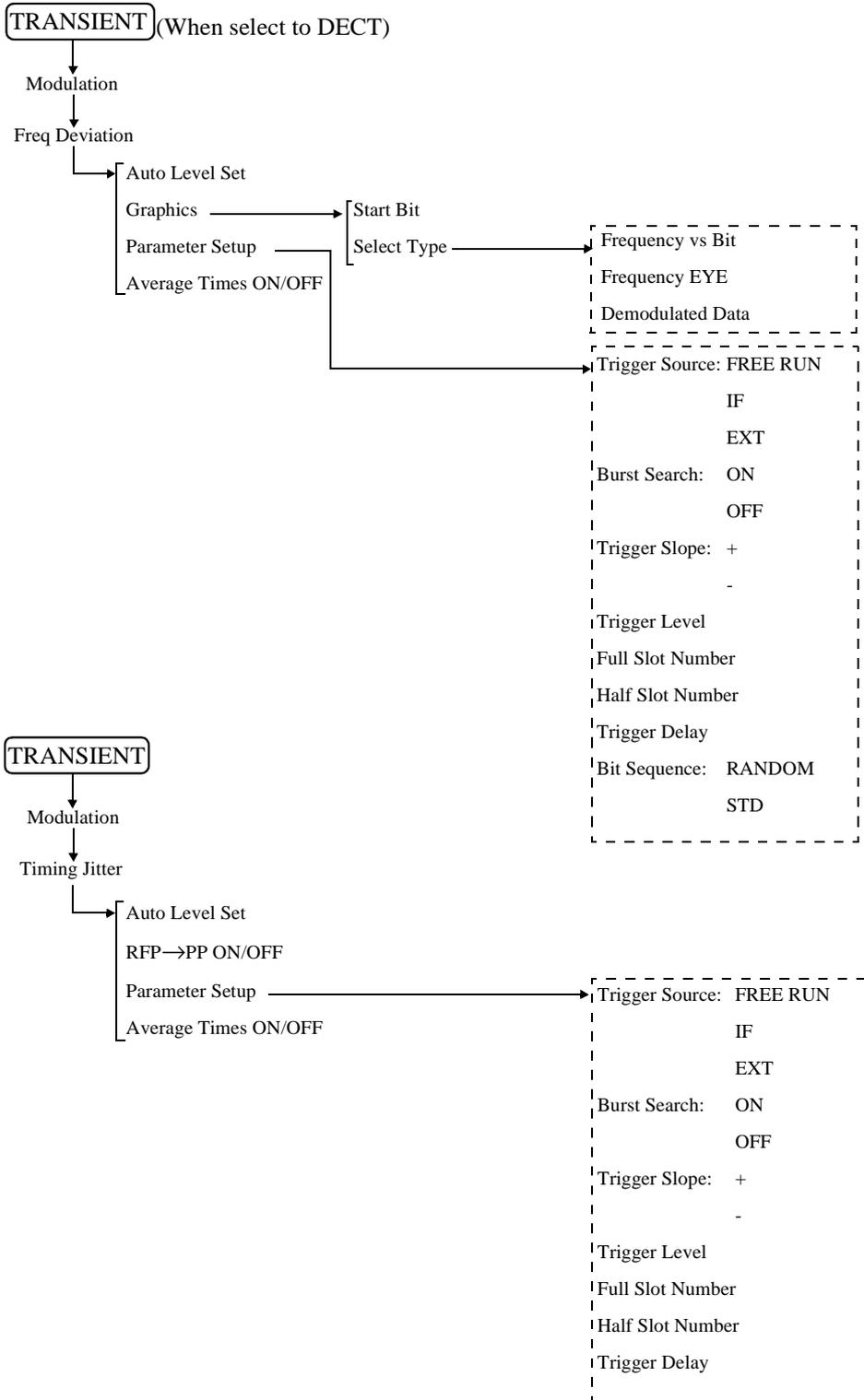

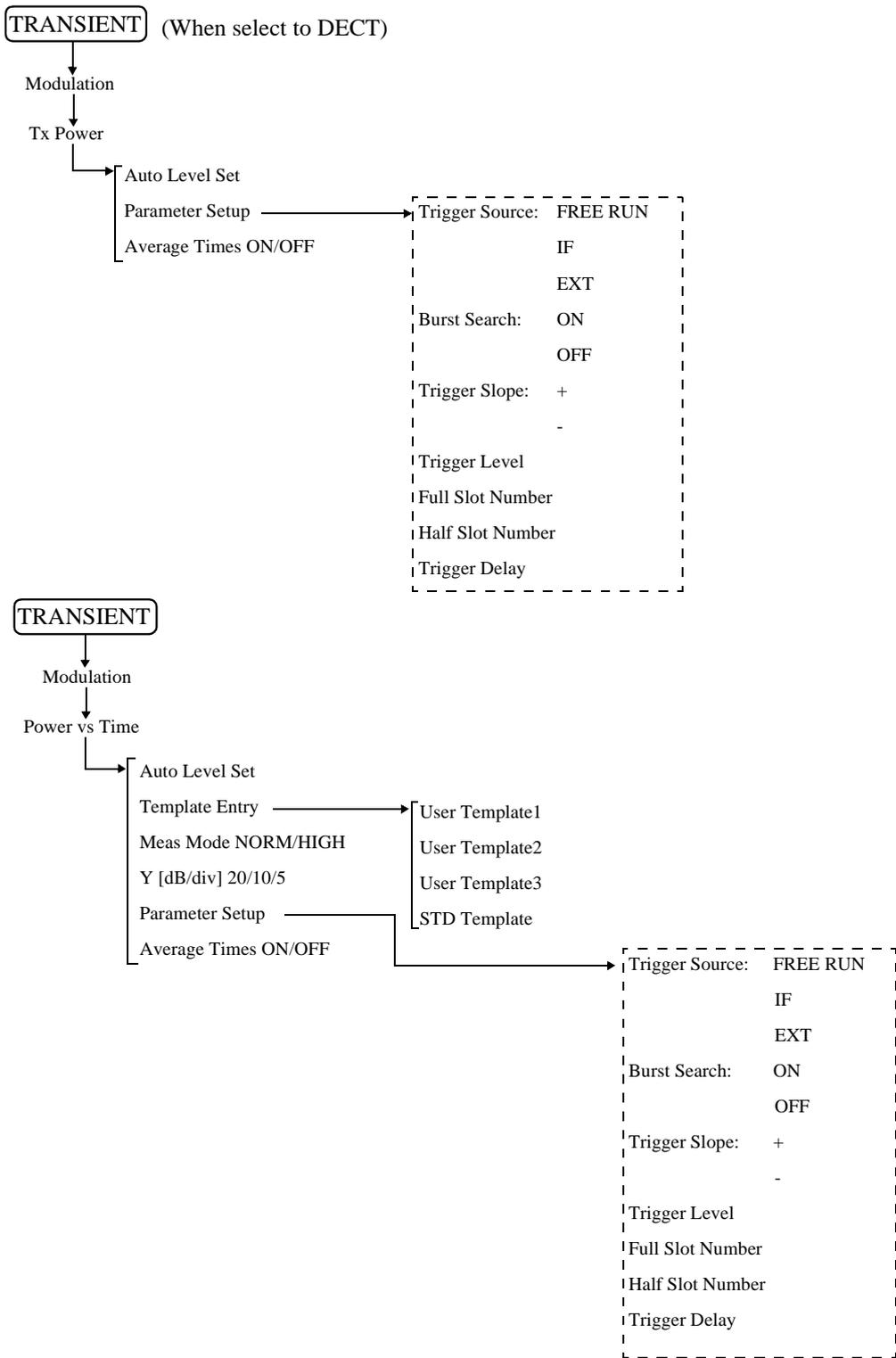

3.2 Menu Map

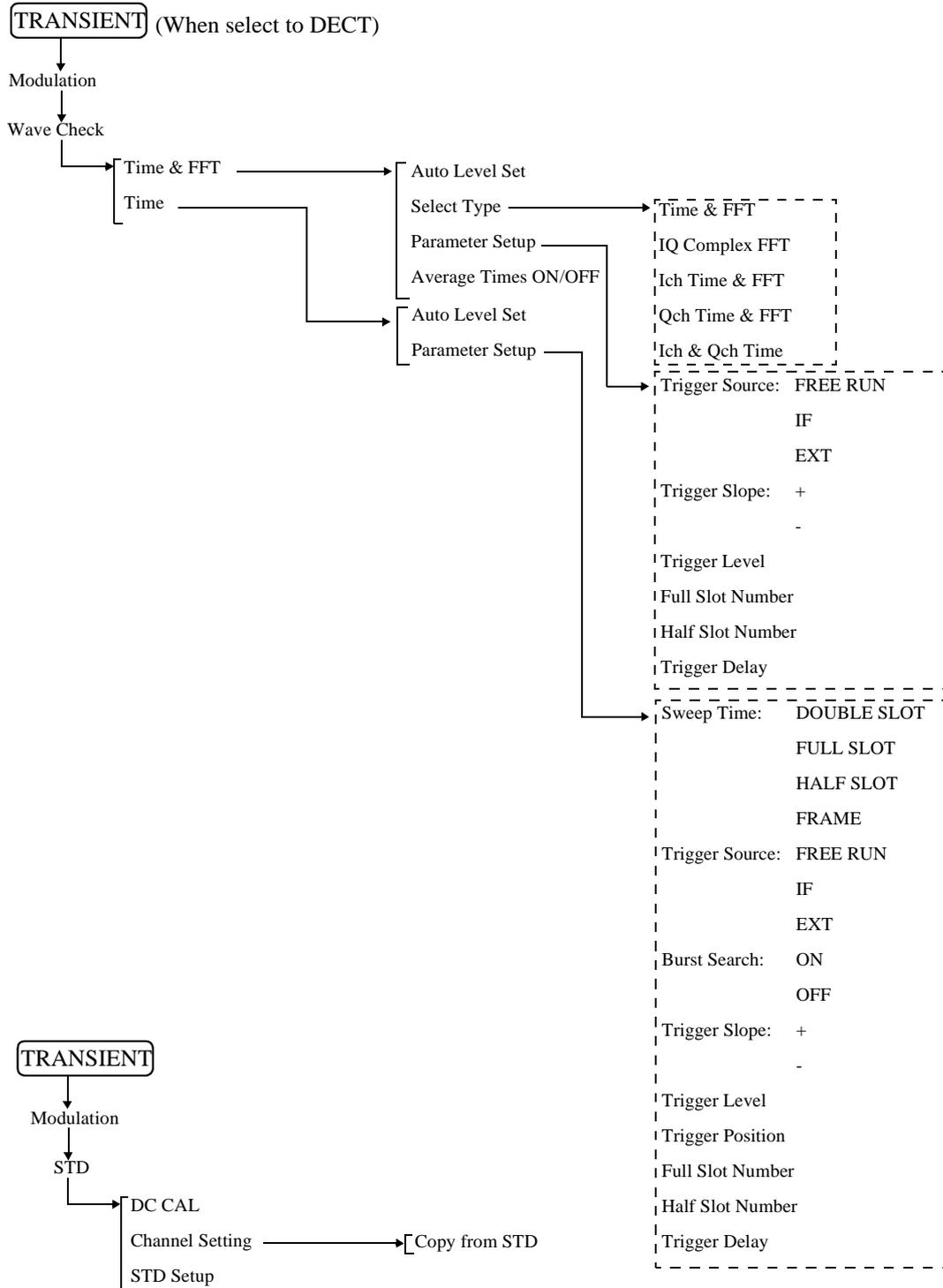

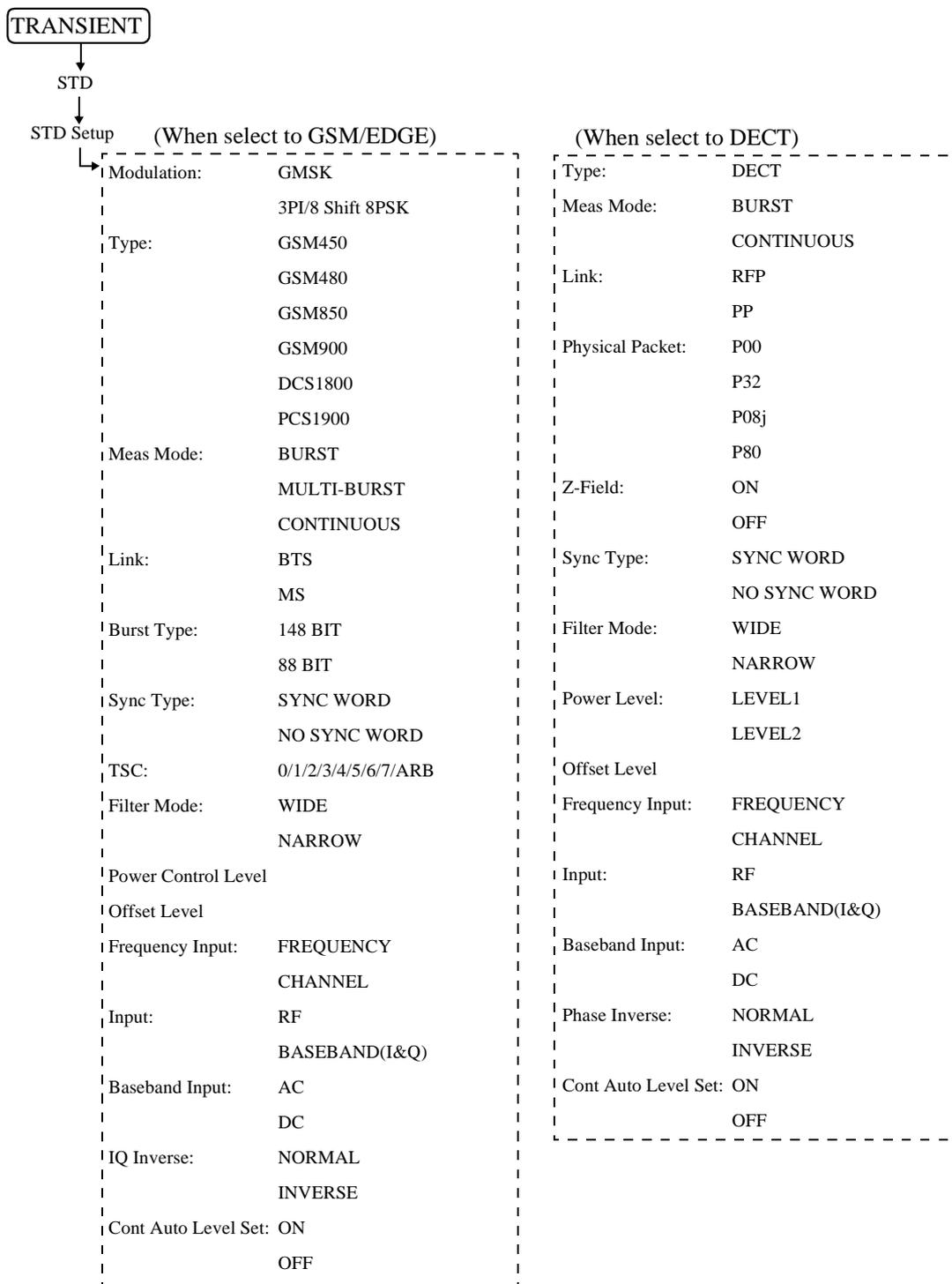

3.3 Functional Description

3.3 Functional Description

When modulation analysis hardware and software are installed, the following menus are assigned to the TRANSIENT key.

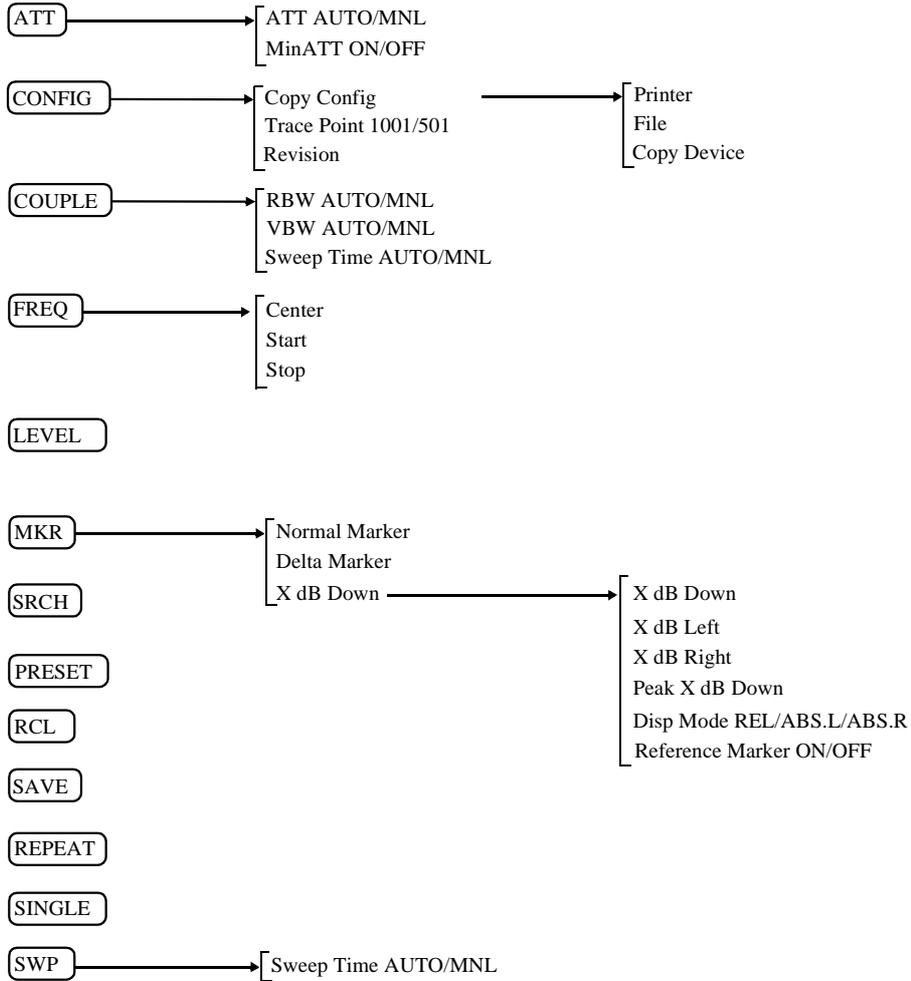

3.3.1 Switching Communication Systems

This section describes how to switch the communication systems. The analyzer must be set to the SPA mode to switch between the communication systems.

NOTE: *After the communication system has been switched, the parameters previously set for the former communication system will be cleared. If necessary, save the old parameters, before switching the communication system to another.*

Switching communication systems

1. Press the **POWER** to enter the SPA mode.
2. Press **CONFIG**.
3. Press *more 1/2*.
If there are other communication systems installed, with which this instrument can analyze, “Comm.System” is displayed in the soft menu.
4. Press *Comm.System*.
Select the communication system you wish using the data knob, and press the knob (or **ENTR**).

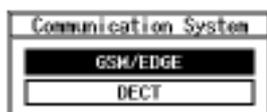

Figure 3-1 Dialog Box Used for the Communication Systems

5. When the data knob (or **ENTR**) is pressed, the message “LOADING” is displayed. After the message disappears, the switchover to another system is complete.
6. Press the **TRANSIENT** to confirm that the menu has been changed.

Saving set conditions

1. To save the parameters, press **SHIFT** and **RCL**.
2. Set the SAVE FILE number and press **Save**.

3.3.2 T-Domain

Carries out a measurement according to the standard using the zero span of the spectrum analyzer. Measurement items include power, ON/OFF ratio of a burst signal, and spurious measurements in the time domain with a specified frequency.

In the T-Domain measurement, the setting for the RBW, VBW, Sweep Time, or Detector is saved when exiting from each measurement and recalled when entering each measurement again. To return the setting to the value specified by the standard, press *Config* and *Set to STD*.

3.3 Functional Description

3.3.2.1 Power (T-Domain)

This is a function to measure power in the time domain (zero span).

There are two Pass/Fail judgment functions: a judgment function for the template and a judgment function for power.

NOTE: The RBW must be set wider than the modulation band.

Auto Level Set

Sets the internal reference level to an optimum value in accordance with the measurement signal. The reference level is automatically adjusted when this key is pressed.

NOTE: The input signal level must be constant while Auto Level Set is being carried out.

Trigger Setup

Sets a trigger.

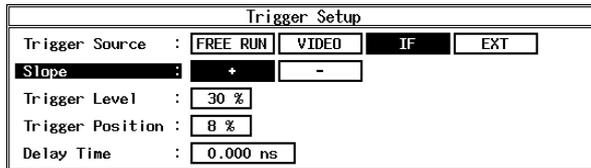

Figure 3-2 Trigger Setup Dialog Box

Trigger Source

Selects a trigger.

FREE RUN:

Captures data using the internal measurement timing.

VIDEO: Captures the signal in sync with the VIDEO signal.

IF: Captures the signal in sync with the IF signal (the leading edge of the burst).

EXT: Captures the signal in sync with the external trigger signal.

Slope

Selects the edge when triggering.

+: Triggers at the leading edge.

-: Triggers at the trailing edge.

Trigger Level

Sets the level to trigger.

Trigger Position

Sets the trigger position where it is displayed on the screen.

Delay Time

Sets a delay time from the time a trigger signal is detected to the time the signal is captured.

NOTE: *When Delay Time is a negative value, signals before the trigger can be captured.*

Window Setup

Sets the window used for power measurement.

Window ON/OFF

Displays a window showing the range for power measurement. When OFF is set, the power measurement range covers all points on the display screen.

Set to STD

Sets the window specified by the communication standard.

Window Position

Sets the position of the window.

Window Width

Sets the width of the window.

NOTE: *In the result screen, an arrow is displayed as appropriate when the entered Window position or Window width value exceeds its limit value.*

TemplateSets the template.
For more information, refer to Section 5.8.1, "Template Setting in the T-Domain Measuring Mode."**Template ON/OFF**

Sets whether to display the template and to toggles the Pass/Fail judgment function on or off.

Shift X

Sets the amount of template movement in the X-axis direction.

Shift Y

Sets the amount of template movement in the Y-axis direction.

Template Edit

Edits the template.

Template UP/LOW Selects the upper template or the lower template.**Copy from STD** Copies the template specified by the communication standard.**Insert Line** Inserts a line.**Delete Line** Deletes a line.**Sort** Sorts template data in ascending order.**Table Init** Initializes the table.**Y Scale [dB/div] 10/5/2**

Switches the display screen scale to 10, 5 or 2 dB/div.

3.3 Functional Description

Average Times ON/OFF

Sets the averaging count.
For the method of average processing, refer to "Average Mode" in the Config → Parameter Setup.

Config

Parameter Setup

Sets the method of measurement, edits the template, and so forth.

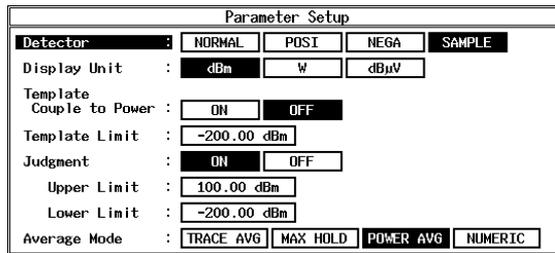

Figure 3-3 Parameter Setup Dialog Box

Detector

NORMAL/POSI/NEGA/SAMPLE
Selects the detector.

Display Unit

dBm/W/dBµV
Selects the display unit of power.

Template Couple to Power

Displays the template that is connected to the measured power.
ON: Displays the template that is connected to the measured power.
On the template edit screen, set the template level to the portion linked with the power value set to 0 dB.
OFF: Displays the template regarding the Y-axis value edited by the template as an absolute value.

Template Limit

If the absolute value of the template is smaller than this value when Template Couple to Power is set to ON, clip the template at this value.

Judgment

Sets ON/OFF for Pass/Fail judgments.

Upper Limit

Sets the upper limit value of power.

Lower Limit

Sets the lower limit value of power.

Average Mode

Selects the processing method when Average Times is set to ON.
TRACE AVG:
Calculates arithmetic average of the measured data (Log data) in the mode LOG.

MAX HOLD:

Displays the maximum value within the average counts of the swept waveforms.

POWER AVG:

Converts the measured data (Log data) to the linear data to take the root mean square value.

NUMERIC:

Converts the measured data (Log data) to the linear data to take the root mean square value.

NOTE: *Using POWER AVG display the average waveforms, using NUMERIC display the swept waveforms and takes an average of the measurement results only.*

Set to STD

Returns measurement parameters to the values specified by the communication standard.

3.3.2.2 ON/OFF Ratio

Measures the power during the burst-on period and the one during the burst-off period, and calculate the ratio of the powers.

Captures the signal with a trigger and calculates the ratio in reference to the burst on and burst off periods (the former is defined as the period immediately before the trigger point; the latter, immediately after the trigger point).

Auto Level Set

Sets the internal reference level to an optimum value in accordance with the measurement signal. The reference level is automatically adjusted when this key is pressed.

NOTE: *The signal level must remain constant while Auto Level Set is being carried out.*

Trigger Setup

Sets a trigger.

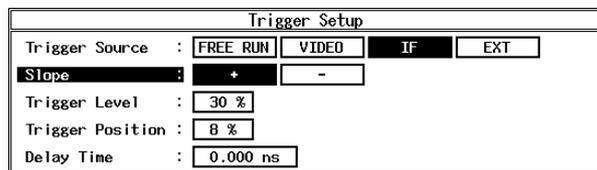

Figure 3-4 Trigger Setup Dialog Box

Trigger Source

Selects a trigger

FREE RUN:

Captures data using the internal measurement timing.

VIDEO: Captures the signal in sync with the VIDEO signal.

3.3 Functional Description

IF: Captures the signal in sync with the IF signal (the leading edge of the burst).

EXT: Captures the signal in sync with the external trigger signal.

Slope

Selects the edge when triggering.

+: Triggers at the leading edge.

-: Triggers at the trailing edge.

Trigger Level

Sets the level to trigger.

Trigger Position

Sets where the trigger position is displayed on the screen.

Delay Time

Sets a delay time from the time a trigger signal is detected to the time the signal is captured.

NOTE: When Delay Time is a negative value, signals before the trigger can be captured.

Window Setup

Sets the burst ON and OFF periods.

Window ON/OFF

Displays a window showing the range for power measurement.

Set to STD

Sets the value that is specified by or complies with the communication standard.

ON Position

Sets the desired position during the burst-on period.

ON Width

Sets the desired width during the burst-on period.

OFF Position

Sets the position during the burst-off period.

OFF Width

Sets the width during the burst-off period.

NOTE: In the result screen, an arrow is displayed as appropriate when the entered Window position or Window width value exceeds its limit value.

Y Scale [dB/div] 10/5/2

Selects the display screen scale to 10, 5 or 2 dB/div.

Average Times ON/OFF

Sets the averaging count.
For the method of average processing, refer to "Average Mode" in the Config → Parameter Setup.

Config

Parameter Setup

Sets the measurement parameters.

Parameter Setup				
Detector	: NORMAL	POSI	NEGA	SAMPLE
Display Unit	: dBm	W	dBμV	
Judgment	: ON	OFF		
Upper Limit	: -100.00	dB		
Average Mode	: TRACE AVG	MAX HOLD	POWER AVG	NUMERIC

Figure 3-5 Parameter Setup Dialog Box**Detector**

NORMAL/POSI/NEGA/SAMPLE

Selects the detector.

Display Unit

dBm/W/dBμV

Selects the display unit of power.

NOTE: The ON/OFF ratio is displayed in units of dB (fixed).

Judgment

Sets ON/OFF of the Pass/Fail judgment for the ON/OFF ratio.

Upper Limit

Enters the upper limit value.

Average Mode

Selects the processing method when Average Times is set to ON.

TRACE AVG:

Calculates arithmetic average of the measured data (Log data) in the mode LOG.

MAX HOLD:

Displays the maximum value within the average counts of the swept waveforms.

POWER AVG:

Converts the measured data (Log data) to the linear data to take the root mean square value.

NUMERIC:

Converts the measured data (Log data) to the linear data to take the root mean square value.

NOTE: Using **POWER AVG** display the average waveforms, using **NUMERIC** display the swept waveforms and takes an average of the measurement results only.

Set to STD

Sets measurement parameters to the values specified by the communication standard.

3.3 Functional Description

3.3.2.3 Spurious (T-Domain)

This is a function to measure power (or peak power) according to the frequency specified in the table by sweeping in the zero span mode.

Auto Level Set

Sets the internal reference level to an optimum value in accordance with the measurement signal. The reference level is automatically adjusted when this key is pressed.

NOTE: The signal level must be constant while Auto Level Set is being carried out.

Trigger Setup

Sets a trigger.

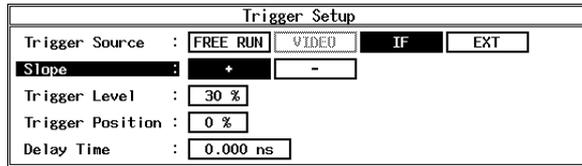

Figure 3-6 Trigger Setup Dialog Box

Trigger Source

Selects a trigger

FREE RUN:

Captures data using the internal measurement timing.

IF: Captures the signal in sync with the IF signal (the leading edge of the burst).

EXT: Captures the signal in sync with the external trigger signal.

Slope

Selects the edge when triggering.

+: Triggers at the leading edge.

-: Triggers at the trailing edge.

Trigger Level

Sets the level to trigger.

Trigger Position

Sets where the trigger position is displayed on the screen.

Delay Time

Sets a delay time from the time a trigger signal is detected to the time the signal is captured.

NOTE: When Delay Time is a negative value, signals before the trigger can be captured.

Table No. 1/2/3

Selects the measurement table.

Load Table	Loads the measurement table.
Table Edit	Edits the measurement table.
Table No. 1/2/3	Selects the table to be edited.
Load Table	Loads the measurement table.
Save Table	Saves the measurement table.
Insert Line	Inserts additional frequency data before the selected frequency number.
Delete Line	Deletes the selected line.
Table Init	Initializes the table
Average Times ON/OFF	Sets the averaging count. For the method of average processing, refer to "Average Mode" in the Config → Parameter Setup.

Config**Parameter Setup**

Sets measurement conditions.

Parameter Setup	
Detector :	NORMAL POSI NEGA SAMPLE
Result :	PEAK RMS
Peak MKR Y Delta :	
Multiplier :	1.000
Display Unit :	dBm W dBµV
Judgment :	ON OFF
Preselector :	1.6G 3.6G
Average Mode :	TRACE AVG MAX HOLD POWER AVG NUMERIC

Figure 3-7 Parameter Setup Dialog Box

Detector	NORMAL/POSI/NEGA/SAMPLE Selects the detector.
Result	PEAK/RMS Selects whether to display the result using average power or peak power.
Peak MKR Y Delta	Sets the Y delta of the peak marker.
Multiplier	Multiplies the measurement result by the set value, then displays the resultant value.
Display Unit	dBm/W/dBµV Selects the display units.

3.3 Functional Description

Judgment Sets ON/OFF of the Pass/Fail judgment for the limit value.

Preselector Sets the preselector.

NOTE: *This menu is displayed on R3267 only.*

1.6G: Used to measure harmonics of more than 1.6 GHz or spurious signals when the carrier frequency is lower than 1.6 GHz.

3.6G: Used to set this parameter for cases other than that above.

Average Mode Selects the processing method when Average Times is set to ON.

TRACE AVG:
Calculates arithmetic average of the measured data (Log data) in the mode LOG.

MAX HOLD:
Displays the maximum value within the average counts of the swept waveforms.

POWER AVG:
Converts the measured data (Log data) to the linear data to take the root mean square value.

NUMERIC:
Converts the measured data (Log data) to the linear data to take the root mean square value.

NOTE: *Using POWER AVG display the average waveforms, using NUMERIC display the swept waveforms and takes an average of the measurement results only.*

Set to Default Returns the set value to the default.

3.3.2.4 Due to Modulation (T-Domain)

This is a function to measure power (or peak power) within the burst period according to the frequency specified in the table by sweeping in the zero span mode.

Auto Level Set Sets the internal reference level to an optimum value in accordance with the measurement signal. The reference level is automatically adjusted when this key is pressed.

NOTE: *This signal level must be constant while Auto Level Set is being carried out.*

Trigger Setup

Sets a trigger.

Trigger Setup	
Trigger Source :	FREE RUN VIDEO IF EXT
Slope :	+ -
Trigger Level :	30 %
Trigger Position :	9 %
Delay Time :	0.000 ns

Figure 3-8 Trigger Setup Dialog Box**Trigger Source**

Selects a trigger.

FREE RUN:

Captures data using the internal measurement timing.

IF: Captures the signal in sync with the IF signal (the leading edge of the burst) .

EXT: Captures the signal in sync with the external trigger signal.

Slope

Selects the edge when triggering.

+: Triggers at the leading edge.

-: Triggers at the trailing edge.

Trigger Level

Sets the level to trigger.

Trigger Position

Sets where the trigger position is displayed on the screen.

Delay Time

Sets a delay time from the time a trigger signal is detected to the time the signal is captured.

Window Setup

Sets the window used for power measurement (or peak search).

Window ON/OFF

Displays a window showing the range for power measurement (or peak search).

When OFF is set, the power measurement (or peak search) range covers all points on the display screen.

Set to STD

Sets the window specified by the communication standard.

Window Position

Sets the position of the window.

Window Width

Sets the width of the window.

Table Edit

Edits the measurement table.

Table No. 1/2/3

Selects the table to be edited.

Load Table

Loads the measurement table.

Save Table

Saves the measurement table.

3.3 Functional Description

<i>Insert Line</i>	Inserts additional frequency data before the selected frequency number.
<i>Delete Line</i>	Delete the selected line.
<i>Table Init</i>	Initialize the table.
<i>Average Times ON/OFF</i>	Sets the averaging count. For the method of average processing, refer to "Average Mode" in the Config → Parameter Setup.
<i>Config</i>	
<i>Parameter Setup</i>	Sets the measurement parameters.

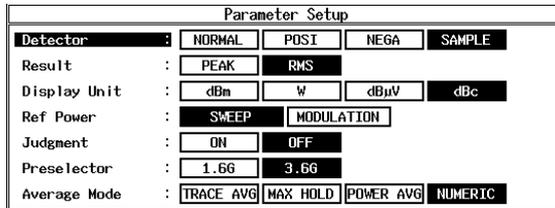

Figure 3-9 Parameter Setup Dialog Box

<i>Detector</i>	NORMAL/POSI/NEGA/SAMPLE Selects the detector.
<i>Result</i>	PEAK/RMS Selects whether to display the result using average power or peak power.
<i>Display Unit</i>	dBm/W/dBµV/dBc Selects the display units.
<i>Ref Power</i>	When the dBc is selected for Result, this selects which relative value to use to display the result value. SWEEP: Displays a relative value to averaged power of swept data. MODULATION: Displays a relative value to the measurement result of Tx Power in the Modulation.
<i>Judgment</i>	Sets the ON/OFF of the Pass/Fail judgment for the limit value.
<i>Preselector</i>	Sets the preselector.

NOTE: This menu is displayed on R3267 only.

1.6G: Used to measure harmonics of more than 1.6Ghz or spurious signal when the carrier frequency is lower than 1.6GHz.

3.6G: Used to set this parameter for cases other than that above.

Average Mode

Selects the processing method when Average Times is set to ON.

TRACE AVG:

Calculates arithmetic average of the measured data (Log data) in the mode LOG.

MAX HOLD:

Displays the maximum value within the average counts of the swept waveforms.

POWER AVG:

Converts the measured data (Log data) to the linear data to take the root mean square value.

NUMERIC:

Converts the measured data (Log data) to the linear data to take the root mean square value.

NOTE: *Using POWER AVG display the average waveforms, using NUMERIC display the swept waveforms and takes an average of the measurement results only.*

Set to STD

Sets the window specified by the communication standard.

3.3.3 F-Domain

Carries out a measurement according to the communication standard using the spectrum analyzer's sweep measurement method. Measurement items include power, occupied bandwidth, Due To Switching, Due to Modulation, Inband Spurious, and Outband Spurious measurements in the frequency domain.

In F-Domain measurement, the setting for the RBW, VBW, Sweep Time, or Detector is saved when exiting each measurement and recalled when entering each measurement again. To return the setting to the value specified by the standard, press **Config** and **Set to STD**.

3.3.3.1 Power (F-Domain)

This is a function to measure power in the frequency domain using the spectrum analyzer.

Auto Level Set

Sets the internal reference level to an optimum value in accordance with the measurement signal. The reference level is automatically adjusted when this key is pressed.

NOTE: *The signal level must be constant while Auto Level Set is being carried out.*

3.3 Functional Description

Gate Setup

Sets the gated sweep.
This setting is required when the input signal is a bursted signal and Sample Detector is used.

Trigger Setup

Sets a trigger.

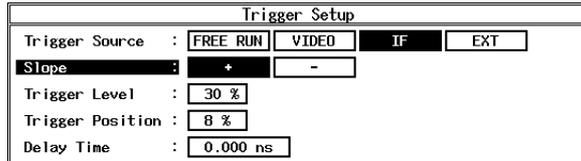

Figure 3-10 Trigger Setup Dialog Box

Trigger Source

Selects a trigger

FREE RUN:

Captures data using the internal measurement timing.

VIDEO: Captures the signal in sync with the VIDEO signal.

IF: Captures the signal in sync with the IF signal (the leading edge of the burst).

EXT: Captures the signal in sync with the external trigger signal.

Slope

Selects the edge when triggering.

+: Triggers at the leading edge.

-: Triggers at the trailing edge.

Trigger Level

Sets the level to trigger.

Trigger Position

Sets where the trigger position is displayed on the screen.

Delay Time

Sets a delay time from the time a trigger signal is detected to the time the signal is captured.

NOTE: When Delay Time is a negative value, signals before the trigger can be captured.

Gate Source

Trigger

Sets Trigger Source specified by Trigger Setup as Gate Source.

NOTE: When Trigger Source is set to IF and SPAN is set to a frequency higher than 6 MHz, the sweeping seems to be stopped, because the IF trigger bandwidth is approximately 6 MHz and the gate trigger is failing.

<i>Ext Gate</i>	Sets the gated sweep mode using the gate signal input from the EXT GATE terminal on the rear panel.
<i>Gate Setup</i>	Sets the gated sweep range when Trigger is selected for Gate Source.
<i>Set to STD</i>	Sets the gate position and width to the values specified by the communication standard.
<i>Gate Position</i>	Sets the gate position.
<i>Gate Width</i>	Sets the gate width.
<i>Gated Sweep ON/OFF</i>	Starts the gated sweep.
<i>Detector</i>	NORMAL/POSI/NEGA/SAMPLE Selects the detector.

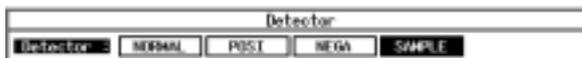

Figure 3-11 Detector Dialog Box

<i>Window Setup</i>	Sets the frequency range used for power measurement.
<i>Window ON/OFF</i>	Sets the window to ON or OFF. When the window is set to OFF, the power measurement range becomes a sweep band.
<i>Set to STD</i>	Sets the value determined by the communication standard.
<i>Window Position</i>	Sets the position of the window.
<i>Window Width</i>	Sets the width of the window.

NOTE: In the result screen, an arrow is displayed as appropriate when the entered Window position or Window width value exceeds its limit value.

<i>Y Scale [dB/div] 10/5/2</i>	Sets the display scale.
<i>Average Times ON/OFF</i>	Sets the averaging count. For the method of average processing, refer to "Average Mode" in the Config → Parameter Setup.
<i>Config</i>	

3.3 Functional Description

Parameter Setup

Sets measurement conditions.

Parameter Setup			
Detector	:	NORMAL	POSI
		NEGA	SAMPLE
Gated Sweep	:	ON	OFF
Display Unit	:	dBm	W
		dBμV	
Judgment	:	ON	OFF
Upper Limit	:	100.00 dBm	
Lower Limit	:	-200.00 dBm	
Average Mode	:	TRACE AVG	MAX HOLD
		POWER AVG	NUMERIC

Figure 3-12 Parameter Setup Dialog Box

- Detector** NORMAL/POSI/NEGA/SAMPLE
Selects the detector.
- Gated Sweep** Sets the gated sweep to ON or OFF.
- Display Unit** dBm/W/dBμV
Selects the display unit.
- Judgment** Sets ON/OFF of the Pass/Fail judgment for measured power.
- Upper Limit** Sets the upper limit for Pass/Fail judgment.
- Lower Limit** Sets the lower limit for Pass/Fail judgment.
- Average Mode** Selects the processing method when Average Times is set to ON.
TRACE AVG:
Calculates arithmetic average of the measured data (Log data) in the mode LOG.
MAX HOLD:
Displays the maximum value within the average counts of the swept waveforms.
POWER AVG:
Converts the measured data (Log data) to the linear data to take the root mean square value.
NUMERIC:
Converts the measured data (Log data) to the linear data to take the root mean square value.

NOTE: *Using POWER AVG display the average waveforms, using NUMERIC display the swept waveforms and takes an average of the measurement results only.*

Set to STD

Sets the measurement parameters to the values specified by the communication standard.

3.3.3.2 OBW

Measure an occupied bandwidth.

Auto Level Set

Sets the internal reference level to an optimum value in accordance with the measurement signal. The reference level is automatically adjusted when this key is pressed.

NOTE: *The signal level must be constant while Auto Level Set is being carried out.*

OBW%

Sets the frequency, including the percentage of the total power as an occupied bandwidth, when calculating the occupied bandwidth.

Average Times ON/OFF

Sets the averaging count.

For the method of average processing, refer to "Average Mode" in the Config → Parameter Setup.

Config

Parameter Setup

Sets measurement conditions and so on.

Parameter Setup	
Detector :	NORMAL POSI NEGA SAMPLE
Judgment :	ON OFF
Upper Limit :	2.500 MHz
Lower Limit :	750 kHz
Average Mode :	TRACE AVG MAX HOLD POWER AVG NUMERIC

Figure 3-13 Parameter Setup Dialog Box

Detector

NORMAL/POSI/NEGA/SAMPLE

Selects the detector.

Judgment

Sets ON/OFF of the Pass/Fail judgment for the occupied bandwidth.

Upper Limit

Sets the upper limit for Pass/Fail judgment.

Lower Limit

Sets the lower limit for Pass/Fail judgment.

Average Mode

Selects the processing method when Average Times is set to ON.

TRACE AVG:

Calculates OBW based on the waveforms, which were generated as a result of arithmetic average of the measured data (Log data) in the log mode.

3.3 Functional Description

MAX HOLD:

Calculates OBW based on the waveform with the maximum value within the average counts of measured data.

POWER AVG:

Calculates OBW based on the waveforms, which were calculated as a result of the conversion of the measured data (Log data) to the linear data to take the root mean square.

NUMERIC:

Calculates OBW by sweep and calculates arithmetic average to display the result. The displayed waveforms are not averaged.

Set to STD

Sets the measurement parameters to the values specified by the communication standard.

3.3.3.3 Due to Transient

This is a function to measure the spectrum, including the rise and fall times of the burst.

Auto Level Set

Sets the internal reference level to an optimum value in accordance with the measurement signal. The reference level is automatically adjusted when this key is pressed.

NOTE: The signal level must be constant while Auto Level Set is being carried out.

Template

Sets and edits the template.
For more information, refer to Section 5.8.2, "Template Setting in the F-Domain Measuring Mode."

Template ON/OFF

Sets ON/OFF of the template display.
When Template is set to ON, the Pass/Fail judgment for the template is displayed under the sweep screen.

Shift X

Shifts the set template in the frequency direction (X-axis).

Shift Y

Shifts the set template in the level direction (Y-axis).

Margin ΔX ON/OFF

Magnifies the template in the X-axis direction with a set template frequency 0 as the center.

Template Edit

Opens the template edit menu.

Copy from STD

Copies the template of the communication standard.
(Displayed only when GSM/EDGE is selected.)

Insert Line

Inserts a line before the selected line.

<i>Delete Line</i>	Deletes the selected line.
<i>Sort</i>	Sorts the tables in order of frequency.
<i>Table Init</i>	Initializes the table.
<i>Marker Edit</i>	Sets the measurement frequency (frequency offset) and measurement band. For more information, refer to Section 5.9.1, "Marker Edit Function."
<i>Copy from STD</i>	Sets to the parameters specified by the communication standard. (Displayed only when GSM/EDGE is selected.)
<i>Insert Line</i>	Inserts a line before the selected line.
<i>Delete Line</i>	Deletes the selected line.
<i>Sort</i>	Sorts data in order of frequency.
<i>Table Init</i>	Initializes the table.
<i>Average Times ON/OFF</i>	Sets the averaging count. For the method of average processing, refer to "Average Mode" in the Config → Parameter Setup.

Config

Parameter Setup

Sets measurement conditions and so on.
For more information, refer to Section 5.9.2, "Measurement results Using Due to Modulation, Due to Transient and Inband Spurious Modes."

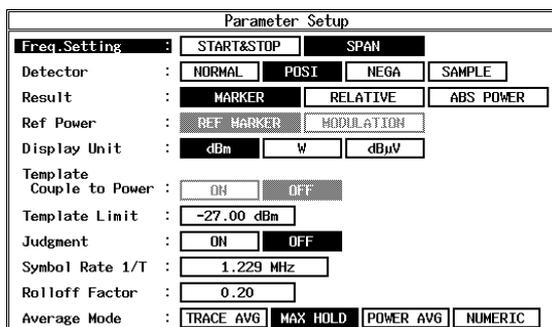

Figure 3-14 Parameter Setup Dialog Box

<i>Freq. Setting</i>	START&STOP/SPAN Selects the measurement mode.
<i>Detector</i>	NORMAL/POST/NEGA/SAMPLE Selects the detector.

3.3 Functional Description

Result	<p>Specifies how to display the result.</p> <p>MARKER: Displays the marker read value. The position of the marker is set by Marker Edit.</p> <p>RELATIVE: Displays the marker read value using a relative value.</p> <p>ABS POWER: Converts the value displayed by RELATIVE into the absolute value using carrier power and displays it.</p>
Ref Power	<p>When RELATIVE is selected for Result, this selects which relative value to use to display the marker read value.</p> <p>REF MARKER: Displays a relative value to Ref Marker set by Marker Edit.</p> <p>MODULATION: Displays a relative value to the measurement result of Tx power in Modulation.</p>
Display Unit	<p>dBm/W/dBμV Selects the unit of the result displayed.</p> <hr/> <p>NOTE: When RELATIVE is selected for Result, the unit is dB.</p> <hr/>
Template Couple to Power	<p>Sets whether to raise or lower the template with the power set by Ref Power.</p>
Template Limit	<p>If the absolute value of the template is smaller than this value when Template Couple to Power is set to ON, clip the template at this value.</p>
Judgment	<p>Used to make the Pass/fail judgment for the limit value set by Marker edit. The Pass/Fail judgment result is displayed under the display screen together with the marker list.</p>
Symbol Rate 1/T	<p>Sets the symbol rate for the Root Nyquist filter.</p>
Rolloff Factor	<p>Sets the roll-off factor for the Root Nyquist filter.</p>
Average Mode	<p>Selects the processing method when Average Times is set to ON.</p> <p>TRACE AVG: Calculates arithmetic average of the measured data (Log data) in the mode LOG.</p> <p>MAX HOLD: Displays the maximum value within the average counts of the swept waveforms.</p>

POWER AVG:

Converts the measured data (Log data) to the linear data to take the root mean square value.

NUMERIC:

Converts the measured data (Log data) to the linear data to take the root mean square value.

NOTE: *Using POWER AVG display the average waveforms, using NUMERIC display the swept waveforms and takes an average of the measurement results only.*

Set to STD

Returns the measurement parameters to the values specified by the standard.
(Displayed only when GSM/EDGE is selected.)
For the method of switching between the systems, refer to Section 3.3.1, "Switching Communication Systems."

3.3.3.4 Due to Modulation

Measure the modulation spectrum excluding the rise and fall of the burst.

Auto Level Set

Sets the internal reference level to an optimum value in accordance with the measurement signal. The reference level is automatically adjusted when this key is pressed.

NOTE: *The signal level must be constant while Auto Level Set is being carried out.*

Gate Setup

Sets the gated sweep.

Trigger Setup

Sets a trigger.

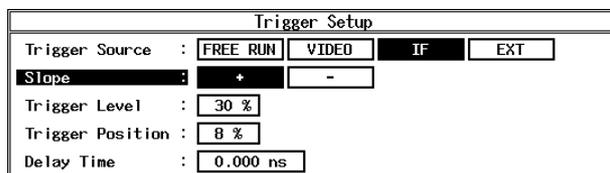

Figure 3-15 Trigger Setup Dialog Box

Trigger Source

Selects a trigger.

FREE RUN:

Captures data using the internal measurement timing.

VIDEO: Captures the signal in sync with the VIDEO signal.

IF: Captures the signal in sync with the IF signal (the leading edge of the burst).

3.3 Functional Description

	EXT:	Captures the signal in sync with the external trigger signal.
Slope		Selects the edge when triggering.
	+	Triggers at the leading edge.
	-	Triggers at the trailing edge.
Trigger Level		Sets the level to trigger.
Trigger Position		Sets where the trigger position is displayed on the screen.
Delay Time		Sets a delay time from the time a trigger signal is detected to the time the signal is captured.
<hr/> <p>NOTE: When Delay Time is a negative value, signals before the trigger can be captured.</p> <hr/>		
Gate Source		
Trigger		Sets Trigger Source specified by Trigger Setup as Gate Source.
<hr/> <p>NOTE: When Trigger Source is set to IF and SPAN is set to a frequency higher than 6 MHz, the sweeping seems to be stopped, because the IF trigger bandwidth is approximately 6 MHz and the gate trigger is failing.</p> <hr/>		
Ext Gate		Performs the gated sweep using the gate signal input from the EXT Gate terminal on the rear panel.
Gate Setup		Sets the gated sweep range when Trigger is selected for Gate Source.
Set to STD		Sets the gate position and width to the values specified by the communication standard.
Gate Position		Sets the gate position.
Gate Width		Sets the gate width.
Gated Sweep ON/OFF		Starts the gated sweep.
Detector		NORMAL/POSI/NEGA/SAMPLE Selects the detector.

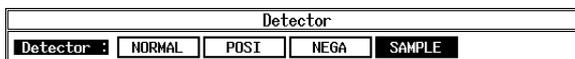

Figure 3-16 Detector Dialog Box

Template	Sets and edits the template. For more information, refer to Section 5.8.2, "Template Setting in the F-Domain Measuring Mode."
Template ON/OFF	Sets the template display to ON or OFF. When Template is set to ON, the Pass/Fail judgment for the template is displayed under the sweep screen.
Shift X	Shifts the set template in the frequency direction (X-axis).
Shift Y	Shifts the set template in the level direction (Y-axis).
Margin ΔX ON/OFF	Magnifies the template in the X-axis direction with a set template frequency 0 as the center.
Template Edit	
Copy from STD	Copies the template specified by the communication standard.
Insert Line	Inserts a line before the selected line.
Delete Line	Deletes the selected line.
Sort	Sorts the tables in frequency order.
Table Init	Initializes the table.
Marker Edit	Sets the measurement frequency (frequency offset) and measurement band. For more information, refer to Section 5.9.1, "Marker Edit Function."
Copy from STD	Sets to the parameters specified by the communication standard.
Insert Line	Inserts a line before the selected line.
Delete Line	Deletes the selected line.
Sort	Sorts data in order of frequency.
Table Init	Initializes the table.
Average Times ON/OFF	Sets the averaging count. For the method of average processing, refer to "Average Mode" in the Config → Parameter Setup.
Config	

3.3 Functional Description

Parameter Setup

Sets measurement conditions and so on.

For more information, refer to Section 5.9.2, "Measurement results Using Due to Modulation, Due to Transient and Inband Spurious Modes."

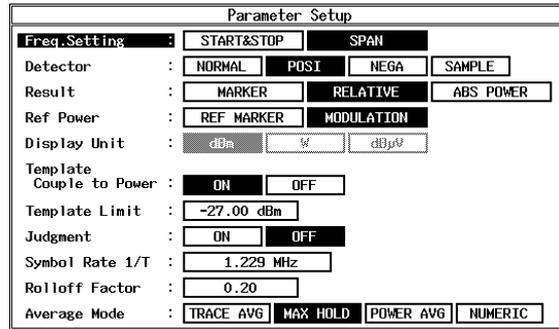

Figure 3-17 Parameter Setup Dialog Box

Freq. Setting

START&STOP/SPAN

Selects the measurement mode.

Detector

NORMAL/POSI/NEGA/SAMPLE

Selects the detector.

Result

Specifies how to display the results.

MARKER:

Displays the marker read value. The position of the marker is set by Marker Edit.

RELATIVE:

Displays the marker read value using a relative value.

ABS POWER:

Converts the value displayed by RELATIVE into the absolute value using carrier power and displays it.

Ref Power

When RELATIVE is selected for Result, this selects which relative value to use to display the marker read value.

REF MARKER:

Displays a relative value to Ref Marker set by Marker Edit.

MODULATION:

Displays a relative value to the measurement result of Tx power in Modulation.

Display Unit

dBm/W/dBµV

Selects the display unit.

NOTE: When RELATIVE is selected for Result, the unit is dB.

Template Couple to Power	Sets whether or not to raise or lower the template with the power set by Ref Power.
Template Limit	If the absolute value of the template is smaller than this value when Template Couple to Power is set to ON, clip the template at this value.
Judgment	Used to make the Pass/Fail judgment for the limit value set by Marker edit. The Pass/Fail judgment result is displayed under the display screen together with the marker list.
Symbol Rate 1/T	Sets the symbol rate for the Root Nyquist filter.
Rolloff Factor	Sets the roll-off factor for the Root Nyquist filter.
Average Mode	Selects the processing method when Average Times is set to ON. TRACE AVG: Calculates arithmetic average of the measured data (Log data) in the mode LOG. MAX HOLD: Displays the maximum value within the average counts of the swept waveforms. POWER AVG: Converts the measured data (Log data) to the linear data to take the root mean square value. NUMERIC: Converts the measured data (Log data) to the linear data to take the root mean square value.

NOTE: *Using POWER AVG display the average waveforms, using NUMERIC display the swept waveforms and takes an average of the measurement results only.*

Set to STD Returns the measurement parameters to the values specified by the standard.

3.3.3.5 Inband Spurious

This is a function to search for a peak by sweeping the set frequency.

Auto Level Set Sets the internal reference level to an optimum value in accordance with the measurement signal. The reference level is automatically adjusted when this key is pressed.

3.3 Functional Description

NOTE: The signal level must be constant while Auto Level Set is being carried out.

Template

Sets and edits the template.

For more information, refer to Section 5.8.2, "Template Setting in the F-Domain Measuring Mode."

Template ON/OFF

Sets the template display to ON or OFF.

When Template is set to ON, the Pass/Fail judgment for the template is displayed under the sweep screen.

Shift X

Shifts the set template in the frequency direction (X-axis).

Shift Y

Shifts the set template in the level direction (Y-axis).

Margin ΔX ON/OFF

Magnifies the template in the X-axis direction with a set template frequency 0 as the center.

Template Edit**Copy from STD**

Copies the template specified by the communication standard.

Insert Line

Inserts a line before the selected line.

Delete Line

Deletes the selected line.

Sort

Sorts the tables in frequency order.

Table Init

Initializes the table.

Marker Edit

Sets the measurement frequency (frequency offset) and measurement band.

For more information, refer to Section 5.9.1, "Marker Edit Function."

Copy from STD

Sets the measurement parameters specified by the communication standard.

Insert Line

Inserts a line before the selected line.

Delete Line

Deletes the selected line.

Sort

Sorts data in order of frequency.

Table Init

Initializes the table.

Average Times ON/OFF

Sets the averaging count.

For more information, refer to Section 5.8.1, "Template Setting in the T-Domain Measuring Mode."

Config**Parameter Setup**

Sets measurement conditions and so on.

For more information, refer to Section 5.9.3, "Measurement Result of Inband Spurious."

Parameter Setup	
Freq. Setting :	START&STOP SPAN
Detector :	NORMAL POST NEGA SAMPLE
Peak MKR Y Delta :	0.5 div
Result :	MARKER RELATIVE ABS POWER
Ref Power :	REF MARKER MODULATION
Display Unit :	dBm W dBμV
Template Couple to Power :	ON OFF
Template Limit :	-13.00 dBm
Judgment :	ON OFF
Average Mode :	TRACE AVG MAX HOLD POWER AVG

Figure 3-18 Parameter Setup Dialog Box

Freq. Setting

START&STOP/SPAN

Selects the measurement mode.

Detector

NORMAL/POST/NEGA/SAMPLE

Selects the detector.

Peak MKR Y Delta

Sets the Y delta of the peak marker.

Result

Specifies how to display the results.

MARKER:

Displays the marker read value. The position of the marker is set by Marker Edit.

RELATIVE:

Displays the marker read value using a relative value.

ABS POWER:

Converts the value displayed by RELATIVE into the absolute value using carrier power and displays it.

Ref Power

When RELATIVE is selected for Result, this selects which relative value is used to display the marker read value.

REF MARKER:

Displays a relative value to Ref Marker set by Marker Edit.

MODULATION:

Displays a relative value to the measurement result of Tx power in Modulation.

3.3 Functional Description

Display Unit	dBm/W/dB μ V Selects the display unit.
<hr/> <i>NOTE: When RELATIVE is selected for Result, the unit is dB.</i> <hr/>	
Template Couple to Power	Sets whether or not to raise or lower the template with the power set by Ref Power.
Template Limit	If the absolute value of the template is smaller than this value when Template Couple to Power is set to ON, clip the template at this value.
Judgment	Used to make the Pass/Fail judgment for the limit value set by Marker edit. The Pass/Fail judgment result is displayed under the display screen together with the marker list.
Average Mode	Selects the processing method when Average Times is set to ON. TRACE AVG: Calculates arithmetic average of the measured data (Log data) in the mode LOG. MAX HOLD: Displays the maximum value within the average counts of the swept waveforms. POWER AVG: Converts the measured data (Log data) to the linear data to take the root mean square value.
Set to STD	Returns the measurement parameters to the values specified by the standard.

3.3.3.6 Outband Spurious

This is a function to search for a peak by sweeping the frequency according to the table.

Auto Level Set	Sets the internal reference level to an optimum value in accordance with the measurement signal. The reference level is automatically adjusted when this key is pressed.
-----------------------	--

NOTE: The signal level must be constant while Auto Level Set is being carried out.

Table No. 1/2/3	Selects the table number.
Load Table	Loads the table.

Table Edit	Edits the table.
Copy from STD	Copies the template specified by the communication standard.
Table No. 1/2/3	Selects the table number.
Load Table	Loads the table.
Save Table	Saves the table.
Insert Line	Inserts a line before the selected line.
Delete Line	Deletes the selected line.
Table Init	Initializes the table
Average Times ON/OFF	Sets the averaging count. For the method of average processing, refer to "Average Mode" in the Config → Parameter Setup.

Config**Parameter Setup**

Sets measurement parameters.

Parameter Setup					
Detector	3	NORMAL	POSI	NEGA	SAMPLE
Peak MKR Y Delta	:	1.0 div			
Display Unit	:	dBm	W	dBμV	
Judgment	:	ON	OFF		
Preselector	:	1.6G	3.6G		
Average Mode	:	TRACE AVG	MAX HOLD	POWER AVG	

Figure 3-19 Parameter Setup Dialog Box

Detector	NORMAL/POSI/NEGA/SAMPLE
	Selects the detector.
Peak MKR Y Delta	
	Sets the Y delta of a peak marker.
Display Unit	dBm/W/dBμV
	Selects the display unit.
Judgment	Makes the Pass/Fail judgment using the limit values set by Table Edit.
Preselector	Sets the preselector.

NOTE: This menu is displayed on R3267 only.

3.3 Functional Description

- 1.6G: Used to measure harmonics of more than 1.6 GHz or spurious signals when the carrier frequency is lower than 1.6 GHz.
- 3.6G: Used to set this parameter for cases other than that above.

Average Mode

Selects the processing method when Average Times is set to ON.

TRACE AVG:

Calculates arithmetic average of the measured data (Log data) in the mode LOG.

MAX HOLD:

Displays the maximum value within the average counts of the swept waveforms.

POWER AVG:

Converts the measured data (Log data) to the linear data to take the root mean square value.

Set to Default

Returns the set value to the default.

3.3.4 Modulation (When select to GSM/EDGE)

Modulation analysis by the DSP.

3.3.4.1 Phase Error

This function is used to measure and phase errors. Only GSM signals can be analyzed.

Auto Level Set

Sets the internal reference level to an optimum value in accordance with the measurement signal. The reference level is automatically adjusted when this key is pressed.

NOTE: The signal level must stay constant while Auto Level Set is being carried out.

Graphics

Selects the type of graph to be displayed.

Select Type

Selects the type of graph on the window.

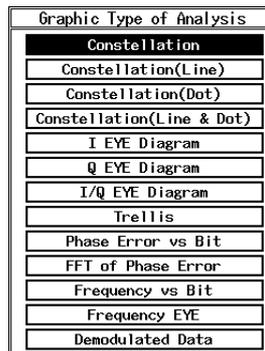

Figure 3-20 Select Type Dialog Box

Parameter Setup

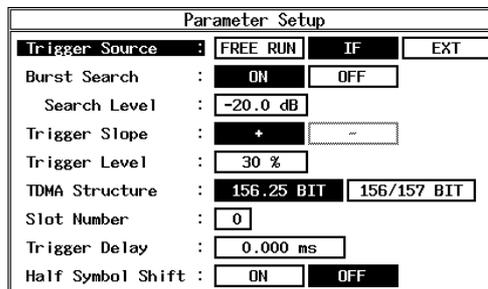

Figure 3-21 Parameter Setup Dialog Box

Trigger Source

Sets the trigger signal.

FREE RUN:

Captures data using the internal measurement timing.

3.3 Functional Description

- IF: Captures the signal in sync with the IF signal (the leading edge of the burst).
- EXT: Captures the signal in sync with the external trigger signal.

NOTE: *The external trigger signal is input to the EXT TRIG connector on the rear panel.*

<i>Burst Search</i>	Toggles the burst search function (which uses the Software) on or off. ON: Searches for a burst using the Software. OFF: Does not search for a burst using the Software.
<i>Search Level</i>	Sets the threshold level used to search for a burst if Burst Search is set to ON.
<i>Trigger Slope</i>	Selects the polarity (leading or trailing edge) of a trigger signal.
<i>Trigger Level</i>	Sets the trigger level.
<i>TDMA Structure</i>	Selects the frame format. The value used with Trigger Delay is automatically calculated from the settings TDMA Structure and Slot Number. 156.25 BIT: Selects the format in which all slots consist of 156.25 bits. 156/157 BIT: Selects the format in which Slots 0 and 4 are 157 bits, and any slots other than Slots 0 and 4 are 156 bits.
<i>Slot Number</i>	Sets the slot number.
<i>Trigger Delay</i>	Sets the delay time from when the trigger signal is generated to capture data to when the data is actually captured. Although the value used with Trigger Delay is automatically calculated based on the settings TDMA Structure and Slot Number, adjust it when necessary.
<i>Half Symbol Shift</i>	Performs the analysis after the symbol points (bit points) definition has been shifted by half a symbol.
<i>Average Times ON/OFF</i>	Sets the averaging count.

3.3.4.2 Modulation Accuracy

Performs the modulation analysis of 3PI/8 shift 8PSK.

Auto Level Set

Sets the internal reference level to an optimum value which depends on the measurement signal. Pressing this key executes the Auto Level Set function.

NOTE: While the Auto Level Set function is being executed, the measurement signal level must be constant.

Graphics

Select Type

Selects the type of graph on the window.

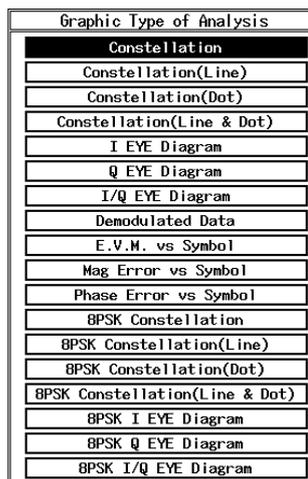

Figure 3-22 Graphic Type of Analysis Dialog Box

Parameter Setup

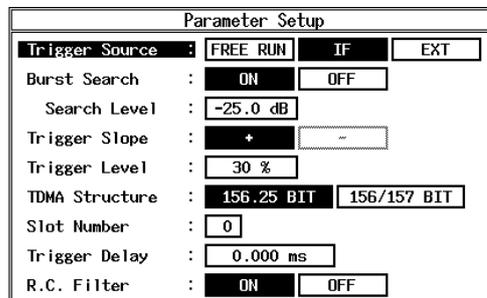

Figure 3-23 Parameter Setup Dialog Box

Trigger Source

Sets the trigger signal.

FREE RUN:

Captures data using the internal measurement timing.

3.3 Functional Description

- IF: Captures the signal in sync with the IF signal (the leading edge of the burst).
- EXT: Captures the signal in sync with the external trigger signal.

NOTE: *The external trigger signal is input to the EXT TRIG connector on the rear panel.*

- Burst Search*** Toggles the burst search function (which uses the Software) on or off.
- ON: Searches for a burst using the Software.
- OFF: Does not search for a burst using the Software.
- Search Level*** Sets the threshold level used to search for a burst if Burst Search is set to ON.
- Trigger Slope*** Selects the polarity (leading or trailing edge) of a trigger signal.
- Trigger Level*** Sets the trigger level.
- TDMA Structure*** Selects the frame format.
The value used with Trigger Delay is automatically calculated from the settings TDMA Structure and Slot Number.
- 156.25 BIT: Selects the format in which all slots consist of 156.25 bits.
- 156/157 BIT: Selects the format in which Slots 0 and 4 are 157 bits, and any slots other than Slots 0 and 4 are 156 bits.
- Slot Number*** Sets the slot number.
- Trigger Delay*** Sets the delay time from when the trigger signal is generated to capture data to when the data is actually captured.
Although the value used with Trigger Delay is automatically calculated based on the settings TDMA Structure and Slot Number, adjust it when necessary.
- R.C. Filter*** Sets whether or not the Raised Cosine Filter (with a rolloff of 0.25 and a single-sideband bandwidth of 90 kHz) is used as a receiving filter.
- ON: Uses the Raised Cosine Filter as the receiving filter.
- OFF: Does not use the Raised Cosine Filter.
- Average Times ON/OFF*** Sets the averaging count.

3.3.4.3 Tx Power

Auto Level Set

Sets the internal reference level to an optimum value in accordance with the measurement signal. The reference level is automatically adjusted when this key is pressed.

NOTE: *The signal level must stay constant while Auto Level Set is being carried out.*

Parameter Setup

Parameter Setup	
Trigger Source :	<input checked="" type="radio"/> FREE RUN <input type="radio"/> IF <input type="radio"/> EXT
Burst Search :	<input checked="" type="radio"/> ON <input type="radio"/> OFF
Search Level :	-20.0 dB
Trigger Slope :	<input checked="" type="radio"/> + <input type="radio"/> -
Trigger Level :	30 %
TDMA Structure :	<input checked="" type="radio"/> 156.25 BIT <input type="radio"/> 156/157 BIT
Slot Number :	0
Trigger Delay :	0.000 ms
Half Symbol Shift :	<input type="radio"/> ON <input checked="" type="radio"/> OFF

Figure 3-24 Parameter Setup Dialog Box

Trigger Source

Sets the trigger signal.

FREE RUN:

Captures data using the internal measurement timing.

IF: Captures the signal in sync with the IF signal (the leading edge of the burst).

EXT: Captures the signal in sync with the external trigger signal.

NOTE: *The external trigger signal is input to the EXT TRIG connector on the rear panel.*

Burst Search

Toggles the burst search function (which uses the Software) on or off.

ON: Searches for a burst using the Software.

OFF: Does not search for a burst using the Software.

Search Level

Sets the threshold level used to search for a burst if Burst Search is set to ON.

Trigger Slope

Selects the polarity (leading or trailing edge) of a trigger signal.

Trigger Level

Sets the trigger level.

3.3 Functional Description

<i>TDMA Structure</i>	Selects the frame format. The value used with Trigger Delay is automatically calculated from the settings TDMA Structure and Slot Number. 156.25 BIT: Selects the format in which all slots consist of 156.25 bits. 156/157 BIT: Selects the format in which Slots 0 and 4 are 157 bits, and any slots other than Slots 0 and 4 are 156 bits.
<i>Slot Number</i>	Sets the slot number.
<i>Trigger Delay</i>	Sets the delay time from when the trigger signal is generated to capture data to when the data is actually captured. Although the value used with Trigger Delay is automatically calculated based on the settings TDMA Structure and Slot Number, adjust it when necessary.
<i>Half Symbol Shift</i>	Performs the analysis after the symbol points (bit points) definition has been shifted by half a symbol.
<i>Average Times ON/OFF</i>	Sets the averaging count.

3.3.4.4 Power vs Time

<i>Auto Level Set</i>	Sets the internal reference level to an optimum value in accordance with the measurement signal. The reference level is automatically adjusted when this key is pressed.
------------------------------	--

NOTE: The signal level must stay constant while Auto Level Set is being carried out.

<i>Template Entry</i>	Displays the menu used to set the template.
<i>MS Template</i>	The limit value can be set using the MS template.
<i>BTS Template1</i>	The limit value can be set using the GSM450,GSM480,GSM850 GSM900 or DCS1800 BTS template.
<i>BTS Template2</i>	The limit value can be set using the PCS1900 template.
<i>STD Template</i>	Selects the template compliant with the standard. The limit value cannot be edited.
<i>Meas Mode NORM/HIGH</i>	Selects the measurement mode. NORM: Measures using data captured with one command. HIGH: The synthesized waveform is displayed after the upper and lower parts of the burst signal have separately been measured.

NOTE:

1. **HIGH mode cannot be selected when set to the multi burst mode.**
2. **There is a possibility that measurements are not made in HIGH mode when a multi burst signal (which contains multiple bursts in a single frame) is input.**

Y [dB/div] 20/10/5

Switches the vertical scale display.

Parameter Setup

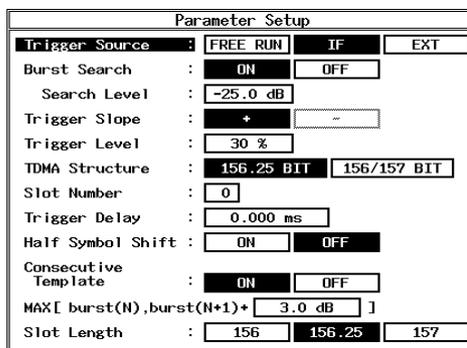

Figure 3-25 Parameter Setup Dialog Box

Trigger Source

Sets the trigger signal.

FREE RUN:

Captures data using the internal measurement timing.

IF:

Captures the signal in sync with the IF signal (the leading edge of the burst).

EXT:

Captures the signal in sync with the external trigger signal.

NOTE: The external trigger signal is input to the EXT TRIG connector on the rear panel.

Burst Search

Toggles the burst search function (which uses the Software) on or off.

ON:

Searches for a burst using the Software.

OFF:

Does not search for a burst using the Software.

Search Level

Sets the threshold level used to search for a burst if Burst Search is set to ON.

Trigger Slope

Selects the polarity (leading or trailing edge) of a trigger signal.

3.3 Functional Description

<i>Trigger Level</i>	Sets the trigger level.
<i>TDMA Structure</i>	<p>Selects the frame format. The value used with Trigger Delay is automatically calculated from the settings TDMA Structure and Slot Number.</p> <p>156.25 BIT: Selects the format in which all slots consist of 156.25 bits.</p> <p>156/157 BIT: Selects the format in which Slots 0 and 4 are 157 bits, and any slots other than Slots 0 and 4 are 156 bits.</p>
<i>Slot Number</i>	Sets the slot number.
<i>Trigger Delay</i>	<p>Sets the delay time from when the trigger signal is generated to capture data to when the data is actually captured. Although the value used with Trigger Delay is automatically calculated based on the settings TDMA Structure and Slot Number, adjust it when necessary.</p>
<i>Half Symbol Shift</i>	Performs the analysis after the symbol points (bit points) definition has been shifted by half a symbol.
<i>Consecutive Template</i>	Selects whether the two consecutive bursts are measured using templates. This function is enabled only when MULTI-BURST is selected from Meas Mode in the STD Setup window.
<i>MAX[burst(N),burst(N+1)+ dB]</i>	<p>Sets the guard section template when templates are set for the two consecutive bursts. Use (the first burst power) or (the first burst power + X), whichever is larger as the guard section template. Sets the value X.</p>
<i>Slot Length</i>	<p>Sets the slot length of the first burst, when templates are set for the two consecutive bursts. The position of the second template is changed due to this setting.</p>
<i>Average Times ON/OFF</i>	Sets the averaging count.
<i>Burst PREV/NEXT</i>	<p>Sets which of the two consecutive bursts is displayed on the lower screen.</p> <p>PREV: The first burst is displayed with the template.</p> <p>NEXT: The second burst is displayed with the template.</p>

3.3.4.5 Wave Check

Opens the menu used to display an IF or base-band signal waveform in time domain or FFT waveform.

Time & FFT

Displays an IF or base-band signal waveform in time domain or FFT waveform. This function is used to check an input signal.

Auto Level Set

Sets the internal reference level to an optimum value in accordance with the measurement signal. The reference level is automatically adjusted when this key is pressed.

NOTE: *The signal level must stay constant while Auto Level Set is being carried out.*

Select Type

Selects the type of graph on the window.

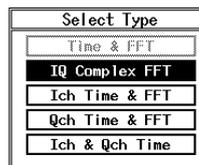

Figure 3-26 Select Type Dialog Box

Parameter Setup

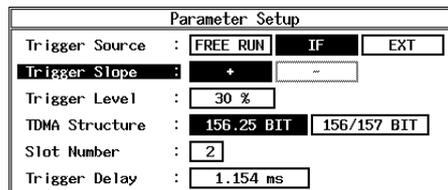

Figure 3-27 Parameter Setup Dialog Box

Trigger Source

Sets the trigger signal.

FREE RUN:

Captures data using the internal measurement timing.

IF: Captures the signal in sync with the IF signal (the leading edge of the burst).

EXT: Captures the signal in sync with the external trigger signal.

NOTE: *The external trigger signal is input to the EXT TRIG connector on the rear panel.*

Trigger Slope

Selects the polarity (leading or trailing edge) of a trigger signal.

3.3 Functional Description

<i>Trigger Level</i>	Sets the trigger level.
<i>TDMA Structure</i>	<p>Selects the frame format. The value used with Trigger Delay is automatically calculated from the settings TDMA Structure and Slot Number.</p> <p>156.25 BIT: Selects the format in which all slots consist of 156.25 bits.</p> <p>156/157 BIT: Selects the format in which Slots 0 and 4 are 157 bits, and any slots other than Slots 0 and 4 are 156 bits.</p>
<i>Slot Number</i>	Sets the slot number.
<i>Trigger Delay</i>	<p>Sets the delay time from when the trigger signal is generated to capture data to when the data is actually captured. Although the value used with Trigger Delay is automatically calculated based on the settings TDMA Structure and Slot Number, adjust it when necessary.</p>
<i>Average Times ON/OFF</i>	Sets the averaging count.
<i>Time</i>	An IF or base-band signal is displayed using the slot length and frame length. This function is used to verify the settings such as Trigger level and Trigger Delay, as well as the input signals.
<i>Auto Level Set</i>	Sets the internal reference level to an optimum value in accordance with the measurement signal. The reference level is automatically adjusted when this key is pressed.

NOTE: The signal level must stay constant while Auto Level Set is being carried out.

Parameter Setup

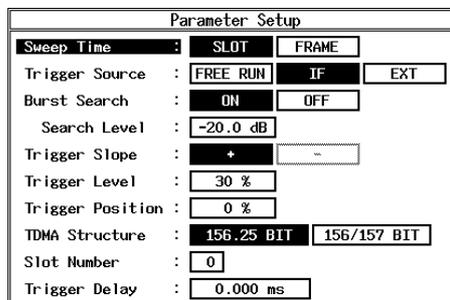

Figure 3-28 Parameter Setup Dialog Box

<i>Sweep Time</i>	<p>Sets the sweep time when displaying waveform in time domain.</p> <p>SLOT: Displays the waveform of one slot.</p>
--------------------------	---

	FRAME: Displays the waveform of one frame.
Trigger Source	Sets the trigger signal. FREE RUN: Captures data using the internal measurement timing. IF: Captures the signal in sync with the IF signal (the leading edge of the burst). EXT: Captures the signal in sync with the external trigger signal..
<hr/>	
<i>NOTE: The external trigger signal is input to the EXT TRIG connector on the rear panel.</i>	
<hr/>	
Burst Search	Toggles the burst search function (which uses the Software) on or off. ON: Searches for a burst using the Software. OFF: Does not search for a burst using the Software.
Search Level	Sets the threshold level used to search for a burst if Burst Search is set to ON.
Trigger Slope	Selects the polarity (leading or trailing edge) of a trigger signal.
Trigger Level	Sets the trigger level.
Trigger Position	Determines where the triggered position must be displayed on the screen.
TDMA Structure	Selects the frame format. The value used with Trigger Delay is automatically calculated from the settings TDMA Structure and Slot Number. 156.25 BIT: Selects the format in which all slots consist of 156.25 bits. 156/157 BIT: Selects the format in which Slots 0 and 4 are 157 bits, and any slots other than Slots 0 and 4 are 156 bits.
Slot Number	Sets the slot number.
Trigger Delay	Sets the delay time from when the trigger signal is generated to capture data to when the data is actually captured. Although the value used with Trigger Delay is automatically calculated based on the settings TDMA Structure and Slot Number, adjust it when necessary.

3.3 Functional Description

3.3.5 Modulation (When select to DECT)

3.3.5.1 Freq Deviation

This function is used to measure frequency deviations. Only the signals compliant with DECT can be analyzed.

Auto Level Set

Sets the internal reference level to an optimum value in accordance with the measurement signal. The reference level is automatically adjusted when this key is pressed.

NOTE: *The signal level must stay constant while Auto Level Set is being carried out.*

Graphics

Selects the type of graph to be displayed.

Start Bit

Sets bit number from which the graphic display is started. A graphic display of 128 bits is displayed starting from the bit number.

Select Type

Selects the type of graph on the window.

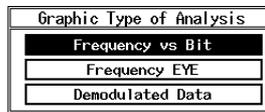

Figure 3-29 Select Type Dialog Box

Parameter Setup

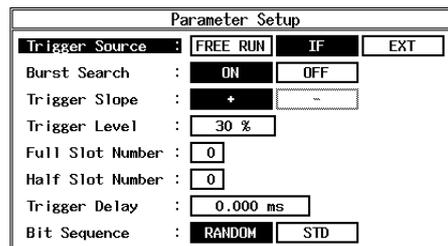

Figure 3-30 Parameter Setup Dialog Box

Trigger Source

Sets the trigger signal.

FREE RUN:

Captures data using the internal measurement timing.

IF: Captures the signal in sync with the IF signal (the leading edge of the burst).

EXT: Captures the signal in sync with the external trigger signal.

NOTE: *The external trigger signal is input to the EXT TRIG connector on the rear panel.*

<i>Burst Search</i>	Toggles the burst search function (which uses the Software) on or off. ON: Searches for a burst using the Software. OFF: Does not search for a burst using the Software.
<i>Trigger Slope</i>	Selects the polarity (leading or trailing edge) of a trigger signal.
<i>Trigger Level</i>	Sets the trigger level.
<i>Full Slot Number</i>	Sets the full slot number of the signal to be measured.
<i>Half Slot Number</i>	Sets the half slot number of the signal to be measured.
<i>Trigger Delay</i>	Sets the delay time from when the trigger signal is generated to capture data to when the data is actually captured. Although the value used with Trigger Delay is automatically calculated based on the settings Full Slot Number and Half Slot Number, adjust it when necessary.
<i>Bit Sequence</i>	Selects the algorithm of the measurement. RANDOM: The formula shown below is used to calculate the frequency error using the maximum and minimum frequencies, assuming that the bit data is on a random basis. Frequency error = (Maximum frequency + Minimum frequency) / 2 STD Measurement is made compliant with TBR06 standard. Refer to “5.3 RANDOM/STD in the DECT bit sequence”.
<i>Average Times ON/OFF</i>	Sets the averaging count.

3.3 Functional Description

3.3.5.2 Timing Jitter

Auto Level Set

Sets the internal reference level to an optimum value in accordance with the measurement signal. The reference level is automatically adjusted when this key is pressed.

NOTE: *The signal level must stay constant while Auto Level Set is being carried out.*

RFP→PP ON/OFF

ON: Measures the jitter between Radio Fixed Part and Portable Part.
 OFF: Measures the jitters of a signal set to Link.
 For example, when Setup STD is set to PP, the jitters are measured using the two bursts the PP has sent.

Parameter Setup

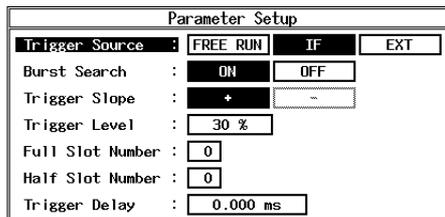

Figure 3-31 Parameter Setup Dialog Box

Trigger Source

Sets the trigger signal.
 FREE RUN: Captures data using the internal measurement timing.
 IF: Captures the signal in sync with the IF signal (the leading edge of the burst).
 EXT: Captures the signal in sync with the external trigger signal.

NOTE: *The external trigger signal is input to the EXT TRIG connector on the rear panel.*

Burst Search

Toggles the burst search function (which uses the Software) on or off.
 ON: Searches for a burst using the Software.
 OFF: Does not search for a burst using the Software.

Trigger Slope

Selects the polarity (leading or trailing edge) of a trigger signal.

<i>Trigger Level</i>	Sets the trigger level.
<i>Full Slot Number</i>	Sets the full slot number of the signal to be measured
<i>Half Slot Number</i>	Sets the half slot number of the signal to be measured.
<i>Trigger Delay</i>	Sets the delay time from when the trigger signal is generated to capture data to when the data is actually captured. Although the value used with Trigger Delay is automatically calculated based on the settings Full Slot Number and Half Slot Number, adjust it when necessary.
<i>Average Times ON/OFF</i>	Sets the averaging count.

3.3.5.3 Tx Power

<i>Auto Level Set</i>	Sets the internal reference level to an optimum value in accordance with the measurement signal. The reference level is automatically adjusted when this key is pressed.
-----------------------	--

NOTE: *The signal level must stay constant while Auto Level Set is being carried out.*

Parameter Setup

Figure 3-32 Parameter Setup Dialog Box

<i>Trigger Source</i>	Sets the trigger signal. FREE RUN: Captures data using the internal measurement timing. IF: Captures the signal in sync with the IF signal (the leading edge of the burst). EXT: Captures the signal in sync with the external trigger signal.
-----------------------	---

NOTE: *The external trigger signal is input to the EXT TRIG connector on the rear panel.*

3.3 Functional Description

<i>Burst Search</i>	Toggles the burst search function (which uses the Software) on or off. ON: Searches for a burst using the Software. OFF: Does not search for a burst using the Software.
<i>Trigger Slope</i>	Selects the polarity (leading or trailing edge) of a trigger signal.
<i>Trigger Level</i>	Sets the trigger level.
<i>Full Slot Number</i>	Sets the full slot number of the signal to be measured.
<i>Half Slot Number</i>	Sets the half slot number of the signal to be measured.
<i>Trigger Delay</i>	Sets the delay time from when the trigger signal is generated to capture data to when the data is actually captured. Although the value used with Trigger Delay is automatically calculated based on the settings Full Slot Number and Half Slot Number, adjust it when necessary.
<i>Average Times ON/OFF</i>	Sets the averaging count.

3.3.5.4 Power vs Time

<i>Auto Level Set</i>	Sets the internal reference level to an optimum value in accordance with the measurement signal. The reference level is automatically adjusted when this key is pressed.
------------------------------	--

NOTE: The signal level must stay constant while Auto Level Set is being carried out.

<i>Template Entry</i>	Displays the menu used to set the template.
<i>User Template1</i>	Selects the user-specified template.
<i>User Template2</i>	Selects the user-specified template.
<i>User Template3</i>	Selects the user-specified template.
<i>STD Template</i>	Selects the template compliant with the standard.
<i>Meas Mode NORM/HIGH</i>	Selects the measurement mode. NORM: Measures using data captured with one command. HIGH: The synthesized waveform is displayed after the upper and lower parts of the burst signal have separately been measured.
<i>Y [dB/div] 20/10/5</i>	Switches the vertical scale display.

Parameter Setup

Parameter Setup	
Trigger Source :	<input type="radio"/> FREE RUN <input checked="" type="radio"/> IF <input type="radio"/> EXT
Burst Search :	<input checked="" type="checkbox"/> ON <input type="checkbox"/> OFF
Trigger Slope :	<input checked="" type="radio"/> + <input type="radio"/> -
Trigger Level :	<input type="text" value="30 %"/>
Full Slot Number :	<input type="text" value="0"/>
Half Slot Number :	<input type="text" value="0"/>
Trigger Delay :	<input type="text" value="0.000 ms"/>

Figure 3-33 Parameter Setup Dialog Box*Trigger Source*

Sets the trigger signal.

FREE RUN:

Captures data using the internal measurement timing.

IF: Captures the signal in sync with the IF signal (the leading edge of the burst).

EXT: Captures the signal in sync with the external trigger signal.

NOTE: The external trigger signal is input to the EXT TRIG connector on the rear panel.

Burst Search

Toggles the burst search function (which uses the Software) on or off.

ON: Searches for a burst using the Software.

OFF: Does not search for a burst using the Software.

Trigger Slope

Selects the polarity (leading or trailing edge) of a trigger signal.

Trigger Level

Sets the trigger level.

Full Slot Number

Sets the full slot number of the signal to be measured.

Half Slot Number

Sets the half slot number of the signal to be measured.

Trigger Delay

Sets the delay time from when the trigger signal is generated to capture data to when the data is actually captured.

Although the value used with Trigger Delay is automatically calculated based on the Full Slot number and Half Slot Number, adjust it when necessary.

Average Times ON/OFF

Sets the averaging count.

3.3 Functional Description

3.3.5.5 Wave Check

Opens the menu used to display an IF or base-band signal waveform in time domain or FFT waveform.

Time & FFT

An IF or base-band signal waveform in time domain and FFT waveform are displayed. This function is used to verify input signals.

Auto Level Set

Sets the internal reference level to an optimum value in accordance with the measurement signal. The reference level is automatically adjusted when this key is pressed.

NOTE: *The signal level must stay constant while Auto Level Set is being carried out.*

Select Type

Selects a graph to be displayed.

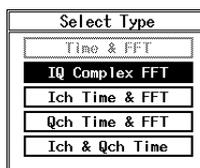

Figure 3-34 Display Dialog Box

Parameter Setup

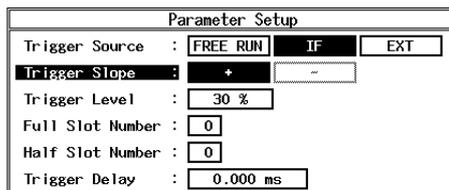

Figure 3-35 Parameter Setup Dialog Box

Trigger Source

Sets the trigger signal.

FREE RUN:

Captures data using the internal measurement timing.

IF: Captures the signal in sync with the IF signal (the leading edge of the burst).

EXT: Captures the signal in sync with the external trigger signal.

NOTE: *The external trigger signal is input to the EXT TRIG connector on the rear panel.*

- Trigger Slope** Selects the polarity (leading or trailing edge) of a trigger signal.
- Trigger Level** Sets the trigger level.
- Full Slot Number** Sets the full slot number.
- Half Slot Number** Sets the half slot number.
- Trigger Delay** Sets the delay time from when the trigger signal is generated to capture data to when the data is actually captured. Although the value used with Trigger Delay is automatically calculated based on the settings Full Slot Number and Half Slot Number, adjust it when necessary.

Average Times ON/OFF Sets the averaging count.

Time An IF or base-band signal is displayed using the slot length and frame length. This function is used to verify the settings such as Trigger level and Trigger Delay, as well as the input signals.

Auto Level Set Sets the internal reference level to an optimum value in accordance with the measurement signal. The reference level is automatically adjusted when this key is pressed.

NOTE: The signal level must stay constant while Auto Level Set is being carried out.

Parameter Setup

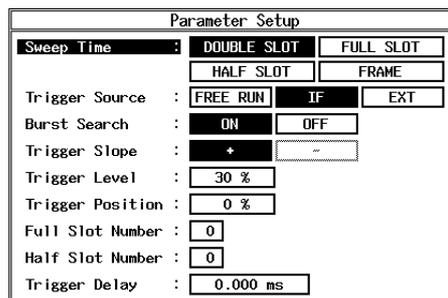

Figure 3-36 Parameter Setup Dialog Box

- Sweep Time** Sets the sweep time when displaying waveform in time domain.
 - DOUBLE SLOT:** Displays a waveform corresponding to one double slot.
 - FULL SLOT:** Displays a waveform corresponding to one full slot.
 - HALF SLOT:** Displays a waveform corresponding to one half slot.

3.3 Functional Description

	FRAME:	Displays a waveform corresponding to one frame.
Trigger Source	Sets the trigger signal.	
	FREE RUN:	Captures data using the internal measurement timing.
	IF:	Captures the signal in sync with the IF signal (the leading edge of the burst).
	EXT:	Captures the signal in sync with the external trigger signal.
<hr/>		
<i>NOTE: The external trigger signal is input to the EXT TRIG connector on the rear panel.</i>		
<hr/>		
Burst Search	Toggles the burst search function (which uses the Software) on or off.	
	ON:	Searches for a burst using the Software.
	OFF:	Does not search for a burst using the Software.
Trigger Slope	Selects the polarity (leading or trailing edge) of a trigger signal.	
Trigger Level	Sets the trigger level.	
Trigger Position	Determines where the triggered position must be displayed on the screen.	
Full Slot Number	Sets the full slot number of the signal to be measured.	
Half Slot Number	Sets the half slot number of the signal to be measured.	
Trigger Delay	Sets the delay time from when the trigger signal is generated to capture data to when the data is actually captured. Although the value used with Trigger Delay is automatically calculated based on the settings Full Slot Number and Half Slot Number, adjust it when necessary.	

3.3.6 STD

Sets parameters used for measurement and relationship between the channel number and frequency.

3.3.6.1 DC CAL

Compensates for direct current components inside the circuit.

3.3.6.2 Channel Setting

Sets the relationship between the channel number and frequency.

Copy from STD

Sets the relationship between the channel number and frequency specified by the communication standard. Sets the relationship between the channel number and frequency in the band specified by Type of STD Setup.

UpLink: Sets the channel number of the mobile station (MS).
When set to DECT, the channel number of PP (Portable Part) is set.

DownLink: Sets the channel number of the base station (BTS).
When set to DECT, the channel number of RFP (Radio Fixed Part) is set.

3.3.6.3 STD Setup

This section describes the STD Setup menu.

- When selected to GSM/EDGE

STD Measurement Parameter Set		
Modulation	GMSK	3PI/8 Shift 8PSK
Type	GSM450	GSM480 GSM850 GSM900 DCS1800 PCS1900
Meas Mode	BURST	MULTI-BURST CONTINUOUS
Link	BTS	MS
Burst Type	14B BIT	8B BIT
Sync Type	SYNC WORD	NO SYNC WORD
TSC	0 1 2 3 4 5 6 7	ARB
	0970897 (Hex)	
Filter Mode	WIDE	NARROW
Power Control Level	16: 11dBm	17: 9dBm 18: 7dBm
	19: 5dBm	OTHER
Offset Level	0.0 dB	
Frequency Input	FREQUENCY	CHANNEL
Input	RF	BASEBAND (I&Q)
Baseband Input	AC	DC
IQ Inverse	NORMAL	INVERSE
Cont Auto Level Set	ON	OFF

1 STD

DC CAL

6 Channel Setting

7 STD Setup

Modulation

Selects a modulation to analyze.

Type

GSM450/GSM480/GSM850/GSM900/DCS1800/PCS1900
Selects the communication standard. The channel number, spurious measurement range which are specified for the default template are displayed.

3.3 Functional Description

<i>Meas Mode</i>	<p>Selects the measurement mode.</p> <p>BURST: Selected when there is one burst in one frame.</p> <p>MULTI-BURST: Selected when there are multiple bursts in one frame.</p> <p>CONTINUOUS: Measures a continuous wave. Although no continuous waves are defined in the standard, this position is used to test a continuous signal.</p>
<i>Link</i>	<p>Sets the direction of signal.</p> <p>BTS: Measures signals from the base station.</p> <p>MS: Measures signals from mobile station.</p>
<i>Burst Type</i>	<p>148 BIT/88 BIT</p> <p>Sets the bit length of a burst.</p>
<i>Sync Type</i>	<p>Sets whether to measure in sync with the sync word.</p>
<hr/> <p><i>NOTE: To detect the position of a burst compliant with the standard, measure the burst in sync with the sync word.</i></p> <hr/>	
<i>TSC</i>	<p>SYNC WORD: Measures the signal in sync with the sync word.</p> <p>NO SYNC WORD: Measures the signal without using the sync word.</p> <p>0/1/2/3/4/5/6/7: Selects the training sequence code.</p> <p>ARB: Sets any of the training sequence code.</p> <p>The training sequence code is set in hexadecimal number when GMSK is selected from Modulation. The following keys are used to enter data in hexadecimal number.</p> <p style="margin-left: 40px;">A: SHIFT, 0 B: SHIFT, 1 C: SHIFT, 2 D: SHIFT, 3 E: SHIFT, 4 F: SHIFT, 5</p> <p>The training sequence code is set in octal number when 3PI/8 Shift 8PSK is selected from Modulation.</p>
<i>Filter Mode</i>	<p>Selects the receiving filter.</p> <p>Refer to Section “5.1 NARROW/WIDE in the GSM filter mode”.</p>

NOTE: Select *WIDE*, when measuring a signal with a large frequency error; and select *NARROW* when measuring one carrier selected from multiple carriers.

WIDE: Selects the filter with a wide bandwidth.
NARROW: Selects the filter with a narrow bandwidth.

Power Control Level

Sets the Power Control Level. A template which is used to measure the leading and trailing edges is created.

Offset Level

Sets reference level's offset value within a range of -100 dB to +100 dB.

Frequency Input

Sets the method of entering the center frequency to the instrument.

FREQUENCY: Enters a frequency.
CHANNEL: Enters a channel number.

Input

Sets an input signal route.

NOTE: Settings using *Input* are valid only for: *Phase Error, Modulation Accuracy, Power vs Time, and Tx Power*. When entering *BASEBAND, Power vs Time, and Tx Power* are displayed in relative power.

RF: The RF input route is set.
BASEBAND (I&Q):
 The IQ input route is set.
 The input signal magnitude is from 0.25V to 0.9V_{p-p} ($\pm 0.47V$ or less).

Baseband Input

Selects the coupling of signals.

AC: Sets an alternate current coupling. (A cutoff frequency is approx. 15 Hz)
DC: Sets a direct current coupling.

IQ Inverse

Sets whether to invert the sign of the Q signal.

NORMAL: The sign of the Q signal is not inverted.
INVERSE: The sign of the Q signal is inverted.

Cont Auto Level Set

Sets whether to carry out the auto ranging.

3.3 Functional Description

NOTE: When RF is selected for Input, Cont Auto Level Set takes effect only for Phase Error, Power vs Time, and Tx Power. Use the soft key Auto Level Set when adjusting the reference level.

ON: The auto ranging is carried out on a measurement basis.
 OFF: The auto ranging is not carried out.

- When selected to DECT

STD Measurement Parameter Set		STD
Type :	DECT	1 DC CAL
Meas Mode :	BURST CONTINUOUS	
Link :	RFP PP	
Physical Packet :	P00 P32 P08j P80	
Z-Filed :	ON OFF	
Sync Type :	SYNC WORD NO SYNC WORD	
	AAAAE98A	
Filter Mode :	WIDE NARROW	
Power Level :	LEVEL1 LEVEL2	
Offset Level :	0.0 dB	
Frequency Input :	FREQUENCY CHANNEL	
Input :	RF BASEBAND(I&Q)	
Baseband Input :	AC DC	
Phase Inverse :	NORMAL INVERSE	6 Channel Setting
Cont Auto Level Set :	ON OFF	7 STD Setup

Type

Selects the communication standard.
 For the DECT, only the DECT is used.

Meas Mode

Selects the measurement mode.
BURST: Selected when there is one burst in one frame.
CONTINUOUS: Measures a continuous wave. Although no continuous waves are defined in the standard, this position is used to test a continuous signal.

Link

Sets the direction of signal.
RFP: Measures Radio Fixed Part signals.
PP: Measures Portable Part signals.

Physical Packet

P00/P32/P08j/P80
 Selects a communication packet.

Z-Field

Toggles the Z-Field on or off.

Sync Type

Sets whether to measure in sync with the sync word.

NOTE: *To detect the position of a burst compliant with the standard, measure the burst in sync with the sync word.*

SYNC WORD: Measures the signal in sync with the sync word.

NO SYNC WORD: Measures the signal without using the sync word.

Filter Mode

Selects the receiving filter.
Refer to Section “5.2 NARROW/WIDE in the DECT filter mode”.

NOTE: *Select WIDE, when measuring a signal with a large frequency error; and select NARROW when measuring one carrier selected from multiple carriers.*

WIDE: Selects the filter with a wide bandwidth.

NARROW: Selects the filter with a narrow bandwidth.

Power Level

Selects the power level.

LEVEL1: Selects LEVEL1 (2.5 mW).

LEVEL2: Selects LEVEL1 (250 mW).

Offset Level

Sets reference level's offset value within a range of -100 dB to +100 dB.

NOTE: *In a high-power signal measurement, entering an offset value of the reference level allows you to read the power when a fixed attenuator is used for the input signal.*

Frequency Input

Sets the method of entering the center frequency to the instrument.

FREQUENCY: Enters a frequency.

CHANNEL: Enters a channel number.

Input

Sets an input signal route.

NOTE: *Settings using Input are valid only for: Freq Deviation, Timing Jitter, Power vs Time, and Tx Power. When entering BASE-BAND, Power vs Time, and Tx Power are displayed in relative power.*

3.3 Functional Description

RF: The RF input route is set.
BASEBAND (I&Q): The IQ input route is set.
The input signal magnitude is from 0.25V to 0.9Vp-p ($\pm 0.47V$ or less).

Baseband Input

Selects the coupling of signals.

AC: Sets an alternate current coupling. (A cutoff frequency is approx. 15 Hz)

DC: Sets a direct current coupling.

Phase Inverse

Sets whether to invert the phase of demodulation.

NORMAL: The phases are not inverted.

INVERSE: The phases are inverted.

Cont Auto Level Set

Sets whether or not to carry out the auto ranging with reference to the input signal.

NOTE: When RF is selected for Input, Cont Auto Level Set takes effect only for Freq Deviation, Timing Jitter, Power vs Time, and Tx Power. Use the soft key Auto Level Set when adjusting the reference level.

ON: The auto ranging is carried out on a measurement basis.

OFF: The auto ranging is not carried out.

4 REMOTE CONTROL

4.1 GPIB Command Index

This GPIB command index can be used as the index for Chapter 4.

<u>GPIB Command</u>	<u>Pages</u>	<u>GPIB Command</u>	<u>Pages</u>
*CLS	4-71	CHTBL1 ENBL	4-17, 4-19
*ESE	4-71	CHTBL2 DSBL	4-17, 4-19
*ESR	4-71	CHTBL2 ENBL	4-17, 4-19
*IDN	4-71	CHTBL3 DSBL	4-17, 4-19
*RST	4-71	CHTBL3 ENBL	4-17, 4-19
*SRE	4-71	CLDC	4-17, 4-20
*STB	4-71	COMMSYS DECT	4-10
.	4-70	COMMSYS GSM	4-10
0 to 9	4-70	COMMSYS IS-136	4-10
AA	4-10	COMMSYS IS95	4-10
AD	4-71	COMMSYS PDC	4-10
ALS OFF	4-17, 4-20	COMMSYS PHS	4-10
ALS ON	4-17, 4-20	COMMSYS WCDMA	4-10
AS	4-11	DB	4-70
AT	4-10	DC0	4-12
ATMIN	4-10	DC1	4-12
ATMIN OFF	4-10	DC2	4-12
ATMIN ON	4-10	DCAPTRG EXT	4-61, 4-63, 4-65, 4-66
AUTOLVL	4-47, 4-49, 4-53, 4-55, 4-61, 4-63, 4-65, 4-66	DCAPTRG FREE	4-61, 4-63, 4-65, 4-66
AUTOWFL	4-21	DCAPTRG IF	4-61, 4-63, 4-65, 4-66
BA	4-11	DCPDIV P10DB	4-22
BBINPUT AC	4-17, 4-20	DCPDIV P2DB	4-22
BBINPUT DC	4-17, 4-20	DCPDIV P5DB	4-22
BTYP B148	4-14	DEL	4-13
BTYP B88	4-14	DEL REG_nn	4-13
CF	4-11	DELSTBL	4-28
CH	4-16, 4-19	DEMOD	4-69
CHEDDN1	4-16, 4-19	DFMAVG	4-61
CHEDDN2	4-16, 4-19	DFMBITSEQ RND	4-61
CHEDDN3	4-16, 4-19	DFMBITSEQ STD	4-61
CHEDUP1	4-16, 4-19	DFMDEV	4-61, 4-62
CHEDUP2	4-16, 4-19	DFMDEVSTD	4-62
CHEDUP3	4-16, 4-19	DFMGTYT BIT	4-69
CHSETSTD	4-17, 4-19	DFMGTYT DEMOD	4-69
CHTBL1 DSBL	4-17, 4-19	DFMGTYT EYE	4-69

4.1 GPIB Command Index

DL0	4-71	DTMJJDG ON	4-41
DL1	4-71	DTMMEAS	4-42
DL2	4-71	DTMMKRCLR.....	4-40
DL3	4-71	DTMMKRCP.....	4-40
DL4	4-71	DTMMKRED	4-40
DPTAVG	4-68	DTMREF MKR	4-42
DPTDIV P10DB	4-67	DTMREF MOD	4-42
DPTDIV P20DB	4-67	DTMRES ABS	4-42
DPTDIV P5DB	4-67	DTMRES MKR	4-42
DPTENT	4-67	DTMRES REL.....	4-42
DPTJJDG.....	4-68	DTMRFACT.....	4-42
DPTLV0.....	4-67	DTMSETSTD.....	4-42
DPTLV1.....	4-67	DTMSYMRT.....	4-42
DPTLV2.....	4-67	DTMTMPL OFF.....	4-40
DPTLV3.....	4-67	DTMTMPL ON	4-40
DPTLV4.....	4-67	DTMTMPLBTM	4-41
DPTLV5.....	4-67	DTMTMPLCLR	4-40
DPTLVENT.....	4-68	DTMTMPLCP.....	4-40
DPTTYP	4-67	DTMTMPLDX	4-40
DPTUNIT0 DB.....	4-68	DTMTMPLED.....	4-40
DPTUNIT0 W.....	4-68	DTMTMPLPW OFF.....	4-41
DPTUNIT1 DB.....	4-68	DTMTMPLPW ON	4-41
DPTUNIT1 W.....	4-68	DTMTMPLSX.....	4-40
DPTUNIT2 DB.....	4-68	DTMTMPLSY.....	4-40
DPTUNIT2 W.....	4-68	DTMUNIT DBM.....	4-41
DPTUNIT3 DB.....	4-68	DTMUNIT DBUV.....	4-41
DPTUNIT3 W.....	4-68	DTMUNIT W	4-41
DPTUNIT4 DB.....	4-68	DTRGSLP FALL.....	4-61, 4-63, 4-65, 4-66
DPTUNIT4 W.....	4-68	DTRGSLP RISE	4-61, 4-63, 4-65, 4-66
DPTUNIT5 DB.....	4-68	DTSAUTOLVL.....	4-36
DPTUNIT5 W.....	4-68	DTSAVG	4-37
DPWRM.....	4-68	DTSAVGCNT	4-37
DSTTBIT	4-69	DTSAVGMD MAX	4-37
DTJAVG	4-63	DTSAVGMD NUMERIC	4-37
DTJIT	4-64	DTSAVGMD POWER.....	4-37
DTJLNK OFF	4-63	DTSAVGMD TRACE.....	4-37
DTJLNK ON.....	4-63	DTSDET NEG	4-37
DTMAUTOLVL.....	4-39	DTSDET NRM	4-37
DTMAVG	4-41	DTSDET POS.....	4-37
DTMAVGCNT.....	4-41	DTSDET SMP.....	4-37
DTMAVGMD MAX	4-41	DTSFRMD CFSP	4-37
DTMAVGMD NUMERIC	4-41	DTSFRMD STSP	4-37
DTMAVGMD POWER	4-41	DTSJDG OFF	4-37
DTMAVGMD TRACE	4-41	DTSJDG ON.....	4-37
DTMDET NEG.....	4-41	DTSMEAS.....	4-38
DTMDET NRM.....	4-41	DTSMKRCLR.....	4-36
DTMDET POS	4-41	DTSMKRCP.....	4-36
DTMDET SMP.....	4-41	DTSMKRED	4-36
DTMFRMD CFSP	4-41	DTSREF MKR	4-38
DTMFRMD STSP	4-41		
DTMJJDG OFF	4-41		

DTSREF MOD	4-38	FB.....	4-11
DTSRES ABS.....	4-38	FDPAUTOLVL	4-32
DTSRES MKR	4-38	FDPAVG	4-33
DTSRES REL	4-38	FDPAVGCNT	4-33
DTSRFACT.....	4-38	FDPAVGMD MAX.....	4-33
DTSSETSTD	4-38	FDPAVGMD NUMERIC.....	4-33
DTSSYMRT	4-38	FDPAVGMD POWER	4-33
DTSTMPL OFF.....	4-36	FDPAVGMD TRACE.....	4-33
DTSTMPL ON	4-36	FDPDET NEG	4-34
DTSTMPLBTM.....	4-37	FDPDET NRM	4-34
DTSTMPLCLR	4-36	FDPDET POS	4-34
DTSTMPLCP	4-36	FDPDET SMP	4-34
DTSTMPLDX	4-36	FDPDIV P10DB	4-33
DTSTMPLD	4-36	FDPDIV P2DB	4-33
DTSTMPLPW OFF.....	4-37	FDPDIV P5DB	4-33
DTSTMPLPW ON	4-37	FDPJDG OFF	4-34
DTSTMPLSX	4-36	FDPJDG ON	4-34
DTSTMPLSY	4-36	FDPJDGLOW.....	4-34
DTSUNIT DBM	4-37	FDPJDGUP.....	4-34
DTSUNIT DBUV	4-37	FDPMEAS	4-34
DTSUNIT W.....	4-37	FDPSETSTD	4-34
DTXAVG.....	4-65	FDPUNIT DBM	4-34
DTXPOW	4-65, 4-66	FDPUNIT DBUV	4-34
DUEMOD.....	4-42	FDPUNIT W.....	4-34
DUESWT.....	4-38	FDPWDO OFF	4-33
EDEMODO	4-60	FDPWDO ON.....	4-33
EGPHI?.....	4-60	FDPWPOS	4-33
EGPHQ	4-60	FDPWWID	4-33
EGPHX	4-60	FDSAUTOLVL	4-45
EGPHY	4-60	FDSAVG	4-45
EGPTYP 8CON.....	4-59	FDSAVGCNT	4-45
EGPTYP 8DOT	4-59	FDSAVGMD MAX.....	4-46
EGPTYP 8IEYE	4-59	FDSAVGMD POWER	4-46
EGPTYP 8INP.....	4-59	FDSAVGMD TRACE.....	4-46
EGPTYP 8IQEYE	4-59	FDSCLR	4-45
EGPTYP 8LIN.....	4-59	FDSJCP	4-45
EGPTYP 8QEYE.....	4-59	FDSDET NEG	4-46
EGPTYP CON	4-59	FDSDET NRM	4-46
EGPTYP DEMOD.....	4-59	FDSDET POS	4-46
EGPTYP DOT	4-59	FDSDET SMP	4-46
EGPTYP EVM	4-59	FDSJDG OFF	4-46
EGPTYP IEYE	4-59	FDSJDG ON	4-46
EGPTYP INP.....	4-59	FDSL.....	4-45
EGPTYP IQEYE	4-59	FDSMEAS	4-46, 4-47
EGPTYP LIN.....	4-59	FDSPKMKY.....	4-46
EGPTYP ME	4-59	FDSPRE 16G.....	4-46
EGPTYP PFE	4-59	FDSPRE 36G.....	4-46
EGPTYP QEYE.....	4-59	FDSSETSTD	4-46
ENT.....	4-70	FDSSV	4-45
ERRNO.....	4-71	FDSTBL.....	4-45
FA	4-11	FDSTBLED	4-45

4.1 GPIB Command Index

FDSUNIT DBM	4-46	GPWRM.....	4-52
FDSUNIT DBUV	4-46	GPWRM2.....	4-52
FDSUNIT W.....	4-46	GZ.....	4-70
FINPMD CHL	4-16, 4-18	HAFSLT	4-61, 4-63, 4-65, 4-66
FINPMD FREQ	4-16, 4-18	HCOPY	4-10
FULSLT.....	4-61, 4-63, 4-65, 4-66	HZ.....	4-70
GPHX.....	4-58, 4-69	INPUT IQ	4-17, 4-19
GPHY.....	4-58, 4-69	INPUT RF.....	4-17, 4-19
GPTAVG	4-50, 4-52	IP.....	4-12
GPTDIV P10DB	4-50	IQMD INV.....	4-17, 4-20
GPTDIV P20DB	4-50	IQMD NORM.....	4-17, 4-20
GPTDIV P5DB	4-50	KZ.....	4-70
GPTENT	4-50	LC	4-71
GPTENT2	4-50	LIMMRG	4-40
GPTJDG.....	4-52	LINK BTS.....	4-14
GPTLV0.....	4-50	LINK MS	4-14
GPTLV1.....	4-50	LINK PP	4-18
GPTLV2.....	4-50	LINK RFP.....	4-18
GPTLV3.....	4-50	MA	4-70
GPTLV4.....	4-50	MEASMD BURST	4-14, 4-18
GPTLV5.....	4-50	MEASMD CONT	4-14, 4-18
GPTLV6.....	4-50	MEASMD MBURST	4-14
GPTLV7.....	4-50	MF.....	4-12
GPTLVENT.....	4-51	MFL	4-12
GPTLVENT2.....	4-51	MFLTMD NARW	4-16, 4-18
GPTTM0.....	4-51	MFLTMD WIDE.....	4-16, 4-18
GPTTM1	4-51	MK	4-12
GPTTM2.....	4-51	MKBW.....	4-12
GPTTM3	4-51	MKD	4-12
GPTTM4.....	4-51	MKN	4-12
GPTTM5	4-51	MKOFF.....	4-12
GPTTMENT	4-52	ML	4-12
GPTTMENT2	4-52	MO.....	4-12
GPTTYP	4-50	MODACC.....	4-56
GPTUNIT0 DB	4-51	MODACCPK.....	4-56
GPTUNIT0 DBM	4-51	MODBRSTLVL	4-47, 4-49, 4-53, 4-55
GPTUNIT1 DB	4-51	MODHSS OFF	4-47, 4-49, 4-53
GPTUNIT1 DBM	4-51	MODHSS ON	4-47, 4-49, 4-53
GPTUNIT2 DB	4-51	MODRCFLT OFF	4-55
GPTUNIT2 DBM	4-51	MODRCFLT ON.....	4-55
GPTUNIT3 DB	4-51	MODRNYQ OFF	4-55
GPTUNIT3 DBM	4-51	MODRNYQ ON	4-55
GPTUNIT4 DB	4-51	MODSYS 8PSK	4-14
GPTUNIT4 DBM	4-51	MODSYS GMSK	4-14
GPTUNIT5 DB	4-51	MODTRG EXT	4-47, 4-49, 4-53, 4-55, 4-61, 4-63,
GPTUNIT5 DBM	4-51		
GPTUNIT6 DB	4-51		
GPTUNIT6 DBM	4-51		
GPTUNIT7 DB	4-51		
GPTUNIT7 DBM	4-51		

MODTRG FREE	4-47, 4-49, 4-53, 4-55, 4-61, 4-63, 4-65, 4-66	OBWAVGMD TRACE.....	4-35
MODTRG IF.....	4-47, 4-49, 4-53, 4-55, 4-61, 4-63, 4-65, 4-66	OBWDET NEG	4-35
MODTRGBRST OFF.....	4-47, 4-49, 4-53, 4-55, 4-61, 4-63, 4-65, 4-66	OBWDET NRM	4-35
MODTRGBRST ON	4-47, 4-49, 4-53, 4-55, 4-61, 4-63, 4-65, 4-66	OBWDET POS	4-35
MODTRGDLY	4-47, 4-49, 4-53, 4-55, 4-61, 4-63, 4-65, 4-66	OBWDET SMP	4-35
MODTRGLVL	4-47, 4-49, 4-53, 4-55, 4-61, 4-63, 4-65, 4-66	OBWJDG OFF	4-35
MODTRGSLP FALL	4-47, 4-49, 4-53, 4-55, 4-61, 4-63, 4-65, 4-66	OBWJDG ON.....	4-35
MODTRGSLP RISE.....	4-47, 4-49, 4-53, 4-55, 4-61, 4-63, 4-65, 4-66	OBWJDGLOW.....	4-35
MODTRGSLT	4-47, 4-49, 4-53, 4-55	OBWJDGUP.....	4-35
MODTYP DCS1800.....	4-14	OBWMEAS	4-35, 4-36
MODTYP GSM450.....	4-14	OBWPER.....	4-35
MODTYP GSM480.....	4-14	OBWSETSTD	4-35
MODTYP GSM850.....	4-14	OORAUTOLVL	4-25
MODTYP GSM900.....	4-14	OORAVG	4-25
MODTYP PCS1900	4-14	OORAVGCNT	4-25
MS.....	4-70	OORAVGMD MAX.....	4-26
MV	4-70	OORAVGMD NUMERIC	4-26
MW	4-70	OORAVGMD POWER.....	4-26
MZ	4-70	OORAVGMD TRACE.....	4-26
OBWAUTOLVL	4-35	OORDET NEG.....	4-26
OBWAVG	4-35	OORDET NRM	4-26
OBWAVGCNT	4-35	OORDET POS	4-26
OBWAVGMD MAX.....	4-35	OORDET SMP	4-26
OBWAVGMD NUMERIC.....	4-35	OORDIV P10DB	4-25
OBWAVGMD POWER.....	4-35	OORDIV P2DB	4-25
		OORDIV P5DB	4-25
		OORJDG OFF	4-26
		OORJDG ON.....	4-26
		OORJDGUP.....	4-26
		OORMEAS	4-26
		OORSETSTD	4-26
		OORTRGDT.....	4-25
		OORTRGLVL	4-25
		OORTRGPOS.....	4-25
		OORTRGSLP FALL	4-25
		OORTRGSLP RISE	4-25
		OORTRGSRC EXT.....	4-25
		OORTRGSRC FREE.....	4-25
		OORTRGSRC IF.....	4-25
		OORTRGSRC VIDEO	4-25
		OORUNIT DBM	4-26
		OORUNIT DBUV	4-26
		OORUNIT W.....	4-26
		OORWDO OFF	4-25
		OORWDO ON.....	4-25
		OORWOFPOS.....	4-25
		OORWOFWID	4-25
		OORWONPOS	4-25
		OORWONWID	4-25
		OPR.....	4-71
		OPREVT	4-71

SYNC TSC0	4-15	TDMWDO OFF.....	4-30
SYNC TSC1	4-15	TDMWDO ON	4-30
SYNC TSC2	4-15	TDMWPOS	4-30
SYNC TSC3	4-15	TDMWWID.....	4-30
SYNC TSC4	4-15	TDPAUTOLVL.....	4-21
SYNC TSC5	4-15	TDPAVG	4-22
SYNC TSC6	4-15	TDPAVGCNT	4-22
SYNC TSC7	4-15	TDPAVGMD MAX	4-22
SYNCARB.....	4-15	TDPAVGMD NUMERIC	4-22
TAVGAP	4-48	TDPAVGMD POWER.....	4-22
TAVGMOD.....	4-56	TDPAVGMD TRACE.....	4-22
TAVGPH	4-53	TDPDET NEG.....	4-23
TAVGTX	4-48, 4-65	TDPDET NRM.....	4-23
TDMAUTOLVL.....	4-30	TDPDET POS.....	4-23
TDMAVGCNT.....	4-31	TDPDET SMP.....	4-23
TDMAVGMD MAX	4-31	TDPDIV P10DB	4-22
TDMAVGMD NUMERIC	4-31	TDPDIV P2DB	4-22
TDMAVGMD POWER	4-31	TDPDIV P5DB	4-22
TDMAVGMD TRACE	4-31	TDPJDG OFF	4-24
TDMCLR.....	4-30	TDPJDG ON.....	4-24
TDMDET NEG.....	4-31	TDPJDGLOW	4-24
TDMDET NRM.....	4-31	TDPJDGUP	4-24
TDMDET POS	4-31	TDPMEAS.....	4-24
TDMDET SMP.....	4-31	TDPSETSTD	4-24
TDMJDG OFF.....	4-31	TDPTMPL OFF.....	4-23
TDMJDG ON	4-31	TDPTMPL ON	4-23
TDMLD	4-30	TDPTMPLBTM.....	4-24
TDMMEAS	4-32	TDPTMPLCLR	4-23
TDMPRE 16G	4-31	TDPTMPLCP	4-23
TDMPRE 36G	4-31	TDPTMPLED.....	4-23
TDMREFPW MOD.....	4-31	TDPTMPLPW OFF.....	4-23
TDMREFPW SWP.....	4-31	TDPTMPLPW ON	4-23
TDMREFPWR.....	4-32	TDPTMPLSEL LOW	4-23
TDMRES PK	4-31	TDPTMPLSEL UP.....	4-23
TDMRES RMS.....	4-31	TDPTMPLSX	4-23
TDMSETSTD.....	4-31	TDPTMPLSY	4-23
TDMSV	4-30	TDPTRGDT.....	4-21
TDMTBL	4-30	TDPTRGLVL	4-21
TDMTBLED.....	4-30	TDPTRGPOS.....	4-21
TDMTRGDT	4-30	TDPTRGSLP FALL	4-21
TDMTRGLVL.....	4-30	TDPTRGSLP RISE	4-21
TDMTRGPOS	4-30	TDPTRGSRC EXT.....	4-21
TDMTRGSLP FALL.....	4-30	TDPTRGSRC FREE.....	4-21
TDMTRGSLP RISE	4-30	TDPTRGSRC IF.....	4-21
TDMTRGSRC EXT	4-30	TDPTRGSRC VIDEO.....	4-21
TDMTRGSRC FREE	4-30	TDPUNIT DBM	4-23
TDMTRGSRC IF	4-30	TDPUNIT DBUV	4-23
TDMUNIT DBC.....	4-31	TDPUNIT W.....	4-23
TDMUNIT DBM.....	4-31	TDPWDO OFF	4-22
TDMUNIT DBUV.....	4-31	TDPWDO ON.....	4-22
TDMUNIT W	4-31	TDPWPOS.....	4-22

4.1 GPIB Command Index

TDPWWID	4-22	TGTTRG EXT	4-32, 4-39
TDSAUTOLVL	4-27	TGTTRG FREE	4-32, 4-39
TDSAVG	4-28	TGTTRG IF	4-32, 4-39
TDSAVGCNT	4-28	TGTTRG VIDEO	4-32, 4-39
TDSAVGMD MAX	4-28	TGTTRGDT	4-32, 4-39
TDSAVGMD NUMERIC	4-28	TGTTRGLVL	4-32, 4-39
TDSAVGMD POWER	4-28	TGTTRGPOS	4-32, 4-39
TDSAVGMD TRACE	4-28	TGTTRGSLP FALL	4-32, 4-39
TDSCLR	4-28	TGTTRGSLP RISE	4-32, 4-39
TDSDET NEG	4-28	TGTWID	4-32, 4-39
TDSDET NRM	4-28	TPWAVG	4-24
TDSDET POS	4-28	TPWTM	4-22
TDSDET SMP	4-28	TRGDT	4-21
TDSJDG OFF	4-29	TRGLVL	4-21
TDSJDG ON	4-29	TRGMODE EXT	4-47, 4-49, 4-53, 4-55
TDSLDR	4-27	TRGMODE FREE	4-47, 4-49, 4-53, 4-55
TDSMEAS	4-29	TRGMODE IF	4-47, 4-49, 4-53, 4-55
TDSMULTI	4-29	TRGMSLP FALL	4-47, 4-49, 4-53, 4-55
TDSPKMKY	4-29	TRGMSLP RISE	4-47, 4-49, 4-53, 4-55
TDSPRE 16G	4-29	TRGPOS	4-21
TDSPRE 36G	4-29	TRGSLP FALL	4-21
TDSRES PK	4-29	TRGSLP RISE	4-21
TDSRES RMS	4-29	TRGSRC EXT	4-21
TDSSETSTD	4-29	TRGSRC FREE	4-21
TDSSV	4-28	TRGSRC IF	4-21
TDSTBL	4-27	TRGSRC VIDEO	4-21
TDSTBLED	4-27	TRGSTR TYP1	4-47, 4-49, 4-53, 4-55
TDSTBLF ABS	4-28	TRGSTR TYP2	4-47, 4-49, 4-53, 4-55
TDSTBLF REL	4-28	TRSPMD EXT	4-27
TDSTRGDT	4-27	TRSPMD FREE	4-27
TDSTRGLVL	4-27	TRSPMD IF	4-27
TDSTRGPOS	4-27	TRSPSLP FALL	4-27
TDSTRGSLP FALL	4-27	TRSPSLP RISE	4-27
TDSTRGSLP RISE	4-27	TWDO OFF	4-22
TDSTRGSRC EXT	4-27	TWDO ON	4-22
TDSTRGSRC FREE	4-27	TWDX	4-22
TDSTRGSRC IF	4-27	TWLX	4-22
TDSUNIT DBM	4-28	TXAVG	4-48, 4-65
TDSUNIT DBUV	4-28	TXPWR	4-48, 4-65, 4-66
TDSUNIT W	4-28	US	4-70
TGTDET NEG	4-33, 4-39	VA	4-11
TGTDET NRM	4-33, 4-39	VB	4-11
TGTDET POS	4-33, 4-39	XDB	4-12
TGTDET SMP	4-33, 4-39		
TGTPOS	4-32, 4-39		
TGTSETUP OFF	4-32, 4-39		
TGTSETUP ON	4-32, 4-39		
TGTSRC EXT	4-32, 4-39		
TGTSRC TRG	4-32, 4-39		
TGTSWP OFF	4-33, 4-39		
TGTSWP ON	4-33, 4-39		

XDL	4-12
XDR	4-12
ZFILD OFF	4-18
ZFILD ON	4-18

4.2 GPIB Command Codes

4.2 GPIB Command Codes

The following table list the GPIB commands by function.

Table 4-1 Operating mode

Function		Listener Code	Talker Request		Remarks
			Code	Output Format	
Operating mode	Spectrum analyzer mode	SETFUNC CW	SETFUNC?	0: Spectrum analyzer 1: TRANSIENT	
	TRANSIENT mode	SETFUNC TRAN			
Communication System	WCDMA mode	COMMSYS WCDMA	COMMSYS?	1: W CDMA 2: IS-95 3: PDC 4: PHS 5: IS-136 6: GSM 7: DECT	*1
	IS-95 mode	COMMSYS IS95			
	PDC mode	COMMSYS PDC			
	PHS mode	COMMSYS PHS			
	IS-136 mode	COMMSYS IS136			
	GSM mode	COMMSYS GSM			
	DECT mode	COMMSYS DECT			

*1: Listener code is available only when the analyzer is set to the CW mode. The codes within the talker request are available for both the CW and TRANSIENT modes.

Table 4-2 ATT key (Attenuator)

Function		Listener Code	Talker Request		Remarks
			Code	Output Format	
Attenuator	AT	AT *	AT?	Level	
	ATT AUTO	AA	AA?	0: Manual 1: AUTO	
	Min. ATT Min. ATT ON OFF	ATMIN * ATMIN ON [*] ATMIN OFF	ATMIN? ATMINON?	Level 0: OFF 1: ON	

Table 4-3 COPY key (Hand copy)

Function		Listener Code	Talker Request		Remarks
			Code	Output Format	
Printer output File output		HCOPY	-	-	

Table 4-4 COUPLE key (Couple function)

Function		Listener Code	Talker Request		Remarks
			Code	Output Format	
Couple function	RBW	RB *	RB?	Frequency	
	RBW AUTO	BA	BA?	0: Manual 1: AUTO	
	VBW	VB *	VB?	Frequency	
	VBW AUTO	VA	VA?	0: Manual 1: AUTO	
	Sweep Time	SW * ST *	SW? ST?	Time	
	Sweep Time Auto	AS	AS?	0: Manual 1: AUTO	

Table 4-5 FREQ key (Frequency)

Function		Listener Code	Talker Request		Remarks
			Code	Output Format	
Frequency	Center frequency	CF *	CF?	Frequency	
	Start frequency	FA *	FA?	Frequency	
	Stop frequency	FB *	FB?	Frequency	

Table 4-6 LEVEL key (Reference Level)

Function		Listener Code	Talker Request		Remarks
			Code	Output Format	
Reference level	Reference level	RL *	RL?	Level	

4.2 GPIB Command Codes

Table 4-7 MKR key (Marker)

Function	Listener Code	Talker Request		Remarks
		Code	Output Format	
Marker	ΔMarker ON	MKD [*]	-	Frequency (Time)
	OFF	MKOFF MO	- -	- -
	Reading marker frequency (time)	-	MF?	Frequency (Time)
	Reading marker level	-	ML?	Level
	Reading marker frequency (time) and marker level	-	MFL?	Frequency (Time), Level
	Normal marker	MK [*] MKN [*]	- -	Frequency (Time)
	Peak search	PS		
X-dB Down				
X-dB Down width	MKBW *	MKBW?	Level	
X-dB Down	XDB	-		
X-dB Down Left	XDL	-		
Right	XDR	-		
Display mode REL.	DC0	DC?	0: Relative mode	
ABS.L.	DC1		1: Absolute mode (Left side)	
ABS.R.	DC2		2: Absolute mode (Right side)	

Table 4-8 PRESET Key (Initialization)

Function	Listener Code	Talker Request		Remarks
		Code	Output Format	
Preset	Instrument preset	IP	-	-

Table 4-9 RCL Key (Recall)

Function	Listener Code	Talker Request		Remarks
		Code	Output Format	
Recall	RC REG_nn RC file name	- -	nn: 01 to 10 File name: Max.8 character	

Table 4-10 SAVE Key (Save)

Function		Listener Code	Talker Request		Remarks
			Code	Output Format	
Save	Save	SV REG_nn SV file name	- -	nn: 01 to 10 File name: Max.8 character	
	Deletion	DEL REG_nn DEL file name	- -	nn: 01 to 10 File name: Max.8 character	

Table 4-11 SPAN Key (Frequency span)

Function		Listener Code	Talker Request		Remarks
			Code	Output Format	
Fre- quency Span	-	SP *	SP?	Frequency	

4.2 GPIB Command Codes

Table 4-12 TRANSIENT Key (1 of 56)

Function	Listener Code	Talker Request		Remarks
		Code	Output Format	
STD Setup (GSM)	Modulation Method			
	GMSK	MODSYS GMSK	MODSYS?	0:GMSK
	3PI/8 Shift 8PSK	MODSYS 8PSK		1: 3PI/8 Shift 8PSK
	Communication System			
	GSM450	MODTYP GSM450	MODTYP?	0: GSM450
	GSM480	MODTYP GSM480		1: GSM480
	GSM850	MODTYP GSM850		2: GSM850
	GSM900	MODTYP GSM900		3:GSM900
	DCS1800	MODTYP DCS1800		4: DCS1800
	PCS1900	MODTYP PCS1900		5: PCS1900
Meas. Mode				
BURST	MEASMD BURST	MEASMD?	0: BURST	
MULTI-BURST	MEASMD MBURST		1: MULTI-BURST	
CONTINUOUS	MEASMD CONT		2: CONTINUOUS	
Link				
MS	LINK MS	LINK?	0: MS	
BTS	LINK BTS		1: BTS	
Burst Type				
148bits	BTYP B148	BTYP?	0: 148bits	
88bits	BTYP B88		1: 88bits	

Table 4-12 TRANSIENT Key (2 of 56)

Function	Listener Code	Talker Request		Remarks
		Code	Output Format	
STD Setup (GSM)	Sync.Type&Sync.Word Training Sequence Code Sync. (When select to Burst Type, 148BIT)			
	TSC0	SYNC TSC0	SYNC?	0:TSC0 or BIT
	TSC1	SYNC TSC1		1:TSC1
	TSC2	SYNC TSC2		2:TSC2
	TSC3	SYNC TSC3		3:TSC3
	TSC4	SYNC TSC4		4:TSC4
	TSC5	SYNC TSC5		5:TSC5
	TSC6	SYNC TSC6		6:TSC6
	TSC7	SYNC TSC7		7:TSC7
	ARB	SYNC ARB		8:ARB
	Sync. Bit Sync. (When select to Burst Type, 88BIT)	SYNC BIT		99:NO SYNC WORD
SYNC. WORD Not using	SYNC NO			
Sync. Arbitration (The data type varies according to the modula- tion format.)	SYNCARB *	SYNCARB?	Hexadecimal number (0 thru 2FFFFFFF) (Modulation method: when set to GMSK) Octal (26 symbols) (Modulation method: when set to 3PI/8 Shift 8PSK)	

4.2 GPIB Command Codes

Table 4-12 TRANSIENT Key (3 of 56)

Function	Listener Code	Talker Request		Remarks
		Code	Output Format	
STD Setup (GSM)	Receiving Filter mode			
	WIDE	MFLTMD WIDE	MFLTMD?	0: WIDE
	NARROW	MFLTMD NARW		1: NARROW
	Power Control Level			
	GSM450	PWCTL n	PWCTL?	16: 11dBm, 17: 9dBm
	GSM480	(n: 16 to 19, 99)		18: 7dBm, 19: 5dBm
	GSM900			99: Other
	DCS1800	PWCTL n	PWCTL?	11: 8dBm, 12: 6dBm
		(n: 11 to 15, 99)		13: 4dBm, 14: 2dBm
				15: 0dBm, 99: Other
Offset Level	RO *	RO?	Level	
Freq.Setting mode				
Freq. Input mode	FINPMD FREQ	FINPMD?	0: Freq. Input	
Channel Input mode	FINPMD CHL		1: Channel Input	
Channel Setting	CH *	CH?	Integer (Channel No.)	
Channel Edit				
Input #1 (MS)	CHEDUP1 *,*,*,*	CHEDUP1?	ch1, ch2, f1, f2, chof	
Input #2 (MS)	CHEDUP2 *,*,*,*	CHEDUP2?	ch1, ch2, f1, f2, chof	
Input #3 (MS)	CHEDUP3 *,*,*,*	CHEDUP3?	ch1, ch2, f1, f2, chof	
Input #1 (BTS)	CHEDDN1 *,*,*,*	CHEDDN1?	ch1, ch2, f1, f2, chof	
Input #2 (BTS)	CHEDDN2 *,*,*,*	CHEDDN2?	ch1, ch2, f1, f2, chof	
Input #3 (BTS)	CHEDDN3 *,*,*,*	CHEDDN3?	ch1, ch2, f1, f2, chof	
			ch1: Start channel no.	Units of frequency are necessary for f1 and f2.
			ch2: Stop channel no.	
			f1: Base frequency(Hz)	
			f2: Channel space(Hz)	
			chof: Channel offset	

Table 4-12 TRANSIENT Key (4 of 56)

Function	Listener Code	Talker Request		Remarks
		Code	Output Format	
STD Setup (GSM)	Selection of ENABLE or DISABLE for channel table			
	#1 ENABLE	CHTBL1 ENBL	CHTBL1?	0: Disable
	DISABLE	CHTBL1 DSBL		1: Enable
	#2 ENABLE	CHTBL2 ENBL	CHTBL2?	0: Disable
	DISABLE	CHTBL2 DSBL		1: Enable
	#3 ENABLE	CHTBL3 ENBL	CHTBL3?	0: Disable
	DISABLE	CHTBL3 DSBL		1: Enable
	Channel			
	Copy from STD	CHSETSTD		
	Input			
RF	INPUT RF	INPUT?	0: RF	
Baseband(I&Q)	INPUT IQ		1: Baseband(I&Q)	
BaseBand Input				
AC	BBINPUT AC	BBINPUT?	0: AC	
DC	BBINPUT DC		1: DC	
IQ Inverse				
NORMAL	IQMD NORM	IQMD?	0: NORMAL	
INVERSE	IQMD INV		1: INVERSE	
Auto Level Setting				
Auto Level OFF	ALS OFF	ALS?	0: OFF	
Auto Level ON	ALS ON		1: ON	
DC CAL	CLDC			

4.2 GPIB Command Codes

Table 4-12 TRANSIENT Key (5 of 56)

Function	Listener Code	Talker Request		Remarks
		Code	Output Format	
STD Setup (DECT)	Meas. Mode			
	BURST	MEASMD BURST	MEASMD?	0: BURST
	CONTINUOUS	MEASMD CONT		2: CONTINUOUS
	Link			
	RFP	LINK RFP	LINK?	0: RFP
	PP	LINK PP		1: PP
	Sync.Type			
	SYNC WORD	SYNC SYNC	SYNC?	0: SYNC WORD
	NO SYNC WORD	SYNC NO		1: NO SYNC WORD
	Physical Packet			
	P00	PHYPKT P00	PHYPKT?	0: P00
	P32	PHYPKT P32		1: P32
	P08j	PHYPKT P08		2: P08j
P80	PHYPKT P80		3: P80	
Z-Field				
OFF	ZFILD OFF	ZFILD?	0: OFF	
ON	ZFILD ON		1: ON	
Receiving filter mode				
WIDE	MFLTMD WIDE	MFLTMD?	0: WIDE	
NARROW	MFLTMD NARW		1: NARROW	
Power Level				
LEVEL1: 2.5mW	PWRLVL *	PWRLVL?	1: LEVEL1	
LEVEL2: 250mW			2: LEVEL2 (Integer)	
Offset Level	RO *	RO?	Level	
Frequency Setting Mode				
Frequency Input Mode	FINPMD FREQ	FINPMD?	0: Freq. Input	
Channel Input Mode	FINPMD CHL		1: Channel Input	

Table 4-12 TRANSIENT Key (6 of 56)

Function	Listener Code	Talker Request		Remarks	
		Code	Output Format		
STD Setup (DECT)	Channel Setting	CH *	CH?	Integer (Channel No.)	Units of frequency are necessary for f1 and f2.
	Channel Edit				
	Input #1(PP)	CHEDUP1 *,*,*,*	CHEDUP1?	ch1, ch2, f1, f2, chof	
	Input #2(PP)	CHEDUP2 *,*,*,*	CHEDUP2?	ch1, ch2, f1, f2, chof	
	Input #3(PP)	CHEDUP3 *,*,*,*	CHEDUP3?	ch1, ch2, f1, f2, chof	
	Input #1(RFP)	CHEDDN1 *,*,*,*	CHEDDN1?	ch1, ch2, f1, f2, chof	
	Input #2(RFP)	CHEDDN2 *,*,*,*	CHEDDN2?	ch1, ch2, f1, f2, chof	
	Input #3(RFP)	CHEDDN3 *,*,*,*	CHEDDN3?	ch1, ch2, f1, f2, chof	
				ch1: Start channel no. ch2: Stop channel no. f1: Base frequency(Hz) f2: Channel space(Hz) chof: Channel offset	
	Channel Table Enable/Disable				
#1 ENABLE	CHTBL1 ENBL	CHTBL1?	0: Disable		
DISABLE	CHTBL1 DSBL		1: Enable		
#2 ENABLE	CHTBL2 ENBL	CHTBL2?	0: Disable		
DISABLE	CHTBL2 DSBL		1: Enable		
#3 ENABLE	CHTBL3 ENBL	CHTBL3?	0: Disable		
DISABLE	CHTBL3 DSBL		1: Enable		
Channel					
Copy from STD	CHSETSTD				
Input					
RF	INPUT RF	INPUT?	0: RF		
Baseband(I&Q)	INPUT IQ		1: Baseband(I&Q)		

4.2 GPIB Command Codes

Table 4-12 TRANSIENT Key (7 of 56)

Function	Listener Code	Talker Request		Remarks
		Code	Output Format	
STD Setup (DECT)	BaseBand Input			
	AC	BBINPUT AC	BBINPUT?	0: AC
	DC	BBINPUT DC		1: DC
	IQ Inverse			
	NORMAL	IQMD NORM	IQMD?	0: NORMAL
	INVERSE	IQMD INV		1: INVERSE
Auto Level Setting				
Auto Level OFF	ALS OFF	ALS?	0: OFF	
Auto Level ON	ALS ON		1: ON	
DC CAL	CLDC			

Table 4-12 TRANSIENT Key (8 of 56)

Function	Listener Code	Talker Request		Remarks	
		Code	Output Format		
T-Domain Power	Auto Level Set	AUTOWFL TDPAUTOLVL			
	Trigger Setup				
	Trigger Source				
	FREERUN	TRGSRC FREE TDPTRGSRC FREE	TRGSRC? TDPTRGSRC?	0: FREERUN 1: VIDEO	
	VIDEO	TRGSRC VIDEO TDPTRGSRC VIDEO		2: IF 3: EXT	
	IF	TRGSRC IF TDPTRGSRC IF			
	EXT	TRGSRC EXT TDPTRGSRC EXT			
	Trigger Slope				
+	TRGSLP RISE TDPTRGSLP RISE	TRGSLP? TDPTRGSLP?	0: - 1: +		
-	TRGSLP FALL TDPTRGSLP FALL				
Trigger Level	TRGLVL * TDPTRGLVL *	TRGLVL? TDPTRGLVL?	Integer (0 to 100)		
Trigger Position	TRGPOS * TDPTRGPOS *	TRGPOS? TDPTRGPOS?	Integer (0 to 100)		
Trigger Delay	TRGDT * TDPTRGDT *	TRGDT? TDPTRGDT?	Time		

4.2 GPIB Command Codes

Table 4-12 TRANSIENT Key (9 of 56)

Function	Listener Code	Talker Request		Remarks	
		Code	Output Format		
T-Domain Power	Window Setup				
	Window				
	ON	TDPWDO ON TWDO ON	TDPWDO? TWDO?	0: OFF	
	OFF	TDPWDO OFF TWDO OFF		1: ON	
	Window Position	TDPWPOS * TWLX *	TDPWPOS? TWLX?	Time	
	Window Width	TDPWWID * TWDX *	TDPWWID? TWDX?	Time	
	Y Scale				
	10dB/div	TDPDIV P10DB DCPDIV P10DB	TDPDIV? DCPDIV?	0: 10dB/div	
	5dB/div	TDPDIV P5DB DCPDIV P5DB		1: 5dB/div	
	2dB/div	TDPDIV P2DB DCPDIV P2DB		2: 2dB/div	
Average Times	TDPAVGCNT * TDPAVG * TPWTM *	TDPAVGCNT? TDPAVG? TPWTM?	Integer (1:OFF, 2 to 999) Integer (1:OFF, 2 to 999) Integer (1:OFF, 2 to 999)	 *1 *1	
Average Mode					
TRACE AVG	TDPAVGMD TRACE	TDPAVGMD?	0: Trace Avg		
MAX HOLD	TDPAVGMD MAX		1: Max Hold		
POWER AVG	TDPAVGMD POWER		2: Power Avg		
NUMERIC	TDPAVGMD NUMERIC		3: Numeric		

*1: Average Mode is set to POWER AVG.

Table 4-12 TRANSIENT Key (10 of 56)

Function	Listener Code	Talker Request		Remarks
		Code	Output Format	
T-Domain Power	Template			
	Template			
	ON	TDPTMPL ON	TDPTMPL?	0: OFF
	OFF	TDPTMPL OFF		1: ON
	Template Shift			
	Shift X	TDPTMPLSX *	TDPTMPLSX?	Time
	Shift Y	TDPTMPLSY *	TDPTMPLSY?	Level
	Template Edit			
	Template UP/LOW Select	TDPTMPLSEL UP TDPTMPLSEL LOW	TDPTMPLSEL?	0: UP 1: LOW
	Copy from STD Template	TDPTMPLCP		
	Data Input	TDPTMPLED *,*		t1, l1 t1: Time l1: Level
	Init Table	TDPTMPLCLR		
	Parameter Setup			
	Detector			
Normal	TDPDET NRM	TDPDET?	0: Normal	
Posi	TDPDET POS		1: Posi	
Nega	TDPDET NEG		2: Nega	
Sample	TDPDET SMP		3: Sample	
Display Unit				
dBm	TDPUNIT DBM	TDPUNIT?	0: dBm	
W	TDPUNIT W		1: W	
dB μ V	TDPUNIT DBUV		2: dB μ V	
Template Couple to Power				
ON	TDPTMPLPW ON	TDPTMPLPW?	0: OFF	
OFF	TDPTMPLPW OFF		1: ON	

4.2 GPIB Command Codes

Table 4-12 TRANSIENT Key (11 of 56)

Function		Listener Code	Talker Request		Remarks
			Code	Output Format	
T-Domain Power	Template Limit	TDPTMPLBTM *	TDPTMPLBTM?	Level (dBm/W/dBμV)	
	Judgment				
	ON	TDPJDG ON	TDPJDG?	0: OFF	
	OFF	TDPJDG OFF		1: ON	
	Upper Limit	TDPJDGUP *	TDPJDGUP?	Level	
	Lower Limit	TDPJDGLOW *	TDPJDGLOW?	Level	
	Set to STD	TDPSETSTD			
	Starts measurement				
T-Domain Power	TPWAVG TDPMEAS				
Starts measurement in the same mode	SI				
Measurement results					
T-Domain Power		TDPMEAS? TPWAVG?	l1, j1 l1: Level (dBm/W/dBμV) j1: Integer (0: FAIL, 1: PASS, -1: Judgment OFF) Level		

Table 4-12 TRANSIENT Key (12 of 56)

Function	Listener Code	Talker Request		Remarks
		Code	Output Format	
ON/OFF Ratio	Auto Level Set	OORAUTOLVL		
	Trigger Setup			
	Trigger Source			
	FREERUN	OORTRGSRC FREE	OORTRGSRC?	0: FREERUN
	VIDEO	OORTRGSRC VIDEO		1: VIDEO
	IF	OORTRGSRC IF		2: IF
	EXT	OORTRGSRC EXT		3: EXT
	Trigger Slope			
	+	OORTRGSLP RISE	OORTRGSLP?	0: -
	-	OORTRGSLP FALL		1: +
	Trigger Level	OORTRGLVL*	OORTRGLVL?	Integer (0 to 100)
	Trigger Position	OORTRGPOS *	OORTRGPOS?	Integer (0 to 100)
	Trigger Delay	OORTRGDT *	OORTRGDT?	Time
	Window Setup			
	Window			
	ON	OORWDO ON	OORWDO?	0: OFF
	OFF	OORWDO OFF		1: ON
	ON Position	OORWONPOS *	OORWONPOS?	Time
	ON Width	OORWONWID *	OORWONWID?	Time
	OFF Position	OORWOFPOS *	OORWOFPOS?	Time
OFF Width	OORWOFWID *	OORWOFWID?	Time	
Y Scale				
10dB/div	OORDIV P10DB	OORDIV?	0: 10dB/div	
5dB/div	OORDIV P5DB		1: 5dB/div	
2dB/div	OORDIV P2DB		2: 2dB/div	
Average Times	OORAVGCNT *	OORAVGCNT?	Integer (1:OFF, 2 to 999)	
	OORAVG *	OORAVG?	Integer (1:OFF, 2 to 999)	

*1: Average Mode is set to NUMERIC.

4.2 GPIB Command Codes

Table 4-12 TRANSIENT Key (13 of 56)

Function	Listener Code	Talker Request		Remarks
		Code	Output Format	
ON/OFF Ratio	Average Mode			
	TRACE AVG	OORAVGMD TRACE	OORAVGMD?	0: Trace Avg
	MAX HOLD	OORAVGMD MAX		1: Max Hold
	POWER AVG	OORAVGMD POWER		2: Power Avg
	NUMERIC	OORAVGMD NUMERIC		3: Numeric
	Parameter Setup			
	Detector			
	Normal	OORDET NRM	OORDET?	0: Normal
	Posi	OORDET POS		1: Posi
	Nega	OORDET NEG		2: Nega
	Sample	OORDET SMP		3: Sample
	Display Unit			
	dBm	OORUNIT DBM	OORUNIT?	0: dBm
W	OORUNIT W		1: W	
dBμV	OORUNIT DBUV		2: dBμV	
Judgment				
ON	OORJDG ON	OORJDG?	0: OFF	
OFF	OORJDG OFF		1: ON	
Upper Limit	OORJDGUP *	OORJDGUP?	Level	
Set to STD	OORSETSTD			
Starts measurement				
ON/OFF Ratio	OORMEAS			
Starts measurement in the same mode	SI			
Measurement results				
ON/OFF Ratio		OORMEAS?	l1, l2, d1, j1 l1: ON Level (dBm/W/dBμV) l2: OFF Level (dBm/W/dBμV) d1: ON/OFF Ratio(dB) j1: Integer (0: FAIL, 1: PASS, -1: Judgment OFF)	

Table 4-12 TRANSIENT Key (14 of 56)

Function	Listener Code	Talker Request		Remarks
		Code	Output Format	
T-Domain Spurious	Auto Level Set	TDSAUTOLVL		
	Trigger Setup			
	Trigger Source			
	FREERUN	TDSTRGSRG FREE TRSPMD FREE	TDSTRGSRG?	0: FREERUN
	IF	TDSTRGSRG IF TRSPMD IF	TRSPMD?	2: IF
	EXT	TDSTRGSRG EXT TRSPMD EXT		3: EXT
	Trigger Slope			
	+	TDSTRGSLP RISE TRSPSLP RISE	TDSTRGSLP?	0: - 1: +
	-	TDSTRGSLP FALL TRSPSLP FALL	TRSPSLP?	
	Trigger Level	TDSTRGLVL *	TDSTRGLVL?	Integer (0 to 100)
	Trigger Position	TDSTRGPOS *	TDSTRGPOS?	Integer (0 to 100)
	Trigger Delay	TDSTRGDT *	TDSTRGDT?	Time
	Table			
	Table No. 1/2/3	TDSTBL *	TDSTBL?	Integer (1 to 3)
Table Edit	TDSTBLEDD **,*		f1, l1 f1: Frequency l1: Limit Level	
Load Table	TDSLDD RCLTBL *		Integer (1 to 3)	

4.2 GPIB Command Codes

Table 4-12 TRANSIENT Key (15 of 56)

Function	Listener Code	Talker Request		Remarks	
		Code	Output Format		
T-Domain Spurious	Save Table	TDSSV SVSTBL *		Integer (1 to 3)	*1
	Init Table	TDSCLR DELSTBL			
	Table Freq. Input				
	ABS	TDSTBLF ABS	TDSTBLF?	0: ABS	
	REL	TDSTBLF REL		1: REL	
	Average Times	TDSAVGCNT *	TDSAVGCNT?	Integer (1:OFF, 2 to 999)	
		TDSAVG *	TDSAVG?	Integer (1:OFF, 2 to 999)	
	Average Mode				
	TRACE AVG	TDSAVGMD TRACE	TDSAVGMD?	0: Trace Avg	
	MAX HOLD	TDSAVGMD MAX		1: Max Hold	
POWER AVG	TDSAVGMD POWER		2: Power Avg		
NUMERIC	TDSAVGMD NUMERIC		3: Numeric		
Parameter Setup					
Detector					
Normal	TDSDET NRM	TDSDET?	0: Normal		
Posi	TDSDET POS		1: Posi		
Nega	TDSDET NEG		2: Nega		
Sample	TDSDET SMP		3: Sample		
Display Unit					
dBm	TDSUNIT DBM	TDSUNIT?	0: dBm		
W	TDSUNIT W		1: W		
dB μ V	TDSUNIT DBUV		2: dB μ V		

*1: When Detector is set to Positive, Average Mode is set to MAX HOLD. When Detector is set to something other than Positive, Average Mode is set to TRACE AVG.

Table 4-12 TRANSIENT Key (16 of 56)

Function	Listener Code	Talker Request		Remarks
		Code	Output Format	
T-Domain Spurious	Judgment			
	ON	TDSJDG ON	TDSJDG?	0: OFF
	OFF	TDSJDG OFF		1: ON
	Result			
	Peak	TDSRES PK	TDSRES?	0: Peak
	RMS	TDSRES RMS		1: RMS
	Multiplier	TDSMULTI *	TDSMULTI?	Real Number
	Peak Marker Y-Delta	TDSPKMKY *	TDSPKMKY?	Real Number
	Preselector 1.6G	TDSPRE 16G	TDSPRE?	0: 1.6G
	3.6G	TDSPRE 36G		1: 3.6G
	Set to Default	TDSSETSTD		
	Starts measurement			
Spurious	TDSMEAS SPUR			
Starts measurement in the same mode	SI			
Measurement results				
Spurious		TDSMEAS?	n<CR+LF>+f1,l1,j1<CR+LF> +fn,ln,jn<CR+LF> n: Amount (Integer) fn: Frequency ln: Level (dBm/W/dBµV) jn: Integer (0: FAIL, 1: PASS, -1: Judgment OFF)	

4.2 GPIB Command Codes

Table 4-12 TRANSIENT Key (17 of 56)

Function	Listener Code	Talker Request		Remarks
		Code	Output Format	
T-Domain Due to Modulation	Auto Level Set	TDMAUTOLVL		
	Trigger Setup			
	Trigger Source			
	FREE RUN	TDMTRGSRC FREE	TDMTRGSRC?	0: FREE RUN
	IF	TDMTRGSRC IF		2: IF
	EXT	TDMTRGSRC EXT		3: EXT
	Trigger Slope			
	+	TDMTRGSLP RISE	TDMTRGSLP?	0: -
	-	TDMTRGSLP FALL		1: +
	Trigger Level	TDMTRGLVL *	TDMTRGLVL?	Integer (0 to 100)
	Trigger Position	TDMTRGPOS *	TDMTRGPOS?	Integer (0 to 100)
	Delay Time	TDMTRGDT *	TDMTRGDT?	Time
	Window Setup			
	Window			
	ON	TDMWDO ON	TDMWDO?	0: OFF
	OFF	TDMWDO OFF		1: ON
	Window Position	TDMWPOS *	TDMWPOS?	Time
Window Width	TDMWWID *	TDMWWID?	Time	
Table Edit				
Table No. 1/2/3	TDMTBL *	TDMTBL?	Integer (1 to 3)	
Load Table	TDMLD			
Save Table	TDMSV			
Table Init	TDMCLR			
Table Edit	TDMTBLED *,*		f1,l1 f1: Frequency l1: Limit Level	

Table 4-12 TRANSIENT Key (18 of 56)

Function	Listener Code	Talker Request		Remarks
		Code	Output Format	
T-Domain Due to Modulation	Average Times	TDMAVGCNT *	TDMAVGCNT?	Integer (1:OFF, 2 to 999)
	Average Mode			
	TRACE AVG	TDMAVGMD TRACE	TDMAVGMD?	0: Trace Avg
	MAX HOLD	TDMAVGMD MAX		1: Max Hold
	POWER AVG	TDMAVGMD POWER		2: Power Avg
	NUMERIC	TDMAVGMD NUMERIC		3: Numeric
	Parameter Setup			
	Detector			
	Normal	TDMDET NRM	TDMDET?	0: Normal
	Posi	TDMDET POS		1: Positive
	Nega	TDMDET NEG		2: Negative
	Sample	TDMDET SMP		3: Sample
	Result			
	PEAK	TDMRES PK	TDMRES?	0: Peak
RMS	TDMRES RMS		1: RMS	
Display Unit				
dBm	TDMUNIT DBM	TDMUNIT?	0: dBm	
W	TDMUNIT W		1: W	
db μ V	TDMUNIT DBUV		2: db μ V	
dBc	TDMUNIT DBC		3: dBc	
Ref Power				
SWEEP	TDMREFPW SWP	TDMREFPW?	0: Sweep	
MODULATION	TDMREFPW MOD		1: Modulation	
Judgment				
ON	TDMJDG ON	TDMJDG?	0: OFF	
OFF	TDMJDG OFF		1: ON	
Pleselector				
1.6G	TDMPRE 16G	TDMPRE?	0: 1.6G	
3.6G	TDMPRE 36G		1: 3.6G	
Set to STD	TDMSETSTD			

4.2 GPIB Command Codes

Table 4-12 TRANSIENT Key (19 of 56)

Function	Listener Code	Talker Request		Remarks
		Code	Output Format	
T-Domain Due to Modulation	Starts measurement Due to Modulation	TDMMEAS	TDMMEAS?	n<CR+LF>,f1,lp1,up1, j1<CR+LF>,.....fn,lpn, upn,jn<CR+LF> n: Amount (0 to 10) fx: Frequency lpx: Lower side power (dBm/W/dBμV) upx: Upper side power (dBm/W/dBμV) jx: Integer (0:FAIL, 1:PASS, -1:Judgment OFF)
	Starts measurement in the same mode	SI		
	Ref.Power		TDMREFPWR?	Level
F-Domain Power	Auto Level Set	FDPAUTOLVL		
	Gate Setup			
	ON	TGTSETUP ON	TGTSETUP?	0: OFF
	OFF	TGTSETUP OFF		1: ON
	Trigger Source			
	FREE RUN	TGTTRG FREE	TGTTRG?	0: FREERUN
	VIDEO	TGTTRG VIDEO		1: VIDEO
	IF	TGTTRG IF		2: IF
	EXT	TGTTRG EXT		3: EXT
	Trigger Slope			
	-	TGTTRGSLP FALL	TGTTRGSLP?	0: -
	+	TGTTRGSLP RISE		1: +
	Trigger Level	TGTTRGLVL *	TGTTRGLVL?	Integer (0 to 100)
Trigger Position	TGTTRGPOS *	TGTTRGPOS?	Integer (0 to 100)	
Trigger Delay	TGTTRGDT *	TGTTRGDT?	Time	
Gate Source				
Trigger	TGTSRC TRG	TGTSRC?	0: Trigger	
Ext Gate	TGTSRC EXT		1: EXT	
Gate Position	TGTPOS *	TGTPOS?	Time	
Gate Width	TGTWID *	TGTWID?	Time	

Table 4-12 TRANSIENT Key (20 of 56)

Function	Listener Code	Talker Request		Remarks	
		Code	Output Format		
F-Domain Power	Detector				
	Normal	TGTDET NRM	TGTDET?	0: Normal	
	Posi	TGTDET POS		1: Posi	
	Nega	TGTDET NEG		2: Nega	
	Sample	TGTDET SMP		3: Sample	
	Gated Sweep ON/OFF				
	ON	TGTSWP ON	TGTSWP?	0: OFF	
	OFF	TGTSWP OFF		1: ON	
	Window Setup				
	Window				
	ON	FDPWDO ON	FDPWDO?	0: OFF	
	OFF	FDPWDO OFF		1: ON	
	Window Position	FDPWPOS *	FDPWPOS?	Frequency	
Window Width	FDPWWID *	FDPWWID?	Frequency		
Y Scale					
10dB/div	FDPDIV P10DB	FDPDIV?	0: 10dB/div		
5dB/div	FDPDIV P5DB		1: 5dB/div		
2dB/div	FDPDIV P2DB		2: 2dB/div		
Average Times	FDPAVGCNT *	FDPAVGCNT?	Integer (1:OFF, 2 to 999)	*1	
	FDPAVG *	FDPAVG?	Integer (1:OFF, 2 to 999)		
Average Mode					
TRACE AVG	FDPAVGMD TRACE	FDPAVGMD?	0: Trace Avg		
MAX HOLD	FDPAVGMD MAX		1: Max Hold		
POWER AVG	FDPAVGMD POWER		2: Power Avg		
NUMERIC	FDPAVGMD NUMERIC		3: Numeric		

*1: Average Mode is set to POWER AVG.

4.2 GPIB Command Codes

Table 4-12 TRANSIENT Key (21 of 56)

Function	Listener Code	Talker Request		Remarks
		Code	Output Format	
F-Domain Power	Parameter Setup			
	Detector			
	Normal	FDPDET NRM	FDPDET?	0: Normal
	Posi	FDPDET POS		1: Posi
	Nega	FDPDET NEG		2: Nega
	Sample	FDPDET SMP		3: Sample
	Display Unit			
	dBm	FDPUNIT DBM	FDPUNIT?	0: dBm
	W	FDPUNIT W		1: W
	dBμV	FDPUNIT DBUV		2: dBμV
	Judgment			
	ON	FDPJDG ON	FDPJDG?	0: OFF
	OFF	FDPJDG OFF		1: ON
Upper Limit	FDPJDGUP *	FDPJDGUP?	Level (dBm/W/dBμV)	
Lower Limit	FDPJDGLOW *	FDPJDGLOW?	Level (dBm/W/dBμV)	
Set to STD	FDPSETSTD			
Starts measurement				
F-Domain Power	FDPMEAS			
Starts measurement in the same mode	SI			
Measurement results				
F-Domain Power		FDPMEAS?	l1, j1 l1: Level (dBm/W/dBμV) j1: Integer (0: FAIL, 1: PASS, -1: Judgment OFF)	

Table 4-12 TRANSIENT Key (22 of 56)

Function	Listener Code	Talker Request		Remarks
		Code	Output Format	
OBW	Auto Level Set	OBWAUTOLVL		
	OBW%	OBWPER *	OBWPER?	Real Number (0.5 to 99.5)
	Average Times	OBWAVGCNT * OBWAVG *	OBWAVGCNT? OBWAVG?	Integer (1:OFF, 2 to 999) Integer (1:OFF, 2 to 999)
	Average Mode TRACE AVG MAX HOLD POWER AVG NUMERIC	OBWAVGMD TRACE OBWAVGMD MAX OBWAVGMD POWER OBWAVGMD NUMERIC	OBWAVGMD?	0: Trace Avg 1: Max Hold 2: Power Avg 3: Numeric
	Parameter Setup Detector Normal Posi Nega Sample	OBWDET NRM OBWDET POS OBWDET NEG OBWDET SMP	OBWDET?	0: Normal 1: Pos 2: Nega 3: Sample
	Judgment ON OFF Upper Limit Lower Limit Set to STD	OBWJDG ON OBWJDG OFF OBWJDGUP * OBWJDGLOW * OBWSETSTD	OBWJDG? OBWJDGUP? OBWJDGLOW?	0: OFF 1: ON Frequency Frequency
	Starts measurement OBW Starts measurement in the same mode	OBWMEAS SI		

*1: When Detector is set to Positive, Average Mode is set to MAX HOLD. When Detector is set to something other than Positive, Average Mode is set to TRACE AVG.

4.2 GPIB Command Codes

Table 4-12 TRANSIENT Key (23 of 56)

Function		Listener Code	Talker Request		Remarks
			Code	Output Format	
OBW	Measurement results OBW		OBWMEAS?	f1, f2, f3, j1 f1: OBW Frequency f2: Lower side Frequency f3: Higher side Frequency j1: Integer (0: FAIL, 1: PASS, -1: Judgment OFF)	
Due to Transient	Auto Level Set	DTSAUTOLVL			
	Template				
	Template				
	ON	DTSTMPL ON	DTSTMPL?	0: OFF	
	OFF	DTSTMPL OFF		1: ON	
	Template Shift				
	Shift X	DTSTMPLSX *	DTSTMPLSX?	Frequency	
	Shift Y	DTSTMPLSY *	DTSTMPLSY?	Level	
	Margin delta X	DTSTMPLDX *	DTSTMPLDX?	Frequency (0: OFF)	
	Copy from STD	DTSTMPLCP			
	Data Input	DTSTMPLD *,*		f1, l1 f1: Frequency l1: Level (dBm/W/dBμV)	
Init Table	DTSTMPLCLR				
Marker Edit					
Copy from STD	DTSMKRCP				
Data Input	DTSMKRED *,*,*,*		d1, f1, f2, l1 d1: (0: Normal, 1: Integral, 2:√Nyquist) f1: Offset frequency f2: Bandwidth l1: Limit Level	Set the reference bandwidth to f2, after initializing the table.	
Init Table	DTSMKRCLR				

Table 4-12 TRANSIENT Key (24 of 56)

Function	Listener Code	Talker Request		Remarks	
		Code	Output Format		
Due to Transient	Average Times	DTSAVGCNT *	DTSAVGCNT?	Integer (1: OFF, 2 to 999)	*1
		D TSAVG *	D TSAVG?	Integer (1: OFF, 2 to 999)	
	Average Mode				
	TRACE AVG	D TSAVGMD TRACE	D TSAVGMD?	0: Trace Avg	
	MAX HOLD	D TSAVGMD MAX		1: Max Hold	
	POWER AVG	D TSAVGMD POWER		2: Power Avg	
	NUMERIC	D TSAVGMD NUMERIC		3: Numeric	
	Parameter Setup				
	Detector				
	Normal	D TSDET NRM	D TSDET?	0: Normal	
Posi	D TSDET POS		1: Posi		
Nega	D TSDET NEG		2: Nega		
Sample	D TSDET SMP		3: Sample		
Display Unit					
dBm	D TSUNIT DBM	D TSUNIT?	0: dBm		
W	D TSUNIT W		1: W		
dB μ V	D TSUNIT DB μ V		2: dB μ V		
Template Couple to Power					
ON	D TSTMPLPW ON	D TSTMPLPW?	0: OFF		
OFF	D TSTMPLPW OFF		1: ON		
Template Limit	D TSTMPLBTM *	D TSTMPLBTM?	Level (dBm/W/dB μ V)		
Judgment					
ON	D TSJDG ON	D TSJDG?	0: OFF		
OFF	D TSJDG OFF		1: ON		
Freq. Setting					
CFSP	D TSFRMD CFSP	D TSFRMD?	0: Center/Span Mode		
STSP	D TSFRMD STSP		1: Start/Stop Mode		

*1: When Detector is set to Positive, Average Mode is set to MAX HOLD. When Detector is set to something other than Positive, Average Mode is set to TRACE AVG.

4.2 GPIB Command Codes

Table 4-12 TRANSIENT Key (25 of 56)

Function	Listener Code	Talker Request		Remarks
		Code	Output Format	
Due to Transient	Result Type			
	ABS	DTSRES ABS	DTSRES?	0: Absolute
	REL	DTSRES REL		1: Relative
	MKR	DTSRES MKR		2: Marker
	Reference Power			
	MKR	DTSREF MKR	DTSREF?	0: Reference Marker
	MOD	DTSREF MOD		1: Modulation
Symbol Rate 1/T	DTSSYMRT *	DTSSYMRT?	Frequency	
Rolloff Factor	DTSRFACT *	DTSRFACT?	Real Number	
Set to STD	DTSETSTD			(GSM only)
Starts measurement				
Due to Transient	DTSMEAS DUESWT			
Starts measurement in the same mode	SI			
Measurement results				
Due to Transient		DTSMEAS? DUESWT?	n<CR+LF>+d1,j1 <CR+LF> +dn,jn<CR+LF> n: Amount (Integer) dn: Power jn: Integer (0: FAIL, 1: PASS, -1: Judgment OFF)	

Table 4-12 TRANSIENT Key (26 of 56)

Function	Listener Code	Talker Request		Remarks
		Code	Output Format	
Due to Modulation	Auto Level Set	DTMAUTOLVL		
	Gate Setup			
	ON	TGTSETUP ON	TGTSETUP?	0: OFF
	OFF	TGTSETUP OFF		1: ON
	Trigger Source			
	FREE RUN	TGTTRG FREE	TGTTRG?	0: FREERUN
	VIDEO	TGTTRG VIDEO		1: VIDEO
	IF	TGTTRG IF		2: IF
	EXT	TGTTRG EXT		3: EXT
	Trigger Slope			
	-	TGTTRGSLP FALL	TGTTRGSLP?	0: -
	+	TGTTRGSLP RISE		1: +
	Trigger Level	TGTTRGLVL *	TGTTRGLVL?	Integer (0 to 100)
	Trigger Position	TGTTRGPOS *	TGTTRGPOS?	Integer (0 to 100)
	Trigger Delay	TGTTRGDT *	TGTTRGDT?	Time
	Gate Source			
	Trigger	TGTSRC TRG	TGTSRC?	0: Trigger
	Ext Gate	TGTSRC EXT		1: EXT
	Gate Position	TGTPOS *	TGTPOS?	Time
	Gate Width	TGTWID *	TGTWID?	Time
Detector				
Normal	TGTDET NRM	TGTDET?	0: Normal	
Posi	TGTDET POS		1: Posi	
Nega	TGTDET NEG		2: Nega	
Sample	TGTDET SMP		3: Sample	
Gated Sweep ON/OFF				
ON	TGTSWP ON	TGTSWP?	0: OFF	
OFF	TGTSWP OFF		1: ON	

4.2 GPIB Command Codes

Table 4-12 TRANSIENT Key (27 of 56)

Function	Listener Code	Talker Request		Remarks
		Code	Output Format	
Due to Modulation	Template			
	Template			
	ON	DTMTMPL ON	DTMTMPL?	0: OFF
	OFF	DTMTMPL OFF		1: ON
	Template Shift			
	Shift X	DTMTMPLSX *	DTMTMPLSX?	Frequency
	Shift Y	DTMTMPLSY *	DTMTMPLSY?	Level
	Margin delta X	DTMTMPLDX * LIMMRG *	DTMTMPLDX? LIMMRG?	Frequency (0: OFF)
	Copy from STD	DTMTMPLCP		
	Data Input	DTMTMPLED *,*		f1, l1 f1: Frequency l1: Level (dBm/W/dBμV)
	Init Table	DTMTMPLCLR		
	Marker Edit			
	Copy from STD	DTMMKRCP		
Data Input	DTMMKRED *,*,*,*		d1, f1, f2, l1 d1: (0:Normal, 1: Integral, 2:√Nyquist) f1: Offset Frequency f2: Bandwidth l1: Limit Level	
Init Table	DTMMKRCLR			

Set the reference bandwidth to f2, after initializing the table.

Table 4-12 TRANSIENT Key (28 of 56)

Function	Listener Code	Talker Request		Remarks	
		Code	Output Format		
Due to Modulation	Average Times	DTMAVGCNT *	DTMAVGCNT?	Integer (1: OFF, 2 to 999)	*1
		DTMAVG *	DTMAVG?	Integer (1: OFF, 2 to 999)	
	Average Mode				
	TRACE AVG	DTMAVGMD TRACE	DTMAVGMD?	0: Trace Avg	
	MAX HOLD	DTMAVGMD MAX		1: Max Hold	
	POWER AVG	DTMAVGMD POWER		2: Power Avg	
	NUMERIC	DTMAVGMD NUMERIC		3: Numeric	
	Parameter Setup				
	Detector				
	Normal	DTMDET NRM	DTMDET?	0: Normal	
Posi	DTMDET POS		1: Posi		
Nega	DTMDET NEG		2: Nega		
Sample	DTMDET SMP		3: Sample		
Display Unit					
dBm	DTMUNIT DBM	DTMUNIT?	0: dBm		
W	DTMUNIT W		1: W		
dB μ V	DTMUNIT DBUV		2: dB μ V		
Template Couple to Power					
ON	DTMTMPLPW ON	DTMTMPLPW?	0: OFF		
OFF	DTMTMPLPW OFF		1: ON		
Template Limit	DTMTMPLBTM *	DTMTMPL-BTM?	Level (dBm/W/dB μ V)		
Judgment					
ON	DTMJDG ON	DTMJDG?	0: OFF		
OFF	DTMJDG OFF		1: ON		
Freq. Setting					
CFSP	DTMFRMD CFSP	DTMFRMD?	0: Center/Span Mode		
STSP	DTMFRMD STSP		1: Start/Stop Mode		

*1: When Detector is set to Positive, Average Mode is set to MAX HOLD. When Detector is set to something other than Positive, Average Mode is set to TRACE AVG.

4.2 GPIB Command Codes

Table 4-12 TRANSIENT Key (29 of 56)

Function	Listener Code	Talker Request		Remarks
		Code	Output Format	
Due to Modulation	Result Type			
	ABS	DTMRES ABS	DTMRES?	0: Absolute
	REL	DTMRES REL		1: Relative
	MKR	DTMRES MKR		2: Marker
	Reference Power			
	MKR	DTMREF MKR	DTMREF?	0: Reference Marker
	MOD	DTMREF MOD	REFPWR?	1: Modulation
	REFPWR SWP	REFPWR DSP		
	Symbol Rate 1/T	DTMSYMRT *	DTMSYMRT?	Frequency
	Rolloff Factor	DTMRFACT *	DTMRFACT?	Real Number
Set to STD	DTMSETSTD			
Start Measurement				
Due to Modulation	DTMMEAS DUEMOD			
Starts measurement in the same mode	SI			
Measurement results				
Due to Modulation		DTMMEAS? DUEMOD?	n<CR+LF>+d1, j1<CR+LF>+dn,jn<CR+LF> n: Amount (Integer) dn: Power jn: Integer(0: FAIL, 1: PASS, -1: Judgment OFF)	

Table 4-12 TRANSIENT Key (30 of 56)

Function		Listener Code	Talker Request		Remarks
			Code	Output Format	
Inband Spurious	Auto Level Set	SPRAUTOLVL			
	Template				
	Template				
	ON	SPRTMPL ON	SPRTMPL?	0: OFF	
	OFF	SPRTMPL OFF		1: ON	
	Template Shift				
	Shift X	SPRTMPLSX *	SPRTMPLSX?	Frequency	
	Shift Y	SPRTMPLSY *	SPRTMPLSY?	Level	
	Margin delta X	SPRTMPLDX *	SPRTMPLDX?	Frequency (0: OFF)	
	Copy from STD	SPRTMPLCP			
	Data Input	SPRTMPLED *,*		f1, l1 f1: Frequency l1: Level (dBm/W/dBμV)	
	Init Table	SPRTMPLCLR			
	Marker Edit				
	Copy from STD	SPRMKRCP			
	Data Input	SPRMKRED *,*,*,*		d1, f1, f2, l1 d1: (0: Peak, 1: Integral) f1: Start Frequency f2: Stop Frequency l1: Limit Level	Set the reference bandwidth to f2, after initializing the table.
Init Table	SPRMKRCLR				
Average Times	SPRAVGCNT *	SPRAVGCNT?	Integer (1: OFF, 2 to 999)		
	SPRAVG *	SPRAVG?	Integer (1: OFF, 2 to 999)	*1	
Average Mode					
TRACE AVG	SPRAVGMD TRACE	SPRAVGMD?	0: Trace Avg		
MAX HOLD	SPRAVGMD MAX		1: Max Hold		
POWER AVG	SPRAVGMD POWER		2: Power Avg		

*1: When Detector is set to Positive, Average Mode is set to MAX HOLD. When Detector is set to something other than Positive, Average Mode is set to TRACE AVG.

4.2 GPIB Command Codes

Table 4-12 TRANSIENT Key (31 of 56)

Function	Listener Code	Talker Request		Remarks
		Code	Output Format	
Inband Spurious	Parameter Setup			
	Detector			
	Normal	SPRDET NRM	SPRDET?	0: Normal
	Posi	SPRDET POS		1: Posi
	Nega	SPRDET NEG		2: Nega
	Sample	SPRDET SMP		3: Sample
	Display Unit			
	dBm	SPRUNIT DBM	SPRUNIT?	0: dBm
	W	SPRUNIT W		1: W
	dBμV	SPRUNIT DBUV		2: dBμV
	Template Couple to Power			
	ON	SPRTMPLPW ON	SPRTMPLPW?	0: OFF
	OFF	SPRTMPLPW OFF		1: ON
	Template Limit	SPRTMPLBTM *	SPRTMPLBTM?	Level (dBm/W/dBμV)
	Judgment			
ON	SPRJDG ON	SPRJDG?	0: OFF	
OFF	SPRJDG OFF		1: ON	
Freq. Setting				
CFSP	SPRFRMD CFSP	SPRFRMD?	0: Center/Span Mode	
STSP	SPRFRMD STSP		1: Start/Stop Mode	
Result Type				
ABS	SPRRES ABS	SPRRES?	0: Absolute	
REL	SPRRES REL		1: Relative	
MKR	SPRRES MKR		2: Marker	
Reference Power				
MKR	SPRREF MKR	SPRREF?	0: Reference Marker	
MOD	SPRREF MOD		1: Modulation	
Peak Marker Y-Delta	SPRPKMKY *	SPRPKMKY?	Real Number	
Set to STD	SPRSETSTD			

Table 4-12 TRANSIENT Key (32 of 56)

Function		Listener Code	Talker Request		Remarks
			Code	Output Format	
Inband Spurious	Starts measurement Inband Spurious	SPRMEAS			
	Starts measurement in the same mode	SI			
	Measurement results Inband Spurious		SPRMEAS?	n<CR+LF>+f1,l1,j1<CR+LF> +fn,ln,jn<CR+LF> n: Amount (Integer) fn: Frequency ln: Level (dBm/W/ dBμV) jn: Integer (0: FAIL, 1: PASS, -1: Judgment OFF)	
Outband Spurious	Auto Level Set	FDSAUTOLVL			
	Table				
	Copy from STD	FDSCP			
	Table No.1/2/3	FDSTBL *	FDSTBL?	Integer (1 to 3)	
	Table Edit	FDSTBLED *,*,*,*,*,*		f1, f2, f3, f4, d1, l1 f1: Start Frequency f2: Stop Frequency f3: RBW f4: VBW d1: Sweep Time l1: Limit Level	
	Load Table	FDSLDD			
	Save Table	FDSSV			
	Init Table	FDSCLR			
Average Times		FDSAVGCNT *	FDSAVGCNT?	Integer (1:OFF, 2 to 999)	
		FDSAVG *	FDSAVG?	Integer (1:OFF, 2 to 999)	*1

*1: When Detector is set to Positive, Average Mode is set to MAX HOLD. When Detector is set to something other than Positive, Average Mode is set to TRACE AVG.

4.2 GPIB Command Codes

Table 4-12 TRANSIENT Key (33 of 56)

Function	Listener Code	Talker Request		Remarks
		Code	Output Format	
Outband Spurious	Average Mode			
	TRACE AVG	FDSAVGMD TRACE	FDSAVGMD?	0: Trace Avg
	MAX HOLD	FDSAVGMD MAX		1: Max Hold
	POWER AVG	FDSAVGMD POWER		2: Power Avg
	Parameter Setup			
	Detector			
	Normal	FDSDET NRM	FDSDET?	0: Normal
	Posi	FDSDET POS		1: Posi
	Nega	FDSDET NEG		2: Nega
	Sample	FDSDET SMP		3: Sample
	Display Unit			
	dBm	FDSUNIT DBM	FDSUNIT?	0: dBm
	W	FDSUNIT W		1: W
	dBμV	FDSUNIT DBUV		2: dBμV
Judgment				
ON	FDSJDG ON	FDSJDG?	0: OFF	
OFF	FDSJDG OFF		1: ON	
Peak Marker Y-Delta	FDSPKMKY *	FDSPKMKY?	Real Number	
Preselector 1.6G	FDSPRE 16G	FDSPRE?	0: 1.6G	
3.6G	FDSPRE 36G		1: 3.6G	
Set to Default	FDSSETSTD			
Starts measurement				
Outband Spurious	FDSMEAS			
Starts measurement in the same mode	SI			

Table 4-12 TRANSIENT Key (34 of 56)

Function		Listener Code	Talker Request		Remarks
			Code	Output Format	
Outband Spurious	Measurement results Outband Spurious		FDSMEAS?	n<CR+LF>+f1,11,j 1<CR+LF> +fn,ln,jn<CR+LF> n: Amount (Integer) fn: Frequency ln: Level (dBm/W/dBμV) jn: Integer (0: FAIL, 1: PASS, -1: Judgment OFF)	
Tx Power (GSM)	Auto Level Set	AUTOLVL			
	Trigger Setup				
	Trigger Mode	MODTRG FREE	MODTRG?	0: FREERUN	
	FREERUN	TRGMODE FREE	TRGMODE?		
	IF	MODTRG IF		1: IF	
		TRGMODE IF			
	EXT	MODTRG EXT		2: EXT	
		TRGMODE EXT			
	EXT Trigger Slope				
	+	MODTRGSLP RISE	MODTRGSLP?	0: -	
		TRGMSLP RISE	TRGMSLP?		
	-	MODTRGSLP FALL		1: +	
		TRGMSLP FALL			
TDMA Structure					
156.25 bit	TRGSTR TYP1	TRGSTR?	0: 156.25 bit		
156/157 bit	TRGSTR TYP2		1: 156/157 bit		
EXT Trigger Delay					
Time Setting	MODTRGDLY *	MODTRGDLY?	Time		
Slot Setting	MODTRGSLT *	MODTRGSLT?	0 to 7		
IF Trigger Level	MODTRGLVL *	MODTRGLVL?	Integer (0 to 100)		
Burst Search					
Burst Search OFF	MODTRGBRST OFF	MODTRGBRST?	0: OFF		
Burst Search ON	MODTRGBRST ON		1: ON		
Search Level	MODBRSTLVL *	MODBRSTLVL?	Level		
Half Symbol Shift					
Half Symbol Shift ON	MODHSS ON	MODHSS?	0: OFF		
Half Symbol Shift OFF	MODHSS OFF		1: ON		

4.2 GPIB Command Codes

Table 4-12 TRANSIENT Key (35 of 56)

Function		Listener Code	Talker Request		Remarks
			Code	Output Format	
Tx Power (GSM)	Average Times	TXAVG *	TXAVG?	Integer (1: OFF, 2 to 32)	
		TAVGTX *	TAVGTX?		
		TAVGAP *	TAVGAP?		
	Starts measurement Tx Power	TXPWR			
	Starts measurement in the same mode	SI			
	Measurement results Tx Power	Modulation:For GMSK	TXPWR?	d1, d2 d1: Tx Power(dBm) d2: Tx Power(W)	
		Modulation:For 3PI/8 Shift 8PSK	TXPWR?	d1,d2,d3 d1: Tx Power(dB) d2: Tx Power(W) d3: Peak Factor(dB)	

Table 4-12 TRANSIENT Key (36 of 56)

Function	Listener Code	Talker Request		Remarks
		Code	Output Format	
Power vs. Time (GSM)	Auto Level Set	AUTOLVL		
	Trigger Setup			
	Trigger Mode			
	FREERUN	MODTRG FREE TRGMODE FREE	MODTRG? TRGMODE?	0: FREERUN
	IF	MODTRG IF TRGMODE IF		1: IF
	EXT	MODTRG EXT TRGMODE EXT		2: EXT
	EXT Trigger Slope			
	+	MODTRGSLP RISE TRGMSLP RISE	MODTRGSLP? TRGMSLP?	0: - 1: +
	-	MODTRGSLP FALL TRGMSLP FALL		
	TDMA Structure			
	156.25 bit	TRGSTR TYP1	TRGSTR?	0: 156.25 bit
	156/157 bit	TRGSTR TYP2		1: 156/157 bit
	EXT Trigger Delay			
	Time Setting	MODTRGDLY *	MODTRGDLY?	Time
	Slot Setting	MODTRGSLT *	MODTRGSLT?	0 to 7
IF Trigger Level	MODTRGLVL *	MODTRGLVL?	Integer (%)	
Burst Search				
Burst Search OFF	MODTRGBRST OFF	MODTRGBRST?	0: OFF	
Burst Search ON	MODTRGBRST ON		1: ON	
Search Level	MODBRSTLVL *	MODBRSTLVL?	Level	
Half Symbol Shift				
Half Symbol Shift ON	MODHSS ON	MODHSS?	0: OFF	
Half Symbol Shift OFF	MODHSS OFF		1: ON	
Consecutive Template				
Consecutive Template ON	PTCONSTM ON	PTCONSTM?	0: OFF	
Consecutive Template OFF	PTCONSTM OFF		1: ON	
Max dB+	PTMAXDB *	PTMAXDB?	Level	
Slot Length				
Slot Length 156	PTSLTLEN 156	PTSLTLEN?	0:156	
Slot Length 156.25	PTSLTLEN 15625		1:156.25	
Slot Length 157	PTSLTLEN 157		2:157	

4.2 GPIB Command Codes

Table 4-12 TRANSIENT Key (37 of 56)

Function	Listener Code	Talker Request		Remarks	
		Code	Output Format		
Power vs. Time (GSM)	Average Times	GPTAVG * PTAVG *	GPTAVG? PTAVG?	Integer (1: OFF, 2 to 32)	
	Measurement Mode				
	Normal	PTMOD NORM	PTMOD?	0: NORM	
	High dynamic range	PTMOD HIGH		1: HIGH	
	Y Scale				
	20dB/div	GPTDIV P20DB PTDIV P20DB	GPTDIV? PTDIV?	0: 20dB/div 1: 10dB/div	
	10dB/div	GPTDIV P10DB PTDIV P10DB		2: 5dB/div	
	5dB/div	GPTDIV P5DB PTDIV P5DB			
	Template				
	Template Select	GPTTYP * PTTYP *	GPTTYP? PTTYP?	Integer (Template No.: 1, 2, 3, 4) 1: MS Template 2: BTS Template 1	
Template Edit	GPTENT d0,d1,d2,d3,d4,d5,d6 PTENT d0,d1,d2,d3,d4,d5,d6		d0 to d6: Level(dB) (OffLev Unit is set to DB.)	If the number of data is less than 7, enter a 0 in each position.	
	GPTENT2 d0,d1,d2,d3,d4,d5,d6,d7 PTENT2 d0,d1,d2,d3,d4,d5,d6,d7		d0 to d7: Level(dB) (OffLev Unit is set to DB.)	If the number of data is less than 8, enter a 0 in each position.	
Level Edit					
#0	GPTLV0 *	GPTLV0?	Level		
#1	GPTLV1 *	GPTLV1?	Level		
#2	GPTLV2 *	GPTLV2?	Level		
#3	GPTLV3 *	GPTLV3?	Level		
#4	GPTLV4 *	GPTLV4?	Level		
#5	GPTLV5 *	GPTLV5?	Level		
#6	GPTLV6 *	GPTLV6?	Level		
#1'	GPTLV7 *	GPTLV7?	Level		

Table 4-12 TRANSIENT Key (38 of 56)

Function	Listener Code	Talker Request		Remarks	
		Code	Output Format		
Power vs. Time (GSM)	OffLev Unit Edit				
	#0 dBm	GPTUNIT0 DBM	GPTUNIT0?	0: dBm 1: dB	
	dB	GPTUNIT0 DB			
	#1 dBm	GPTUNIT1 DBM	GPTUNIT1?	0: dBm 1: dB	
	dB	GPTUNIT1 DB			
	#2 dBm	GPTUNIT2 DBM	GPTUNIT2?	0: dBm 1: dB	
	dB	GPTUNIT2 DB			
	#3 dBm	GPTUNIT3 DBM	GPTUNIT3?	0: dBm 1: dB	
	dB	GPTUNIT3 DB			
	#4 dBm	GPTUNIT4 DBM	GPTUNIT4?	0: dBm 1: dB	
	dB	GPTUNIT4 DB			
	#5 dBm	GPTUNIT5 DBM	GPTUNIT5?	0: dBm 1: dB	
	dB	GPTUNIT5 DB			
	#6 dBm	GPTUNIT6 DBM	GPTUNIT6?	0: dBm 1: dB	
	dB	GPTUNIT6 DB			
	#1' dBm	GPTUNIT7 DBM	GPTUNIT7?	0: dBm 1: dB	
	dB	GPTUNIT7 DB			
	Time Edit				
	#0	GPTTM0 *	GPTTM0?	Time	
	#1	GPTTM1 *	GPTTM1?	Time	
	#2	GPTTM2 *	GPTTM2?	Time	
	#3	GPTTM3 *	GPTTM3?	Time	
	#4	GPTTM4 *	GPTTM4?	Time	
	#0'	GPTTM5 *	GPTTM5?	Time	
	Entering a set of levels	GPTLVENT d0,u0,d1,u1,d2,u2, d3,u3,d4,u4,d5,u5,d6,u6		d0 to d6: Level(dB) (DB is the unit of lev- els) u0 to u6: (0: dBm 1: dB)	If the number of data is less than 7, enter a 0 in each position.
		GPTLVENT2 d0,u0,d1,u1,d2,u2,d3,u3, d4,u4,d5,u5,d6,u6,d7,u7		d0 to d7: Level(dB) (DB is the unit of lev- els) u0 to u7: (0: dBm 1: dB)	If the number of data is less than 8, enter a 0 in each position.

4.2 GPIB Command Codes

Table 4-12 TRANSIENT Key (39 of 56)

Function		Listener Code	Talker Request		Remarks
			Code	Output Format	
Power vs. Time (GSM)	Entering a set of times	GPTTMENT t0,t1,t2,t3,t4		t0 to t4: Time	If the number of data is less than 5, enter a 0 in each position.
		GPTTMENT2 t0,t1,t2,t3,t4,t5		t0 to t5: Time	If the number of data is less than 6, enter a 0 in each position.
Average Times		GPTAVG * PTAVG *	GPTAVG? PTAVG?	Integer (1: OFF, 2 to 32)	
Starts measurement Power vs. Time		GPWRM PWRM			
Starts measurement in the same mode		SI			
Measurement results Power vs. Time			GPWRM? PWRM? GPWRM2? PWRM2?	Level (dBm) Level (dBm) d1,d2,d3 d1: Tx Power1 (dBm) d2: Tx Power2 (dBm) d3: Δ Power (dB)	
PASS/FAIL			GPTJDG? PTJDG?	0/1 0: FAIL 1: PASS	

Table 4-12 TRANSIENT Key (40 of 56)

Function	Listener Code	Talker Request		Remarks
		Code	Output Format	
Phase Error (GSM)	Auto Level Set	AUTOLVL		
	Trigger Setup			
	Trigger Mode			
	FREERUN	MODTRG FREE TRGMODE FREE	MODTRG? TRGMODE?	0: FREERUN
	IF	MODTRG IF TRGMODE IF		1: IF
	EXT	MODTRG EXT TRGMODE EXT		2: EXT
	EXT Trigger Slope			
	+	MODTRGSLP RISE TRGMSLP RISE	MODTRGSLP? TRGMSLP?	0: -
	-	MODTRGSLP FALL TRGMSLP FALL		1: +
	TDMA Structure			
	156.25 bit	TRGSTR TYP1	TRGSTR?	0: 156.25 bit
	156/157 bit	TRGSTR TYP2		1: 156/157 bit
	EXT Trigger Delay			
	Time Setting	MODTRGDLY *	MODTRGDLY?	Time
	Slot Setting	MODTRGSLT *	MODTRGSLT?	0 to 7
IF Trigger Level	MODTRGLVL *	MODTRGLVL?	Integer (0 to 100)	
Burst Search				
Burst Search OFF	MODTRGBRST OFF	MODTRGBRST?	0: OFF	
Burst Search ON	MODTRGBRST ON		1: ON	
Search Level	MODBRSTLVL *	MODBRSTLVL?	Level	
Half Symbol Shift				
Half Symbol Shift ON	MODHSS ON	MODHSS?	0:OFF	
Half Symbol Shift OFF	MODHSS OFF		1:ON	
Average Times	TAVGPH *	TAVGPH?	Integer (1: OFF, 2 to 200)	

4.2 GPIB Command Codes

Table 4-12 TRANSIENT Key (41 of 56)

Function		Listener Code	Talker Request		Remarks
			Code	Output Format	
Phase Error (GSM)	Starts measurement				
	Phase Error	PHACC			
	Starts measurement in the same mode	SI			
	Measurement results				
	Phase Error		PHACC?	Pk, Ph, Fr Pk: Phase (degree) Ph: Phase (degree rms) Fr: Frequency(Hz)	
			PHACC2?	Ph, Pk, Bit, Fr Ph: Phase (degree rms) Pk: Phase (degree) Bit: Peak Phase error position (bit) Fr: Frequency (Hz)	

Table 4-12 TRANSIENT Key (42 of 56)

Function	Listener Code	Talker Request		Remarks
		Code	Output Format	
Modulatin Accuracy (GSM)	Auto Level Set	AUTOLVL		
	Trigger Setup			
	Trigger Mode			
	FREERUN	MODTRG FREE TRGMODE FREE	MODTRG? TRGMODE?	0: FREERUN
	IF	MODTRG IF TRGMODE IF		1: IF
	EXT	MODTRG EXT TRGMODE EXT		2: EXT
	EXT Trigger Slope			
	+	MODTRGSLP RISE TRGMSLP RISE	MODTRGSLP? TRGMSLP?	0: - 1: +
	-	MODTRGSLP FALL TRGMSLP FALL		
	TDMA Structure			
	156.25 bit	TRGSTR TYP1	TRGSTR?	0: 156.25 bit
	156/157 bit	TRGSTR TYP2		1: 156/157 bit
	EXT Trigger Delay			
	Time Setting	MODTRGDLY *	MODTRGDLY?	Time
Slot Setting	MODTRGSLT *	MODTRGSLT?	0 to 7	
IF Trigger Level	MODTRGLVL *	MODTRGLVL?	Integer(%)	
Burst Search				
Burst Search OFF	MODTRGBRST OFF	MODTRGBRST?	0: OFF	
Burst Search ON	MODTRGBRST ON		1: ON	
Search Level	MODBRSTLVL	MODBRSTLVL?	Level	
R.C. Filter				
R.C. Filter ON	MODRCFLT ON MODRNYQ ON	MODRCFLT? MODRNYQ?	0: OFF 1: ON	
R.C. Filter OFF	MODRCFLT OFF MODRNYQ OFF			

4.2 GPIB Command Codes

Table 4-12 TRANSIENT Key (43 of 56)

Function		Listener Code	Talker Request		Remarks
			Code	Output Format	
Modulation Accuracy (GSM)	Average Times	TAVGMOD *	TAVGMOD?	Integer(1:OFF,2 to 200)	
	Starts measurement				
	Modulation Accuracy	MODACC			
	Starts measurement in the same mode	SI			
	Measurement results				
	Modulation accuracy (1 symbol)		MODACC?	d1,d2,d3,d4,d5,d6,d7,d8 d1:Burst Amplitude Droop(dB/symbol) d2:Carrier Frequency Error(Hz) d3:I/Q origin off-set(dBc) d4:Magnitude Error(% rms) d5:Phase Error(deg. rms) d6:Error Vector Magnitude(% rms) d7:95:th percentile(%) d8:Peak EVM(Avg) (% rms)	
	Modulation accuracy(Peak)		MODAC-CPK?	d1 ,s1,d2,s2,d3,s3 d1: Peak Magnitude Error(%rms) s1: Position of Peak Mag. Error d2: Peak Phase Error(deg.rms) s2: Position of Peak Phase Error d3: Peak E.V.M(%rms) s3: Position of Peak E.V.M	

Table 4-12 TRANSIENT Key (44 of 56)

Function		Listener Code	Talker Request		Remarks
			Code	Output Format	
Graphics Selection Phase Error	Constellation	GGPTYP INP	GGPTYP?	0: Constellation	
	Constellation(Line)	GGPTYP LIN		1: Constellation(Line)	
	Constellation(Dot)	GGPTYP DOT		2: Constellation(Dot)	
	Constellation(Line&Dot)	GGPTYP CON		3: Constellation(Line&Dot)	
	I EYE Diagram	GGPTYP IEYE		4: I EYE Diagram	
	Q EYE Diagram	GGPTYP QEYE		5: Q EYE Diagram	
	I/Q EYE Diagram	GGPTYP IQEYE		6: I/Q EYE Diagram	
	Trellis	GGPTYP TR		7: Trellis	
	Phase Error vs Bit	GGPTYP PE		8: Phase Error vs Bit	
	FFT of Phase Error	GGPTYP FPE		9: FFT of Phase Error	
	Frequency vs Bit	GGPTYP BF		10: Frequency vs Bit	
	Frequency EYE	GGPTYP FREYE		11: Frequency EYE	
Demodulated Data	GGPTYP DE	12: Demodulated Data			
Data Output					
Constellation	I-channel data output	GPHI?		n<CR+LF>+d1<CR+LF> +.....+dn<CR+LF>	
Constellation(Line)				n: Number of output dn: Data (Real Number)	
Constellation(Dot)					
Constellation(Line&Dot)	Q-channel data output	GPHQ?		n<CR+LF>+d1<CR+LF> +.....+dn<CR+LF>	
I EYE Diagram				n: Number of output	
Q EYE Diagram				dn: Data (Real Number)	
I/Q EYE Diagram					

4.2 GPIB Command Codes

Table 4-12 TRANSIENT Key (45 of 56)

Function		Listener Code	Talker Request		Remarks
			Code	Output Format	
Demodulated Data	Demodulated data output		DEMOMD?	n<CR+LF>+d1\$<CR+LF> +....+dn\$<CR+LF> n: Number of output character string data dn\$: Character string data (1 Data: 10 bit)	
Trellis Phase Error vs Bit Frequency vs Bit Frequency EYE	X data		GPHX?	n<CR+LF>+d1<CR+LF>++dn<CR+LF> n: Number of output dn: Data (Integer)	
	Y data		GPHY?	n<CR+LF>+d1<CR+LF>++dn<CR+LF> n: Number of output dn: Data (Real Number)	
FFT of Phase Error	X data		GPHX?	n<CR+LF>+d1<CR+LF>++dn<CR+LF> n: Number of output dn: Data (Real Number)	
	Y data		GPHY?	n<CR+LF>+d1<CR+LF>++dn<CR+LF> n: Number of output dn: Data (Real Number)	

Table 4-12 TRANSIENT Key (46 of 56)

Function		Listener Code	Talker Request		Remarks
			Code	Output Format	
Graphics Selection Modulation Accuracy	Constellation	EGPTYP INP	EGPTYP?	0: Constellation	
	Constellation(Line)	EGPTYP LIN		1: Constellation(Line)	
	Constellation(Dot)	EGPTYP DOT		2: Constellation(Dot)	
	Constellation(Line&Dot)	EGPTYP CON		3: Constellation(Line&Dot)	
	I EYE Diagram	EGPTYP IEYE		4: I EYE Diagram	
	Q EYE Diagram	EGPTYP QEYE		5: Q EYE Diagram	
	I/Q EYE Diagram	EGPTYP IQEYE		6: I/Q EYE Diagram	
	Demodulated Data	EGPTYP DEMOD		7: Demodulated Data	
	E.V.M. vs. Symbol	EGPTYP EVM		8: E.V.M. vs. Symbol	
	Mag. Error vs. Symbol	EGPTYP ME		9: Mag. Error vs. Symbol	
	Phase Error vs. Symbol	EGPTYP PFE		10: Phase Error vs. Symbol	
	8PSK Constellation	EGPTYP 8INP		11: 8PSK Constellation	
	8PSK Constellation(Line)	EGPTYP 8LIN		12: 8PSK Constellation(Line)	
	8PSK Constellation(Dot)	EGPTYP 8DOT		13: 8PSK Constellation(Dot)	
	8PSK Constellation(Line&Dot)	EGPTYP 8CON		14: 8PSK Constellation(Line&Dot)	
	8PSK I EYE Diagram	EGPTYP 8IEYE		15: 8PSK I EYE Diagram	
	8PSK Q EYE Diagram	EGPTYP 8QEYE		16: 8PSK Q EYE Diagram	
8PSK I/Q EYE Diagram	EGPTYP 8IQEYE		17: 8PSK I/Q EYE Diagram		

4.2 GPIB Command Codes

Table 4-12 TRANSIENT Key (47 of 56)

Function		Listener Code	Talker Request		Remarks
			Code	Output Format	
Data Output					
Constellation	I-channel data output		EGPHI?	n<CR+LF>+d1<CR+LF>++dn<CR+LF>	
Constellation (Line)				n: Number of output	
Constellation (Dot)				dn: Data (Real Number)	
Constellation (Line&Dot)					
I EYE Diagram	Q-channel data output		EGPHQ?	n<CR+LF>+d1<CR+LF>++dn<CR+LF>	
Q EYE Diagram				n: Number of output	
I/Q EYE Diagram				dn: Data (Real Number)	
Demodulated Data	Demodulated data output		EDEM0D?	n<CR+LF>+d1\$<CR+LF>++dn\$<CR+LF>	
				n: Number of output character string data	
				dn\$: Character string data (1 Data: 10 bit)	
E.V.M. vs. Symbol	X data(Symbol Number)		EGPHX?	n<CR+LF>+d1<CR+LF>++dn<CR+LF>	
Mag. Error vs. Symbol				n: Number of output	
Phase Error vs. Symbol				dn: Data (Integer)	
	Y data		EGPHY?	n<CR+LF>+d1<CR+LF>++dn<CR+LF>	
				n: Number of output	
				dn: Data (Real Number)	

Table 4-12 TRANSIENT Key (48 of 56)

Function	Listener Code	Talker Request		Remarks
		Code	Output Format	
Freq Deviation (DECT)	Auto Level Set	AUTOLVL		
	Trigger Setup			
	Trigger Mode			
	FREERUN	MODTRG FREE DCAPTRG FREE	MODTRG? DCAPTRG?	0: FREERUN
	IF	MODTRG IF DCAPTRG IF		1: IF
	EXT	MODTRG EXT DCAPTRG EXT		2: EXT
	Burst Search			
	Burst Search OFF	MODTRGBRST OFF	MODTRGBRST?	0: OFF
	Burst Search ON	MODTRGBRST ON		1: ON
	EXT Trigger Slope			
	+	MODTRGSLP RISE DTRGSLP RISE	MODTRGSLP? DTRGSLP?	0: - 1: +
	-	MODTRGSLP FALL DTRGSLP FALL		
	Slot No.			
	Full Slot Number	FULSLT *	FULSLT?	Integer (0 to 23)
	Half Slot Number	HAFSLT *	HAFSLT?	Integer (0 to 1)
EXT Trigger Delay				
Time Setting	MODTRGDLY *	MODTRGDLY?	Time	
IF Trigger Level	MODTRGLVL *	MODTRGLVL?	Integer (0 to 100)	
Bit Sequence				
RANDOM	DFMBITSEQ RND	DFMBITSEQ?	0: RANDOM	
STD	DFMBITSEQ STD		1: STD	
Average Times	DFMAVG *	DFMAVG?	Integer (1: OFF, 2 to 32)	
Starts measurement				
Freq Deviation	DFMDEV			
Starts measurement in the same mode	SI			

4.2 GPIB Command Codes

Table 4-12 TRANSIENT Key (49 of 56)

Function		Listener Code	Talker Request		Remarks
			Code	Output Format	
Freq Deviation (DECT)	Measurement results				
	<p>Freq Deviation</p> <p>When Bit Sequence is using a RANDOM pattern.</p> <p>When Bit Sequence is set the STD pattern.</p>		DFMDEV?	Pk1, Pk2, Fr Pk1: Max. Peak Devi.(Hz) Pk2: Min. Peak Devi.(Hz) Fr: Frequency Error (Hz)	
			DFMDEVSTD ?	Pk1, Pk2, Pk3, Pk4, Fr Pk1: Sync Field Max. Peak Devi.(Hz) Pk2: Sync Field Min. Peak Devi.(Hz) Pk3: Loopback Field Max. Peak Devi.(Hz) Pk4: Loopback Field Min. Peak Devi.(Hz) Fr: Frequency Error (Hz)	

Table 4-12 TRANSIENT Key (50 of 56)

Function	Listener Code	Talker Request		Remarks
		Code	Output Format	
Timing Jitter (DECT)	Auto Level Set	AUTOLVL		
	RFP→PP			
	ON	DTJLNK ON	DTJLNK?	0: OFF
	OFF	DTJLNK OFF		1: ON
	Trigger Setup			
	Trigger Mode			
	FREERUN	MODTRG FREE DCAPTRG FREE	MODTRG? DCAPTRG?	0: FREERUN
	IF	MODTRG IF DCAPTRG IF		1: IF
	EXT	MODTRG EXT DCAPTRG EXT		2: EXT
	Burst Search			
	Burst Search ON	MODTRGBRST ON	MODTRGBRST?	0: OFF
	Burst Search OFF	MODTRGBRST OFF		1: ON
	EXT Trigger Slope			
+	MODTRGSLP RISE DTRGSLP RISE	MODTRGSLP? DTRGSLP?	0: - 1: +	
-	MODTRGSLP FALL DTRGSLP FALL			
Slot No.				
Full Slot Number	FULSLT *	FULSLT?	Integer (0 to 23)	
Half Slot Number	HAFSLT *	HAFSLT?	Integer (0 to 1)	
EXT Trigger Delay				
Time Setting	MODTRGDLY *	MODTRGDLY?	Time	
IF Trigger Level	MODTRGLVL *	MODTRGLVL?	Integer (0 to 100)	
Average Times	DTJAVG *	DTJAVG?	Integer (1: OFF, 2 to 32)	

4.2 GPIB Command Codes

Table 4-12 TRANSIENT Key (51 of 56)

Function		Listener Code	Talker Request		Remarks
			Code	Output Format	
Timing Jitter (DECT)	Starts measurement				
	Timing Jitter	DTJIT			
	Starts measurement in the same mode	SI			
	Measurement results				
	Timing Jitter		DTJIT?	d1, d2, d3 d1: Max. Peak Jitter(sec) d2: Min. Peak Jitter(sec) d3: Average Jitter(sec)	

Table 4-12 TRANSIENT Key (52 of 56)

Function	Listener Code	Talker Request		Remarks
		Code	Output Format	
Tx Power (DECT)	Auto Level Set	AUTOLVL		
	Trigger Setup			
	Trigger Mode			
	FREERUN	MODTRG FREE DCAPTRG FREE	MODTRG? DCAPTRG?	0: FREERUN
	IF	MODTRG IF DCAPTRG IF		1: IF
	EXT	MODTRG EXT DCAPTRG EXT		2: EXT
	Burst Search			
	Burst Search OFF	MODTRGBRST OFF	MODTRGBRST?	0: OFF
	Burst Search ON	MODTRGBRST ON		1: ON
	EXT Trigger Slope			
	+	MODTRGSLP RISE DTRGSLP RISE	MODTRGSLP? DTRGSLP?	0: - 1: +
	-	MODTRGSLP FALL DTRGSLP FALL		
	Slot No.			
	Full Slot Number	FULSLT *	FULSLT?	Integer (0 to 23)
Half Slot Number	HAFSLT *	HAFSLT?	Integer (0 to 1)	
EXT Trigger Delay				
Time Setting	MODTRGDLY *	MODTRGDLY?	Time	
IF Trigger Level	MODTRGLVL *	MODTRGLVL?	Integer (0 to 100)	
Average Times	TXAVG * TAVGTX * DTXAVG *	TXAVG? TAVGTX? DTXAVG?	Integer (1: OFF, 2 to 32)	
Starts measurement				
Tx Power	TXPWR DTXPOW			
Starts measurement in the same mode	SI			

4.2 GPIB Command Codes

Table 4-12 TRANSIENT Key (53 of 56)

Function		Listener Code	Talker Request		Remarks
			Code	Output Format	
Tx Power (DECT)	Measurement results				
	Tx Power		TXPWR? DTXPOW?	d1, d2 d1: Tx Power(dBm) d2: Tx Power(W)	
Power vs Time (DECT)	Auto Level Set	AUTOLVL			
	Trigger Setup				
	Trigger Mode				
	FREERUN	MODTRG FREE DCAPTRG FREE	MODTRG? DCAPTRG?	0: FREERUN	
	IF	MODTRG IF DCAPTRG IF		1: IF	
	EXT	MODTRG EXT DCAPTRG EXT		2: EXT	
	Burst Search				
	Burst Search OFF	MODTRGBRST OFF	MODTRGBRST?	0: OFF	
	Burst Search ON	MODTRGBRST ON		1: ON	
	EXT Trigger Slope				
	+	MODTRGSLP RISE DTRGSLP RISE	MODTRGSLP? DTRGSLP?	0: - 1: +	
-	MODTRGSLP FALL DTRGSLP FALL				
Slot No.					
Full Slot Number	FULSLT *	FULSLT?	Integer (0 to 23)		
Half Slot Number	HAFSLT *	HAFSLT?	Integer (0 to 1)		
EXT Trigger Delay					
Time Setting	MODTRGDLY *	MODTRGDLY?	Time		
IF Trigger Level	MODTRGLVL *	MODTRGLVL?	Integer (%)		

Table 4-12 TRANSIENT Key (54 of 56)

Function		Listener Code	Talker Request		Remarks
			Code	Output Format	
Power vs Time (DECT)	Measurement Mode				
	Normal	PTMOD NORM	PTMOD?	0: NORM	
	High dynamic range	PTMOD HIGH		1: HIGH	
	Y Scale				
	20dB/div	DPTDIV P20DB PTDIV P20DB	DPTDIV? PTDIV?	0: 20dB/div	
	10dB/div	DPTDIV P10DB PTDIV P10DB		1: 10dB/div	
	5dB/div	DPTDIV P5DB PTDIV P5DB		2: 5dB/div	
	Template				
	Template Select	DPTTYP * PTTYP *	DPTTYP? PTTYP?	Integer (Template No.: 1, 2, 3, 4) 1: User Template 1 2: User Template 2 3: User Template 3 4: STD Template	
	Template Edit	DPTENT d0,d1,d2,d3,d4,d5 PTENT d0,d1,d2,d3,d4,d5		d0 to d5: Level(dB) (Unit of level, dB, is necessary)	OffLev Unit is set to dB.
Level Edit					
#0	DPTLV0 *	DPTLV0?	Level		
#1	DPTLV1 *	DPTLV1?	Level		
#2	DPTLV2 *	DPTLV2?	Level		
#3	DPTLV3 *	DPTLV3?	Level		
#4	DPTLV4 *	DPTLV4?	Level		
#5	DPTLV5 *	DPTLV5?	Level		

4.2 GPIB Command Codes

Table 4-12 TRANSIENT Key (55 of 56)

Function	Listener Code	Talker Request		Remarks
		Code	Output Format	
Power vs Time (DECT)	OffLev Unit Edit			
	#0 W	DPTUNIT0 W	DPTUNIT0?	0: W 1: dB
	dB	DPTUNIT0 DB		
	#1 W	DPTUNIT1 W	DPTUNIT1?	0: W 1: dB
	dB	DPTUNIT1 DB		
	#2 W	DPTUNIT2 W	DPTUNIT2?	0: W 1: dB
	dB	DPTUNIT2 DB		
	#3 W	DPTUNIT3 W	DPTUNIT3?	0: W 1: dB
	dB	DPTUNIT3 DB		
	#4 W	DPTUNIT4 W	DPTUNIT4?	0: W 1: dB
dB	DPTUNIT4 DB			
#5 W	DPTUNIT5 W	DPTUNIT5?	0: W 1: dB	
dB	DPTUNIT5 DB			
Entering a set of levels	DPTLVENT d0,u0,d1,u1, d2,u2,d3,u3,d4,u4,d5, u5		d0 to d5: Level(dB) (Unit of level, dB, is necessary) u0 to u5: (0:W 1:dB)	
Average Times	DPTAVG * PTAVG *	DPTAVG? PTAVG?	Integer (1: OFF, 2 to 32)	
Starts measurement				
Power vs Time	DPWRTM PWRTM			
Starts measurement in the same mode	SI			
Measurement results				
Power vs Time		DPWRTM? PWRTM?	Level (W) Level (W)	
PASS/FAIL		DPTJDG? PTJDG?	0/1 0: FAIL 1: PASS	

Table 4-12 TRANSIENT Key (56 of 56)

Function		Listener Code	Talker Request		Remarks
			Code	Output Format	
Graphics Selection (DECT)	Frequency vs Bit	DFMGTYP BIT	DFMGTYP?	0: Frequency vs Bit	
	Frequency EYE	DFMGTYP EYE		1: Frequency EYE	
	Demodulated Data	DFMGTYP DEMOD		2: Demodulated Data	
	Start Bit setting	DSTTBIT *	DSTTBIT?	Integer	
Data Output					
Demodulated Data	Demodulated data output		DEMOMOD?	n<CR+LF>+d1\$<CR+LF>++dn\$<CR+LF> n: Number of output character string data dn\$: Character string data (1 Data: 10 bit)	
Frequency vs Bit	X data (Bit Number)		GPHX?	n<CR+LF>+d1<CR+LF>++dn<CR+LF> n: Number of output data	
Frequency EYE	Y data (Frequency)		GPHY?	dn: Data (Integer) n<CR+LF>+d1<CR+LF>++dn<CR+LF> n: Number of output data dn: Data (Real Number)	

4.2 GPIB Command Codes

Table 4-13 Numeric keys/Step keys/Data knob/Unit keys (Entering data)

Function	Listener Code	Talker Request		Remarks	
		Code	Output Format		
Entering data	0 to 9	0 to 9	-	-	
	. (Decimal point)	.	-	-	
	GHz	GZ	-	-	
	MHz	MZ	-	-	
	kHz	KZ	-	-	
	Hz	HZ	-	-	
	mV	MV	-	-	
	mW	MW	-	-	
	dB	DB	-	-	
	mA	MA	-	-	
	sec	SC	-	-	
	ms	MS	-	-	
	μ s	US	-	-	
	ENTER	ENT	-	-	

Table 4-14 Miscellaneous

Function	Listener Code	Talker Request		
		Code	Output Format	
Miscellaneous	Outputting error number	-	ERRNO?	Integer
	Local	LC	-	-
	Reading GPIB address	-	AD?	Integer (0 to 30)
	Specification of the delimiter CR LF <EOI>	DL0	-	-
	LF	DL1	-	-
	<EOI>	DL2	-	-
	CR LF	DL3	-	-
	LF <EOI>	DL4	-	-
	Service request interruption ON	S0	-	-
	OFF	S1	-	-
	Status clear	S2	-	-
	Service request mask	RQS *	RQS?	Decimal number corresponding to the SRQ bit
	Outputting ID of the instrument	-	*IDN?	Manufacturer name (character string), instrument type (character string), 0 and revision (character string)
	Initializing the instrument	*RST	-	-
	Clearing the queues related to the status byte	*CLS	-	-
	Accessing the standard event enable register	*ESE *	*ESE?	Decimal number corresponding to the register bits
	Reading or clearing the standard event enable register	-	*ESR?	Decimal number corresponding to the register bits
	Accessing the service request enable register	*SRE *	*SRE?	Decimal number corresponding to the register bits
	Reading the status byte and MSS bit	-	*STB?	Decimal number corresponding to the status byte
	Accessing the operation status enable register	OPR *	OPR?	Decimal number corresponding to the register bits
	Reading or clearing the operation status register	-	OPREVT?	Decimal number corresponding to the register bits

5 TECHNICAL INFORMATION

5.1 NARROW/WIDE in the GSM filter mode

The characteristics of a filter used for signal reception (referred to as a receiving filter hereafter) are not explicitly specified in the GSM standard. In this standard, data must be sampled for further analysis at a rate twice or more as fast as the actual bit rate is. The bandwidth of receiving filters can be interpreted as the bit rate from the standard cited above.

The sampling rate used in the instrument is four times the bit rate currently used.

“NARROW” filter refers to a low-pass filter whose bandpass is almost same as the bit rate currently used; and “WIDE” filter is a low-pass filter whose bandpass is almost two times the bit rate currently used.

5.2 NARROW/WIDE in the DECT filter mode

The characteristics of a receiving filter are not explicitly specified in the DECT standard.

The characteristics of the filter used in the instrument are:

NARROW Filter: A low-pass filter whose bandpass is almost same as the bit rate currently used.

NARROW: A low-pass filter whose bandpass is almost two times the bit rate currently used.

5.3 RANDOM/STD in the DECT bit sequence

In the TBR 06 standard, the frequency error is measured by averaging the frequency deviations of a loopback field of the packet after a test pattern is transmitted in the loopback field.

Select the STD mode to measure frequency errors according to the standard. The input signal, however, must already contain the test pattern in the loopback field.

Select the Random mode when the data pattern in a packet is random.

Frequency error (Ferror) is calculated from the formula below using the maximum frequency deviation (fmax) and the minimum frequency deviation (fmin).

$$\text{Ferror} = (\text{fmax} + \text{fmin}) / 2$$

5.4 Measurement of a Signal Containing Multiple Bursts in a Frame (IN GSM)

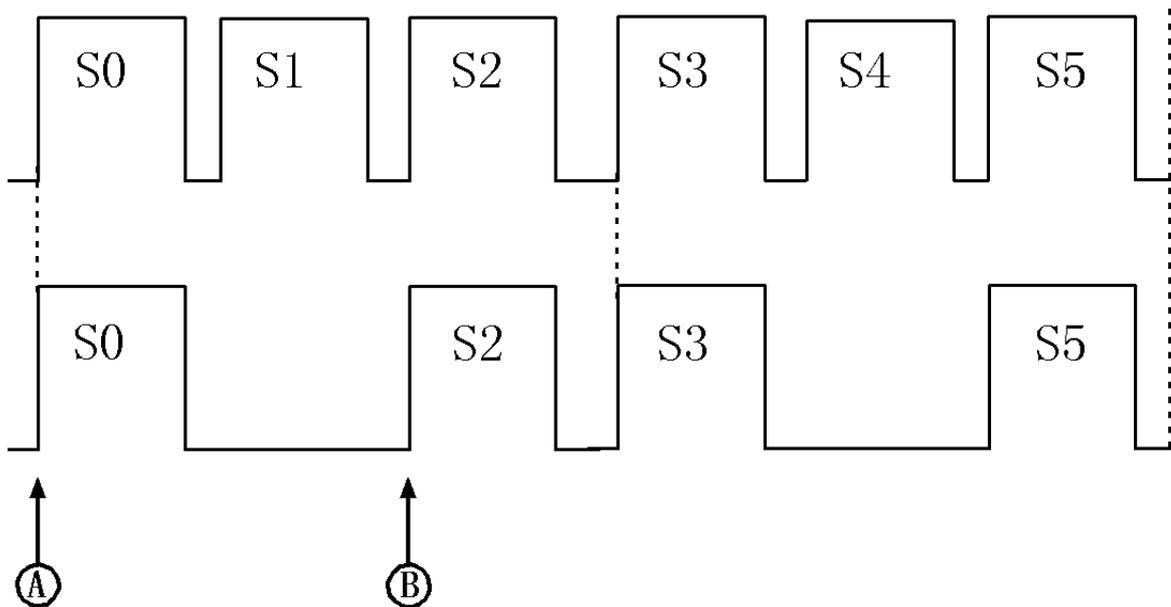

Figure 5-1 A Signal Containing Multiple Bursts in a Frame

In GSM, the targeted slot of a signal, which contains multiple bursts in a frame as shown in Figure 5-1, can be measured by setting Meas Mode (in STD Setup) to MULTI-BURST.

STD Setup is set as follows:

Sync Type: SYNC WORD

Sync Word: TSC 0

When Meas Mode is set to BURST and the circuit in the instrument is triggered at point A on the signal, the measurement is valid. When triggered at point B, however, the measurement is not valid.

When Meas mode is set to MULTI-BURST, measurements are always valid regardless of the triggering point.

In this mode, even if the sync word of the first burst does not coincide with TSC0, the measurement can be repeated up to 16 times until the sync word coincides with TSC0 by automatically capturing the next slot data. This can be applied to a signal having the Super Frame structure. Once the rise of a burst is correctly detected, a slot with TSC0 sync word can be measured regardless of the frame position in which TSC0 sync word is contained.

5.5 Measurement of a Signal Containing UP LINK/DOWN LINK Bursts in a Frame (IN DECT)

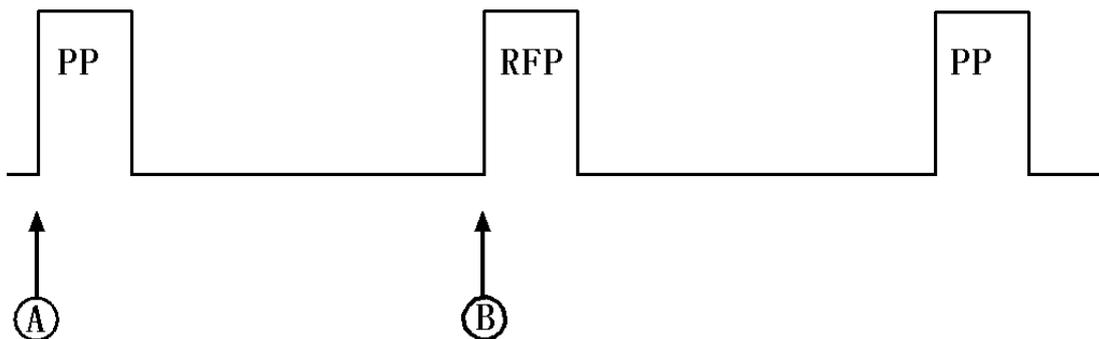

Figure 5-2 A Signal Containing Up Link/Down Link Bursts in a Frame

In DECT, a signal, which contains uplink/downlink signals in a frame as shown in Figure 5-2, can be measured.

STD Setup is set as follows:

Sync Type: SYNC WORD

Link: PP

- (1) When the trigger position is at A:

The measurement is made using this slot as uplink.

- (2) When the trigger position is at B:

As this slot is a downlink slot, the sync word will not coincide with PP when demodulated. When the sync word does not coincide with PP, the instrument automatically capture the 13th slot data after skipping the subsequent 12 slots, and takes a measurement using the slot as a uplink slot.

As a result, the measurement for the set signal can be made even if the signal contains both uplink and downlink signals.

NOTE: When Link is set to RFP, slots with downlink can be measured.

5.6 T-DOMAIN Power

5.6.1 Default values of Time Template

The templates, which are used with T-Domain power measurements of the signals containing raising/falling edges, are set as follows depending on communication systems and their power control levels:

5.6.1.1 GSM Template

Modulation: When select to GMSK

- (1) GSM450,GSM480,GSM850,GSM900,DCS1800BTS

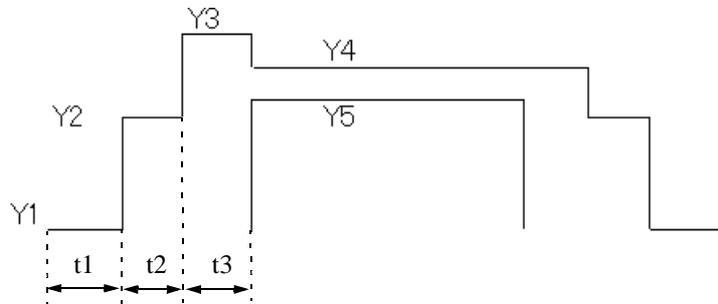

Y1	Y2	Y3	Y4	Y5	t1	t2	t3
-30dBc	-6dBc	+4dBc	+1dBc	-1dBc	10μs	8μs	10μs

- (2) PCS1900BTS

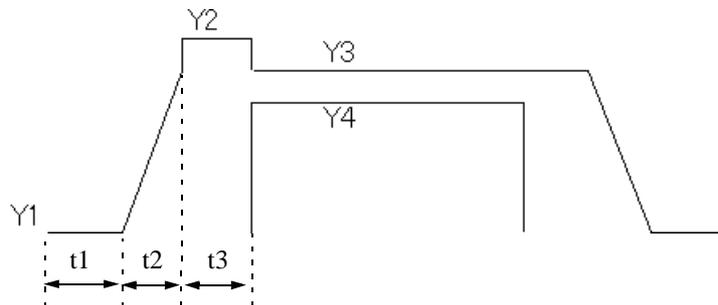

Y1	Y2	Y3	Y4	t1	t2	t3
-30dBc	+4dBc	+1dBc	-1dBc	10μs	8μs	10μs

(3) GSM450,GSM480,GSM850,GSM900,DCS1800,PCS1900MS

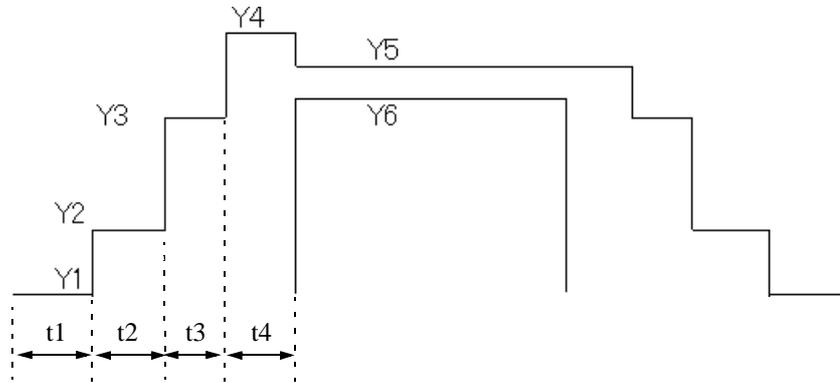

	Pwr Ctrl Lvl	Y1	Y2	Y3	Y4	Y5	Y6	t1	t2	t3	t4
GSM450		MAX[-59dBc,-54dBm]	-30dBc	-6dBc	+4dBc	+1dBc	-1dBc	10μs	10μs	8μs	10μs
GSM480		MAX[-59dBc,-54dBm]	-30dBc	-6dBc	+4dBc	+1dBc	-1dBc	10μs	10μs	8μs	10μs
GSM850		MAX[-59dBc,-54dBm]	-30dBc	-6dBc	+4dBc	+1dBc	-1dBc	10μs	10μs	8μs	10μs
GSM900	16	MAX[-59dBc,-54dBm]	-28dBc	-4dBc	+4dBc	+1dBc	-1dBc	10μs	10μs	8μs	10μs
	17	MAX[-59dBc,-54dBm]	-26dBc	-2dBc	+4dBc	+1dBc	-1dBc	10μs	10μs	8μs	10μs
	18	MAX[-59dBc,-54dBm]	-24dBc	-1dBc	+4dBc	+1dBc	-1dBc	10μs	10μs	8μs	10μs
	19	MAX[-59dBc,-54dBm]	-22dBc	-1dBc	+4dBc	+1dBc	-1dBc	10μs	10μs	8μs	10μs
	Other	MAX[-59dBc,-54dBm]	-30dBc	-6dBc	+4dBc	+1dBc	-1dBc	10μs	10μs	8μs	10μs
DCS1800	11	MAX[-48dBc,-48dBm]	-28dBc	-4dBc	+4dBc	+1dBc	-1dBc	10μs	10μs	8μs	10μs
	12	MAX[-48dBc,-48dBm]	-26dBc	-2dBc	+4dBc	+1dBc	-1dBc	10μs	10μs	8μs	10μs
	13	MAX[-48dBc,-48dBm]	-24dBc	-1dBc	+4dBc	+1dBc	-1dBc	10μs	10μs	8μs	10μs
	14	MAX[-48dBc,-48dBm]	-22dBc	-1dBc	+4dBc	+1dBc	-1dBc	10μs	10μs	8μs	10μs
	15	MAX[-48dBc,-48dBm]	-20dBc	-1dBc	+4dBc	+1dBc	-1dBc	10μs	10μs	8μs	10μs
	other	MAX[-48dBc,-48dBm]	-30dBc	-6dBc	+4dBc	+1dBc	-1dBc	10μs	10μs	8μs	10μs
PCS1900		MAX[-48dBc,-48dBm]	-30dBc	-6dBc	+4dBc	+1dBc	-1dBc	10μs	10μs	8μs	10μs

Pwr Ctrl Lvl:Power Control Level

5.6 T-DOMAIN Power

Modulation: When select to 3PI/8 shift 8PSK

(4) GSM450,GSM480,GSM850,GSM900,DCS1800,PCS1900BTS

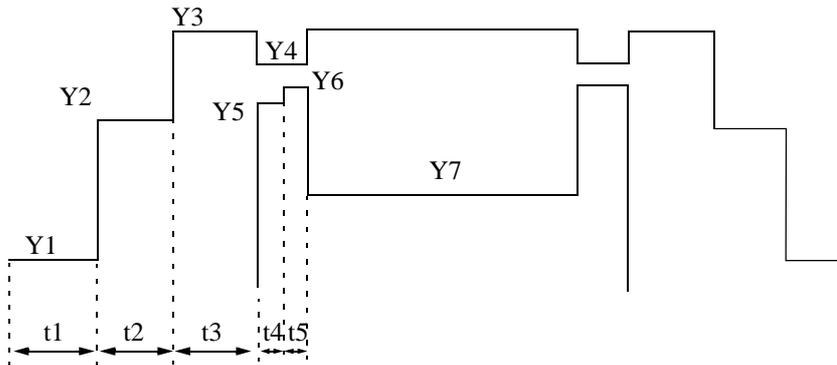

Y1	Y2	Y3	Y4	Y5	Y6	Y7	t1	t2	t3	t4	t5
-30dBc	-6dBc	+4dBc	+2.4dBc	-2dBc	0dBc	-15dBc	10μs	8μs	10μs	2μs	2μs

(5) GSM450,GSM480,GSM850,GSM900,DCS1800,PCS1900MS

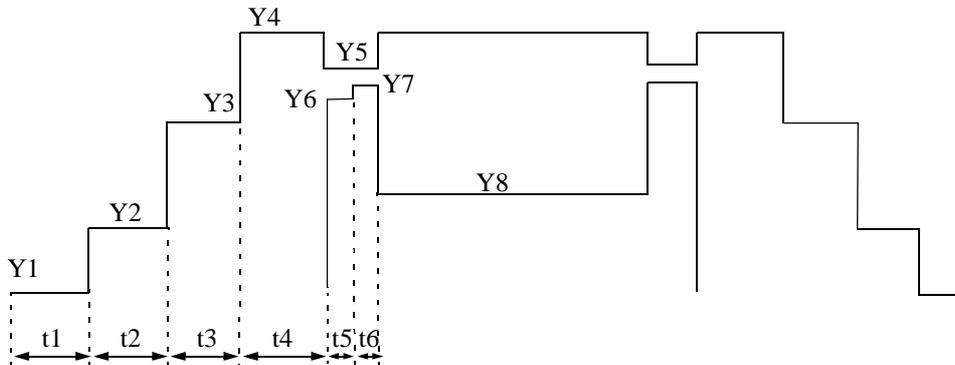

	Y1	Y2	Y3	Y4	Y5	Y6	Y7	Y8
GSM450/GSM480/ GSM850/GSM900	MAX[-59dBc, -54dBm]	-30dBc	-6dBc	+4dBc	+2.4dBc	-2dBc	0dBc	-15dBc
DCS1800/PCS1900	MAX[-48dBc, -48dBm]	-30dBc	-6dBc	+4dBc	+2.4dBc	-2dBc	0dBc	-15dBc

	t1	t2	t3	t4	t5	t6
GSM450/GSM480/ GSM850/GSM900	10µs	10µs	8µs	10µs	2µs	2µs
DCS1800/PCS1900	10µs	10µs	8µs	10µs	2µs	2µs

5.6.1.2 DECT Template

Power Level1

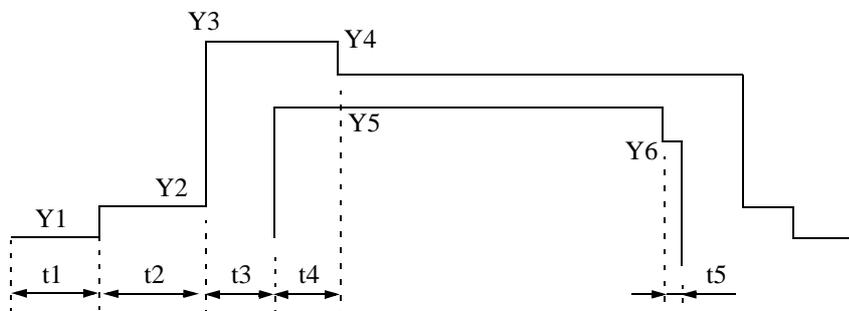

Y1	Y2	Y3	Y4	Y5	Y6	t1	t2	t3	t4	t5
20nW	-20dBc	+4dBc	+1dBc	-1dBc	-6dBc	10µs	17µs	10µs	10µs	0.5µs

Power Level2

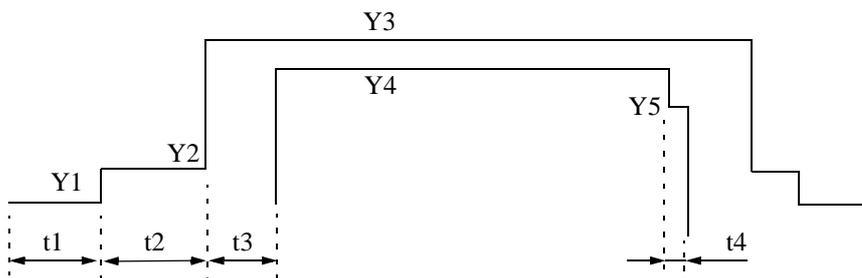

Y1	Y2	Y3	Y4	Y5	t1	t2	t3	t4
20nW	-20dBc	+1 Bc	-1dBc	-6dBc	10µs	17µs	10µs	0.5µs

5.7 Phase Error Measurements Compliant With GSM

Graphic Display Ranges

The GSM standard recommends that only the useful part should be measured in phase error measurements.

The useful part is defined as follows: for a 148-bit slot, the useful part is 147 bits, because the leading and trailing bursts each lose 1/2 bit; for a 88-bit slot, the useful part is 87 bits, because of the same reason as in the former.

If the bit point, which is the converged point displayed when a constellation is displayed, is considered as the reference point, Graphic Display part is “Useful part $\pm 1/2$ bit,” because display begins the time corresponding to 1/2 bit time later (or + 1/2 bit time) and finishes 1/2 bit earlier (or - 1/2 bit time).

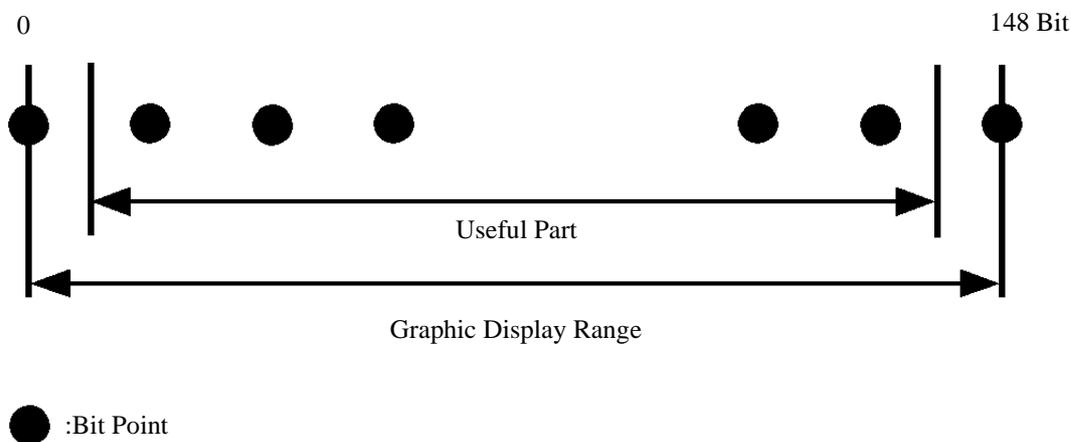

Figure 5-3 Relationship Between Useful Part and Graphic Display Range

Numeric values displayed for the phase errors or peak phase errors are targeted for the useful part.

5.8 Template Edit Function

In TRANSIENT mode, the user can change template. It is necessary to pay attention when entering template, because the data can be interpreted as a relative or absolute value, depending on the setting of Template Couple to Power ON/OFF in the Config menu.

The PASS/FAIL judgment is performed and then the result is displayed on the screen, when Template ON/OFF in the Template menu is set to ON.

The setting values are retained even if a preset is executed.

5.8.1 Template Setting in the T-Domain Measuring Mode

When Template Couple to Power is set to OFF, template (Y axis data) is interpreted as an absolute value. As a result, the template consists of the data you entered.

Use the Shift X/Y keys to adjust the template position over the measured value.

When Template Couple to Power is set to ON, template (Y axis data) is interpreted as a relative value to the average power.

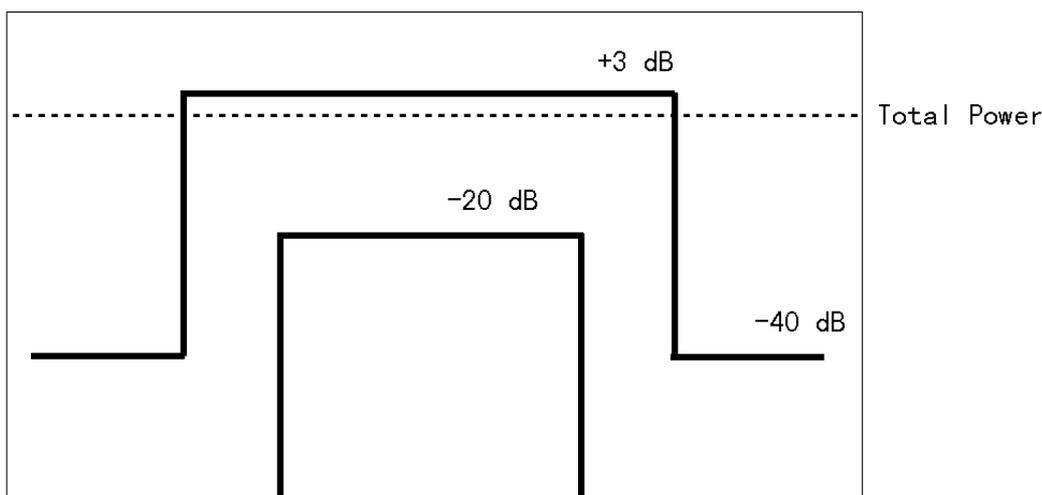

Figure 5-4 Template to Be Set

For example, the above template gives +3 dB and -40 dB of the power during the burst period of the signal. To prepare this template, follow the procedure shown below.

5.8 Template Edit Function

Set the template using the relative value to the average power.

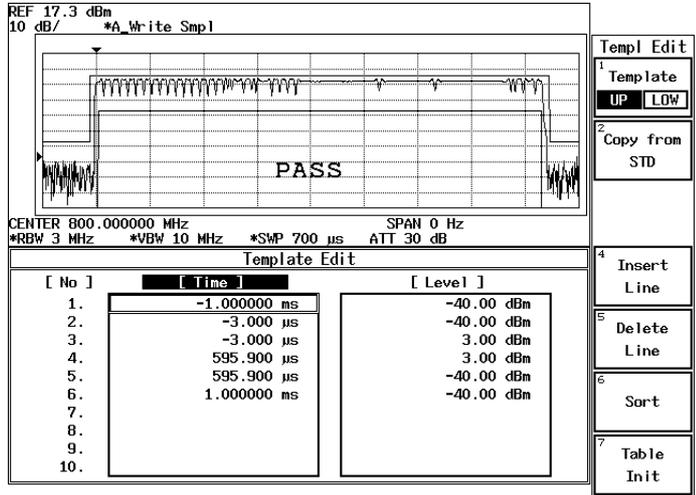

Figure 5-5 Template settings

When you shift the template to the direction of Y axis using Shift X/Y function while the Template Couple to Power is set to ON, the relative value to the average power is: Relative value (set on the template) + Shifted data on Y axis.

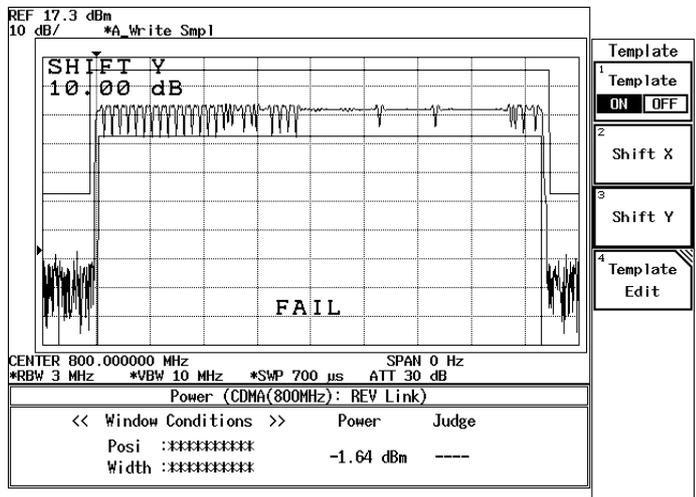

Figure 5-6 Template Shifted Using the Shift Y Function

5.8.2 Template Setting in the F-Domain Measuring Mode

In F-Domain measurement mode, the carrier frequencies depend on the channel numbers. As a result, use the offset frequency from the carrier frequency for template's X axis data.

Set the carrier frequency on the template to 0 Hz so that you can use plus or minus values for the offset frequencies.

The analyzer sets the template by adding the center frequency currently used to X value in the Shift X menu.

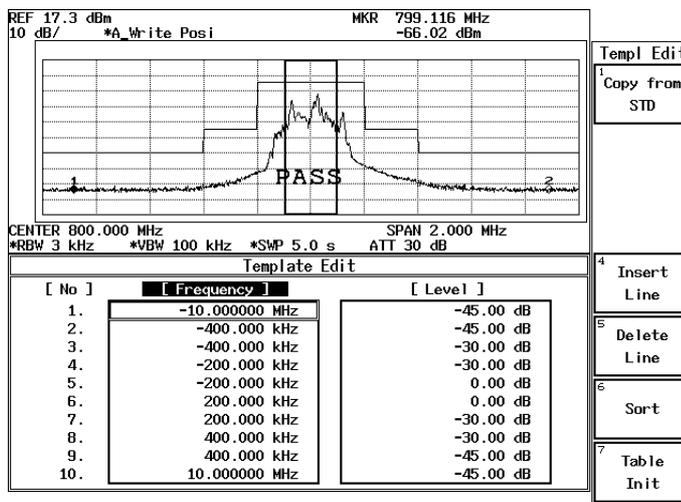

Figure 5-7 Template with the Set Values

Soft menu Margin delta X expands the template frequency by (X/2 to both sides toward plus and minus frequency directions) from the 0 Hz on the template.

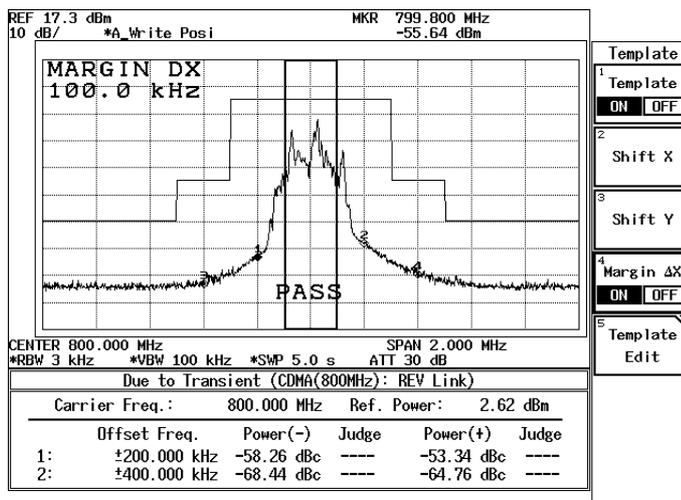

Figure 5-8 Template with Margin Delta X

5.8 Template Edit Function

When Template Couple to Power is set to OFF, template (Y axis data) is interpreted as an absolute value. As a result, the template is made up of the data you entered.

Use the Shift X/Y keys to adjust the template position over the measured value.

When Template Couple to Power is set to ON, template (Y axis data) is interpreted as a relative value to the average power.

When the template is shifted on Y axis using the Shift X/Y function, the relative value to the average power is: Relative value (set on the template) + Shifted data on Y axis.

5.9 Measurement Parameter Settings in Due to Transient, Due to Modulation and Inband Spurious

In TRANSIENT mode, any parameters are compliant with the communication standard when you specify the communication standard. You can also change the measuring frequency and the secondary processing of the measured results.

For the method of changing these, refer to the following

5.9.1 Marker Edit Function

Measurement frequency can be set using Marker Edit in Due to Transient, Due to Modulation or Inband Spurious function (these three functions are found within the Transient mode). In addition, each limit level can be set using Marker Edit.

The setting values are retained even if a preset is executed.

(1) Marker Edit used in the Due to Transient and Due to Modulation

The measuring frequency is set using the offset frequency from a carrier frequency. If you set the offset frequency to 200 kHz, the offset frequencies (+200 kHz and -200 kHz) can be measured. The Normal marker, Integral marker and Root Nyquist marker are available.

Normal marker is used to read the level of the frequency previously set, and the Integral marker is used to calculate the power of the bandwidth whose center frequency is specified by Marker Edit.

When the Root Nyquist marker is selected, the power of the frequencies, which passed through the Root Nyquist filter, is calculated. To set the Root Nyquist filter parameters, press Config and Parameter Setup.

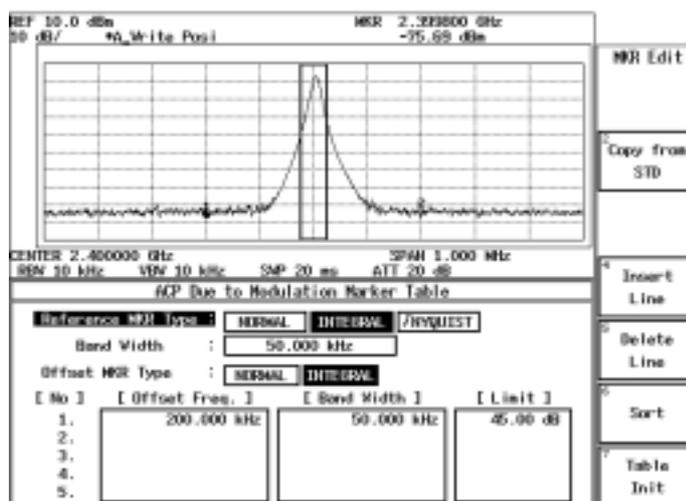

Figure 5-9 Example of Marker Edit Setting

(2) Marker Edit used in the Inband Spurious

Measuring frequency range is set using the offset frequency from the carrier frequency. If you set 3 MHz and 10 MHz, the peak search is performed for two ranges: one of the two offset frequency range is between -3 MHz and -10 MHz; another range is between +3 MHz and +10 MHz.

5.9 Measurement Parameter Settings in Due to Transient, Due to Modulation and Inband Spurious

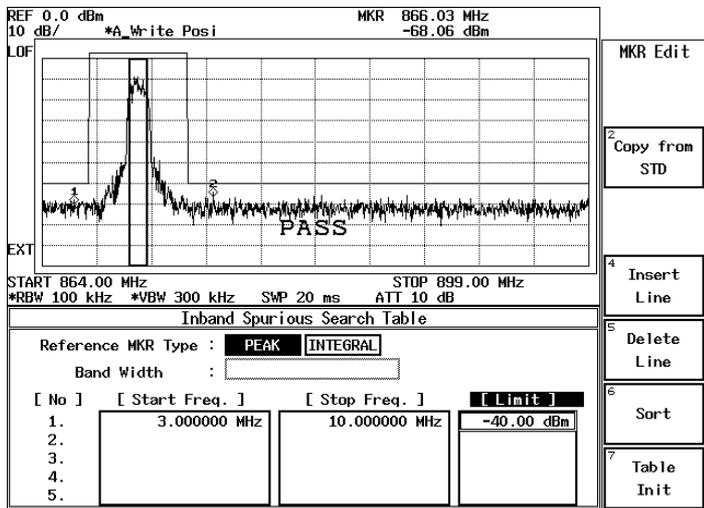

Figure 5-10 Marker Edit Setting

Peak marker is set using the Peak Marker Y Delta soft key in the Config menu.

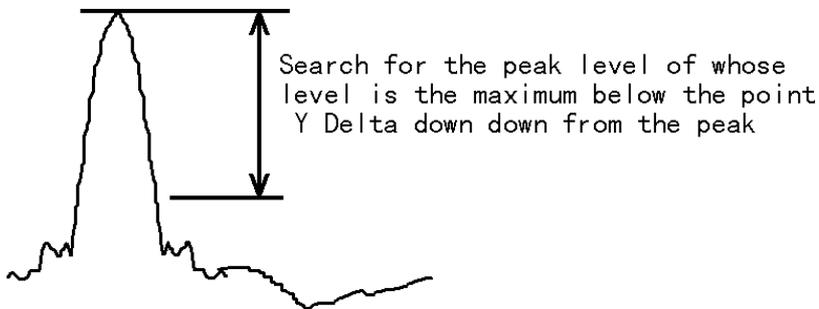

Figure 5-11 Example of Peak Marker Y Delta

5.9.2 Measurement results Using Due to Modulation, Due to Transient and Inband Spurious Modes

In spectrum measurements, there are three methods for displaying results of adjacent or alternate adjacent channel leakage power measurements.

- (1) The measured value displays the absolute level of the marker, which is located at an offset frequency from the carrier frequency.
- (2) The ratio of the absolute level of the marker to the absolute level of the carrier is displayed. The marker point is located at an offset frequency from the carrier frequency.
- (3) The value obtained in (2) is multiplied by the level by the power meter. The calculated value is then displayed.

5.9 Measurement Parameter Settings in Due to Transient, Due to Modulation and Inband Spurious

This method is used when the absolute value of the adjacent channel power cannot be measured. The ratio of the adjacent channel power to the carrier power can be measured only when Detector is set to Posi. However, the absolute level cannot be measured.

To display a measured value in (1), select MARKER on the Result: MARKER/RELATIVE/ABS POWER menu in the Parameter Setup dialog box.

To display the measured value in (2), select RELATIVE.

To display a measured value in (3), select ABS POWER. In addition, use the Marker Edit menu to set up measurement conditions for the carrier power. Set the MKR Type to NORMAL, INTEGRAL or $\sqrt{\text{NYQUIST}}$ in the Reference Marker in order to measure the carrier power.

To measure the power of the bandwidth by integration, Reference MKR Type must be set to INTEGRAL.

To measure a point level (marker reading), Reference MKR Type must be set to NORMAL.

To measure adjacent channel power, set Offset MKR Type to NORMAL, INTEGRAL or $\sqrt{\text{NYQUIST}}$. To measure the carrier power in (2) or (3), there are two methods: one is by setting the Marker Edit to the Reference MKR type (set the Ref Power to REF MARKER. Ref Power is in the Parameter Setup dialog box on the config menu); another is to measure power using the DSP (set the Ref Power to MODULATION. Ref Power is in the Parameter Setup dialog box on the config menu).

When REF MARKER is selected, the carrier power is measured by setting Reference MKR Type in the Marker Edit menu.

When MODULATION is selected, the carrier power is measured by Tx Power (Modulation, Tx Power).

When ABS POWER of the Result is selected from the Parameter Setup dialog box in the Config Menu, the ratio of Offset MKR to Reference MKR is calculated, the measurement value from Tx Power is multiplied by this ratio. Then, the result will be displayed.

5.9.3 Measurement Result of Inband Spurious

In Spurious measurements, there are two methods:

- (1) After searching for the peak on the trace, the frequency and level at the marker are displayed.
- (2) After searching for the peak on the trace, the ratio of the marker level to the carrier level is displayed.
- (3) The calculated level, which is calculated using the result obtained in (2) and the level on the power meter is displayed.

To display the measured value in (1), select MARKER on the Result: MARKER/RELATIVE/ABS POWER menu in the Parameter Setup dialog box. And also, to display the measured value in (2), select RELATIVE; for the (3), select ABS POWER. The measurement conditions for the carrier power is set up using the Marker Edit menu. To measure the carrier power, set Reference MKR Type to PEAK or NORMAL.

To measure the carrier power at the specified frequency, NORMAL is set; and to measure the carrier power at the peak on the trace, PEAK is set.

To measure the carrier power in (2) or (3), there are two methods: one is by setting the instrument to the Reference MKR type in the Marker Edit menu; another is by the DSP.

When Ref Power is set to REF MARKER, the carrier power is measured by Reference MKR Type in the Marker Edit menu.

When Ref Power is set to MODULATION, the carrier power is measured by the Tx Power (Modulation, Tx Power).

5.10 Phase Error

5.10 Phase Error

Phase Error is defined as shown in Figure 5-12, and the value is calculated using the following formula.

$$\text{Phase Error}(i) = \tan^{-1}(Q_m(i)/I_m(i)) - \tan^{-1}(Q_r(i)/I_r(i))$$

$I_m(i)$, $Q_m(i)$: measured value
 $I_r(i)$, $Q_r(i)$: Reference value
 i : Symbol number

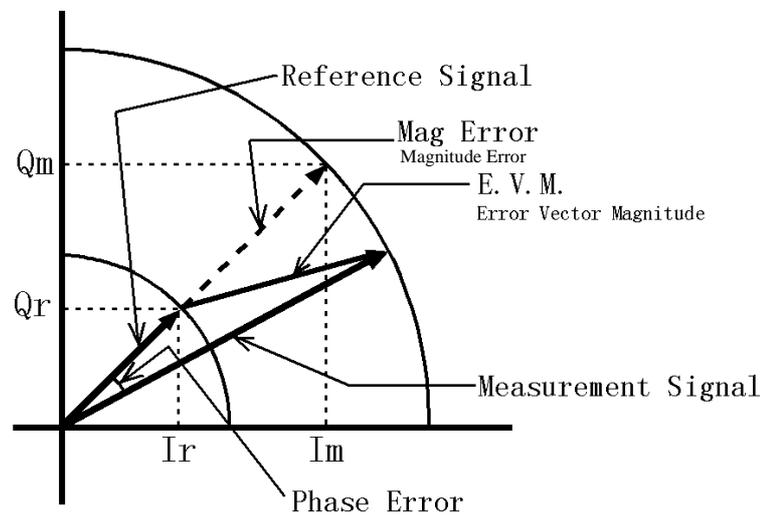

Figure 5-12 Mag Error, Phase Error, E.V.M.

5.11 8 PSK Graph

When 3 pi/8 Shift 8PSK is selected to analyze EDGE signal modulation, 8PSK Constellation or 8PSK I(Q) Eye can be selected from the Modulation Accuracy menu.

The symbol points of the EDGE signal vary due to the baseband signal characteristic.

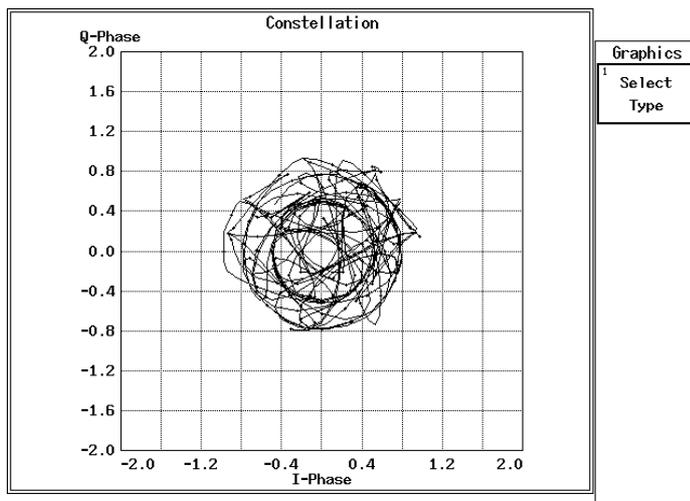

Figure 5-13 EDGE Signal Constellation

An 8 PSK signal with convergent symbol points can be obtained using a filter whose characteristics are opposite to the EDGE baseband filter characteristics. An 8 PSK signal with convergent symbol points is referred to as 8 PSK Constellation.

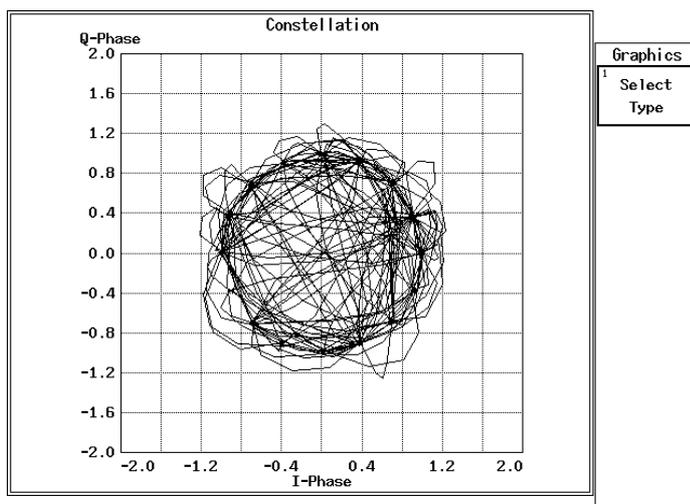

Figure 5-14 EDGE Signal 8 PSK Constellation

5.12 Tx Power Peak Factor

When 3 PI/8 Shift 8PSK is selected to analyze EDGE signal modulation, measuring the Tx power displays the peak factor, which is calculated using the equation shown below.

Peak factor = Peak power / Average power

The input signal is down-converted to the baseband signal to calculate the peak and average powers from the baseband signal envelope.

Make sure this Peak Factor is not equal to Peak Amplitude of IF or RF status.

5.13 Block Diagram

This section shows the block diagram for the modulation analysis hardware.

The Figure 5-15 shows the modulation analysis part. Therefore the spectrum analyzer part is simplified. The area inside the double lines is the block diagram for the spectrum analyzer, and the part outside that area represents the modulation analysis hardware.

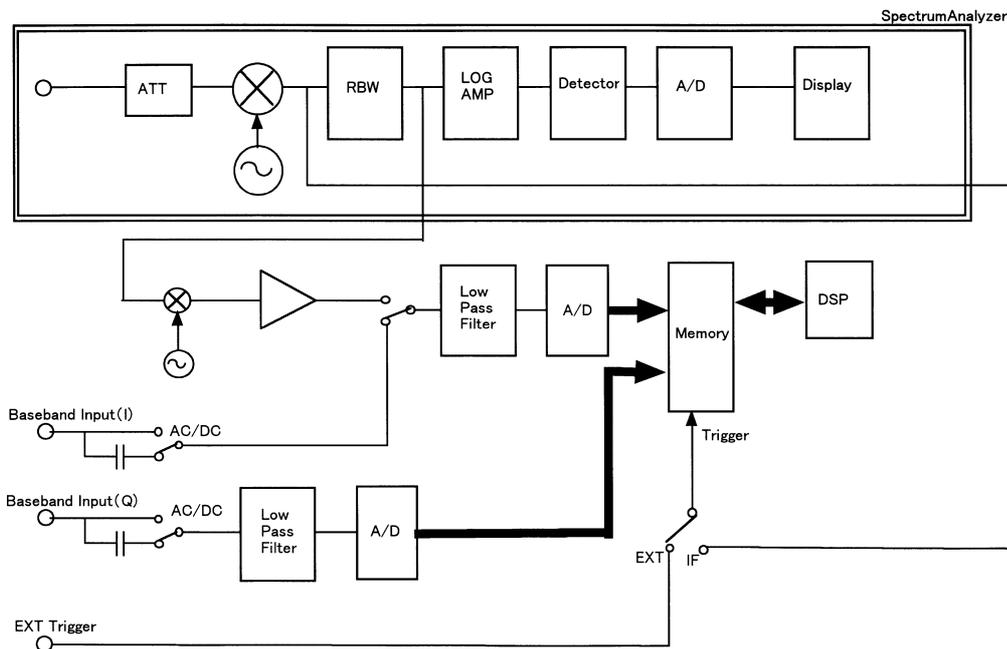

Figure 5-15 Block Diagram

6 PERFORMANCE VERIFICATION TEST

6.1 General

6.1.1 Introduction

This chapter provides R3267 Series performance verification test procedures, item by item as listed in Table 6-1.

Performance verification test will be carried out under following condition.

Temperature range: 20°C to 30°C

Relative Humidity: 85% or less

Table 6-1 Performance Verification Items

No.	Test Items
6.2.1	Phase Error Measurement Accuracy for GSM
6.2.2	Modulation Accuracy Measurement for EDGE
6.2.3	Frequency Deviation Accuracy Measurement for DECT

6.1.2 Test Equipment

The Table 6-2 lists recommended test equipment.

The equipment needed to perform all of the performance test.

Equipment lists for individual tests are provided in each performance verification test.

In the table, PV is abbreviation of performance verification.

-
- NOTE:**
1. *The R3267 Series with OPT63 to be tested should be warm up for at least 30 minutes before starting test.*
 2. *Make sure that the test equipment used meets its own published specifications.*
 3. *Any equipment that meets the critical specifications given in the table can be substituted for recommended models.*
-

Table 6-2 Equipment List

No.	Description	Specification required	Recommended Model	Manufacturer	Usage
1	RF Cable	BNC(m)-BNC(m), 50Ω	MI-09	Advantest	PV
2	Adapter	Type N(m)-BNC(f), 50Ω	JUG-201A-U	Advantest	PV

6.1.3 Calibration Cycle

The performance verifications test should be used to check the spectrum analyzer against its specifications once a year recommended.

6.1 General

6.1.4 Performance Verification Test Record Sheet

The performance verification test record sheets are provided at the end of this chapter.

The test record lists test specification and acceptable limits.

Recommend that make a copy of this table, record the complete test results on the copy, and keep the copy for calibration test record.

This record could prove invaluable in tracking gradual changes in test result over long periods of the time.

6.1.5 Performance Verification Procedures

Typeface conventions used in this manual.

- Panel keys and soft keys are printed in a contrasting type style to make them stand out from the text as follows:

Panel keys: Boldface type

Example: **FREQ, FORMAT**

Soft keys: Boldface and Italic

Example: ***Center, Trace Detector***

- When a series of key operations are described using a comma between two keys.
- There are various soft menus used to switch between two states such as ON/OFF and AUTO/MNL.

For example, when turning off the ***Display ON/OFF*** function, the annotation "***Display ON/OFF*** (OFF)" is used.

When switching the ***RBW AUTO/MNL*** function to MNL, the annotation "***RBW AUTO/MNL*** (MNL)" is used.

6.2 Performance Verification Test Procedure

This section provides performance verification test procedure for R3267 Series OPT 63.

Built-in calibration signal is used for performance verification.

6.2.1 Phase Error Measurement Accuracy for GSM

(1) Description

Test phase error measurement accuracy in rms and peak mode and carrier frequency accuracy for GSM.

(2) Specification

Phase Error Measurement Accuracy(rms) : $< 1^\circ$

Phase Error Measurement Accuracy(peak) : $< 5^\circ$

Carrier Frequency Accuracy : $< \pm 5$ Hz

(3) Equipment used

RF Cable : BNC(m)-BNC(m)

Adapter : N(m)-BNC(f)

(4) Setup

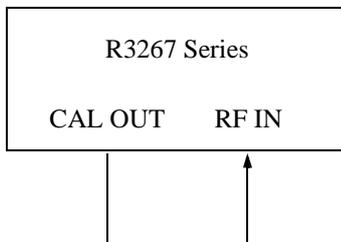

Figure 6-1 Setup of Phase Error Measurement Accuracy for GSM

(5) Procedure

1. Connect equipment as shown in Figure 6-1.
2. On the R3267 Series, after preset, set control as follow;
Center Frequency: 30.067708 MHz

6.2 Performance Verification Test Procedure

- On the R3267 Series, set the STD parameter as shown Figure 6-2.

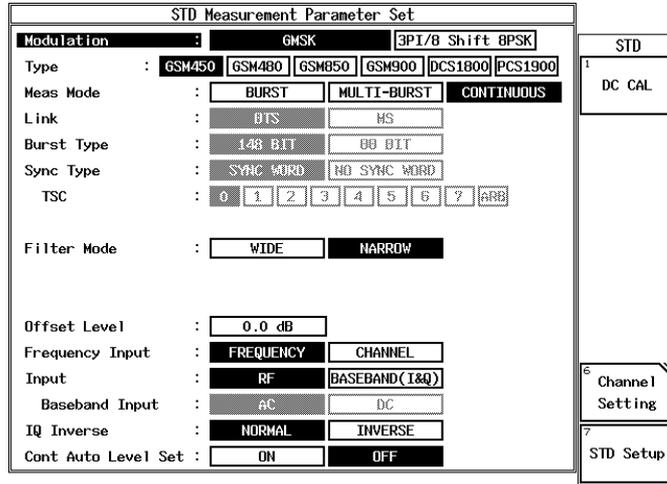

Figure 6-2 Setting of STD Parameter for Phase Error Accuracy Measurement (GSM)

- On the R3267 Series, press **DC CAL**, **Phase Error** and **AUTO LEVEL**.
- On the R3267 Series, press **SINGLE** for single sweep.
- After single sweep has completed, record the measurement result in the performance verification test record sheet.

6.2.2 Modulation Accuracy Measurement for EDGE

- Description

Test modulation accuracy and carrier frequency accuracy in EDGE mode.

- Specification

Modulation Accuracy (rms) : $\leq 1.8 \%$

Carrier Frequency Accuracy : $\leq \pm 10 \text{ Hz}$

- Equipment used

RF Cable : BNC (m)-BNC (m)

Adapter : N (m)-BNC (f)

(4) Setup

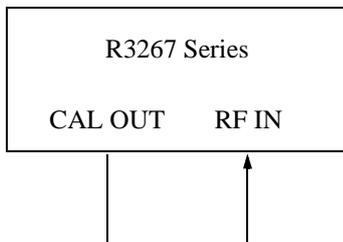

Figure 6-3 Setup of Modulation Accuracy for EDGE

(5) Procedure

1. Connect equipment as shown in Figure 6-3.
2. On the R3267 Series, after preset, set control as follow:
Center Frequency :30.050781 MHz
3. On the R3267 Series, set the measurement parameter as shown in Figure 6-4.

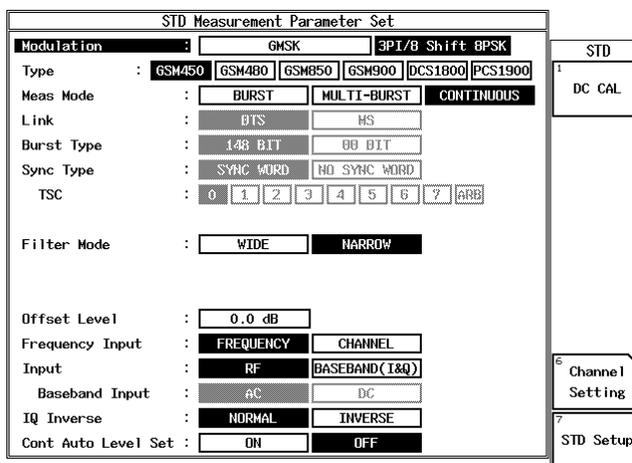

Figure 6-4 Setting of STD Parameter for Modulation Accuracy Measurement (EDGE)

4. On the R3267 Series, press **DC CAL** to perform dc calibration.
5. On the R3267 Series, press **Modulation Accuracy** and **Parameter Setup** to set R.C. filter to on as shown in Figure 6-5.

6.2 Performance Verification Test Procedure

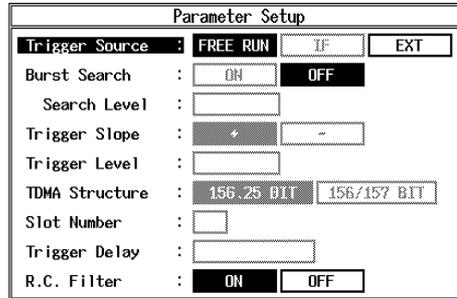

Figure 6-5 Setting of Parameter Setup

6. On the R3267 Series, press keys as follows to perform auto level.
Parameter Setup, AUTO LEVEL
7. On the R3267 Series, press **SINGLE** for a single sweep.
8. On the R3267 Series, after the single sweep has completed, record the result on the performance verification test record sheet.

6.2.3 Frequency Deviation Accuracy Measurement for DECT

- (1) Description

Test carrier frequency accuracy, frequency deviation (\pm peak) frequency deviation for DECT.

- (2) Specification

Carrier Frequency Accuracy : $< -288 \text{ kHz} \pm 10 \text{ kHz}$
 Frequency Deviation Accuracy (+peak) : $< -288 \text{ kHz} \pm 10 \text{ kHz}$
 Frequency Deviation Accuracy (-peak) : $< -288 \text{ kHz} \pm 10 \text{ kHz}$

- (3) Equipment used

RF Cable : BNC(m)-BNC(m)
 Adapter : N (m)-BNC (f)

- (4) Setup

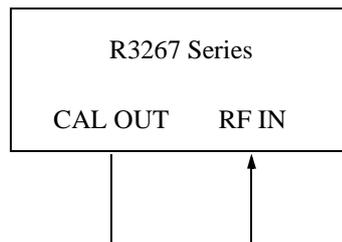

Figure 6-6 Setup of Frequency Deviation Accuracy Measurement for DECT

(5) Procedure

1. Connect equipment as shown in Figure 6-6.
2. On the R3267 Series, after preset, set control as follow:

Center Frequency : 30.228 MHz

3. On the R3267 Series, set the measurement parameter as shown in Figure 6-7.

STD Measurement Parameter Set	
Type :	DECT
Meas Mode :	BURST CONTINUOUS
Link :	RFP PP
Physical Packet :	P00 P32 P08 P80
Z-Filed :	ON OFF
Sync Type :	SYNC WORD NO SYNC WORD
Filter Mode :	WIDE NARROW
Power Level :	LEVEL1 LEVEL2
Offset Level :	0.0 dB
Frequency Input :	FREQUENCY CHANNEL
Input :	RF BASEBAND(I&Q)
Baseband Input :	AC DC
Phase Inverse :	NORMAL INVERSE
Cont Auto Level Set :	ON OFF

1 STD
DC CAL

6 Channel Setting

7 STD Setup

Figure 6-7 Setting of Measurement parameter for Frequency Deviation Accuracy Measurement (DECT)

4. On the R3267 Series, press **DC CAL**, **Freq Deviation** and **AUTO LEVEL**.
5. On the R3267 Series, press **SINGLE** for single sweep,
6. After single sweep has completed, record the measurement result in the performance verification test record sheet.

6.3 Performance Verification Test Record Sheet

6.3 Performance Verification Test Record Sheet

Model : OPT3264/67/73+63

S/N :

(1) Phase Error Measurement Accuracy for GSM

Items	Specification			Result
	Min.	Measured Value	Max.	Pass/ Fail
Phase Error Accuracy (rms)	N/A		1	
Phase Error Accuracy (peak)	N/A		5°	
Carrier Frequency Accuracy	-5 Hz		+5 Hz	

(2) Modulation Accuracy Measurement for EDGE

Items	Specification			Result
	Min.	Measured Value	Max.	Pass/ Fail
Modulation Accuracy (rms)	N/A		1.8% rms	
Carrier Frequency Accuracy	-10 Hz		+10 Hz	

(3) Frequency Deviation Accuracy Measurement for DECT

Test Items	Specification			Result
	Min.	Measured Value	Max.	Pass/ Fail
Carrier Frequency Accuracy	-298 kHz		-278 kHz	
Frequency Deviation Accuracy (+peak)	-298 kHz		-278 kHz	
Frequency Deviation Accuracy (-peak)	-298 kHz		-278 kHz	

7 SPECIFICATIONS

RF input

- GSM Phase Error Measurement

Characteristics	Specification
Target modulation system	GMSK
Measurement frequency range	30 MHz to 3.0 GHz
Input level range	-30 dBm to +30 dBm
Frequency/phase error measurements	
Frequency error range	< ± 10 kHz
Accuracy	< \pm (Reference frequency accuracy \times Carrier frequency + 5 Hz)
Phase error range	$\leq \pm 30^\circ$ (peak)
Accuracy	$\leq \pm 5^\circ$ (peak) $\pm 1^\circ$ (rms)

- EDGE measurement

Characteristics	Specification
Target modulation system	3PI/8 Shift 8PSK (Linearized Gaussian Filter)
Measurement frequency range	30 MHz to 3.0 GHz
Input level range	-30 dBm to +30 dBm
Frequency error measurement	
Measurement accuracy	< \pm (Reference frequency accuracy \times Carrier Frequency + 10 Hz)
Modulation accuracy measurement	
Residual vector error	<1.8% rms

7 SPECIFICATIONS

- DECT measurement

Characteristics	Specification
Target modulation system	GFSK
Measurement frequency range	30 MHz to 3.0 GHz
Input level range	-30 dBm to +30 dBm
Frequency deviation accuracy	$< \pm(\text{Reference frequency accuracy} \times \text{Carrier frequency} + 10 \text{ kHz})$ (For the maximum and minimum deviations)
Frequency error accuracy	$< \pm(\text{Reference frequency accuracy} \times \text{Carrier frequency} + 10 \text{ kHz})$
Jitter accuracy	$< \pm 0.1 \mu\text{sec}$ A jitter between bursts (such as "PP to PP," "RFP to RFP," and "RFP to PP") is measured.

APPENDIX

A.1 Messages

In this section, the messages that are displayed while the analyzer is being used are described.

Code	Messages	Description
700	System Error. Cannot allocate the required memory.	Fatal Error occurred. Data area for the calculation is insufficient on the memory. Contact a sales representative.
701	System Error. Clock is not operational.	Fatal Error occurred. System clock is not in operation. Contact a sales representative.
702	Modulation Gain CAL error. Check 30 MHz CAL signal for connection.	
703	Modulation DC CAL error. Remove input signals and try again.	
704	Time Out! No Trigger Detected	Time out error on the trigger signal occurred. Check the trigger settings.
705	Input Level is out of Range. Check the Ref. level.	
706	No graph data. Execute measurement.	
708	System Error. Contact qualified engineer.	
710	Auto Level completed !	
711	Auto Level Set can not be succeed. Signal level is not stable.	
719	Burst signal is not detected. Check Burst length or Ref. level.	
721	Modulation Gain CAL error!(#100) Check 30 MHz CAL signal for connection.	

A.1 Messages

Code	Messages	Description
722	Modulation Gain CAL error!(#200) Check 30 MHz CAL signal for connection.	
723	Modulation Gain CAL error!(#300) Check 30 MHz CAL signal for connection.	
724	Modulation Gain CAL error!(#110) Check 30 MHz CAL signal for connection.	
725	Modulation Gain CAL error!(#120) Check 30 MHz CAL signal for connection.	
726	Modulation Gain CAL error!(#210) Check 30 MHz CAL signal for connection.	
730	Cannot measure Multi-Burst/Continuous Signal. Set Meas Mode to BURST.	
731	Cannot detect Sync Word. Check link or syncword number.	
732	Sync Word position is different from STD.	
733	Input Level is too Low. Adjust Ref. level, trigger delay, burst type.	
734	Result Error. Check input signal or settings.	The measured value is outside the measurement range. Check the input signal and the instruments for the correct settings.
736	Cannot measure GMSK signal. Set Modulation Type to 3PI/8 Shift 8PSK.	This measurement function cannot be used to analyze GMSK signals. To enable this measurement function, set Modulation Type to 3PI/8 Shift 8PSK.

Code	Messages	Description
737	Cannot measure 3PI/8 Shift 8PSK signal. Set Modulation Type to GMSK.	This measurement function cannot be used to analyze 3PI/8 Shift 8PSK signals. To enable this measurement function, set Modulation Type to GMSK.
795	System Error. Memory test failed. (#0)	
796	System Error. Memory test failed. (#1)	
797	System Error. Memory test failed. (#2)	
798	System Error. Memory test failed. (#3)	

ALPHABETICAL INDEX

			3-34, 3-37, 3-40, 3-43, 3-45, 3-47, 3-51, 3-55, 3-57, 3-60, 3-62, 3-64, 3-66, 3-68, 3-71, 3-73, 3-74, 3-75, 3-77
	[Numerics]		
8PSK Constellation	3-20		
8PSK Constellation(Dot)	3-20		
8PSK Constellation(Line & Dot)	3-20		
8PSK Constellation(Line)	3-20		
8PSK I EYE Diagram	3-20		
8PSK I/Q EYE Diagram	3-20		
8PSK Q EYE Diagram	3-20		
	[A]		
Accessories	1-1		
Auto Level Set	3-8, 3-9, 3-10, 3-11, 3-12, 3-13, 3-14, 3-15, 3-17, 3-18, 3-19, 3-20, 3-21, 3-22, 3-23, 3-24, 3-25, 3-26, 3-30, 3-33, 3-36, 3-38, 3-41, 3-45, 3-46, 3-49, 3-53, 3-56, 3-59, 3-61, 3-63, 3-64, 3-67, 3-68, 3-70, 3-72, 3-73, 3-74, 3-76, 3-77		
Average Mode	3-8, 3-9, 3-10, 3-11, 3-12, 3-13, 3-14, 3-16, 3-17, 3-18, 3-32, 3-35, 3-38, 3-41, 3-44, 3-45, 3-48, 3-53, 3-56, 3-58		
Average Times	3-11		
Average Times ON/OFF	3-8, 3-9, 3-10, 3-12, 3-13, 3-14, 3-15, 3-17, 3-18, 3-19, 3-20, 3-21, 3-22, 3-23, 3-24, 3-25, 3-26, 3-32,		
		[B]	
		Baseband Input	3-27, 3-81, 3-84
		Bit Sequence	3-24, 3-71
		BTS Template1	3-22, 3-64
		BTS Template2	3-22, 3-64
		Burst PREV/NEXT	3-22, 3-66
		Burst Search	3-19, 3-20, 3-21, 3-22, 3-23, 3-24, 3-25, 3-26, 3-60, 3-62, 3-63, 3-65, 3-69, 3-71, 3-72, 3-74, 3-75, 3-78
		Burst Type	3-27, 3-80
		[C]	
		Calibration	1-1
		Calibration Cycle	6-1
		Channel Setting	3-7, 3-23, 3-26, 3-79
		Code	A-1, A-2, A-3
		Communication Systems	3-29
		Config	3-8, 3-9, 3-10, 3-11, 3-12, 3-13, 3-14, 3-15, 3-17, 3-18, 3-32, 3-34, 3-37, 3-40, 3-43, 3-45, 3-47, 3-51, 3-55, 3-57
		Connectors	1-2
		Consecutive Template	3-22, 3-66
		Constellation	3-19, 3-20

Alphabetical Index

Constellation(Dot)	3-19, 3-20	3-48, 3-52,
Constellation(Line & Dot)	3-19, 3-20	3-56, 3-57
Constellation(Line)	3-19, 3-20	Due to Modulation
Cont Auto Level Set	3-27, 3-81,	3-7, 3-49,
	3-84	5-13, 5-14
Copy from STD	3-7, 3-8,	Due to Transient
	3-14, 3-15,	3-7, 3-46,
	3-17, 3-18,	5-13, 5-14
	3-23, 3-26,	
	3-31, 3-46,	
	3-47, 3-51,	
	3-54, 3-57,	
	3-79	
		[E]
		E.V.M. vs Symbol
		3-20
		Ext Gate
		3-12, 3-15,
		3-43, 3-50
		[F]
		F-Domain
		3-7, 3-41
		FFT of Phase Error
		3-19
		Filter Mode
		3-27, 3-80,
		3-83
		Freq Deviation
		3-7, 3-24,
		3-70
		Freq. Setting
		3-14, 3-16,
		3-17, 3-47,
		3-52, 3-55
		Frequency Deviation Accuracy
		Measurement for DECT
		6-6
		Frequency EYE
		3-19, 3-24
		Frequency Input
		3-27, 3-81,
		3-83
		Frequency vs Bit
		3-19, 3-24
		Full Slot Number
		3-24, 3-25,
		3-26, 3-71,
		3-73, 3-74,
		3-75, 3-77,
		3-78
		Functional Description
		3-28
		[G]
		Gate Position
		3-12, 3-15,
		3-43, 3-50
		Gate Setup
		3-12, 3-15,
		3-42, 3-43,
		3-49, 3-50
		Gate Source
		3-12, 3-15,
		3-42, 3-50
		Gate Width
		3-12, 3-15,
		3-43, 3-50
		Gated Sweep
		3-12, 3-44
		Gated Sweep ON/OFF
		3-12, 3-15,
		3-43, 3-50
		GPIB Command Codes
		4-10
		GPIB Command Index
		4-1
		Graphics
		3-19, 3-20,
		3-24, 3-59,

GSM Template	3-61, 3-70	3-18, 3-37, 3-39, 3-56, 3-57	
[H]			
Half Slot Number	3-24, 3-25, 3-26, 3-71, 3-73, 3-74, 3-75, 3-77, 3-78	Lower Limit	
Half Symbol Shift	3-19, 3-21, 3-22, 3-60, 3-64, 3-66	3-8, 3-12, 3-13, 3-32, 3-44, 3-45	
[I]			
I EYE Diagram	3-19, 3-20		
I/Q EYE Diagram	3-19, 3-20		
Ich & Qch Time	3-23, 3-26		
Ich Time & FFT	3-23, 3-26		
Inband Spurious	3-7, 3-53, 5-13, 5-15		
Inband Spurious Modes	5-14		
Input	3-27, 3-81, 3-83		
Insert Line	3-8, 3-10, 3-11, 3-14, 3-15, 3-17, 3-18, 3-31, 3-37, 3-40, 3-46, 3-47, 3-51, 3-54, 3-57		
INTRODUCTION	1-1		
IQ Complex FFT	3-23, 3-26		
IQ Inverse	3-27, 3-81		
[J]			
Judgment	3-8, 3-9, 3-10, 3-11, 3-12, 3-13, 3-14, 3-16, 3-17, 3-18, 3-32, 3-35, 3-38, 3-40, 3-44, 3-45, 3-48, 3-53, 3-56, 3-57		
[L]			
Link	3-27, 3-80, 3-82		
Load Table	3-10, 3-11,		
		Mag Error vs Symbol	
		Margin ΔX ON/OFF	
		Marker Edit	
		Marker Edit Function	
		MAX[burst (N),burst(N+1)+ dB]	
		Meas Mode	
		Meas Mode NORM/HIGH	
		Measurement of a Signal Containing Multiple Bursts in a Frame (IN GSM)	
		Measurement of a Singal Containing UP LINK/DOWN LINK Bursts in a Frame (IN DECT)	
		Measuring Multi-burst Signals (No External Triggers Available)	
		Measuring the Multi-Burst Signals (Using an External Trigger)	
		Menu Index	
		Menu Map	
		Messages	
		Modulation	
		Modulation (When select to DECT)	
		Modulation (When select to GSM)	
		Modulation Accuracy	
		MS Template	
		Multiplier	
		[M]	
		[N]	
		[O]	
		[P]	
		[Q]	
		[R]	
		[S]	
		[T]	
		[U]	
		[V]	
		[W]	
		[X]	
		[Y]	
		[Z]	
		[A]	
		[B]	
		[C]	
		[D]	
		[E]	
		[F]	
		[G]	
		[H]	
		[I]	
		[J]	
		[K]	
		[L]	
		[M]	
		[N]	
		[O]	
		[P]	
		[Q]	
		[R]	
		[S]	
		[T]	
		[U]	
		[V]	
		[W]	
		[X]	
		[Y]	
		[Z]	
		[A]	
		[B]	
		[C]	
		[D]	
		[E]	
		[F]	
		[G]	
		[H]	
		[I]	
		[J]	
		[K]	
		[L]	
		[M]	
		[N]	
		[O]	
		[P]	
		[Q]	
		[R]	
		[S]	
		[T]	
		[U]	
		[V]	
		[W]	
		[X]	
		[Y]	
		[Z]	
		[A]	
		[B]	
		[C]	
		[D]	
		[E]	
		[F]	
		[G]	
		[H]	
		[I]	
		[J]	
		[K]	
		[L]	
		[M]	
		[N]	
		[O]	
		[P]	
		[Q]	
		[R]	
		[S]	
		[T]	
		[U]	
		[V]	
		[W]	
		[X]	
		[Y]	
		[Z]	
		[A]	
		[B]	
		[C]	
		[D]	
		[E]	
		[F]	
		[G]	
		[H]	
		[I]	
		[J]	
		[K]	
		[L]	
		[M]	
		[N]	
		[O]	
		[P]	
		[Q]	
		[R]	
		[S]	
		[T]	
		[U]	
		[V]	
		[W]	
		[X]	
		[Y]	
		[Z]	
		[A]	
		[B]	
		[C]	
		[D]	
		[E]	
		[F]	
		[G]	
		[H]	
		[I]	
		[J]	
		[K]	
		[L]	
		[M]	
		[N]	
		[O]	
		[P]	
		[Q]	
		[R]	
		[S]	
		[T]	
		[U]	
		[V]	
		[W]	
		[X]	
		[Y]	
		[Z]	
		[A]	
		[B]	
		[C]	
		[D]	
		[E]	
		[F]	
		[G]	
		[H]	
		[I]	
		[J]	
		[K]	
		[L]	
		[M]	
		[N]	
		[O]	
		[P]	
		[Q]	
		[R]	
		[S]	
		[T]	
		[U]	
		[V]	
		[W]	
		[X]	
		[Y]	
		[Z]	
		[A]	
		[B]	
		[C]	
		[D]	
		[E]	
		[F]	
		[G]	
		[H]	
		[I]	
		[J]	
		[K]	
		[L]	
		[M]	
		[N]	
		[O]	
		[P]	
		[Q]	
		[R]	
		[S]	
		[T]	
		[U]	
		[V]	
		[W]	
		[X]	
		[Y]	
		[Z]	
		[A]	
		[B]	
		[C]	
		[D]	
		[E]	
		[F]	
		[G]	
		[H]	
		[I]	
		[J]	
		[K]	
		[L]	
		[M]	
		[N]	
		[O]	
		[P]	
		[Q]	
		[R]	
		[S]	
		[T]	
		[U]	
		[V]	
		[W]	
		[X]	
		[Y]	
		[Z]	
		[A]	
		[B]	
		[C]	
		[D]	
		[E]	
		[F]	
		[G]	
		[H]	
		[I]	
		[J]	
		[K]	
		[L]	
		[M]	
		[N]	
		[O]	
		[P]	
		[Q]	
		[R]	
		[S]	
		[T]	
		[U]	
		[V]	
		[W]	
		[X]	
		[Y]	
		[Z]	
		[A]	
		[B]	
		[C]	
		[D]	
		[E]	
		[F]	
		[G]	
		[H]	
		[I]	
		[J]	
		[K]	
		[L]	
		[M]	
		[N]	
		[O]	
		[P]	
		[Q]	
		[R]	
		[S]	
		[T]	
		[U]	
		[V]	
		[W]	
		[X]	
		[Y]	
		[Z]	
		[A]	
		[B]	
		[C] </	

Alphabetical Index

Offset Level	3-27, 3-81, 3-83	3-25, 3-64, 3-74
ON Position	3-9, 3-34	Preselector
ON Width	3-9, 3-34	3-10, 3-11, 3-18, 3-38, 3-40, 3-57
ON/OFF Ratio	3-7, 3-9, 3-33	Product Overview
OPERATION	2-1	1-1
Outband Spurious	3-7, 3-56	
		[Q]
		Q EYE Diagram
		3-19, 3-20
		Qch Time & FFT
		3-23, 3-26
		[R]
		R.C. Filter
		3-20, 3-62
		RANDOM/STD in the DECT bit sequence
		5-1
		Record Sheet
		6-8
		Ref Power
		3-11, 3-14, 3-16, 3-17, 3-40, 3-48, 3-52, 3-55
		REFERENCE
		3-1
		REMOTE CONTROL
		4-1
		Result
		3-10, 3-11, 3-14, 3-16, 3-17, 3-37, 3-40, 3-48, 3-52, 3-55
		RFP→PP ON/OFF
		3-24, 3-72
		Rolloff Factor
		3-14, 3-16, 3-48, 3-53
		[S]
		Save Table
		3-10, 3-11, 3-18, 3-37, 3-39, 3-57
		Search Level
		3-19, 3-20, 3-21, 3-22, 3-23, 3-60, 3-62, 3-63, 3-65, 3-69
		Select Type
		3-19, 3-20, 3-23, 3-24, 3-26, 3-59, 3-61, 3-67, 3-70, 3-76
		Self Test Function
		1-1
		Set to Default
		3-10, 3-18, 3-38, 3-58
		Set to STD
		3-8, 3-9, 3-11, 3-12, 3-13, 3-14, 3-15, 3-17,
Parameter Setup	3-8, 3-9, 3-10, 3-11, 3-12, 3-13, 3-14, 3-15, 3-17, 3-18, 3-19, 3-20, 3-21, 3-22, 3-23, 3-24, 3-25, 3-26, 3-32, 3-35, 3-37, 3-40, 3-44, 3-45, 3-47, 3-52, 3-55, 3-57, 3-59, 3-61, 3-63, 3-65, 3-67, 3-68, 3-70, 3-72, 3-73, 3-75, 3-76, 3-77	
Peak MKR Y Delta	3-10, 3-17, 3-18, 3-37, 3-55, 3-57	
PERFORMANCE VERIFICATION TEST	6-1	
Performance Verification Test Procedure	6-3	
Phase Error	3-7, 3-19, 3-59	
Phase Error Measurement Accuracy for GSM	6-3	
Phase Error Measurements Compliant With GSM	5-8	
Phase Error vs Bit	3-19	
Phase Error vs Symbol	3-20	
Phase Inverse	3-27, 3-84	
Physical Packet	3-27, 3-82	
Power	3-7	
Power (F-Domain)	3-41	
Power (T-Domain)	3-30	
Power Control Level	3-27, 3-81	
Power Level	3-27, 3-83	
Power vs Time	3-7, 3-22,	

	3-31, 3-33, 3-34, 3-35, 3-39, 3-41, 3-43, 3-44, 3-46, 3-49, 3-50, 3-53, 3-56		
Shift X	3-8, 3-14, 3-15, 3-17, 3-31, 3-46, 3-51, 3-54		
Shift Y	3-8, 3-14, 3-15, 3-17, 3-31, 3-46, 3-51, 3-54		
Slope	3-8, 3-9, 3-10, 3-11, 3-12, 3-15, 3-30, 3-34, 3-36, 3-39, 3-42, 3-50		
Slot Length	3-22, 3-66		
Slot Number	3-19, 3-20, 3-21, 3-22, 3-23, 3-60, 3-62, 3-64, 3-66, 3-68, 3-69		
Sort	3-8, 3-14, 3-15, 3-17, 3-31, 3-47, 3-51, 3-54		
SPECIFICATIONS	7-1		
Spurious	3-7		
Spurious (T-Domain)	3-36		
Start Bit	3-24, 3-70		
STD	3-7, 3-23, 3-26, 3-79		
STD Setup	3-7, 3-23, 3-26, 3-79		
STD Template	3-22, 3-25, 3-64, 3-74		
Sweep Time	3-23, 3-26, 3-68, 3-77		
Symbol Rate 1/T	3-14, 3-16, 3-48, 3-53		
Sync Type	3-27, 3-80, 3-82		
[T]			
Table Edit	3-10, 3-11, 3-18, 3-37, 3-39, 3-57	Table Init	3-8, 3-10, 3-11, 3-14, 3-15, 3-17, 3-18, 3-31, 3-37, 3-40, 3-47, 3-51, 3-54, 3-57
		Table No. 1/2/3	3-10, 3-11, 3-18, 3-36, 3-37, 3-39, 3-56, 3-57
		TDMA Structure	3-19, 3-20, 3-21, 3-22, 3-23, 3-60, 3-62, 3-64, 3-66, 3-68, 3-69
		T-Domain	3-7, 3-29
		T-DOMAIN Power	5-4
		TECHNICAL INFORMATION	5-1
		Template	3-8, 3-14, 3-15, 3-17, 3-31, 3-46, 3-51, 3-54
		Template Couple to Power	3-8, 3-14, 3-16, 3-17, 3-32, 3-48, 3-53, 3-56
		Template Edit	3-8, 3-14, 3-15, 3-17, 3-31, 3-46, 3-51, 3-54
		Template Edit function	5-9
		Template Entry	3-22, 3-25, 3-64, 3-74
		Template Limit	3-8, 3-14, 3-16, 3-17, 3-32, 3-48, 3-53, 3-56
		Template ON/OFF	3-8, 3-15, 3-17, 3-31, 3-46, 3-51, 3-54
		Template Setting in the F-Domain Measuring Mode	5-11
		Template Setting in the T-Domain Measuring Mode	5-9
		Template UP/LOW	3-8, 3-31
		Test Equipment	6-1
		Time	3-23, 3-26, 3-68, 3-77
		Time & FFT	3-23, 3-26, 3-67, 3-76

Alphabetical Index

Timing Jitter	3-7, 3-24, 3-72	3-74, 3-75, 3-77, 3-78
Trellis	3-19	
Trigger	3-12, 3-15, 3-42, 3-50	Trigger Source
Trigger Delay	3-19, 3-20, 3-21, 3-22, 3-23, 3-24, 3-25, 3-26, 3-60, 3-62, 3-64, 3-66, 3-68, 3-69, 3-71, 3-73, 3-74, 3-75, 3-77, 3-78	3-8, 3-9, 3-10, 3-11, 3-12, 3-15, 3-19, 3-20, 3-21, 3-22, 3-23, 3-24, 3-25, 3-26, 3-30, 3-33, 3-36, 3-39, 3-42, 3-49, 3-59, 3-61, 3-63, 3-65, 3-67, 3-69, 3-70, 3-72, 3-73, 3-75, 3-76, 3-78
Trigger Level	3-8, 3-9, 3-10, 3-11, 3-12, 3-15, 3-19, 3-20, 3-21, 3-22, 3-23, 3-24, 3-25, 3-26, 3-30, 3-34, 3-36, 3-39, 3-42, 3-50, 3-60, 3-62, 3-63, 3-66, 3-68, 3-69, 3-71, 3-73, 3-74, 3-75, 3-77, 3-78	TSC
Trigger Position	3-8, 3-9, 3-10, 3-11, 3-12, 3-15, 3-23, 3-26, 3-30, 3-34, 3-36, 3-39, 3-42, 3-50, 3-69, 3-78	Tx Power
Trigger Setup	3-8, 3-9, 3-10, 3-11, 3-12, 3-15, 3-30, 3-33, 3-36, 3-39, 3-42, 3-49	Type
Trigger Slope	3-19, 3-20, 3-21, 3-22, 3-23, 3-24, 3-25, 3-26, 3-60, 3-62, 3-63, 3-65, 3-67, 3-69, 3-71, 3-72,	3-27, 3-80 3-7, 3-21, 3-25, 3-63, 3-73 3-27, 3-79, 3-82
		[U]
		Upper Limit
		User Template1
		User Template2
		User Template3
		[W]
		Wave Check
		Window ON/OFF
		Window Position
		Window Setup
		Window Width

[Y]

Y [dB/div] 20/10/5	3-22, 3-25, 3-65, 3-74
Y Scale [dB/div] 10/5/2	3-8, 3-9, 3-12, 3-31, 3-34, 3-43

[Z]

Z-Field	3-27, 3-82
---------------	------------

IMPORTANT INFORMATION FOR ADVANTEST SOFTWARE

PLEASE READ CAREFULLY: This is an important notice for the software defined herein. Computer programs including any additions, modifications and updates thereof, operation manuals, and related materials provided by ADVANTEST (hereafter referred to as "SOFTWARE"), included in or used with hardware produced by ADVANTEST (hereafter referred to as "PRODUCTS").

SOFTWARE License

All rights in and to the SOFTWARE (including, but not limited to, copyright) shall be and remain vested in ADVANTEST. ADVANTEST hereby grants you a license to use the SOFTWARE only on or with ADVANTEST PRODUCTS.

Restrictions

- (1) You may not use the SOFTWARE for any purpose other than for the use of the PRODUCTS.
- (2) You may not copy, modify, or change, all or any part of, the SOFTWARE without permission from ADVANTEST.
- (3) You may not reverse engineer, de-compile, or disassemble, all or any part of, the SOFTWARE.

Liability

ADVANTEST shall have no liability (1) for any PRODUCT failures, which may arise out of any misuse (misuse is deemed to be use of the SOFTWARE for purposes other than it's intended use) of the SOFTWARE. (2) For any dispute between you and any third party for any reason whatsoever including, but not limited to, infringement of intellectual property rights.

LIMITED WARRANTY

1. Unless otherwise specifically agreed by Seller and Purchaser in writing, ADVANTEST will warrant to the Purchaser that during the Warranty Period this Product (other than consumables included in the Product) will be free from defects in material and workmanship and shall conform to the specifications set forth in this Operation Manual.
2. The warranty period for the Product (the "Warranty Period") will be a period of one year commencing on the delivery date of the Product.
3. If the Product is found to be defective during the Warranty Period, ADVANTEST will, at its option and in its sole and absolute discretion, either (a) repair the defective Product or part or component thereof or (b) replace the defective Product or part or component thereof, in either case at ADVANTEST's sole cost and expense.
4. This limited warranty will not apply to defects or damage to the Product or any part or component thereof resulting from any of the following:
 - (a) any modifications, maintenance or repairs other than modifications, maintenance or repairs (i) performed by ADVANTEST or (ii) specifically recommended or authorized by ADVANTEST and performed in accordance with ADVANTEST's instructions;
 - (b) any improper or inadequate handling, carriage or storage of the Product by the Purchaser or any third party (other than ADVANTEST or its agents);
 - (c) use of the Product under operating conditions or environments different than those specified in the Operation Manual or recommended by ADVANTEST, including, without limitation, (i) instances where the Product has been subjected to physical stress or electrical voltage exceeding the permissible range and (ii) instances where the corrosion of electrical circuits or other deterioration was accelerated by exposure to corrosive gases or dusty environments;
 - (d) use of the Product in connection with software, interfaces, products or parts other than software, interfaces, products or parts supplied or recommended by ADVANTEST;
 - (e) the occurrence of an event of force majeure, including, without limitation, fire, explosion, geological change, storm, flood, earthquake, tidal wave, lightning or act of war; or
 - (f) any negligent act or omission of the Purchaser or any third party other than ADVANTEST.
5. **EXCEPT TO THE EXTENT EXPRESSLY PROVIDED HEREIN, ADVANTEST HEREBY EXPRESSLY DISCLAIMS, AND THE PURCHASER HEREBY WAIVES, ALL WARRANTIES, WHETHER EXPRESS OR IMPLIED, STATUTORY OR OTHERWISE, INCLUDING, WITHOUT LIMITATION, (A) ANY WARRANTY OF MERCHANTABILITY OR FITNESS FOR A PARTICULAR PURPOSE AND (B) ANY WARRANTY OR REPRESENTATION AS TO THE VALIDITY, SCOPE, EFFECTIVENESS OR USEFULNESS OF ANY TECHNOLOGY OR ANY INVENTION.**
6. **THE REMEDY SET FORTH HEREIN SHALL BE THE SOLE AND EXCLUSIVE REMEDY OF THE PURCHASER FOR BREACH OF WARRANTY WITH RESPECT TO THE PRODUCT.**
7. **ADVANTEST WILL NOT HAVE ANY LIABILITY TO THE PURCHASER FOR ANY INDIRECT, INCIDENTAL, SPECIAL, CONSEQUENTIAL OR PUNITIVE DAMAGES, INCLUDING, WITHOUT LIMITATION, LOSS OF ANTICIPATED PROFITS OR REVENUES, IN ANY AND ALL CIRCUMSTANCES, EVEN IF ADVANTEST HAS BEEN ADVISED OF THE POSSIBILITY OF SUCH DAMAGES AND WHETHER ARISING OUT OF BREACH OF CONTRACT, WARRANTY, TORT (INCLUDING, WITHOUT LIMITATION, NEGLIGENCE), STRICT LIABILITY, INDEMNITY, CONTRIBUTION OR OTHERWISE.**

CUSTOMER SERVICE DESCRIPTION

In order to maintain safe and trouble-free operation of the Product and to prevent the incurrence of unnecessary costs and expenses, ADVANTEST recommends a regular preventive maintenance program under its maintenance agreement.

ADVANTEST's maintenance agreement provides the Purchaser on-site and off-site maintenance, parts, maintenance machinery, regular inspections, and telephone support and will last a maximum of ten years from the date the delivery of the Product. For specific details of the services provided under the maintenance agreement, please contact the nearest ADVANTEST office listed at the end of this Operation Manual or ADVANTEST's sales representatives.

Some of the components and parts of this Product have a limited operating life (such as, electrical and mechanical parts, fan motors, unit power supply, etc.). Accordingly, these components and parts will have to be replaced on a periodic basis. If the operating life of a component or part has expired and such component or part has not been replaced, there is a possibility that the Product will not perform properly. Additionally, if the operating life of a component or part has expired and continued use of such component or part damages the Product, the Product may not be repairable. Please contact the nearest ADVANTEST office listed at the end of this Operation Manual or ADVANTEST's sales representatives to determine the operating life of a specific component or part, as the operating life may vary depending on various factors such as operating condition and usage environment.

CLAIM FOR DAMAGE IN SHIPMENT TO ORIGINAL BUYER

The product should be thoroughly inspected immediately upon original delivery to buyer. All material in the container should be checked against the enclosed packing list or the instruction manual alternatively. ADVANTEST will not be responsible for shortage unless notified immediately.

If the product is damaged in any way, a claim should be filed by the buyer with carrier immediately. (To obtain a quotation to repair shipment damage, contact ADVANTEST or the local supplier.) Final claim and negotiations with the carrier must be completed by buyer.

SALES & SUPPORT OFFICES

Advantest America Measuring Solutions, Inc. (North America)

New Jersey Office

258 Fernwood Avenue, Edison, NJ 08837

Phone: (1) (732) 346-2600 Facsimile: (1) (732) 346-2610

Santa Clara Office

3201 Scott Blvd., Santa Clara, CA 95054

Phone: (1) (408) 988-7700 Facsimile: (1) (408) 987-0688

ROHDE & SCHWARZ Engineering and Sales GmbH (Europe)

Mühlldorfstraße 15, D-81671 München, Germany

P.O.B. 80 14 29, D-81614 München, Germany

Phone: (49) (89) 4129-13711 Facsimile: (49) (89) 4129-13723

Advantest (Singapore) Pte. Ltd. (Singapore)

438A Alexandra Road, #8-03/06

Alexandra Technopark, Singapore 119967

Phone: (65) (6) 274-3100 Facsimile: (65) (6) 274-4055

Advantest Korea Co., Ltd. (Korea)

16Fl., MIRAEWASARAM Bldg., 942-1

Daechi-Dong, Kangnam-Ku, Seoul, Korea

Phone: (82) (02) 3452-7710 Facsimile: (82) (02) 3452-7970

Advantest (Suzhou) Co., Ltd. (China)

5F, No. 46 Factory Building,

No. 555 Gui Ping Road, Shanghai, China 200233

Phone: (86) (21) 6485-2725 Facsimile: (86) (21) 6485-2726

Technology Support on the Leading Edge

ADVANTEST®

ADVANTEST CORPORATION

Shinjuku-NS Building, 4-1, Nishi-Shinjuku 2-chome, Shinjuku-ku, Tokyo 163-0880, Japan
Phone:+81-3-3342-7500 Facsimile:+81-3-5322-7270 Telex:232-4914 ADVAN J