

TABLE OF CONTENTS

1. GENERAL

2. PANELS

3. BASIC OPERATIONS

4. EXAMPLES OF MEASUREMENT

5. EXPLANATION OF FUNCTIONS

6. GPIB:REMOTE PROGRAMMING

7. INSPECTION

8. OPERATION DESCRIPTION

9. SPECIFICATIONS

APPENDIX

TABLE OF CONTENTS

1. GENERAL	1-1
1.1 Outline of the Analyzer	1-2
1.2 Preparations before Using the Analyzer	1-4
1.2.1 Checking Accessories	1-4
1.2.2 Environmental Conditions	1-5
1.2.3 Storage, Cleaning and Transportation of the Analyzer	1-6
1.2.4 Power Source	1-7
2. PANELS	2-1
2.1 Front Panel	2-2
2.2 Rear Panel	2-7
3. BASIC OPERATIONS	3-1
3.1 Panel keys and Softkeys.	3-2
3.2 Screen Annotation (comments)	3-4
3.3 Basic Measurement	3-5
4. EXAMPLES OF MEASUREMENT	4-1
4.1 Measuring Frequency	4-2
4.2 Measuring AM Signal Modulation Frequency and Modulation Index ..	4-6
4.3 Measuring FM Wave	4-11
4.4 Measuring Pulse-Modulated Wave	4-19
4.5 Measuring Occupied bandwidth (OBW)	4-21
4.6 Measuring Adjacent Channel Leak Power (ADJ)	4-24
4.7 Analyzing Burst Signal Spectrum	4-29
5. EXPLANATION OF FUNCTIONS	4-1
5.1 Basic Key Functions	5-2
5.1.1 Center Frequency	5-2
5.1.2 Frequency Span	5-9
5.1.3 Start and Stop Frequency	5-11
5.1.4 Reference Level	5-12
5.1.5 Couple (Interlocked functions)	5-14
5.1.6 Menu Key	5-20

5.2 TRACE Section Functions	5-27
5.3 MARKER Section Functions	5-34
5.3.1 Marker ON	5-34
5.3.2 Peak Search	5-44
5.3.3 Marker (Marker to)	5-50
5.3.4 Marker OFF	5-51
5.3.5 Multi Marker Function	5-52
5.4 User-Defined Functions	5-57
5.5 Memory Card Function	5-60
5.5.1 Memory Card Initialization and Soft Menu Save/Recall	5-60
5.5.2 Saving and Reading the Internal Back-up Memory Data	5-65
5.5.3 How to Handle the Memory Card	5-67
5.6 Save and Recall Functions	5-69
5.6.1 Save Function	5-70
5.6.2 Recall Function	5-82
5.7 Preset and Last State Functions	5-86
5.7.1 Preset	5-86
5.7.2 Last State	5-87
5.8 Calibration Function	5-88
5.9 Plot Output Function	5-91
5.10 Label Function	5-98
5.11 EMC Function	5-101
5.12 Date Function	5-111
5.13 Utility Function	5-112
5.14 Measurement Window Function	5-115
6. GPIB: REMOTE PROGRAMMING	6-1
6.1 Outline of GPIB	6-2
6.2 GPIB Specifications and the Analyzer GPIB Specifications	6-4
6.3 GPIB Setting	6-8
6.3.1 Setting the GPIB Address	6-8
6.3.2 Delimiter	6-8
6.3.3 Input/Output format	6-8
6.4 Input Format (Listener)	6-9
6.5 Output format (Talker)	6-15
6.6 Input and Output of Trace Data	6-20
6.7 Service Request (SRQ)	6-27
6.8 List of GPIB Codes	6-34

7. INSPECTION	7-1
7.1 Inspection and Brief Diagnosis	7-2
8. OPERATION DESCRIPTION	8-1
8.1 Operations on Block Basis	8-2
8.2 Block Diagram	8-4
9. SPECIFICATIONS	9-1
9.1 R3265 Specifications	9-2
9.2 R3271 Specifications	9-9
APPENDIX	A-1
Appendix 1 Explanation on the technical Terms	A-1
Appendix 2 Level Scalings	A-8
Appendix 3 Menu Lists	A-9
Appendix 4 List of Messages	A-13

LIST OF ILLUSTRATIONS

No.	Title	Page
1-1	Environmental Conditions	1-5
1-2	Checking the Fuse	1-7
1-3	Power Cable Plug and Adapter	1-8*
2-1	Front Panel	2-5
2-2	Rear Panel	2-9*
3-1	Screen Annotation	3-4
3-2	Wiring	3-5
3-3	Initial Screen (R3271)	3-5
3-4	Setting the center frequency	3-6
3-5	Setting the span	3-6
3-6	Peak marker	3-7*
4-1	Measuring frequency with normal marker	4-2
4-2	Measuring frequency in Frequency counter mode	4-3
4-3	Measuring frequency in Marker counter mode	4-5
4-4	Measuring AM signal	4-6
4-5	Modulation frequency of the AM modulation	4-8
4-6	AM modulation index	4-8
4-7	AM wave with high modulation frequency and small modulation index	4-10
4-8	Side band level - Relationships between the carrier level value ($E_{SB} - E_C$) and the modulation index m (%)	4-10
4-9	Measuring FM signal	4-11
4-10	FM wave with low modulation frequency	4-14
4-11	FM wave with high modulation frequency and small m	4-15
4-12	FM wave with small Δf_{peak}	4-16
4-13	FM wave with large Δf_{peak}	4-17
4-14	FM wave f_c and E_c	4-18
4-15	FM wave f_{SB} and E_{SB}	4-18
4-16	Pulse-modulated wave	4-19
4-17	Measuring OBW	4-22
4-18	Measuring the adjacent channel leak power (ADJ POINT)	4-26
4-19	Measuring the adjacent channel leak power (ADJ GRAPH)	4-27
5-1-2	Entering the External Mixer Correction Data	5-7
5-1-3	Frequency Span	5-9
5-1-4	Start/Stop Frequency	5-11
5-1-5	Reference Level	5-12
5-1-6	RBW: The Maximum IF Bandwidth which can be Separated as Two Signals	5-14

5.1-7	VBW = 300kHz	5-15
5.1-8	VBW = 3kHz	5-15
5.1-9	SWP = AUTO (500ms)	5-16
5.1-10	SWP = 50ms	5-16
5.1-11	Trigger on the Waveform on the Screen	5-20
5.1-12	Setting the Squeich Level	5-23
5.2-1	Basic Waveform in VIEW Mode	5-28
5.2-2	Second Higher Harmonics in WRITE B	5-28
5.2-3	AVG = None	5-30
5.2-4	ABG = 31 st	5-30
5.3-1	Normal Marker	5-35
5.3-2	Delta (Δ) Marker	5-35
5.3-3	Noise/Hz Level Measurement	5-38
5.3-4	XdB Down	5-40
5.3-5	Executing the AUTO PEAKING	5-42
5.3-6	Peak Search Screen	5-44
5.3-7	Δ X and Δ Y Resolution	5-46
5.3-8	Setting Δ X and Δ Y	5-46
5.3-9	NEXT PK when NORM is selected	5-47
5.3-10	NEXT PK when UP is selected	5-47
5.3-11	NEXT PK when LOW is selected	5-47
5.3-12	Listing in the Order of Levels	5-48
5.3-13	Listing with NEXT PK RIGHT specified	5-49
5.3-14	Setting MKR \rightarrow CF	5-50
5.3-15	Multi Marker Display	5-52
5.3-16	Multi Marker Listing	5-52
5.3-17	An Example of Delta Marker Listing	5-54
5.3-18	An Example of Listing with Display Line	5-54
5.4-1	User-Defined Display	5-57
5.5-1	External View of Memory Card	5-60
5.5-2	Inserting and Removing the Memory Card	5-61
5.5-3	Initializing the Memory Card	5-63
5.5-4	Memory Card Battery Replacement	5-67
5.6-1	List of Saved Data	5-70
5.6-2	Explanation of the List	5-71
5.6-3	Data in Detail	5-75
5.6-4	Entering the title of the saved data	5-76
5.6-5	Selecting the Data to be saved	5-79
5.6-6	Listing the Initialization data	5-80
5.6-7	Recall Data List	5-82
5.6-8	Recall Data in Detail	5-84
5.9-1	Plotter Connection	5-91
5.9-2	Dip Switch Setting	5-92

	Plotter Operation Screen	5-92
9-3	Plotter error Message	5-96
9-4	Label Display	5-99
10-1	TR1722 Antenna Factor	5-102
11-1	Entering a Limit Line	5-104
11-2	Measuring the Power Source Terminal Voltage	5-109
11-3	Waveform to determine the OBW	5-112
13-1	Adjacent channel leak power in graph	5-112
13-2	Initial screen of Measurement window	5-115
14-1	Partial Sweep within a Window	5-118
14-2	Peak Search within a Window	5-119*
14-3		
	GPIB Bus Line Configuration	6-4
2	GPIB Connector Pin Assignment	6-5
3	Signal Line Termination	6-6

LIST OF TABLES

No.	Title	Page
1-1	Accessories	1-4
1-2	Power Supply Conditions	1-7
5.1-1	Center Frequency Display Resolution	5-3
5.1-2	External Mixer Frequency Bandwidth which Can be Set	5-5
5.1-3	Frequency Span Display Resolution	5-9
5.1-4	RBW Automatically Selected	5-15
5.1-5	Function which Cannot be Used in Digital IF	5-19
5.9-1	Plotters which can be connected	5-91
5.9-2	Plotter Pen Assignment	5-97
5.11-1	RBW according to the CISPR specification	5-103
6-1	Analyzer GPIB Interface Functions	6-7
6-2	Delimiter Specification Codes	6-8
6-3	Trace Accuracy Specification Codes	6-20
6-4	SRQ ON/OFF Specification codes	6-27
6-5	Trace Accuracy Specification Codes	6-27
6-6	List of Typical Functions for Data Entry (GPIB codes with asterisk)	6-70

1. GENERAL

This chapter describes the outline of the analyzer and cautions at setup until power is turned on.
Do read this chapter before starting to use the analyzer.

Table of Contents

1.1	Outline of the Analyzer	1-2
1.2	Preparations before Using the Analyzer	1-4
1.2.1	Checking Accessories	1-4
1.2.2	Environmental Conditions	1-5
1.2.3	Storage, Cleaning and Transportation of the Analyzer	1-6
1.2.4	Power Source	1-7

1. GENERAL

1.1 Outline of the Analyzer

The R3265/3271 series spectrum analyzer which employs synthesized local oscillation assures high stability in spectrum analysis.

Frequency range	:	100Hz to 8.0 GHz (R3265)
		100Hz to 26.5GHz (R3271)
Input range	:	-140dBm to +30dBm (R3265)
		-135dBm to +30dBm (R3271)
Display range	:	95dB

In the wide range as described above, the analyzer features the following basic performances: maximum resolution 10Hz, residual FM 3Hz_{p-p} and noise sideband -112dBc/Hz (at 10kHz from the carrier). It is equipped with full remote control GPIB and memory card function for saving/recalling waveform data and panel setting conditions.

Features of the Analyzer

- ① The analyzer permits sweeping over a wide frequency range at once: from 100Hz to 26.5GHz (R3271); from 100Hz to 8GHz (R3265). Log sweep is also enabled in the range from 1kHz to 1GHz.
- ② High frequency resolution of 10Hz at maximum permits analysis of adjacent signals and spurious at high frequency.
- ③ High-precision frequency measurement
The built-in reference crystal oscillator with aging rate of 2×10^{-8} /day permits to measure very weak signals such that cannot be measured by any counter, at a resolution of 1Hz in the counter mode of frequency measurement.
- ④ Setting conditions and waveform data can be stored by using memory card.
- ⑤ The electric field strength can be viewed and read directly after compensating the antenna calibration coefficient, and the QP value based on the CISPR specification can be observed directly.
- ⑥ Various enhanced functions supported by digital indications
The information required for spectrum analysis is entirely displayed on the CRT together with signal traces. The digital memory screen realizes flickerless display. Various marker functions assures accurate and easy reading even in the manual mode.
- ⑦ Sweep time of 50 μ s can be set in the ZERO SPAN mode, which facilitates analysis of the burst wave on the time axis.

R3265/3271
SPECTRUM ANALYZER
INSTRUCTION MANUAL

1.1 *Outline of the Analyzer*

- ⑨ Two independent channels of digital memory enable simultaneous display of two screens.
- ⑨ A full-remote GPIB is used as a powerful measurement system component.

1.2 Preparations before Using the Analyzer

1.2.1 Checking Accessories

- ① Upon receipt of the analyzer, check for any damages or imperfections.
- ② Check the quantity and specification of the accessories according to Table 1-1. If any part is damaged or missing, contact ATCE or the nearest support office. Their addresses and phone numbers are given at the end of this instruction manual. When ordering the any additional accessories, do not forget to specify the type name (or stock No.).

Table 1-1 Accessories

Part Name	Specification		Quantity		Remarks
	Type code	Stock No.	R3265	R3271	
Power cable	A01412	DCB-DD3130×01	1	1	
Input cable	MI-09	DCB-FF0392	1	1	
	MC-61	DCB-FF0383	1	1	
N-BNC conversion adapter	JUG-201A/V	JCF-AF001E×3	1	1	
Power fuse		DFT-AA6R3A	2	2	
Memory card	-	SEE-MAC1101BAB	1	1	
Instruction manual	-	JR3265/3271	1	1	Japanese version
	-	ER3265/3271			English version

1.2.2 Environmental Conditions

- (1) Do not use the analyzer in a place exposed to direct sunlight, dust, corrosive gas, or vibration.
- (2) The operation temperature allowed for the analyzer is 0°C to +50°C and the humidity allowed is 85% or below.
- (3) The analyzer storage temperature allowed is -20°C to +60°C.
If the analyzer is not used for a long time, wrap it with a vinyl cover or put it in corrugated cardboard box.
Store it in a dry place not exposed to direct sunlight.
- (4) The analyzer is designed with consideration against noise from the AC power line. However, it is recommended to use it in a place with minimum noise. If the noise is unavoidable, use a noise suppressing filter.

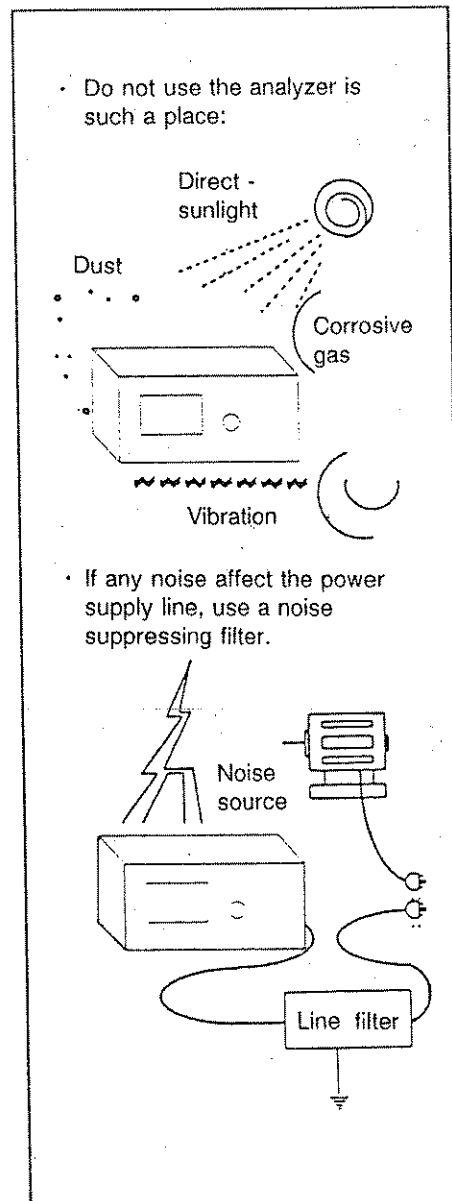

Fig.1-1 Environmental Conditions

1.2.3 Storage, Cleaning and Transportation of the Analyzer

(1) Storage of the Analyzer

The analyzer storage temperature should be in the range from -20°C to $+60^{\circ}\text{C}$. If the analyzer is not used for a long time, wrap it with a vinyl cover or put it into a corrugated cardboard box, and store it in a dry place not exposed to direct sunlight.

(2) Cleaning of the Analyzer

The filter protecting the CRT display should be cleared periodically with a soft cloth dipped in alcohol. Never dip the cloth other than in alcohol.

Normally, cleaning of the filter surface is enough. However, when the CRT display screen itself is found to be dirty, remove the bezel and clean the CRT display surface with a soft cloth dipped in alcohol in the same way as when cleaning the filter surface.

CAUTION

When cleaning the analyzer, never use solvent which affects plastic such as benzene, toluene and acetone.

(3) Transportation of the Analyzer

When the analyzer is to be transported, put it in the packing box which was used when the analyzer was shipped from the factory or in the box equivalent to it.

If the box and packing material are missing, prepare a corrugated cardboard box with thickness of 5mm or above and pack the analyzer with shock-absorbing material before putting it into the box.

After packing the analyzer with shock-absorbing material, place the accessories and shock absorbing material, close the corrugated cardboard box, and bind the outside with the packing tape and fasteners.

1.2.4 Power Source

1. The analyzer may be damaged if the power supply conditions listed in Table 1-2 are not satisfied.
2. The analyzer may be damaged if the fuse rating is not as specified.

(1) Power requirement

Power supply conditions are specified in Table 1-2.

Table 1-2 Power Supply Conditions

Power	Condition	
Input voltage	90V to 132Vrms	198V to 250Vrms
Frequency	48 to 440Hz	48 to 66Hz
Power consumption	400VAC or below	

(2) Checking the Fuse

The fuse rating of the AC power line is 6.3A/250V for either of the input voltage ranges 90 to 132V or 198 to 250V.

Check the Fuse in power connector of rear panel.

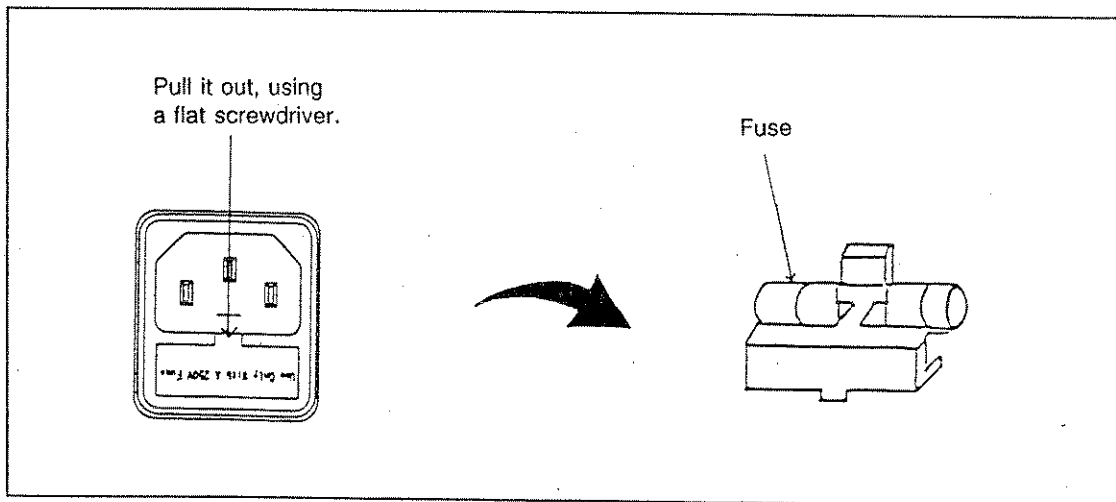

Fig.1-2 Checking the Fuse

(3) Checking the Power Cable

The power cable plug is three-pin type and the round pin at the center is used for grounding. When using a two-pin adapter for connection to the receptacle, connect the grounding lead wire from the adapter or the grounding terminal on the rear panel of the analyzer to an external grounding terminal.

The adapter A09034 (KPR-18) conforms to the Electric Equipment regulations. The two pins of the adapter have different widths as shown in Fig.1-3 (b). When inserting it in the receptacle, check the plug and receptacle directions. If the A09034 cannot be inserted into the receptacle, use the optionally available adapter KPR-13.

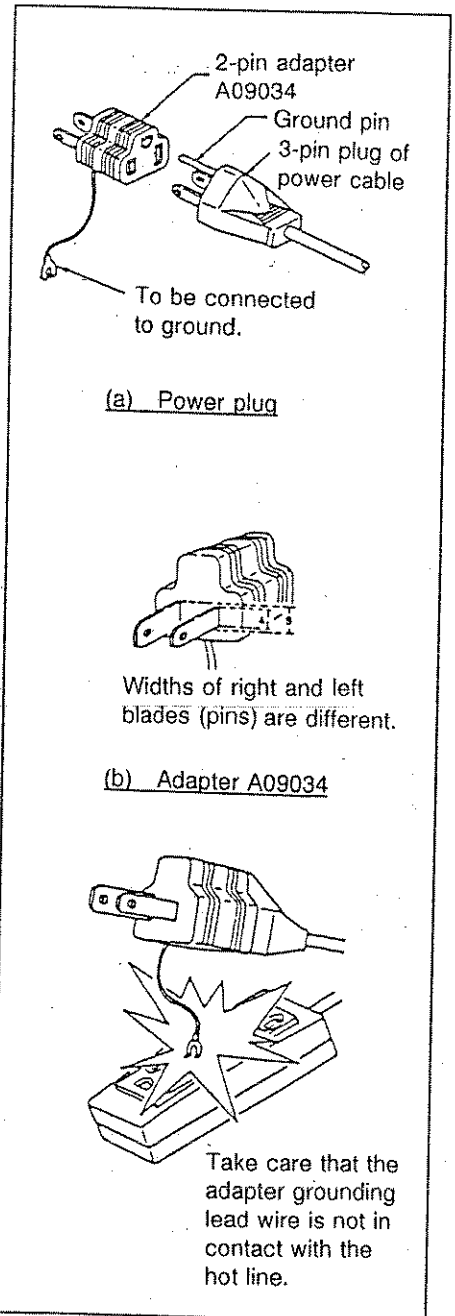

Fig.1-3 Power Cable Plug and Adapter

PANELS

This chapter gives brief explanation of the analyzer panels.

Table of Contents

1 Front Panel	2-2
2 Rear Panel	2-7

2. PANELS

2.1 Front Panel

- ① Power switch : Supplies or cuts power.
- ② Memory card insertion slot
- ③ Eject button : When pressed, the memory card is ejected.
- ④ DRIVE lamp : Lit while the memory card is operating.
- ⑤ 1st I/O OUT connector : The output connector of the 1st block oscillator to be connected with the external mixer.
- ⑥ INTENSITY knob : Adjusts the CRT brightness.
- ⑦ PHONE terminal : An 8Ω ear phone jack.
- ⑧ PROBE POWER : Power source for the accessories such as active probe.
Note: The output current should be $\pm 150\text{mA}$ or below.

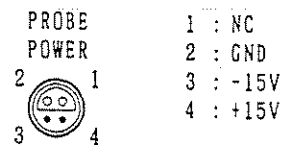

- ⑨ CAL OUT connector : Outputs signals for automatic level calibration.
- ⑩ INPUT connector : N-type input connector.
In the case of R3271, the connector changes into the SMA connector if the N-type connector is removed.
- ⑪ CRT display : Displays waveforms and measurement data.
- ⑫ Softkey menu display section : Displays up to seven items.
- ⑬ Softkeys : There are seven softkeys which correspond to the softkey menu at the left-hand.

MAIN FUNCTION

- ⑭ CENTER FREQUENCY key : Selects the input mode of the center frequency.
- ⑮ FREQUENCY SPAN key : Selects the input mode of the frequency span.
- ⑯ START key : Selects the input mode of the sweep starting frequency.
- ⑰ STOP key : Selects the input mode of the sweep end frequency.
- ⑱ COUPLE key : Used to specify the resolution bandwidth, video band width, sweep time and input attenuator.
- ⑲ REFERENCE LEVEL key : Selects the input mode of the reference level.
- ㉑ MENU key : Used to select trigger, detector, sweep, display line or tracing.
- ㉒ SWEEP lamp : Lit while sweep is in progress.

TRACE Section

- ㉔ A-key
 - ㉕ B-key
- } : Control trace memory.
The LED are lit in every mode excluding VIEW,BLANK.

GPIB Section

- ㉖ LCL key : Releases external control.
- ㉗ REMOTE lamp : Lit while the analyzer is control.

- ⑳ USER key : The function of this key can be defined by the user.
DEFINE (SHIFT + USER) key: Used when the user defines the function.
- ㉑ RECALL key : Used to call the setting conditions saved.
SAVE (SHIFT + RECALL) key : Used to save the currently set conditions.
- ㉒ SHIFT key : Selects the shift mode (key extension function).
(The LED goes on when this mode is selected.)
- ㉓ PRESET key : Initializes the analyzer.

MARKER Section

- ㉔ ON key : Displays a marker for direct read of the waveform data.
- ㉕ PEAK key : Shifts the marker to the highest level (peak) on the screen.
- ㉖ MKR →(marker to) key : Moves the value of the marker point to another function.
- ㉗ OFF key : Deletes the marker display.

DATA Section

- ㉘ Data knob : Used to adjust data input in jog mode.
- ㉙ Step key : Used for step input of data.
- ㉚ Ten key : Consists of numeric keys (0 to 9) and decimal point key (.).
- ㉛ Back space key : Used to correct input data of ten-key operation.
- ㉜ Unit key : Selects a unit and enters the set value.

Rear Panel

① SERIAL I/O (Optional)

② GPIB connector : Terminal to connect the analyzer with the GPIB cable to an external controller and plotter.

③ Controller output terminal (optional)

④ X, 2V/nGHz output terminal : Outputs lamp voltage in proportion to the sweep of about -5V to +5V, or 2V voltage per 1GHz of tuning frequency.

This output can be selected with the softkey **REAR PNL OUT** in the **MENU** key.
The output impedance is approximately 1k Ω .

⑤ Y output terminal

: Outputs video signals in detection in proportion to trace vertical deflection.

Output voltage: Approx. 0 to 2V
Output impedance: Approx. 220 Ω

⑥ Z output terminal

: Outputs +5V (TTL High level) while the spectrum analyzer is sweeping and 0V (TTL Low level) at retrace.

⑦ Output terminal to an external CRT display and VIDEO printer

: The output impedance is approximately 75 Ω and contains 1V_{p,p} composite signal.

⑧ External trigger

: After **EXT TRIG** in the softkey menu displayed with the **MENU** key is selected, sweep starts at the rise or trailing edge of the external input signal (can be selected).

⑨ Gated sweep control terminal

: Stops sweep and measurement at TTL Low level, and executes sweep and measurement at TTL High level.

- ⑩ Reference frequency signal input/output terminal : Input or Output is selected with the softkey menu displayed by [CENTER FREQ] key operation.
Output: Approx. 0dBm
Input: Approx. -5dBm to +5dBm.
 - ⑪ 21.4 MHz IF OUT : Outputs final IF (21.4 MHz) signals.
Bandwidth Resolution band width specified
Output level: Approx. 0dBm at full scale on the CRT
Output impedance: Approx. 50Ω
 - ⑫ 421.4 MHz IF OUT : Outputs 2nd IF (421.4 MHz) signals.
Output impedance: Approx. 50Ω.
 - ⑬ PARALLEL I/O : optional
 - ⑭
- CAUTION

For continued protection against fire hazard, replace the fuse with the same type and specification.
FOR CONTINUED PROTECTION AGAINST FIRE HAZARD.
REPLACE FUSE WITH SAME TYPE AND RATING.
- ⑮ Indication of installed optional parts
 - ⑯
- CAUTION

Panel opening is allowed only for the trained service personnel.
INSIDE ENTRY BY TRAINED SERVICE PERSONNEL ONLY.
- ⑰ Cooling fan : A cooling fan that blows air out.
 - ⑱ AC power connector : An connector having three pins. The lower central pin is used for grounding. Pull out the upper lid to remove the power fuse.
 - ⑲ Ground terminal : Used to connect the analyzer unit to the ground when neither 3-pin connector or 2-pin adapter for power cable cannot be used.

3. BASIC OPERATIONS

This chapter is edited for the beginners to get acquainted with the basic operations of the analyzer.

Table of Contents

3.1 Panel keys and Softkeys.	3-2
3.2 Screen Annotation (comments)	3-4
3.3 Basic Measurement	3-5

3. BASIC OPERATIONS

3.1 Panel keys and Softkeys

The manual operation of the analyzer is performed with the panel keys and softkeys

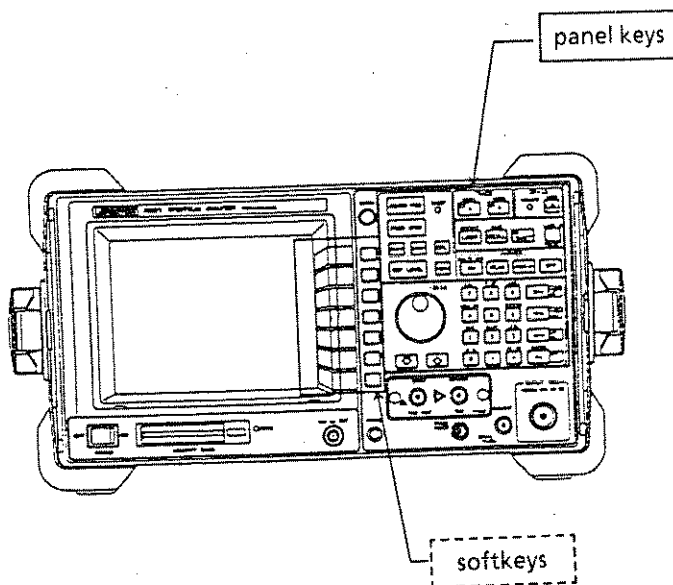

(1) panel keys

For the function described in blue color on the key, press the SHIFT key at first.

Example:

SHIFT MULTI MKR ON (Setting the multi-marker.)

(2) Softkeys

FREQ OPS
ON OFF

Switched ON and OFF every time the key is pressed.
Reversed indication is active.

(3) Data setting

Data can be set by three ways.

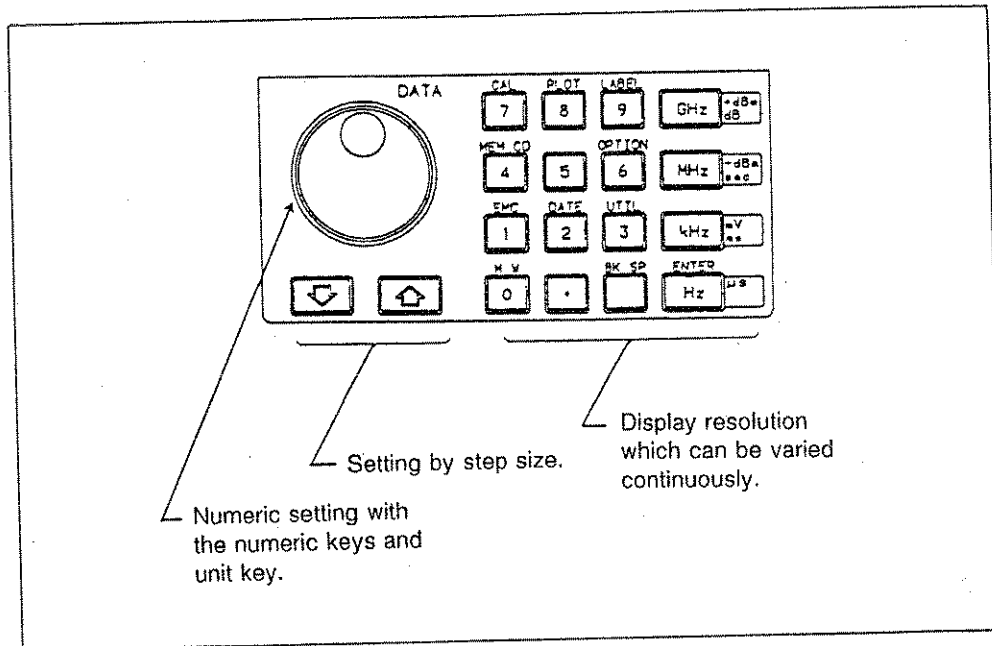

3.2 Screen Annotation (comments)

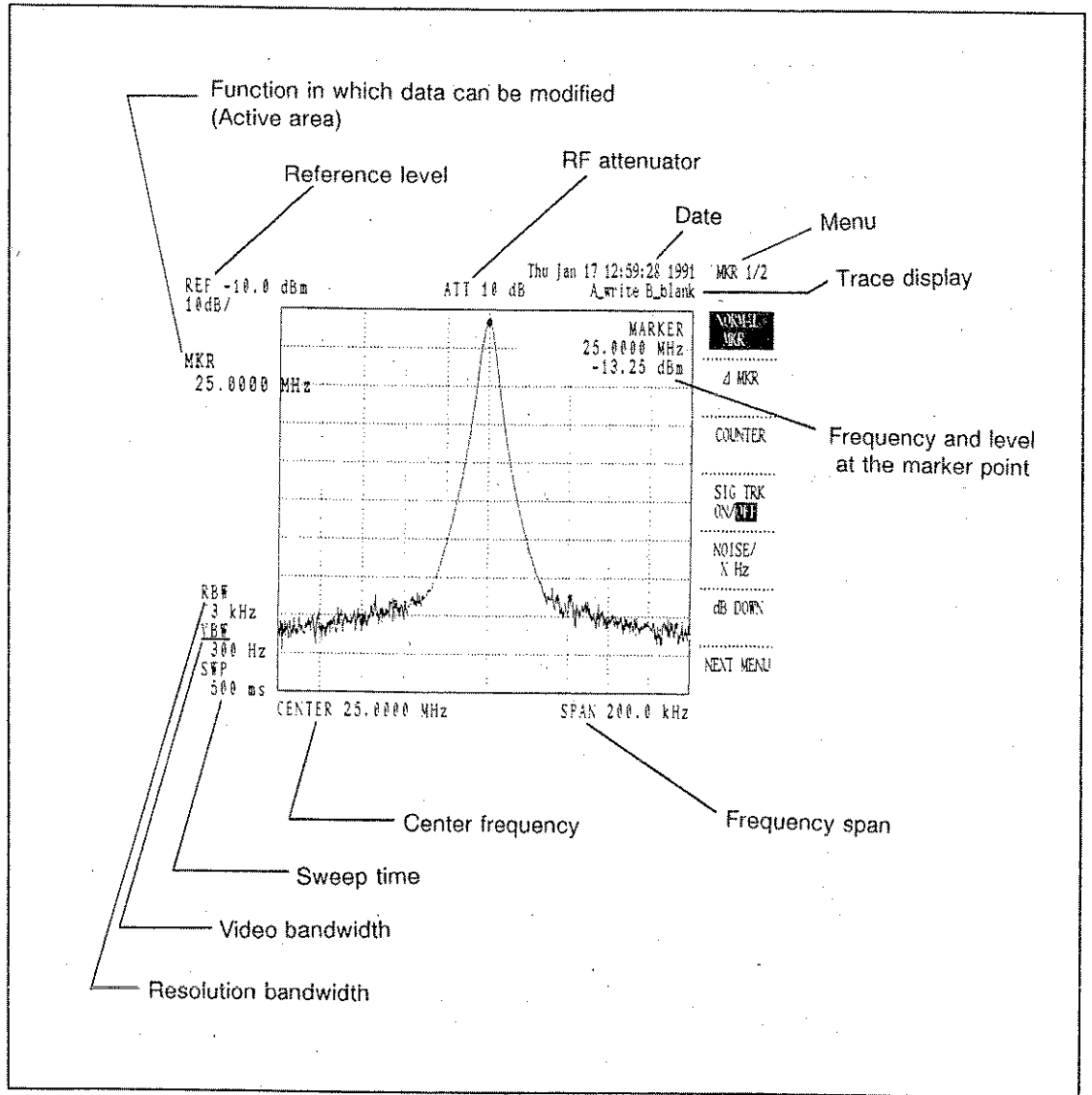

Fig. 3-1 Screen Annotation

3.3 Basic Measurement

The analyzer can measure the signal frequency and level.

This section explains the procedure to measure the frequency and level of the 430M bandwidth oscillator. Figure 3-2 illustrates wiring for the measurement.

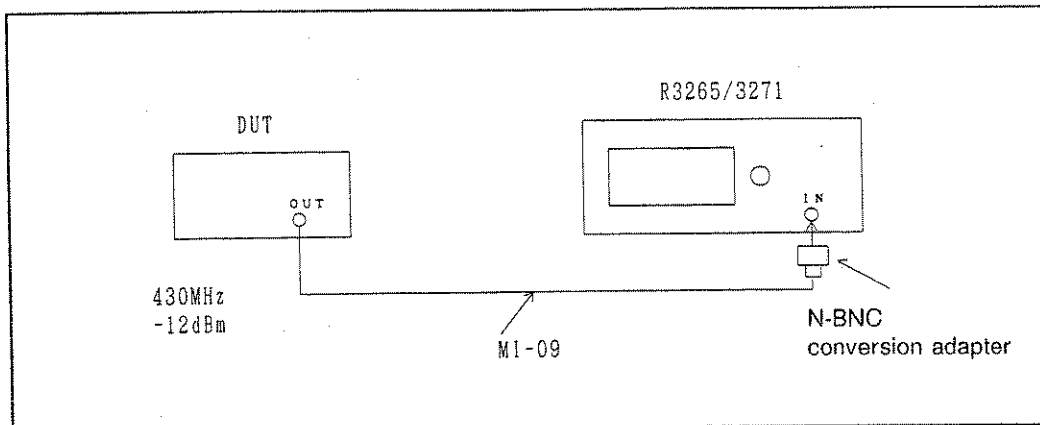

Fig. 3-2 Wiring

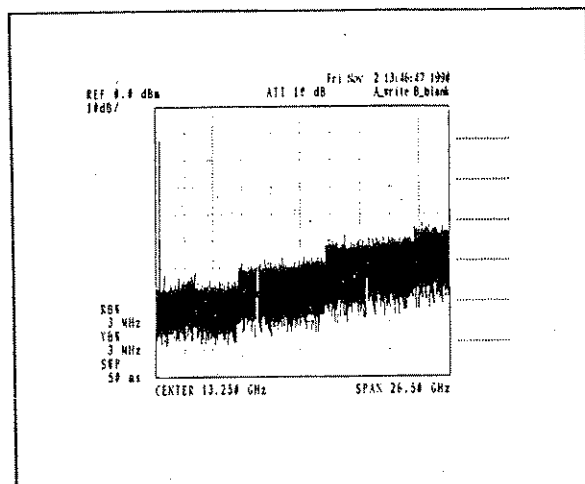

Fig. 3-3 Initial Screen (R3271)

- ① Turn the power switch ON.
Self check start.
- ② Press the **PRESET** key, and the analyzer is initialized.
- ③ Connect the analyzer to the source of the signals to be measured.

WARNING

The maximum level which can be fed to the input connector of the analyzer is as follows.

Maximum input level: +30dBm

DC couple: 0V

If a voltage level exceeding the value specified here is fed to the analyzer, the input mixer section will be broken, which will require repair of high cost. In case there is a possibility that the input signal level may exceed the analyzer maximum level, do not forget to use an external attenuator so that the signal level is lowered sufficiently.

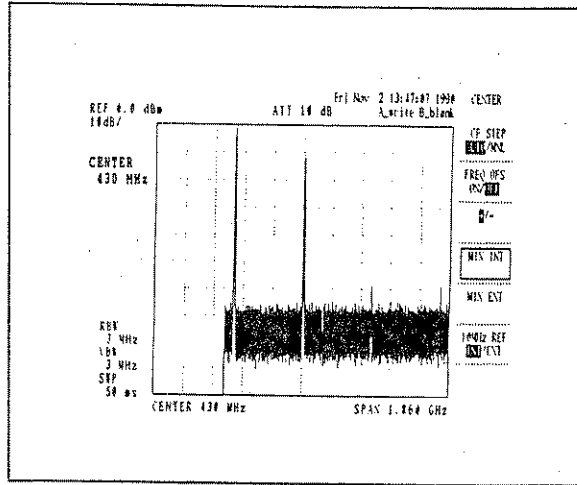

Fig. 3-4 Setting the center frequency

- ④ Press the **CENTER FREQUENCY** then keys **4** **3** **0** **MHz**

The signal is displayed at the center of the screen.

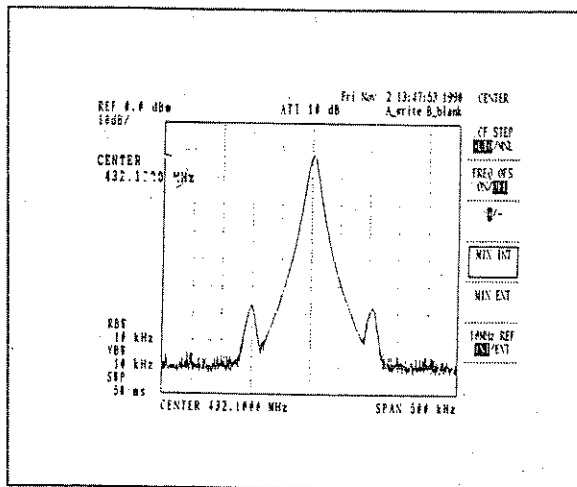



Fig. 3-5 Setting the span

- ⑤ Press the **SPAN** key and make adjustment with **↓** key so that the waveform can easily be viewed. If the center frequency is shifted, press the **CENTER FREQUENCY** key and make adjustment with knob .

CAUTION

When the frequency span is modified, the 430MHz signal may be shifted from the screen center. This is caused by that the setting resolution varies depending on the frequency span. In case the frequency value is known, enter the frequency with ten-key operation so that the spectrum will not be shifted from the screen center when the frequency span is set.

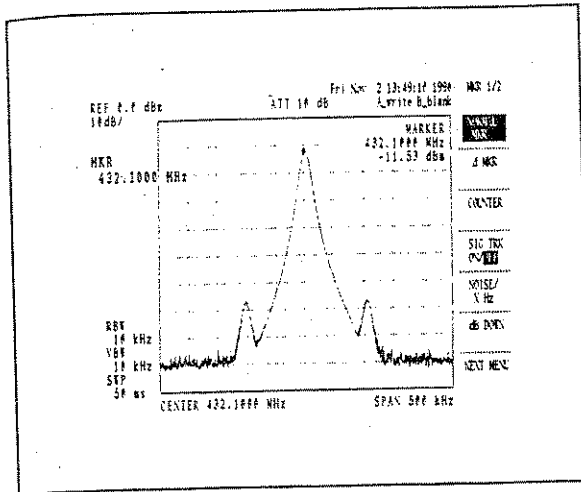

Fig. 3-6 Peak marker

- ⑥ Press the **PEAK** of the **MARKER**, then the marker is displayed at the peak. The frequency and the level at the marker position are displayed at the upper right corner.

To erase the marker, press the **OFF** key.

CAUTION

To make measurement with the accuracy to satisfy the specification of the analyzer, warm-up (for about 60 minutes or above) and calibration are required. (See Section 5.8 Calibration function).

EXAMPLES OF MEASUREMENT

This chapter explains the analyzer operations through concrete examples.

CAUTION

In the examples below, the analyzer is in the initialized mode when shipped from the factory. The signal to be measured through the attenuator so that it is below the maximum input allowance (30dBm).

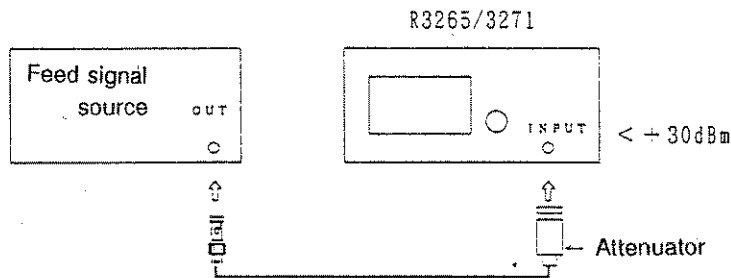

Table of Contents

Measuring Frequency	4-2
Measuring AM Signal Modulation Frequency and Modulation Index	4-6
Measuring FM Wave	4-11
Measuring Pulse-Modulated Wave	4-19
Measuring Occupied bandwidth (OBW)	4-21
Measuring Adjacent Channel Leak Power (ADJ)	4-24
Analyzing Burst Signal Spectrum	4-29

4. EXAMPLES OF MEASUREMENT

4.1 Measuring Frequency

An example of measuring approx. 200MHz signal

(1) Measuring frequency with normal marker

Display the input signal in the way that it can easily be viewed and adjust the marker with the peak.

- ① Press
- ② Press
- ③ Press

The marker frequency is displayed at the upper right corner of the screen.

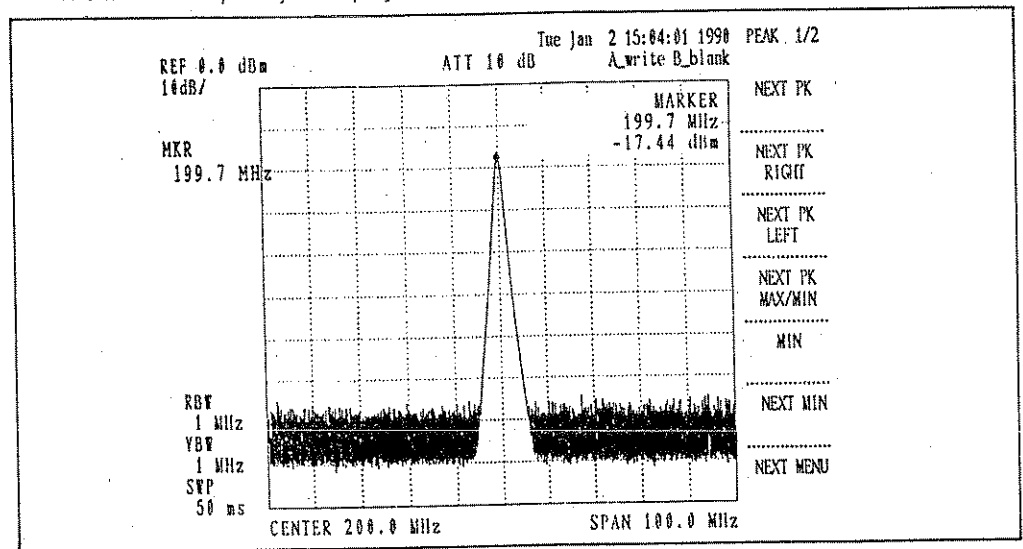

Fig. 4-1 Measuring frequency with normal marker

Measurement Accuracy

$$\pm (\text{Marker frequency reading value} \times \text{Reference source accuracy} + \text{Span} \times \text{Span accuracy} + 0.15 \times \text{Resolution bandwidth} + 10\text{Hz})$$

Span accuracy: $\pm 3\%$ (Span > 2MHz)
 $\pm 5\%$ (Span \leq 2MHz)

(2) Measuring frequency in frequency counter mode

Select the Frequency counter mode and specify the counter measurement resolution.

① Press MARKER ON

② Press COUNTER CNT RES 10Hz to select the measurement frequency resolution 10Hz.

③ Set FREQ CNT/ MKR CNT to FREQ CNT

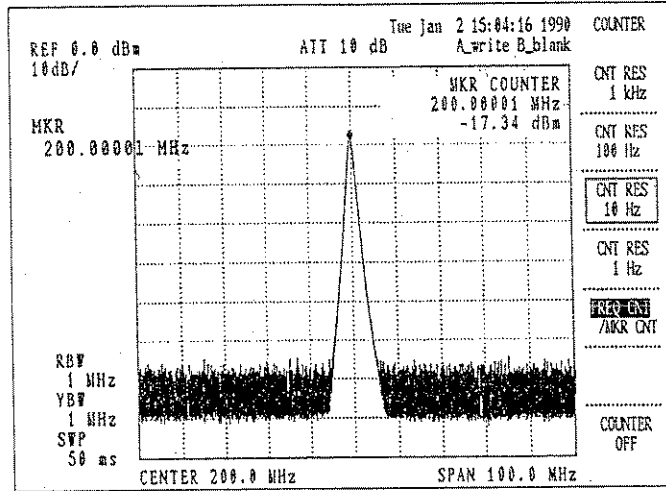

The marker frequency is displayed with 10Hz resolution at the upper right corner of the screen.

In this mode, the input signal frequency can be measured even if the marker point is out of the signal peak.

Fig. 4-2 Measuring frequency in Frequency counter mode

Measurement Accuracy

\pm (Marker frequency reading value x Reference source accuracy + 5Hz x N + 1LSD)

	Frequency band	N: Mixer degree
R3265	0 to 8GHz	N = 1
R3271	0 to 7.5GHz	N = 1
	7.4GHz to 15.4GHz	N = 2
	15.2GHz to 23.3GHz	N = 3
	23GHz to 26.5GHZ	N = 4

CAUTION

1. The frequency counter mode may not operate correctly in the following cases:
 - Span > 1GHz
 - Difference between the marker point and the level is 25dB or below.
2. Cannot be used in parallel with SIGNAL TRACK mode.

(3) Measuring frequency in Marker counter mode

Measuring accuracy is improved if this mode is used when the difference between the signal level and noise level (S/N) is 20dB or below and the frequency counter does not operate correctly.

- ① Set the counter mode to Marker counter mode.

Set FREQ CNT/
MKR CNT to MKR CNT

- ② Set the sweep time longer.

Press CPL SWP and specify 1 MHz sec.

The marker frequency is displayed with 10Hz resolution at the upper right of the screen.

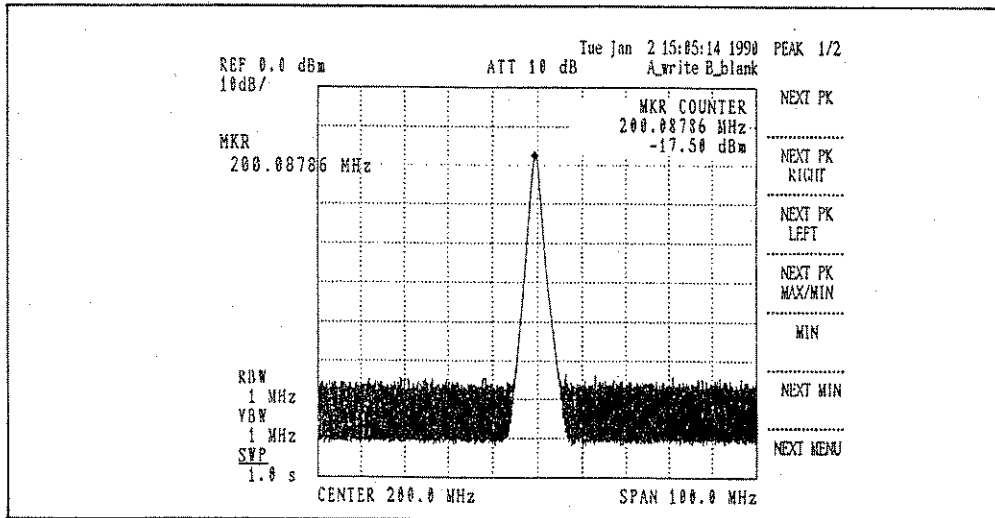

Fig. 4-3 Measuring frequency in Marker counter mode

Measurement Accuracy

Frequency counter mode accuracy + Span x Sweep delay

Sweep delay: Approx. 1% (If the sweep time is AUTO)

4.2 Measuring AM signal modulation frequency and modulation index

The spectrum analyzer shows performance superior to time domain oscilloscope in measuring slight modulation of residual AM and residual FM.

In time domain measurement, the AM wave modulation index m is determined as follows:

$$m = (E_{max} - E_{min}) / (E_{max} + E_{min}) \text{ (See Fig. 4-4(a).)}$$

When the same is determined by the spectrum analyzer, it is possible to determine how much (in dB) lowered is the side band from the carrier. (See fig. 4-4 (b).)

Modulation degree of the modulated wave against higher harmonic can also be determined separately. When the depth of modulation is small, the modulation degree can be read only in the order of 2% in time domain method while it can be read in the order up to 0.02% if the spectrum analyzer is used.

Note that measurement accuracy is improved if LINEAR mode is used for the modulation index 10% or above and LOG mode is used for the modulation index below 10%.

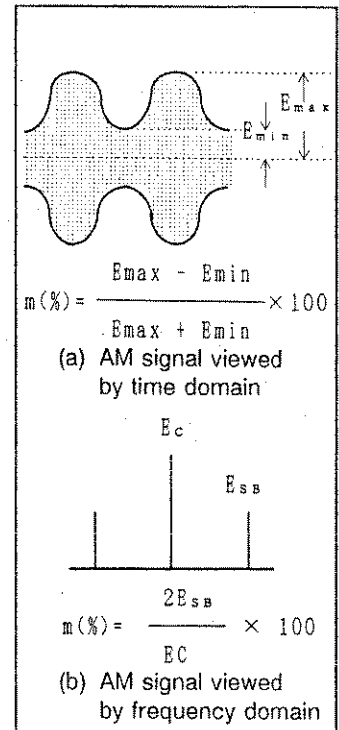

Fig. 4-4 Measuring AM signal

4.2.1 An example of measuring AM wave of low modulation frequency and great modulation index

Operation Procedure

- ① Display the signal to be measured and match its peak with the reference level. In this example the carrier is assumed to be 903MHz.

Press CENTER FREQ 9 0 3 MHz

Press FREQ SPAN 2 0 MHz

Press REF LEVEL and make adjustment with the INTENSITY knob so that the level peak is on the screen REF level.

4.2 Measuring AM signal modulation frequency and modulation index

- ② Set the resolution bandwidth to three times of modulation frequency or above.

Press

- ③ Set the vertical scale to LINEAR mode.

Press

- ④ Select ZERO SPAN mode.

Press

- ⑤ Set the Trace detection mode to SAMPLE.

- ⑥ Press the and make adjustment with the data knob so that the signal level peak is in contact with the REF line.

- ⑦ Set the TRIGGER mode to VIDEO.

Press and adjust the trigger level.

- ⑧ Set the sweep time to such value that makes observation easy.

Press and make adjustment with the step key.

- ⑨ Using the marker, determine the interval between the modulation signal peaks, i.e., modulated wave period T (S). Then, set the delta marker at the next peak.

Press and make adjustment with the data knob.

Modulation frequency is determined when set to ON.

- ⑩ Set the marker at the waveform maximum value, read the level E_{max} and write it down.

Press

- ⑪ Set the marker at the waveform minimum value and read the level E_{min}. Using the data knob, set the marker at the waveform minimum value.

4.2 Measuring AM signal modulation frequency and modulation index

- ② Substitute the following expression with the read values to determine the modulation index m .

$$m (\%) = \frac{E_{max} - E_{min}}{E_{max} + E_{min}} \times 100 (\%)$$

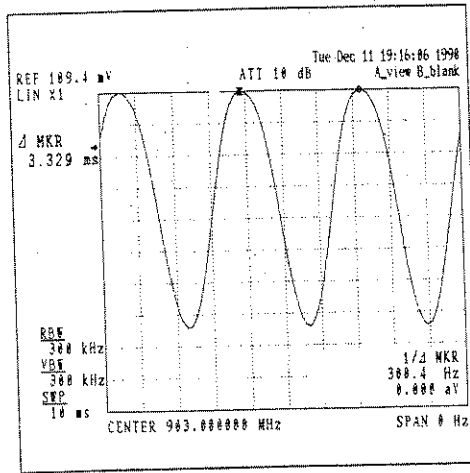

Fig. 4-5 Modulation frequency of the AM modulation

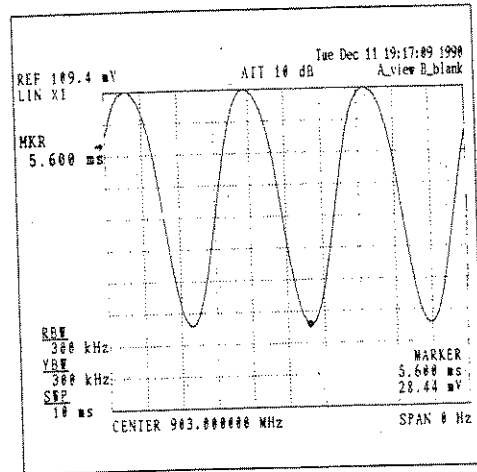

Fig. 4-6 AM modulation index

4.2 Measuring AM signal modulation frequency and modulation index

4.2.2 Measuring AM wave with high modulation frequency and small modulation index

Operation Procedure

- ① Set the frequency span at the range from twice to ten times of the modulation frequency.

Press and make adjustment with the step key.

- ② Set the center frequency at the frequency of the carrier.

Press and make adjustment with the data knob.

- ③ Set the marker at the carrier peak.

Press

- ④ Δ Match the delta marker with the modulation signal spectrum peak.

Press and make adjustment with the data knob.

- ⑤ The modulation frequency f_m and modulation index m can be obtained from the next expressions, using the delta marker frequency and the level indication at step 4).

$f_m =$ Delta marker frequency

$$m = \log^{-1} \frac{E_{SB} - E_C + 6}{20}$$

Figure 4.8 shows the relationships between the value $(E_{SB} - E_C)$ and $m(\%)$.

4.2 Measuring AM signal modulation frequency and modulation index

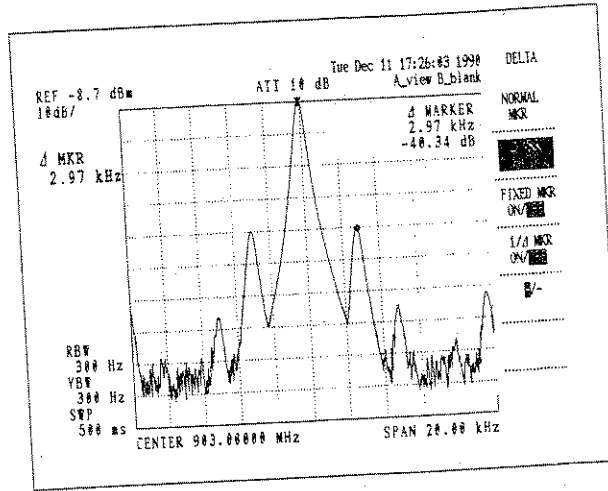

$f_m = 2.97 \text{ KHz}$
 $E_{SB} - E_C = 40.34 \text{ dB}$

Fig. 4-7 AM wave with high modulation frequency and small modulation index

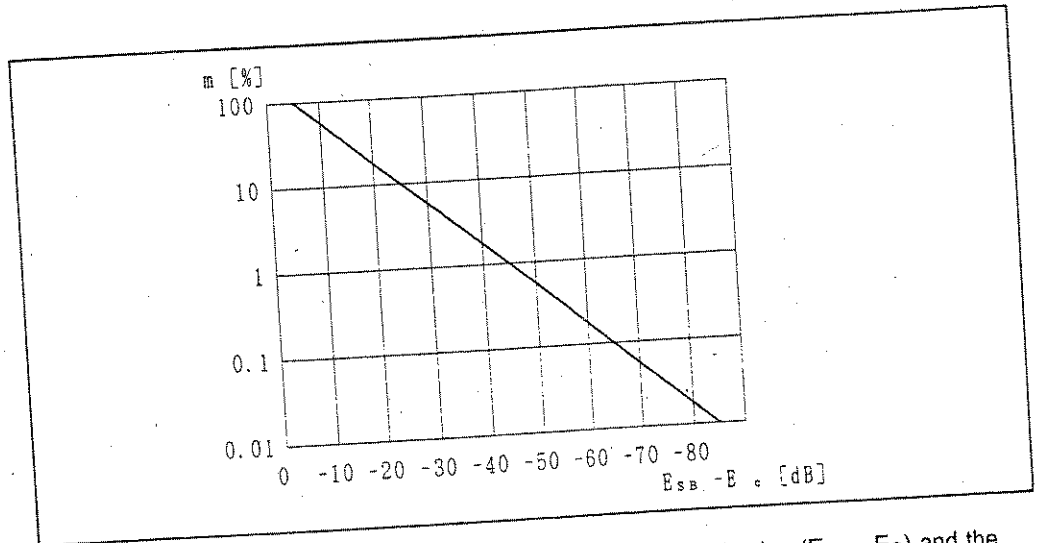

Fig. 4-8 Side band level - Relationships between the carrier level value ($E_{SB} - E_C$) and the modulation index m (%)

4.3 Measuring FM Wave

The following are normally measured in FM wave observation: carrier frequency f_c , modulated wave frequency F_m , frequency shift Δf_{peak} , modulation index m and occupied frequency bandwidth.

The FM modulation index m can be expressed as $\Delta f_{\text{peak}} / f_m$.

Modifying the modulation index into 2.4, 5.6, 8.6....., determine where the carrier is at minimum, and the the modulation index m or frequency shift Δf_{peak} can be obtained. (See Fig. 4-9 (a) and (b).)

In case FM wave modulation cannot be analyzed sufficiently only from the spectrum, there is a way to change the FM composite of the input signal into amplitude change to be displayed.

In such a case, a discriminator is normally used. But in case of the spectrum analyzer, detection can be performed by using the IF, B.P.F slope. The modulated wave detected is displayed on the screen. (See Fig. 4-9 (c).)

If the modulation frequency is low, set the analyzer horizontal axis to ZERO SPAN so that it operates as the fixed tuning receiver and make measurement along the time axis.

If the modulation frequency is high, make measurement along the frequency axis and determine the modulation frequency from the frequency of the side band.

If the modulation index is small (approx. 0.8 or below), the value m can be obtained from the relationships between the carrier level and the 1st side band level.

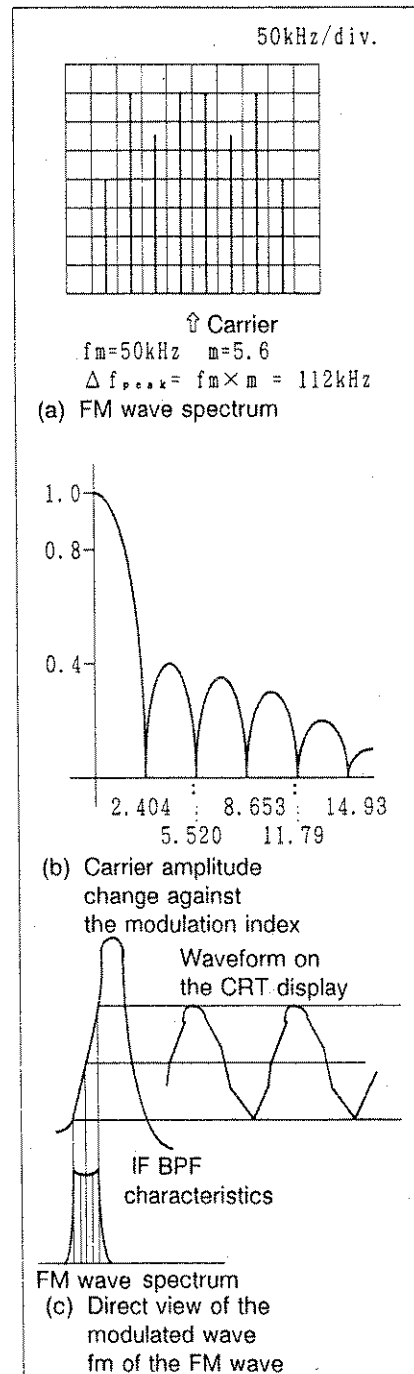

Fig. 4-9 Measuring FM signal

4.3.1 Measuring FM wave with low modulation frequency

Operation Procedure

- ① Set the signal carrier to be the Center frequency.

Press and make adjustment with the step key or data knob.

- ② Set the resolution bandwidth at three times or above of the modulation frequency.

Press and make adjustment with the step key.

- ③ Set the signal peak to be the reference level.

Press and make adjustment with the data knob so that the signal level peak is at the screen REF line.

- ④ Set ZERO SPAN mode on.

Press

- ⑤ Modify the center frequency so that the demodulated wave is at the center of the screen.

Press and make adjustment with the step key or data knob.

- ⑥ Set Trigger mode to VIDEO.

Press

- ⑦ Select a sweep time such that demodulated wave can easily be viewed.

Press and make adjustment with the step key.

- ⑧ Set the marker at the demodulated wave peak.

Press

⑨ Match the delta marker with the adjacent peak.

Press ON Δ MKR and make adjustment with the data knob.

Set 1 Δ MKR ON/OFF to ON to obtain the modulation frequency f_m .

$$f_m = \frac{1}{T(s)}$$

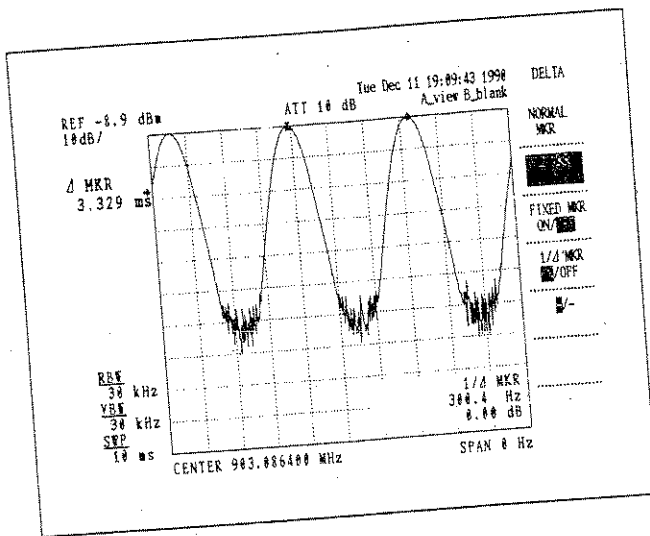

fm = 300.4 Hz

Fig. 4-10 FM wave with low modulation frequency

4.3.2 Measuring FM wave with high modulation frequency and small m

Operation Procedure

- ① Set the frequency span in the range from twice to ten times of the modulation frequency.

Press **FREQ SOAN** and make adjustment with the step key.

- ② Set the carrier frequency to be the center frequency.

Press **CENTER FREQ** and make adjustment with the data knob.

- ③ Set the marker at the carrier peak.

Press **PEAK**

- ④ Set the delta marker at the adjacent side band signal peak.

Press **ON** **Δ MKR** and make adjustment with the data knob.

The frequency indication of the delta marker is the modulation frequency fm.

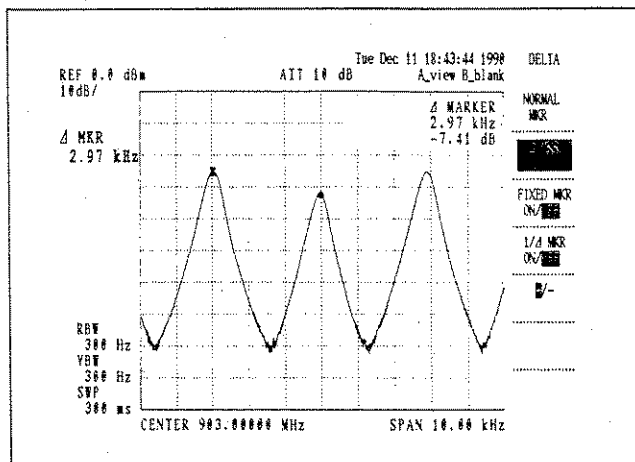

Fig. 4-11 FM wave with high modulation frequency and small m

4.3.3 Measuring FM wave peak shift (Δf_{peak})

Operation Procedure

- ① Set the resolution bandwidth to the value containing the main side band (5 times or above of the modulation frequency).

Press **COUPLE** **RBW** and make adjustment with the step key.

- ② Set the center frequency to the carrier frequency.

Press **CENTER FREQ** and make adjustment with the data knob.

- ③ Set the frequency span in accordance with the peak shift so that measurement can easily be performed.

Press **FREQ SPAN** and make adjustment with the step key.

- ④ From the waveform, determine $\Delta f_{\text{peak peak}}$.
 Δf_{peak} and the modulation index m are obtained from the following expressions.

$$\Delta f_{\text{peak}} = \frac{1}{2} \Delta f_{\text{peak peak}}$$

$$m = \frac{\Delta f_{\text{peak}}}{f_m}$$

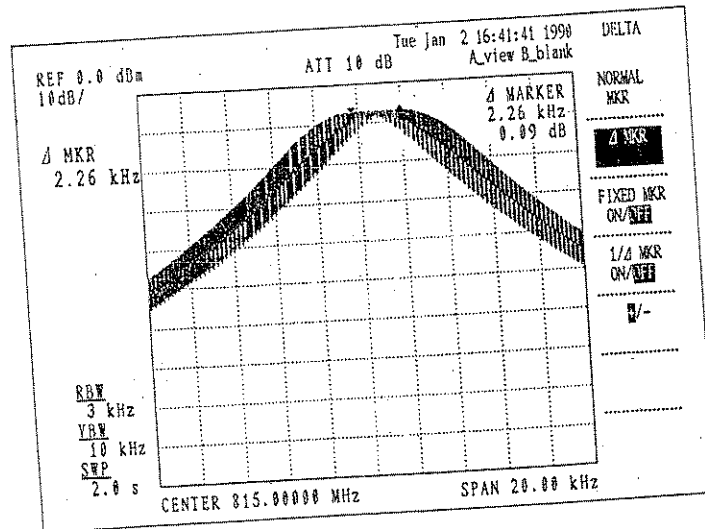

- When Δf_{peak} is small:
In this example, $\Delta f_{\text{peak peak}} = (\text{delta marker frequency})/2 = 2.26\text{kHz}$

$$\Delta f_{\text{peak}} = \frac{1}{2} \Delta f_{\text{peak peak}} = 1.13\text{kHz}$$

Fig. 4-12 FM wave with small Δf_{peak}

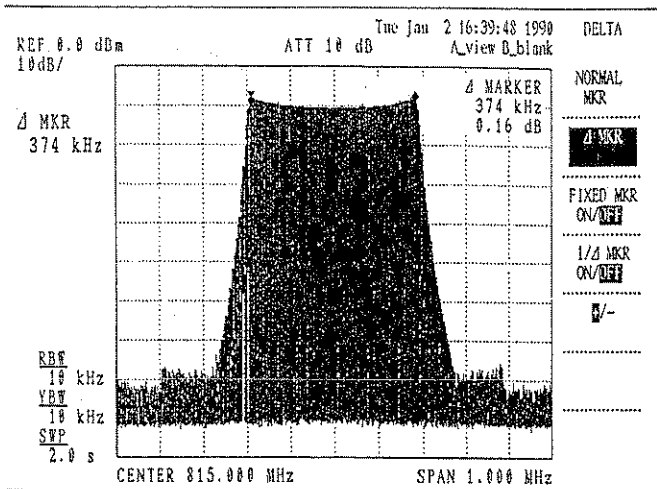

- When f_{peak} is large:
In this example, $f_{\text{peak peak}}$
= (delta marker frequency)/2
= 374kHz

$$\Delta f_{\text{peak}} = \frac{1}{2} \Delta f_{\text{peak peak}}$$

$$= 187 \text{ kHz}$$

Fig. 4-13 FM wave with large Δf_{peak}

4.3.4 How to determine m when FM modulation index m is small

If the FM wave modulation index m is approximately 0.8 or below, the following expression is satisfied.

$$m = \frac{2E_{\text{SB}}}{E_{\text{C}}}$$

E_{SB} : 1st side band level
 E_{C} : Carrier level

Operation Procedure

- ① Set the center frequency and the frequency span at the values such that the carrier can easily be viewed, and match the carrier level with the reference level.

Press CENTER FREQ and make adjustment with the data knob.

Press FREQ SPAN and make adjustment with the step key.

Press REF LEVEL and make adjustment with the data knob.

- ② Read the carrier frequency f_{c} from the center frequency indication and read the carrier level E_{c} from the reference level indication. (See Fig. 4-14.)

- ③ Match the delta marker with the 1st side band and read the frequency f_{SB} and level E_{SB} from the delta marker indication.

Press PEAK ON Δ MKR and make adjustment with the data knob.
(See Fig. 4-15.)

- ④ The FM modulation index m is obtained from the following expression.

$$m = 2 \times \frac{E_{SB}}{E_c} = \log^{-1} \frac{E_{SB} - E_c + 6}{20}$$

- ⑤ The modulation frequency f_m is obtained from the following expression or from the delta marker frequency indication.

$$f_m = |f_{SB} - f_c|$$

- ⑥ The frequency shift f_{peak} is obtained from the following expression.

$$\Delta f_{peak} = m \times f_m$$

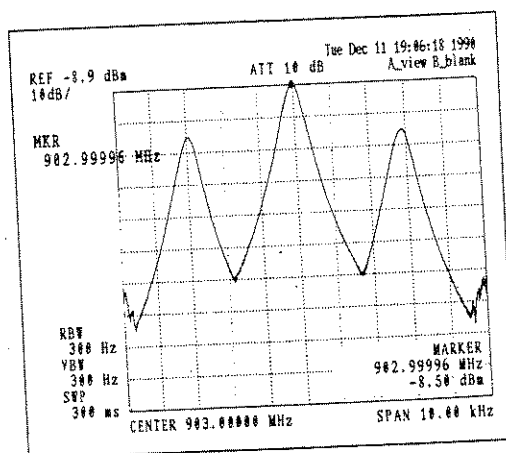

Fig. 4-14 FM wave f_c and E_c

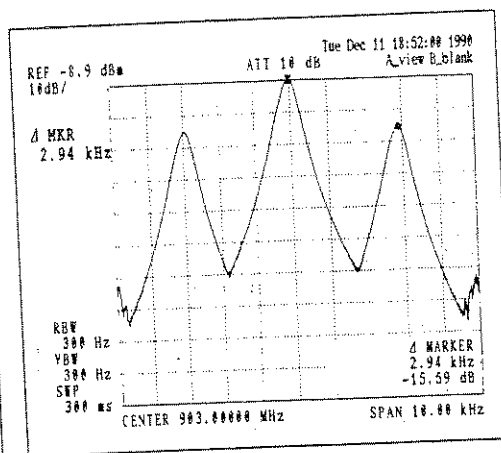

Fig. 4-15 FM wave f_{SB} and E_{SB}

4.4 Measuring pulse-modulated wave

The spectrum analyzer equivalently analyzes the waveform and displays higher harmonic and dominant wave contained in the waveform. As illustrated in Fig.4-16 (a), if the time-axis waveform of the pulse-modulated wave is converted into the frequency axis, spectrum distribution having envelope centered at the carrier f_c as shown in Fig. 4-16 (b) is obtained.

In case of pulse-modulated wave of a radar, the following can be determined with the spectrum analyzer.

- Pulse repetition frequency (PRF)
- Pulse width (τ)
- Carrier frequency (f_c)
- Peak power (P_{peak})
- Average power (P_{ave})

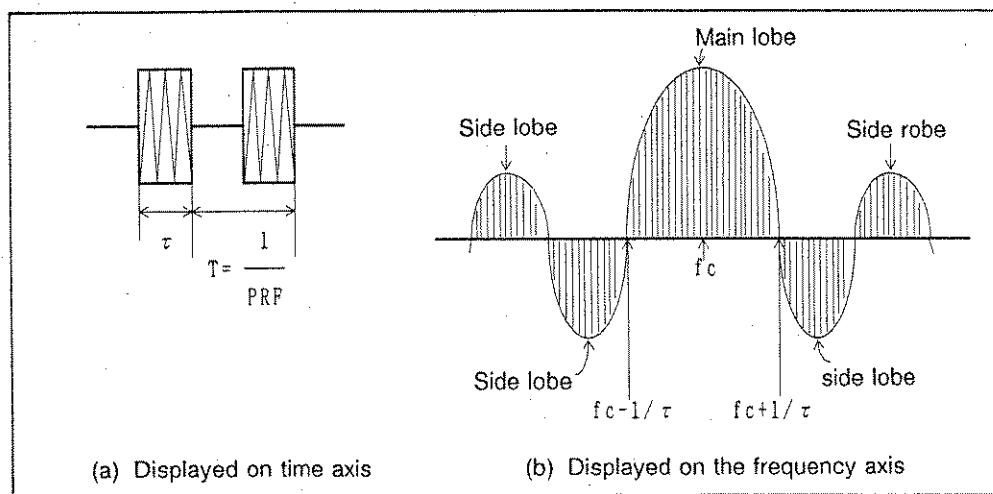

Fig. 4-16 Pulse-modulated wave

CAUTION

1. The maximum input level of the analyzer is +30dBm, 0VDC when the input attenuator is set to 10 dB or above. Pulse-modulated wave of a radar which has great peak power should be sufficiently attenuated by using a coupler before fed to the analyzer input connector.
2. As the analyzer mixer input level is -10dBm, set the input attenuator so that $P_{peak} \leq -10\text{dBm}$. To prevent mixer saturation, lower the input attenuator by 10dB starting at 50dB and find the minimum attenuator value which will not lower the signal level.

(1) Pulse width (τ)

The pulse width (τ) is determined by the inverse number of the 1/2 width of the main lobe or inverse number of the side lobe. To obtain an envelope with sufficient resolution, the resolution bandwidth should be set in the range described below.

$$\text{Pulse repetition frequency (PEF)} \times 1.7 \leq \text{Resolution bandwidth} \leq 0.1/\tau$$

(2) Carrier frequency

The measurement accuracy of the carrier frequency (f_c) is determined by the pulse width. If τ is small, the main lobe spreads out and the determination of the center becomes difficult. To display the center accurately, SPAN/DIV should be set wider than $1/\tau$. In this case, measurement frequency accuracy is the center frequency accuracy at the SPAN/DIV specified.

(3) Peak power (P_{peak})

The amplitude indication is in proportion to the resolution bandwidth if the resolution bandwidth of the spectrum analyzer satisfies the following conditions:

$$\text{Pulse repetition frequency (PEF)} \times 1.7 \leq \text{Resolution bandwidth} \leq 0.2/\tau$$

Under this condition, the amplitude indication is in proportion to the resolution bandwidth and the relationships between the actual peak power P_{peak} (dBm) and amplitude indication P'_{peak} (dBm) can be expressed as follows.

$$P_{\text{peak}} = P'_{\text{peak}} - \alpha \text{ (dB)} \quad \alpha: \text{Pulse attenuation factor}$$

$$\alpha \text{ (dB)} = 20 \log (\tau \times 1.5 \times \text{RBW})$$

(4) Average power P_{ave} (dBm)

The average power P_{ave} (dBm) is determined as follows.

$$P_{\text{ave}} = p_{\text{pave}} \times \text{PRF} \times \tau$$

PRF: Pulse repetition frequency (Hz)
 τ : Pulse width (s)

Measuring the Occupied Bandwidth (OBW)

The Trace A memory of the analyzer executes calculation to determine the occupied bandwidth with the measurement data on the screen. This calculation can specify the ratio against the centre power up to 10.0 to 99.8%. The initial value is 99%.

Caution

- As the calculation error is significantly great when the signal amplitude on the screen is 50dB or below, adjust the reference level and span so that the amplitude is above 50dB. The span recommended is three times of the occupied bandwidth.
- Measurement with minimum error can be obtained if the analyzer resolution bandwidth is specified to be 3% or below of the specified bandwidth.
- If too much noise is contained in the signal, especially in the case that the modulated wave is false aural signal, set the Trace DET. to SAMPLE to minimize the error.

(1) Operation Procedure

- ① Set the center frequency so that the Trace A signal wave is displayed at the center of the screen and specify the frequency span and resolution bandwidth to the values to be measured.

A	WRITE A			
CENTER FREQ	9	0	2	MHz
FREQ SPAN	5	0		kHz
COUPLE	data adjustment			
Press	RBW	3	0	0 Hz

- ② Set the Trace DET. to SAMPLE mode.

MENU	TRACE DET.	SAMPLE	in this sequence.
------	------------	--------	-------------------

- ③ Measure the occupied bandwidth.

Press	SHIFT	UTIL	3	OBW	in this sequence.
-------	-------	------	---	-----	-------------------

When the calculation is complete, the occupied bandwidth and the carrier frequency (Fc: the center value of the occupied bandwidth) are displayed at the upper right of the screen and the marker is set at the point of the ratio against the entire power. For example, if the ratio is 99.0%, the markers are set from the left end of the screen to the points of 0.5% and 99.5% of the entire power, respectively.

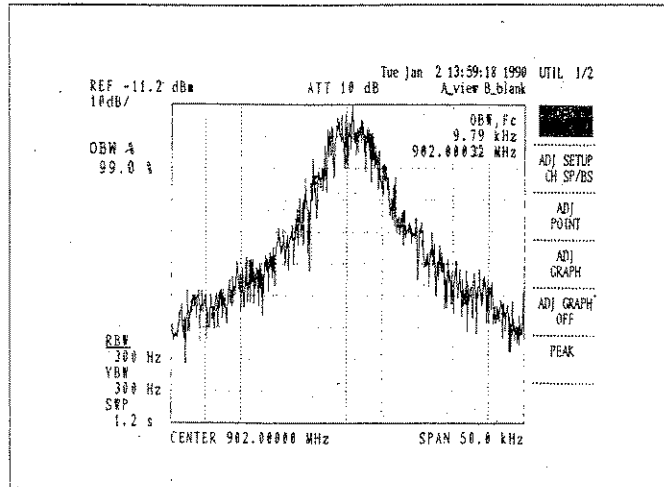

Fig. 4-17 Measuring OBW

- ④ The ratio against the entire power can be modified by ten-key operation.

Example:

Press in this sequence, and the occupied bandwidth is displayed.

Press and the ratio is set to 80%.

- (2) How to calculate the occupied bandwidth (OBW)

The data on the analyzer screen consists of 701 points along the frequency axis. If the voltage of one point is assumed to be V_n , the total power P on the screen can be obtained from the following expression.

$$P \text{ (W)} = \sum_{n=1}^{701} \frac{V_n^2}{R} \quad (\text{R: Input impedance})$$

The following expression is satisfied if the total of the powers at the interval from the screen left end to the X-th point is 0.5% of the entire power P .

$$0.005P = \sum_{n=1}^X \frac{V_n^2}{R} \quad (\text{When the ratio is 99.0\%})$$

The following expression is satisfied if the total of the powers at the interval from the screen left end to the Y-th point is 99.5% of the entire power P .

$$0.995P = \sum_{n=1}^Y \frac{V_n^2}{R} \quad (\text{When the ratio is 99.0\%})$$

Determine the values of X and Y from the expressions above and substitute them into the following expression to obtain the occupied bandwidth.

$$\text{OBW (Hz)} = \frac{f_{\text{SPAN}}(Y-X)}{701} \quad (\text{F}_{\text{SPAN}}: \text{Frequency span})$$

4.6 Measuring Adjacent Channel (Leak) Power (ADJ: Adjacent channel power)

4.6 Measuring Adjacent Channel (Leak) Power (ADJ: Adjacent channel power)

Use the Trace A memory of the analyzer to execute calculations to determine the total power from the measurement data on the screen, to integrate the power with the specified bandwidth (BS) and to determine the ratio.

Two types of measurement are available: ADJ POINT and ADJ GRAPH

ADJ POINT : The leak power of the upper and lower channels are measured at the specified channel interval.

ADJ GRAPH : The leak power of the bandwidth specified (BS) is determined for each of the frequency points and the results are stored in the trace B memory and displayed on the screen.

CAUTION

1. The dynamic range is lowered if the signal level is much lower than the reference level. Span recommended is four or five times of the channel interval of the radio.
2. Measurement with minimum error can be obtained if the analyzer bandwidth is set to 1/40 or below of the specified bandwidth.
3. If too much noise is contained in the signal, especially when the modulated wave is false aural signal, set the trace DET to SAMPLE mode so that error can be minimized.

(1) Measurement Procedure

- ① Set the center frequency so that the trace A signal wave is displayed at the center of the screen and specify the values of frequency span and resolution bandwidth to be measured.

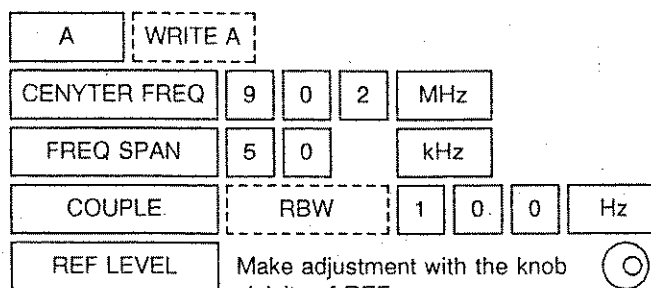

- ② Set the Trace DET to SAMPLE mode.



4.6 Measuring Adjacent Channel (Leak) Power (ADJ: Adjacent channel power)

- ③ Method using ADJ POINT is explained in paragraph (a), and method using ADJ GRAPH is explained in (b).

(a) Method using ADJ POINT

- (a-1) Set the marker to the frequency of the specified channel.

MARKER ON 9 0 2 MHz

- (a-2) Select the adjacent channel leak power mode and set the specified bandwidth and channel interval.

Press SHIFT UTIL 3 ADJ SETUP
CH SP/BS to select

and specify the channel interval.

ADJ SETUP
CH SP/BS 1 2 . 5 kHz

Then, select BS (bandwidth specified) and set the value.

ADJ SETUP
CH SP/BS 8 . 5 kHz

- (a-3) Execute measurement of the adjacent channel leak power.
(Execution of ADJ POINT)

Press ADJ
POINT

The marker indicates the point of the specified channel frequency \pm channel interval and the power ratio of the upper adjacent channel against the lower adjacent channel is displayed in the marker indication area of the upper right corner of the screen.

This calculation is repeated every time ADJ
POINT is pressed.

4.6 Measuring Adjacent Channel (Leak) Power (ADJ: Adjacent channel power)

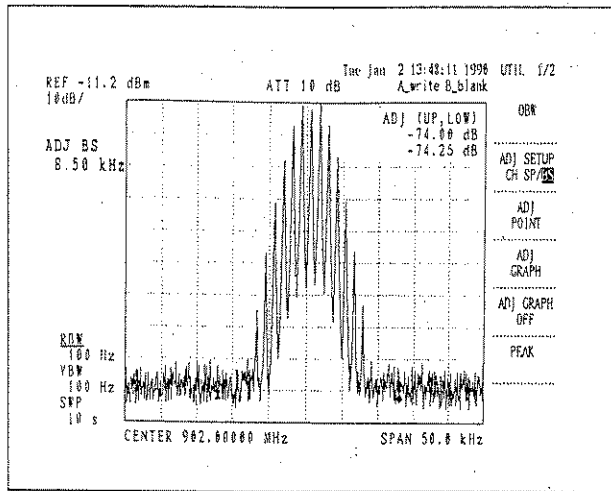

Fig. 4-18 Measuring the adjacent channel leak power (ADJ POINT)

CAUTION

1. When executing ADJ POINT measurement, at first set the marker to the frequency of the specified channel as in (a-2). The measurement will not operate if the channel interval and the specified bandwidth are not set or set incorrectly.
2. If the marker function is used after measurement, the indication is in delta marker mode. Before measurement, do not forget to set the marker to the specified channel frequency.

(b) Method using

ADJ
GRAPH

(b-1) Select adjacent channel leak power mode and specify set the specified bandwidth (BS).

Press SHIFT 3 UTIL
ADJ SETUP
CH SP/BS to select BS

and set the specified bandwidth by pressing

8 . 5 kHz

R3265/3271
SPECTRUM ANALYZER
INSTRUCTION MANUAL

4.6 Measuring Adjacent Channel (Leak) Power (ADJ: Adjacent channel power)

- (b-2) Execute measurement of the adjacent channel leak power
(Execution of ADJ GRAPH)

Press ADJ
GRAPH

The result of the adjacent channel leak power calculation are displayed on the screen B. Calculation result is displayed ever time the key is pressed.

- (b-3) By using the delta marker, the adjacent channel leak power can be measured with channel interval displayed.

Press ON 9 0 2 MHz

and set the marker to the specified channel frequency.

Press Δ MKR and set the adjacent channel frequency to be measured with the data knob, step key and ten-key operation.

Press 1 2 . 5 kHz

The adjacent channel leak power ratio is displayed in the upper right corner of the screen.

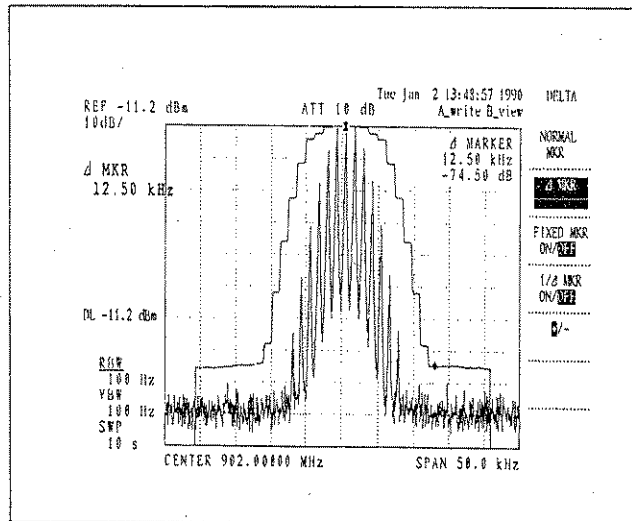

Fig. 4-19 Measuring the adjacent channel leak power (ADJ GRAPH)

CAUTION

Measurement will not operate if the specified bandwidth is improper.

4.6 Measuring Adjacent Channel (Leak) Power (ADJ: Adjacent channel power)

(2) Calculation Method

The analyzer screen data consists of 701 points along the frequency axis. If P_n is assumed to be power of one point, the total power P on the screen can be obtained from the expression as follows.

$$P [W] = \sum_{n=1}^{701} P_n$$

If ΔX is assumed to be the specified bandwidth (BS), the adjacent channel leak power at the n -th point from the screen left end is determined by the expression as follows.

$$P_{ADJ} [dB] = 10 \log_{10} \frac{\sum_{n=n-\Delta X/2}^{n+\Delta X/2} P_n}{P}$$

(If the following conditions are satisfied:

$n - \Delta X/2 \geq \text{Start frequency}$ and $n + \Delta X/2 \leq \text{Stop frequency}$)

7 Analyzing the burst signal spectrum

Burst signal spectrum can be analyzed, using the Gated Sweep function. Burst signal is often used for magnetic tape record in the VTR, 8mm video and digital audio tape (DAT).

Measurement method

Use the gated sweep control terminal (GATE IN terminal) on the analyzer rear panel for gate control. Sweep starts at the TTL level "High" (or Open) and stops at "Low".

The input signal and the gate control signal should be as specified below.

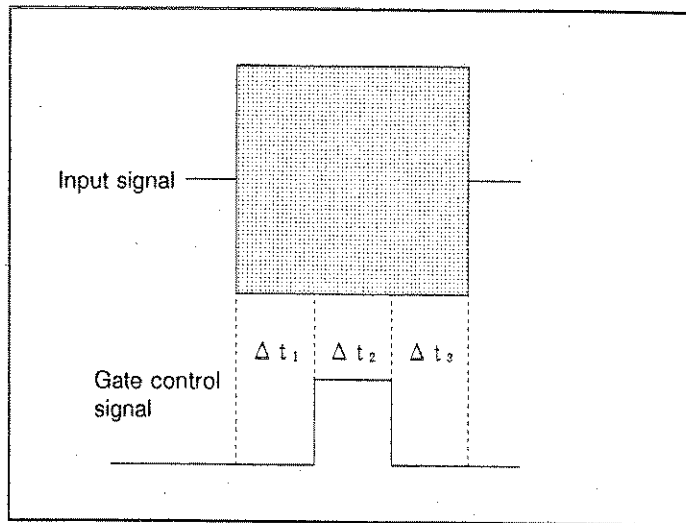

	RBW				
	3MHz, 1MHz	300kHz	100kHz	30kHz	10kHz
Δt_1	10 μ s or more	15 μ s or more	20 μ s or more	50 μ s or more	180 μ s or more
Δt_2	15 μ s or more				
Δt_3	1 μ s or more				

Note: When measuring noise, Detection mode should be set to SAMPLE.

5. EXPLANATION OF FUNCTIONS

This chapter explains the key functions and menu.

A list of menu is given in Appendix 3 at the end of this manual.

Table of Contents

5.1	Basic Key Functions	5-2
5.1.1	Center Frequency	5-2
5.1.2	Frequency Span	5-9
5.1.3	Start and Stop Frequency	5-11
5.1.4	Reference Level	5-12
5.1.5	Couple (Interlocked functions)	5-14
5.1.6	Menu Key	5-20
5.2	TRACE Section Functions	5-27
5.3	MARKER Section Functions	5-34
5.3.1	Marker ON	5-34
5.3.2	Peak Search	5-44
5.3.3	Marker ((Marker to)	5-50
5.3.4	Marker OFF	5-51
5.3.5	Multi Marker Function	5-52
5.4	User-Defined Functions	5-57
5.5	Memory Card Function	5-60
5.5.1	Memory Card Initialization and Soft Menu Save/Recall	5-60
5.5.2	Saving and Reading the Internal Back-up Memory Data	5-65
5.5.3	How to Handle the Memory Card	5-67
5.6	Save and Recall Functions	5-69
5.6.1	Save Function	5-70
5.6.2	Recall Function	5-82
5.7	Preset and Last State Functions	5-86
5.7.1	Preset	5-86
5.7.2	Last State	5-87
5.8	Calibration Function	5-88
5.9	Plot Output Function	5-91
5.10	Label Function	5-98
5.11	EMC Function	5-101
5.12	Date Function	5-111
5.13	Utility Function	5-112
5.14	Measurement Window Function	5-115

5. Explanation of Functions

5.1 Basic Key Functions

A list of soft menus is given in the Appendix 3.

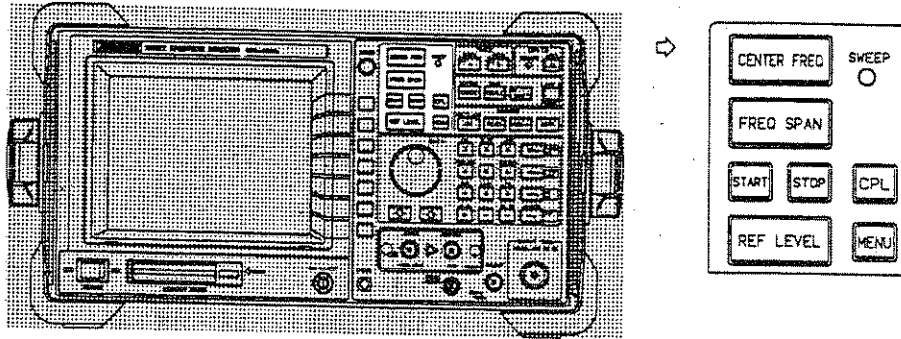

5.1.1 Center Frequency

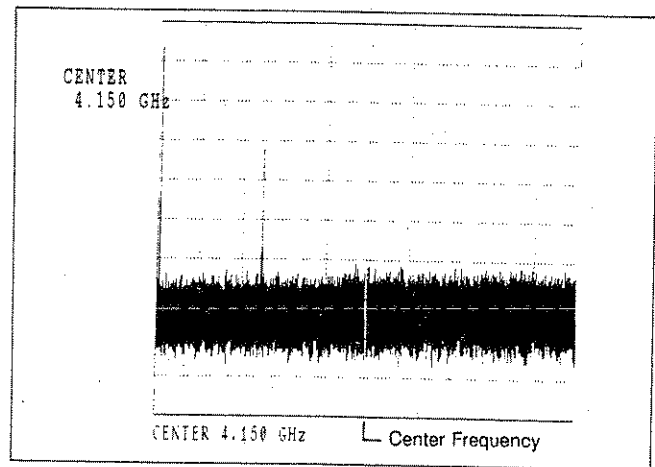
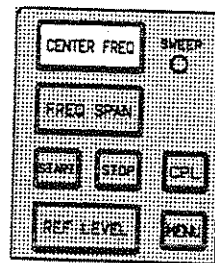

CENTER FREQ

When this key is pressed, the Center Frequency mode is set. In this mode, data can be entered and the center frequency data will appear on the screen.

R3265: 0 to 8GHz

R3271: 0 to 26.5GHz

CAUTION

The center frequency cannot be modified if the Span mode is LOG span.

Table 5.1-1 Center Frequency Display Resolution

Center Frequency Display Resolution	
1 MHz	(Span \geq 1000 MHz)
100 kHz	(1000MHz > Span \geq 100 MHz)
10 kHz	(100MHz > Span \geq 10 MHz)
1 kHz	(10MHz > Span \geq 1 MHz)
100 Hz	(1MHz > Span \geq 100 kHz)
10 Hz	(100 kHz > Span \geq 10 kHz)
1 Hz	(10 kHz > Span \geq 200 Hz)
1 Hz	(Span = 0 Hz)

(1) Explanation on the Menu

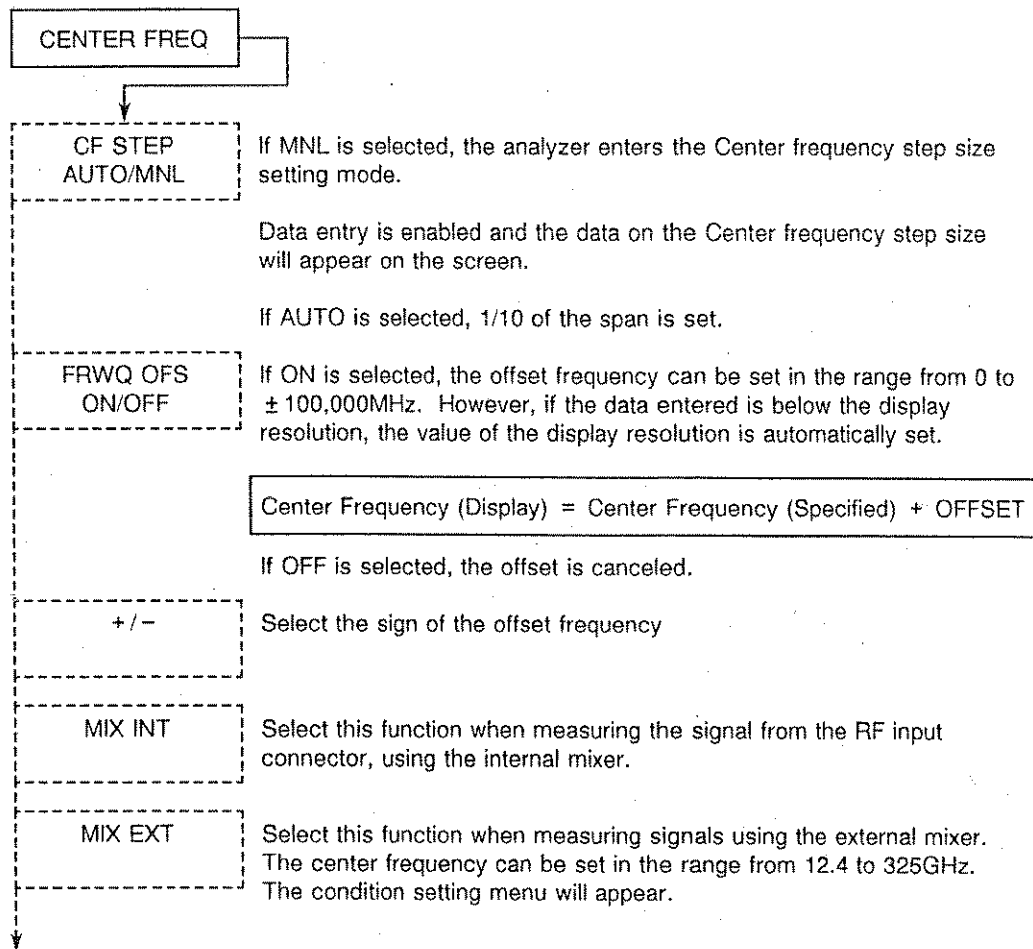

10 MHz REF
INT/EXT

If INT is specified, the internal reference frequency is selected. The frequency measurement accuracy will be $\pm 2 \times 10^{-8}$ /day, $\pm 1 \times 10^{-7}$ /year.

If EXT is specified, the external reference frequency connected to the 10MHz REF IN/OUT terminal on the rear panel is selected, and the frequency accuracy is determined by this.

The frequency error of the external reference source should be within 5×10^{-6} and the output level within the range of -5dBm to $+5\text{dBm}$.

CAUTION

1. When INT is specified, remove the external reference source from the 10MHz REF IN/OUT terminal. If it is connected, spurious will be generated.
2. When EXT is specified, do not forget to connect the reference source. If not connected, the frequency measurement error is significantly increased.

(2) Setting the External Mixer Conditions

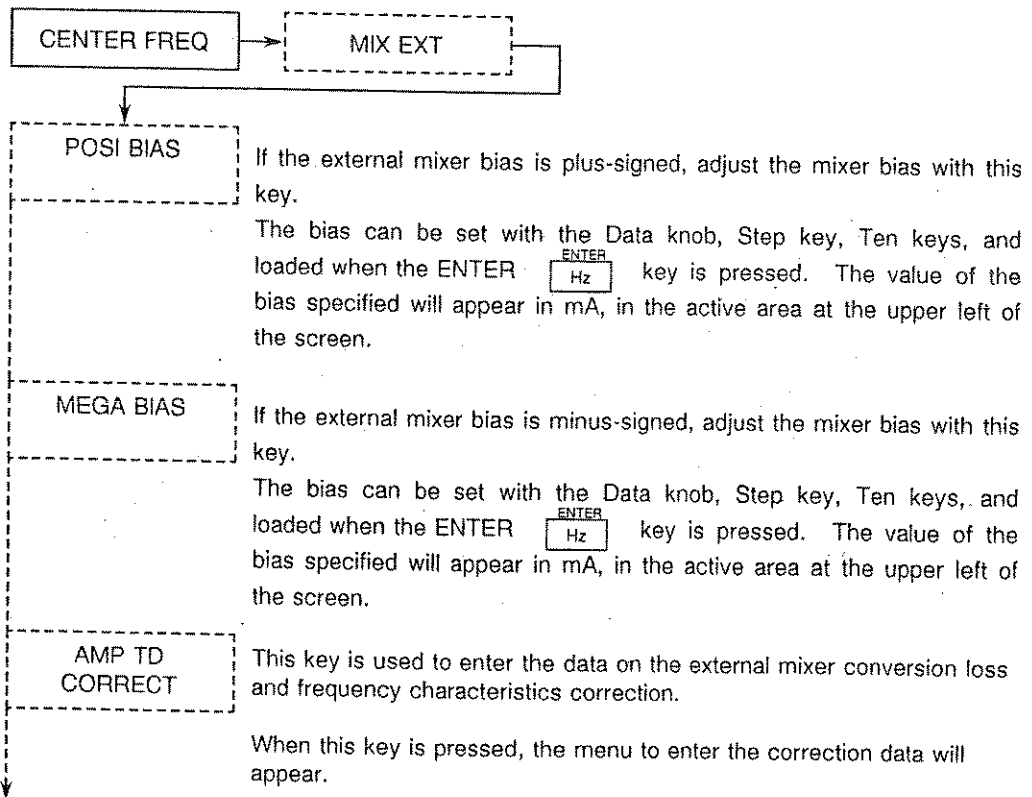

**BAND
 SELECT**

Set the frequency bandwidth of the external mixer to be used.

The frequency bandwidth which can be set is shown in Table 5.1-2.

Select the necessary bandwidth with the Data knob, Step key and Ten keys. When using the Ten keys, specify the Band No. in Table 5.1-2.

The Band No. and the mixing degree (N) will appear in the active area of the upper left of the screen.

Table 5.1-2 External Mixer Frequency Bandwidth which Can be Set

Band No.	Frequency Range (GHz)	Mixing Degree (N)
1	12.4 to 18.0	3
2	17.0 to 26.5	4
3	22.0 to 33.0	5
4	26.5 to 40.0	6
5	33.0 to 50.0	8
6	40.0 to 60.0	8
7	50.0 to 75.0	10
8	60.0 to 90.0	12
9	75.0 to 110.0	14
10	90.0 to 140.0	18
11	110.0 to 170.0	22
12	140.0 to 220.0	28
13	170.0 to 260.0	34
14	220.0 to 325.0	42

**BAND LOCK
 ON/OFF**

If ON is specified by the **BAND SELECT**, the bandwidth is fixed to the value which has been selected in the above step.

The center frequency and the start/stop frequency can be entered within the frequency range selected.

If OFF is specified, the bandwidth is automatically selected from Table 5.1-2 according to the center frequency and the start/stop frequency entered.

**SIGNAL ID
 ON/OFF**

Since no preselector is contained when using the external mixer, multiple spectra will appear against one signal due to image and multiple response. When the SIGNAL ID function is operating, the true signal is identified through the identification operation for each sweep. When the true signal is identified, the spectrum display position will not be modified.

(3) Selecting the External Mixer Correction

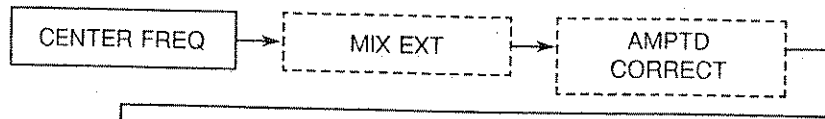

AVG LOSS
ON/OFF

Enter the average conversion loss of the external mixer to be used with the Ten keys and the ENTER  key.

If this key is set to ON, the measurement results will be corrected by the conversion loss entered.

This function is canceled, when this key is set to OFF.

LOSS: FREQ
EDIT

When this key is pressed, the table and menu to enter the conversion loss of the external mixer to be used will appear.

LOSS: FREQ
ON/OFF

If this key is set to ON, the correction specified in the above step is executed by the LOSS:FREQ EDIT.

This function is canceled when the this key is set to OFF.

(4) Entering the External Mixer Correction Data

Press the following keys in the sequence as shown:



The window as illustrated below will appear so that data can be entered. The data is scrolled with the Data knob and Step key.

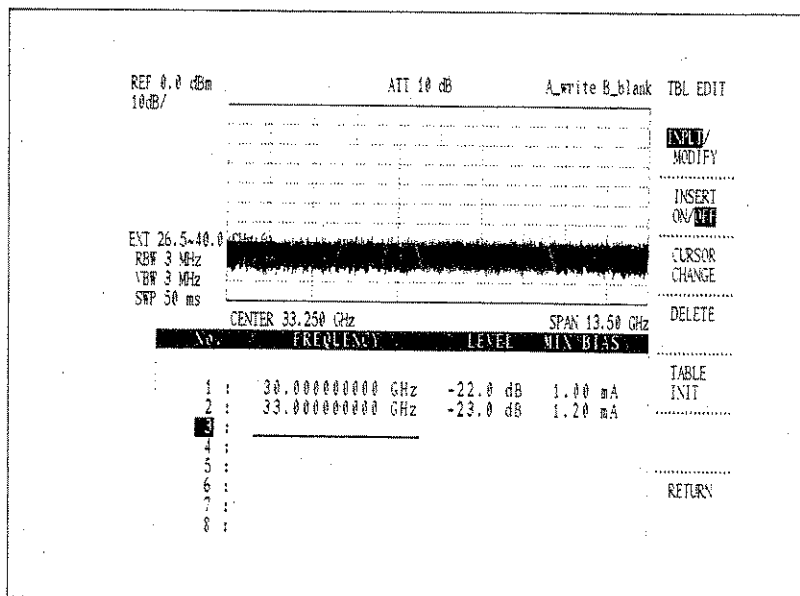

Fig. 5.1-2 Entering the External Mixer Correction Data

INPUT/MODIFY

This key is used to switch between the Input and Modify modes. This function operates on the item underlined.

In the Input mode, enter the frequency, level and bias current in this sequence. One-point data is defined by these three values. The data entered will be sorted in the ascending order.

In the Modify mode, modify the data which has been entered per frequency and per level, and the data modified will be sorted.

INSERT ON/OFF

When this function is set to ON, an empty line is inserted in the cursor line prompting data entry.

CURSOR CHANGE	This key switches the input between Frequency, Level and Bias.
DELEE	This key deletes the cursor line.
TABLE INIT	When this key is pressed, menu of "CONFIRM" will appear, and all the data entered will be deleted.
RETURN	When this key is pressed, the window will be closed and the preceding menu will appear.

5.1.2 Frequency Span

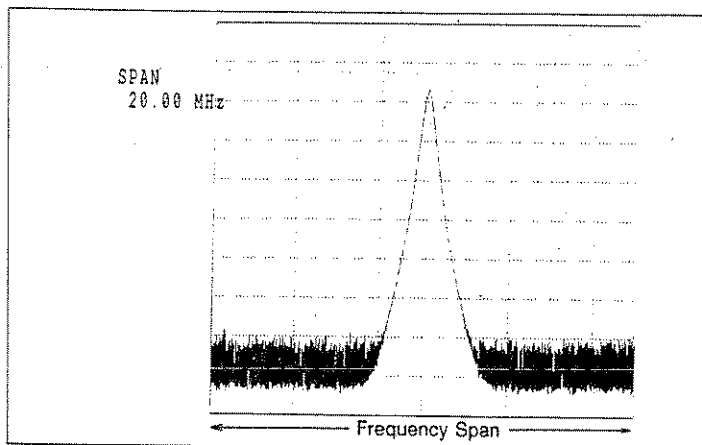
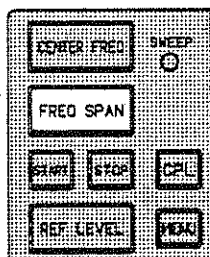

Fig. 5.1-3 Frequency Span

FREQ SPAN

When this key is pressed, the analyzer enters Frequency span setting mode.

You can enter data. The frequency span data will appear on the screen.

CAUTION

Modification can be made if the Frequency span mode is set to Linear, and not if set to LOG span mode.

(1) Frequency Span Display Resolution

Table 5.1-3 Frequency Span Display Resolution

Frequency Span Display Resolution	
10 MHz (Span > 4000 MHz)
1 MHz (4000 MHz ≥ Span > 400 MHz)
100 kHz (400.0MHz ≥ Span > 40.1 MHz)
10 kHz (40.00MHz ≥ Span > 2.01 MHz)
1 kHz (2.000MHz ≥ Span > 401 kHz)
100 Hz (400.0MHz ≥ Span > 20.0 kHz)
10 Hz (20.0MHz ≥ Span > 2.00 kHz)
1 Hz (2.000MHz ≥ Span)

(2) Span Menu

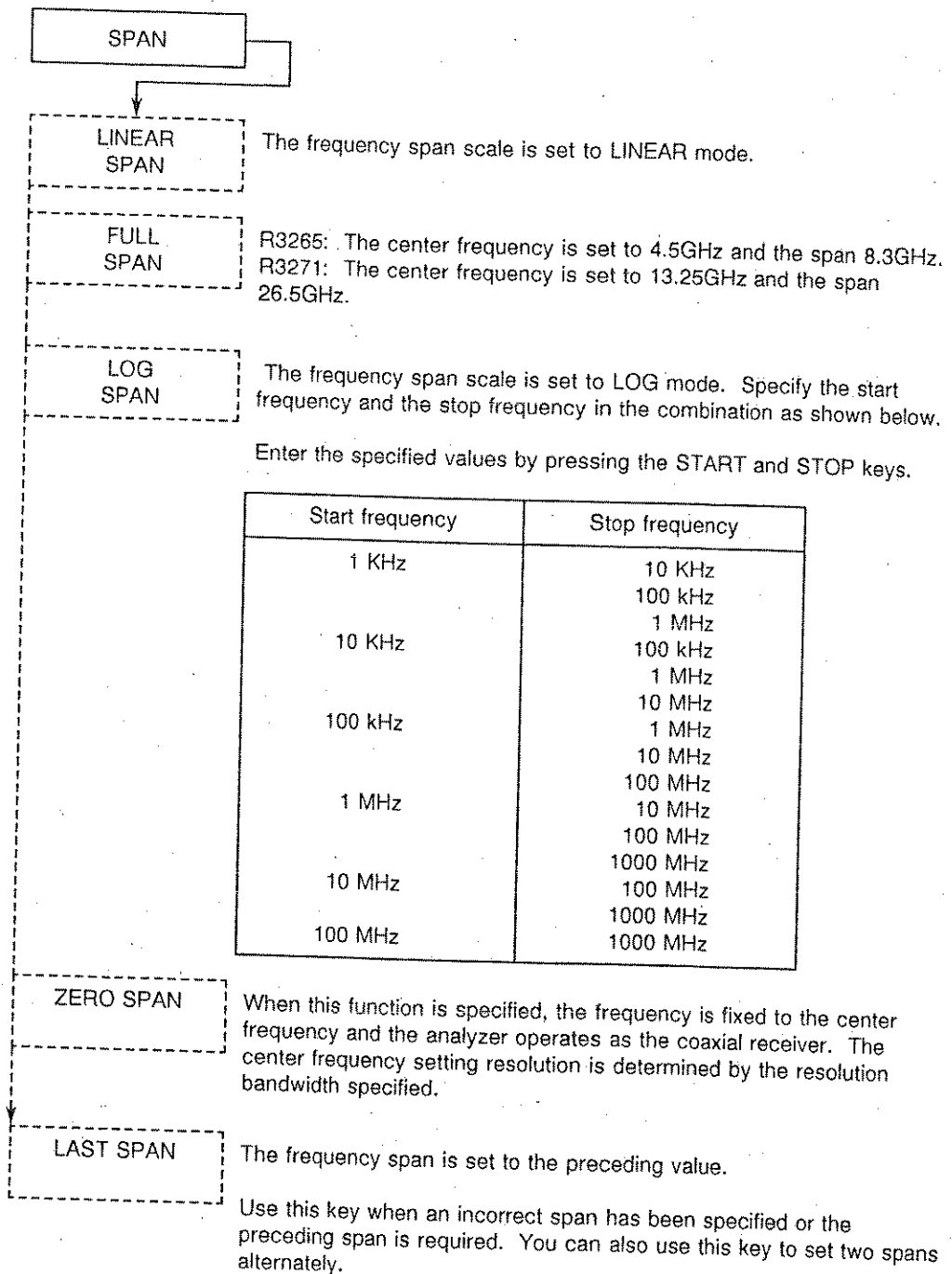

5.1.3 Start and Stop Frequency

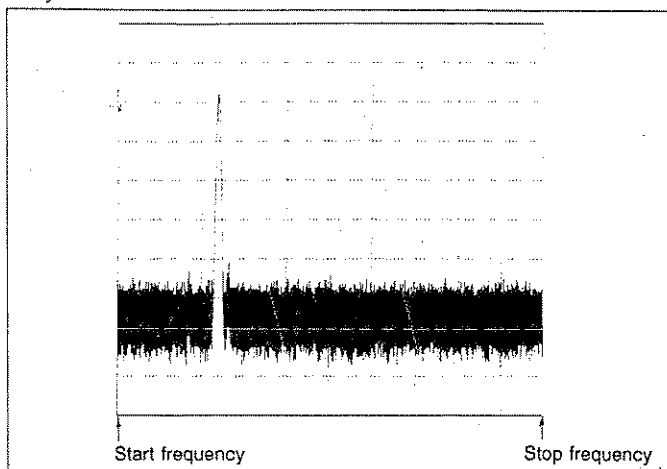
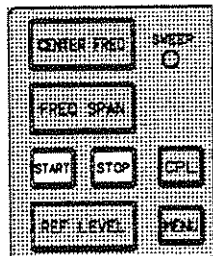

Fig. 5.1-4 Start/Stop Frequency

START

R3265: 0Hz to 8GHz (Initial value 0Hz)
R3271: 0Hz to 26.5GHz (Initial value 0Hz)

STOP

R3265: 0Hz to 8GHz (Initial value 8.3Hz)
R3271: 0Hz to 26.5GHz (Initial value 26.5Hz)

CAUTION

In LOG span mode, the start frequency (stop frequency) is replaced with an approximate value to the value specified.

FREQ OFS
ON/OFF

If this function is set to ON, the offset frequency can be set within the range from 0 to $\pm 100,000$ MHz. However, in case data below the display resolution has been entered, the value of the display resolution is automatically set.

Start (or Stop) frequency (display) = Start (or Stop) frequency (specified) + Offset

If the function is set to OFF, the offset is canceled.

+/-

Select the sign of the offset frequency setting.

5.1.4 Reference Level

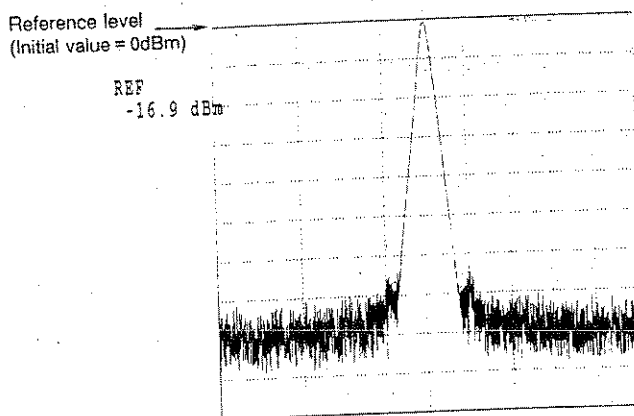
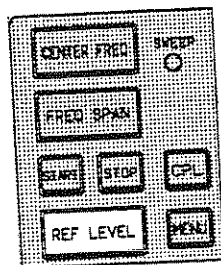
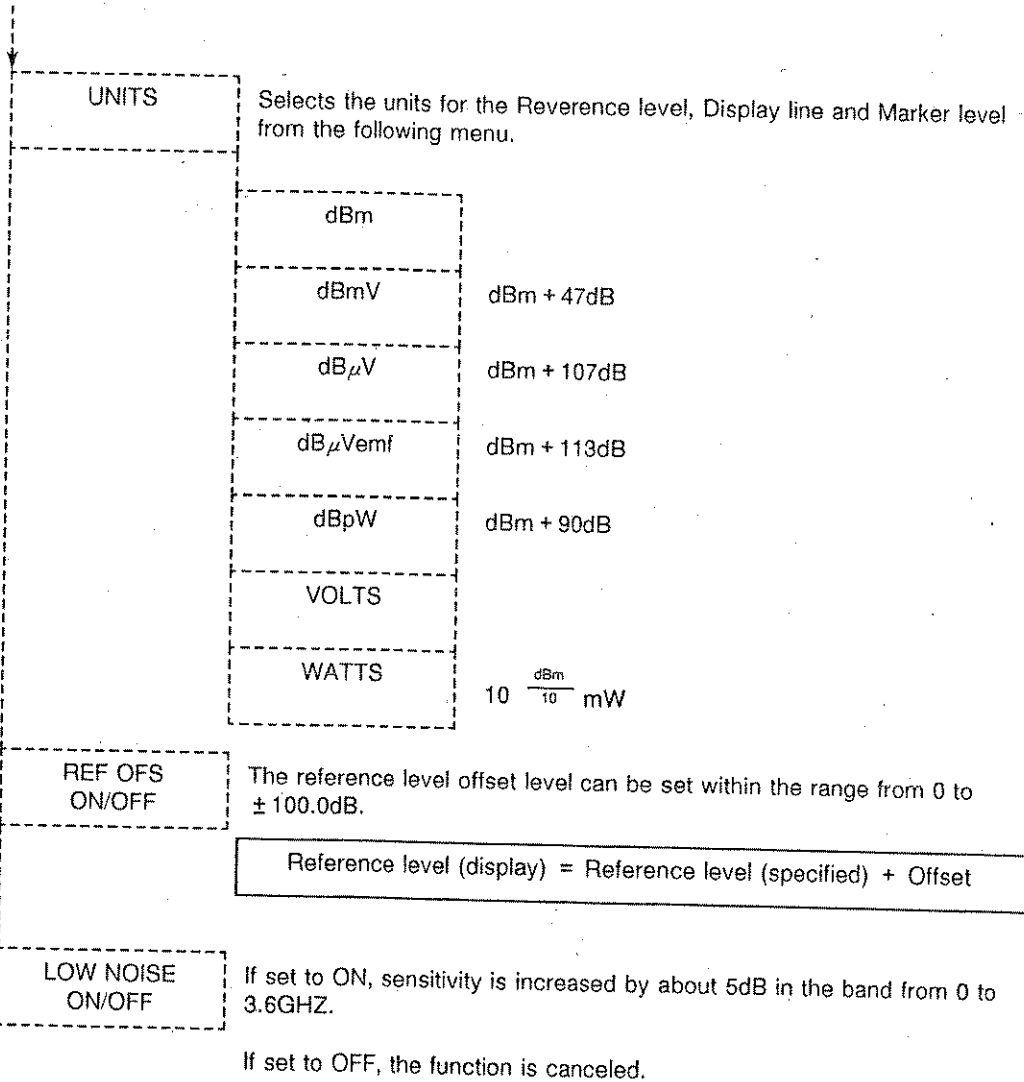

Fig. 5.1-5 Reference Level

REF LEVEL	The reference level can be set within the range from -149.9 to $+60$ dBm.
CAUTION	
In case the input attenuator has been set to MANUAL or MIN ATT, the reference level setting range may be narrower than specified here (-149 to $+60$ dBm).	
x dB/div	The amplitude scale can be set to 10dB/div to 0.1dB/div.
LINEAR	The reference level data is displayed in voltage unit. An error may be contained in the value displayed in voltage unit which has been converted from the dBm unit.
x 1	The interval from 0V to REF level is displayed in Linear: $(\text{REF level}/10)/\text{div}$
x 2	Display is multiplied by two according to the Reference level. $(\text{REF level}/20)/\text{div}$
x 5	Display is multiplied by five according to the Reference level. $(\text{REF level}/50)/\text{div}$
x 10	Display is multiplied by ten according to the Reference level. $(\text{REF level}/100)/\text{div}$



CAUTION

1. The LOW NOISE function is provided only in the R3265, and not in the R3271.
2. If the LOW NOISE function is set to ON, the tertiary modulation distortion or 1dB gain compression will be deteriorated. Therefore, set this function OFF when measuring distortion.

5.1.5 Couple (Interlocked functions)

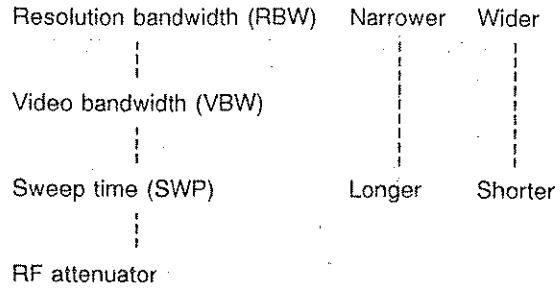
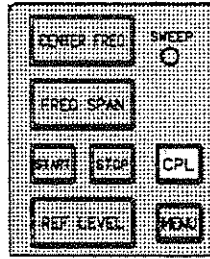

(1) Resolution Bandwidth

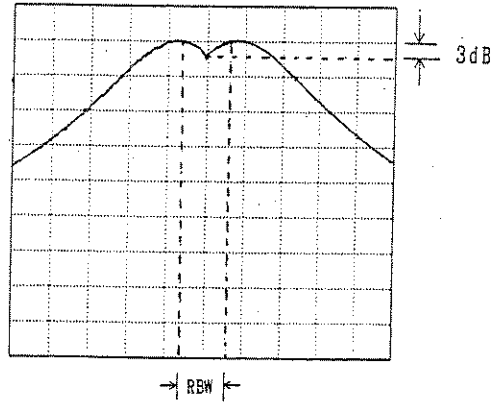
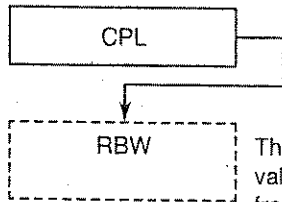

Fig. 5.1-6 RBW: The Maximum IF Bandwidth which can be Separated as Two Signals

When the RBW is set to a narrower value, the spectrum becomes slender and the resolution is increased. Consequently, separation of adjacent noise from the spectrum to be measured or separation of a spectrum from another spectrum can be executed. However, as the resolution becomes narrower, the time required for measurement will increase. If the sweep time is not sufficient, the signal level is lowered and message UNCAL will appear.



The RBW can be set within the range from 10Hz to 3MHz. The initial value is AUTO and the optimal RBW is selected in accordance with the frequency span. (See Table 5.1-4.)

Table 5.1-4 RBW Automatically Selected

Frequency span	RBW
Span \geq 200MHz	3 MHz
200 MHz > Span \geq 60MHz	1 MHz
60 MHz > Span \geq 20MHz	300 kHz
20 MHz > Span \geq 6MHz	100 kHz
6 MHz > Span \geq 2MHz	30 kHz
2 MHz > Span \geq 300kHz	10 kHz
300 kHz > Span \geq 100kHz	3 kHz
100 kHz > Span \geq 30kHz	1 kHz
30 kHz > Span \geq 10kHz	300 Hz
10 kHz > Span \geq 5kHz	100 Hz
5 kHz > Span \geq 1kHz	30 Hz
1 kHz > Span	10 Hz

(2) Video Bandwidth (VBW)

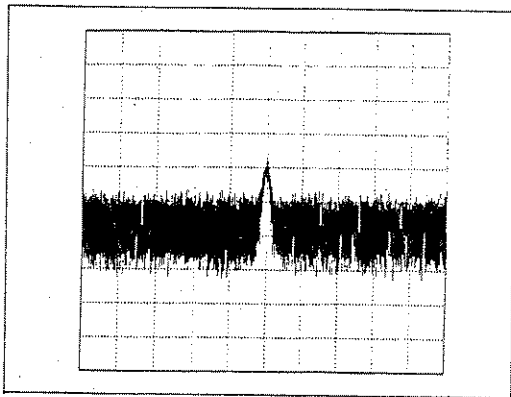

Fig. 5.1-7 VBW = 300kHz

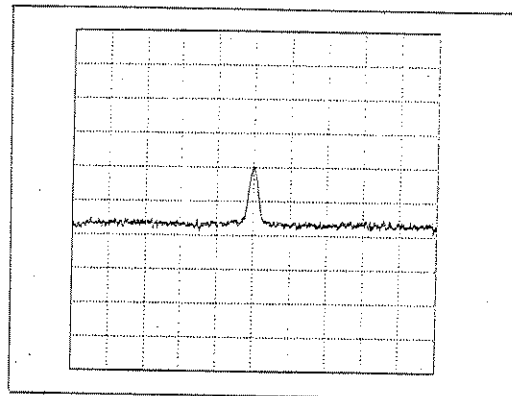
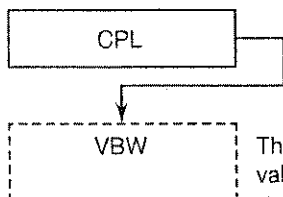

Fig. 5.1-8 VBW = 3kHz

The video bandwidth is used to detect signal buried in noise by averaging the noise overlaid on the waveform and the noise at the bottom. The noise averaging is executed by inserting a low pass filter into the detected signal. Thus the S/N ratio is improved by about 10dB. To increase the efficiency of averaging, set the bandwidth of the low pass filter in accordance with the RBW. (1/10 of the RBW or below)

In case the VBW is set too narrow, the measurement level is lowered due to the time constant of the low pass filter and the message UNCAL may appear. In such a case, set the sweep time longer.



The VBW can be set within the range from 1Hz to 3MHz. The initial value is AUTO and the RBW = VBW.

(3) Sweep Time (SWP)

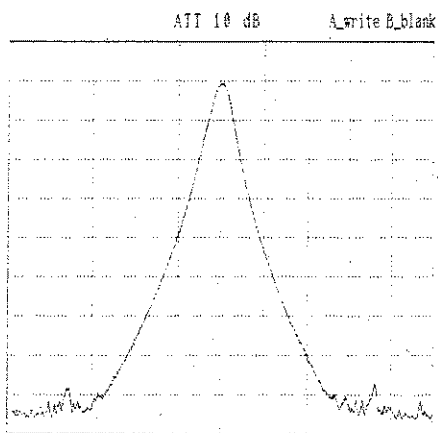

Fig. 5.1-9 SWP = AUTO (500ms)

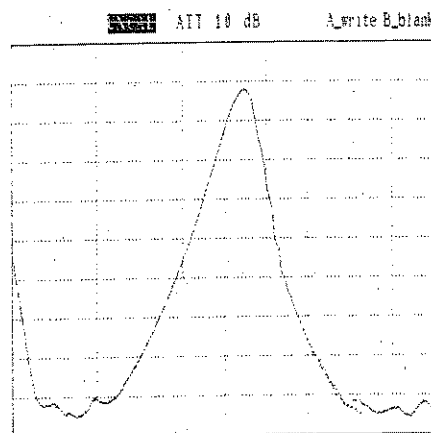
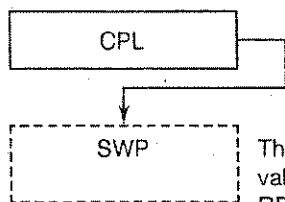

Fig. 5.1.10 SWP = 50ms

If the sweep is set too fast and the signal cannot be displayed in time, an error is caused in the level display and the message **UNCAL** will appear at the center of the screen. In such a case, set the sweep time longer.



The SWP can be set within the range from 20ms to 1000ms. The initial value is AUTO to select a range in accordance with the frequency span, RBW and VBW so that no level error will be caused.

If Span = 0Hz, the setting range is from 50μs to 1000s.

The relationships of the SWP AUTO value with the Frequency span, RBW and VBW

$$\text{Frequency span} / \{ \text{RBW} * \text{Min}(\text{RBW}, \text{VBW}) * 0.5 \} = \text{SWP}$$

(4) Input Attenuator (ATT)

The attenuator is used to prevent the input block damage and attenuate the input signal amplitude to a level which facilitates easy observation as well as to prevent the generation of distortion.

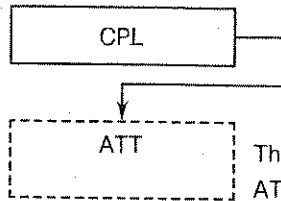

The ATT can be set within the range from 0 to 7dB. However, if MIN ATT has been set to ON, a value lower than the MIN ATT value cannot be set.

The initial value is AUTO (10dB) and the optimal ATT value in accordance with the reference level is automatically set.

(5) AUTO Selection

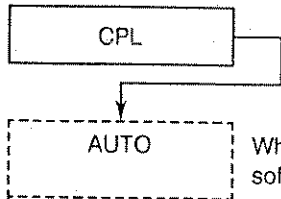

When setting the COUPLE function to AUTO, select the AUTO in the soft menu.

The function which is currently in data entry mode will appear in reversed (black-white) display. The others will appear in white.

Example: RBW In Data entry mode and in Manual mode.

RBW In Manual mode.
The RBW at the lower left of the screen is underlined.

RBW In AUTO mode.



All the COUPLE functions are set to AUTO.

(6) Menu on page 2



MIN ATT
ON/OFF

This key operation will determine the minimum value in the input attenuator AUTO mode.

If this function is set to OFF, 10dB is set.

This function is used to protect the input and prevent errors in level measurement and distortion measurement.

- (Example)
- In level measurement, set the MIN ATT so that the mixer input level will be -10dBm or below.
($\text{MIN ATT} \geq \text{Signal level} + 10\text{dB}$)
 - In distortion measurement, set the value as follows.
 $\text{MIN ATT} \geq \text{Signal level} + 30\text{dB}$ (0 to 3.6GHz)
 $\text{MIN ATT} \geq \text{Signal level} + 10\text{dB}$ ($>3.6\text{GHz}$)

RBW:SPAN
ON/OFF

Set the ratio of the resolution bandwidth against the span.

If the RBW has been set to AUTO, the RBW value is automatically determined for the span in the ratio specified here.

The value from 0.1 to 0.001 can be entered.

The initial value is 0.01.

VBW:RBW
ON/OFF

Specify the ratio of the video bandwidth (VBW) against the resolution bandwidth (RBW). If the VBW has been set to AUTO, the VBW is automatically determined according to the RBW value in the ratio specified.

The initial value is 1.

DIGITAL IF
I/II/OFF

If the Digital IF is set to I, the Digital IF is set when the RBW is 100Hz or below. If the Digital IF is set to II, the Digital IF is set when the RBW is 30Hz or below.

When the span is set to 200kHz or more, or 0Hz, the Digital IF mode is automatically switched to the Analog IF mode.

If the Digital IF is set to OFF, Analog IF is set.

CAUTION

1. When the Digital IF is used, the functions described in Table 5-5 cannot be used.
2. The RBW 30Hz and 10Hz in Analog IF mode fluctuates in the level due to the change in temperature. Therefore, use it after CAL. No definition has about the bandwidth accuracy, level accuracy and noise level of the RBW 10Hz in Analog IF mode. Setting the RBW 10Hz in the Analog IF mode indicates "RBW 10Hz".
3. The digital IF dynamic range displayed will be about 75dB in the input frequency range of $\pm 300\text{Hz}$.

Table 5.1-5 Function which Cannot be Used in Digital IF

SWEEP TIME
VIDEO BW
MARKER COUNTER
SWEEP TRIGGER
TRACE DET
WINDOW SWP
FULL SPAN
LOG SPAN
ZERO SPAN
EXT TRIGGER
SWEEP MODE
AUTO ZOOM

PREV MENU

The preceding menu will appear.

5.1.6 Menu Keys

(1) Trigger Menu

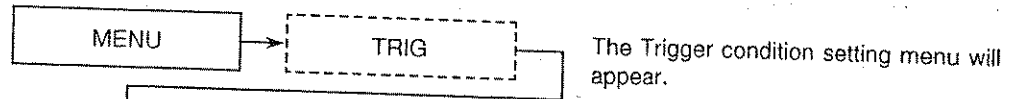

- FREE RUN Sweep is internally repeated automatically. (Initial value)
- LINE Sweep is repeated, being synchronized with the AC power frequency.
- VIDEO Trigger is executed with the waveform on the screen.

When this mode is set, an arrow → will appear at the scale at the leftmost of the screen to indicate the trigger position. You can set the trigger level with the Data knob, Step key and Ten keys.

The position of the trigger level is indicated at the full scale 100 in the active area of the screen.

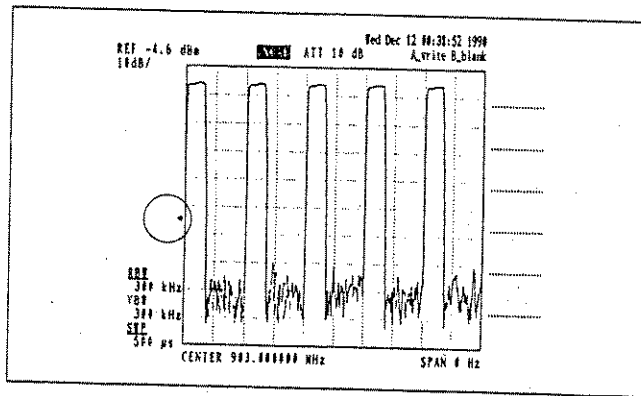

Fig. 5.1-11 Trigger on the Waveform on the Screen

- TV-V Trigger is executed with the Vertical synchronous signal of the TV video waveform.

When this mode is set, an arrow → will appear at the scale at the leftmost of the screen to indicate the trigger position. You can set the trigger level with the Data knob, Step key and Ten keys.

The position of the trigger level is indicated at the full scale 100 in the active area of the screen.

- TV-H The sweep is triggered with the Horizontal synchronous signal of the TV signal (NTSC).

This trigger becomes valid at the sweep time 20ms or below.

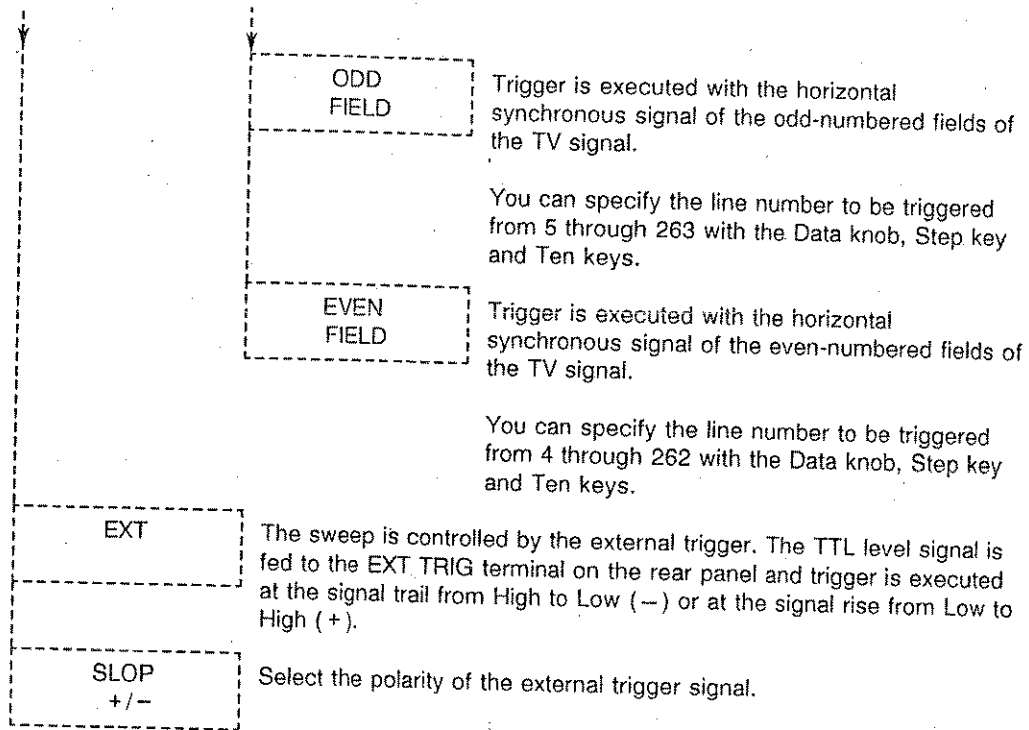

(2) Detection mode menu

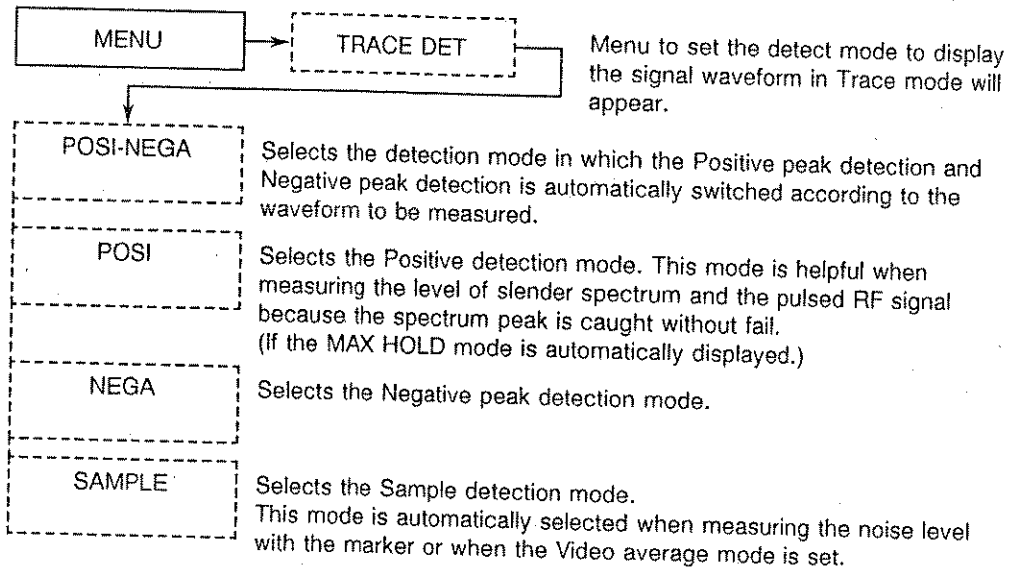

(3) Sweep mode menu

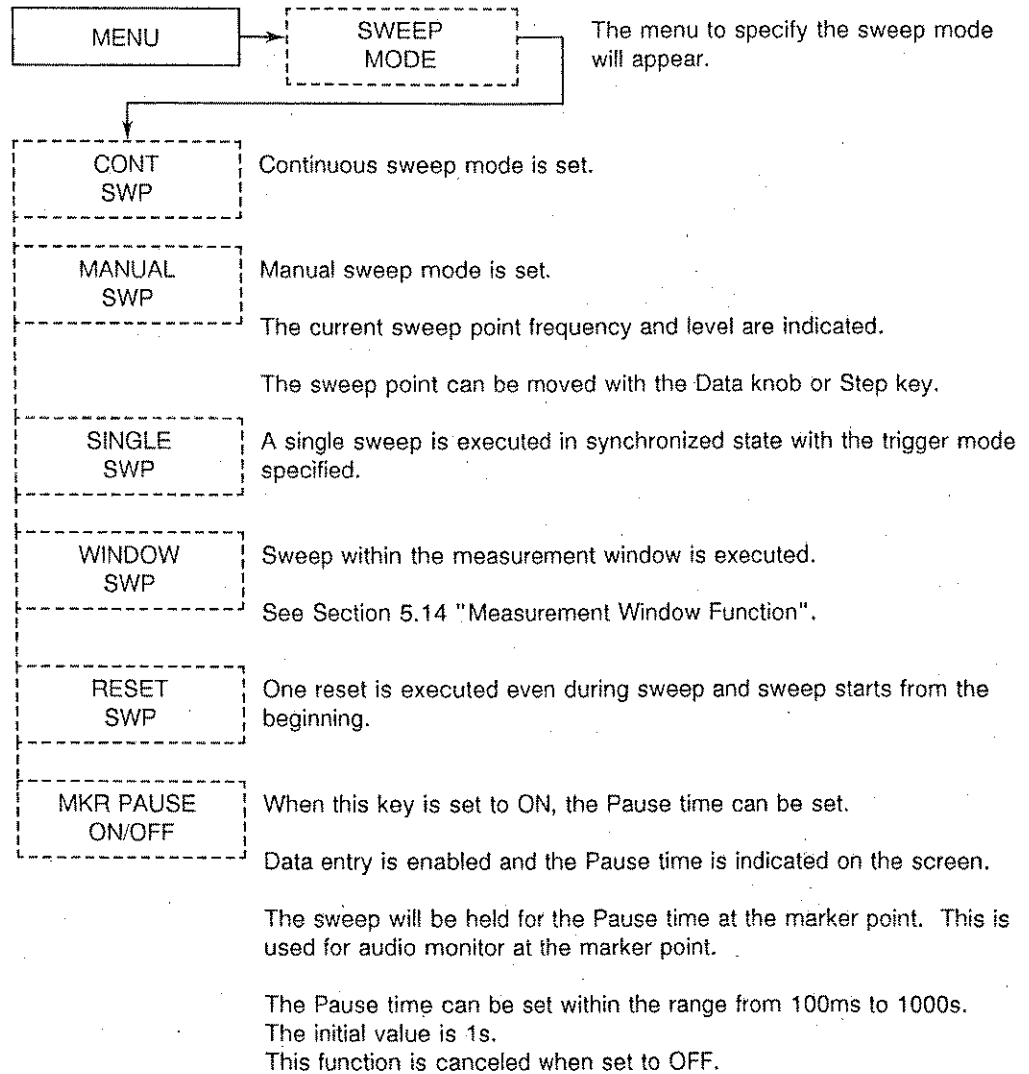

CAUTION

The MKR PAUSE function cannot be used in Zero span mode.

(4) Sound menu

A marker will appear and the demodulated wave at the marker point can be heard with the internal speaker.

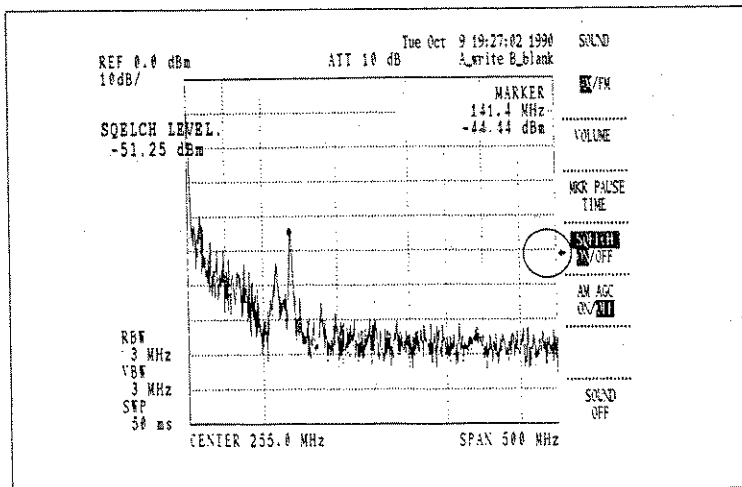
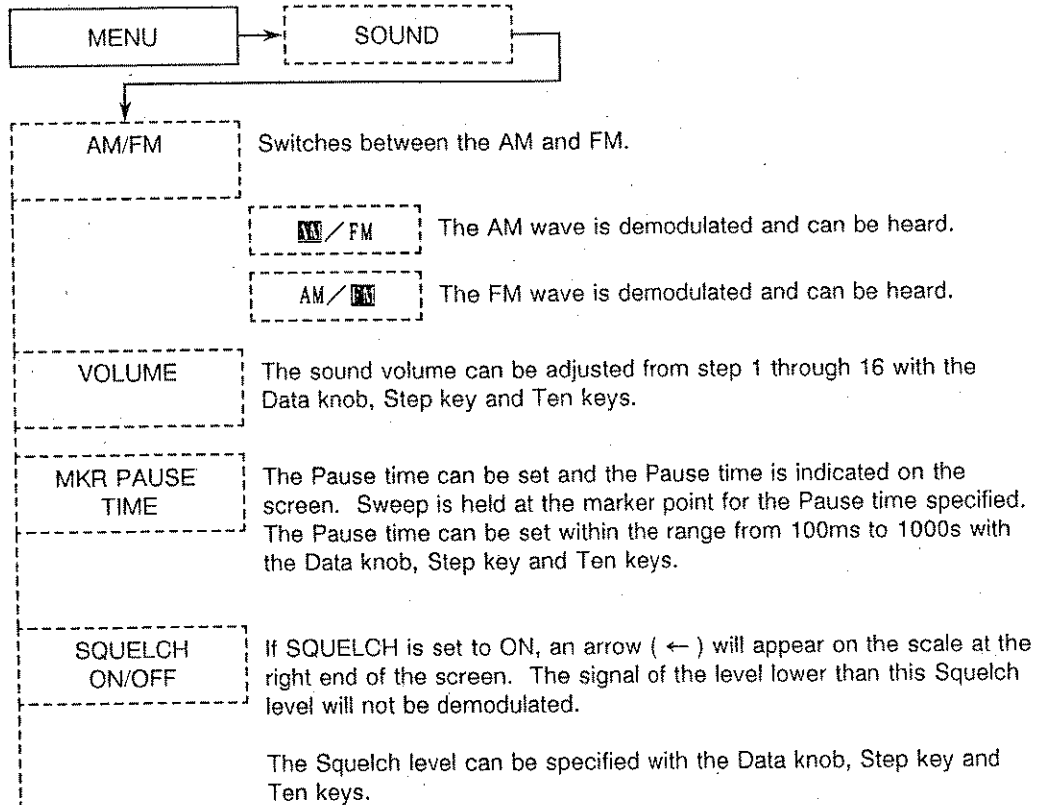
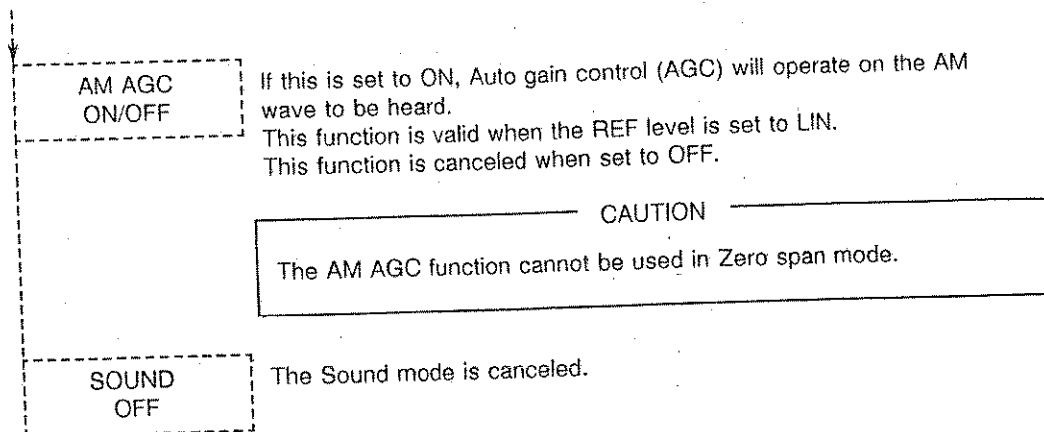

Fig. 5.1-12 Setting the Squelch Level



(5) Use as the Fixed Synchronous Receiver

① Set the marker at the spectrum to be monitored.

② Press the keys to set Sound monitor state.

③ Set the Pause time as follows.

Press the and enter the Pause time.
(For example, if setting 10 seconds, press the keys.)

④ Selecting the demodulation type

Press the key to select AM or FM.
The one reversed in black-white is specified.

⑤ Adjusting the sound volume

Press the and make adjustment with the Data knob and Step key.

⑥ Setting the SQUELCH level

Press the key to ON.

The Squelch level is indicated with the arrow ← on the scale at the right side of the screen. specify the Squelch level higher than the Noise level with the Data knob, Step key and Ten keys. Thus, no sound can be heard when no signal is fed.

⑦ Setting SOUND OFF

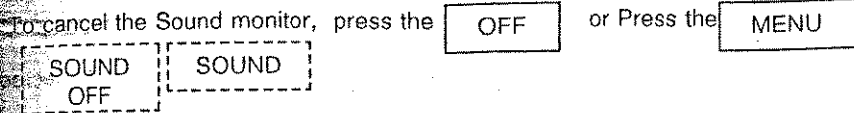

⑥ Setting the Display line

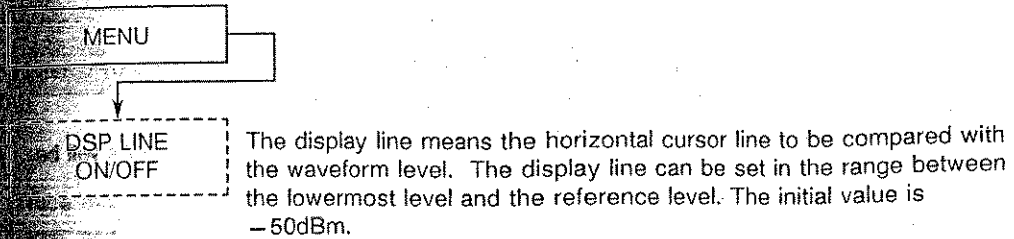

⑤ Selecting the Display type

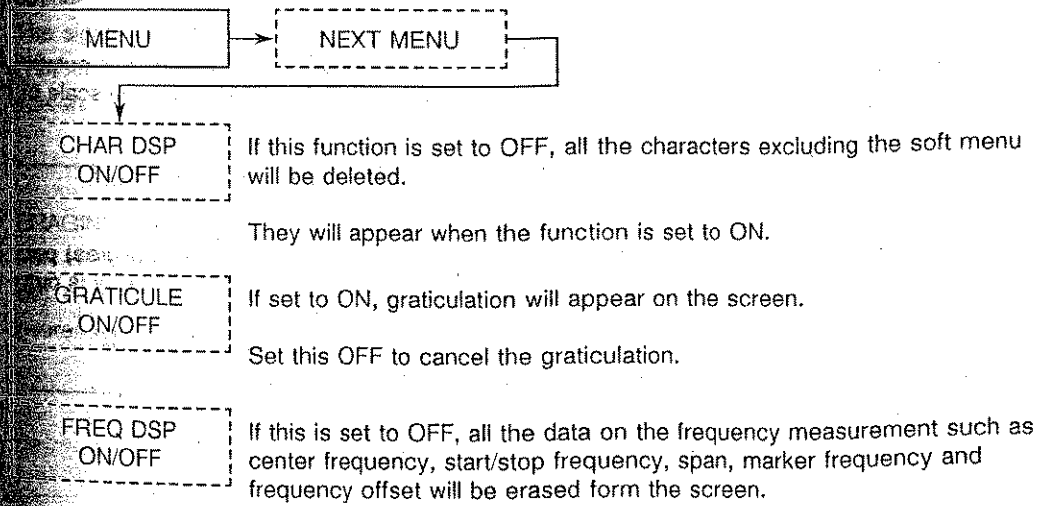

(8) Selecting the Input/Output types

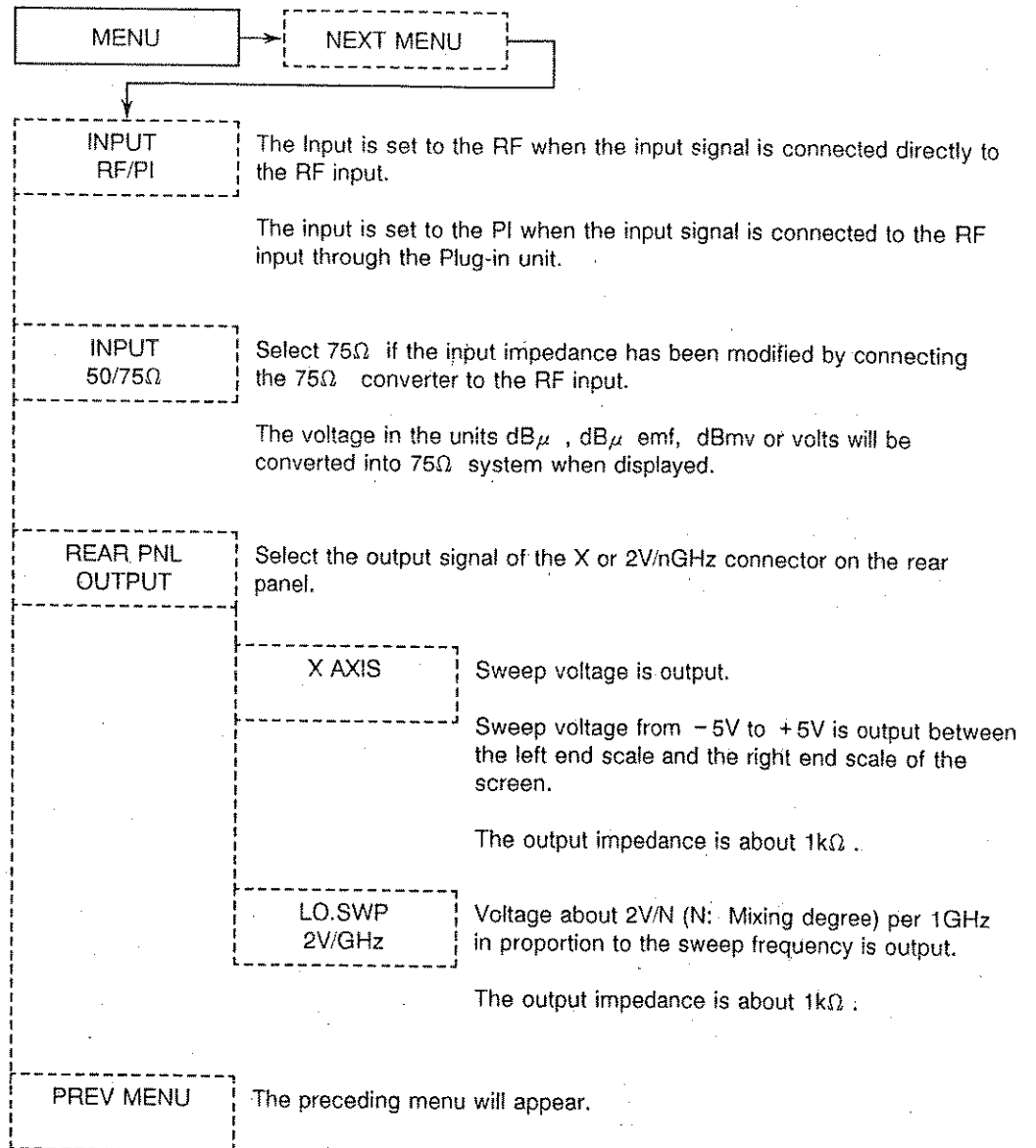

5.2 TRACE Section Functions

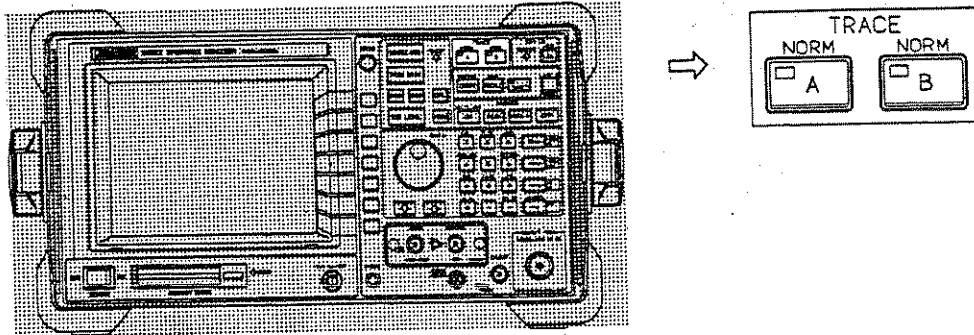

Trace memory A and B are provided. Each of them can be rewritten according to the sweep, store and display any waveform. Various calculation functions are available and various waveform comparisons can be made.

The CRT display consists of 701 points in the horizontal direction and 401 points in the vertical points. When the level data of every horizontal point is displayed, trace (signal waveform) will appear.

The signal input is fed through the RF/IF section and detected by the LOG/LIN amplifier before A/D-converted. The data enters Trace memory and is controlled by the CPU to appear on the screen.

CAUTION

AVERAGING (SAMPLE mode) is not allowed to be executed during MAX HOLD (POSI mode) or MIN HOLD (NEGA mode) measurement. MAX HOLD (POSI mode) or MIN HOLD (NEGA mode) measurement is not allowed to be executed during AVERAGING (SAMPLE mode) measurement. They should be set to different Trace Detection modes.

Memory A and Memory B are provided with identical soft menu functions.
An example of Memory A operation is given below.

(1) Trace mode

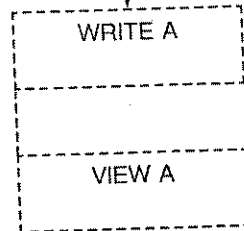
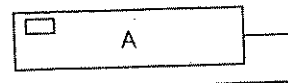

WRITE mode

Memory A is rewritten by every new sweep and the results will appear on the screen.

VIEW mode

If VIEW mode is selected in BLANK mode (explained below), Trace A will appear again. If VIEW mode is selected in other than BLANK mode, Memory A rewriting stops and the waveform on the screen also stops.

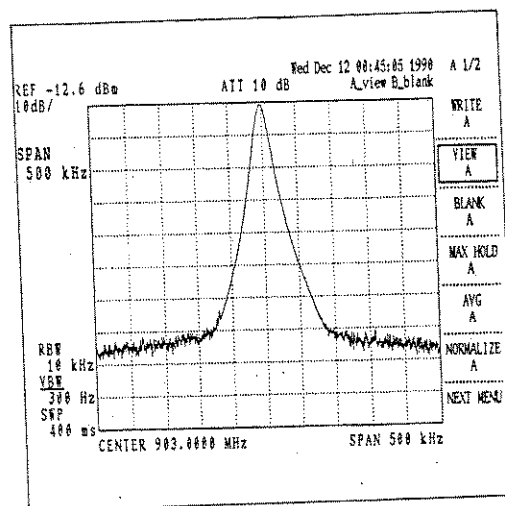

Fig. 5.2-1 Basic Waveform in VIEW Mode

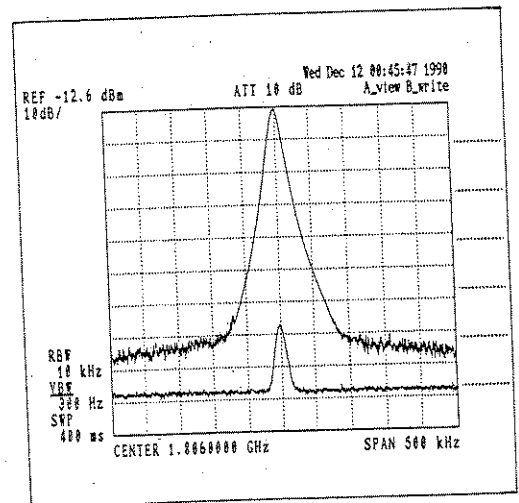
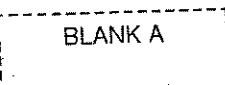

Fig. 5.2-2 Second Higher Harmonics in WRITE B



BLANK mode

Trace A (or B) will be erased from the screen. Memory A (or B) saves the Trace data at the moment when BLANK mode is set.

When VIEW mode is set, Memory A (or B) data will appear on the screen.

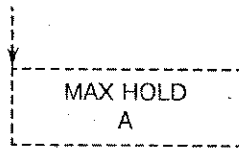

MAX HOLD mode

The point data on the frequency axis is compared to new data at every sweep, and the greater one is saved in memory and it will appear on the screen. Consequently, the waveform will be trace of the maximum values in the time series. In this mode, Trace Detection mode is automatically set to POSI.

(2) Averaging mode

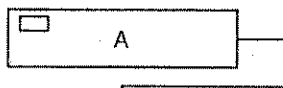

The S/N ratio can be improved in shorter time compared to noise reduction by VIDEO BW. Quantitative analysis of the random components and measurement of signals buried in noise can be performed. In this mode, the Trace Detection mode is automatically set to SAMPLE. the number of times of averaging can be set to 2 through 1000 by 1 step.



If this key is pressed (STP) while Averaging is in progress, the Averaging mode is canceled and Trace mode is set. If the key is pressed again (SRT), Averaging mode operation starts from the beginning.

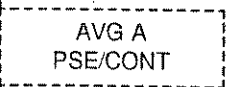

If this key is pressed (PSE) while Averaging is in progress, The Averaging mode is held for a while, and the number of times of Averaging will appear at the upper left of the CRT screen. If this key is pressed again (CONT), The Averaging mode is resumed, starting at the point of hold.

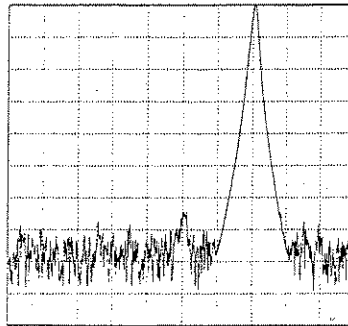

Fig. 5.2-3 AVG = None

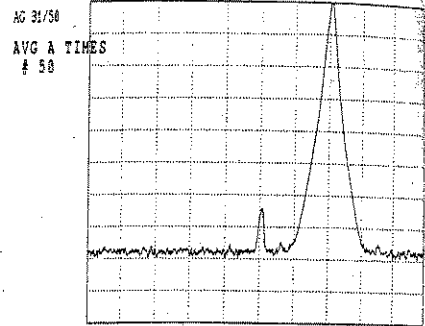

Fig. 5.2-4 ABG = 31 st

AVG A
 CONT/ONLY

If set to CONTINUE, averaging operation will be continued by the Calculation method 2 after the specified number of times are complete.

If set to 1 ONLY, after the specified number of times of averaging is complete, Trace is automatically set to VIEW mode and the Averaging is canceled.

Averaging Calculation Method

If $N \geq n$: Calculation method 1

$$Y_n = \text{Sigma}/n$$
 If $N < n$: Calculation method 2

$$\overline{Y}_n = \frac{((N - 1) \cdot \overline{Y}_{n-1}) + Y_n}{N}$$

n :	The current total of averagings
N :	The number of averagings specified
\overline{Y}_n :	n-th Trace data
\overline{Y}_n :	n-th Average data
\overline{Y}_{n-1} :	(n-1)th Average data
Sigma:	Sum of the data up to n-th

Normalize mode

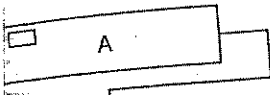

The NORMALIZE function is executed by the signal saved in memory. When actually displayed, the DIS

Input signal - Correction data

NORM A
ON/OFF

The NORMALIZE function is executed by the signal saved in memory. When setting the function ON/OFF, execute CORRECTION DATA.

DSP LINE
ON/OFF

The display line means the horizontal line to compare waveform levels.

(Data setting)
Data knob

The setting resolution is 1 point.

Step key

Increases and decreases by 1-div step.

Ten keys and unit key

The setting resolution is identical to the Display resolution.

NORM A
SAVE CORR

The current Trace A is saved as Correction data into memory. This data will be maintained when the power is turned off.

INSTANT
NORM A

Normalize mode is set.

When this key is pressed, a series of following operations are executed.

- ① A display line will appear almost at the center point between the signal maximum point and minimum point.
- ② The current Trace A is saved as Correction data into memory. (CORRECTION DATA SAVE)
- ③ The NORMALIZE function is set to ON.

(4) Calculation mode

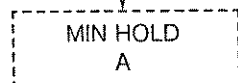

MIN HOLD mode

Every point data on the frequency axis is compared to new data at every sweep and the smaller one is saved into memory to be displayed. Consequently, the waveform will be the trace of the minimum values on time axis. In this mode, the Trace Detection mode is automatically set to NEGA.

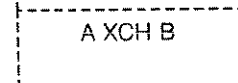

A XCH B mode

The contents of Memory A and Memory B are exchanged.
The contents of Trace A and Trace B are exchanged.

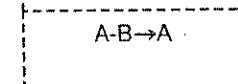

A-B→A mode

For each point, the value of Memory A deleted by the value of Memory B will appear on the screen. The contents of Memory A or the sweep results deleted by the contents of Memory B will be saved into Memory A.

In case of A VIEW of B BLANK, the Memory A contents are deleted by the Memory B contents and the results are saved in Memory A. If Trace A is other than VIEW and BLANK, the sweep results are deleted by the Memory B contents and the results will be saved in Memory A. If Trace B is other than VIEW and BLANK, Trace B is automatically set to B VIEW.

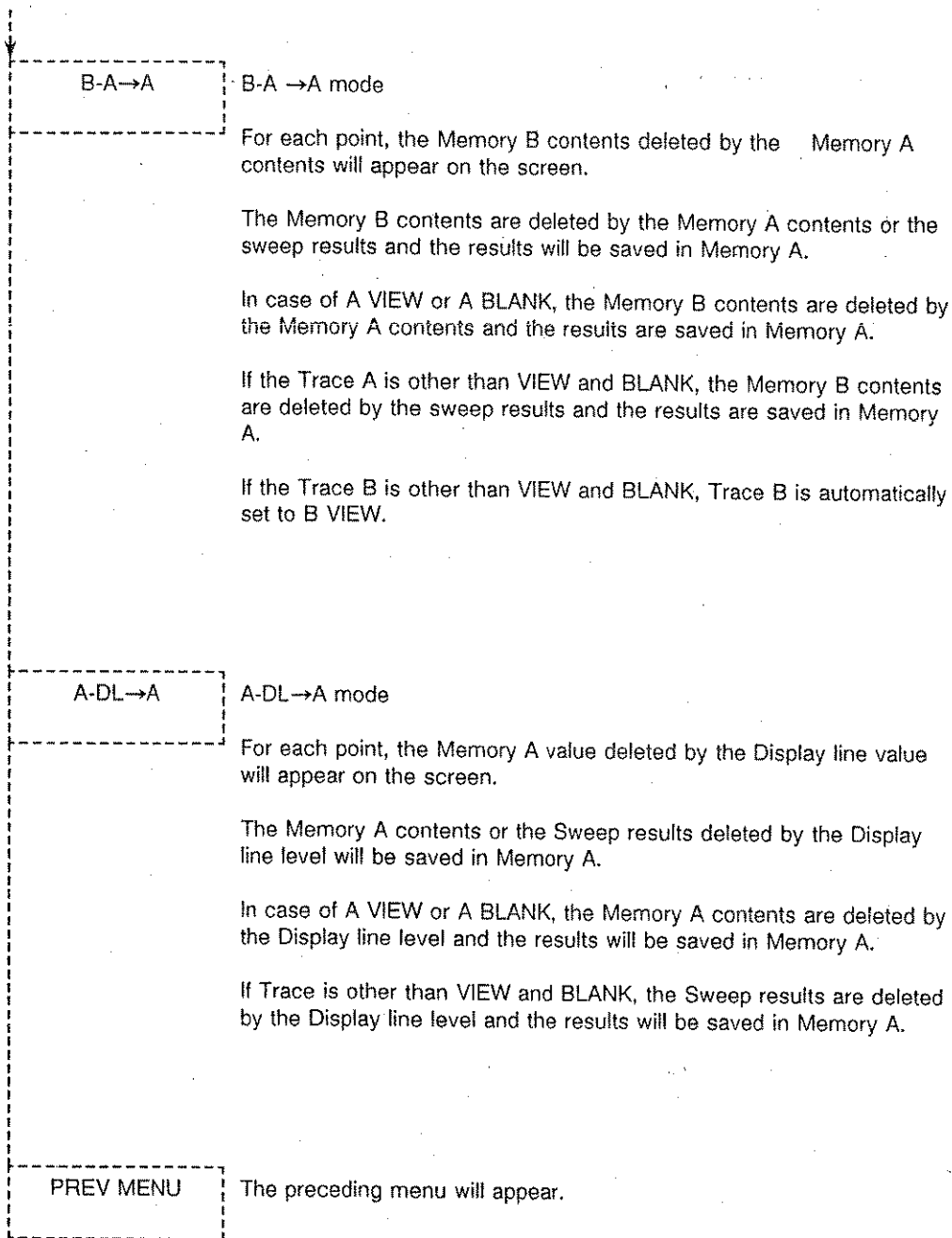

5.3 MARKER Section Functions

The waveform on the screen can be superimposed with the Normal marker and Delta marker to indicate the frequency and the level data.

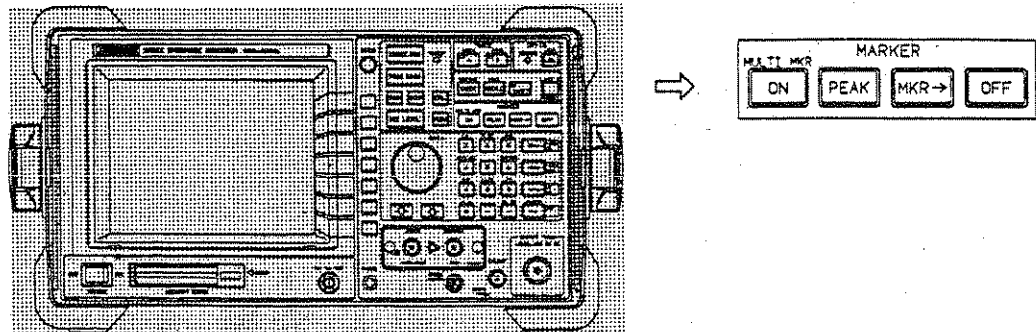

5.3.1 Marker ON



(1) Normal marker and Delta marker

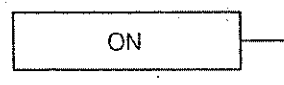

Marker is set to ON and the data on the marker frequency can be entered. The frequency and the level data will appear on the screen.

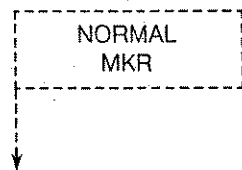

Mode to set the Normal marker frequency is specified.

Data can be entered and the Normal marker frequency together with the level data will appear on the screen.

△ MKR

The Delta (△) marker will appear at the position of the normal marker, and the difference in the frequency and the level data between the delta and normal markers will be indicated. The data is entered according to the difference in frequency between the delta and normal markers. The delta marker is fixed while the normal marker is shifted.

NORMAL
 MKR

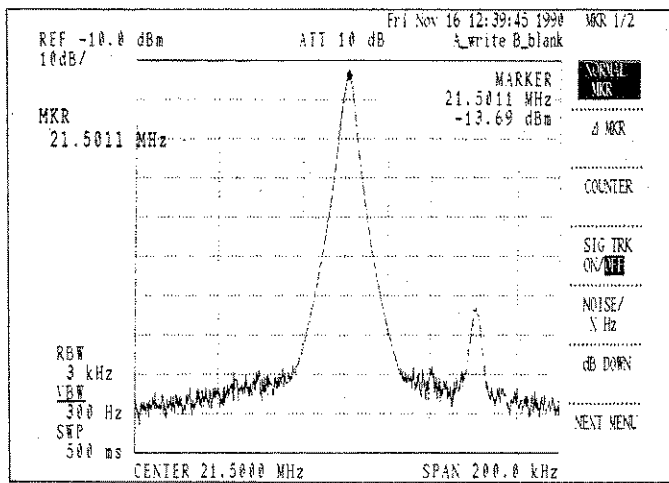

Fig. 5.3-1 Normal Marker

△ MKR

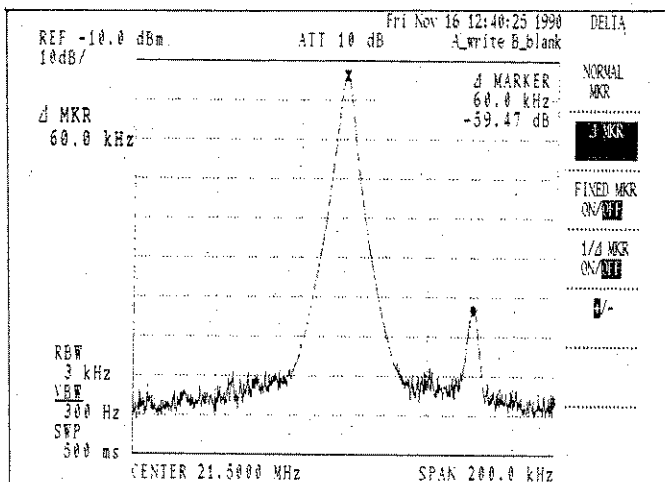

Fig. 5.3-2 Delta (△) Marker

FIXED MKR
ON/OFF

The delta (Δ) marker is fixed to an absolute position on the screen according to the current frequency and level which are stored in memory. The frequency and the level when this function is set to ON will be the reference, even if the center frequency and the reference level are modified, and the marker data will be indicated.

1/ Δ MKR
ON/OFF

The inverse number of the current delta marker is indicated.

This function is helpful to determine the modulation frequency when the modulated wave is demodulated in Zero span mode.

Marker Shift between Trace A and B

As illustrated below, the active marker shift to the point ① of the Trace A waveform when the Trace A key is pressed and to the point ② of the Trace B waveform when the Trace B key is pressed. (Note that the delta marker will not move.)

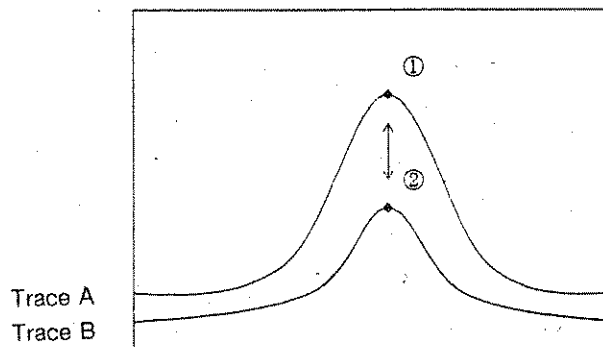

(2) Frequency Counter Function

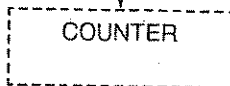
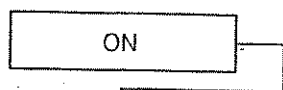

If the marker point is higher than the noise level by 25dB or more, the frequency of the signal containing the marker will be measured with high accuracy. In this case, measurement is made on the frequency of the signal containing the marker instead of the marker itself, and there is no need to set the marker at the spectrum peak. However, the amplitude indicated is the amplitude at the marker point.

In the Normal marker mode, the marker frequency is calculated according to the marker position on the frequency axis from the center frequency while in the Counter mode, the measurement is made directly with

Resolution up to 1Hz can be set with the soft menu. As the counter resolution increases, the gate time becomes longer, and as a result, the sweep time is delayed. This function cannot be used together with the SIGNAL TRACK function.

CNT RES 1kHz	The frequency counter resolution is set to 1kHz.
CNT RES 100Hz	The frequency counter resolution is set to 100Hz.
CNT RES 10Hz	The frequency counter resolution is set to 10Hz.
CNT RES 1Hz	The frequency counter resolution is set to 1Hz.
FREQ CNT /MKR CNT	<p>FREQ CNT: By setting the marker at the spectrum of the signal fed, the input frequency is measured with the accuracy of the internal reference source frequency.</p> <p>MKR CNT: The frequency at the marker point is measured. For detailed information, see the paragraph on the Example of Frequency Measurement in the preceding chapter.</p>
COUNTER OFF	The frequency counter function is canceled.

(3) Signal Track Mode

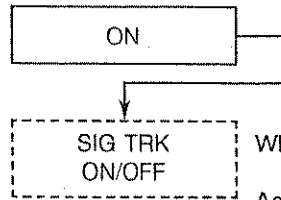

When this key is set to ON, the Signal Track mode is set.

As the signal drifts, the marker follows the signal, and the center frequency is modified. Thus, the signal can always be caught at the center of the screen. However, if the signal drifts out of the screen, it cannot be caught.

If the Span is set narrower in Signal Track mode, the "AUTO ZOOM" function will operate and the span can be modified without missing the target waveform.

To cancel the Signal Track mode, set the key OFF.

CAUTION

Accurate detection can be executed even for the smooth slope by modifying the ΔX and ΔY settings which are explained in the paragraph 5.3.2 Peak Search.

(4) Measuring the Noise/Hz

As Noise level measurement mode, the rms of the noise level normalized at the noise power bandwidth from 1Hz to 100MHz can be measured.

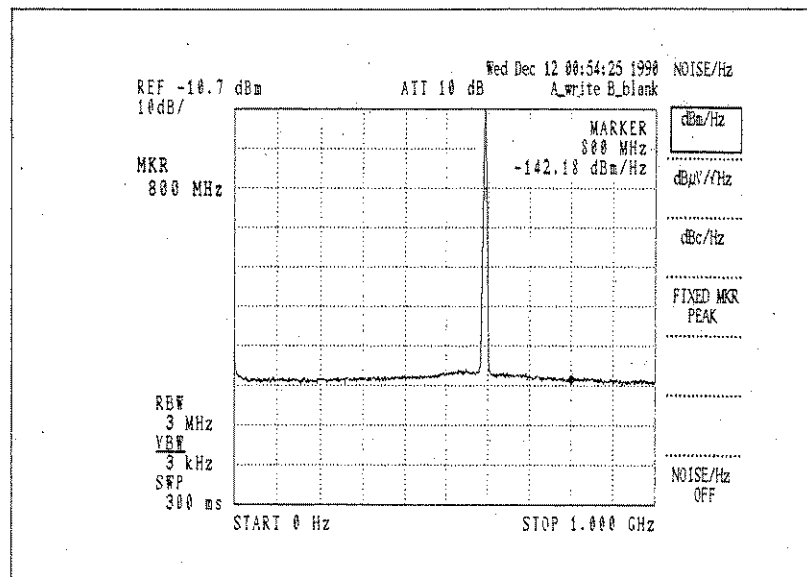
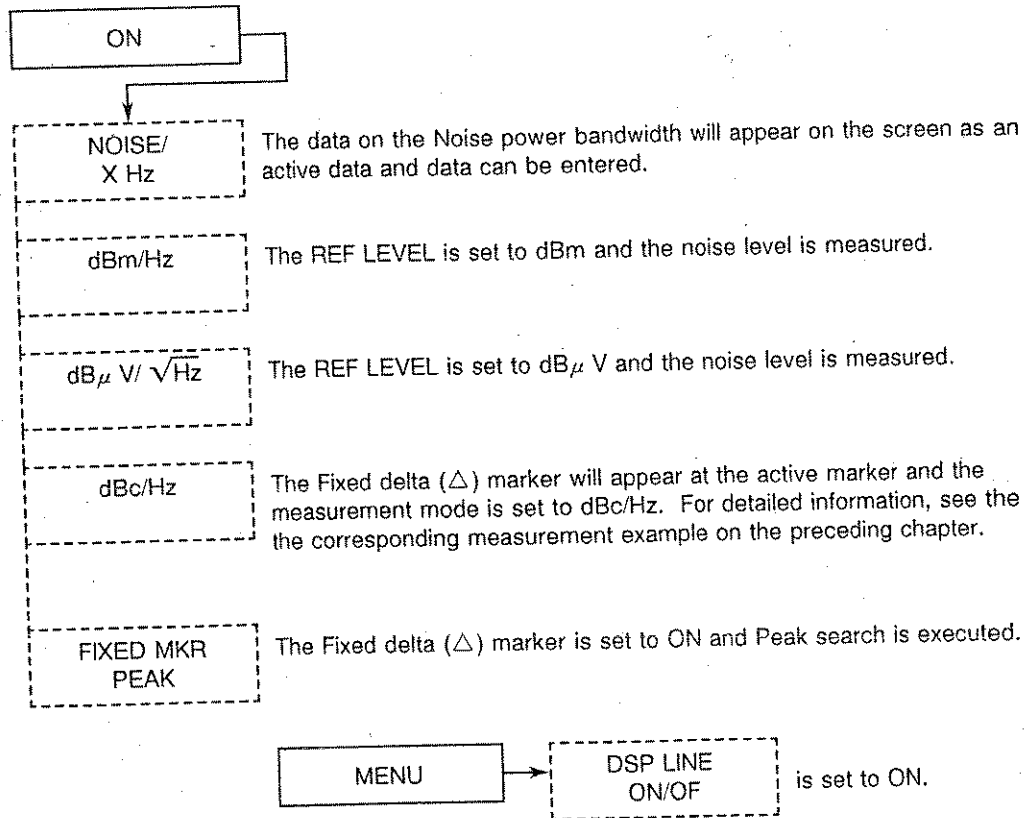

Fig. 5.3-3 Noise/Hz Level Measurement



If the Display Line is set to ON during Noise level measurement, switching can be executed between the Noise level measurement result and the Normal marker display.
If the active marker is below the Display line: Noise level measurement data is displayed.
If the active marker is above the Display line: Normal marker level is displayed.

(5) Setting X dB Down

This function is used to display the difference in the frequency and level between two markers at the XdB from the reference marker. The XdB value can be set within the range from 0 to \pm Screen dynamic range. The initial value 3dB.

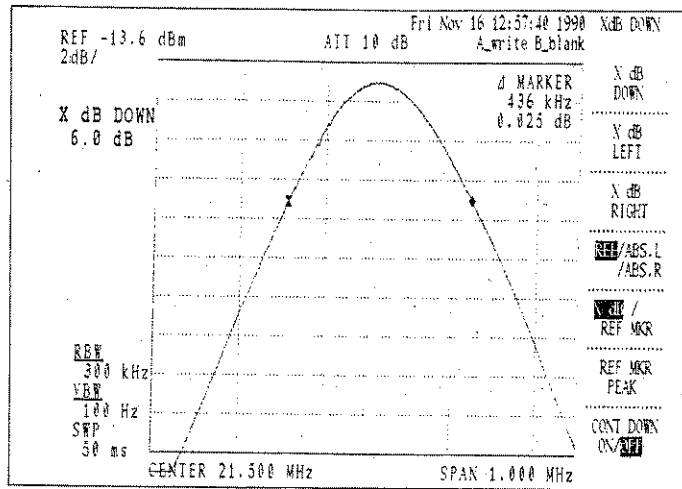
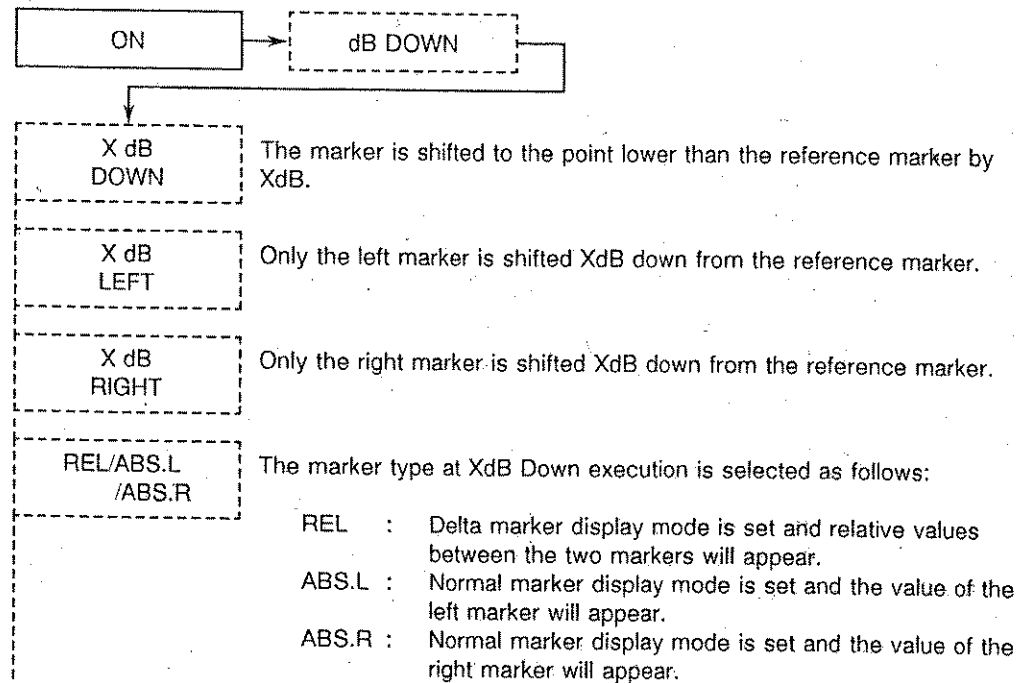
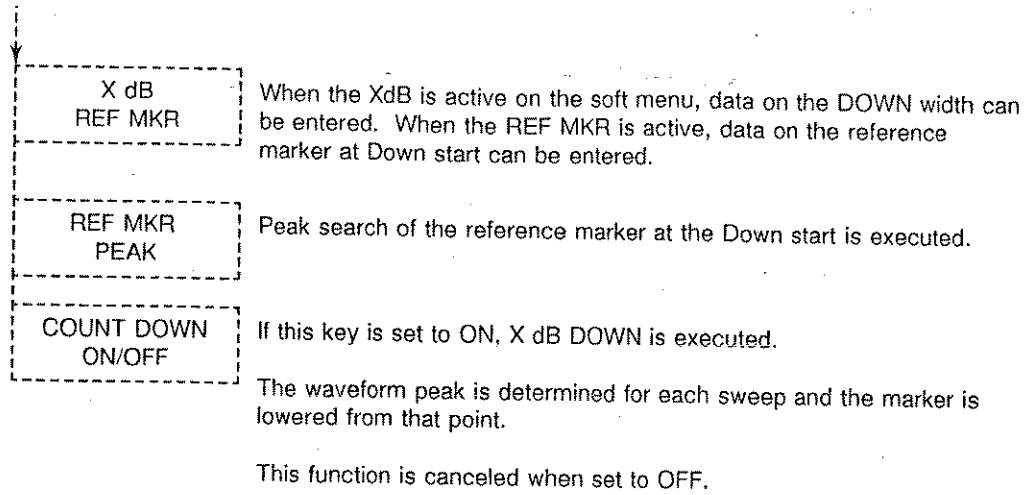
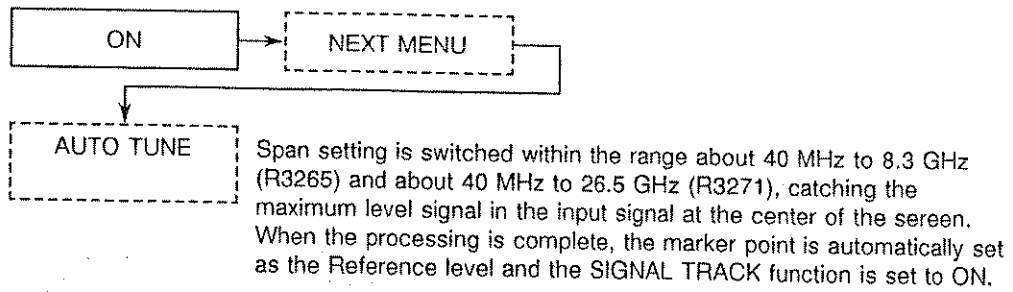

Fig. 5.3-4 XdB Down





(6) Executing the Auto Tuning



CAUTION

If a key operation occurs during AUTO TUNE execution, the operation stops at the current span setting.

(7) Setting the Preselector

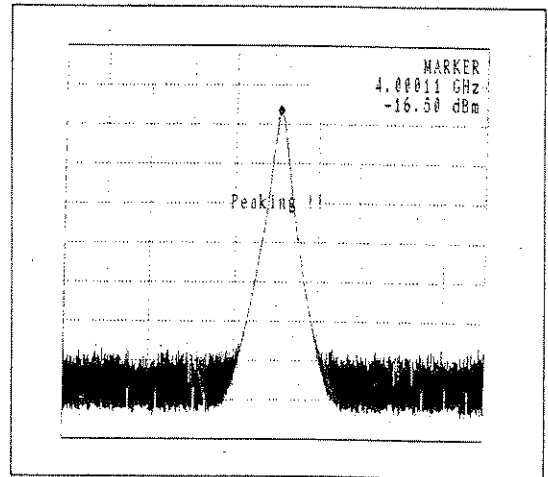
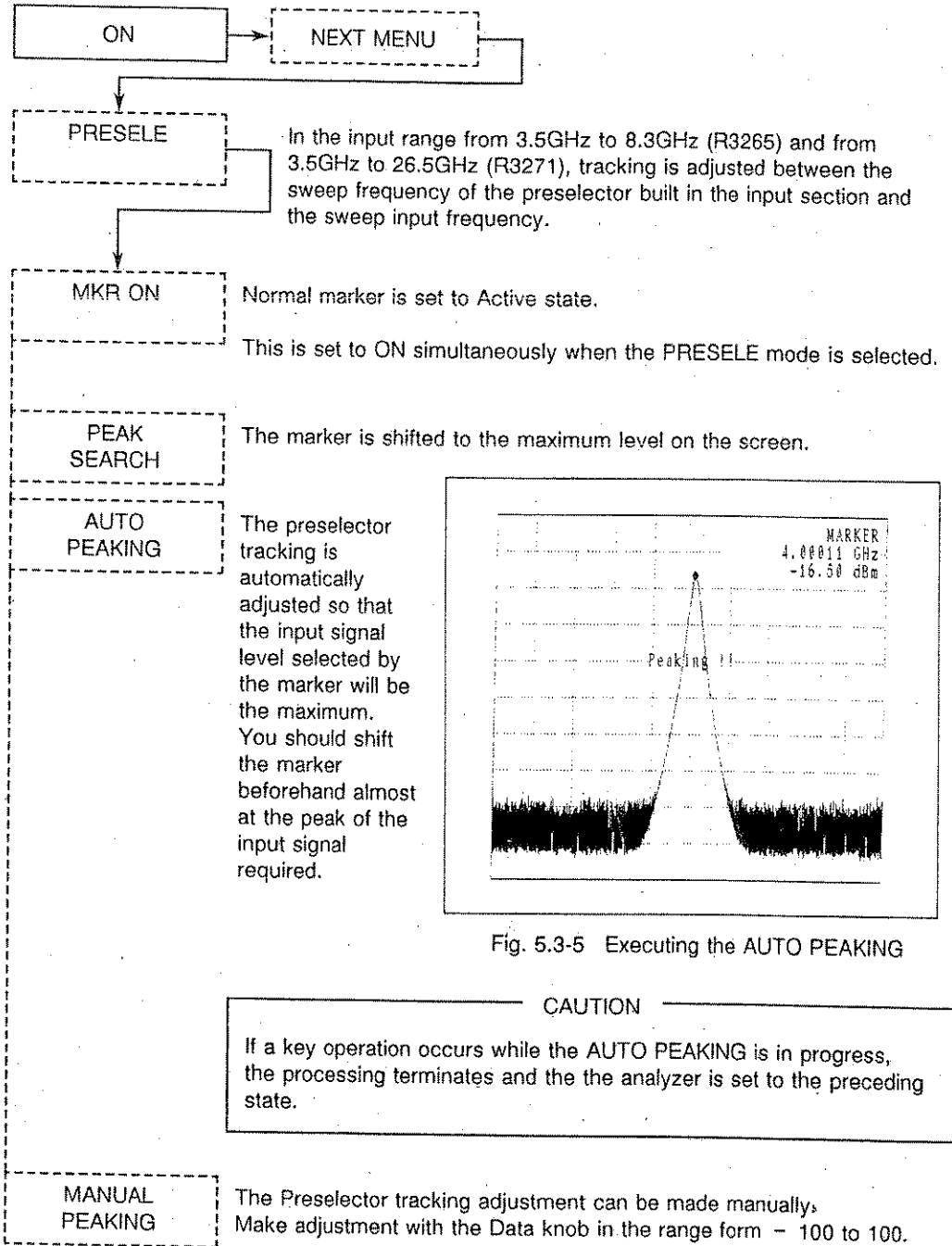
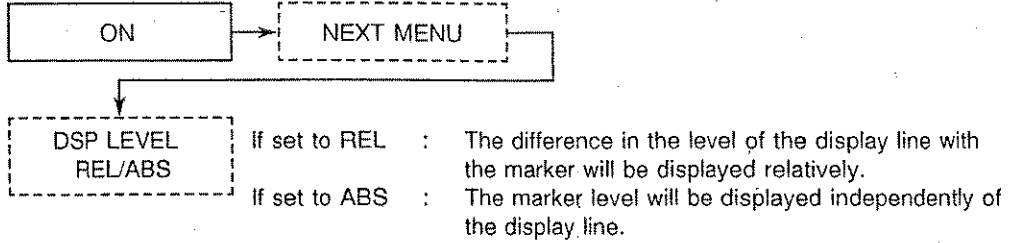

Fig. 5.3-5 Executing the AUTO PEAKING

CAUTION

If a key operation occurs while the AUTO PEAKING is in progress, the processing terminates and the analyzer is set to the preceding state.

- (8) Switching the Marker Level Display at Display Line ON
The Display line operates when set to ON.



CAUTION

When the delta (Δ) marker is ON, normal delta (Δ) marker level display will appear even if the REL is set.

- (9) Switching the Marker Data Display Position
Select the Marker data display position at the upper right or lower right of the screen.

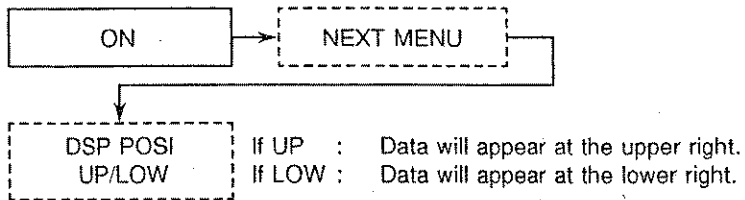

5.3.2 Peak Search



(1) Peak Search Menu

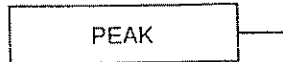

The maximum level is determined on the waveform currently containing the marker, and the marker is shifted to that maximum level point determined. The frequency and the level of that point will appear.
 If the Measurement window is ON, peak search is executed within the window. (See section 5.14.)

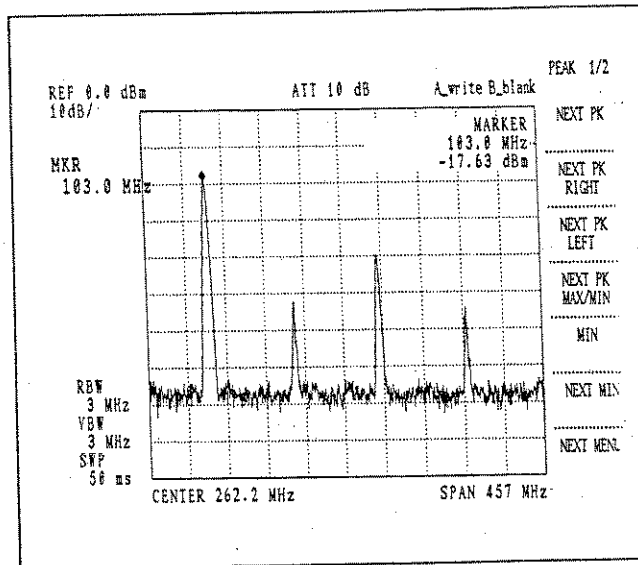

◆ : Active marker (Marker which can be moved)

Fig.5.3-6 Peak Search Screen

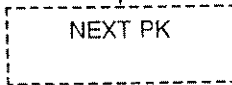

The peak level within the current waveform are retrieved up to 256 upper level points and their frequency and level are displayed.

The waveform valid in this mode is VIEW waveform or waveform after Single sweep.

If the NEXT PEAK is executed in the middle of sweep, valid results may not be obtained.

Every time this **NEXT PK** key is pressed, the marker is shifted from the greater amplitude to the smaller amplitude step by step.

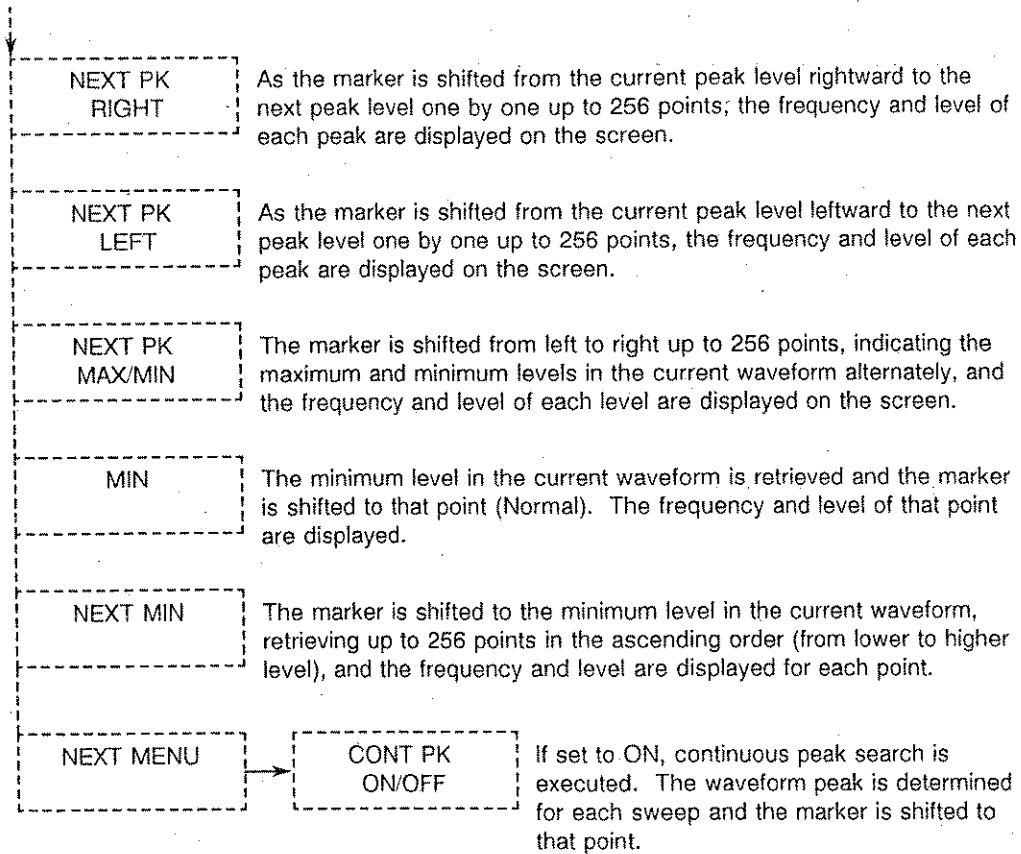

CAUTION

Since the peak data which has been retrieved will become invalid when the PEAK or MIN search is pressed, the data on NEXT PK will be collected from the beginning. The same occurs when marker shift is caused by data entry or $\Delta X/\Delta Y$ is modified.

(2) Setting $\Delta X/\Delta Y$

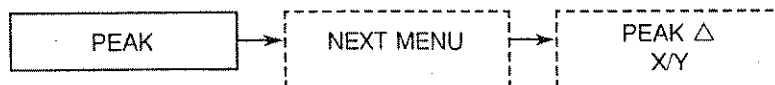

To find the waveform peak (Maximum, Minimum), set the point value which indicates the inclination in the X and Y directions. The point values in the X and Y directions on the screen have resolution as shown below.

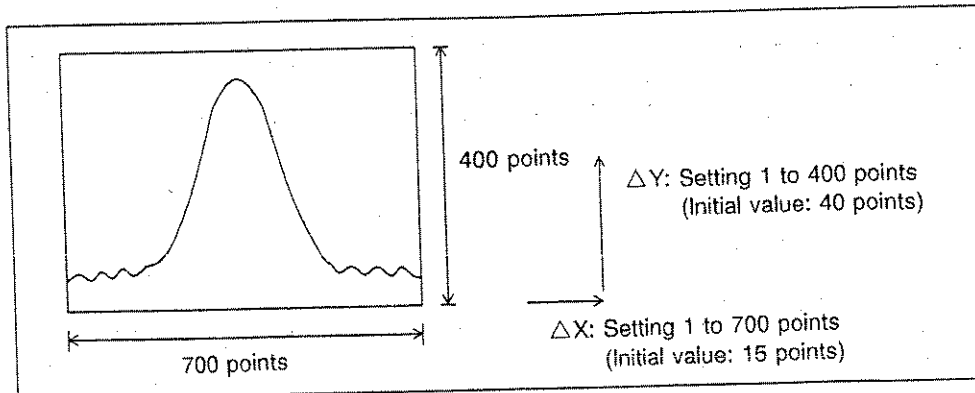
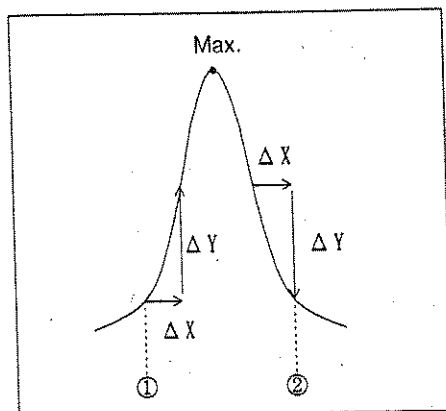

Fig. 5.3-7 ΔX and ΔY Resolution



The point ① where the waveform data increases by ΔY or more at the ΔX point apart is assumed to be the rise.

The point ② where the waveform data decreases by ΔY or more is assumed to be the trail.

The point of the maximum value at the interval between ① and ② is called Peak.

Fig. 5.3-8 Setting ΔX and ΔY

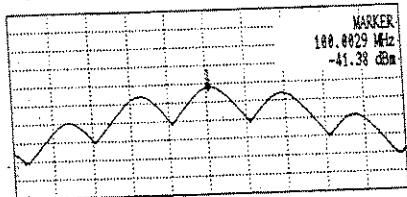

(Example 1)

If $\Delta X = 15$ and $\Delta Y = 40$,

Only one peak is determined because ΔY is great.

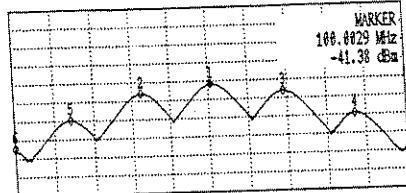

(Example 2)

If $\Delta X = 15$ and $\Delta Y = 10$,

As ΔY is small, peaks of small inclination can be caught.

(3) Modifying the Peak Search Level

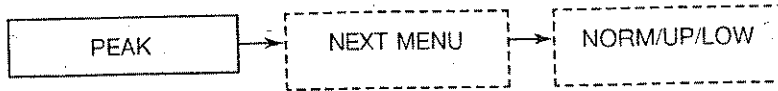

The reference level of the peak search can be modified, using the display line.

NORM : Search is executed to all the waveforms. (Initial value)

UP : Level above the display line is searched.

LOW : Level below the display line is searched.

Before setting UP or LOW, set the Display line ON and adjust the level.

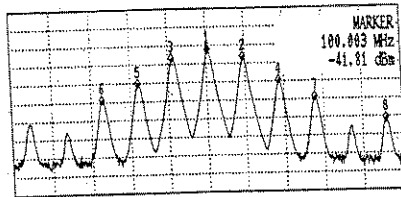
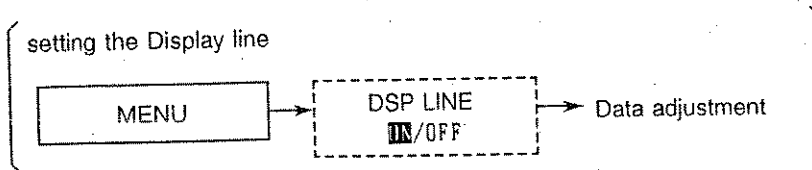

Fig. 5.3-9 NEXT PK when NORM is selected

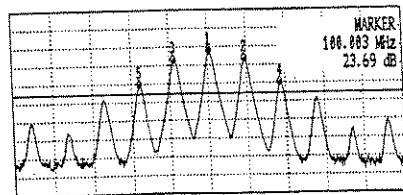

Fig. 5.3-10 NEXT PK when UP is selected

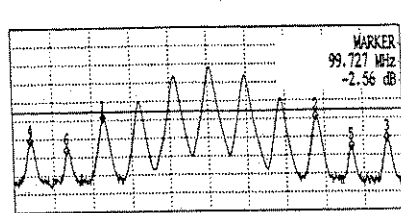
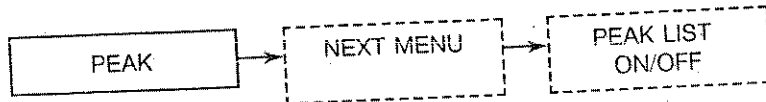

Fig. 5.3-11 NEXT PK when LOW is selected

CAUTION

This function will not operate in PEAK search or MIN search mode.

- (4) Peak List Display
A marker will appear on the every peak (up to eight points) on the screen, and the frequency and level are listed.



- ① Listing in the ascending order of levels (Default)

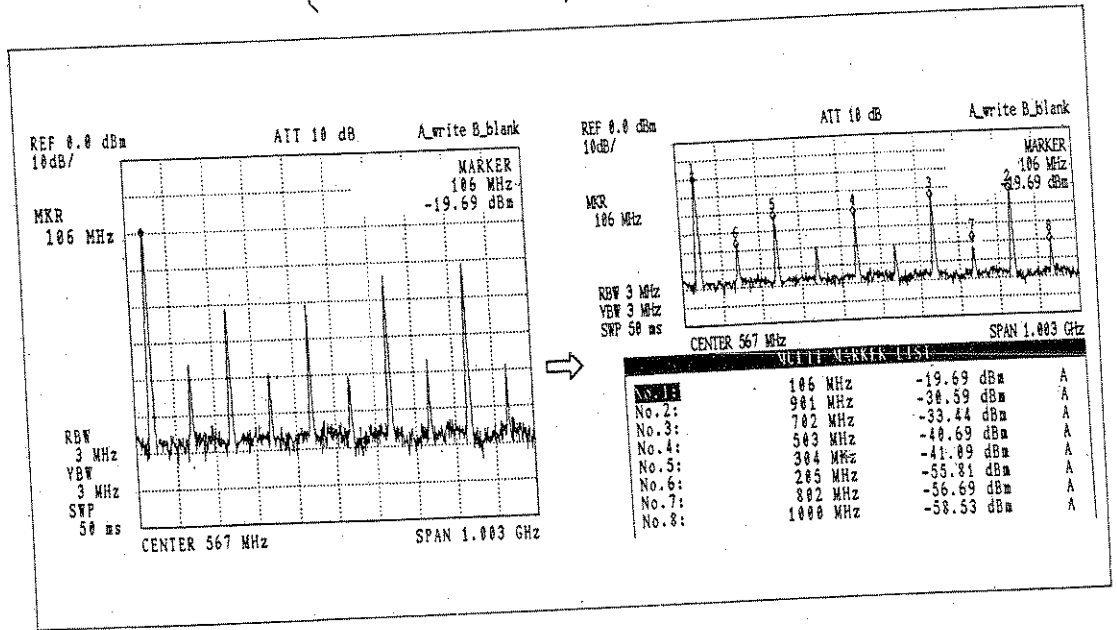
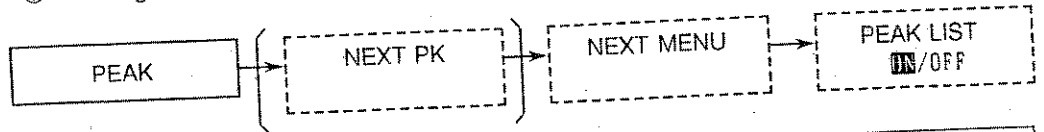
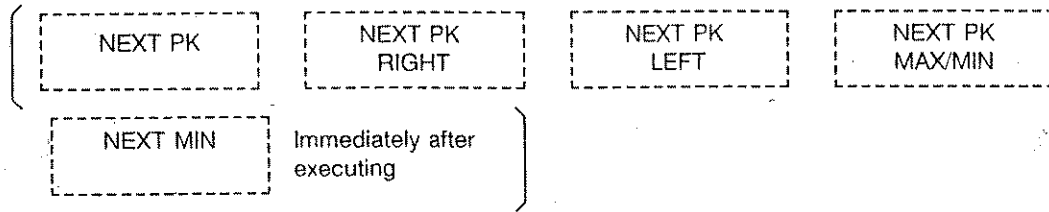

Fig. 5.3-12 Listing in the Order of Levels

② Listing with other specification



Listing will be executed according to the functions given above.

If **NEXT PK RIGHT** is specified by pressing the following keys:



Listing will be executed in the order of frequency, starting at the peak preceding the peak with the active marker (◆).

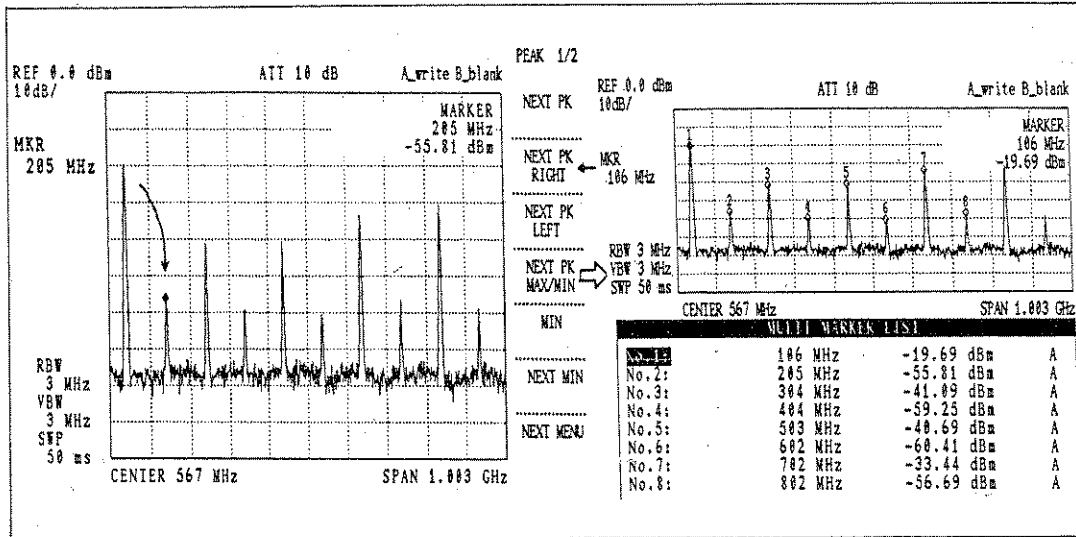
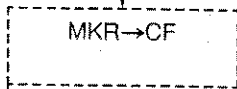
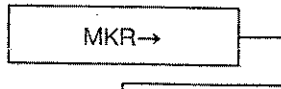
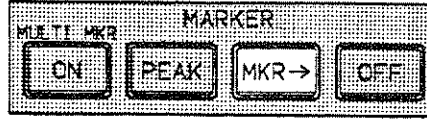

Fig. 5.3-13 Listing with NEXT PK RIGHT specified

5.3.3 Marker → (Marker to)

The current marker data (frequency, level, Δ) are specified as the data of another function.



The active marker frequency is set as the center frequency.

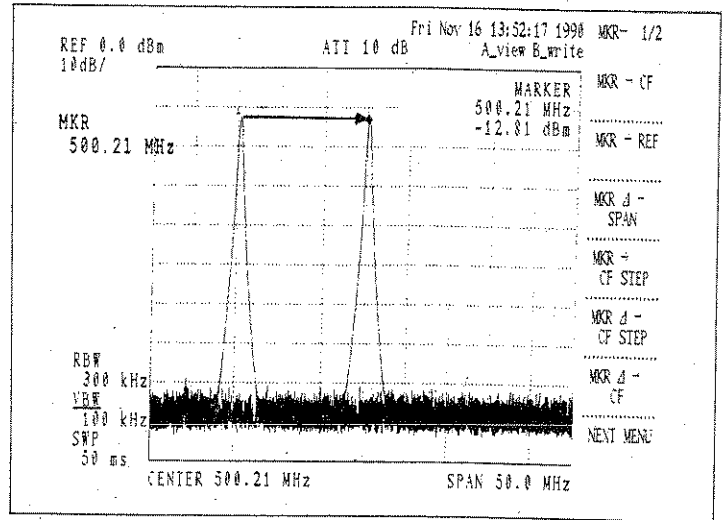
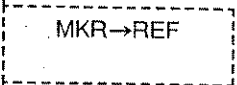
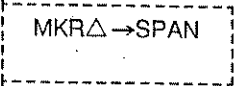

Fig. 5.3-14 Setting MKR → CF



The active marker level is set as the reference level.



The delta marker frequency is set as the frequency span.

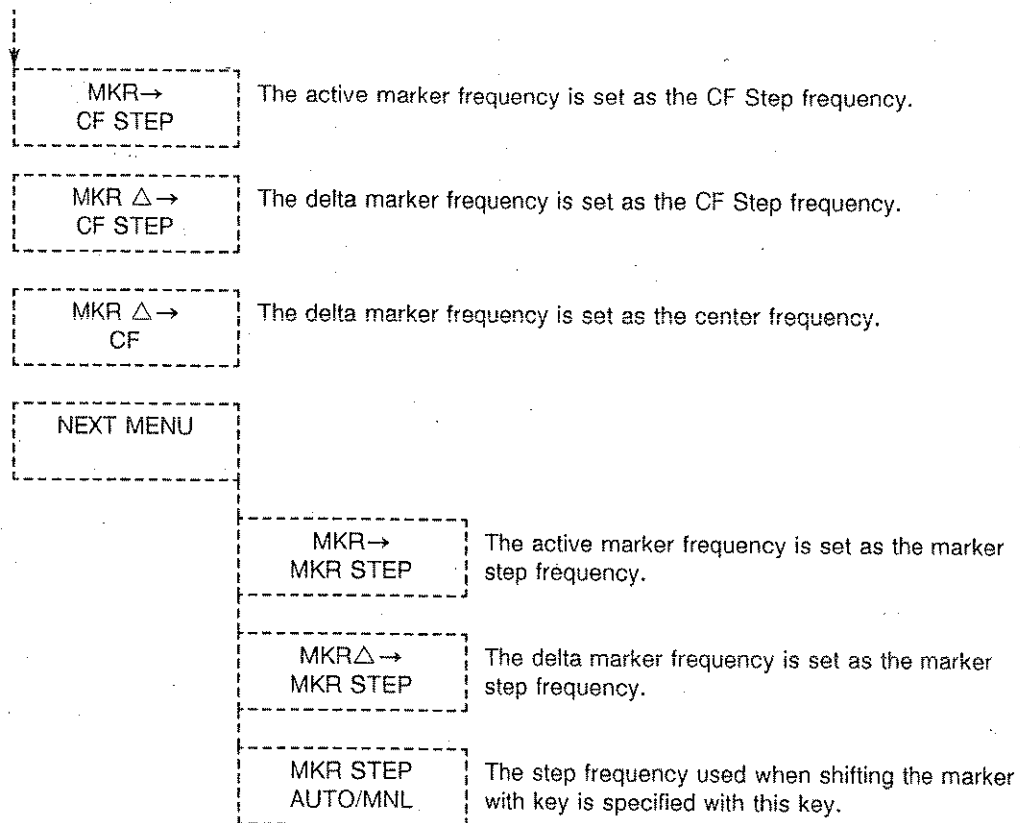

AUTO : The step frequency is set to 1/10 of the frequency span.

MNL : Enter the data of the step frequency.
 The data is entered as time data if in Zero span mode.

5.3.4 Marker OFF

All the markers are erased from the screen and the marker-related functions are canceled if any are set to ON.



[Functions which are canceled]

- Counter
- Noise/Hz
- Marker pause
- Single track
- Manual sweep
- Continuous dB down
- 1/Δ mark
- AUTO TUNE

5.3.5 Multi Marker function (**SHIFT** → **ON**)

When the Multi Marker function is ON, up to eight markers can be displayed in Trace A/B. Thus frequency and level at multiple points can be measured simultaneously. One of the markers will be an active marker (indicated by \blacklozenge). The active marker can be moved with the Ten keys, Step key and Data knob, indicating the frequency and level on the screen. In addition to the eight markers, delta(Δ) marker can be used. The delta marker indicates the difference with the active marker(indicated by \blacklozenge).

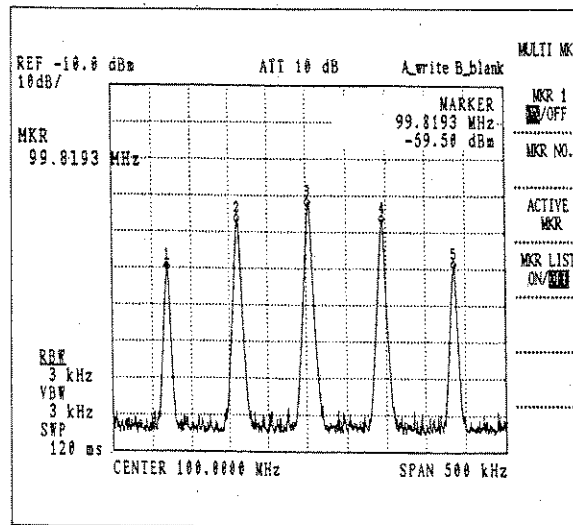

Five markers are on the screen in this case. The first marker is active.

Fig. 5.3-15 Multi Marker Display

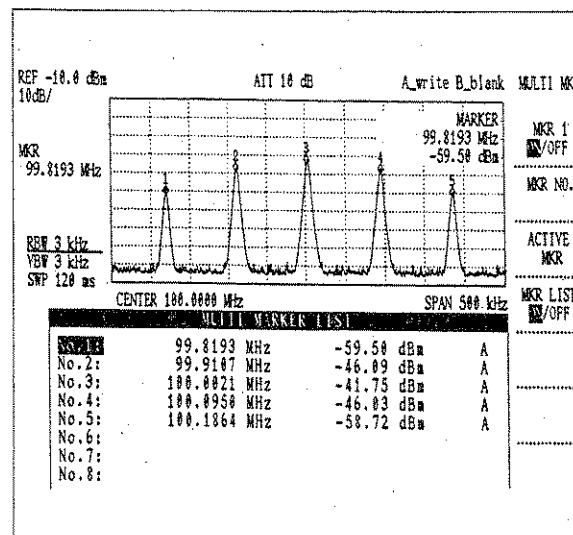

If the Multi marker listing function is used, the frequency and level data of all the markers can be read at once, which significantly improves measurement efficiency.

Fig. 5.3-16 Multi Marker Listing

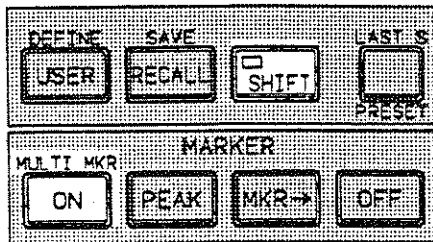

(1) Multi Marker Menu

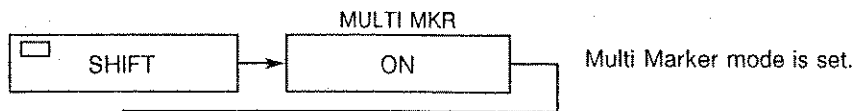

- MKR * ON/OFF** *: Indicates marker No.

ON/OFF : The active marker (*) can be shifted with the Data knob, Step key and Ten keys.

ON/OFF : Marker (*) OFF state. If this key is pressed in the OFF state, the marker (*) is set to ON, i.e., active.
- MKR No.** Marker No.1 through 8 can be selected.

Every time this key is pressed, the marker number on the menu is switched to another in the ascending order.
- ACTIVE MKR** Every time this key is pressed, the marker ON number is switched in the ascending order.
- MKR LIST ON/OFF** When set to ON, frequency and level of all the markers on the screen are listed at real time.

Marker No.(active number is black-white reversed), frequency, level and trace information are listed from left to right.

They are erased from the screen when the key is set to OFF.

② Setting the Multi Marker function to OFF

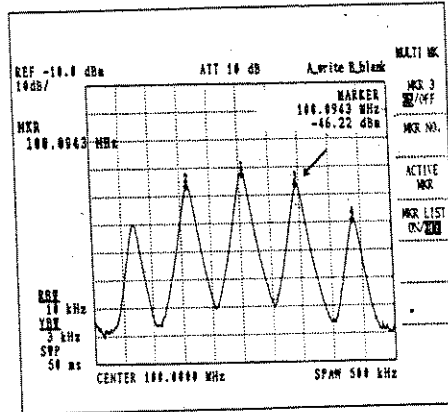

To set Marker No.3 to OFF, select "3" with the **ACTIVE MKR** and set

MKR 3 to OFF.

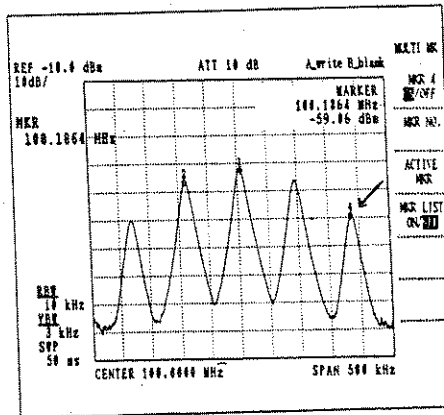

When marker No.3 is set to OFF, marker No.4 automatically becomes active.

If **MKR 4** is set to OFF in this state, marker No.1 becomes active.

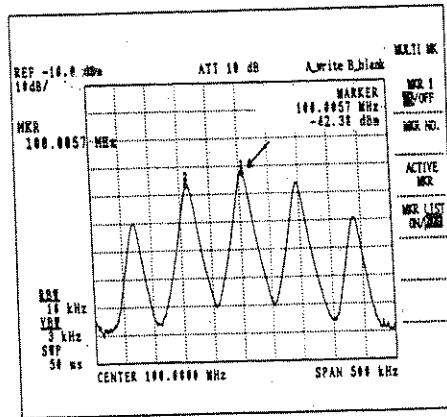

Thus, when one marker is set to OFF, the marker of the next greatest No. becomes active.

If no marker, the marker with the smallest No. will become active.

5.4 User-Defined Function

This function can be used to replace soft menu corresponding to the function keys. For example, the menu which is used frequently by the user can be called with high priority or can be entered into the soft menu of the User key. Thus, the number of key operations required is minimized.

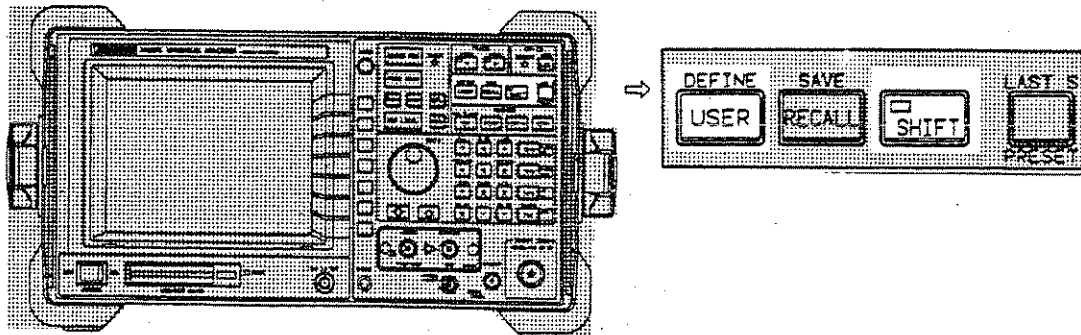

(1) Reconstructing the Soft Menu

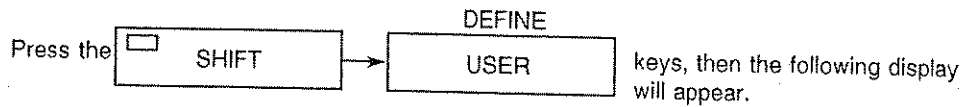

① These can be set by pressing the

GROUP
ACTIVE

Soft group

② These can be set by pressing

MEMBER
ACTIVE

Soft member

```

changed soft menu mode
/### CENTER ###/
* SF1 : cf step size is auto/manual
  SF2 : frequency offset is on/off
  SF3 : +/-
  SF4 : internal mixer
  SF5 : external mixer
  SF6 : 10 MHz ref is int/ext
  SF7 :
-----
/### MARKER ###/
  1 : marker is on
  2 : marker is off
  3 : normal marker
  4 : delta marker
  5 : fixed marker is on/off
  6 : 1/delta marker
  7 : counter is on
  8 : counter res is 1 kHz
  9 : counter res is 100 Hz
 10 : counter res is 10 Hz
  
```

CHG MEN
 GROUP ACTIVE
 MEMBER ACTIVE
 ENTER
 DELETE
 INITIAL GROUP
 ALL INITIAL
 RETURN

Fig. 5.4-1 User-Defined Display

- ① The current soft menu (SF1 through SF7) assignment is displayed in the upper half of the screen. Hereafter, this is referred to as Soft Group.
- ② In the lower half of the screen, menu (function) is displayed corresponding to the soft group. Hereafter, this is referred to as Soft Member.

(2) Explanation on the Menu

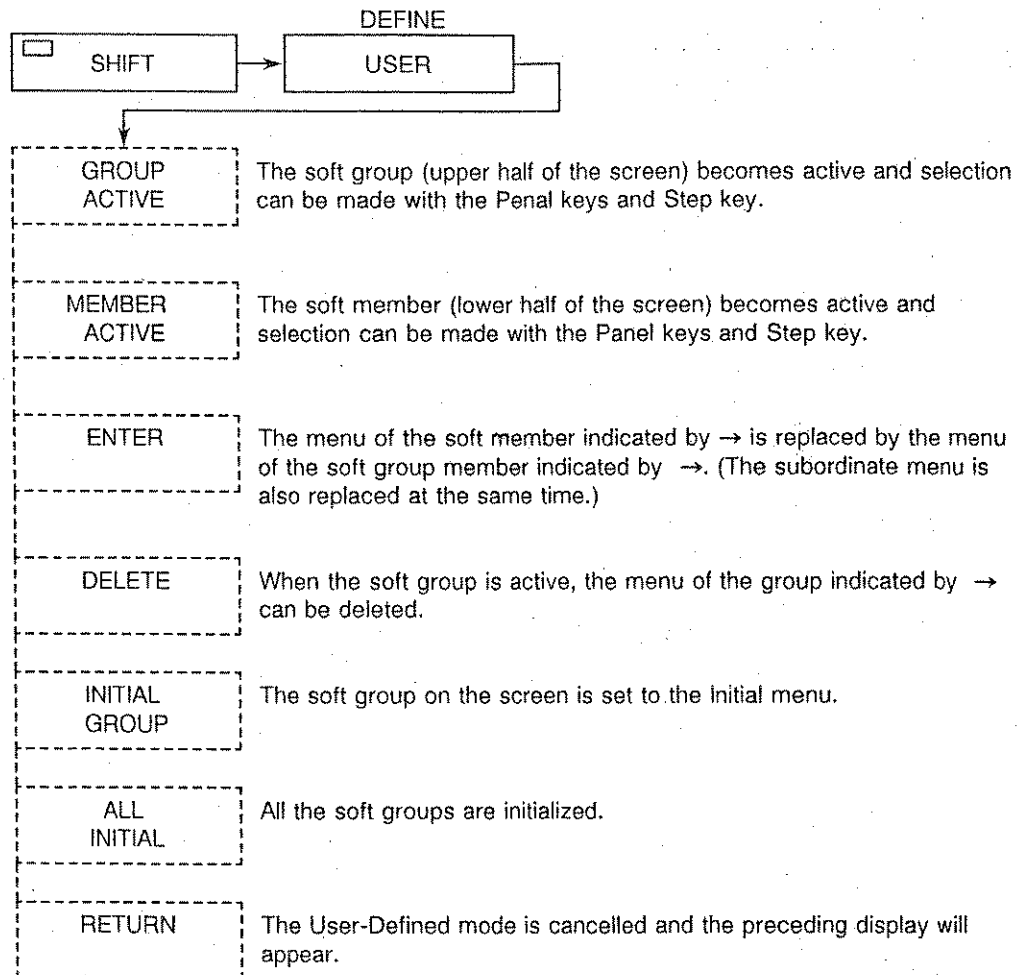

CAUTION

The menu which has been modified will not be initialized when power is turned off. However, to execute remote control with GPIB, do not forget to reset to the initial value. The menu modified can be saved in the Memory card. (See Section 5.5.)

(3) An example of User-Defined mode setting

```

changed soft menu mode
/### USER ###/
SF1 :
SF2 :
* SF3 :
SF4 :
SF5 :
SF6 :
SF7 :

-----
/### MARKER ###/
* 1 : marker is on
  2 : marker is off
  3 : normal marker
  4 : delta marker
  5 : fixed marker is on/off
  6 : 1/delta marker
  7 : counter is on
  8 : counter res is 1 kHz
  9 : counter res is 100 Hz
 10 : counter res is 10 Hz
    
```

CHG MENU
GROUP ACTIVE
MEMBER ACTIVE
ENTER
DELETE
INITIAL GROUP
ALL INITIAL
RETURN

```

changed soft menu mode
/### USER ###/
SF1 :
SF2 :
* SF3 :
SF4 :
SF5 :
SF6 :
SF7 :

-----
11 : counter res is 1 Hz
12 : count mode is mkr cnt/freq cnt
13 : counter is off
14 : signal track is on/off
15 : x dB down mode
* 16 : dB down
  17 : dB down left
  18 : dB down right
  19 : relative/absolute1/absolute2
  20 : reference marker is active
  21 : reference marker -> peak
    
```

CHG MENU
GROUP ACTIVE
MEMBER ACTIVE
ENTER
DELETE
INITIAL GROUP
ALL INITIAL
RETURN

```

changed soft menu mode
/### USER ###/
SF1 :
SF2 :
* SF3 : dB down
SF4 :
SF5 :
SF6 :
SF7 :

-----
11 : counter res is 1 Hz
12 : count mode is mkr cnt/freq cnt
13 : counter is off
14 : signal track is on/off
15 : x dB down mode
* 16 : dB down
  17 : dB down left
  18 : dB down right
  19 : relative/absolute1/absolute2
  20 : reference marker is active
  21 : reference marker -> peak
    
```

CHG MENU
GROUP ACTIVE
MEMBER ACTIVE
ENTER
DELETE
INITIAL GROUP
ALL INITIAL
RETURN

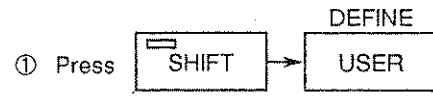

→ **GROUP ACTIVE**

and select to soft group to be replaced with the Panel keys and Step key.

In the example at left, **USER** is selected.

② Set the arrow → at the softkey to be replaced by using the Data nob.

③ Press **MEMBER ACTIVE**

and select to function to be replaced with the Panel keys, Step key and Data knob.

In the example at left, **MARKER ON** dB DOWN is selected.

④ Press the **ENTER** key

to execute soft group replacement or addition.

Note: No replacement or addition can be made to the members with three asterisks (***)

5.5 Memory Card Function

5.5.1 Initializing the Memory Card and Saving/Recalling the Soft Menu

Initialize the memory card and save/recall the soft menu defined with the key:

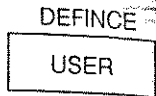

CAUTION

The setting conditions and measurement data save/recall procedures are described in the following section 5.6 Save and Recall Functions.

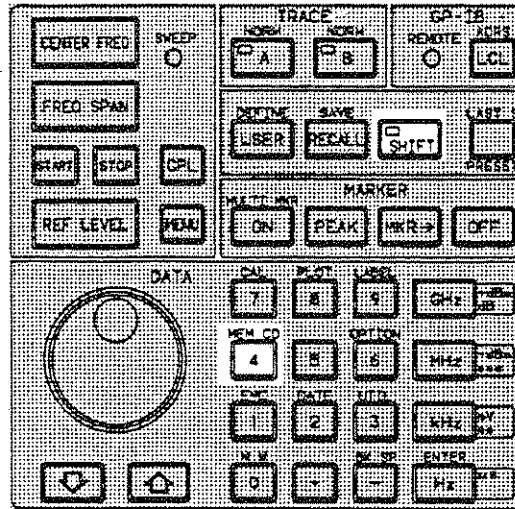

(1) External view of Memory card

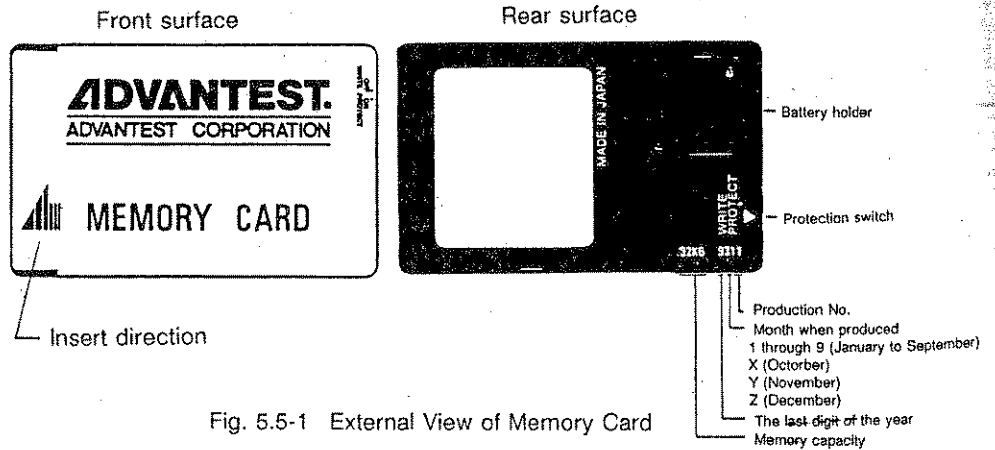

Fig. 5.5-1 External View of Memory Card

② Inserting and Removing the Memory Card

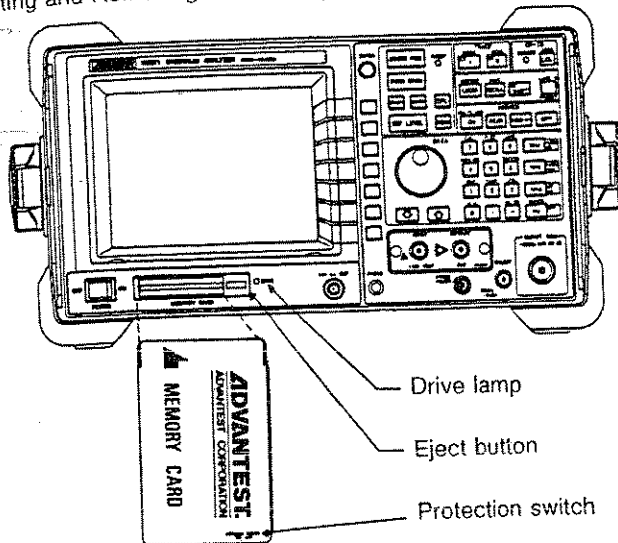

Fig. 5.5-2 Inserting and Removing the Memory Card

- ① Insert the memory card with the printed surface upward.
- ② When the Protection switch is OFF, the memory card executes normal read/write operation. When the switch is ON, write is inhibited.
- ③ Before removing the card, confirm that the drive lamp is not lit, and press the eject button.

CAUTION

When the memory card is accessed, the drive lamp is kept ON. While the lamp is lit, do not remove the card even if you have pressed the eject button.
If the memory card is removed while the drive lamp is lit, the data in the card may be broken.

(3) Procedure to Initialize the Memory Card

The memory will not operate unless it is initialized.

*: Initialization consists of memory check and formatting.

- ① Set the protection switch OFF.
In case of the memory card containing data, the data is erased when the card is initialized.
- ② Insert the memory card into the analyzer.

③

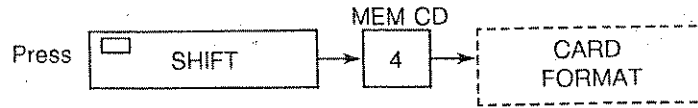

The following screen will appear.

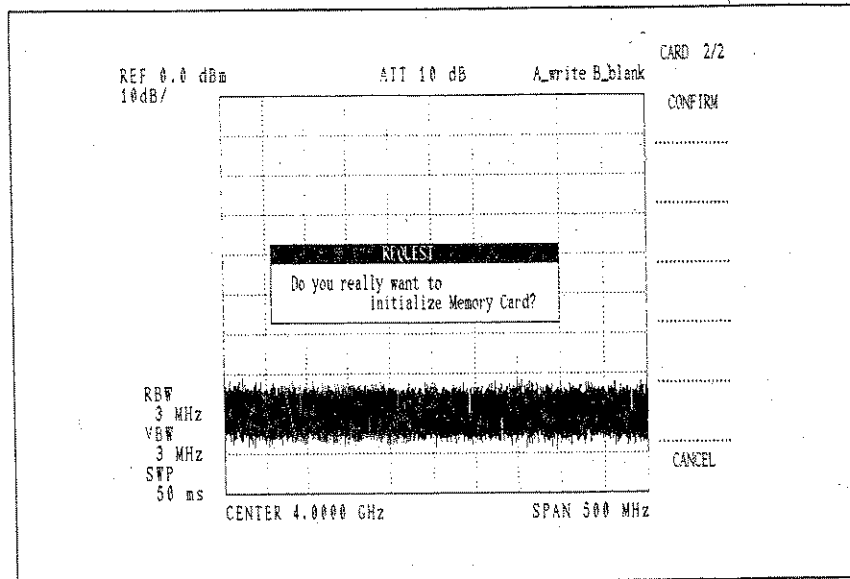

Press the CONFIRM , and initialization is executed.

When the CANCEL is pressed, the preceding menu will appear.

- ④ The initialization is completed with the following message. If any other message is on the screen, it is an error message: Memory card failure or Protection switch ON.

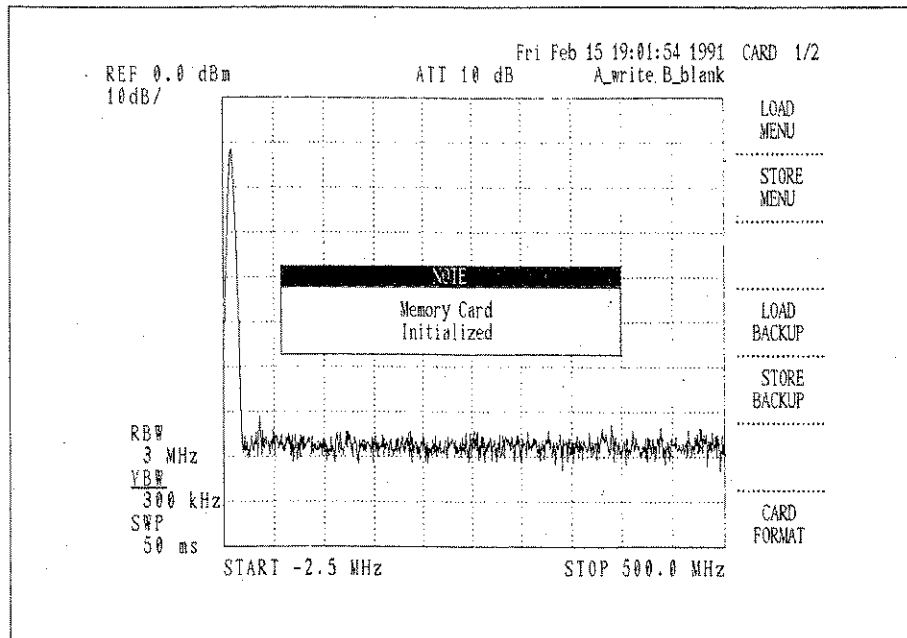

Fig. 5.5-3 Initializing the Memory Card

WARNING

If a memory card containing data is initialized, the data is erased.

(4) Saving the Soft Menu

The soft menu defined by the user can be saved in the memory card: One definition per card.

- ① Insert the memory card into the drive.
- ②

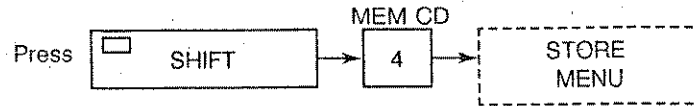

Data saving will start.

The channels to store data vary, depending on the card capacity.
(If the empty area is insufficient, saving may fail.)

32K bytes : CH39

128K bytes: CH79

CAUTION

1. If the channel specified above contains data on setting conditions and others, the data will be erased when the channel is overwritten. When saving soft menu data, confirm whether the channel contains any data.
2. To protect the save data, set the Protection switch on the card to ON position.

(5) Recalling the Soft Menu

- ① Insert the memory card containing the soft menu.
- ②

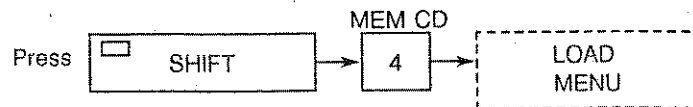

Recalling will start.

CAUTION

The soft menu data which has been set will be rewritten when soft menu data is recalled from the memory card.

5.5.2 Saving and Reading out Internal Back-up Memory Data into/from Memory card

- (1) Saving data into Memory card from Internal back-up memory

This function is used when replacing the back-up battery for the Internal back-up memory or making copy of the back-up data into multiple R3265/3271.

① Insert the Memory card into the drive.

②

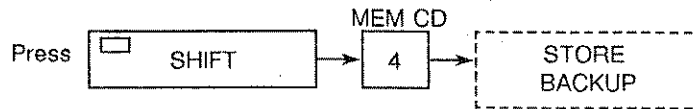

The following image will appear.

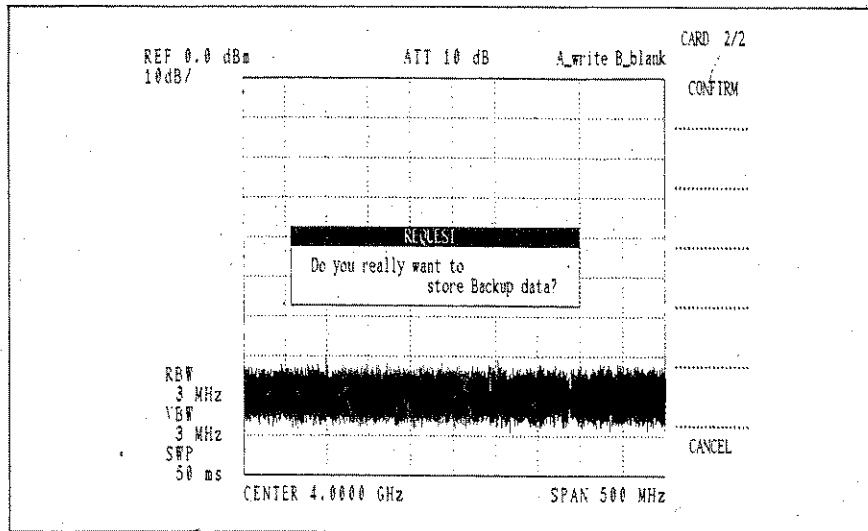

Press the  CONFIRM to start data saving.

When the  CANCEL is pressed, the preceding menu will appear.

CAUTION

1. When saving data from the Back-up memory into the Memory card, the memory card should have capacity of at least 64K bytes.
2. This function does not require initialization, but the format in the memory card will be broken when data is saved.

(2) Reading the back-up memory data from the Memory card

- ① Insert the memory card into the drive.
- ②

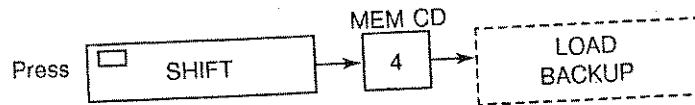

The following display will appear.

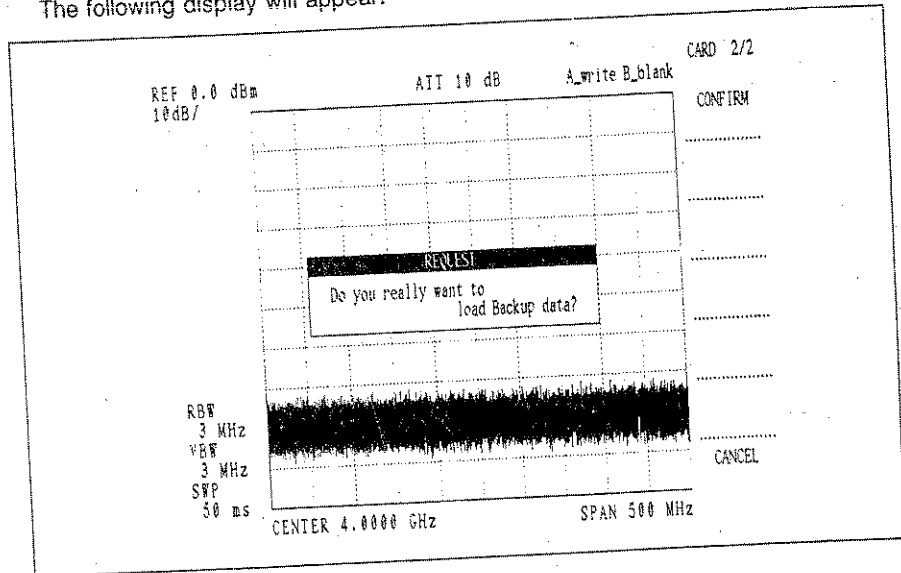

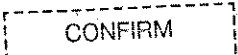
Press the  CONFIRM to start read.

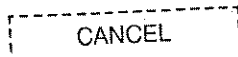
When the  CANCEL is pressed, the preceding menu will appear.

5.5.3 How to Handle the Memory Card

(1) Back-up Battery Operation Life

Memory saving period of the memory card is about 5 years if a new battery is mounted and the card is kept under normal temperature.

When replacing the battery for the first time, check the number printed on the memory card rear surface.

Example: 32KB 9206

This means that the battery was produced in February in 1989. Therefore, the battery should be replaced in February of 1994.

WARNING

The memory card operation life will be significantly shortened if it is kept under high temperature.

Remove the memory card from the analyzer when not in use.

(2) Battery Replacement

- ① Remove the two screws from the battery holder on the memory card rear surface, using a screwdriver with crossed end, and remove the cover.
- ② Remove the old battery and insert the new battery so that plus sign (+) can be seen.

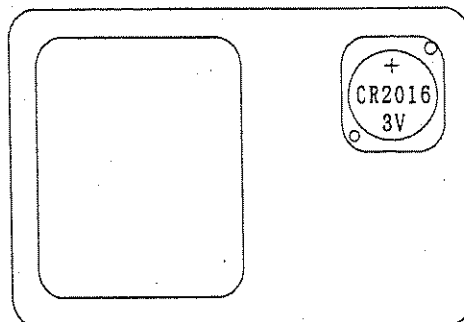

battery type CR2016

Fig. 5.5-4 Memory Card Battery Replacement

- ③ Mount the cover as it was.

CAUTION

When the battery is replaced, the data which has been saved in the memory card is lost. The card contains necessary data, copy the data into another memory card before replacing the battery.

Memory cards on sale: A09505 32K bytes, SRAM card, 5 pcs in a set
A09506 128K bytes, SRAM card, 5 pcs in a set

(3) Precautions when handling Memory card

- ① Take care so that no dust will come into the connector hole. Dust will cause connection failure or breakage.
- ② Never touch the connector with a metal needle or things like that, which may cause breakage due to static electricity.
- ③ Do not bend the card or do not apply shock to the card.
- ④ Do not dip the card in water.

(4) Specifications of the Memory Card

Memory capacity	:	32K bytes
Connector	:	20-pole, 2 pcs (Insert/Removal allowed: 5000 times or above)
Interface	:	I/O bus byte (based on the Japan Electronic Industry Promotion Association)
Memory back-up battery	:	CR2016 (1 pc. Replacable)
Memory hold period	:	5 years (if kept under normal temperature)
External dimensions	:	54 (width) × 86 (length) × 2.2 (thickness) mm
Environmental conditions	:	No condensation allowed Operation temperature 0 to 40°C Storage temperature -20 to 60°C relative humidity 10 to 90%
Protection switch	:	Switched ON/OFF Write inhibited when the switch is set to ON.

5.6 Save and Recall Function

The analyzer setting conditions and measurement data can be saved and recalled, using the back-up memory or memory card. (Note: The memory card should be initialized when used.)

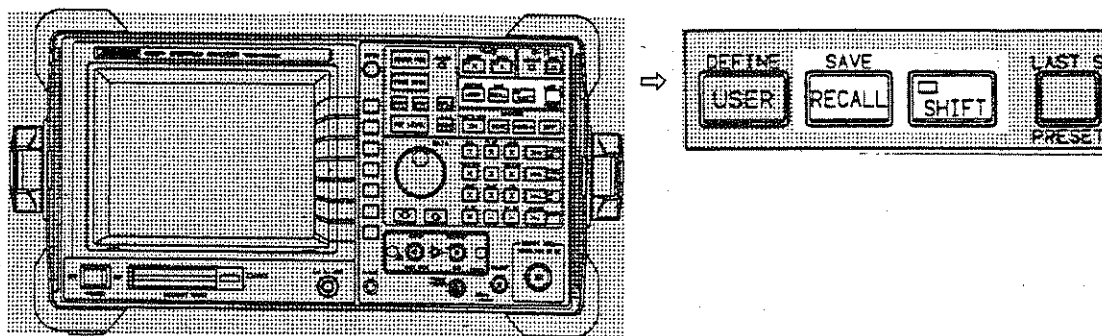

Saving the setting conditions and measurement data can be realized with the back-up memory and the memory card. The items which can be saved in the back-up memory and memory card are as follows.

- Back-up memory (17 items can be saved in channel IP through 15.)
 - CHIP : Contains the initial state when the IP key is pressed.
 - CH0 : Contains the data immediately after the power is turned ON or immediately before the IP key is pressed.
 - CH1 to 5: User-defined
 - The following can be saved:
 - Waveform data A/B : These can be saved in various combinations.
 - Antenna correction table : These can be saved in various combinations.
 - Normalize data : These can be saved in various combinations.
 - Limit line table 1/2 : These can be saved in various combinations.
 - Loss table : These can be saved in various combinations.
 - User-defined : 1 item per memory card
- Memory card (Channel 16 and after: The maximum number of items which can be saved is determined by the memory card capacity. However, the maximum number may be decreased when the following data are saved.)
 - Setting data : 15 items per channel
 - Waveform data A/B : 20 screens in total
 - Normalize data : 20 screens in total
 - Antenna correction table : 5 items in total
 - Limit line table 1/2 : 5 items in total

5.6.1 Save Function

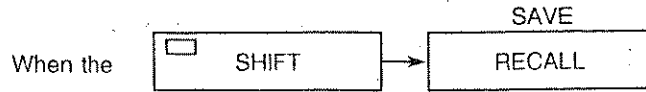

keys are pressed, the saved data will be listed on the screen.

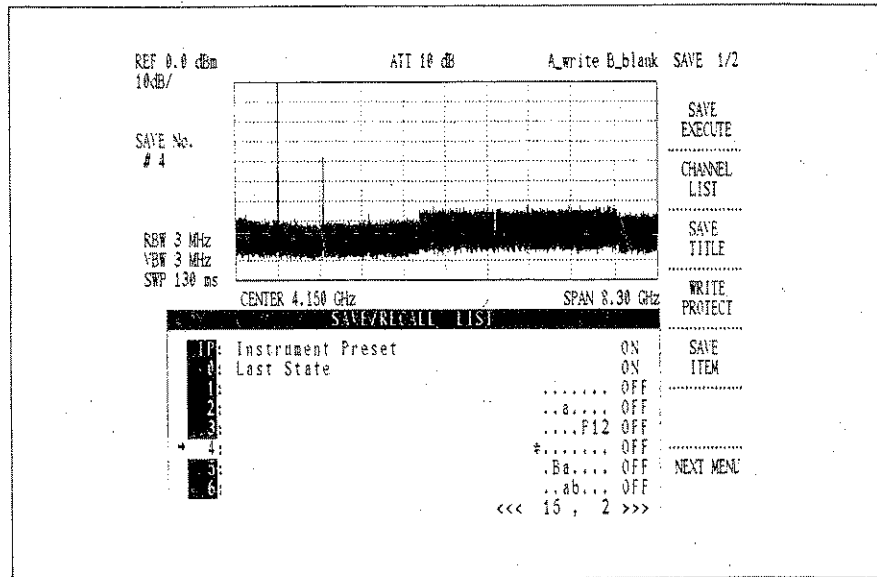

Fig. 5.6-1 List of Saved Data

(1) Explanation of the List

The data saved in eight channels are listed at once on the screen. The data in the channel numbers before and after can be scrolled.

Channels 1P through 15 store the data in the analyzer back-up memory and the 16th item and after are stored in the memory card.

When the cursor (j) is shifted to the 16th item and after, the number of remaining bytes in the memory card will be indicated as the number of items.

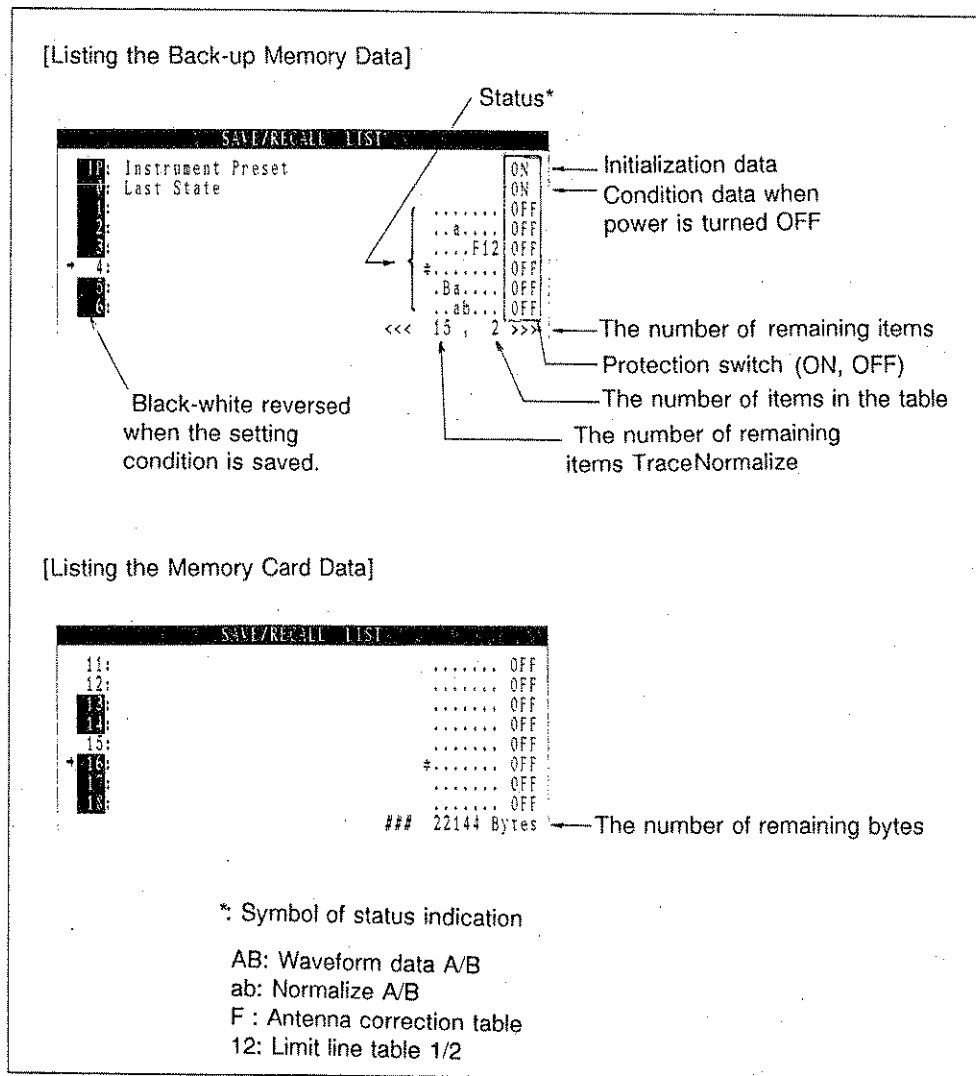
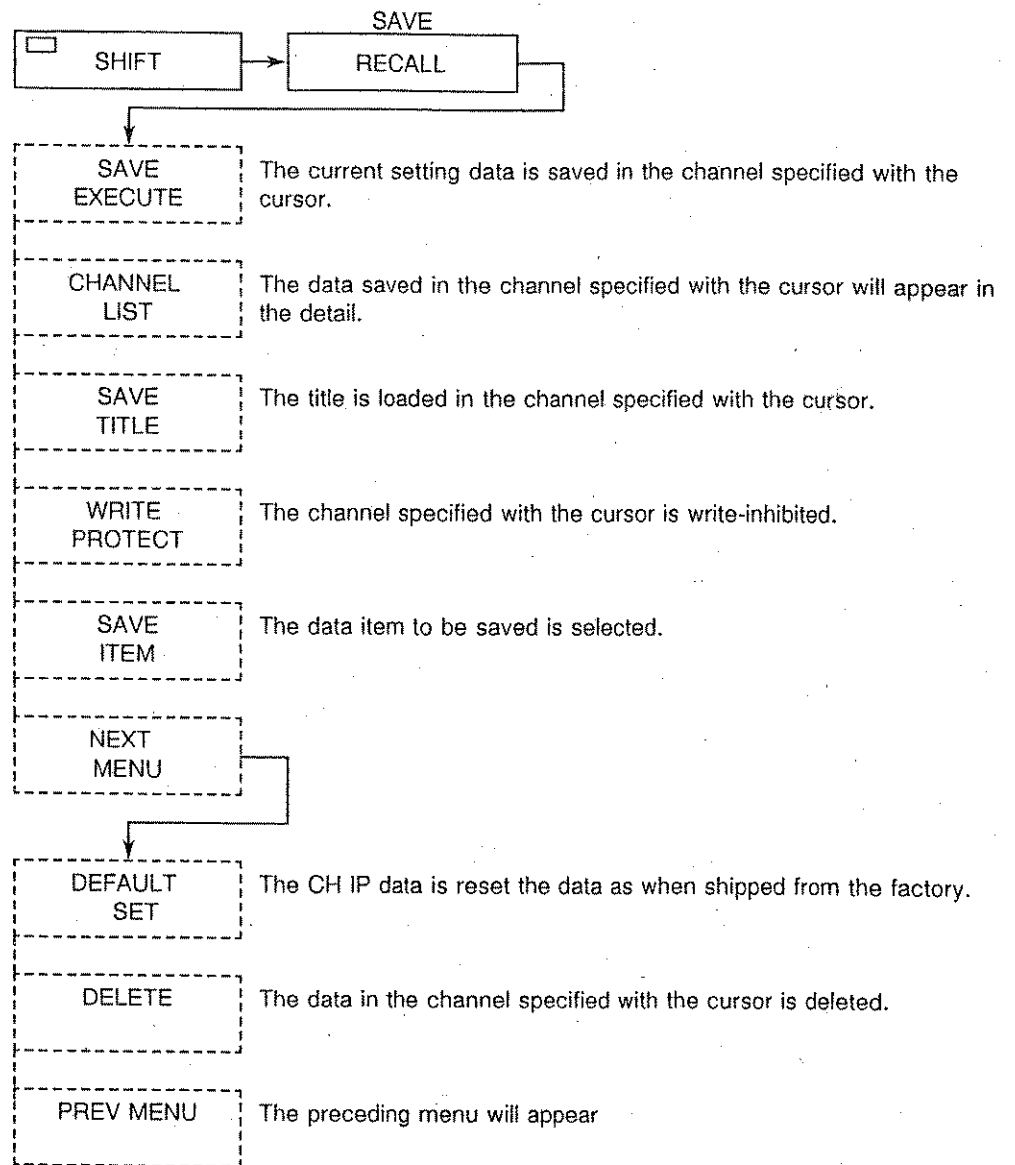
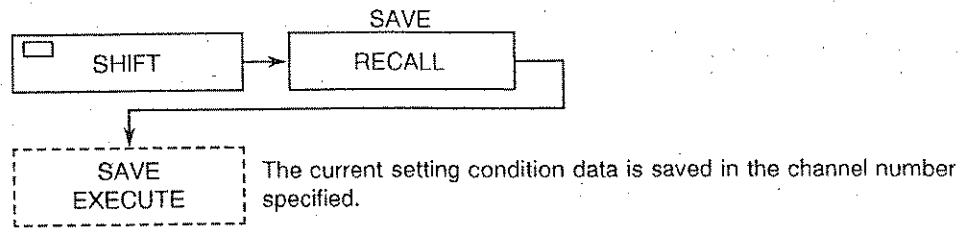

Fig. 5.6-2 Explanation of the List

(2) Save Menu



(3) Saving Data



The item specified with the specified.



is saved in the channel number

When a data is saved in channel No. 1P, the current setting data is saved as the initialization data at preset. After this, initialization at preset will be executed with the data saved here.

To reset the initialization data to the one prepared when shipped from the factory, press the

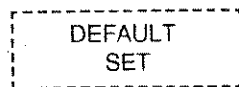

key.

No data can be saved in channel No.0. (This area is reserved to store the LAST STATE when the power is turned OFF.)

For the channels numbers 1 through 15, data is saved in the analyzer back-up memory.

For the channel number 16 and after, data is saved in the memory card.

[How to Save Data]

- ① Saving the waveform data
Set the TRACE section to VIEW mode. If no data is to be saved, set the WRITE,BLANK mode.
- ② Saving the Normalize data
Set the NORMALIZE ON/OFF key in the TRACE section to ON state. No data can be saved if it is set to OFF.
- ③ Saving the Limit line data, Antenna correction data, Loss table data and Marker
Set the mode of the corresponding section ON. No data can be saved if the mode is set to OFF.

④ Saving the soft menu data

Press the



of the Memory card section.

(See section 5.5 Memory Card Function.)

(5) Loading the title of the saved data (Entry operation is same 5.10 Label Function.)

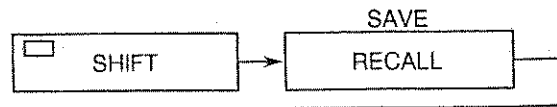

SAVE
TITLE

The title of the channel number specified with the cursor is loaded. (up to 30 characters) Set the cursor at the character to be entered with the Rotary knob and press the Unit key.

After entering the title, press the

RETURN key.

When entering a title in the memory card, press

SAVE EXECUTE

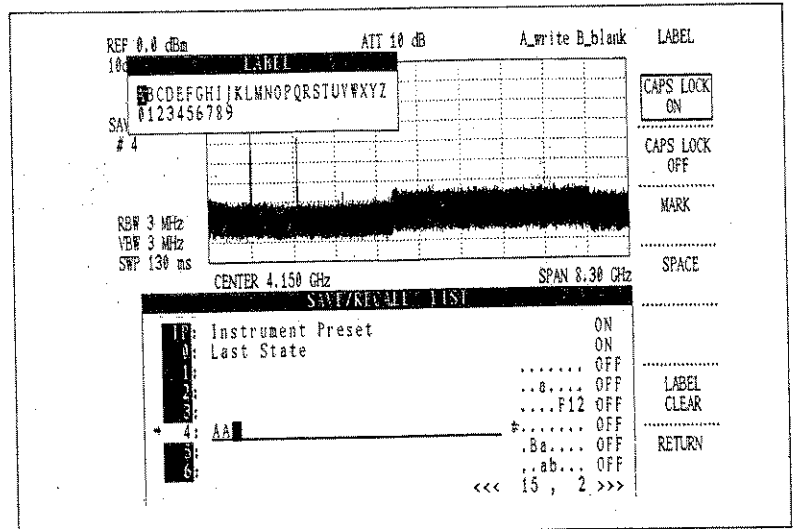
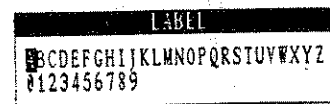

Fig. 5.6-4 Entering the title of the saved data

CAPS LOCK ON

Entering an alphabetic character of upper case



CAPS LOCK OFF

Entering an alphabetic character of lower case

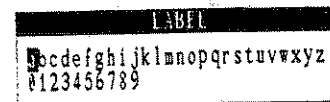

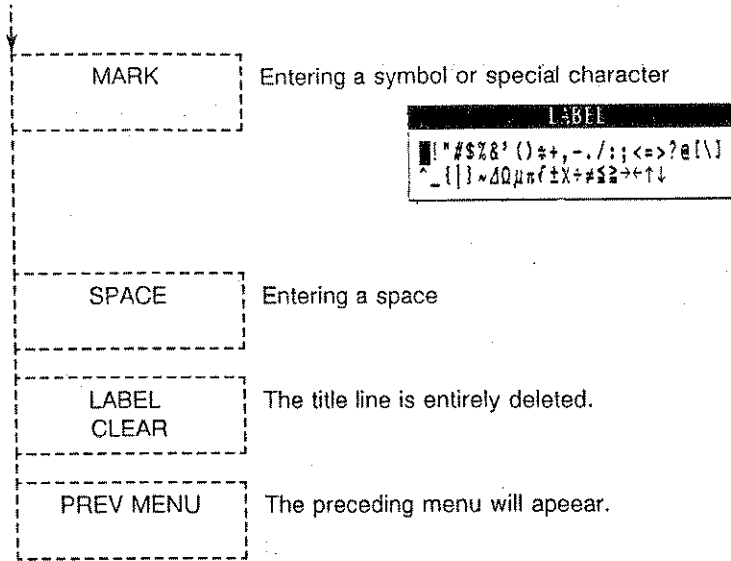

(6) Protection of the saved data

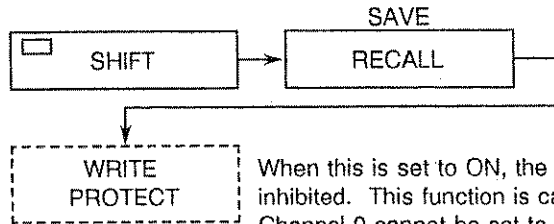

When this is set to ON, the channel specified with the cursor is write-inhibited. This function is cancelled when it is set to OFF. Channel 0 cannot be set to write-inhibited mode.

SAVE/RECALL LIST		
11:	Instrument Preset	ON
0:	Last State	ON
1:		OFF
2:	OFF
3:	#....F12	ON
4:	AA	OFF
5:	.Ba....	OFF
6:	..ab...	OFF
		<<< 15, 2 >>>

Write-inhibited or not

(7) Selecting the item to be saved

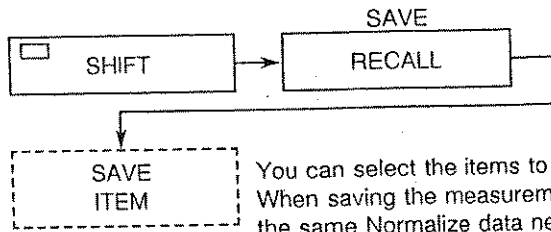

You can select the items to be saved. When saving the measurement data and Normalize data for example, the same Normalize data need not be saved at every measurement if set to OFF. (Using the memory data)

After selecting the item to be saved, set the SAVE menu and press the

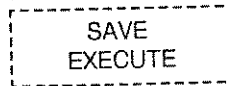

The items specified will be saved.

CAUTION

This time is cleared every time

```
graph LR; A[SHIFT] --> B[SAVE RECALL];
```

are pressed and all data items set to ON.

To cancel data saving, set the item OFF.

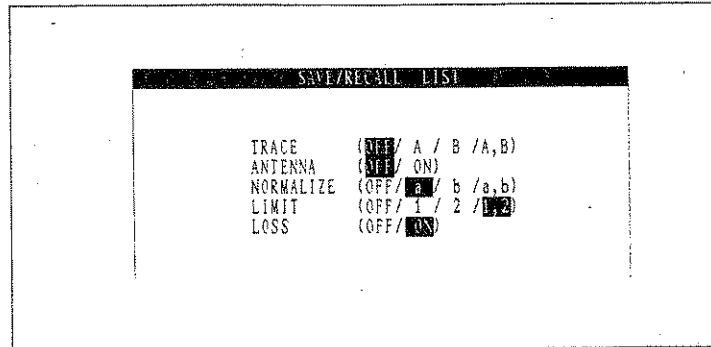
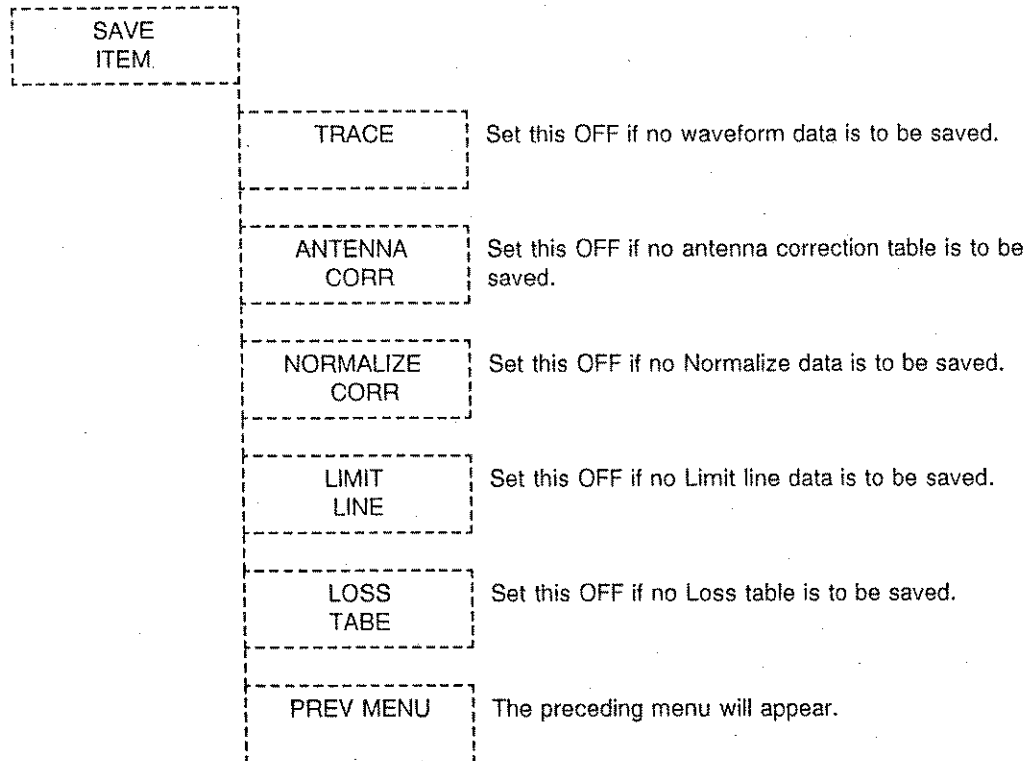
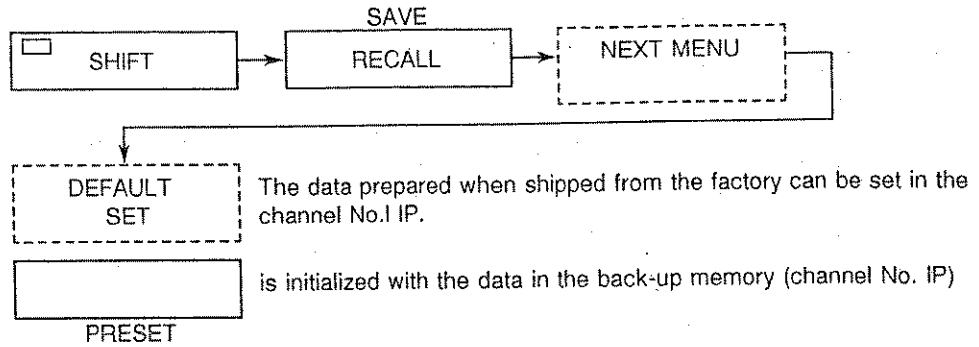

Fig. 5.6-5 Selecting the Data to be saved



(8) Initializing the saved data



Once a setting data is written into the channel No. IP, hereafter the IP (PRESET) will be initialized with that setting data. To replace the setting data with the data when shipped from the factory, use this function.

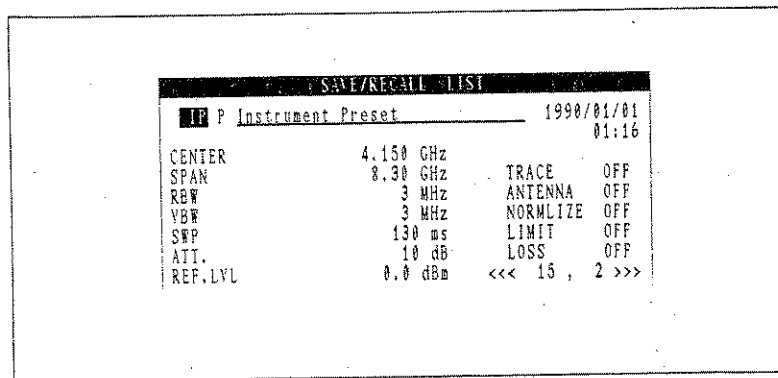
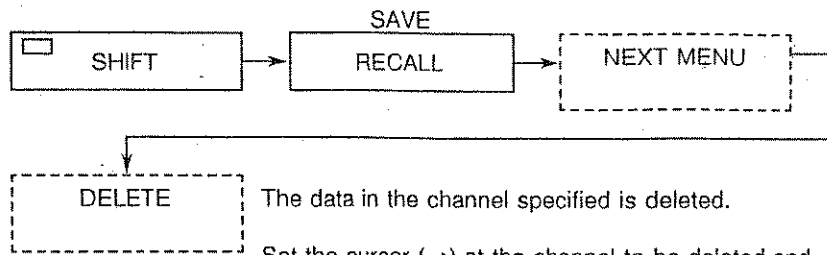

Fig. 5.6-6 Listing the Initialization data

(9) Deleting the saved data



The data in the channel specified is deleted.

Set the cursor (→) at the channel to be deleted and press to delete the saved data.

When the delete is complete, the channel number in black-white reversed state will appear in normal state.

CAUTION

No data can be deleted from channel 1P and channel 0, or other channel which is set to ON.

5.6.2 Recall function

Press the SAVE
RECALL key

The recall data list will appear at the lower half of the screen.
 Note: No list will appear if the RECALL is set to FAST mode.

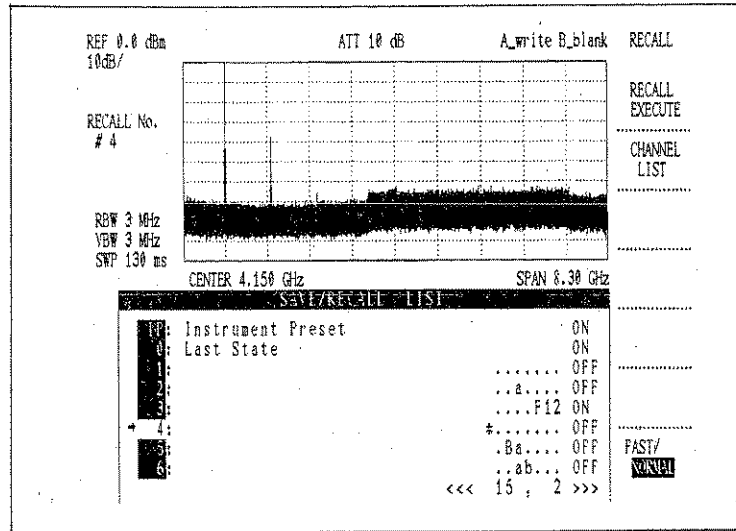
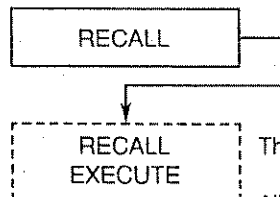

Fig. 5.6-7 Recall Data List

The recall list is explained in Paragraph 5.6.1 (1).

(1) Recalling the saved data



The data of the specified channel number is recalled.

All the data contained in the specified channel number are recalled. When channel number IP or 0 through 15 are specified, the data are recalled from the analyzer back-up memory.

When channel number 16 or after is specified, the data is recalled from the memory card.

(2) Recall Data in Detail

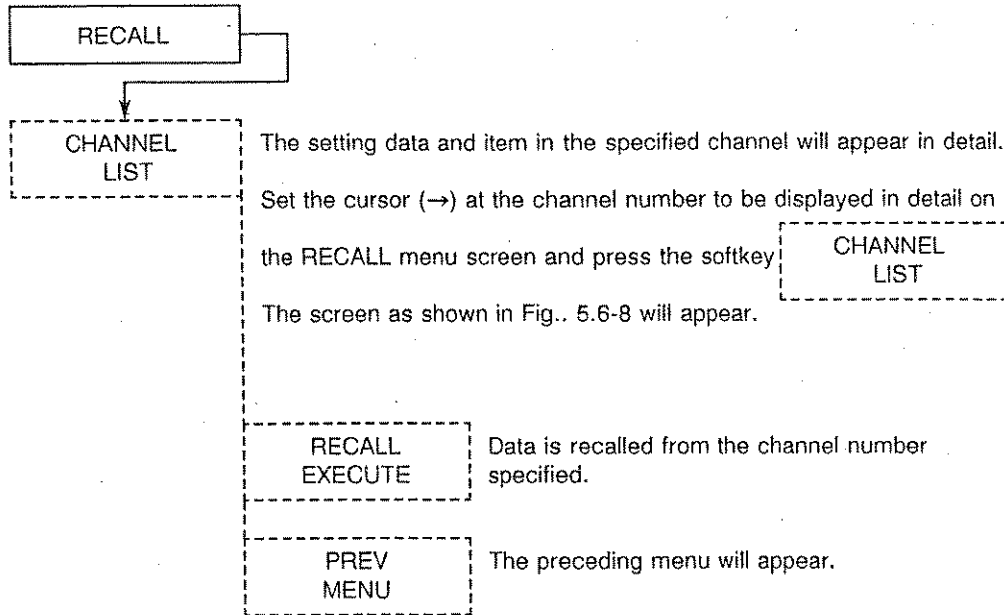

① When setting data is contained

```
SAVE/RECALL LIST
3 P _____ 1990/01/01
                                01:17
CENTER      4.150 GHz
SPAN        8.30  GHz
RBW         3  MHz
VBW         3  MHz
SRP         130 ns
ATT         10 dB
REF.LVL     107.0 dBµV
TRACE       OFF
ANTENNA     ON
NORMLIZE    OFF
LIMIT       1,2
LOSS        OFF
<<< 15 , 2 >>>
```

② When soft menu is contained

```
SAVE/RECALL LIST
3 P SOFT KEY MENU _____ 1990/01/01
                                01:22
SOFT KEY MENU
### 20480 Bytes
```

③ When no data is contained

```
SAVE/RECALL LIST
4 . _____
NO DATA
<<< 15 , 2 >>>
```

Fig. 5.6-8 Recall Data in Detail

(3) Selecting the Recall Data Mode

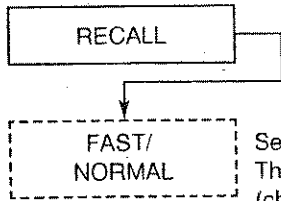

Select the FAST or Normal mode of Recall.
The Fast mode is valid only for the internal Back-up memory (channels 0 through 9).

- In Fast mode, the list displayed in the window in Normal mode will not appear. Recall can be executed only with the Ten keys (0 through 9) without pressing the

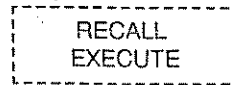

- In Normal mode, looking at the list displayed in the window, select a channel and press the key to execute Recall.

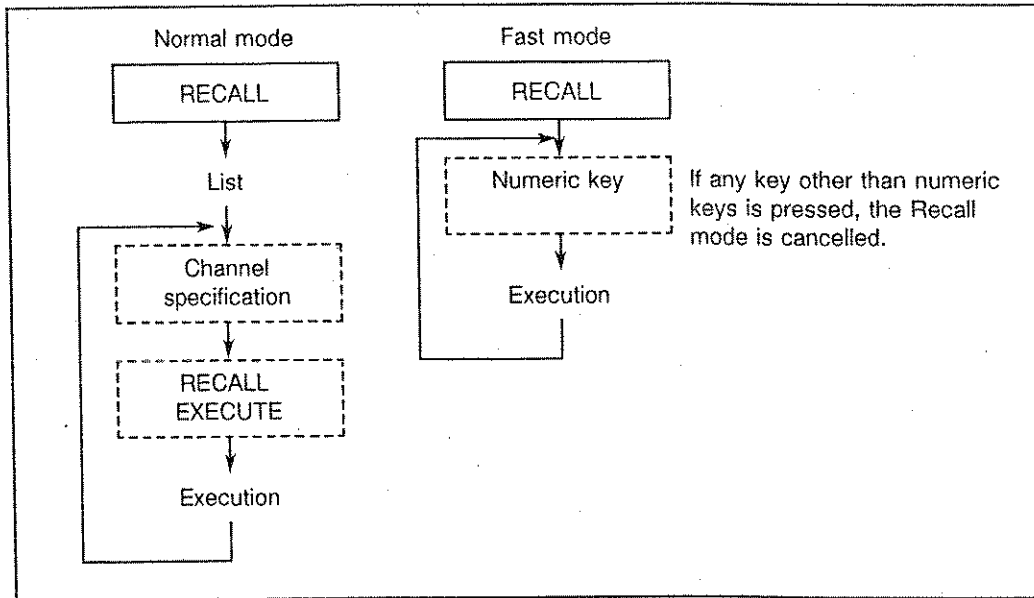
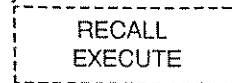

CAUTION

The Fast mode is valid only for the internal memory. No data can be recalled from the memory card if one has been inserted.

5.8 Calibration Function

In this analyzer, the calibration factor obtained by executing calibration can be corrected at actual measurement to improve the measurement accuracy.

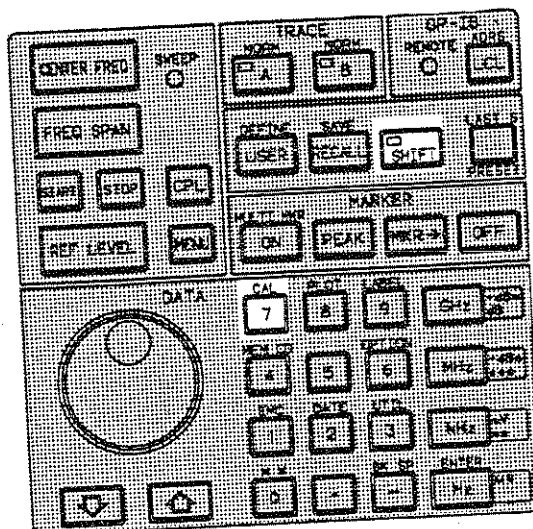

(1) Calibration items

- Absolute error in the Resolution bandwidth 300kHz, Correction signal output -10dBm, 1dB/div.
- IF filter switching level error in the Resolution bandwidth 10Hz to 3MHz.
- Screen vertical axis linearity in LOG 10dB/div, 5dB/div, 2dB/div and 1dB/div.
- Switching error in LOG 10dB/div to 0.1dB/div.
- IF step AMP, switching error
- Input attenuator switching error
- PBW (Noise power bandwidth)

CAUTION

1. Before executing the Calibration function, do not forget to take 60 minutes or more for warm-up.
2. When executing the Calibration, connect the Input to the CAL OUT (correction signal out) on the front panel with the attached cable (MC-61: 10cm).

(2) Calibration menu

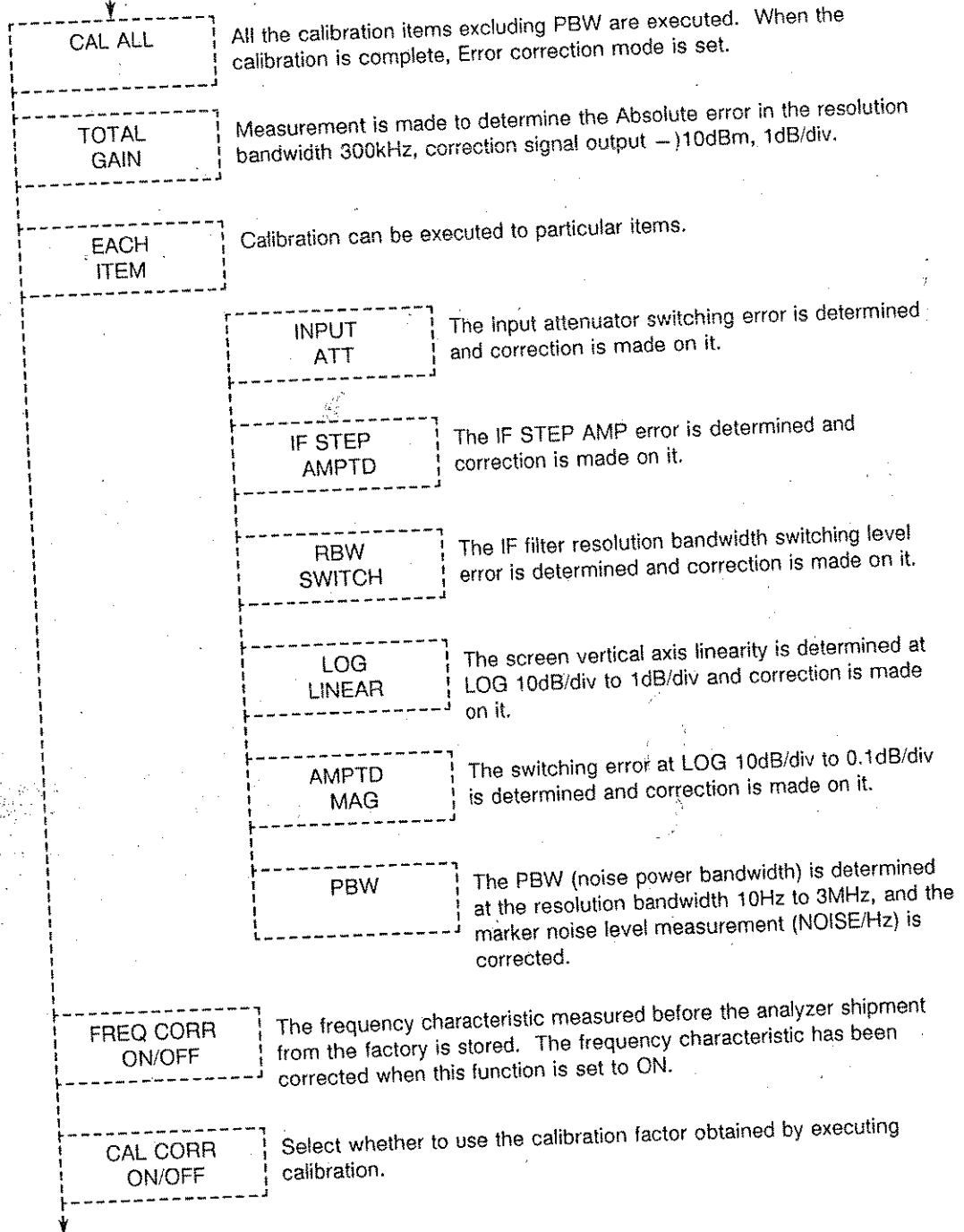
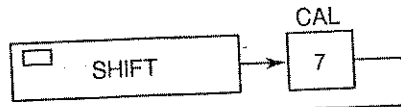

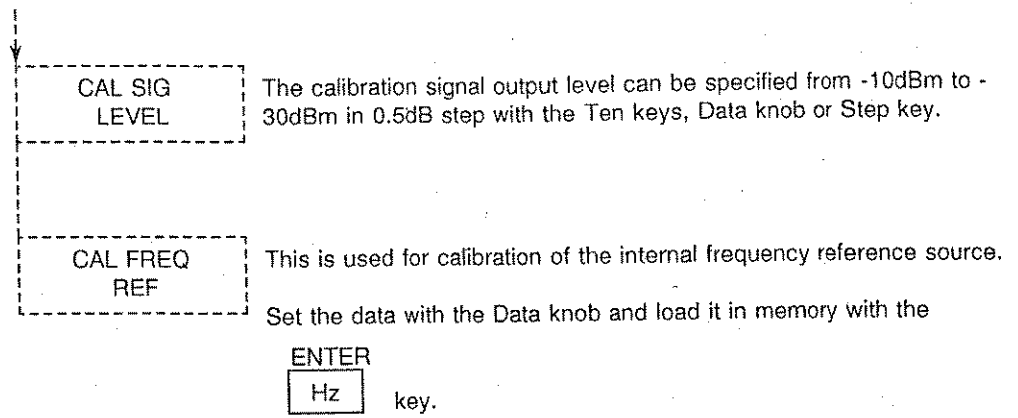

The accuracy is 2×10^{-7} /year.

5.9 Plot Output Function

Set the conditions to output data to the plotter and output the data. Panel key operation is enabled even during plot and the following operations can be executed without waiting for the output completion.

(1) Plotters which can be connected to the analyzer

To output the measurement data from the analyzer to the plotter, use the GPIB connector to connect the plotter to the analyzer. Table 5.9-1 shows the plotters which can be connected and Figure 5.9-1 illustrates the connection.

Table 5.9-1 Plotters which can be connected

Manufacturer	Plotter type
ADVANTEST	R9833
HP	HP7470A, HP7475A, HP7440A, HP7550A

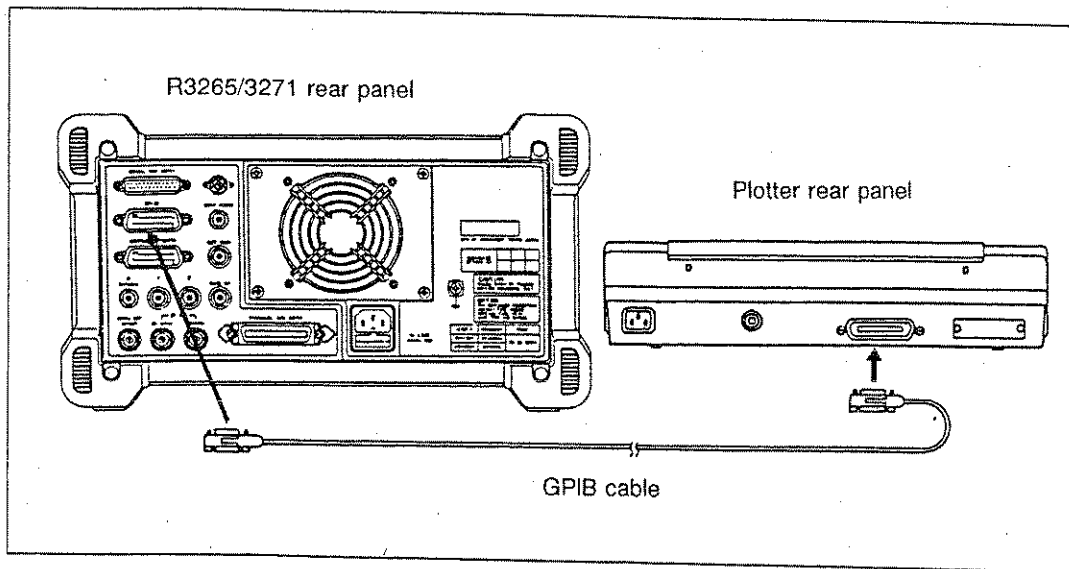

Fig. 5.9-1 Plotter Connection

CAUTION

1. When connecting the GPIB cable, the power switch should be turned OFF.
2. Read through the instruction manual of the plotter.

(2) Setting the Plotter

Set the dip switch corresponding to the plotter address to Listen Only mode.

Other than address setting may be required depending on the plotter type. Read the instruction manual of the plotter.

An example of setting A4 form in lateral direction on the R9833 (ADVANTEST) is given Fig.

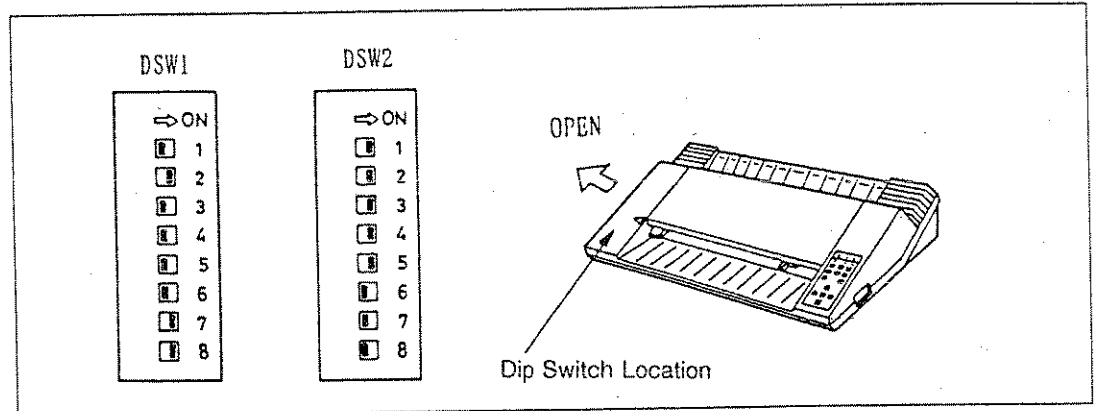
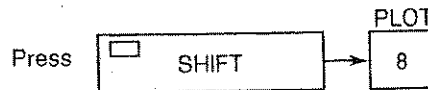

Fig. 5.9-2 Dip Switch Setting

(3) Plotter Operation Procedure



The following operation window will appear.
 Specify the necessary conditions on it.

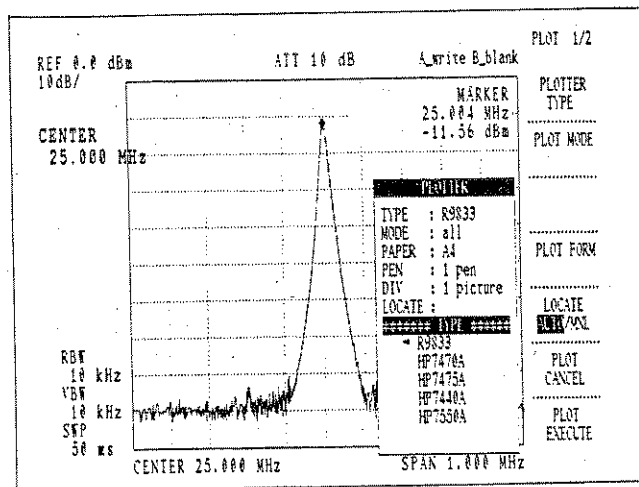
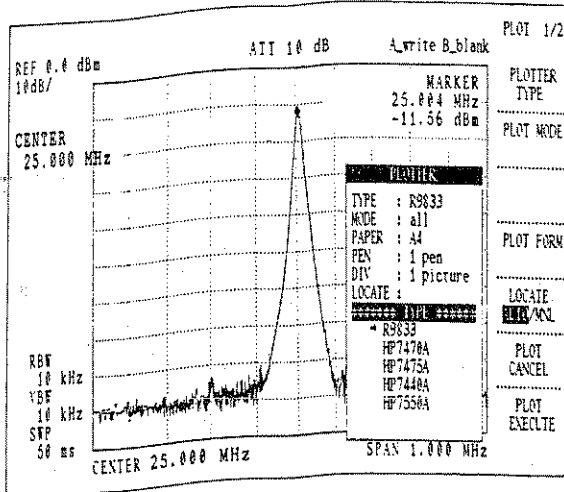
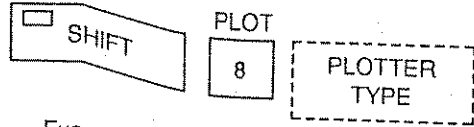

Fig. 5.9-3 Plotter Operation Screen

5.9 Plot Output Function



① Select the plotter.



Every time this key is pressed, the cursor (→) is shifted to select the plotter type.

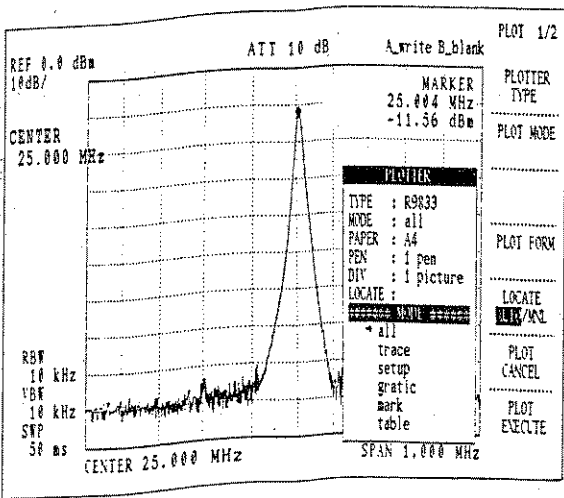

② Select the plot mode.

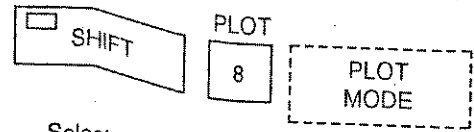

Select the plot mode by pressing this key. However, if a table is selected, select the table type as described in step ③.

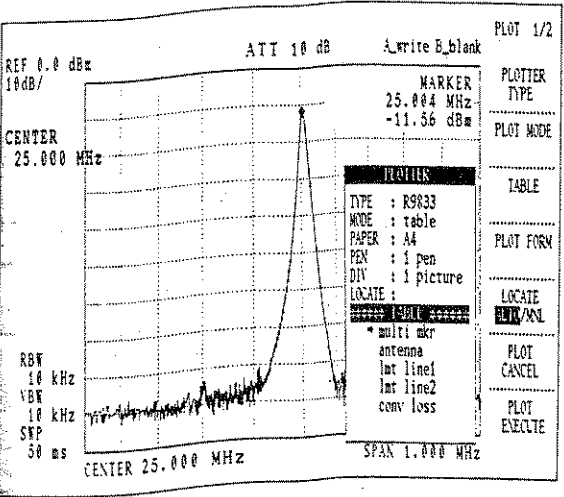

③ Select the table type.

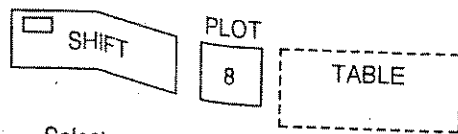

Select the table type by pressing this key. Note that this key is valid only if table has been selected as plot mode.

No TABLE will appear if plot mode has been set to other than table.

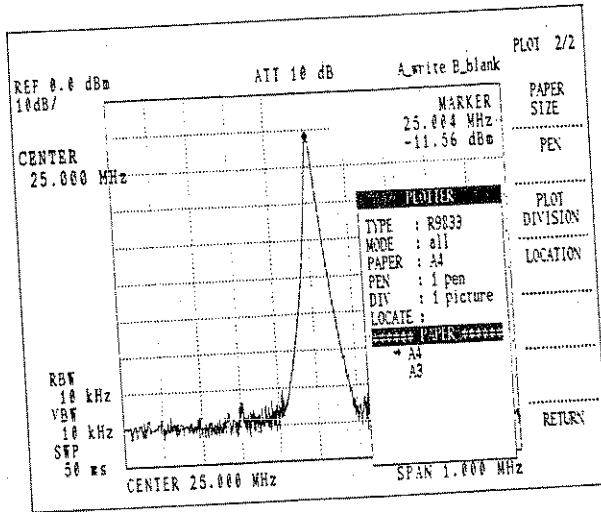

④ Select the plotter form size.

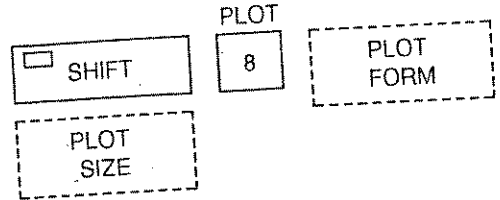

Press this key and select the plotter form size.

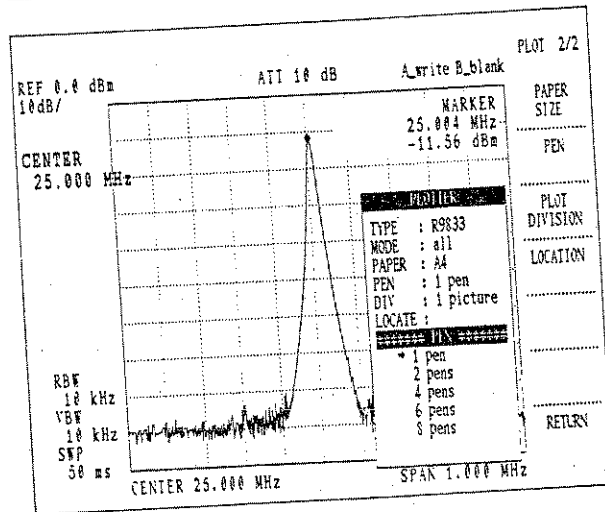

⑤ Select the number of pens.

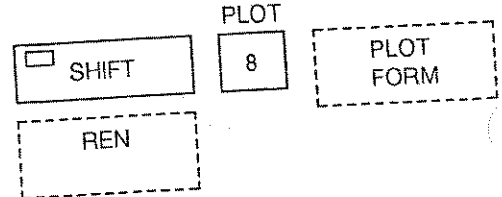

Press this key and select the number of pens.

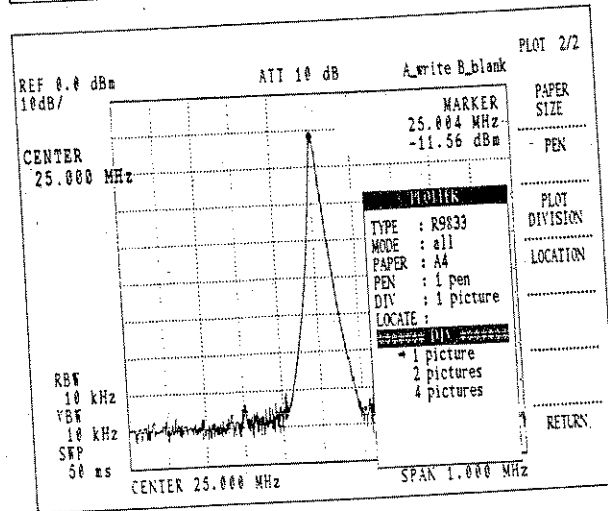

⑥ Select the screen split size.

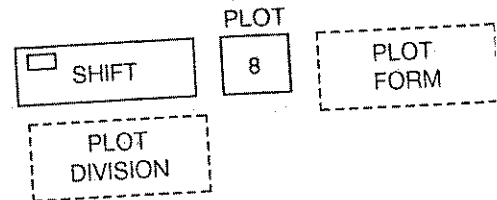

Press this key and select the screen split size.

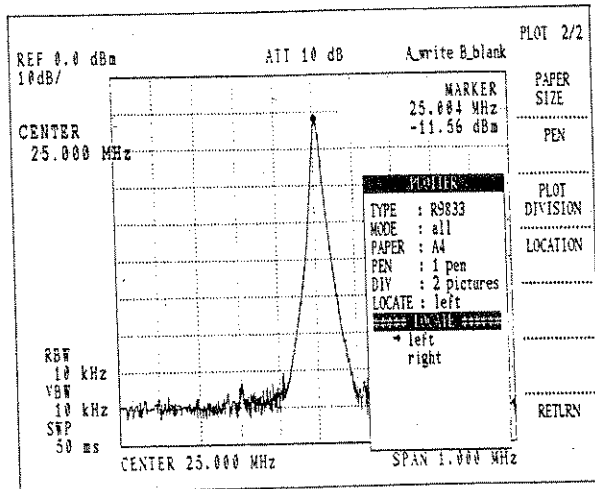

⑦ Select the screen to be output.

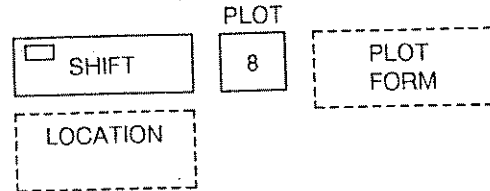

Press this key and select the screen part to be output.

Specified to be divided into two parts.

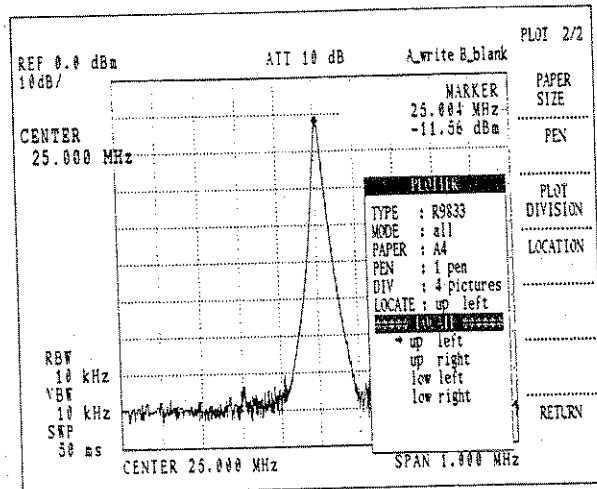

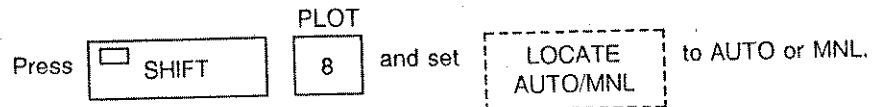

Specified to be divided into four parts.

⑧ Auto/Manual switching of the output position

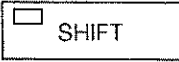

If AUTO is specified, all the divided screen parts will automatically be plotted.

⑨ Executing the plot output

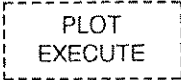
Press   and  in this sequence.

Plot output will be executed under the conditions which have been specified.

At this time, the operation window is replaced by the normal screen.

Even during plot output, panel key operation is accepted. You can proceed to the next step without waiting for the completion of the plot output. However, if another plot output is attempted during a plot output, an error message will appear.

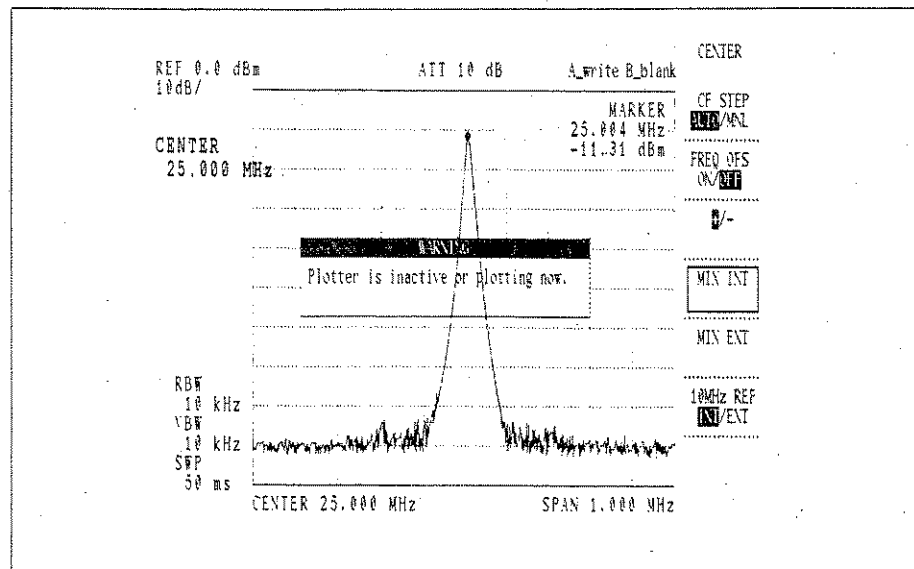
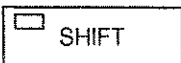



Fig. 5.9-4 Plotter error Message

⑩ Canceling the plot output

Press   and  in this sequence.

The plot output will be canceled.

However, if the plotter has a built-in buffer, the data in the buffer will be entirely output before the plot output stops.

CAUTION

1. For the operation of the plotter itself, read the Instruction Manual of the plotter.
2. The plotter types which can be selected for the analyzer are those based on HP-GL. Take care in mode selection.
 Note that screen split function may not be equipped, depending on the plotter type. For example, division into two cannot be specified for HP7470A.
3. If HP7475A select DIP-switch to US/A4, US/A3 for paper size.

Table 5.9-2 Plotter Pen Assignment

1-pen mode	Pen 1	Frame, marker, window, limit line, characters, display line, Waveform A and Waveform B
2-pen mode	Pen 1 Pen 2	Frame, marker, window, limit line, waveform B Waveform A, characters, display line
4-pen mode	Pen 1 Pen 2 Pen 3 Pen 4	Frame Display line, marker, window, limit line, characters Waveform A Waveform B
6-pen mode	Pen 1 Pen 2 Pen 3 Pen 4 Pen 5 Pen 6	Frame Marker, characters Waveform A Waveform B Display line Window, limit line
8-pen mode	Pen 1 Pen 2 Pen 3 Pen 4 Pen 5 Pen 6 Pen 7 Pen 8	Frame Marker, characters Waveform A Waveform B Display line Window Limit line

5.10 Label Function

This function is used to enter the label for waveforms and title for save/recall.

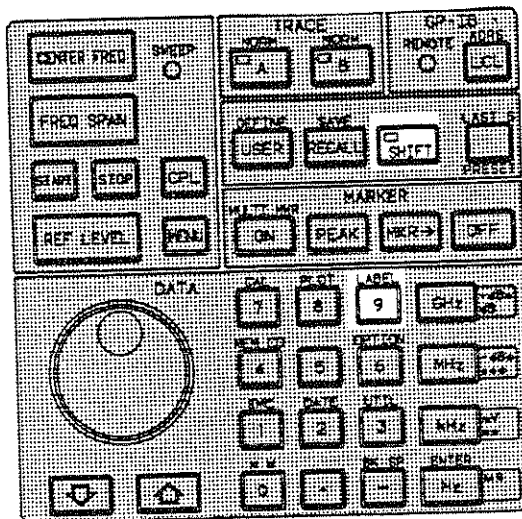

(1) Operation procedure

① Press the **SHIFT** **LABEL** **9** in this sequence.

② Move the cursor leftward and rightward with the step keys.

Pressing **↑** moves the cursor rightward and **↓** moves the cursor leftward.

③ By turning the data knob, select the required character and press **ENTER** to load the character.

④ To delete the character entered, press **BK SP**

CAUTION

If one and the same key is kept pressed for a while, the repeat function will operate and the data can be entered or deleted continuously.

(2) Menu

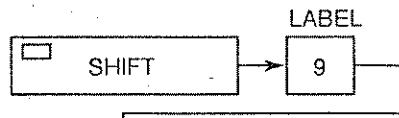

CAPS LOCK ON

Select an alphabetic character of upper case with the knob

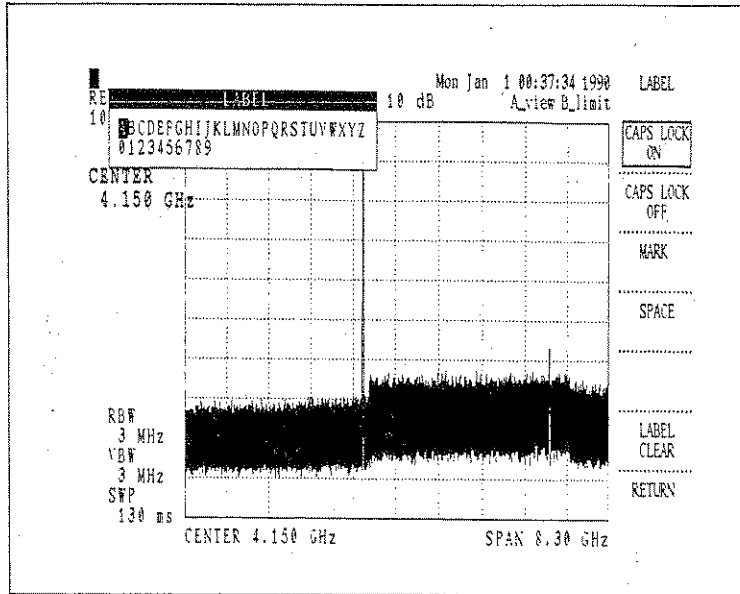
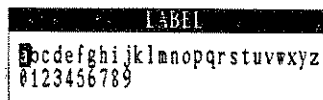

Fig. 5.10-1 Label Display

CAPS LOCK OFF

Select an alphabetic character of lower case with the knob



MARK

Select a symbol with the knob

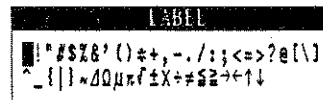

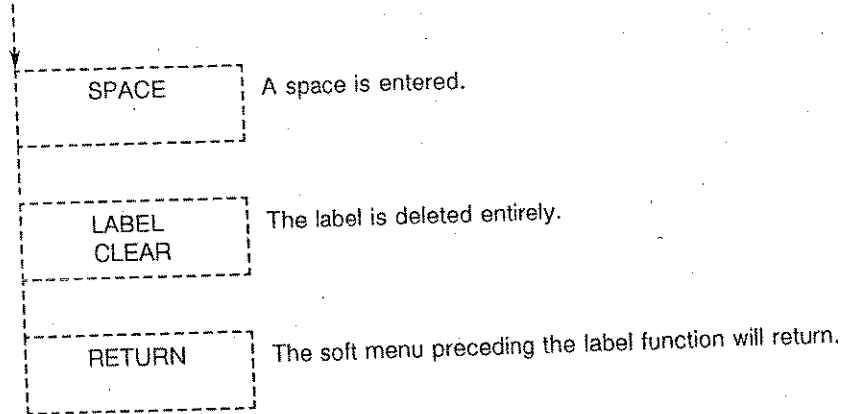

5.11 EMC Function

This function is used to set the analyzer as the EMC receiver.

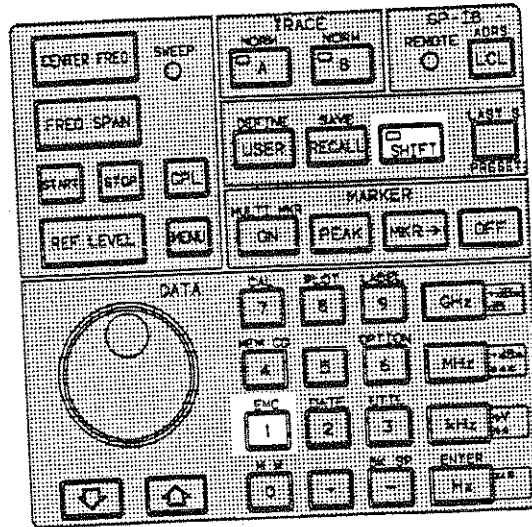

The following are determined in EMC measurement:

- Intensity of radiation interfering electric field using an antenna
- Voltage of the power source terminal using quasi-power source circuit
- Interfering power using absorption clamp

Note: For the detailed explanation on the EMC measurement, see the "EMI/EMC Measurement System Guide Book" which is on sale.

- (1) Correction of the antenna factor
Correct the antenna factor in the measurement of electric field intensity using an antenna. The correction factor is calculated and the level appears in $\text{dB}_\mu \text{V/m}$.

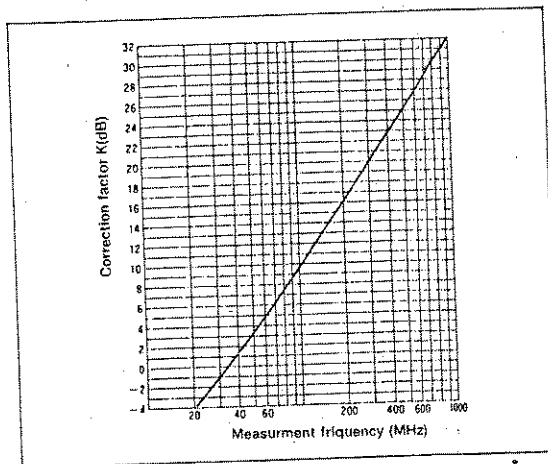
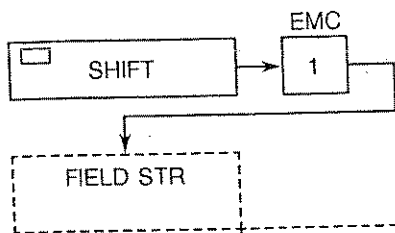
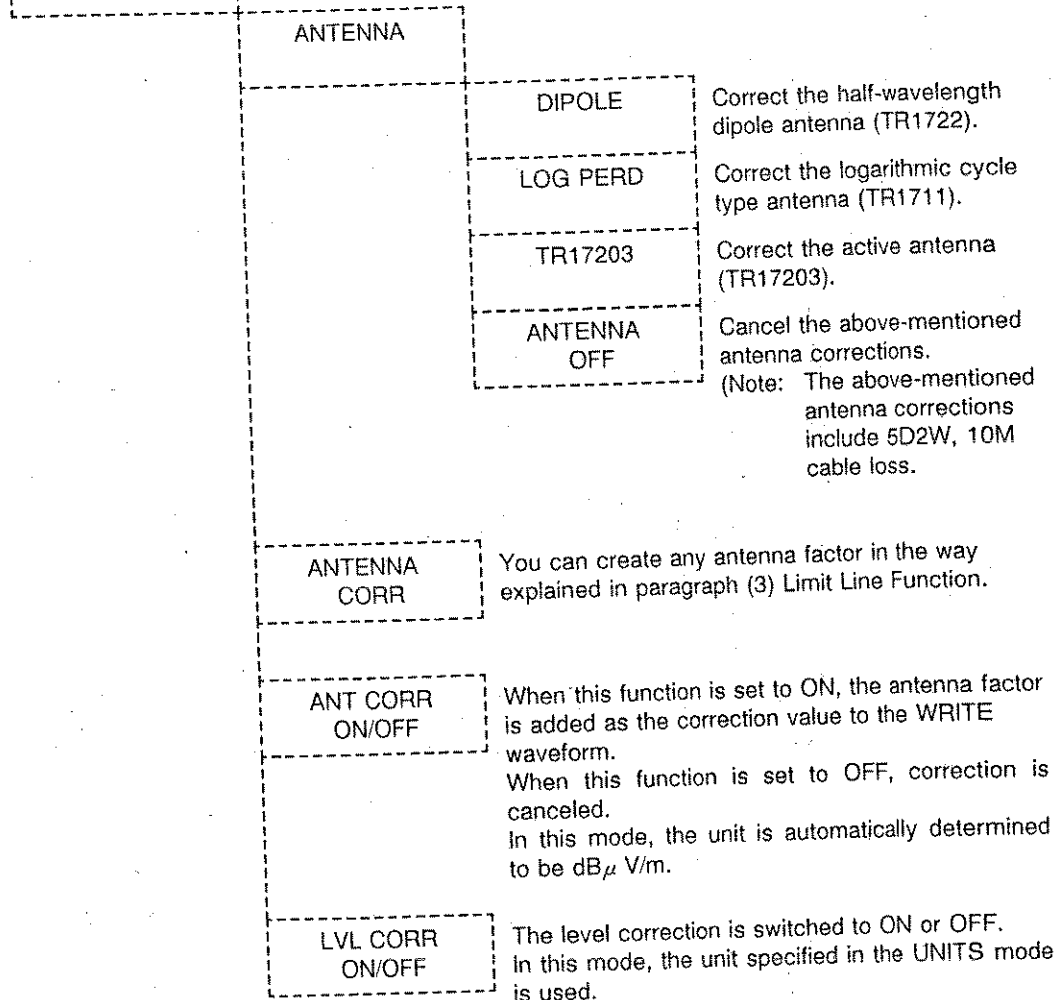

Fig. 5.11-1 TR1722 Antenna Factor



- (2) Detection Mode Selection
Select the detection mode defined in the CISPR specification.

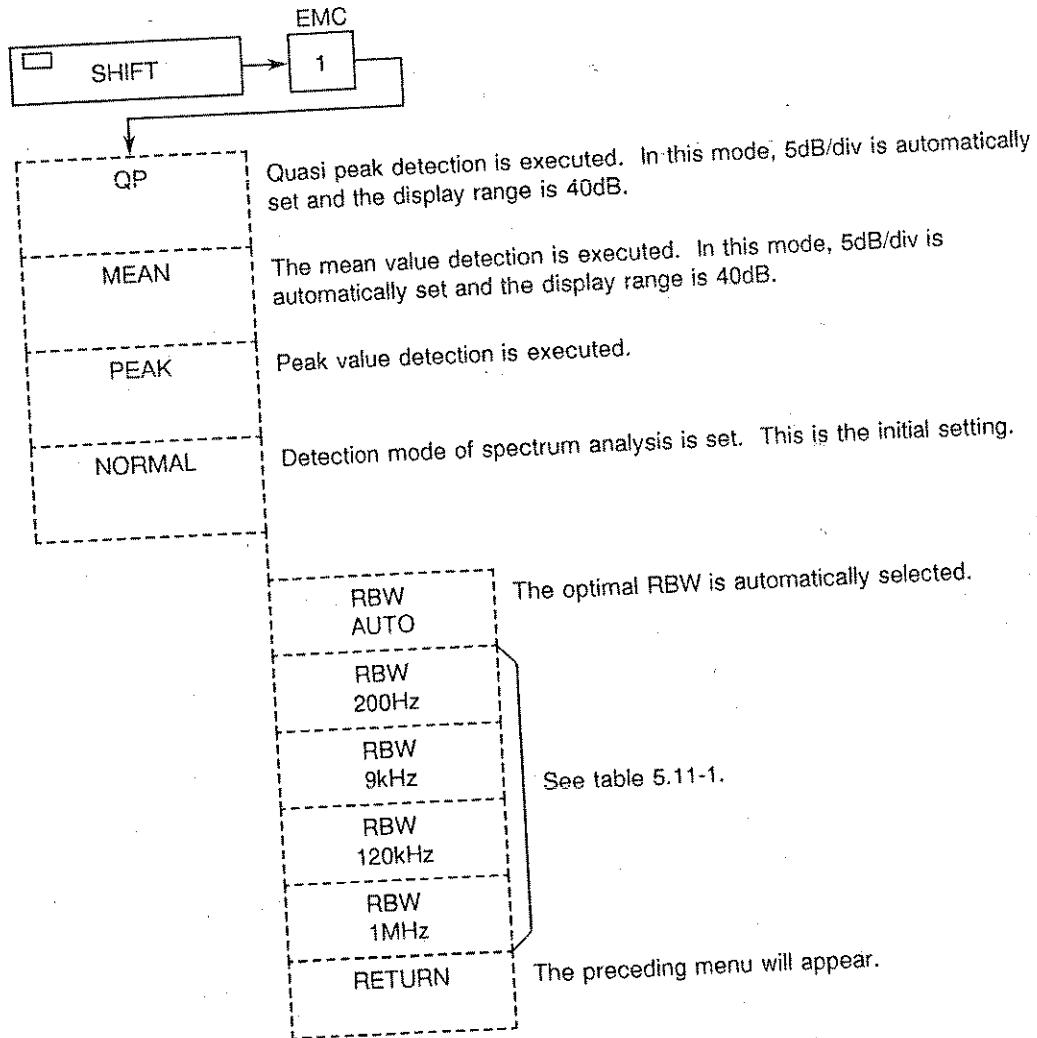

Table 5.11-1 RBW according to the CISPR specification

Measurement bandwidth		RBW (6dB bandwidth)	Sweep time setting
A	10 kHz to 150 kHz	200 Hz	1s per frequency span 200Hz
B	150 kHz to 30MHz	9 KHz	1s per frequency span 10kHz
C	40MHz to 300MHz	120 kHz	1s per frequency span 100kHz
D	300MHz to 1GHz	120 kHz	

(3) Limit Line Function

When the Limit Line function is operating, a line to indicate the spectrum upper limit or lower limit (or both) will appear on the spectrum so that data to be observed can be compared to the line(s).

① Entering a data table

Two limit lines can be used: Limit line 1 and Limit line 2.

Either the frequency domain data or the time domain data is selectable for each of limit lines 1 and 2.

Up to 51 points can be entered for the frequency and level as the limit line data. The frequency data can be entered in the range from 0 to 999.999GHz the time data can be entered in the range from 0 to 1000s, and the level data can be entered in the range from -240 to 100dBm. The level data can also be entered in the same unit as the reference level (excluding the units V and W).

Normally, data is entered in Input mode and modification is made in Modify mode.

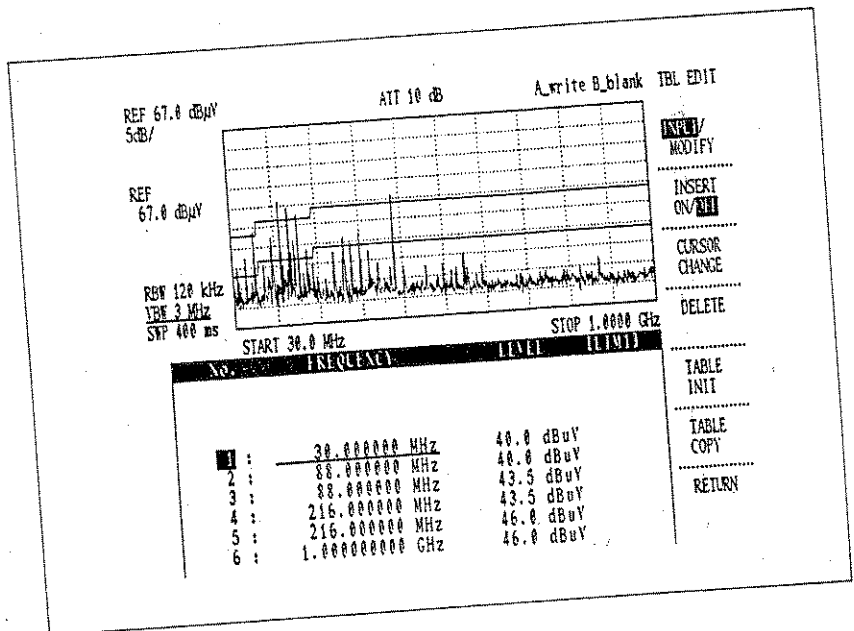

Fig. 5.11-2 Entering a Limit Line

② Limit line menu

Frequency domain data input



Time domain data input

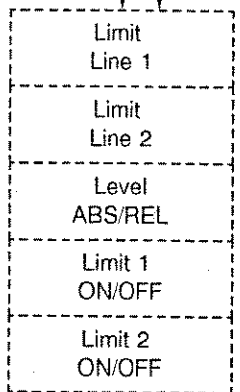

Limit lines 1 and 2 are automatically set to ON so that data can be entered.

Data can be scrolled with the Data knob and Step keys.

Sets level data as ABS (absolute value) or REL (relative value). If REL is selected, the reference level is used as reference.

Limit line 1/2 is switched ON or OFF. The line will appear when switched ON.

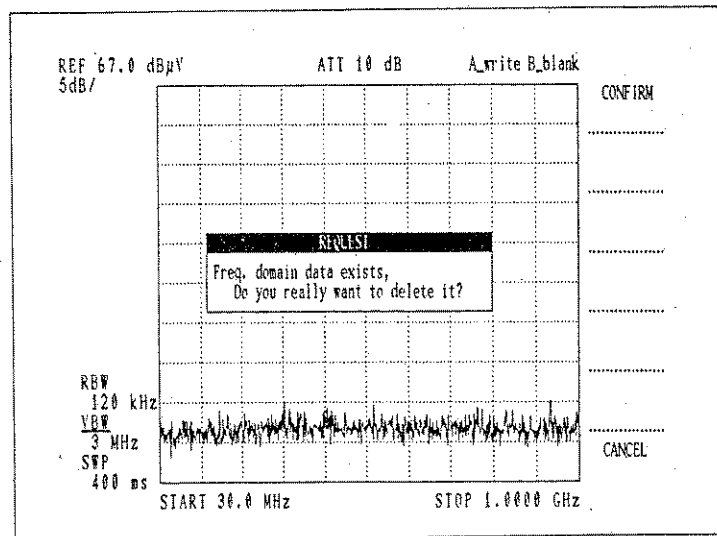
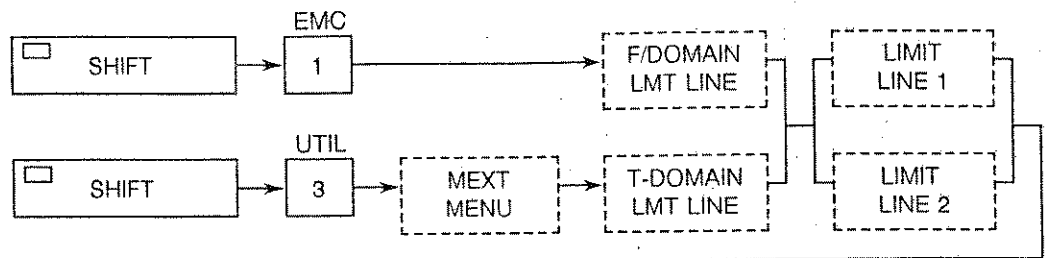

- ① Appears when input of time domain data is attempted with frequency domain data already input. Press to continue the input operation, and the preset frequency domain data is cancelled.

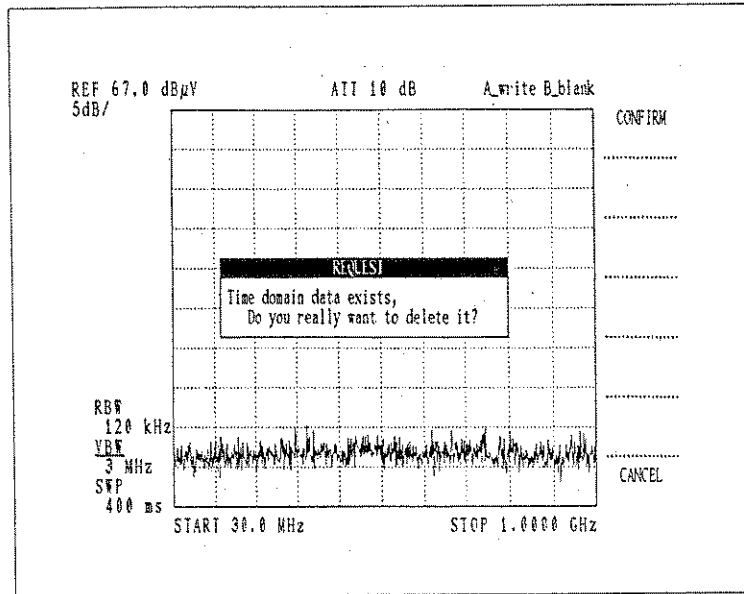

- ② Appears when input of frequency domain data is attempted with time domain data already input. Press to continue the input operation, and the preset time domain data is cancelled.

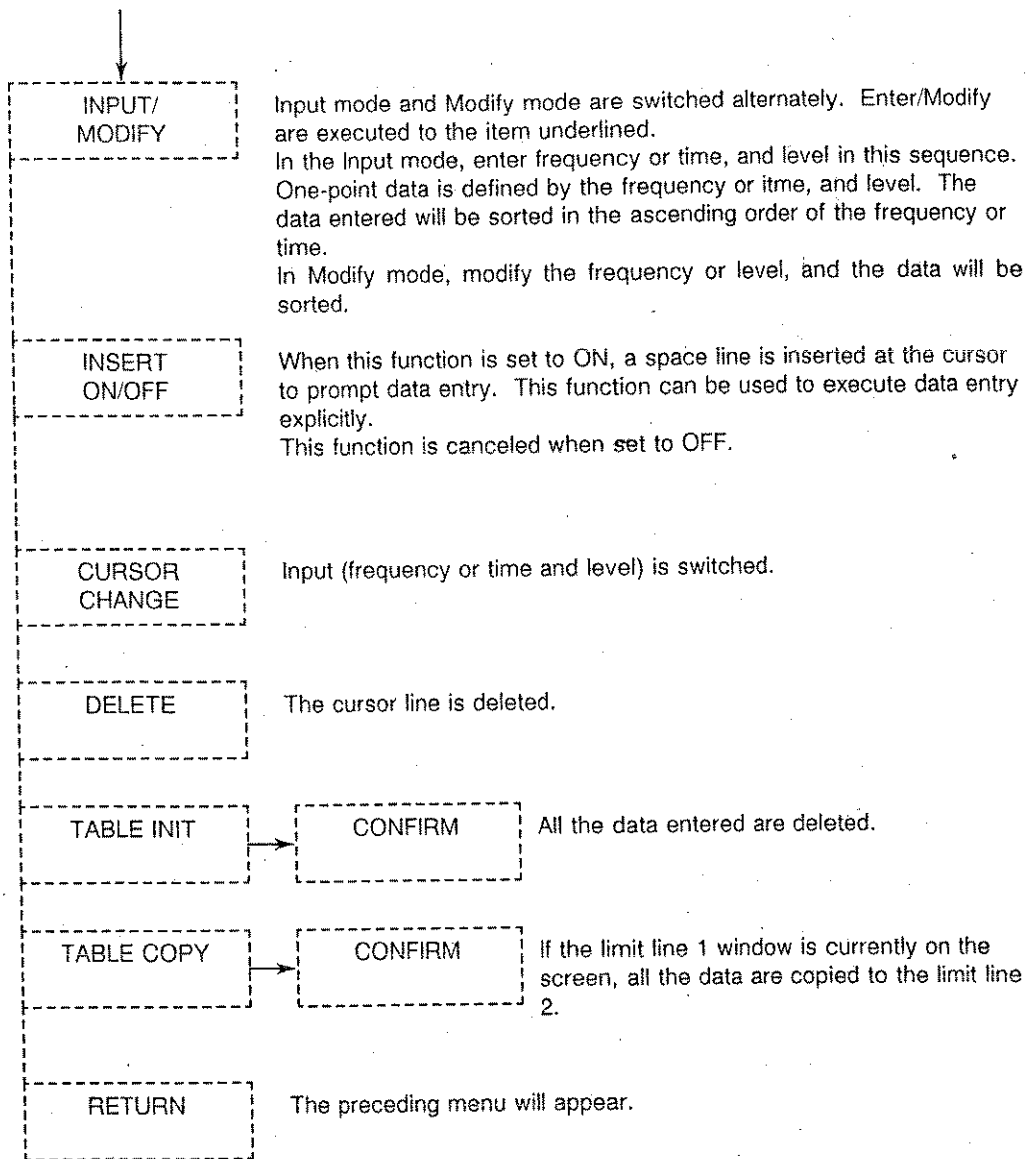

(4) Measuring the power source terminal voltage (using a quasi-power source circuit)

- ① Connect the signal line to be measured (DUT) as illustrated in Fig. 5.11-3 :

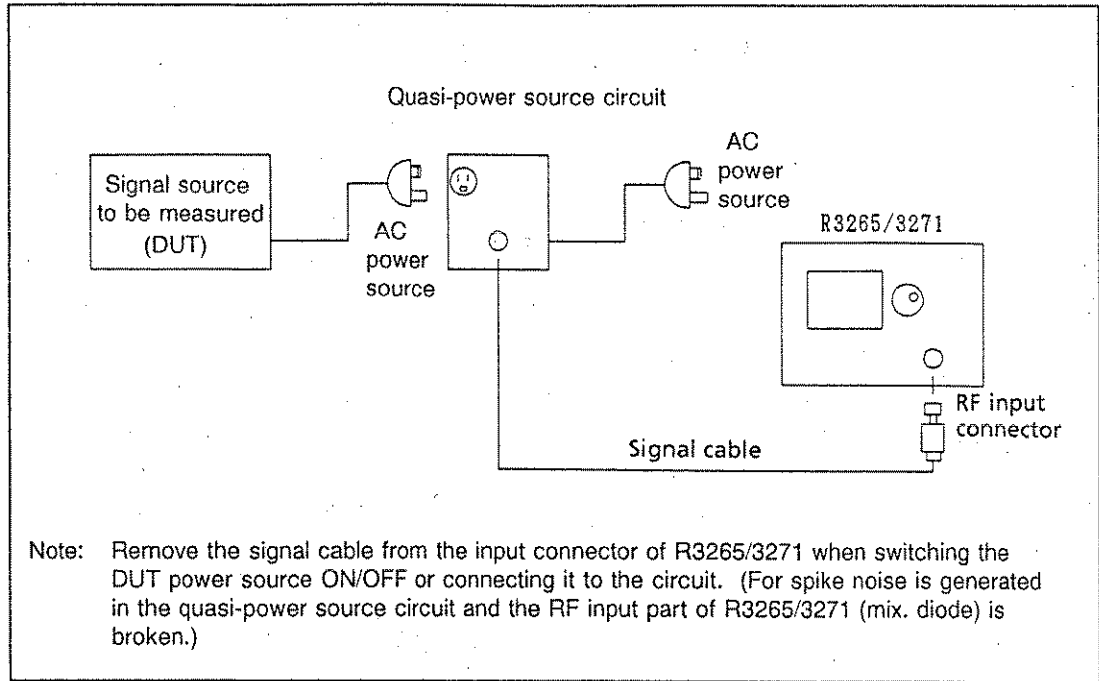

Fig. 5.11-3 Measuring the Power Source Terminal Voltage

- ② Enter the start and stop frequency to be measured.

Press the

START	1	5	0	kHz
-------	---	---	---	-----

 keys in this sequence.

Press the

STOP	1	0	MHz
------	---	---	-----

 keys in this sequence.

- ③ Confirm that the waveform level will not vary while increasing or decreasing the attenuator by 10dB. If the waveform level varies, which means the analyzer input stage is saturated, increase the attenuator value or insert the band pass filter in the input.

Press the

COUPLE	ATT
--------	-----

 and adjust the data with the

↑

 or

↓

 key. Confirm that the level will not vary.

- ④ Press the REF LEVEL key and make adjustment with the knob  so that the signal will be at the reference level.

- ⑤ Specify the QP resolution bandwidth.

Press the SHIFT EMC 1 QP and set BW AUTO

The resolution bandwidth (9kHz) and the charge and discharge constant will be automatically selected.

Notes: 1. If the Start and Stop frequency are specified in multiple measurement regions, the resolution bandwidth is automatically selected according to the Stop frequency.

2. In QP mode, 5dB/div is automatically specified.

- ⑥ Set the sweep time according to Table 5.11-1 .

Press the COUPLE SWP and adjust the data with ↑ or ↓ key.

The Sweep time should be long enough. (For example 1000 seconds)

- ⑦ Set the marker on the screen to read the data and correct the data with the correction factor corresponding to the quasi-power source circuit.

Press the MULTI MKR ON and adjust the data with knob 

- ⑧ When the QP measurement mode is canceled, the REf mode will be set.

Press the SHIFT EMC 1 NORMAL to cancel the QP mode.

5.12 DATE Function

Using this function, you can set the year, month, day and time.

The data function operates from 1989.1.1 to 2088.12.31 (leap year included).

During this period, the day of the week is automatically determined.

The time is indicated by 24-hour system.

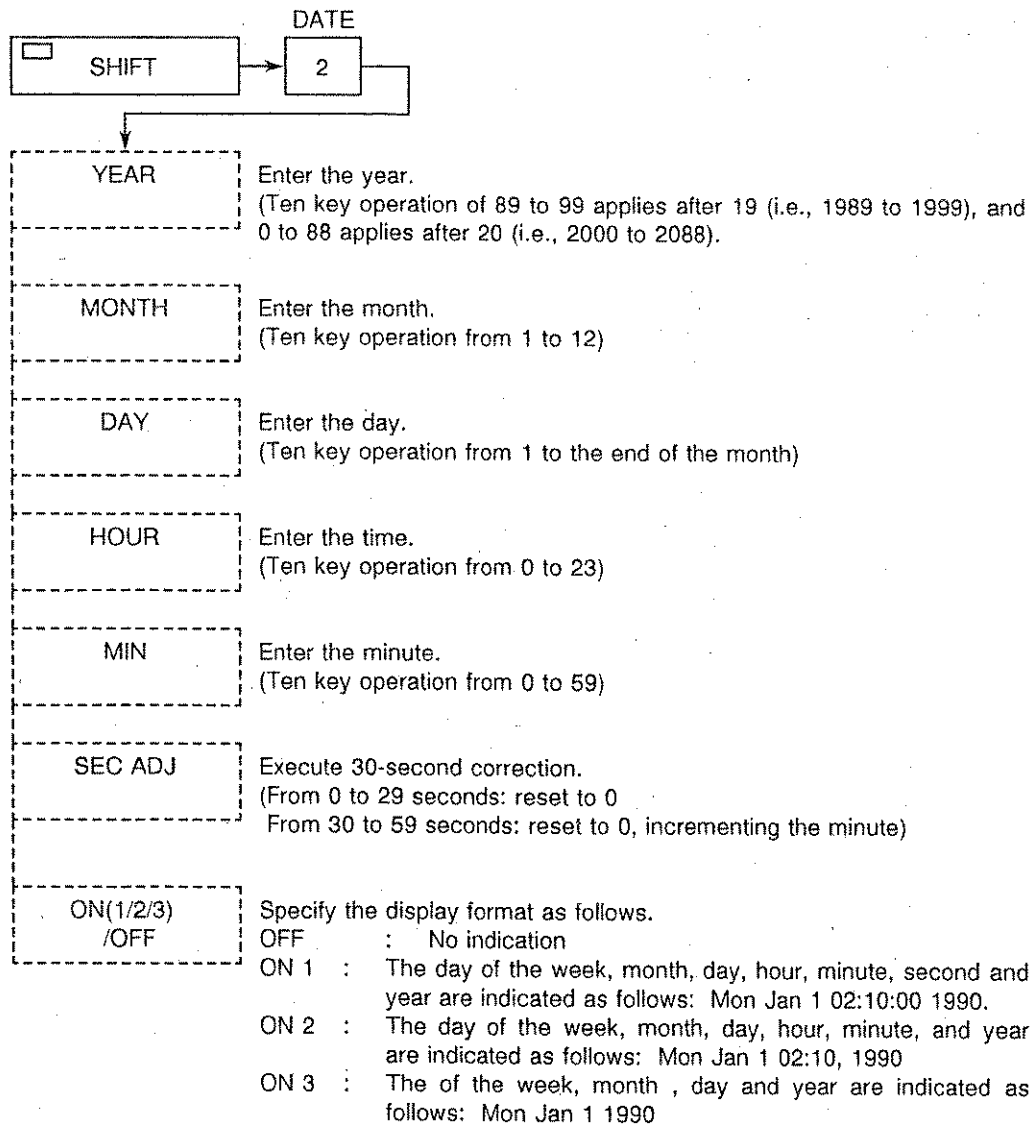

5.13 Utility function

The occupied bandwidth (OBW) and the adjacent channel leak power (ADJ) can be determined.

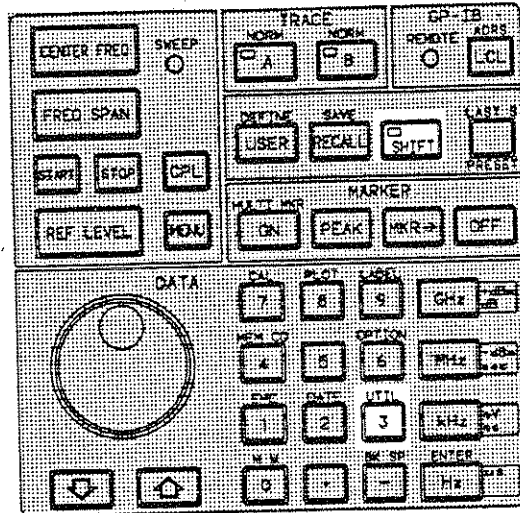

(1) Waveforms to be measured

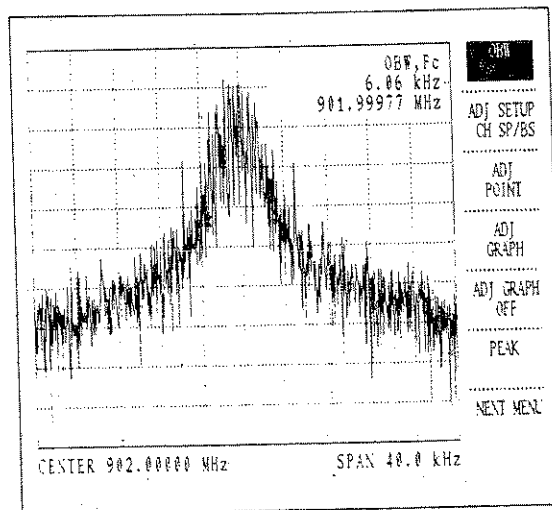

Fig. 5.13-1 Waveform to determine the OBW

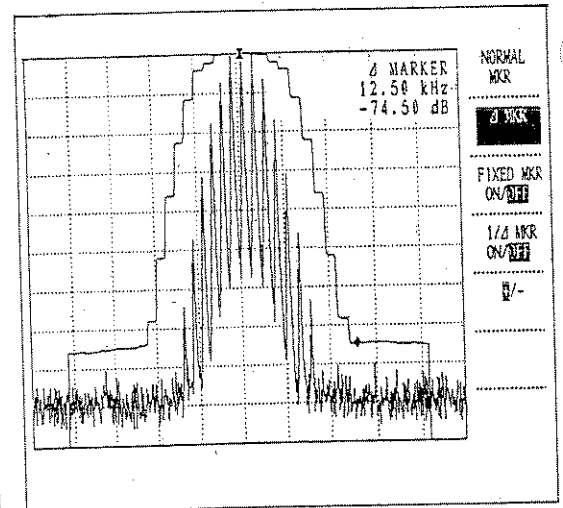
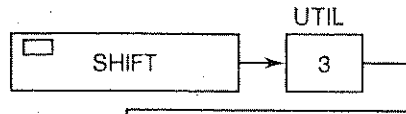

Fig. 5.13-2 Adjacent channel leak power in graph

(2) Utility menu



OBW

The occupied bandwidth of the waveform on the screen is determined by calculation. The results are displayed, centering at the carrier frequency (F_c) between the occupied bandwidth (OBW) and the occupied bandwidth.
 The measurement method is detailed in Chapter 5 Examples of Measurement (Section 4.5).

ADJ SETUP
 CH SP/BS

Specify the channel spacing (CH SP) and set the bandwidth specified (BS) to measure the adjacent channel leak power. Every time this key is pressed, CH SP and BS are switched alternately. The one reversed in black-white is active. Enter the value with Ten keys.

ADJ POINT

The upper adjacent channel and lower adjacent channel leak power are determined by calculation at the channel spacing specified with

ADJ SETUP

centering at the active marker frequency. The upper and lower adjacent channel leak powers will appear with UP and LOW indication, respectively, in the marker display area. The marker will appear at each adjacent channel frequency.

CAUTION

1. An error is caused unless the active marker has been set to the channel frequency to be measured.
2. This function will not operate if no channel spacing or bandwidth has been specified with the ADJ SETUP or an improper value has been entered.

the measurement method is detailed in Chapter 4 Examples of Measurement (Section 4.6).

ADJ GRAPH

The leak power is calculated at the every frequency point on the screen with the bandwidth specified with the

ADJ SETUP

and the results will appear as a graph.

The marker will be shifted to the displayed graph and the leak power can be determined at the frequency of the marker point.

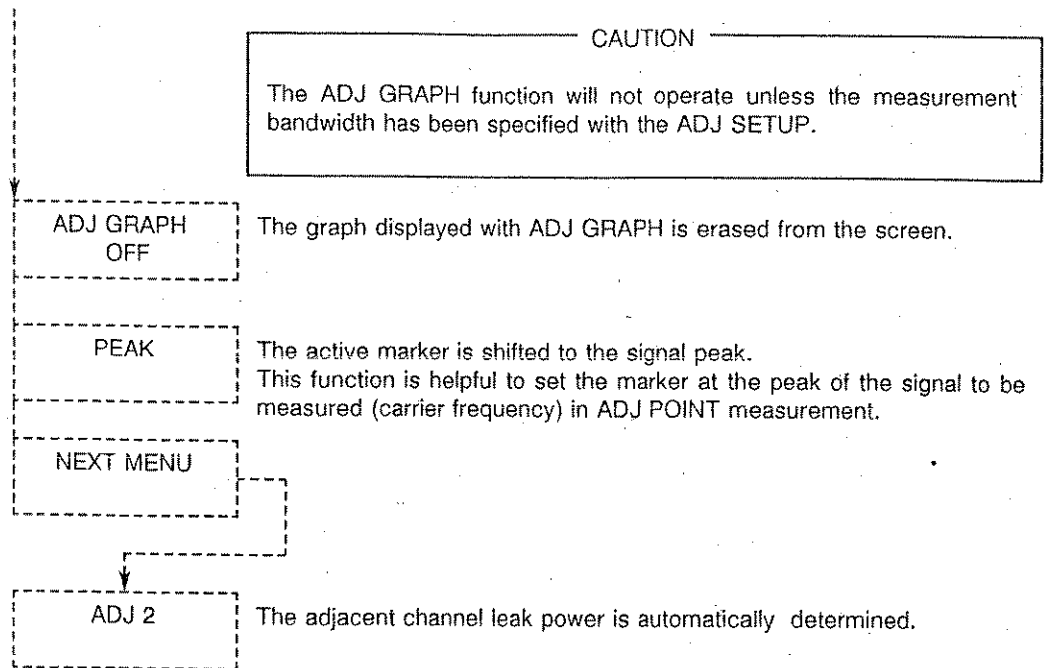

Assuming the center frequency specified as the carrier frequency, specify the span on the bandwidth specified with the

ADJ SETUP, and determine the total (PC) of the waveform power displayed on the screen.

Switch the center frequency to the upper and lower adjacent channels determined by the channel spacing specified with the

ADJ SETUP and determine the power total for each

of them (PU and PL). Determine the ratio of PU against PC and ratio of PL against PC. The upper and lower adjacent channel leak power will appear on the screen as UP and LOW, and a marker will appear at each channel frequency.

- CAUTION**
1. If the signal to be the carrier frequency is set apart from the center frequency, a measurement error will be caused.
 2. This function will not operate if no channel spacing of bandwidth has been specified with the ADJ SETUP, or an improper value has been set.
 3. After the calculation is complete, the marker is displayed with the value of the channel spacing multiplied by 3 is set as the span.

5.14 Measurement Window Function

Sweep and marker peak search operate within the window specified.
Quick measurement can be realized with a wide span.

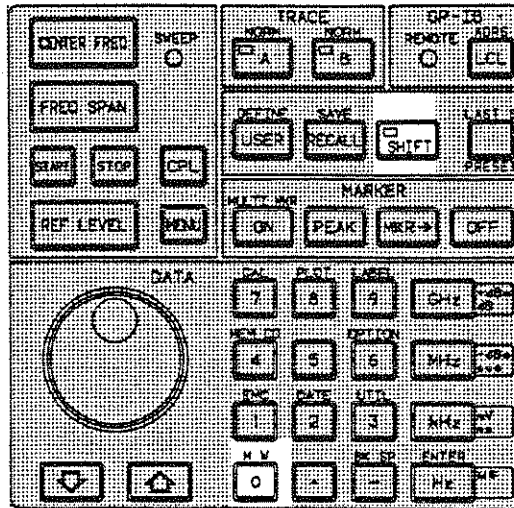

(1) Window setting menu



The initial screen of the measurement window will appear.
The window setting can be modified during measurement to modify the measurement conditions.

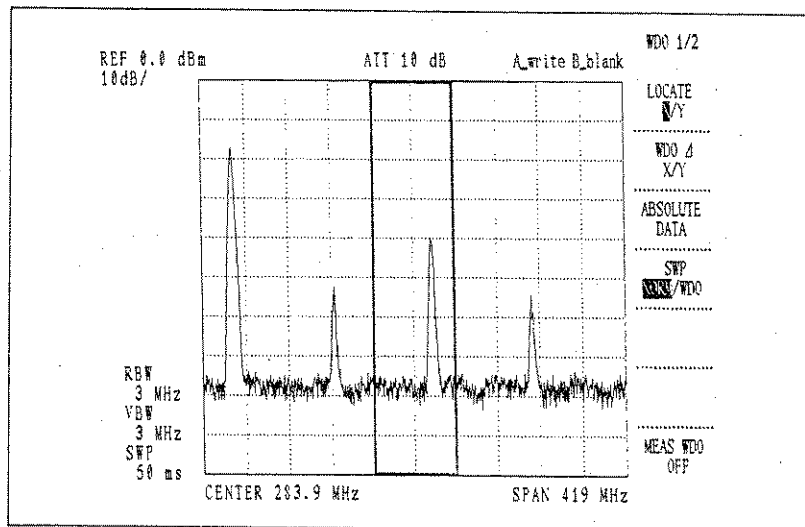
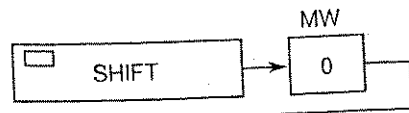



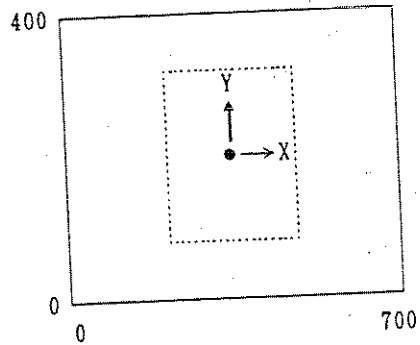





Fig. 5.14-1 Initial screen of Measurement window



LOCATE X/Y Specify the window center position (X, Y) with the keys and knob   



WD0 Δ X/Y The window width (ΔX) and length (ΔY) can be increased or decreased with the   keys and knob .

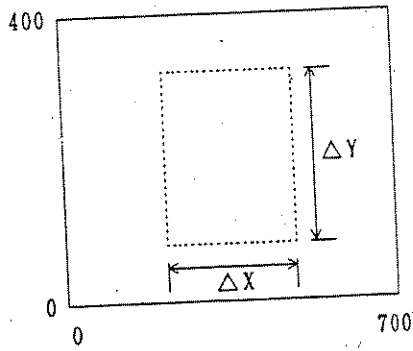

SWP NORM/WD0 When set to WD0, sweep is executed within the window. When set to NORM, the sweep within the window is canceled.

ABSOLUTE
DATA

The window can be specified with absolute values using the



keys, knob  and Ten keys.

MEAS WDO
START

Specify the Start frequency.

MEAS WDO
STOP

Specify the Stop frequency.

MEAS WDO
UPPER

Specify the upper level.

MEAS WDO
LOWER

Specify the lower level.

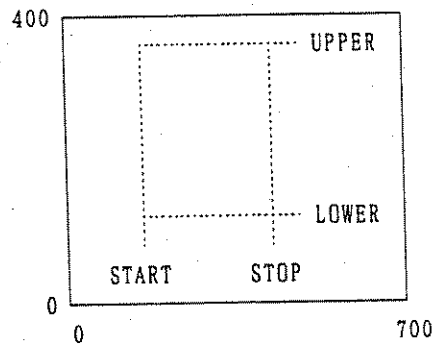

MEAS WDO
OFF

The window will be erased from the screen.
At this time, the measurement using the window is canceled.

(2) An example of window measurement

① Partial sweep within the window

Press SHIFT MW and set

to MD0. (This function is canceled when the key is set to NORM.)

OR

Press

(This function is canceled when these keys are pressed again.)

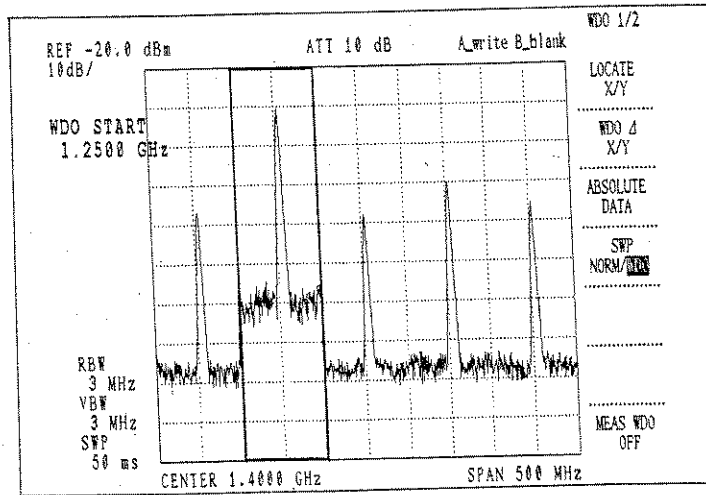

Fig. 5.14-2 Partial Sweep within a Window

- ② Peak search and continuous peak search within a window

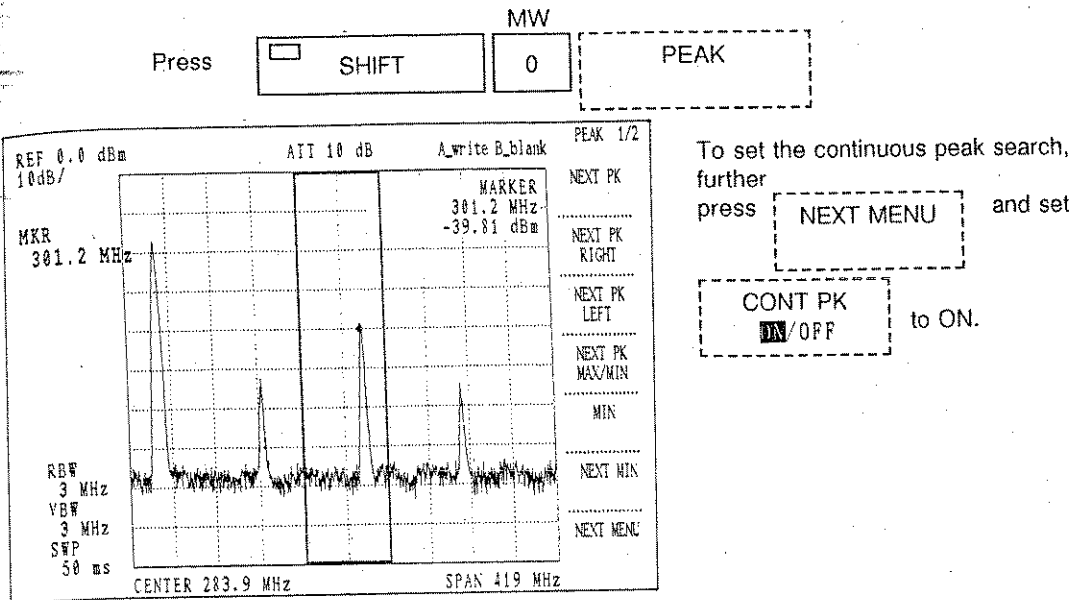
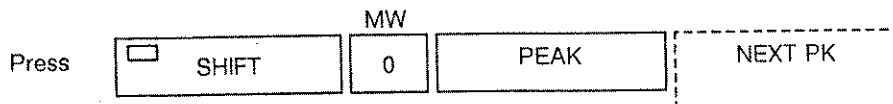
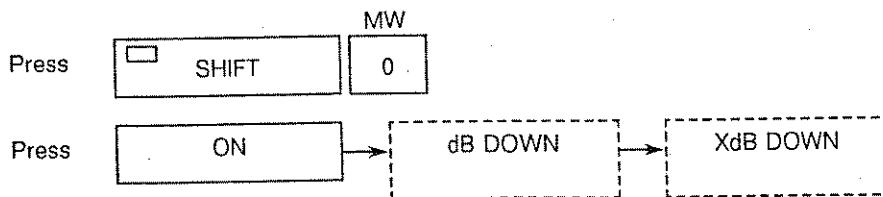

Fig. 5.14-3 Peak Search within a Window

- ③ NEXT peak search within a window



- ④ XdB down within a window



CAUTION

The XdB DOWN function will not operate unless the marker to be the reference of XdB down is located within the window.

6. GPIB: REMOTE PROGRAMMING

The analyzer loaded with a general-purpose interface abuse (GPIB) can be fully remote-controlled by the external controller. This chapter explains the external control and its programming.

Table of Contents

6.1 Outline of GPIB	6-2
6.2 GPIB Specifications and the Analyzer GPIB Specifications	6-4
6.3 GPIB Setting	6-8
6.3.1 Setting the GPIB Address	6-8
6.3.2 Delimiter	6-8
6.3.3 Input/Output format	6-8
6.4 Input Format (Listener)	6-9
6.5 Output format (Talker)	6-15
6.6 Input and Output of Trace Data	6-20
6.7 Service Request (SRQ)	6-27
6.8 List of GPIB Codes	6-34

6. GPIB

6.1 Outline of GPIB

The analyzer is loaded with the measurement bus GPIB (general-purpose interface bus) of IEEE specification 488-1978 and can be controlled at distance fully by the external controller.

(1) GPIB extension and compatibility

The GPIB is an interface system connecting the analyzer with the controller and peripheral devices with a cable (bus line). The GPIB is superior to the current interface method in extensibility and compatible electrically, mechanically and functionally with products of other companies. High-grade measuring system can easily be constructed with this GPIB in the same way as a simple system with a single bus cable.

(2) Talker, Listener, Controller

In the GPIB system, "address" is assigned to the devices connected to the bus line. Each device can play one or two roles selected from Controller, Talker and Listener. During system operation, only one talker can transmit data to the bus line and multiple listeners can receive the data. The controller specifies the talker and listener addresses and transfers data from the talker to the listener, or the controller itself can play the role of talker and specifies listener measurement conditions.

(3) GPIB-related panel switches

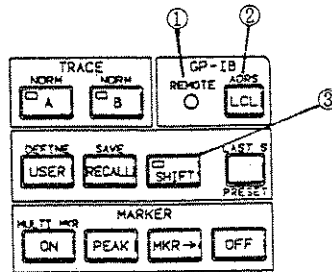

Front panel

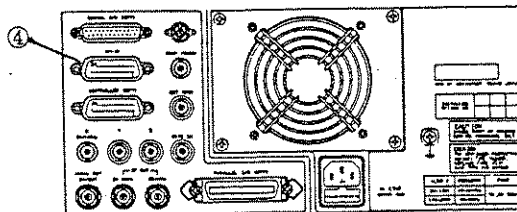

Rear panel

- ① Remote lamp
This lamp will light when the analyzer is set to External control mode.
- ② LCL key
This is used to switch between Remote and Local.
With this switch, external control can be interrupted to enable input from the panel.
- ③ Shift key
After pressing this key, press the LCL key so that GPIB address can be specified.
- ④ GPIB connector
This terminal is used to connect the analyzer to the external controller or plotter with the GPIB cable.

(4) Functions which can be controlled externally

- ① Setting the measurement conditions: Entering the measurement conditions in the same way as the panel key operation.
- ② Output of the setting conditions: The analyzer setting conditions and data call.
- ③ Input and Output of measurement data: Screen trace, Data write and read out.
- ④ Service request to the controller: Interrupt processing request to the controller control and output of status byte.

6.2 GPIB Specifications and the Analyzer GPIB Specifications

(1) Bus line

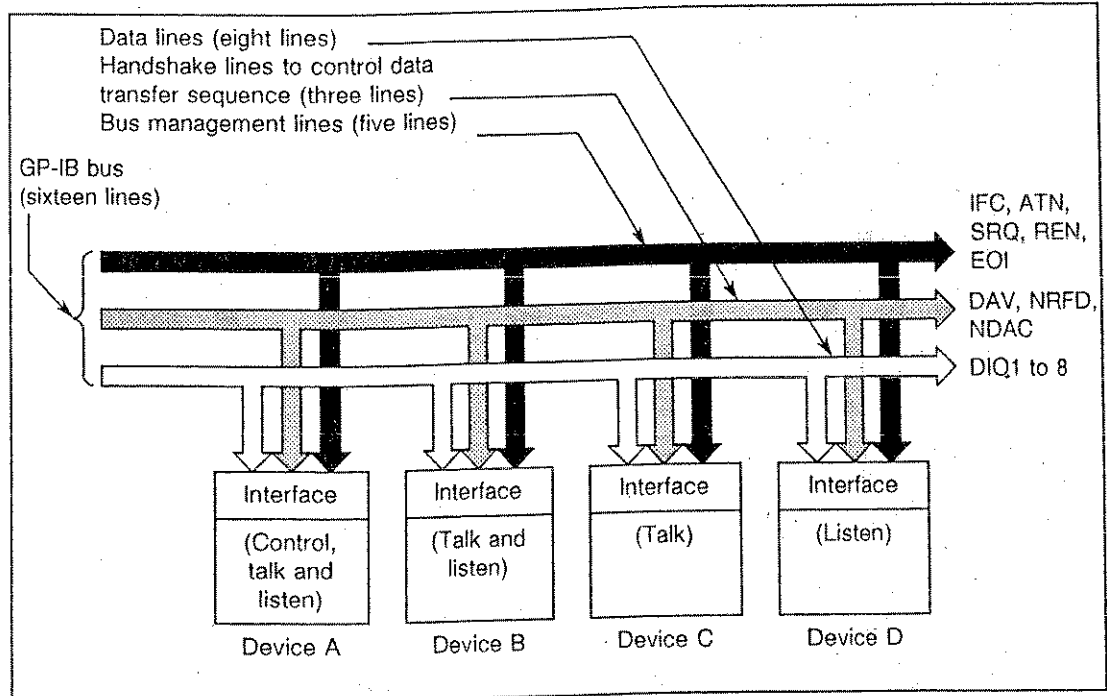

Fig. 6.1-1 GPIB Bus Line Configuration

The GPIB bus cables include eight data lines, three transfer control lines (handshake lines) to control asynchronous data transfer between devices and five bus management lines (control lines) to control information flow through the bus.

- **Data line:** Eight data lines of bit parallel bite serial type are used for data transfer between devices so that asynchronous bi-directional transfer can be executed. Since it this is an asynchronous system, devices of high speed and low speed can be connected at once. ASCII code is used in the data (messages) transferred between devices, including measurement data, measurement conditions (programs) and various commands.
- **Transfer control lines (Handshake lines) :**
 The following signals are used:
 DAV (Data valid): Signal indicating the data valid state
 NRFD (Not ready for data): Signal indicating that data can be received
 NDAC (Not data accepted): Signal indicating that data receive is complete

6.2 GPIB Specifications and the Analyzer GPIB Specifications

- Bus control lines: the following signals are used:
 - ATN (Attention): Signal to determine whether the signal on the data line is a command or other information.
 - IFC (Interface clear): Signal to clear the interface.
 - EOI (End of identify): Signal used upon completion of information transfer.
 - SRQ (Service request): Signal to make service request to the controller from a device.
 - REN (Remote enable): Used to remote-control a device which can be remote-programmed.
- (2) Connector: 24-pin GPIB connector, 557-20240-D35A (Product of Amphenor or its equivalent)

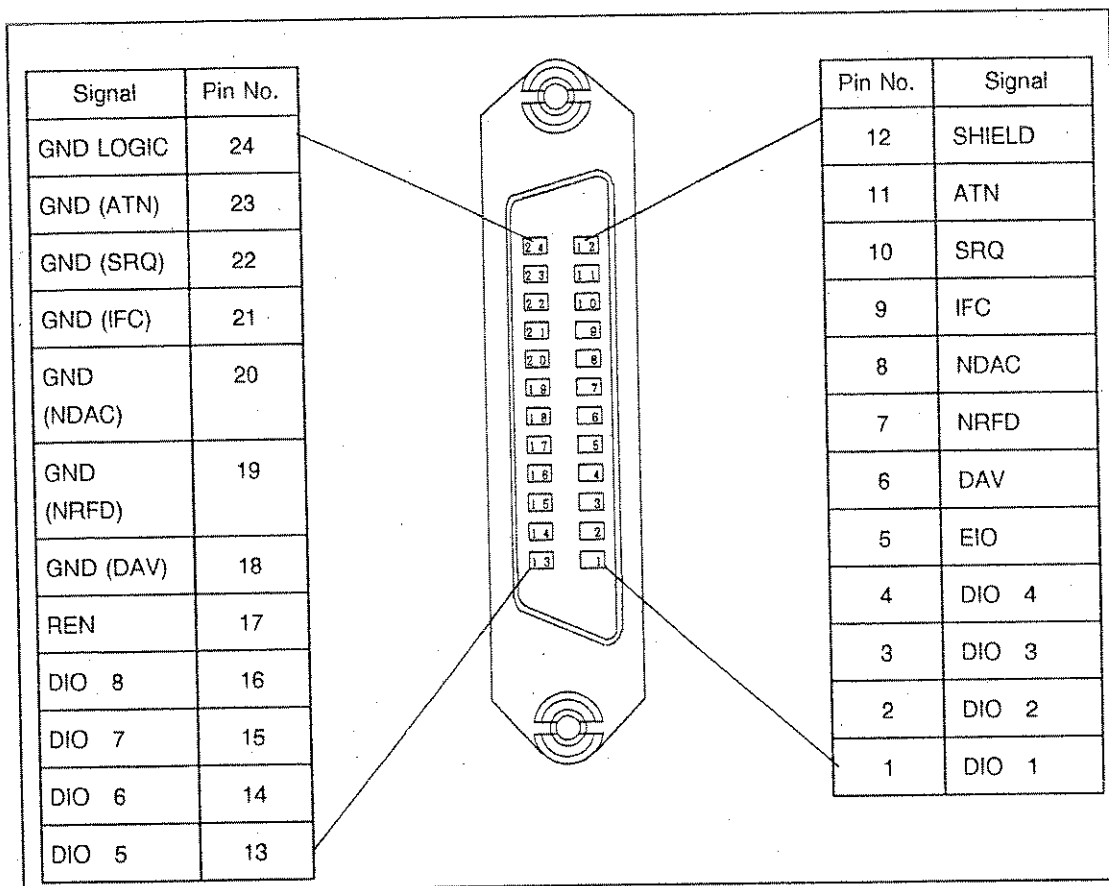

Fig. 6-2 GPIB Connector Pin Assignment

(3) Specifications

Code: ASCII code, except at packed formatting when binary code is used.

Logic level: Logical 0 "High" state +2.4V or above

Logical 1 "Low" state +0.4V or below

Signal line termination: The sixteen bus lines are terminated as shown below. (Fig. 6-3)

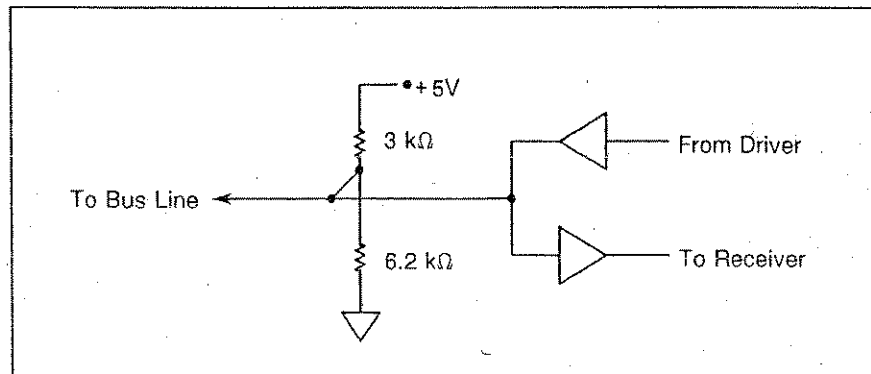

Fig. 6-3 Signal Line Termination

Driver: Open collector type

Output voltage at "Low" ... +0.4V or below, 48mA

at "High" +2.4V or above, -6.2mA

Receiver: +6V or below ... "Low" state

+2.0V or above ... "High" state

Bus cable length: Each cable length should be 4m or less and the total bus cable length, i.e., twice the number of devices connected to the bus, should not exceed 20m.

Address specification: Up to 31 talk/listen addresses can be entered through panel key operation.

R3265/3271
SPECTRUM ANALYZER
INSTRUCTION MANUAL

6.8 List of GPIB Codes

Function	Listener code	Talker request			Remarks
		Code	Output format	Header	
Display line	DL *	DL?	OFF/ON + Level	Unit : Header dBm: DLB dBmV: DLM dB μ V: DLU dB μ Vemf dBm: DLE dBpW: dlp V:DLV W:DLW	
Display line ON	DL ON *	-	-	-	
	DLN *	-	-	-	
Display line OFF	DL OFF	-	-	-	
	DLF	-	-	-	
Character display?	-	CHD?	OFF/ON	-	
	-	ANNOT?	-	-	
Character display ON	CHD ON	-	-	-	
	ANNOT ON	-	-	-	
Character display OFF	DHC OFF	-	-	-	
	ANNOT OFF	-	-	-	
Grid?	-	GR?	OFF/ON	-	
	-	GRAT?	-	-	
Grid ON	GR ON	-	-	-	
	GRAT ON	-	-	-	
	GN	-	-	-	

R3265/3271
SPECTRUM ANALYZER
INSTRUCTION MANUAL

6.8 List of GPIB Codes

Function	Listener code	Talker request			Remarks
		Code	Output format	Header	
Grid OFF	GR OFF	—	—	—	
	GRAT OFF	—	—	—	
	GF	—	—	—	
Frequency display?	—	FRD?	OFF/ON	—	
Frequency display ON	FRD ON	—	—	—	
Frequency display OFF	FRD OFF	—	—	—	
Input format?	—	IN?	0 : RF 1 : PI (Plug IN)	—	
: RF input	RFIN	—	—	—	
: PI input	PI	—	—	—	
Impedance?	—	OHM?	0 : 50Ω 1 : 75Ω	—	
: 50Ω	OHM50	—	—	—	
: 75Ω	OHM75	—	—	—	
Rear panel output					
: AXIS	AXIS	—	—	—	
: 2V/GHz	LOSWP	—	—	—	
Trace A	TA	TA?	(Lower bytes) 0: write 1: view 2: blank 3: normalize 4: A-DL→A 5: A-B→A 6: B-A→A		

R3265/3271
 SPECTRUM ANALYZER
 INSTRUCTION MANUAL

6.8 List of GPIB Codes

Function	Listener code	Talker request			Remarks
		Code	Output format	Header	
			(Upper bytes)		
			0: nothing		
			1: + max hold		
			2: + averaging		
			3: + min hold		
A write	AWRITE	-	-	-	
	AW	-	-	-	
A view	AVIEW	-	-	-	
	AV	-	-	-	
A blank	ABLANK	-	-	-	
	AB	-	-	-	
A max hold	AMAX	-	-	-	
	AM	-	-	-	
A min hold	AMIN	-	-	-	
A averaging	AAVG *	AAVG?	Integer	AG	
	AG *	AG?	Integer	AG	
: start	AGR	-	-	-	
: stop	AGS	-	-	-	
: pause	AGP	-	-	-	
: continue	AGC	-	-	-	
: 1 time	AG1	-	-	-	
: continue	AG0	-	-	-	
Normalize A ON	ANORM	-	-	-	
	AN	-	-	-	
	ANORM ON	-	-	-	
	AN ON	-	-	-	
	ANN	-	-	-	

Function	Listener code	Talker request			Remarks
		Code	Output format	Header	
Normalize A OFF	ANORM OFF	-	-	-	
	AN OFF	-	-	-	
	ANF	-	-	-	
Correction data save	AR	-	-	-	
Instant normalize A	AI	-	-	-	
	SHTA	-	-	-	
A XCH B	ACHB	-	-	-	
	CH	-	-	-	
A - B → A	ABA	-	-	-	
	TRO	-	-	-	
B - A → A	BAA	-	-	-	
	TR1	-	-	-	
A - DL → A	ADLA	-	-	-	
	TR2	-	-	-	
Trace A clear	CWA	-	-	-	
Trace B	TB	TB?	(Lower bytes) 0: write 1: view 2: blank 3: normalize 4: B - DL → B (Upper bytes) 0: nothing 1: + max hold 2: + averaging 3: + min hold		

R3265/3271
 SPECTRUM ANALYZER
 INSTRUCTION MANUAL

6.8 List of GPIB Codes

Function	Listener code	Talker request			Remarks
		Code	Output format	Header	
B write	BWRITE	-	-	-	
	BW	-	-	-	
B view	BVIEW	-	-	-	
	BV	-	-	-	
B blank	BBLANK	-	-	-	
	BB	-	-	-	
B max hold	BMAX	-	-	-	
	BM	-	-	-	
B min hold	BMIN	-	-	-	
B averaging	BAVG *	BANG?	Integer	BG	
	BG *	BG?	Integer	BG	
: start	BGR	-	-	-	
: stop	BGS	-	-	-	
: pause	BGP	-	-	-	
: continue	BGC	-	-	-	
: 1 time	BG1	-	-	-	
: continue	BG0	-	-	-	
Normalize B ON	BNORM	-	-	-	
	BN	-	-	-	
	BNORM ON	-	-	-	
	BN ON	-	-	-	
	BNN	-	-	-	
Normalize B OFF	BNORM OFF	-	-	-	
	BN OFF	-	-	-	
	BNF	-	-	-	

Function	Listener code	Talker request			Remarks
		Code	Output format	Header	
Correction data save	BR	-	-	-	
Instant normalize B	BI	-	-	-	
	SHTB	-	-	-	
B - DL → B	BDLB	-	-	-	
	TR3	-	-	-	
Trace B clear	CWB	-	-	-	
Local	LOCAL	-	-	-	
	LC	-	-	-	
GPIB address	-	AD?	Integer	AD	
	-	SHLC?	Integer	AD	
User definition	USER	-	-	-	
	UR	-	-	-	
: 1	UR1	-	-	-	
: 2	UR2	-	-	-	
: 3	UR3	-	-	-	
: 4	UR4	-	-	-	
: 5	UR5	-	-	-	
: 6	UR6	-	-	-	
: 7	UR7	-	-	-	
Recall	RECALL *	RECALL?	0: Normal recall	-	
	RC *	RC?	1: Fast recall	-	
Normal recall	RCNORM *	-	-	-	
	RN *	-	-	-	
Fast recall	RCFAST *	-	-	-	Only one digit
	RF	-	-	-	

Function	Listener code	Talker request			Remarks
		Code	Output format	Header	
Save	SAVE *	—	—	—	
	SV *	—	—	—	
	SHRC *	—	—	—	
Instrument preset	IP	—	—	—	
Marker ON	MKR ON *	MKR?	0: Marker OFF	—	
	MN *	MN?	1: Normal marker	—	
	MKN *	—	2: Δ marker	—	
Marker frequency?	—	MF?	Frequency	MF	
Marker level?	—	ML?	Level	Unit : Header	
				dB: MLD	
				dBm: MLB	
				dBmV: MLM	
				dB _μ V: MLU	
				dB _μ Vemf :MLE	
				dBpW: MLP	
				V:MLV	
				W: MLW	
				dBm/Hz: MLH	
				dB _μ V/ VHz:MLL	
				dBc/Hz :MLC	

Function	Listener code	Talker request			Remarks
		Code	Output format	Header	
frequency + Level?	—	MFL?	Frequency + Level	Same as MF, ML	
Normal marker	MKNORM *	MKNORM?	Frequency	MF	
	MKN *	—	—	—	
	MK *	MK?	Frequency	MF	
Δ marker	MKDLT *	MKDLT?	Frequency	MF	
	MKD *	—	—	—	
	MT *	MT?	Frequency	MF	
Fixed marker?	—	FIX?	OFF/ON	—	
		FX?	OFF/ON	—	
Fixed marker ON	FIX ON	—	—	—	
	FX ON	—	—	—	
	FXN	—	—	—	
Fixed marker OFF	FIX OFF	—	—	—	
	FX OFF	—	—	—	
	FXF	—	—	—	
1/ Δ marker	REDLT	REDLT?	OFF/ON + calculated value (Note)	MF	
1/ Δ marker ON	REDLT ON	—	—	—	
1/ Δ marker OFF	REDLT OFF	—	—	—	
Counter?	—	COUNT?	OFF/ON	—	
	—	CT?	OFF/ON	—	
	—	CN?	OFF/ON	—	
Counter ON	COUNT ON	—	—	—	
	CT ON	—	—	—	
	CN ON	—	—	—	

Note: The calculated value is used as time or frequency data.

R3265/3271
SPECTRUM ANALYZER
INSTRUCTION MANUAL

6.8 List of GPIB Codes

Function	Listener code	Talker request			Remarks
		Code	Output format	Header	
Resolution : 1 kHz	CN0	-	-	-	
: 100 Hz	CN1	-	-	-	
: 10 Hz	CN2	-	-	-	
: 1 Hz	CN3	-	-	-	
Counter OFF	COUNT OFF	-	-	-	
	CT OFF	-	-	-	
	CN OFF	-	-	-	
	CNF	-	-	-	
Counter operation mode?	-	CTMD?	FREQ counter: 0 MKR counter: 1		
MKR counter	CTMK	-	-	-	
FREQ counter	CTFR	-	-	-	
Signal track?	-	SIG?	OFF/ON	-	
	-	SG?	OFF/ON	-	
Signal track ON	SIG ON	-	-	-	
	SG ON	-	-	-	
	SGN	-	-	-	
Signal track OFF	SIG OFF	-	-	-	
	SG OFF	-	-	-	
	SGF	-	-	-	
Noise/Hz?	NOISE *	NOISE?	0: OFF + Frequency	NI	
	NI *	NI?	1: dBm + Frequency	NI	
			2: dB μ V + Frequency	NI	
			3: dBc + Frequency	NI	
dBm/Hz ON	NIDBM	-	-	-	
	NIM	-	-	-	

Function	Listener code	Talker request			Remarks
		Code	Output format	Header	
dB _μ V/V Hz ON	NIDBU	-	-	-	
	NIU	-	-	-	
dBc/Hz ON Noise/Hz OFF	NIDBC	-	-	-	
	NIC	-	-	-	
	NOISE OFF	-	-	-	
	NI OFF	-	-	-	
Fixed Mkr Peak	NIF	-	-	-	
	FXP	-	-	-	
	FXP	-	-	-	
X dB down	DBDOWN *	-	-	-	
	XDB *	-	-	-	
X dB down left	DBLEFT *	-	-	-	
	XDL *	-	-	-	
X dB down right	DBRIGHT *	-	-	-	
	XDR *	-	-	-	
X dB relative	DBREL	-	-	-	
	DCO	-	-	-	
X dB abs. left	DBABSL	-	-	-	
	DC1	-	-	-	
X dB abs. right	DBABSR	-	-	-	
	DC2	-	-	-	
X dB execution state	-	DC?	0: Relative 1: Absolute (Left) 2: Absolute (Right)	-	
Continuous dB down?	-	CDB?	OFF/ON	-	

R3265/3271
SPECTRUM ANALYZER
INSTRUCTION MANUAL

6.8 List of GPIB Codes

Function	Listener code	Talker request			Remarks
		Code	Output format	Header	
Continuous dB down ON	CDB ON	-	-	-	
Continuous dB down OFF	CDB OFF	-	-	-	
AUTO TUNE	TUNE *	TUNE?	Frequency	TN	
	TN *	TN?	Frequency	TN	
Pre-selection Auto peaking	PPA	-	-	-	
Manual peaking	PPM *	-	-	-	Knob alone
Marker display : Relative	MDR	-	-	-	
	:Absolute	MDA	-	-	
Marker position:Upper right	MDU	-	-	-	
	:Lower right	MDL	-	-	
Marker OFF	MKR OFF	-	-	-	
	MKOFF	-	-	-	
	MO	-	-	-	
	MF	-	-	-	
Multi marker ON	MLT	MLT?	ON/OFF	-	
Multi marker OFF	MF or MO	-	-	-	
Active marker shift	MN* or MK*	-	-	-	
Multi marker No.1 On	MLN1 *	-	-	-	
Multi marker No.1 OFF	MLF1	-	-	-	
Multi marker No.2 On	MLN2 *	-	-	-	
Multi marker No.2 OFF	MLF2	-	-	-	
Multi marker No.3 On	MLN3 *	-	-	-	
Multi marker No.3 OFF	MLF3	-	-	-	

Function	Listener code	Talker request			Remarks
		Code	Output format	Header	
Multi marker No.4 ON	MLN4 *	-	-	-	
Multi marker No.4 OFF	MLF4	-	-	-	
Multi marker No.5 ON	MLN5 *	-	-	-	
Multi marker No.5 OFF	MLF5	-	-	-	
Multi marker No.6 ON	MLN6 *	-	-	-	
Multi marker No.6 OFF	MLF6	-	-	-	
Multi marker No.7 ON	MLN7 *	-	-	-	
Multi marker No.7 OFF	MLF7	-	-	-	
Multi marker No.8 ON	MLN8 *	-	-	-	
Multi marker No.8 OFF	MLF8	-	-	-	
Active marker frequency?	-	MF?	Frequency	MF	
Active marker level?	-	ML?	Level	Unit : Header dB: MLD dBm: MLB dBmV: MLM dB μ V: MLU dB μ Vemf :MLE dBpW: MLP V:MLV W: MLW	

Function	Listener code	Talker request			Remarks
		Code	Output format	Header	
Frequency + Level?	—	MFL?	Frequency + Level	dBm/Hz: MLH dB μ V /√ Hz: MLL dBc/Hz :MLC Same as MF, ML	
Multi marker frequency?	—	MLSF?	Frequency	Same as MF	8 items + ΔMKR
Multi marker all level?	—	MLSL?	Level	Same as ML	8 items + ΔMKR
Peak search	PWAK	—	—	—	
	MKPK	—	—	—	
	MKPK HI	—	—	—	
	PS	—	—	—	
NEXT peak	NXPEAK	—	—	—	
	NKPK NH	—	—	—	
	NXP	—	—	—	
Next peak left	NXLEFT	—	—	—	
	NKPK NL	—	—	—	
	NXL	—	—	—	
Next peak right	NXRIGHT	—	—	—	
	NKPK NR	—	—	—	
	NXR	—	—	—	

Function	Listener code	Talker request			Remarks
		Code	Output format	Header	
NEXT peak MAX/MIN	NXMAXMIN	-	-	-	
	NMM	-	-	-	
MIN search	MIN	-	-	-	
	MIS	-	-	-	
NEXT MIN	NXMIN	-	-	-	
	NXM	-	-	-	
Continuous peak?	-	CP?	OFF/ON	-	
Continuous peak ON	CP ON	-	-	-	
	CPN	-	-	-	
Continuous peak OFF	CP OFF	-	-	-	
	CPF	-	-	-	
ΔX	DX *	DX?	Integer (1 to 700)	DX	
ΔY	DY *	DY?	Integer (1 to 400)	DY	
Peak range	-	-	-	-	
:Normal	PSN	-	-	-	
:Upper	PSU	-	-	-	
:Lower	PSL	-	-	-	
Peak list	-	PLS?	OFF/ON	-	
Peak list ON	PLS ON	-	-	-	
Peak list OFF	PLS OFF	-	-	-	
MKR →	MG	-	-	-	
MKR → CF	MKCF	-	-	-	
	MC	-	-	-	

Function	Listener code	Talker request			Remarks
		Code	Output format	Header	
MKR → REF	MKRL	-	-	-	
	MR	-	-	-	
ΔMKR → SPAN	MTSP	-	-	-	
	DS	-	-	-	
MKR → CF step	MKCS	-	-	-	
	MO	-	-	-	
ΔMKR → CF step	MTCS	-	-	-	
	M1	-	-	-	
ΔMKR → CF	MTCF	-	-	-	
MKR → MKR step	MKMKS	-	-	-	
	M2	-	-	-	
ΔMKR → MKR step	MTMKS	-	-	-	
	M3	-	-	-	
MKR step size	MKS *	MKS?	Frequency	MKS	
	MPM *	MPM?	Frequency	MKS	
MKR step AUTO	MKSAUTO	MKSAUTO?	AUTO/MANUAL	-	
	MPA	MPA?	AUTO/MANUAL	-	
Measurement window	WD0	WD0?	OFF/ON	-	
	SH0	SH0?	OFF/ON	-	
	-	WN?	OFF/ON	-	
Window ON	WDO ON	-	-	-	
	WN	-	-	-	
Window OFF	WDO OFF	-	-	-	
	WF	-	-	-	

Function	Listener code	Talker request			Remarks
		Code	Output format	Header	
Center position : X	—	WDOLX?	Integer(0 to 700)	WLX	
	—	WLX?	Integer(0 to 700)	WLX	
Center position : Y	—	WDOLY?	Integer(0 to 400)	WLY	
	—	WLY?	Integer(0 to 400)	WLY	
Window width	—	WDODX?	Integer(0 to 700)	WDX	
	—	WDX?	Integer(0 to 700)	WDX	
Window height	—	WDODY?	Integer(0 to 400)	WDY	
	—	WDY?	Integer(0 to 400)	WDY	
Start frequency	WDOSRT *	WDOSRT?	Frequency	WTF	
	WTF *	WTF?	Frequency	WTF	
Stop frequency	WDOSTP *	WDOSTP?	Frequency	WPF	
	WPF *	WPF?	Frequency	WPF	
Upper limit level	WDOUP *	WDOUP?	Level	WUL	
	WUL *	WUL?	Level	WUL	
Lower limit level	WDOLOW *	WDOLOW?	Level	WLL	
	WLL *	WLL?	Level	WLL	
GO/NG decision	—	CM?	NG:0	—	
			OK:1		
GO/NG decision A execution	CMA	—	—	—	
GO/NG decision B execution	CMB	—	—	—	
EMC	EMC	—	—	—	
	SH1	—	—	—	
Antenna type?	—	ANT?	0: OFF 1: Dipole 2: Log peri 3: TR17203	—	

Function	Listener code	Talker request			Remarks
		Code	Output format	Header	
Antenna select :Dipole :Log peri :TR17203	ANT0	-	-	-	
	AN0	-	-	-	
	ANT1	-	-	-	
	AN1	-	-	-	
	ANT2	-	-	-	
	AN2	-	-	-	
Antenna OFF	ANT OFF	-	-	-	
	AF	-	-	-	
Antenna correction table?	-	ANCORR?	OFF/ON	-	
	-	CR?	OFF/ON	-	
Antenna correction table ON	ANCORR ON	-	-	-	
	CR ON	-	-	-	
	CRN	-	-	-	
Antenna correction table OFF	ANCORR OFF	-	-	-	
	CR OFF	-	-	-	
	CRF	-	-	-	
	CRIN *	-	-	-	
Antenna correction table entry	CRDEL	-	-	-	
Antenna correction table delete					
Level correction?	-	LVCORR?	OFF/ON	-	
Level correction ON	LVCORR ON	-	-	-	
Level correction OFF	LVCORR OFF	-	-	-	
QP	-	QP?	OFF/ON	-	
QP ON	QP ON	-	-	-	
	QN	-	-	-	
QP OFF	QP OFF	-	-	-	
	QF	-	-	-	

Function	Listener code	Talker request			Remarks
		Code	Output format	Header	
QP BW AUTO	QPAUTO	QPAUTO?	0:AUTO	-	
	QA	QA?	1:200Hz	-	
		-	2:9 kHz	-	
		-	3:120 kHz	-	
		-	4:1 MHz	-	
QP BW :200 Hz	QP0	-	-	-	
:9 kHz	QP1	-	-	-	
:120 kHz	QP2	-	-	-	
:1 MHz	QP3	-	-	-	
Limit line 1?	-	LMTA?	OFF/ON	-	
Limit line 1 ON	LMTA ON	-	-	-	
	LAN	-	-	-	
Limit line 1 OFF	LMTA OFF	-	-	-	
	LAF	-	-	-	
Limit line 1 table entry	LMTAIN *	-	-	-	
Limit line 1 table delete	LMTADEL	-	-	-	
Limit line 2?	-	LMTB?	OFF/ON	-	
Limit line 2 ON	LMTB ON	-	-	-	
	LBN	-	-	-	
Limit line 2 OFF	LMTB OFF	-	-	-	
	LBF	-	-	-	
Limit line 2 table entry	LMTBIN *	-	-	-	
Limit line 2 table delete	LMTBDEL	-	-	-	
Calibration	CAL	-	-	-	
	SH7	-	-	-	
CAL ALL	CLALL	-	-	-	
	CLA	-	-	-	

Function	Listener code	Talker request			Remarks
		Code	Output format	Header	
total gain cal.	CLTOTAL	-	-	-	
	CLG	-	-	-	
input ATT cal.	CLATT	-	-	-	
	IT0	-	-	-	
IF step AMP cal.	CLSTEP	-	-	-	
	IT1	-	-	-	
RBW switch cal.	CLRBW	-	-	-	
	IT2	-	-	-	
Log linearity cal.	CLLOG	-	-	-	
	IT3	-	-	-	
AMPTD MAG cal.	CLMAG	-	-	-	
	IT4	-	-	-	
PBW cal.	CLPBW	-	-	-	
	IT6	-	-	-	
Calibration level	CL *	CL?	Level	Unit : Header dBm: CLB dBmV: CLM dB μ V: CLE dB μ Vemt: CLE dBpW: CLP V:CLV W:CLW	
Calivration REF	CLN *	-	-	-	Knob alone
	CLREF *	-	-	-	

Function	Listener code	Talker request			Remarks
		Code	Output format	Header	
f characteristics correction?	—	FRCORR?	OFF/ON	—	
	—	FC?	OFF/ON	—	
f characteristics correction ON	FRCORR ON	—	—	—	
	FC ON	—	—	—	
	FCN	—	—	—	
f characteristics correction OFF	FCCORR OFF	—	—	—	
	FC OFF	—	—	—	
	FCF	—	—	—	
CAL correction?	—	CLCORR?	OFF/ON	—	
	—	CC?	OFF/ON	—	
CAL correction ON	CLCORR ON	—	—	—	
	CC ON	—	—	—	
	CCN	—	—	—	
CAL correction OFF	CLCORR OFF	—	—	—	
	CC OFF	—	—	—	
	CCF	—	—	—	
Plotter	SH8	—	—	—	
Type :R9833	PLTYPEA	—	—	—	
:HP7470	PLTYPEB	—	—	—	
:HP7475	PLTYPEC	—	—	—	
:HP7440	PLTYPED	—	—	—	
:HP7550	PLTYPEE	—	—	—	
Data :All information	PLALL	—	—	—	
:Waveform alone	PLTRACE	—	—	—	
:Characters alone	PLCHAR	—	—	—	
:Grid alone	PLGRAT	—	—	—	
:Marker, DL,WDO	PLMKR	—	—	—	

Function	Listener code	Talker request			Remarks
		Code	Output format	Header	
:Multimarker List	PLMULTI	-	-	-	
:Antenna table	PLANT	-	-	-	
:Limit 1 table	PLLMTA	-	-	-	
:Limit 2 table	PLLMTB	-	-	-	
:Loss table	PLLOSS	-	-	-	
Paper :A4	PLA4	-	-	-	
:A3	PLA3	-	-	-	
Division size :Single	PLPIC1	-	-	-	
:Division into 2	PLPIC2	-	-	-	
:Division into 4	PLPIC4	-	-	-	
Print position :Center	PLMID	-	-	-	
:Left	PLLEFT	-	-	-	
:Right	PLRIGHT	-	-	-	
:Upper left	PLUPLEFT	-	-	-	
:Upper right	PLUPRIGHT	-	-	-	
:Lower left	PLLOWLEFT	-	-	-	
:Lower right	PLLOWRIGHT	-	-	-	
The number of pens:1 pen	PLPEN1	-	-	-	
:2 pens	PLPEN2	-	-	-	
:4 pens	PLPEN4	-	-	-	
:6 pens	PLPEN6	-	-	-	
:8 pens	PLPEN8	-	-	-	
Print position shift:AUTO	PLAUTO	-	-	-	
:Manual	PLMAN	-	-	-	
Execution	PLOT	-	-	-	
	PLT	-	-	-	

R3265/3271
SPECTRUM ANALYZER
INSTRUCTION MANUAL

6.8 List of GPIB Code.

Function	Listener code	Talker request			Remarks
		Code	Output format	Header	
Utility	SH3	--	--	--	
OBW	OBW *	OBW?	Percentage + Calculated value	OBW, MF	(Note)
ADJ	ADJ	ADH?	Calculated value	Same as ML	(Note)
ADK GRAPH	ADG	--	--	--	
ADJ GRAPH OFF	ADG OFF	--	--	--	
ADJ Ch Space	ADCH *	ADCH?	Frequency	ADC	
ADJ Specified BW	ADBS *	ADBS?	Frequency	ADB	
Memory card	CARD	--	--	--	
	SH4	--	--	--	
Card initialization	MCINIT	--	--	--	
	MMI	--	--	--	
Soft menu read-in	MCLOAD	--	--	--	
	MML	--	--	--	
Soft menu write-in	MCSTORE	--	--	--	
	MMS	--	--	--	
Label	--	LB?	OFF/ON + Character string	--	Up to 30 characters
	--	SH9?	OFF/ON + Character string	--	
Label ON	LB ON/**/	--	--	--	Enclose the characters with / to be entered.
	LON/**/	--	--	--	
Label delete	LB OFF	--	--	--	
	LOF	--	--	--	

Note: The two calculation results are output continuously.

IF OBW: Frequency + Frequency

If ADJ: Level + Level

R3265/3271
 SPECTRUM ANALYZER
 INSTRUCTION MANUAL

6.8 List of GPIB Codes

Function	Listener code	Talker request			Remarks
		Code	Output format	Header	
Softkey		--	--	--	
Softkey No.1	SF1	--	--	--	
Softkey No.2	SF2	--	--	--	
Softkey No.3	SF3	--	--	--	
Softkey No.4	SF4	--	--	--	
Softkey No.5	SF5	--	--	--	
Softkey No.6	SF6	--	--	--	
Softkey No.7	SF7	--	--	--	
Data entry					
0 to 9	0 to 9	--	--	--	
. (decimal point)	.	--	--	--	
BK SP	BS	--	--	--	
↑ (step up)	UP	--	--	--	
↓ (step down)	DN	--	--	--	
Knob up (coarse)	CU	--	--	--	
(fine)	FU	--	--	--	
Knob down (coarse)	CD	--	--	--	
(fine)	FD	--	--	--	
GHx	GZ	--	--	--	
MHz	MZ	--	--	--	
kHz	KZ	--	--	--	
Hz	HZ	--	--	--	
mV	MV	--	--	--	
mW	MW	--	--	--	
dB	DB	--	--	--	

Function	Listener code	Talker request			Remarks
		Code	Output format	Header	
second	SC	-	-	-	
mili second	MS	-	-	-	
micro (μ) second	US	-	-	-	
ENTER	ENT	-	-	-	
Trace data input/output		TP?	0: 0 to 400 mode 1: 448 to 3648 mode		
Accuracy : 401 points	TPC	-	-	-	
:3201 points	TPF	-	-	-	
Memory A output (ASCII)	-	TAA?	4 bytes + Delimiter	-	1-point data
(Binary)	-	TBA?	2bytes x 700 points	-	EOI signal
Memory B output (ASCII)	-	TAB?	4 bytes + Delimiter	-	1-point data
(Binary)	-	TBB?	2bytes x 700 points	-	EOI signi
Memory A input (ASCII)	TAA	-	-	-	1-point data
(Binary)	TBA	-	-	-	EOI signal
Memory B input (ASCII)	TAB	-	-	-	1-point data
(Binary)	TBB	-	-	-	EOI signal

R3265/3271
SPECTRUM ANALYZER
INSTRUCTION MANUAL

6.8 List of GPIB Codes

Function	Listener code	Talker request			Remarks
		Code	Output format	Header	
Others					
Header OFF	HD0	-	-	-	
Header ON	DD1	-	-	-	☆
Delimiter					
:CR LF (EOI)	DL0	-	-	-	
:LF	DL1	-	-	-	
:(EOI)	DL2	-	-	-	
:CR LF	DL3	-	-	-	☆
:LF (EOI)	DL4	-	-	-	
Service request					
:Interrupt ON	S0	-	-	-	
:Interrupt OFF	S1	-	-	-	☆
:Status clear	S2	-	-	-	
Soft menu display?	-	MND?	OFF/ON		
Soft menu display ON	MND ON	-	-	-	
Soft menu display OFF	MND OFF	-	-	-	
Device type?	-	VER?	0:R3265 1:R3271	-	
Device type? (Character string)	-	TYPE?	Character string + Delimiter	-	
	-	TYP?	Character string + Delimiter	-	
Revision output	-	REV?	Character string + Delimiter	-	
Screen data output	-	GPL?	64 characters x 24 lines	-	

Table 6-4 List of Typical Functions for Data Entry (GPIB codes with asterisk)

Command example	Description
CF100MZ	Center frequency is set to 100MHz.
CS100KZ	Frequency step size is set to 100kHz.
FON10MZ	Frequency offset is turned ON and set to 10MHz.
SP500MZ or LS500MZ	Frequency span is set to 500MHz.
LGA100MZ	Log start frequency is set to 100MHz.
LGB1000MZ	Log stop frequency is set to 1GHz.
FA100KZ or FT100KZ	Start frequency is set to 100kHz.
FB400KZ or FP400KZ	Stop frequencies is set to 400kHz.
RE-25DB or RL-25DB	Reference level is set to -25dBm (if unit is set to dBm).
DD5DB	5dB/div is set.
RON30DB	Level offset is turned ON and set to 30dB.
RB300KZ	RBW is set to 300kHz.
VB100KZ	VBW is set to 100kHz.
SW200MS	Sweep time is set to 200msec.
AT20DB	Attenuator is set to 20dB.
PUN100MS	Marker pause is turned ON and the time is set to 100msec.
DLN87DB	Display line is turned ON and set to 87dB μ V (if unit is set to μ dB V).
MK1.8GZ	Normal marker is turned ON and set to 1.8GHz.
MT2MZ	Delta marker is turned ON and Normal marker is set at 2MHz apart from it.
MN100KZ	100kHz is set for the active marker(s).
NOISE50Hz	Noise power noise width is set to 50Hz.
XDB6DB	XdB down width is set to 6dB. (This can be also set by XDL, XDR commands.)
DX10GZ	Increment X point of the Next peak search is set to 10. (GZ is entry.)
DY50GZ	Increment Y point of the Next peak search is set to 50. (GZ is entry.)
MPM100KZ	Marker step size is set to 100kHz.
AG 200GZ	Average A is set to 200 times and executed. (GZ is entry.)
BG 300GZ	Average B is set to 300 times and executed. (GZ is entry.)
AD8GZ	The analyzer GPIB address is set to 8. (GZ is entry.)

Command example	Description
WTF1MZ	Window start frequency is set to 1MHz.
WPF2MZ	Window stop frequency is set to 2MHz.
WUL-20DB	Window upper level is set to -20dBm (if unit is set to dBm).
WLL-40DB	Window lower level is set to -40dBm (if unit is set to dBm).
CLN-25DB	CAL level is set to -25dBm (if unit is set to dBm).
SV5GZ SF1	Channel 5 save is executed. (SF1 represents softkey No.1.)
RC5GZ SF1/RF5	Channel 5 recall is executed. (Normal/Fast mode)

7. INSPECTION

Read this chapter if any trouble has occurred.

Table of Contents

7.1 Inspection and Brief Diagnosis	7-2
--	-----

7. INSPECTION

7.1 Inspection and Brief Diagnosis

If any trouble has occurred, read through the table below for check before requesting repair. If the trouble persists in spite of the procedures prescribed in the table, contact ATCE or the nearest dealer or the sales and support offices. The addresses and telephone numbers are listed at the end of this manual. The user will be charged for any repairing done by our engineers, even for the procedures prescribed in the table.

Condition	Possible Cause	Prescription
The system cannot be powered up.	The power cable is not properly inserted in the connector.	Turn the power off and connect the power cable properly.
	The power fuse is blown.	Replace the power fuse. (See paragraph 1.2.4-(2).)
The sweep LED lamp is lit but no waveform is displayed on the screen.	The intensity volume is set too low.	Adjust the intensity by turning the volume knob.
	The input cable or the connector is not properly connected.	Connect the input cable and connector properly.
Sweeping cannot be carried out.	The trigger is set to Single mode.	Press the menu key and select FREE RUN.
	The LED lamp corresponding to key A or B is not lit.	Press the key A or B of TRACE and select WRITE.
The signal level is inaccurate.	The AMPTD CAL has not been adjusted.	Perform calibration.
The keys do not function.	The system is set to the GPIB remote control mode.	If a program is being executed, halt it and press the LCL key.

8. OPERATION DESCRIPTION

The basic operations of R3265/3271 will be explained on block basis.

Table of Contents

8.1 Operations on Block Basis	8-2
8.2 Block Diagram	8-4

8. OPERATION DESCRIPTION

8.1 Operations on Block Basis

The R3265/R3271 is used to convert the input signal of 100Hz to 8GHz (R3265) and 100Hz to 26.5GHz (R3271) into 21.4MHz IF signal. After the resolution is determined using the 21.4 MHz IF filter with variable resolution bandwidth, detection is carried out by the detector and spectrum is displayed on the screen.

(1) Frequency conversion

Operation from 100Hz to 3.6GHz

Within the tuning range of 100Hz to 3.6GHz, the signal entered is fed through the input attenuator (0 to 70dB; 10dB steps) into the first mixer.

The signal which has been fed to the first mixer is mixed with the partial oscillation signal which has been synthesized by the YIG tuning oscillator of 4.2Hz to 7.8GHz and is converted into the first IF signal of 4231.4MHz. The first IF signal is fed through the low noise amplifier (LNA), then to the band pass filter (B.P.F.) to eliminate unnecessary signal which has been generated by the first mixer and the image generated by the second mixer.

Note: No LNA is mounted in the R3271.

The signal which has been fed through the band pass filter is introduced into the second mixer and is mixed with the 3810MHz phase-locked second partial oscillator before being converted into the second IF signal of 421.4MHz.

Operation of 3.5GHz or above

In the tuning range of 3.5GHz or above, the signal passed through the input attenuator is fed to the tracking filter (YIG tuning filter) which operates synchronized with the spectrum analyzer tuning frequency, in order to eliminate image and multiple response from the signal before the signal being fed to the first mixer.

The signal fed to the first mixer is mixed with the synthesized partial oscillation signal of 3.9GHz to 8GHz and is converted into the 421.4MHz IF signal

The signal which has been converted into 421.4MHz is fed through the band pass filter to eliminate the image generated by the third mixer, mixed with the third partial oscillation signal of 400MHz in the third mixer, and is converted into the IF signal of 21.4MHz.

The third partial oscillation signal of 400MHz is generated by doubling the X'tl oscillator of 200MHz which is phase-locked by the 10MHz reference oscillator.

(2) IF section

The input signal which has been converted into 21.4MHz in the frequency conversion section is fed to the IF filter to determine the resolution bandwidth of 10Hz to 3MHz.

The resolution bandwidth filter of 300kHz to 3MHz consists of four stages of 21.4MHz LC filter. For the range from 100kHz to 10Hz, the 21.4MHz is converted into frequency of 3.58MHz and fed through the next IF filter. The IF filter of 1kHz to 10Hz consists of four stages of crystal oscillators.

After passing this 3.58MHz filter, the signal is converted again into the frequency of 21.4MHz.

The IF section contains a step amplifier (0.1dB step) to determine the reference level.

(3) LOG A/D section

The signal, after its resolution bandwidth is determined in the IF, is fed through the logarithm amplifier (LOG amplifier) which has 100dB dynamic range if the level is indicated in decibel. If the level is in linear indication, the signal is passed through the linear amplifier before being fed to the detector (DEC). After detection, the signal is converted into digital signal by the A/D converter. The digital signal is controlled at the display portion and displayed on the CRT.

8.2 Block Diagram

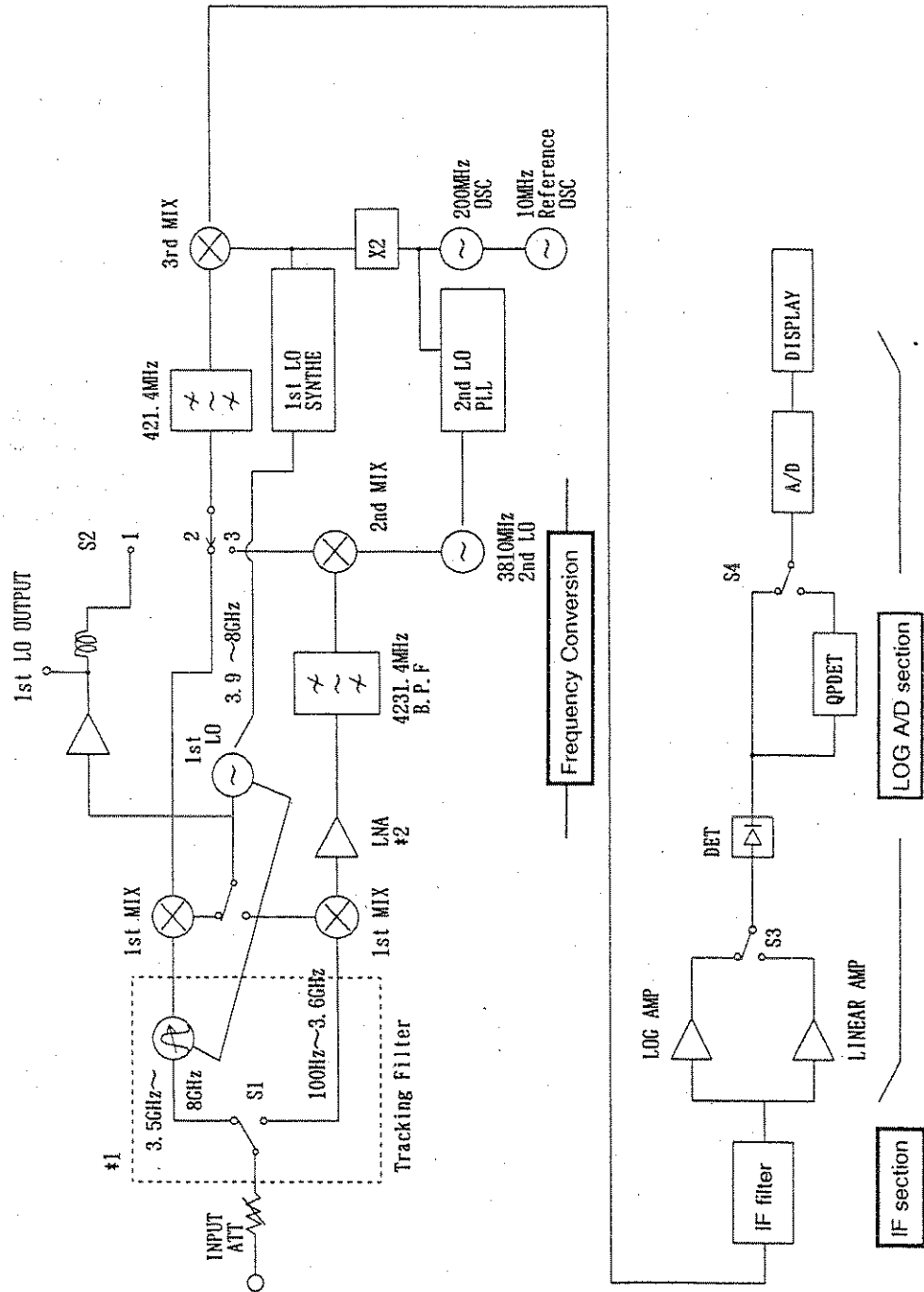

Note 1: The R3271 range is 3.5GHz to 26.5.GHz.
Note 2: The low noise IF amplifier (LNA) is not used in the R3271.

9. SPECIFICATIONS

This chapter describes the R3265 and R3271 specifications and accessories.

Table of Contents

9.1 R3265 Specifications	9-2
9.2 R3271 Specifications	9-9

9.1 R3265 Specifications

(1) Frequency

● Frequency range	100Hz to 8GHz Frequency band 100Hz to 3.6GHz 3.5GHz to 7.5GHz 7.4GHz to 8GHz	Higher harmonics degree 1 1 1															
● Frequency read accuracy (Start, Stop, Center frequency, Marker frequency)	\pm (Frequency reading \times Frequency reference accuracy + Span \times Span accuracy + 0.15 \times Resolution bandwidth + 10Hz) Span accuracy (Span > 2MHz) \pm 3% (Span \leq 2MHz) \pm 5%																
● Marker frequency counter Resolution Accuracy (S/N \geq 25dB) Delta counter accuracy	1Hz to 1kHz \pm (Marker frequency \times Frequency reference accuracy + 5Hz + 1LSD) \pm (Δ frequency \times Frequency reference accuracy + 10Hz + 2LSD)																
● Frequency reference accuracy	$\pm 2 \times 10^{-8}$ /Day $\pm 1 \times 10^{-8}$ /Year																
● Frequency stability Residual FM (Zero span) Drift (After 1 hour warm-up)	$< 3\text{Hz}_{\text{p-p}} / 0.1\text{sec}$ $50\text{kHz} < \text{Span} \leq 2\text{MHz}$, $< 2.5\text{kHz} \times \text{Sweep speed (min.)} \times N$ $\text{Span} \leq 50\text{kHz}$, $< 60\text{Hz} \times \text{Sweep speed (min.)} \times N$																
● Signal purity noise side band	<table border="1"> <thead> <tr> <th>Offset</th> <th>f $\leq 2.6\text{GHz}$</th> <th>f $> 2.6\text{GHz}$</th> </tr> </thead> <tbody> <tr> <td>1kHz</td> <td>$< -100\text{dBc/Hz}$</td> <td>$< -95\text{dBc/Hz}$</td> </tr> <tr> <td>10kHz</td> <td>$< -110\text{dBc/Hz}$</td> <td>$< -108\text{dBc/Hz}$</td> </tr> <tr> <td>20kHz</td> <td>$< -110\text{dBc/Hz}$</td> <td>$< -108\text{dBc/Hz}$</td> </tr> <tr> <td>100kHz</td> <td>$< -114\text{dBc/Hz}$</td> <td>$< -110\text{dBc/Hz}$</td> </tr> </tbody> </table>		Offset	f $\leq 2.6\text{GHz}$	f $> 2.6\text{GHz}$	1kHz	$< -100\text{dBc/Hz}$	$< -95\text{dBc/Hz}$	10kHz	$< -110\text{dBc/Hz}$	$< -108\text{dBc/Hz}$	20kHz	$< -110\text{dBc/Hz}$	$< -108\text{dBc/Hz}$	100kHz	$< -114\text{dBc/Hz}$	$< -110\text{dBc/Hz}$
Offset	f $\leq 2.6\text{GHz}$	f $> 2.6\text{GHz}$															
1kHz	$< -100\text{dBc/Hz}$	$< -95\text{dBc/Hz}$															
10kHz	$< -110\text{dBc/Hz}$	$< -108\text{dBc/Hz}$															
20kHz	$< -110\text{dBc/Hz}$	$< -108\text{dBc/Hz}$															
100kHz	$< -114\text{dBc/Hz}$	$< -110\text{dBc/Hz}$															

● Frequency span	Linear span	Range Accuracy	200Hz to 8GHz, Zero span ±3% (Span > 2MHz), ±5% (Span ≤ 2MHz)
	Logarithmic span	Range Accuracy	1KHz to 1GHz (1, 2, 3 decade can be selected) ±(10% + Stop frequency × 0.1%)
● Resolution bandwidth (-3dB)		Range Accuracy	10Hz to 3MHz, 1, 3, 10 sequence ±50% (Resolution bandwidth 10 to 100Hz, Digital IF) ±15% (Resolution bandwidth 100Hz to 1MHz) ±25% (Resolution bandwidth 3MHz, 30Hz) 30Hz at 25°C ±10°C
		Selectivity Bandwidth (6dB)	< 15:1 (100Hz to 3MHz) < 20:1 (30Hz) 5:1 (10 to 100Hz, Digital IF) Nominal 200Hz, 9kHz, 120kHz (based on the CISPR specification)
● Video bandwidth		Range	1Hz to 3MHz, 1, 3, 10 sequence

(2) Amplitude range

● Measurement range	+30dBm to the average indication noise level
● Maximum safe input Average continuous power (Input ATT ≥ 10dB) DC input	±30dBm (1W) 0 [V]
● Display range	10 × 10 div.
Logarithmic Linear QP logarithm	10, 5, 2, 1, 0.5, 0.2, 0.1 dB/div. 10%/div. of the reference level 40dB (5dB/div.)
● Reference level range Logarithmic Linear	-140dBm to +60dBm (0.1dB step) 2.2 μV to 223V (approx. 1% step of the full scale)
● Input attenuator range	0 to 70dB (10dB step)

(3) Dynamic range

<ul style="list-style-type: none"> ● Maximum dynamic range 1dB gain compression level Noise level Input frequency Distortion characteristics Higher harmonics 100MHz to 3.6GHz 10MHz to 3.6GHz 10MHz > 3.5GHz Tertiary intermodulation > 200MHz > 10MHz 	<p>100MHz to 3.6GHz : 135dB - 1.55 × f(GHz)dB 10MHz to 3.6GHz : 130dB - 1.55 × f(GHz)dB</p> <p>87d 82.5dB 112dB</p> <p>93dB 90dB</p>
<ul style="list-style-type: none"> ● Average display noise level (Resolution bandwidth 10Hz (Digital IF), Input attenuator 0dB, Average 20 times) Frequency range 1kHz 10kHz 100kHz 1MHz to 3.6GHz 3.5GHz to 8GHz 	<p>-100dBm -110dBm -111dBm -{140 - 1.55 × f (GHz)}dBm -{145 - 1.55 × f (GHz)}dBm (Low noise mode) -135dBm</p>
<ul style="list-style-type: none"> ● 1dB gain compression > 200MHz > 10MHz 	<p>-5dBm (Mixer input level) -10dBm (Mixer input level)</p>
<ul style="list-style-type: none"> ● Spurious response Secondary higher harmonics distortion Frequency range 100MHz to 3.6GHz 10MHz to 3.6GHz 10MHz > 3.5GHz Tertiary higher harmonics distortion Frequency range 200MHz to 3.6GHz 10MHz to 3.6GHz 10MHz > 3.5GHz Image/Multiple/Band external response 10MHz to 8GHz 	<p>Mixer level</p> <p>-30dBm < -70dBc -30dBm < -60dBc -10dBm < -100dBc</p> <p>Mixer level</p> <p>-30dBm < -70dBc -30dBm < -60dBc -30dBm < -75dBc</p> <p>< -70dBc</p>

Residual response (No input signal, Input ATT 0dB, 50Ω terminate) 1MHz to 3.6GHz 300kHz to 8GHz	< -100dBm < -90dBm
---	-----------------------

(4) Amplitude accuracy

<ul style="list-style-type: none"> ● Frequency response Flatness within the band (Input ATT 10dB) 100Hz to 3.6GHz ± 1.5dB 50MHz to 2.6GHz ± 1.0dB 3.5GHz to 7.5GHz ± 1.5dB 7.4GHz to 8GHz ± 1.5dB Additional error due to band switching < +0.5dB Calibration signal as the reference (Input ATT 10dB) ± 3dB (100Hz to 8GHz) 	
<ul style="list-style-type: none"> ● Calibration signal accuracy 	-10dBm ± 0.3dBm
<ul style="list-style-type: none"> ● IF gain error (After self calibration) 0dBm to -50dBm ± 0.3dB 0dBm to -80dBm ± 0.7dB ● Scale indication accuracy (After self calibration) Logarithmic ± 0.2dB/1dB ± 1dB/10dB ± 1.5dB/90dB Linear QP mode logarithmic ± 5% of reference level ± 1.0dB/30dB, ± 2dB/40dB ± 1.0dB/40dB (25°C ± 10°C) 	
<ul style="list-style-type: none"> ● Error due to input attenuator switching (10dB as the reference; at 20 to 70dB) Frequency range 0 to 8GHz 	± 1.1dB/10dB step, Maximum 2.0dB
<ul style="list-style-type: none"> ● Error due to resolution bandwidth switching (Resolution bandwidth: 300kHz, reference; After self calibration) 	100Hz to 3MHz; ± 0.3dB 30Hz ± 1dB 10Hz to 100Hz (digital IF) ± 15dB

<ul style="list-style-type: none"> ● Pulse quantization error (In pulse measurement mode, PRF > 700/Sweep time) Peak to peak Logarithmic Linear 	1.2dB (Resolution bandwidth ≤ 1MHz) 3dB (Resolution bandwidth = 3MHz) 4% of the reference level (Resolution bandwidth ≤ 1MHz) 12% of the reference level (Resolution bandwidth = 3MHz)
---	---

(5) Sweep

<ul style="list-style-type: none"> ● Sweep time Zero span Span ≥ 200Hz Accuracy 	50μs to 1000s, Manual sweep 20ms to 1000s, Manual sweep ± 3%
<ul style="list-style-type: none"> ● Trigger 	Free run, Line, Single, Video, TV-H, TV-V, External

(6) Demodulation

<ul style="list-style-type: none"> ● Spectrum demodulation Modulation type Audio output Demodulation duration 	AM, FM Internal speaker, Earphone jack, Sound volume adjustable 100ms to 1000s
---	--

(7) Input/Output

<ul style="list-style-type: none"> ● RF input Connector Impedance VSWR (Frequency setting input ATT ≥ 10dB) LO radiation (Average) Frequency setting 0 to 8GHz 	N-type female 50Ω(Nominal) < 1.5 : 1 (≤ 3.6GHz) (Nominal) < 2.0 : 1 (> 3.6GHz) (Nominal) < -80dBm Typ, Input ATT 10dB
<ul style="list-style-type: none"> ● First LO output Connector Impedance Frequency range Amplitude 	SMA female, Front panel 50Ω(Nominal) 3.921 to 7.921GHz ± 5dBm or above

<ul style="list-style-type: none"> ● Calibration signal output <ul style="list-style-type: none"> Connector Frequency Impedance Amplitude 	BNC female, Front panel 25MHz × (1 ± Frequency reference accuracy) 50Ω (Nominal) -10dBm ± 0.3dB									
<ul style="list-style-type: none"> ● 10MHz frequency reference input/output <ul style="list-style-type: none"> Connector Impedance Frequency range Amplitude Input range 	BNC female, Rear panel 50Ω (Nominal) 10MHz × Frequency reference accuracy 0dBm ± 3dB -5dBm to +5dBm									
<ul style="list-style-type: none"> ● 21.4MHz IF output <ul style="list-style-type: none"> Connector Impedance Amplitude 3dB bandwidth 	BNC female, Rear panel 50Ω (Nominal) 0dBm (Typ) in full scale = Resolution bandwidth									
<ul style="list-style-type: none"> ● 421MHz IF output <ul style="list-style-type: none"> Connector Impedance Gain, Noise factor, 3dB bandwidth Frequency range 1MHz to 3.6GHz 3.5GHz to 8GHz 	BNC female, Rear panel 50Ω (Nominal) <table border="1" data-bbox="857 909 1404 1071" style="margin-left: auto; margin-right: auto;"> <thead> <tr> <th>3dB bandwidth (Nominal)</th> <th>Noise factor (Nominal)</th> <th>Gain (Nominal)</th> </tr> </thead> <tbody> <tr> <td>> 15MHz</td> <td>17dB</td> <td>+ 6dB</td> </tr> <tr> <td>> 30MHz</td> <td>24dB</td> <td>- 9dB</td> </tr> </tbody> </table>	3dB bandwidth (Nominal)	Noise factor (Nominal)	Gain (Nominal)	> 15MHz	17dB	+ 6dB	> 30MHz	24dB	- 9dB
3dB bandwidth (Nominal)	Noise factor (Nominal)	Gain (Nominal)								
> 15MHz	17dB	+ 6dB								
> 30MHz	24dB	- 9dB								
<ul style="list-style-type: none"> ● Video output <ul style="list-style-type: none"> Connector Impedance (AC connection) Amplitude (75Ω terminate) 	BNC female, Rear panel 75Ω (Nominal) Approx. 1V _{P-P} (Composite video signal)									
<ul style="list-style-type: none"> ● X axis, 2V/nGHz output <ul style="list-style-type: none"> Connector Impedance X axis output 2V/nGHz ● Y axis output <ul style="list-style-type: none"> Connector Impedance Amplitude 	BNC female, Rear panel 1kΩ (Nominal), DC connection approx. -5V to +5V approx. 2V per 1GHz BNC female, Rear panel 220Ω (Nominal) approx. 2V in full scale									

<ul style="list-style-type: none"> ● Z axis output <ul style="list-style-type: none"> Connector Amplitude During sweep Retrace interval 	BNC female, Rear panel TTL level High level Low level
<ul style="list-style-type: none"> ● External trigger input <ul style="list-style-type: none"> Connector Impedance Trigger level 	BNC female, Rear panel 10k Ω (Nominal), DC connection TTL level
<ul style="list-style-type: none"> ● Gate input <ul style="list-style-type: none"> Connector Impedance Sweep stop Sweep 	BNC female, Rear panel 10k Ω (Nominal) During low mode at TTL level During high mode at TTL level
<ul style="list-style-type: none"> ● Probe power <ul style="list-style-type: none"> Voltage Current 	4-pin connector, Front panel + 15V, - 15V 150mA each
<ul style="list-style-type: none"> ● Voice output (Modulation audio) <ul style="list-style-type: none"> Connector Power output 	Small-size monophonic jack, Front panel Maximum 0.2W, 8 Ω (Nominal)
<ul style="list-style-type: none"> ● GPIB Plotter 	IEEE-488 bus connector R9833, HP7470A, HP7475A, HP7440A, HP7550A

(8) General specifications

<ul style="list-style-type: none"> ● Temperature and humidity <ul style="list-style-type: none"> During operation When stored Humidity 	0°C to 50°C - 20°C to 60°C RH 85% or below
<ul style="list-style-type: none"> ● Power source <ul style="list-style-type: none"> During 100VAC operation <ul style="list-style-type: none"> Voltage Power consumption Frequency During 220VAC operation <ul style="list-style-type: none"> Voltage Power consumption Frequency 	90V to 132V 400VA at maximum 48Hz to 440Hz 198V to 250V 400VA at maximum 48Hz to 66Hz
<ul style="list-style-type: none"> ● Weight 	22kg (Nominal) (Excluding optional blocks, front cover, and accessories)
<ul style="list-style-type: none"> ● Dimensions 	Approx. 177mm (Height) \times 353mm (Width) \times 450mm (Depth) (Excluding the handle, legs and front cover)

9.2 R3271 Specifications

(1) Frequency

<p>● Frequency range</p>	<p>100Hz to 26.5GHz 18GHz to 60GHz (Using an external mixer; Tuning available up to 325GHz)</p> <table border="1" data-bbox="836 514 1404 682"> <thead> <tr> <th>Frequency band</th> <th>Higher harmonics degree</th> </tr> </thead> <tbody> <tr> <td>100Hz to 3.6GHz</td> <td>1</td> </tr> <tr> <td>3.5GHz to 7.5GHz</td> <td>1</td> </tr> <tr> <td>7.4GHz to 15.4GHz</td> <td>2</td> </tr> <tr> <td>15.2GHz to 23.3GHz</td> <td>3</td> </tr> <tr> <td>23GHz to 26.5GHz</td> <td>4</td> </tr> </tbody> </table>	Frequency band	Higher harmonics degree	100Hz to 3.6GHz	1	3.5GHz to 7.5GHz	1	7.4GHz to 15.4GHz	2	15.2GHz to 23.3GHz	3	23GHz to 26.5GHz	4			
Frequency band	Higher harmonics degree															
100Hz to 3.6GHz	1															
3.5GHz to 7.5GHz	1															
7.4GHz to 15.4GHz	2															
15.2GHz to 23.3GHz	3															
23GHz to 26.5GHz	4															
<p>● Frequency read accuracy (Start, Stop, Center frequency, Marker frequency)</p>	<p>\pm (Frequency read \times Frequency reference accuracy + Span \times Span accuracy + 0.15 \times Resolution bandwidth + 10Hz) Span accuracy (Span > 2MHz) \pm 3% (Span \leq 2MHz) \pm 5%</p>															
<p>● Marker frequency counter Resolution Accuracy (S/N \geq 25dB) Delta counter accuracy</p>	<p>1Hz to 1kHz \pm (Marker frequency \times Frequency reference accuracy + 5Hz \times N + 1LSD) \pm (Delta frequency \times Frequency reference accuracy + 10Hz \times N + 2LSD)</p>															
<p>● Frequency reference accuracy</p>	<p>$\pm 2 \times 10^{-8}$ /Day $\pm 1 \times 10^{-7}$ /Year</p>															
<p>● Frequency stability Residual FM (Zero span) Drift (After 1 hour warm-up)</p>	<p>< 3Hz \times N_{p,p} /0.1sec 50kHz < Span \leq 2MHz; < 2.5kHz \times Sweep speed(min) \times N Span \leq 50kHz; < 60Hz \times Sweep speed(min) \times N</p>															
<p>● Signal purity noise side band</p>	<table border="1" data-bbox="803 1239 1421 1480"> <thead> <tr> <th>Offset</th> <th>f \leq 2.6GHz</th> <th>f > 2.6GHz</th> </tr> </thead> <tbody> <tr> <td>1kHz</td> <td>< -100dBc/Hz</td> <td>< (-95 + 20logN)dBc/Hz</td> </tr> <tr> <td>10kHz</td> <td>< -110dBc/Hz</td> <td>< (-108 + 20logN)dBc/Hz</td> </tr> <tr> <td>20kHz</td> <td>< -110dBc/Hz</td> <td>< (-108 + 20logN)dBc/Hz</td> </tr> <tr> <td>100kHz</td> <td>< -114dBc/Hz</td> <td>< (-110 + 20logN)dBc/Hz</td> </tr> </tbody> </table>	Offset	f \leq 2.6GHz	f > 2.6GHz	1kHz	< -100dBc/Hz	< (-95 + 20logN)dBc/Hz	10kHz	< -110dBc/Hz	< (-108 + 20logN)dBc/Hz	20kHz	< -110dBc/Hz	< (-108 + 20logN)dBc/Hz	100kHz	< -114dBc/Hz	< (-110 + 20logN)dBc/Hz
Offset	f \leq 2.6GHz	f > 2.6GHz														
1kHz	< -100dBc/Hz	< (-95 + 20logN)dBc/Hz														
10kHz	< -110dBc/Hz	< (-108 + 20logN)dBc/Hz														
20kHz	< -110dBc/Hz	< (-108 + 20logN)dBc/Hz														
100kHz	< -114dBc/Hz	< (-110 + 20logN)dBc/Hz														

<ul style="list-style-type: none"> ● Frequency span Linear span Range Accuracy Logarithmic span Range Accuracy 	200Hz to 26.5GHz, Zero span $\pm 3\%$ (Span > 2MHz) $\pm 5\%$ (Span \leq 2MHz) 1kHz to 1GHz (1, 2, 3 decade can be selected) $\pm (10\% + \text{Stop frequency} \times 0.1\%)$
<ul style="list-style-type: none"> ● Resolution bandwidth (-3dB) Range Accuracy Selectivity Bandwidth (6dB) 	10Hz to 3MHz; 1, 3, 10 sequence $\pm 50\%$ (Resolution bandwidth 10 to 100Hz, Digital IF) $\pm 15\%$ (Resolution bandwidth 100Hz to 1MHz) $\pm 25\%$ (Resolution bandwidth 3MHz, 30Hz) Note: 30Hz at 25° C 10° C < 15:1 (100Hz to 3MHz) < 20:1 (30Hz) 5:1 (10 to 100Hz, Digital IF) Nominal 200Hz, 9kHz, 120kHz (based on the CISPR specification)
<ul style="list-style-type: none"> ● Video bandwidth Range 	1Hz to 3MHz; 1, 3, 10 sequence

(2) Amplitude bandwidth

<ul style="list-style-type: none"> ● Measurement range 	+ 30dBm to Average indication noise level
<ul style="list-style-type: none"> ● Maximum safe input Average continuous power (Input ATT \geq 10dB) DC input 	+ 30dBm (1W) 0 [V]
<ul style="list-style-type: none"> ● Display range Logarithmic Linear QP logarithmic 	10 \times 10 div. 10, 5, 2, 1, 0.5, 0.2, 0.1dB/div 10%/div. of the reference level 40dB (5dB/div)
<ul style="list-style-type: none"> ● Reference level range Logarithmic Linear 	- 140dBm to +60dBm (0.1dB step) 2.2 μ V to 223V (approx. 1% step of the full scale)
<ul style="list-style-type: none"> ● Input attenuator range 	0 to 70dB (10dB step)

(3) Dynamic range

<ul style="list-style-type: none"> ● Maximum dynamic range 1dB gain compression level noise level input frequency Distortion characteristics Higher harmonics 10MHz to 3.6GHz 10MHz > 3.5GHz Tertiary intermodulation > 10MHz 	<p>10MHz to 3.6GHz: $130\text{dB} - 1.55 \times f(\text{GHz})\text{dB}$</p> <p>85dB 110dB 90dB</p>
<ul style="list-style-type: none"> ● Average indication noise level (Resolution bandwidth 10Hz (Digital IF), Input attenuator 0dB, Average 20 times) Frequency range 1kHz 10kHz 100kHz 1MHz to 3.6GHz 3.5GHz to 7.5GHz 7.5GHz to 15.4GHz 15.2GHz to 23.3GHz 23GHz to 26.5GHz 	<p>– 100dBm – 110dBm – 111dBm – $\{135 - 1.55 \times f(\text{GHz})\}\text{dBm}$ – 130dBm – 123dBm – 116dBm – 110dBm</p>
<ul style="list-style-type: none"> ● 1dB gain compression > 10MHz 	<p>– 5dBm (Mixer input level)</p>
<ul style="list-style-type: none"> ● Spurious response Secondary higher harmonics distortion Frequency range 10MHz to 3.6GHz 10MHz > 3.5GHz Tertiary higher harmonics distortion Frequency range 10MHz to 3.6GHz 10MHz > 3.5GHz Image/Multiple/Band external response 10MHz to 18GHz 10MHz to 23GHz 10MHz to 26.5Hz 	<p>Mixer level – 30dBm < – 70dBc – 10dBm < – 100dBc</p> <p>Mixer level – 30dBm < – 70dBc – 30dBm < – 75dBc</p> <p>< – 70dBc < – 60dBc < – 50dBc</p>

Residual response (No input signal, Input ATT 0dB, 50 Ω terminate) 1MHz to 3.6GHz 300kHz to 26.5GHz	< -100dBm < -90dBm
--	-----------------------

(4) Amplitude accuracy

<ul style="list-style-type: none"> ● Frequency response Flatness within the band (Input ATT 10dB) 100Hz to 3.6GHz ± 1.5dB 50MHz to 2.6GHz ± 1.0dB 3.5GHz to 7.5GHz ± 1.5dB 7.4GHz to 15.4GHz ± 3.5dB 15.4GHz to 23.3GHz ± 4.0dB 23GHz to 26.5GHz ± 4.0dB Additional error due to band switching ± 0.5dB When the calibration signal is used as the reference (Input ATT 10dB) ± 5dB (100Hz to 26.5GHz) 	
<ul style="list-style-type: none"> ● Calibration signal accuracy -10dB ± 0.3dBm 	
<ul style="list-style-type: none"> ● IF gain error (After self calibration) 0dBm to -50dBm ± 0.3dB 0dBm to -80dBm ± 0.7dB ● Scale indication accuracy (After self calibration) Logarithmic ± 0.2dB/1dB ± 1dB/10dB ± 1.5dB/90dB Linear $\pm 5\%$ of the reference level QP mode logarithmic ± 1.0dB/30dB ± 2dB/40dB ± 1.0dB/40dB (25°C ± 10°C) 	
<ul style="list-style-type: none"> ● Input attenuator Switching error (Based on 10dB; in the range of 20 to 70dB) Frequency range 0 to 12.4GHz ± 1.1dB/10dB step; Maximum 2.0dB 12.4 to 18GHz ± 1.3dB/10dB step; Maximum 2.5dB 18 to 26.5GHz ± 1.8dB/10dB step; Maximum 3.5dB 	
<ul style="list-style-type: none"> ● Resolution bandwidth switching error (Resolution bandwidth: 300kHz; After self calibration) 100Hz to 3MHz: ± 0.3dB 30Hz: ± 1dB 10 to 100Hz (Digital IF) ± 1.5dB 	

<ul style="list-style-type: none"> ● Pulse quantization error (In pulse measurement mode: PRF > 700/Sweep time) <ul style="list-style-type: none"> Peak to peak Logarithmic Linear 	1.2dB (Resolution bandwidth ≤ 1MHz) 3dB (Resolution bandwidth = 3MHz) 4% of the reference level (Resolution bandwidth ≤ 1MHz) 12% of the reference level (Resolution bandwidth = 3MHz)
---	---

(5) Sweep

<ul style="list-style-type: none"> ● Sweep time <ul style="list-style-type: none"> Zero span Span ≥ 200Hz Accuracy 	50μs to 1000s, Manual sweep 20ms to 1000s, Manual sweep ± 3%
<ul style="list-style-type: none"> ● Trigger 	Free run, Line, Single, Video, TV-H, TV-V, External

(6) Demodulation

<ul style="list-style-type: none"> ● Spectrum demodulation <ul style="list-style-type: none"> Modulation type Audio output Demodulation duration 	AM, FM Internal speaker, Earphone, Jack, Sound volume adjustable 100ms to 1000s
---	---

(7) Input/Output

<ul style="list-style-type: none"> ● RF input <ul style="list-style-type: none"> Connector Impedance VSWR (Input ATT ≥ 10dB, frequency setting) LO radiation (average) Frequency setting 0 to 26.5GHz 	N-type, female (can be converted into SMA type) 50Ω (Nominal) < 1.5:1 (≤ 3.6GHz) (Nominal) < 2.5:1 (> 3.6GHz) (Nominal) < -80dBm Typ, Input ATT 10dB
<ul style="list-style-type: none"> ● First LO output <ul style="list-style-type: none"> Connector Impedance Frequency range Amplitude 	SMA, female, Front panel 50Ω (Nominal) 3.921 to 7.921GHz ± 5dB or above

<ul style="list-style-type: none"> ● Calibration signal output <ul style="list-style-type: none"> Connector Frequency Impedance Amplitude 	BNC female, Front panel 25MHz × (1 ± Frequency reference accuracy) 50Ω (Nominal) - 10dBm ± 0.3dB																		
<ul style="list-style-type: none"> ● 10MHz frequency reference input/output <ul style="list-style-type: none"> Connector Impedance Frequency range Amplitude Input range 	BNC female, Rear panel 50Ω (Nominal) 10MHz × Frequency reference accuracy 0dBm ± 3dB - 5dBm to + 5dBm																		
<ul style="list-style-type: none"> ● 21.4MHz IF output <ul style="list-style-type: none"> Connector Impedance Amplitude 3dB bandwidth 	BNC female, Rear panel 50Ω (Nominal) 0dBm (Typ) in full scale = Resolution bandwidth																		
<ul style="list-style-type: none"> ● 421MHz IF output <ul style="list-style-type: none"> Connector Impedance Gain, Noise factor, 3dB bandwidth Frequency range <ul style="list-style-type: none"> 1MHz to 3.6GHz 3.5GHz to 8GHz 7.4GHz to 15.4GHz 15.2GHz to 23.3GHz 23GHz to 26.5GHz 	BNC female, Rear panel 50Ω (Nominal) <table border="1" data-bbox="950 955 1502 1207"> <thead> <tr> <th>3dB bandwidth (Nominal)</th> <th>Noise factor (Nominal)</th> <th>Gain (Nominal)</th> </tr> </thead> <tbody> <tr> <td>> 15MHz</td> <td>24dB</td> <td>- 5dB</td> </tr> <tr> <td>> 30MHz</td> <td>24dB</td> <td>- 4dB</td> </tr> <tr> <td>> 35MHz</td> <td>30dB</td> <td>- 10dB</td> </tr> <tr> <td>> 40MHz</td> <td>38dB</td> <td>- 18dB</td> </tr> <tr> <td>> 50MHz</td> <td>44dB</td> <td>- 24dB</td> </tr> </tbody> </table>	3dB bandwidth (Nominal)	Noise factor (Nominal)	Gain (Nominal)	> 15MHz	24dB	- 5dB	> 30MHz	24dB	- 4dB	> 35MHz	30dB	- 10dB	> 40MHz	38dB	- 18dB	> 50MHz	44dB	- 24dB
3dB bandwidth (Nominal)	Noise factor (Nominal)	Gain (Nominal)																	
> 15MHz	24dB	- 5dB																	
> 30MHz	24dB	- 4dB																	
> 35MHz	30dB	- 10dB																	
> 40MHz	38dB	- 18dB																	
> 50MHz	44dB	- 24dB																	
<ul style="list-style-type: none"> ● Video output <ul style="list-style-type: none"> Connector Impedance (AC connection) Amplitude (75Ω terminate) 	BNC female, Rear panel 75Ω (Nominal) Approx. 1V _{p-p} (Composite video signal)																		
<ul style="list-style-type: none"> ● X axis, 2V/nGHz output <ul style="list-style-type: none"> Connector Impedance X axis output 2V/nGHz ● Y axis output <ul style="list-style-type: none"> Connector Impedance Amplitude 	BNC female, Rear panel 1kΩ (Nominal), DC connection approx. - 5V to + 5V approx. 2V per 1GHz BNC female, Rear panel 220Ω (Nominal) approx. 2V in full scale																		

● Z axis output Connector Amplitude During sweep Retrace interval	BNC female, Rear panel TTL level High level Low level
● External trigger input Connector Impedance Trigger level	BNC female, Rear panel 10k Ω (Nominal), DC connection Trigger at the TTL level raise
● Gate input Connector Impedance Sweep stop Sweep	BNC female, Rear panel 10k Ω (Nominal) During low mode at TTL level During high mode at TTL level
● Probe power Voltage Current	4-pin connector, Front panel + 15V, - 15V Max. 150mA each
● Voice output (Demodulation audio) Connector Power output	Small-size monophonic jack, Front panel Maximum 0.2W, 8 Ω (Nominal)
● GPIB Plotter	IEEE-488, Bus connector R9833, HP7470A, HP7475A, HP7440A, HP7550A

(8) General specifications

● Temperature and humidity During operation When stored Humidity	0°C to 50°C - 20°C to 60°C RH 85% or below
● Power source During 100VAC operation Voltage Power consumption Frequency During 220VAC operation Voltage Power consumption Frequency	90V to 132V 400VA at maximum 48Hz to 440Hz 198V to 250V 400VA at maximum 48Hz to 66Hz

● Weight	22kg (Nominal) (Excluding optional blocks, front cover, and accessories)
● Dimensions	Approx. 177mm (Height) × 353mm (Width) × 450mm (Depth) (Excluding the handle, legs and front cover)

Appendix 1 Explanation on the Technical Terms

IF Bandwidth

A band pass filter (BPF) is used in the spectrum analyzer to analyze the frequency components contained in the input signal. The 3dB bandwidth of the BPF is called IF band. (See Fig. A-1(a).) The BPF characteristics should be set at a proper waveform according to the sweep width and the sweep speed. In the case of this spectrum analyzer, the optimal value is set according to the sweep width. In general, as the smaller bandwidth is set, the spectrum resolution is improved. Therefore, the resolution of the spectrum analyzer can be expressed by the narrowest IF bandwidth. (See Fig. A-1 (b).)

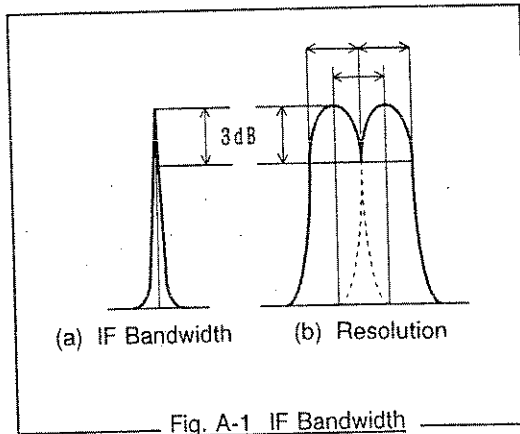

Electromagnetic compatibility (EMC)

This is a field to study the technical requirements so that a system operation will not be affected by the electromagnetic environment and will not affect it.

Electromagnetic interference (EMI)

Noise, at first, was treated as RFI (radio frequency interference), i.e., continuous wave interference, but, to include pulse-type noise interference, the concept of EMI was proposed. Considerations how to cope with EMI are basically taken in the circuit design of the electronic devices. However, circuit design is not enough to prevent electromagnetic wave radiation. Therefore, device frame should be shielded to prevent external radiation.

Reference Level Display Accuracy

When reading the absolute level of an input signal on the spectrum analyzer, the level is determined by the distance in dB from the uppermost scale on the tube surface. The level set for this uppermost scale is called reference level.

The reference level is modified by the IF GAIN key and the input attenuator and displayed in dBm or dB μ . The absolute accuracy of this display will be the reference level accuracy.

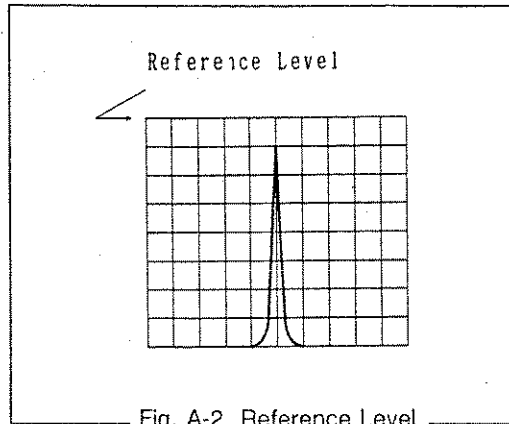

Fig. A-2 Reference Level

Gain Compression

If the input signal is greater than a certain definite value, the correct value is not displayed on the CRT as if the input signal were compressed. This phenomenon is called gain compression. The level range which will cause compression up to 1dB is used.

Maximum Input Sensitivity

The maximum sensitivity of the spectrum analyzer to detect signals. The sensitivity is affected by the noise generated from the spectrum analyzer itself and depends on the IF bandwidth. The maximum input sensitivity is normally expressed by the average noise level in the minimum IF bandwidth of the spectrum analyzer.

Maximum Input Level

This is the maximum level allowed for the input circuit of the spectrum analyzer. The level can be modified by means of the input attenuator.

Residual FM

The short-period frequency stability of the local oscillators built in the spectrum analyzer is expressed as residual FM. The frequency width fluctuating per unit time is expressed by p-p. This also determines the measurement limit value when measuring the residual FM of the signal to be measured.

Residual Response

This is the definition how much (in the input level calculation) the spurious signal generated in the spectrum analyzer is suppressed. Residual response is generated due to leak of particular signal such as local oscillation output in the spectrum analyzer. This should be taken into consideration when analyzing a precise input signal.

Quasi Peak Value Measurements

In radio communication, noise to interfere receiving appears as impulse in most cases. To evaluate this interference objectively, the noise power in proportion to the peak value is used. The measurement bandwidth and detection constant used for this evaluation are officially decided as quasi peak value measurements: JRTC specifications (in Japan) and CISPR specifications (international).

Frequency Response

This is generally used as a term to represent amplitude characteristics (frequency characteristics) for the frequency.

In the spectrum analyzer, frequency response means the frequency characteristics (flatness) of input attenuator and mixer for the input frequency and indicates in $\pm \Delta$ dB.

Zero Span

The spectrum analyzer sweeps at any frequency along the horizontal axis as the time axis but will not sweep in zero span mode.

Occupied Bandwidth

When transferring data by means of electromagnetic waves for communication or broadcasting, modulation causes significant frequency spectrum spread. The occupied bandwidth is the spectrum width which corresponds to 99% of the total average power radiated. (See Fig. A-3.)

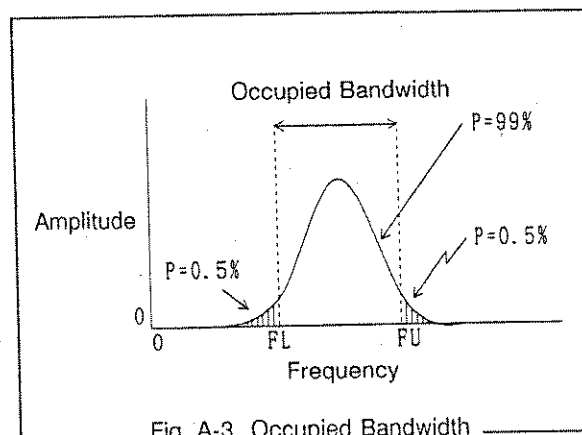

Spurious

Spurious means unnecessary signals, not the target signals. The spurious signals can be divided into several types as follows:

- Higher Harmonic Spurious : This will define the higher harmonic level generated by the spectrum analyzer itself (generated normally in the mixer circuit) when an ideal undistorted signal is fed to the analyzer. This also means the efficiency to measure higher harmonic distortion.
- Adjacent spurious : This is the small spurious generated in the vicinity of the spectrum when a pure single spectrum signal is fed to the spectrum analyzer.
- Non-higher Harmonic Spurious : Besides the two types of spurious described above, there is a spurious of a certain inherent frequency generated by the spectrum analyzer itself. This is called residual response.

Spurious Response

The distortion of the higher harmonic generated in the input mixer when the signal level is increased. The range which can be used without distortion varies depending on the input level of the basic wave. In the example of Fig.A-4, the range is -70dB against -30dBm. If the input signal level is too great, the input attenuator is used to decrease the signal fed to the mixer so that a proper input level can be obtained.

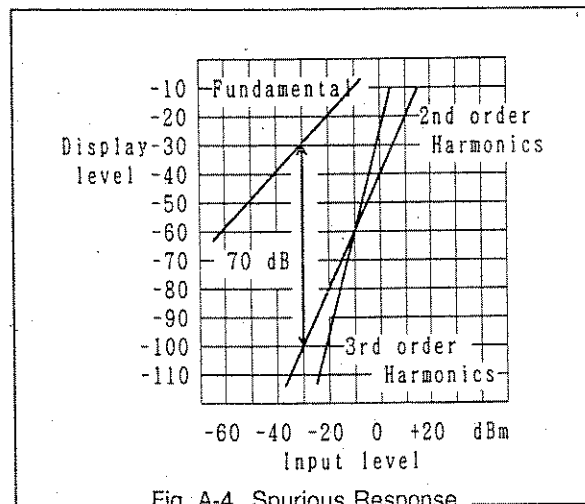

Fig. A-4 Spurious Response

Noise Sideband

This is often used to express the efficiency of the oscillator for oscillation purity. The spectrum analyzer efficiency is also lowered by the noise generated in the local oscillator and phase lock loop of the analyzer itself, which will appear in the vicinity of the spectrum on the CRT. To cope with this, the sideband of the analyzer itself is defined so that signals out of the sideband can be analyzed in a certain range. This range is called noise sideband.

In the case of spectrum analyzer, the noise sideband characteristics are expressed as follows.

Example: If the IF bandwidth is 1kHz, -70dB at 20kHz apart from the carrier. The noise level is normally expressed by the energy contained in the 1Hz bandwidth. (See Fig. A-5 (b).)

If this is expressed in 1Hz bandwidth: Since the value is -70dB when the bandwidth is 1kHz, the signals within the 1Hz bandwidth will be lower than this by about $10 \log 1\text{Hz}/1\text{kHz}$ [dB], about 30dB; and consequently, it is expressed as -100dB/Hz at 20kHz apart from the carrier when the IF bandwidth is 1kHz.

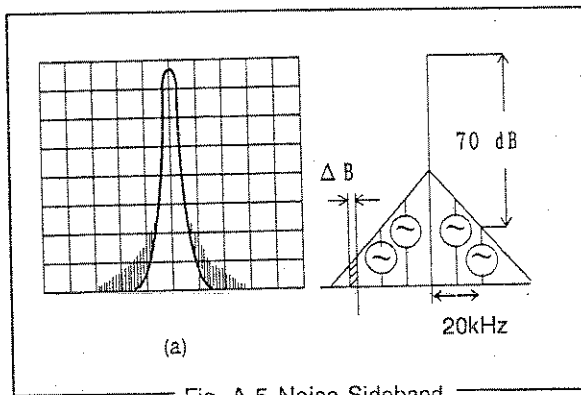

Fig. A-5 Noise Sideband

Appendix 2 Level Scalings

Appendix 2 Level Scalings

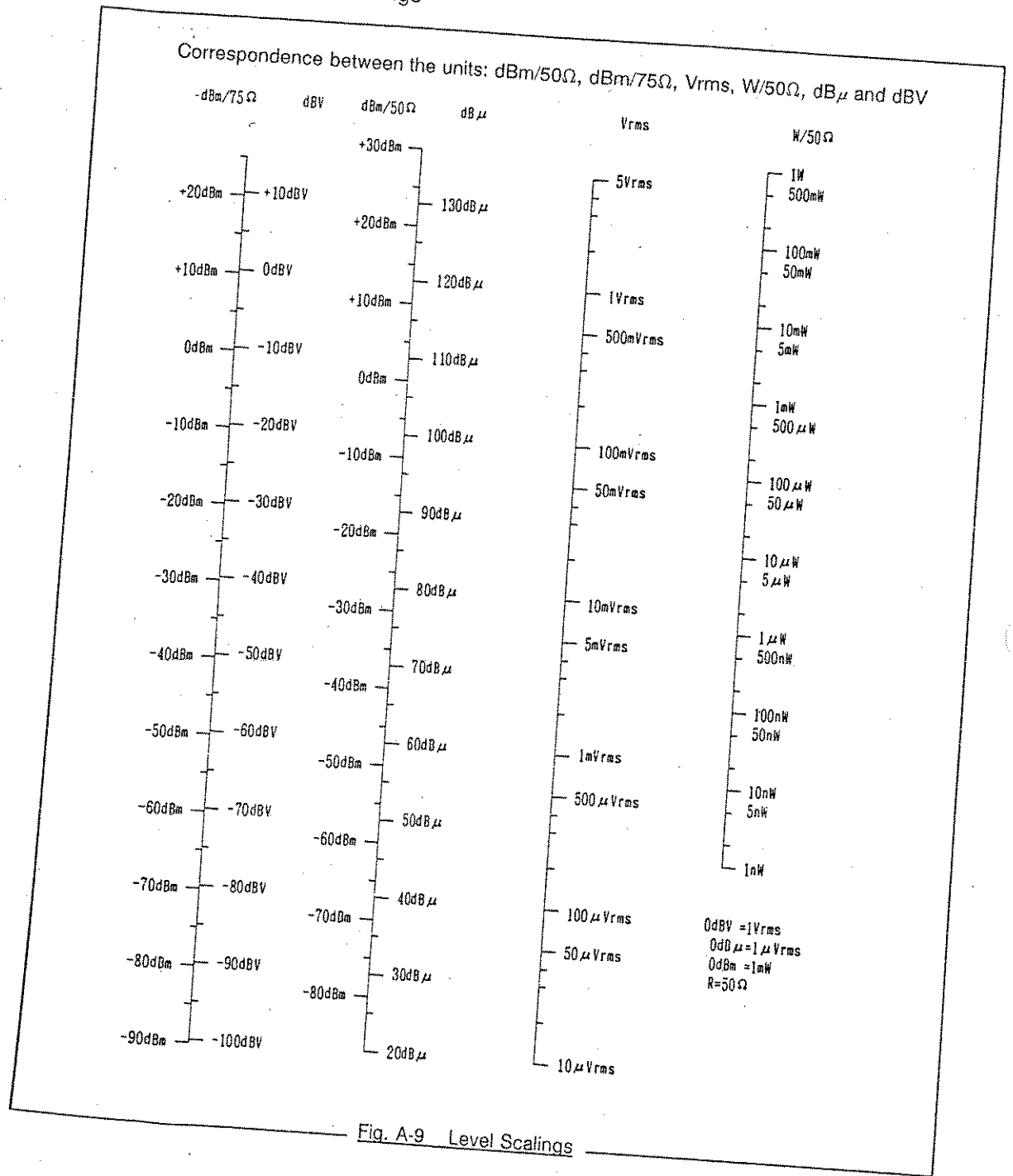

Fig. A-9 Level Scalings

6.4 Input Format (Listener)

The measurement parameters and setting conditions are entered by remote control corresponding to the panel key operations. When setting the center frequency to 300MHz, enter as follows:

PC9800 series

<u>PRINT</u> @ 01 ; "CF 300MZ"					*1 Specifies the controller as the talker.
					*2 GPIB interface selector
↑	↑	↑	↑	↑	*3 Specifies the analyzer (GPIB address 01) as the listener.
*1	*2	*3	*4	*5	*4 Sets the center frequency active.
					*5 Set value

HP200, 300 series

<u>OUTPUT</u> / 01 ; "CF 300MZ"					*1 Specifies the controller as the talker.
					*2 GPIB interface selector
↑	↑	↑	↑	↑	*3 Specifies the analyzer (GPIB address 01) as the listener.
*1	*2	*3	*4	*5	*4 Sets the center frequency active.
					*5 Set value

"CF", "3", "0" and "MZ" in the programs are GPIB codes used to remote-control the analyzer. (See Section 6.8 List of GPIB Codes.)

The following are restrictions on the data to be entered:

- Each command should be separated from another with a space or comma (.). However, this does not apply to numeric data.
 "CF SP" ...Correct
 "CFSP" ... Incorrect
 "CF 300 MZ" ... Correct
 "CF300MZ" Correct
 "DL 1DB" Sets the display line to be 1dB.
 "DL1DB" Specifies "LF" as the delimiter.
- No binary numeric can be entered. (Excluding the trace binary input)
- The carriage return (CR) and line feed (LF) are recognized as the data delimiters.
- Nothing can be entered unless it is defined as a GPIB code. If an undefined data is entered, a syntax error will be caused.

PC9801 series programming examples (GPIB address = 8)

Example 6-1: Reset the analyzer master key and set the center frequency to 25MHz.	
10 ISET IFC:ISET REN	'Executes interface clear and Remote enable.
20 PRINT @8;"IP"	'Executes Master reset.
30 PRINT @8;"CF25MZ"	'Sets the center frequency to 25MHz.
40 STOP	
50 END	
Example 6-2: Setting the start and stop frequencies to 300kHz and 800kHz, respectively, and adding 50kHz to the frequency offset	
10 ISET IFC:ISET REN	
20 PRINT @8;"FA300KZ"	'Sets the start frequency to 300kHz.
30 PRINT @8;"FB800KZ"	'Sets the stop frequency to 800kHz.
40 PRINT @8;"FON50KZ"	'Sets the frequency offset to 50kHz.
50 STOP	
60 END	
Example 6-3: Setting the reference level to 87 μ dB V (5dB/div) and RBW to 100kHz	
10 ISET IFC:ISET REN	
20 PRINT @8;"UU RE87DB"	'Sets the REF level to 87dB μ V.
30 PRINT @8;"DD5DB"	'Sets 5dB/
40 PRINT @8;"RB100KZ"	'Set the RBW to 100kHz.
50 STOP	
60 END	
Example 6-4: Setting numerals with variables	
10 ISET IFC:ISET REN	
20 SPA = 8:A = 10:B = 2:C = 20	'Substitutes set values to the variables
30 PRINT @SPA;"CF",A,"MZ"	'Sets the center frequency to 10MHz.
40 PRINT @SPA;"SP",B,"MZ"	'Sets the frequency span to 2MHz.
50 PRINT @SPA;"AT,C,"DB"	'Sets the ATT to 20dB.
60 STOP	
70 END	

Example 6-5: Save and recall of set values to/from Channel 5

```
10 ISET IFC:ISET REN
20 TITLE$ = "R3265 SPECTRUM Analyzer" 'Label definition
30 PRINT @8;"CF25MZ SP1MZ DTP" 'Data setting
40 PRINT @8"LOn/" + TITLE$ + "/" 'Label ON
50 PRINT @8;"SV 5 GZ SF1" 'Save to channel 5
60 PRINT @8;"CF1GZ SP200MZ" 'DF SP modification
70 PRINT @8;"RC 5 GZ SF1" 'Recall from channel 5
80 STOP
90 END
```

Example 6-6 Turning the soft menu display off

```
10 ISET IFC:ISET REN
20 PRINT @8;"MND OFF" 'Soft menu display OFF
30 PRINT @8;"CF30MZ SP20MZ"
40 PRINT @8;"DTS"
50 PRINT @8;"PS"
60 STOP
70 END
```

Example 6-7: Entering the Limit 1 table and turns it ON.

```
10 ISET IFC:ISET REN
20 PRINT @8;"IP HD0 MND OFF"
30 PRINT @8;"LMTADEL"           'Limit 1 table is deleted.
40 PRINT @8;"UU LMTAIN"         'Sets the unit is set to dB $\mu$ V and specifies entry in
                                the table.
50'
60 PRINT @8;"25MZ 49.5DB"       'Enters the limit line 1 data
70 PRINT @8;"27MZ 50.5DB"
80 PRINT @8;"29MZ 51.5DB"
90 PRINT @8;"31MZ 52.5DB"
100 PRINT @8;"36MZ 54.3DB"
110 PRINT @8;"40MZ 55.9DB"
120 PRINT @8;"43MZ 57.0DB"
130 PRINT @8;"46MZ 58.0DB"
140 PRINT @8;"52MZ 60.5DB"
150 PRINT @8;"63MZ 63.0DB"
160 PRINT @8;"67MZ 64.0DB"
170 PRINT @8;"66MZ 64.6DB"
180 PRINT @8;"75MZ 64.7DB"
190'
200 PRINT @8;"FAOMZ FB100MZ"    'Sets the start and stop frequencies.
210 PRINT @8;"LMTA ON MND ON"  'Limit line 1 and Soft menu display are set to ON.
220 STOP
230 END
```

HP200 and 300 series programming examples (GPIB address = 1)

Example 6-8: Reset the analyzer master key and set the center frequency to 25MHz.	

10 OUTPUT 701;"IP"	
20 OUTPUT 701;"CF25MZ"	
30 END	
Example 6-9: Setting start and stop frequencies to 300kHz and 800kHz, respectively, and adding 50kHz to the frequency offset	

10 OUTPUT 701;"FA300KZ"	
20 OUTPUT 701;"FB800KZ"	
30 OUTPUT 701;"FON50KZ"	
40 END	
Example 6-10: Setting the reference level to -20dBm (5dB/div), resolution bandwidth to 100kHz and detector mode to Positive	

10 OUTPUT 701;"RE-20DB"	
20 OUTPUT 701;"DD5DB"	
30 OUTPUT 701;"RB100KZ"	
40 OUTPUT 701;"DTP"	
50 END	
Example 6-11: Setting the trigger mode to Single, sweep time to 2 seconds, and matching the marker with the maximum level at each sweep	

10 OUTPUT 701;"SI"	
20 OUTPUT 701;"SW2SC"	
30 OUTPUT 701;"SR"	!Sweep start
40 WAIT 2.5	!Waiting for the sweep end (or service request is used)
50 OUTPUT 701;"PS"	!Peak search by the marker
60 GOTO 30	
70 STOP	
80 END	
Example 6-12: Setting MAX HOLD (A)	

OUTPUT 701;"AM"	!Setting directly
or	
OUTPUT 701;"TA SF4"	!Setting through softkey operation (Trace A → Softkey No.4)

Example 6-13: Executing Recall (in case of channel 5)

OUTPUT 701"RN"	!Switching to NORMAL mode
OUTPUT 701;"RC 5 GZ SF1"	!Channel 5 is recalled. !(SF1 is EXECUTE soft key.)
or	
OUTPUT 701;"RF"	!Switching to FAST mode
OUTPUT 701;"RC 5"	!Channel 5 is recalled.

PC9801 series programming examples (GPIB address = 8)

Example 6-14: Output the marker level. (Numeric variable)

```
10 ISET IFC:ISET REN
20 PRINT @8;"HD0"           'Header OFF
30 PRINT @8;"CF25MZ SP1MZ MK" 'Center frequency, Frequency span, Marker ON
40 PRINT @8;"ML?"          'Marker level?
50 INPUT @8;ML              'Marker level read-in
60 PRINT "MARKER LEVEL = ",ML 'The result will appear on the screen.
70 STOP
80 END
```

Result (example): MARKER LEVEL = -16.22

Example 6-15: Output the center frequency. (Character variable)

```
10 ISET IFC:ISET REN
20 PRINT @8;"HD1"           'Header ON
30 PRINT @8;"CF?"
40 INPUT @8;CF$             'Center frequency read-in
50 PRINT CF$                 'The result will appear on the screen.
60 STOP
70 END
```

Result (example): CF 000000025.000E + 6

Example 6-16: Output the level display unit and the level.

```
10 ISET IFC:ISET REN
20 PRINT @8;"HD1"           'Header ON
30 PRINT @88;"RE?"
40 INPUT @8;RE$             'REF level read-in
50 PRINT @8;"UN?"
60 INPUT @8;UN              'Level unit read-in
70 PRINT RE$," : ",UN       'The result will appear on the screen.
80 STOP
90 END
```

Result (example): REB 000000.0E + 0 : 0

Example 6-17: Execute 6dB down and output the frequency and the level. (multiple items)

```
10 ISET IFC:ISET REN
20 PRINT @8;"HD0"           'Header OFF
30 PRINT @8;"CF25MZ SP20MZ" 'Center frequency and frequency span setting
40 PRINT @8;"XDB6DB PS XDB" ' 6dB down is executed.
50 PRINT @8;"MFL?"          'The marker frequency and level are simultaneously
                             read in.
60 INPUT @8; MF,ML
70 PRINT "MARKER FREQ = ";MF;" : MARKER LEVEL = ";ML
80 STOP
90 END
```

Result (example): MARKER FREQ = 400000 : MARKER LEVEL = 1.16

Example 6-18: Execute OBW and output the calculation result.

```
10 ISET IFC:ISET REN
20 PRINT @8;"HD0"           'Header OFF
30 PRINT @8;"CF25MZ"        'Data setting
40 PRINT @8;"SP10MZ"
50 PRINT @8;"MK25MZ"
60 PRINT @8;"OBW"           'OBW is executed.
70 PRINT @8;"OBW?"          'Percentage, Occupied bandwidth, Carrier frequency
80 INPUT @8;PER,OBW,FC
90 PRINT "OBW (";PER;"%) = ";OBW;" : Fc = ";FC
100 STOP
110 END
```

REsult (example): OBW (99%) = 171000 : Fc = 2.503E + 07

Example 6-19: Output the signal level of the maximum, second and third peaks.

```
10 ISET IFC:ISET REN
20 PRINT @8;"HD0 ML?"           'Header OFF
30 print @8;"CF0MZ"           'Center frequency and frequency span setting
40 PRINT @8;"SP100MZ"
50 PRINT @8;"PS"
60 INPUT @8;A                 'Peak level read-in
70 PRINT @8;"NXP"
80 INPUT @8;B                 '2nd peak level read-in
90 PRINT @8;"NXP"
100 INPUT @8;C                '3rd peak level read-in
110 PRINT "1st PK = ";A;" : 2nd Pk = ";B;" : 3rd Pk = ";C
120 STOP
130 END
```

Result (example): 1st PK = -9.44 : 2nd PK = -10.06 : 3rd PK = -11.84

HP200 and 300 series programming examples (GPIB address = 1)

Example 6-20: Output the marker frequency. (Integer value)	
10 OUTPUT 701;"MF?"	
20 ENTER 701;A	
30 END	Result (example): A = 1.8E + 9
Example 6-21: Output the center frequency. (Character string)	
10 DIM A\$ 30	
20 OUTPUT 701;"HD1"	
30 OUTPUT 701;"CF?"	
40 ENTER 701;A\$	
50 END	Result (example): A\$ = CF 00001.234567E + 9
Example 6-22: Output the unit state.	
10 OUTPUT 701;"UN?"	
20 ENTER 701;A	
30 END	Result (example): A = 2 (dB μ V)
Example 6-23: Output the marker frequency and level simultaneously. (Multiple item output)	
10 OUTPUT 701;"MFL?"	
20 ENTER 701;Mf,M1	
30 END	Result (example): Mf = 1.8E + 9 M1 = -65.15
Example 6-24: Output the frequency offset. (Multiple item output)	
10 OUTPUT 701;"FO?"	
20 ENTER 701;On,Frq	
30 END	Result (example): On = 1 Frq = 1.23E + 6
Example 6-25: Using the NEXT PEAK, read the 10 signal peak levels, starting at the second peak.	
10 DIM M1(9)	
20 OUTPUT 701;"PS"	
30 FOR I = 0 TO 9	
40 OUTPUT 701;"NXP"	
50 OUTPUT 701;"ML?"	
60 ENTER 701;M1(I)	
70 NEXT I	
80 END	Result (example): M1(0) = -55.01 M1(1) = -58.22M1(9) = -70.26

6.6 Input and Output of Trace Data

Trace data displayed on the screen comprises 701 points of data on the frequency axis. To input or output the data, data of the 701 points are transferred one after another, starting at the left end (start frequency). The level of each point is expressed by integers from 0 to 400 or from 448 to 3648. (For the waveform out of the uppermost scale, the value exceeds 400 or 3648.)

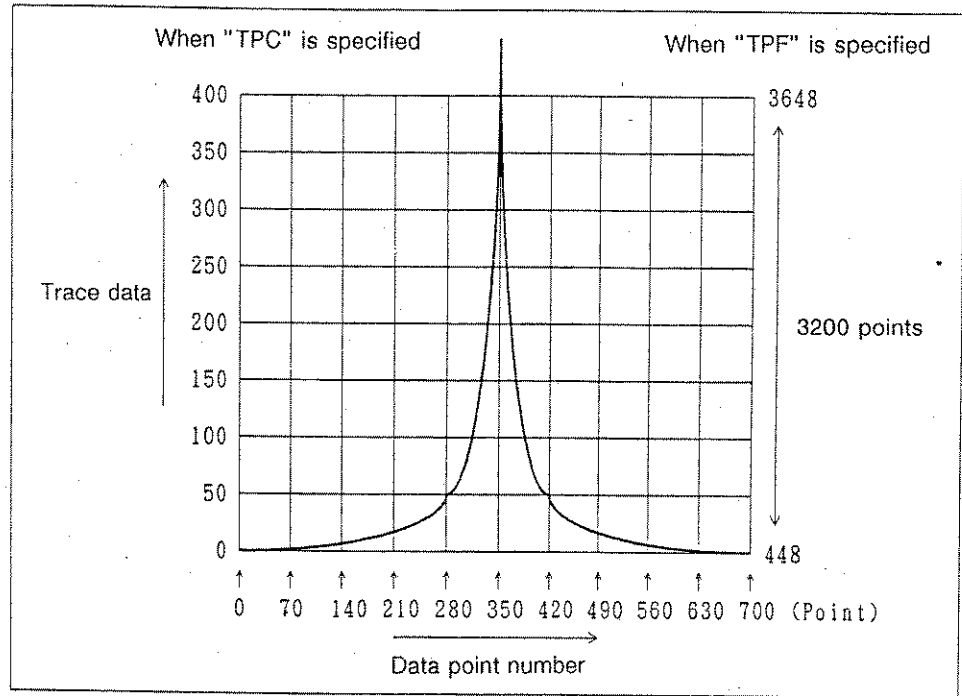

Fig. 6-4 Relation between the Screen Grid and the Number of points

Trace data can be input and output as ASCII data or Binary data.

Table 6-3 Trace Accuracy Specification Codes

GPIB code	Description
TPC	Trace data is input/output at the accuracy 0 to 400.
TPF	Trace data is input/output at the accuracy 448 to 3648.

I/O format	Description									
ASCII format	<p><u>DDDD</u> CR LF</p> <p>↑ ↑</p> <p>Data of one point Delimiter</p> <p>4-byte data without header</p> <table border="1" data-bbox="638 548 1346 695"> <thead> <tr> <th></th> <th>Input GPIB code</th> <th>Output GPIB code</th> </tr> </thead> <tbody> <tr> <td>Memory A</td> <td>TAA</td> <td>TAA?</td> </tr> <tr> <td>Memory B</td> <td>TAB</td> <td>TAB?</td> </tr> </tbody> </table>		Input GPIB code	Output GPIB code	Memory A	TAA	TAA?	Memory B	TAB	TAB?
	Input GPIB code	Output GPIB code								
Memory A	TAA	TAA?								
Memory B	TAB	TAB?								
Binary format	<p><u>DD</u> <u>DD</u> <u>DD</u> <u>DD</u> + EOI</p> <p>↑ ↑ ↑</p> <p>Point 1 lower byte Point 701 lower byte Delimiter</p> <p>Point 1 upper byte Point 701 upper byte</p> <p>The binary value of one-point data consists of upper and lower bytes. The 701-point data is completed with the EOI signal at the end.</p> <table border="1" data-bbox="651 1119 1357 1266"> <thead> <tr> <th></th> <th>Input GPIB code</th> <th>Output GPIB code</th> </tr> </thead> <tbody> <tr> <td>Memory A</td> <td>TBA</td> <td>TBA?</td> </tr> <tr> <td>Memory B</td> <td>TBB</td> <td>TBB?</td> </tr> </tbody> </table>		Input GPIB code	Output GPIB code	Memory A	TBA	TBA?	Memory B	TBB	TBB?
	Input GPIB code	Output GPIB code								
Memory A	TBA	TBA?								
Memory B	TBB	TBB?								

Trace output range specification

The output range of the trace data can be specified. For the following commands, specify the start point and the number of output items.

- TAA?
- TBA?
- TAB?
- TBB?

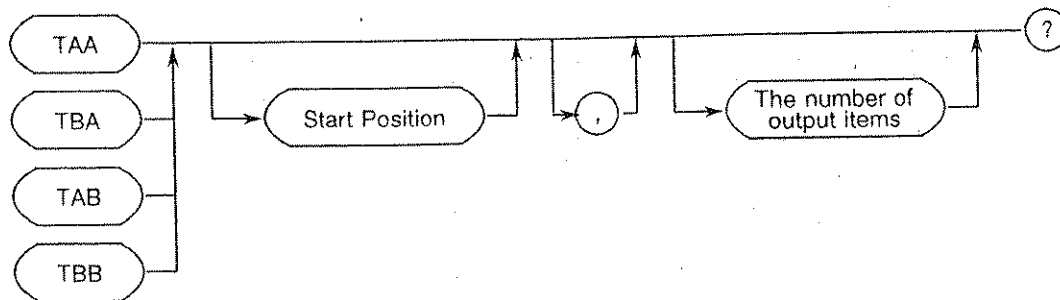

Start position: Specifies 0 through 700. (Initial value is 0.)

The number of output items: This should be specified to satisfy Start position + The number of output items \leq 701 (Initial value is 701.)

PC9801 series programming examples (GPIB address = 8)

Example 6-26: Output the data from memory A in ASCII (0 to 400)	
10 ISET IFC: ISET REN	'Interface clear and Remote enable are executed.
20 DIM TR(701)	
30 PRINT @8;"DL0 TPC DTG"	'Negative detector and Trace accuracy 0 to 400 are set.
40 PRINT @8;"TAA?"	'Output from memory A in ASCII is specified.
50 FOR I=0 TO 700	
60 INPUT @8;TR(I)	'701-point data are read-in
70 PRINT I;"="";TR(I)	
80 NEXT I	
90 END	
Result (example): Tr(0) = 208 Tr(1) = 210 Tr(699) = 311 Tr(700) = 298	

PC9801 series programming examples (GPIB address = 8)

Example 6-27: Output the data from memory A in Binary (0 to 400)	
10 ISET IFC: ISET REN	'Interface clear and Remote enable are executed.
20 DIM TR(701)	
30 PRINT @8;"DL2 TPC DTG"	'Negative detector and Trace accuracy 0 to 400 are set.
40 PRINT @8;"TBA?"	'Output form memory A in Binary is specified.
50 WBYTE &H3F,&H5F,&H3E,&H48;	'Listener is canceled, PC9801 is set as listener No.30, and the analyzer is set as Talker No.8.
60	
70 FOR I=0 TO 700	
80 RBYTE ;UP,LO	'701-point data loading is specified for the upper and lower bytes.
90 TR(I)=UP*256 + LO	'Repeat for the number of points
100 PRINT I;" = ";TR(I)	
110 NEXT I	
120 WBYTE &H3F,&H5F;	'Listener and Talker are canceled.
130 STOP	
140 END	
Result (example): Tr(0) = 312 Tr(1) = 319 Tr(699) = 208 Tr(700) = 211	
Example 6-28: Input data to memory A in ASCII (0 to 400)	
10 ISET IFC: ISET REN	'Interface clear and Remote enable are executed.
20 A=0:ST=3.14/100	
30 PRINT @8;"TPC AB TAA"	'Input to memory A in ASCII is specified. (accuracy 0 to 400)
40 FOR I=0 to 700	
50 N=INT(SIN(A)*200) + 200	
60 A=A+ST	
70 PRINT @8;N	
80 NEXT I	
90 PRINT @8;N"AV"	'A VIEW
100 STOP	
110 END	

PC9801 series programming examples (GPIB address = 8)

Example 6-29: Input data to memory A in Binary. (0 to 400)	
10 ISET IFC:ISET REN	'Interface clear and Remote enable are executed.
20 DIM DT(701)	
30 A = 0:ST = 3.14/100	
40 PRINT @8;"TPC AB CWA TBA"	'Input to memory A in Binary is specified. (accuracy 0 to 400).
50 FOR I=0 TO 700	
60 DT(I) = INT(COS(A)*200) + 200	
70 A = A + ST	
80 NEXT I	
90	'Listener is canceled, PC9801 is set as Talker No.30, and the analyzer is set as Listener No. 8.
100	
110 WBYTE &H3F,&H5F,&H5E,&H28;DT(0) ¥ 256,DT% (0) MOD 256	
120 FOR I= 1 TO 699	
130 WBYTE ; DT(I) ¥ 256,DT(I) MOD 256	'The upper byte and lower byte data are transferred separately.
140 NEXT I	
150 WBYTE ; DT(700) ¥ 256,DT(700) MOD 256@	'The last data is output together with the EOI signal.
160 PRINT @8;"AV"	
170 STOP	'A VIEW
180 END	

HP200 and 300 series programming examples (GPIB address = 1)

Example 6-30: Output data from memory A in ASCII.	
10 DIM Tr(700)	!701 variables are fetched.
20 OUTPUT 701;"DL3"	!CR LF is specified as delimiter.
30 OUTPUT 701;"TAA?"	!Memory A is specified as ASCII.
40 FOR I=0 TO 700	!Data fetch is repeated 701 times.
50 ENTER 701;Tr(I)	!
60 NEXT I	!
70 END	
Result (example): Tr(0) = 208 Tr(1) = 210Tr(699) = 311 Tr(700) = 298	
Example 6-31: Output data from memory B in Binary.	
10 DIM Tr(700)	!701 variables are fetched.
20 OUTPUT 701;"DL2"	!EOI is specified as delimiter.
30 OUTPUT 701;"TBB?"	!Memory B is specified as Binary.
40 ENTER 701 USING "%,W";Tr(*)	!Data is fetched through word conversion until the EOI is received.
50 END	
Result (example): Tr(0) = 312 Tr(1) = 319 Tr(699) = 208 Tr(700) = 211	
Example 6-32: Input data to memory A in ASCII.	
10 INTEGER Tr(700)	!
20 OUTPUT 701;"TAA"	!Memory A is specified as ASCII.
30 FOR I=0 TO 700	!Input of variable Tr is repeated 701 times.
40 OUTPUT 701;Tr(I)	!
50 NEXT I	!
60 END	
Note: VIEW mode should be specified before executing the program. After execution is complete, press the VIEW key again to confirm the input result.	

HP200 and 300 series programming examples (GPIB address = 1)

Example 6-33: Input data to memory B in Binary.

```
10 INTEGER Tr(700)
20 OUTPUT 701;"TBB"
30 OUTPUT 701 USING "#,W";Tr(*),END
40 END
```

Memory B is specified as Binary.

701 data are input in word size and EOI is added at the end.

Note: VIEW mode should be specified before executing the program. After execution is complete, press the VIEW key again to confirm the input result.

Note: If the data is in ASCII mode, 701 times should be specified as the the number of I/O processings.
If the data is in Binary mode, 701 data items should be fetched and the EOI should be specified as the delimiter.

6.7 Service Request (SRQ)

Using the service request function, the analyzer state can be detected by external devices. When one of the following conditions has occurred, the corresponding status bit turns ON and the controller can read the status byte by serial polling.

Table 6-4 SRQ ON/OFF Specification codes

GPIB code	Description
S0	SRQ signal (interrupt) is transmitted to the controller.
S1	No SRQ signal (interrupt) is transmitted to the controller. (initial setting)
S2	The status byte is cleared.

Table 6-5 Trace Accuracy Specification Codes

Bit	Decimal	Description
0	1	Turns ON when UNCAL has occurred.
1	2	Turns ON when the calibration is complete.
2	4	Turns ON when sweep is complete.
3	8	Turns ON when the specified number of averaging is complete.
4	16	Turns ON when plot output is complete.
5	32	Turns ON when an error is found in the GPIB code or a mode error has occurred (SYNTAX ERR)
6	64	Turns ON simultaneously with bits 0 through 5 or bit 7 when a service request is transmitted (SO).
7	128	

PC9801 series programming examples (GPIB address = 8)

Example 6-34: Read out the average completion. (No SRQ interrupt is transmitted.)		
10	ISET IFC:ISET REN	
20	PRINT @8;"S2"	'Status clear
30	PRINT @8;"AG 30GZ"	'Average A start
40	*LOOP	
50	POLL 8,S	'The status byte is read into variable S.
60	IF (S AND 8) = 0 THEN GOTO *LOOP	'Loop until bit 3 turns ON.
70	STOP	
80	END	
Example 6-35: Read the sweep end and execute a single sweep. (No SRQ interrupt is transmitted.)		
10	ISET IFC:ISET REN	
20	PRINT @8;"S1"	'Single sweep is set.
30	*LOOP	
40	PRINT @8;"S2"	'The status byte is cleared.
50	PRINT @8;"SR"	'Sweep start
60	*SPOLL	
70	POLL 8,S	'The status byte is read into the variable S.
80	IF(S AND 4) = 0 THEN GOTO *SPOLL	'Loop and bit 2 turns ON.
90	BEEP:GOTO *LOOP	'Buzzer is actuated to notify sweep end.
100	STOP	
110	END	

PC9801 series programming examples (GPIB address = 8)

Example 6-36: Read out the peak frequency and level for each single sweep. (SRQ interrupt is transmitted.)

```
10 ISET IFC:ISET REN
20 PRINT @8;"HD0 SI MFL?"           'Header OFF, Single sweep
30 ON SRQ GOSUB *SPOLL              'The jump destination when SRQ interrupt is
                                     received is specified.
40 PRINT @8;"S0"                    'The analyzer SRQ interrupt is set to transmission
                                     state.
50 SRQ ON                           'PC9801 is enabled for SRQ interrupt.
60 POLL 8,S                          'The status byte is cleared.
70*LOOP
80 SWP = 0
90 PRINT @8;"SR"                     'Sweep start
100*INTWAIT
110 IF SWP = 0 THEN GOTO *INTWAIT    'Waiting for interrupt
120 '
130 PRINT @8;"PS"                    'Peak search is executed.
140 INPUT @8;"MF,ML"                 'Peak frequency and level are read in.
150 PRINT "PEAK FREQ = ";MF;" : PEAK LEVEL = ";ML
160 GOTO *LOOP                       'Continuous execution
170 '
180*SPOLL
190 POLL 8,S                          'The status byte is read into variable S.
200 IF (S AND 4) < > 0 THEN BEEP:    'Sweep is complete when bit 2 turns ON.
    SWP = 1
210 RETURN
```

Example 6-37: Read the wave 1st and 2nd peak values with the marker counter.

```
10 ISET IFC:ISET REN
20 PRINT @8;"IP HD0 MND OFF"      'Preset, Header OFF
30 PRINT @8;"MFL?"
40 PRINT @8;"CF25MZ SP100MZ"     'Data setting
50 PRINT @8;"DX10GZ DY50GZ"
60 PRINT @8;"SI"                 'Single sweep is set.
70 GOSUB *SWEEP                  'A single sweep is executed.
80 PRINT @8;"CN1"                'Counter and peak search are executed.
90 PRINT @8;"PS"
100 GOSUB *SWEEP                  'A single sweep is executed.
110 INPUT @8;MF1,ML1              'The marker frequency and level are read in.
120 PRINT @8;"NXP"               'Next peak is executed.
130 GOSUB *SWEEP                  'A single sweep is executed.
140 INPUT @8;MF2,ML2              'The 2nd peak frequency and level are read in.
150 PRINT @8;"1st PEAK = ";MF1;" : ";ML1;" 2nd PEAK = ";MF2;" : ";ML2"
160 STOP
170 END
180*SWEEP
190 PRINT @8;"S2"                 'The status byte is cleared.
200 PRINT @8;"S1"                 'Sweep start
210*SPOLL
220 POLL 8,S
230 IF (S AND 4) = 0 THEN GOTO *SPOLL 'Waiting for sweep end
240 BEEP:RETURN
```

Example 6-38: Turn the Next peak list ON and read out the eight peak values.

```
10 ISET IFC:ISET REN
20 PRINT @8;"IP HD0 MND OFF S2"      'Preset and status byte clear
30 PRINT @8;"FA0GZ FB1GZ"
40 PRINT @8;"AG1 AG 30GZ"          'Average A start
50*SPOLL
60 POLL 8,S
70 IF (S AND 8) = 0 THEN GOTO *SPOLL 'Waiting for the average end
80 BEEP
90 PRINT @8;"PLS ON"                'Next peak list turns ON.
100 PRINT @8;"MLSF?"                'The nine marker levels are read in.
110 INPUT @8;F1,F2,F3,F4,F5,F6,F7,F8,F9
120 PRINT "1st PEAK = ";F1           'The result will appear on the screen.
130 PRINT "2nd PEAK = ";F2
140 PRINT "3rd PEAK = ";F3
150 PRINT "4th PEAK = ";F4
160 PRINT "5th PEAK = ";F5
170 PRINT "6th PEAK = ";F6
180 PRINT "7th PEAK = ";F7
190 PRINT "8th PEAK = ";F8
200 PRINT @8;"MND ON"               'Soft menu display turns ON.
210 STOP
220 END
```

Example 6-39: Execute sweep twice and read out the peak frequency and level. ("TS" command is used without using the SRQ.)

```
10 ISET IFC: ISET REN
20 PRINT @8;"IP HD0"
30 PRINT @8;"SP10MZ MFL?"
40 FOR I=0 TO 30
50 PRINT @8;"CF",I,"MZ"
60 PRINT @8;"TS TS PS"
70 INPUT @8;MF,ML
80 PRINT "CF = ";;"MZ","FREQ = ";MF,"LEVEL = ";ML
90 BEEP
100 NEXT I
110 STOP
```

HP200 and 300 series programming examples (GPIB address = 1)

Example 6-40: Read out the average end. (No SRQ is transmitted.)	
10 OUTPUT 701;"S2"	!The status byte is cleared.
20 OUTPUT 701;"AG 30GZ"	!Average (A) start (30 times)
30 S = SPOLL(701)	!The status byte is read into S.
40 IF BIT(S,3) < > 1 THEN 30	!Loop until bit 3 turns ON.
50 DISP "AVG.END"	!Completion is indicated.
60 END	
Example 6-41: Continuously read out the single sweep end. (No SRQ is transmitted.)	
10 OUTPUT 701;"S1"	!Mode is set to Single.
20 OUTPUT 701;"S2"	!The status byte is cleared.
30 OUTPUT 701;"SR"	!Sweep start
40 S = SPOLL(701)	!The status byte is read into S.
50 IF BIT(S,2) < > 1 THEN 40	!Waiting until bit 2 turns ON.
60 PRINT "SWEEP END"	!Completion is indicated.
70 GOTO 20	!Next sweep start
80 END	
Example 6-42: Read out the average end (SRQ is transmitted.)	
10 OUTPUT 701;"S0"	!Transmission
20 OUTPUT 701;"S2"	!The status byte is cleared.
30 OUTPUT 701;"AG"	!Average (A) start
40 ON INTR 7 GOTO 70	!Jump to line 70 when an interrupt has occurred.
50 ENABLE INTR 7;2	!Mode is set to receive interrupt.
60 GOTO 50	!Loop until an interrupt occurs.
70 S = SPOLL(701)	!The status byte is read into S.
80 IF BIT(S,3) = 1 THEN 110	!Jump to line 110 if bit 3 is ON.
90 OUTPUT 701;"S2"	!The status byte is cleared.
100 GOTO 40	!Repeat
110 DISP "AVG.END"	!Completion is indicated.
120 END	

6.8 List of GPIB Codes

The GPIB codes given in the table below can be used in the R3265 and R3271.

Notes on the table below

- The asterisk (*) in the column of Listener codes indicates that numeric data can be entered following the code.
- The plus sign (+) in the column of output formats indicates that multiple data items are output.
- AUTO/MANUAL in the column of output formats indicate that they outputs 1/0, respectively.
- ON/OFF in the column of output formats indicate that they outputs 1/0, respectively.
- The mark ☆ in the column of remarks indicate the initial value when power is turned on.
- The minus sign (-) indicates inapplicable items.

Function	Listener code	Talker request			Remarks
		Code	Output format	Header	
Center frequency	CENTER *	CENTER?	Frequency	CF	
	CF *	CF?	Frequency	CF	
CF step size	CFSTEP *	CFSTEP?	Frequency	CS	
	CS *	CS?	Frequency	CS	
CF step AUTO	CSAUTO	CSAUTO?	AUTO/MANUAL	-	
	CA	CA?	AUTO/MANUAL	-	
Frequency offset size	FROFS *	FROFS?	OFF/ON + Frequency	FO	
	FO *	FO?	OFF/ON + Frequency	FO	
Frequency offset ON	FROFS ON *	-	-	-	
	FO ON *	-	-	-	
	FON *	-	-	-	
Frequency offset OFF	FROFS OFF	-	-	-	
	FO OFF	-	-	-	
	FOF	-	-	-	
Internal mixer	MXINT	-	-	-	
	MXI	-	-	-	

Function	Listener code	Talker request			Remarks
		Code	Output format	Header	
External mixer	MXEXT	-	-	-	
	MXE	-	-	-	
Positive bias	MXPOSI *	MXPOSI ?	Integer	MPX	
	MPX *	MPX?	Integer	MPX	
Negative bias	MXNEGA *	MXNEGA?	Integer	MPXN	
	MPXN *	MPXN?	Integer	MPXN	
Band N	BND *	BND?	Integer	BND	
Band lock	-	BNDLC?	OFF/ON	-	
Band lock ON	BNDLC ON	-	-	-	
Band lock OFF	BNDLC OFF	-	-	-	
Signal ident	-	SIGID?	OFF/ON	-	
Signal ident ON	SIGID ON	-	-	-	
Signal ident OFF	SIGID OFF	-	-	-	
Avg. Loss mode	-	AGL?	OFF/ON	-	
Avg. Loss ON	AGL ON	-	-	-	
Avg. Loss OFF	AGL OFF	-	-	-	
Loss vs. Freq mode	-	LVF?	OFF/ON	-	
Loss vs. Freq ON	LVF ON	-	-	-	
Loss vs. Freq OFF	LVF OFF	-	-	-	
Loss vs. Freq input	LVFIN *	-	-	-	
Loss vs. Freq deletion	LVFDEL	-	-	-	
Reference signal source (Internal)	RFI	-	-	-	
Reference signal source (External)	RFE	-	-	-	

Function	Listener code	Talker request			Remarks
		Code	Output format	Header	
Frequency span	SPAN *	SPAN?	Frequency	SP	
	SP *	SP?	Frequency	SP	
Span mode	—	SPMD?	0: Linear span	—	
	—	SPM?	2: Log span	—	
Linear span	LINSP *	LINSP?	Frequency		
	LS *	LS?	Frequency		
Full span	FLSP	—	—	—	
	FS	—	—	—	
Log span	LOGSP	—	—	—	
	LG	—	—	—	
Log start	LGSTART *	LGSTART?	Frequency	LGA	
	LGSRT *	LGSRT?	Frequency	LGA	
	LGA *	LGA?	Frequency	LGA	
Log stop	LGSTOP *	LGSTOP?	Frequency	LGB	
	LGSTP *	LGSTP?	Frequency	LGB	
	LGB *	LGB?	Frequency	LGB	
Zero span	ZROSP	—	—	—	
	ZS	—	—	—	
Last span	LTSP	—	—	—	
Start frequency	START *	START?	Frequency	FA	
	SRT *	SRT?	Frequency	FA	
	FA *	FA?	Frequency	FA	
	FT *	FT?	Frequency	FA	
Stop frequency	STOP *	STOP?	Frequency	FB	
	STP *	STP?	Frequency	FB	
	FB *	FB?	Frequency	FB	
	FP *	FP?	Frequency	FB	

Function	Listener code	Talker request			Remarks	
		Code	Output format	Header		
Reference level	REF *	REF?	Level	Unit: Header		
	RE *	RE?	Level	dBm: REB		
	RL *	RL?	Level	dBmv:R EM		
				dB μ V:R EU		
				dB μ Vemt: REE		
				dBpW: REP		
				V:REV		
				W: REW		
		DIV *	DIV?	0: 10dB/	-	
		DD *	DD?	1: 5dB/ 2: 2dB/ 3: 1dB/ 4:0.5dB/ 5:0.2dB/ 6:0.1dB/	-	
Multiplication factor	-	LIN?	0: x1	-		
	-	LL?	1: x2	-		
		LN?	2: x5			
			3: x10			
		LIN1	-	-	-	
		LN1	-	-	-	
		LL1	-	-	-	

Function	Listener code	Talker request			Remarks
		Code	Output format	Header	
LINEAR × 2	LIN2	--	--	--	
	LN2	--	--	--	
	LL2	--	--	--	
LINEAR × 5	LIN5	--	--	--	
	LN5	--	--	--	
	LL5	--	--	--	
LINEAR × 10	LIN10	--	--	--	
	LN10	--	--	--	
	LL10	--	--	--	
Reference level display unit?	--	UNIT?	0:dBm	--	
	--	UN?	1:dBmV	--	
		AUNITS?	2:dB μ V	--	
			3:dB μ Vemf		
			4:dBpW		
			6:V		
			7:W		
Unit :dBm	UDBM	--	--	--	
	AUNITS DBM	--	--	--	
	KSA	--	--	--	
:dBmV	UB	--	--	--	
	UDBMV	--	--	--	
	AUNITS DBMV	--	--	--	
	KSB	--	--	--	
	UM	--	--	--	

R3265/3271
SPECTRUM ANALYZER
INSTRUCTION MANUAL

6.8 List of GPIB Codes

Function	Listener code	Talker request			Remarks
		Code	Output format	Header	
: dB μ V	UDBUV	-	-	-	
	AUNITS	-	-	-	
	DBUV	-	-	-	
	KSC	-	-	-	
: dB μ Vemf	UU	-	-	-	
	UEMF	-	-	-	
: dBpW	UE	-	-	-	
	UDBPW	-	-	-	
: volts	UW	-	-	-	
	UVLT	-	-	-	
	AUNITS V	-	-	-	
: watts	KSD	-	-	-	
	UWAT	-	-	-	
	AUNITS W	-	-	-	
Level offset	REFOFS *	REFOFS?	OFF/ON + Level	RO	
	RO *	RO?	OFF/ON + Level	RO	
Level offset ON	REFOFS ON*	-	-	-	
	RO ON *	-	-	-	
	RON *	-	-	-	
Level offset OFF	REFOFS OFF	-	-	-	
	RO OFF	-	-	-	
	ROF	-	-	-	
Low noise mode	-	LNI?	OFF/ON	-	
Low noise mode ON	LNI ON	-	-	-	
Low noise mode OFF	LNI OFF	-	-	-	

Function	Listener code	Talker request			Remarks
		Code	Output format	Header	
COUPLED FUNCTION	COUPLE	--	--	--	
	CO	--	--	--	
RBW	RBW *	RBW?	Frequency	RB	
	RB *	RB?	Frequency	RB	
RBW AUTO	RBAUTO	RBAUTO?	AUTO/MANUAL	--	
	BA	BA?	AUTO/MANUAL	--	
VBW	VBW *	VBW?	Frequency	VB	
	VB *	VB?	Frequency	VB	
VBW AUTO	VBAUTO	VBAUTO?	AUTO/MANUAL		
	VA	VA?	AUTO/MANUAL		
SWP	SWP *	SWP?	Time		
	SW *	SW?	Time		
	ST *	ST	Time		
SWP AUTO	SWAUTO	SWAUTO?	AUTO/MANUAL		
	AS	AS?	AUTO/MANUAL		
ATT	ATT *	ATT?	Level	AT	
	AT *	AT?	Level	AT	
ATT AUTO	ATAUTO	ATAUTO?	AUTO/MANUAL	--	
	AA	AA?	AUTO/MANUAL	--	
Couple AUTO	COAUTO	--	--		
	AC	--	--		
Couple ALL AUTO	COALL	COALL?	AUTO/MANUAL		
	AL	AL?	AUTO/MANUAL		
MIN. ATT	ATMIN *	ATMIN?	OFF/ON + Level	ATM	
MIN. ATT ON	ATMIN ON *	--	--	--	
MIN. ATT OFF	ATMIN OFF	--	--	--	

Function	Listener code	Talker request			Remarks
		Code	Output format	Header	
RBW:SPAN	CORS *	CORS ?	OFF/ON + Ratio	CORS	
RBW:SPAN ON	CORS ON *	-	-	-	
RBW:SPAN OFF	CORS OFF	-	-	-	
VBW:RBW	COVR *	COVR?	OFF/ON + Ratio	COVR	
VBW:RBW ON	COVR ON *	-	-	-	
VBW:RBW OFF	COVR OFF	-	-	-	
Digital IF mode	-	FFT?	0: OFF 1: ON (100Hz contained) 2: OFF (100Hz not contained)		
Digital IF ON	FFT ON	-	-	-	
ON (RBW 100Hz contained)	FFT1	-	-	-	
ON (RBW 100 Hz not contained)	FFT2	-	-	-	
Digital IF OFF	FFT OFF	-	-	-	
MENU	MENU	-	-		
	ME	-	-		
Trigger mode	-	TRMD?	0: FREE RUN		
	-	TM?	1: LINE 2: VIDEO 3: TV_V 4: TV_H 5: External 6: Single		

Function	Listener code	Talker request			Remarks
		Code	Output format	Header	
Trigger : FREE RUN : LINE : VIDEO : TV_V : TV_H ODD : TV_H EVEN : External	FREE	-	-	-	
	TM FREE	-	-	-	
	FR	-	-	-	
	LINE	-	-	-	
	TM LINE	-	-	-	
	LI	-	-	-	
	VIDEO	-	-	-	
	VI	-	-	-	
	TVV	-	-	-	
	TV	-	-	-	
	TVHODD *	TVHODD?	Integer	TVH	
	TVHEVEN *	TVHEVEN?	Integer	TVH	
	EXT	-	-	-	
	TM EXT	-	-	-	
	EX	-	-	-	
Trigger level	TR	TR?	Integer	TR	
Detector mode?	-	DTMD?	0: Posi-Nega	-	
	-	DM?	1: Positive	-	
	-	DET?	2: Negative 3: Sample		
Detector					
Posi-Nega	DTN	-	-	-	
	DET NRM	-	-	-	
	KSa	-	-	-	
Positive	DTP	-	-	-	
	DET POS	-	-	-	
	KSb	-	-	-	

R3265/3271
SPECTRUM ANALYZER
INSTRUCTION MANUAL

6.8 List of GPIB Codes

Function	Listener code	Talker request			Remarks
		Code	Output format	Header	
: Negative	DTG	-	-	-	
	DET NEG	-	-	-	
: Sample	KSd	-	-	-	
	DTS	-	-	-	
	DET SMP	-	-	-	
Sweep mode	KSe	-	-	-	
	-	SWMD?	0: Normal & Full	-	
	-	SWM?	1: Normal & Window 10: Manual & Full 11: Manual & Window 20: Single & Full 21: Single & Window	-	
Sweep : Normal	CONTS	-	-	-	
	SN	-	-	-	
: Manual	MANSWP	-	-	-	
	SM	-	-	-	
: Single	SNGLS	-	-	-	
	SI	-	-	-	
: Window ON	WDOSWP ON	-	-	-	
	SDW	-	-	-	
: Window OFF	WDOSWP OFF	-	-	-	
: Reset & Start	SR	-	-	-	
: Take Sweep	TS	-	-	-	
Sound mode	-	SDMD?	0: OFF	-	
	-	SD?	1: ON (AM)	-	
	-		2: ON (FM)	-	

Function	Listener code	Talker request			Remarks
		Code	Output format	Header	
Sound OF (AM or FM)	SON				
Sound ON (AM)	SD AM	-	-	-	
	SAM	-	-	-	
Sound ON (FM)	SD FM	-	-	-	
	SFM	-	-	-	
Sound OFF	SD OFF	-	-	-	
	SOF	-	-	-	
Sound volume	SDVOL *	SDVOL?	Integer	VOL	
	SDV *	SDV?	Integer	VOL	
Volume (Maximum)	VX	-	-	-	
Volume (Intermediate)	VD	-	-	-	
Volume (Minimum)	VN	-	-	-	
Pause time	PAUSE *	PAUSE?	OFF/ON + Time	PU	
	PU *	PU?	OFF/ON + Time	PU	
Marker pause ON	PAUSE ON *	-	-	-	
	PU ON *	-	-	-	
	PUN *	-	-	-	
Marker pause OFF	PAUSE OFF	-	-	-	
	PU OFF	-	-	-	
	PUF	-	-	-	
SQELCH ?	SQE *	SQE?	OFF/ON + Level	SQE	
SQELCH ON	SQE ON *	-	-	-	
SQELCH OFF	SQE OFF	-	-	-	
AGC ?	-	SDAGC?	OFF/ON	-	
AGC ON	SDAGC ON	-	-	-	
AGC OFF			-	-	

Appendix 2 Level Scalings

3μ and dBV

Appendix 3 Menu Lists

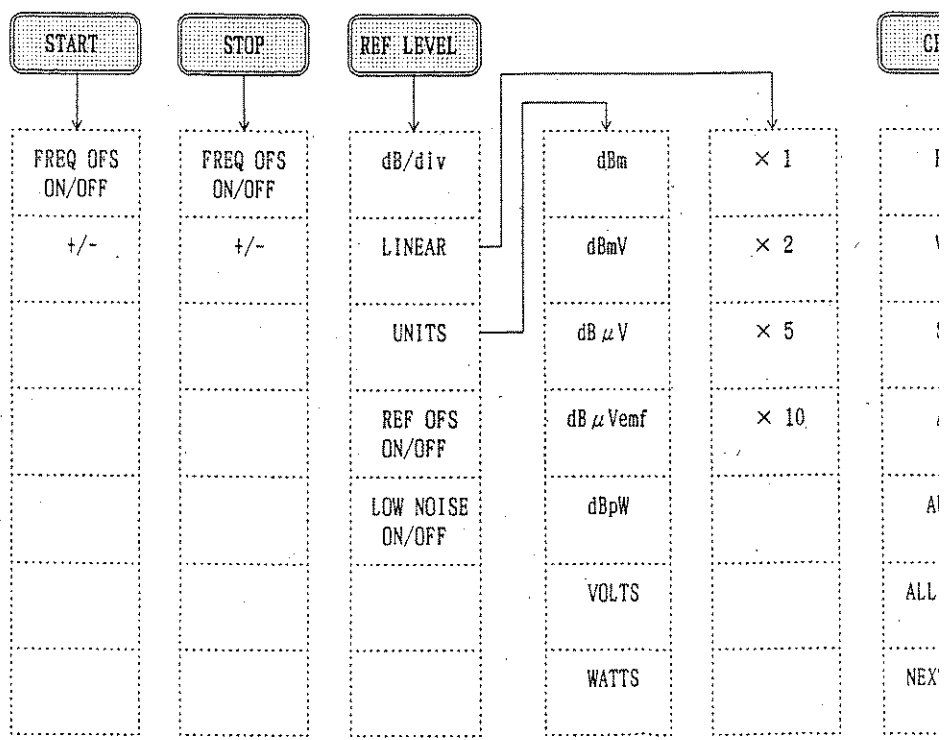
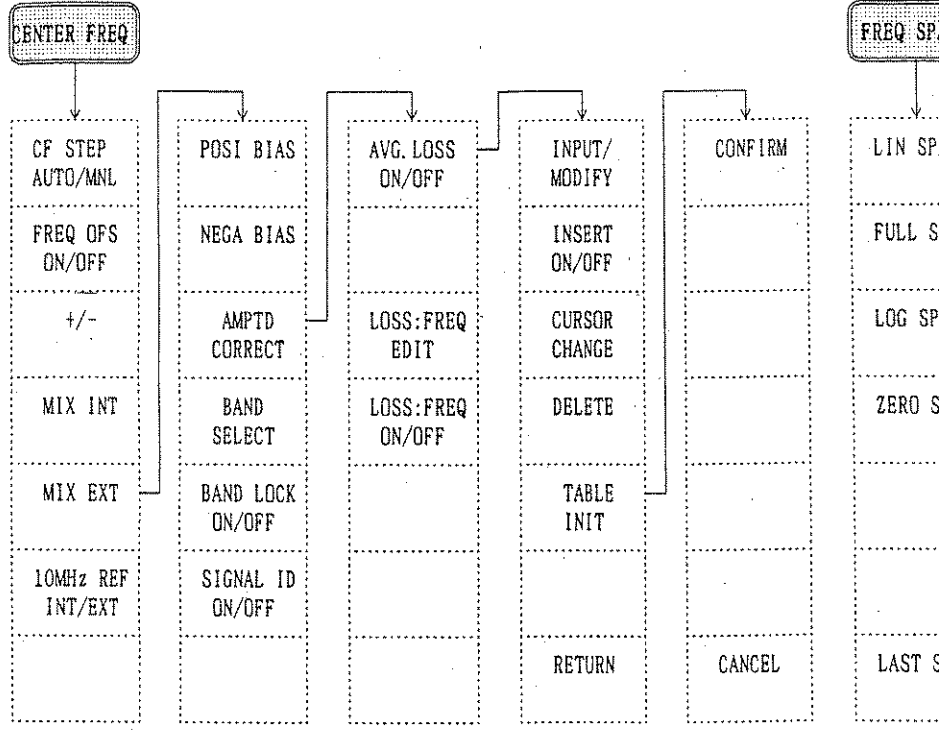

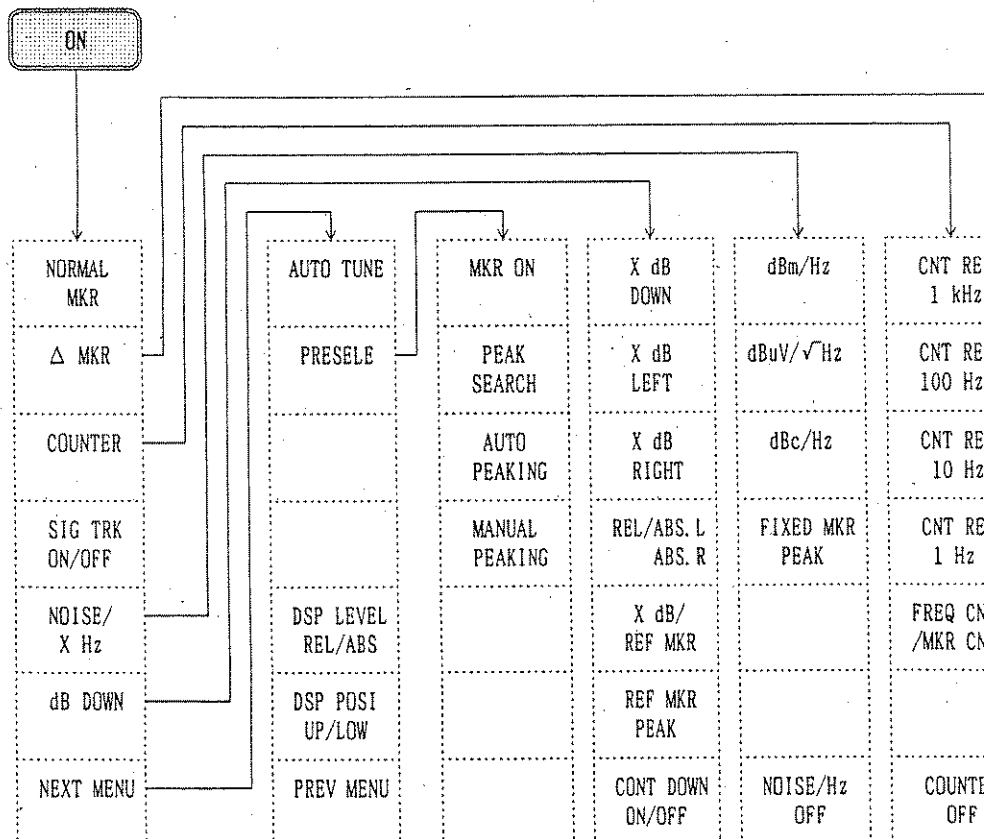
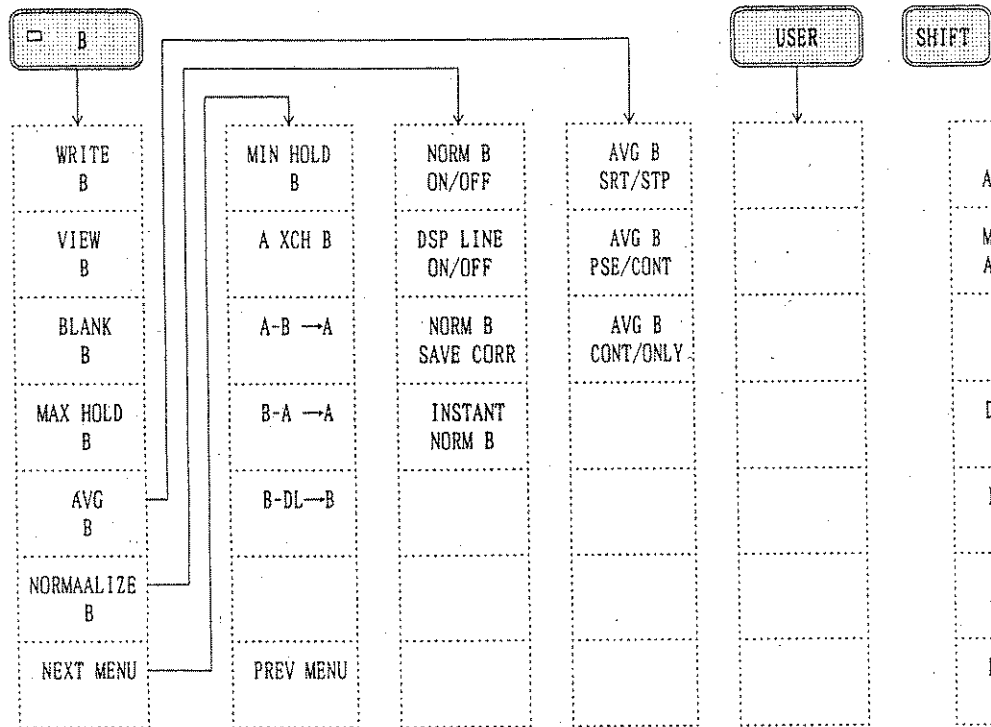

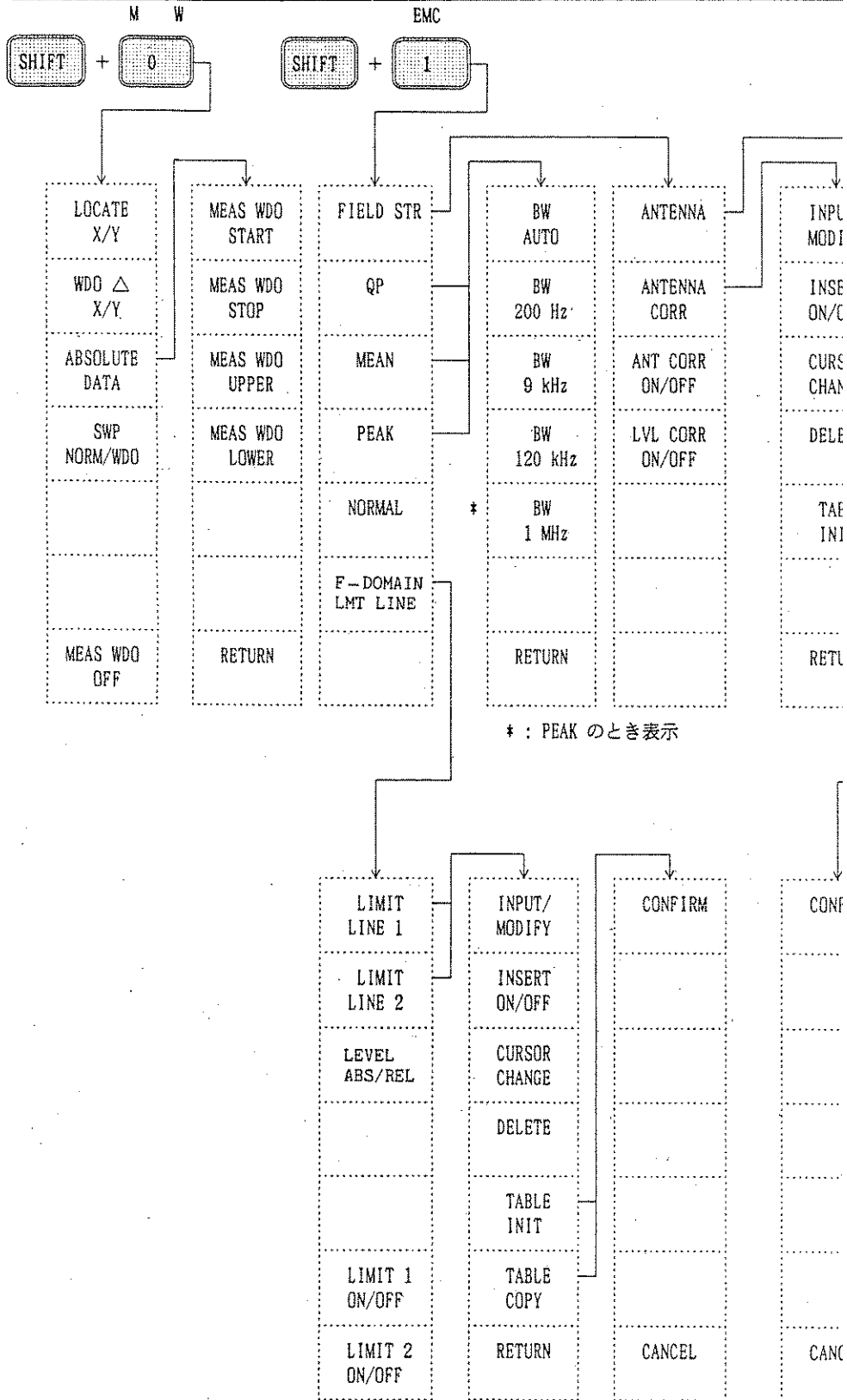

Appendix 4 List of Messages

Messages on the Screen	Description
"A/D calibration failure"	A/D calibration failed.
"All copied" (NOTE message)	All the items have been copied.
"All deleted" (NOTE message)	All the items have been erased.
"Antenna correction mode is OFF"	The antenna correction mode is off.
"Calibration error of AMPTD MAG"	An error was detected in the AMPTD MAG.
"Calibration error of IF STEP AMP"	An error was detected in the IF STEP AMP.
"Calibration error of INPUT ATT"	An error was detected in the INPUT ATT.
"Calibration error of LOG LINEARITY"	An error was detected in the LOG LINEARITY.
"Calibration error of RBW SWITCH"	An error was detected in the RBW SWITCH.
"Calibration error of TOTAL GAIN"	An error was detected in the TOTAL GAIN.
"Calibration signal not detected"	The calibration signal could not be detected.
"Cannot save in this memory area"	Cannot save in this memory area because of write protect.
"Cannot select Trace B while Limit Line On"	The B trace cannot be selected because limit line 1 or 2 is on.
"Caution!! Freq. & Plug-in corr. data abnormal"	The correction data has been destroyed.
"Completed" (NOTE message)	Default vale setting for IP is completed.
"Conversion loss mode is OFF"	The conversion loss mode is off.
"Do you really want to initialize Memory Card?" (REQUEST message)	The system makes sure if you really want to initialize the memory card.
"Do you really want to load Backup data?" (REQUEST message)	The system makes sure if you really want to load the backup data.

Messages on the Screen	Description
"Do you really want to store backup memory?" (REQUEST message)	The system makes sure if you really want to load the backup data to the card.
"File Access completed" (NOTE message)	File access is completed.
"Freq. domain data exists, do you really want to delete it?" (REQUEST message)	The frequency domain data exists. The system makes sure if you really want to delete it.
"Limit line vol. 1 is OFF"	Limit line 1 is off.
"Limit line vol. 2 is OFF"	Limit line 2 is off.
"Marker is inactive"	No marker can be seen.
"Memory Card Access error (Parameter)"	Access failed due to incorrect internal parameters.
"Memory Card Access error (RAM check)"	Access failed due to memory card RAM error.
"Memory Card Access failed (Antenna data)"	The antenna data cannot be accessed.
"Memory Card Access failed (Limit 1 data)"	The limit line 1 data cannot be accessed.
"Memory Card Access failed (Limit 2 data)"	The limit line 2 data cannot be accessed.
"Memory Card Access failed (Loss data)"	The conversion loss data cannot be accessed.
"Memory Card Access failed (Menu data)"	The menu data cannot be accessed.
"Memory Card Access failed (Norm. A data)"	The Normalize A data cannot be accessed.
"Memory Card Access failed (Norm. B data)"	The Normalize B data cannot be accessed.
"Memory card Access failed (Setting Data)"	The setting data cannot be accessed.
"Memory Card Access failed (Soft Protect)"	Access failed due to soft protect (file attribute, etc.).
"Memory Card Access failed (Sum data)"	The check sum data cannot be accessed.
"Memory Card Access failed (Trance A data)"	The A trace data cannot be accessed.

Messages on the Screen	Description
"Memory Card Access failed (Trace B data)"	The B trace data cannot be accessed.
"Memory Card Card access error (FAT)"	Access failed due to file area table error.
"Memory Card Card access error (UAT)"	Access failed due to user area table error.
"Memory Card Data entry overflow"	The number of saved data exceeds the capacity.
"Memory Card Deleted" (NOTE message)	Deletion is completed.
"Memory Card Deletion error (Parameter)"	Deletion failed due to parameter error.
"Memory Card File Access completed" (NOTE message)	STORE/LOAD of the soft menu or the BACKUP MEMORY data is completed.
"Memory card File not found"	The file specified could not be found.
"Memory Card File type unmatched"	The file type did not match.
"Memory Card Init. error (Card size)"	Initialization failed due to incorrect memory card size.
"Memory Card Init. error (Parameter)"	Initialization failed due to incorrect internal parameters.
"Memory Card Init. error (RAM check)"	Initialization failed due to incorrect memory card memory.
"Memory Card Init. error (System Protect)"	The system card cannot be initialized.
"Memory card Initialized" (NOTE message)	Initialization is complete.
"Memory Card Memory Card full"	The memory card is full.
"Memory card Not enough memory, 64KB is required"	The memory card capacity is insufficient to back-up the storage.
"Memory Card Not Initialized"	The memory card has not been initialized.
"Memory Card Password unmatched"	The password was incorrect.

Messages on the Screen	Description
"Memory card Product code unmatched"	The product code of the memory is unmatched.
"Memory Card Write failed (Write Protect)"	Write failed due to write protect.
"Memory protected"	The protect file cannot be accessed.
"Memory table full"	The memory table is full.
"Multi marker list or next peak list is ON"	Label display is impossible because the multi marker list or next peak list is displayed.
"No multi marker list or no next peak list"	No multi marker list or no next peak list is displayed.
"No peak point"	No peak point can be retrieved.
"Not available in QP, MEAN or PEAK mode"	This function is not available in the QP, MEAN or PEAK mode.
"Not available in A avg or A min mode"	This function is not available in the MIN HOLD A or AVG A mode.
"Not available in A max or A avg mode"	This function is not available in the MAX HOLD A or AVG A.
"Not available in A max or A min mode"	This function is not available in the MAX HOLD A or MIN HOLD A.
"Not available in B avg or B min mode"	Execution is impossible for MIN HOLD B or AVG B has been selected.
"Not available in B max or B avg mode"	Execution is impossible for MAX HOLD B or AVG B has been selected.
"Not available in B max or B min mode"	Execution is impossible for MAX HOLD B or MIN HOLD B has been selected.
"Not available in Blank Trace"	Execution is impossible for the trace mode is set to BLANK.
"Not available in Cont. dB Down mode"	Execution is impossible for the Continou dB Down mode is set ON.
"Not available in Counter mode"	Execution is impossible for the Counter mode is set to ON.
"Not available in Diagital IF mode"	Execution is impossible for the display is set to FFT mode.
"Not available in Ext. Mixer mode"	Execution is impossible for the mode is set to Ext. Mixer.
"Not available in High Speed A/D"	Execution is impossible for the mode is set to HIGH SPEED A/D.

Messages on the Screen	Description
"Not available in Linear scale"	Execution is impossible for the mode is set to Linear scale display.
"Not available in Log Span mode"	Execution is impossible for the mode is set to LOG SPAN.
"Not available in Manual Sweep mode"	This function is not available in the MANUAL SWEEP mode.
"Not available in Noise/Hz mode"	This function is not available in the Noise/Hz mode.
"Not available in QP mode"	This function is not available in the QP mode.
"Not available in QP or MEAN mode"	This function is not available in the QP or MEAN mode.
"Not available in Signal Ident mode"	This function is not available in the SIGNAL IDENT mode.
"Not available in Zero Span mode"	This function is not available in the ZERO SPAN mode.
"Not available on baseband frequency"	This function is not available while the marker is on the baseband.
"Not available while Signal Tracking"	This function is not available during SIGNAL TRACK execution.
"Not available Antenna correction is ON"	This function is not available in the ANTENNA CORR mode.
"Plotter is busy or inactive"	The plotter is in operation or inactive status.
"RAM broken (Backup Memory)"	The backup memory RAM has been destroyed.
"RAM broken (Memory Card)"	The memory card RAM has been destroyed.
"Set up data is insufficient Please enter ADJ set up"	No ADJ SET UP data is set or set incorrectly.
"System busy" (NOTE message)	Another processing is being executed.
"Time domain data exists, do you really want to delete it?" (REQUEST message)	The time domain data enterer can be deleted to not?
"VCO calibration failure"	VCO calibration failed.

Messages on the Screen	Description
"Vertical scale factor not correct Select 10 dB/div scale"	The reference scale is set to other than 10dB/div and execution is impossible.
"10MHz reference fixed" (NOTE message)	The reference data is fixed.

ALPHABETICAL INDEX

A			
[A]	5-28	ASCII format	6-21
[A XCH B]	5-32	ATN (Attention)	6-5
[A-B→A]	5-32	[ATT]	5-17
[A-DL→A]	5-33	Auto gain control (AGC)	5-24
[ABSOLUTE DATA]	5-117	[AUTO PEAKING]	5-42
absorption clamp	5-101	[AUTO TUNE]	5-41
Active area	3-4	Auto Tuning	5-41
active marker	5-52	Auto/Manual switching of the output position	5-95
[ACTIVE MKR]	5-53	[AUTO]	5-17
[ADJ 2]	5-114	Average power	4-19
[ADJ GRAPH OFF]	5-114	AVERAGING	5-27
[ADJ GRAPH]	5-113	AVG A CONT/ONLY	5-30
[ADJ POINT]	5-113	[AVG A PSE/CONT]	5-29
[ADJ SETUP CH SP/BS]	5-113	[AVG A SRT/STP]	5-29
adjacent channel leak power	5-112	[AVG A]	5-29
Adjacent spurious	A-4	[AVG LOSS ON/OFF]	5-6
[ALL AUTO]	5-17	B	
[ALL INITIAL]	5-58	[B-A→A]	5-33
[AM AGC ON/OFF]	5-24	Back-up Battery Operation Life	5-67
AM signal	4-6	[BAND LOCK ON/OFF]	5-5
[AM/FM]	5-23	Band Selectivity	A-6
[AMP TD CORRECT]	5-4	[BAND SELECT]	5-5
[AMPTD MAG]	5-89	[BAND SELECT]	5-5
[AMPTD CORRECT]	5-6	Bandwidth Accuracy	A-6
Annotation	3-4	Bandwidth Switching Accuracy	A-6
antenna	5-101	Basic Key Functions	5-2
[ANT CORR ON/OFF]	5-102	Basic Measurement	3-5
[ANTENNA CORR]	5-79	Battery Replacement	5-67
[ANTENNA CORR]	5-102	Binary format	6-21
[ANTENNA OFF]	5-102	[BLANK A]	5-28
[ANTENNA]	5-102		

Block Diagram	8-4*	comments	3-4
burst signal	4-29*	[CONFIRM]	5-108
Bus line	6-4	[CONT PK ON/OFF]	5-45
by serial polling	6-27	[CONT SWP]	5-22
		Controller	6-2
		Correction of the antenna factor	5-102
		C	
CAL	5-89	[COUNT DOWN ON/OFF]	5-41
[CAL ALL]	5-89	[COUNTER OFF]	5-37
[CAL CORR ON/OFF]	5-89	[COUNTER]	5-37
[CAL FREQ REF]	5-90	Couple	5-14
[CAL SIG LEVEL]	5-90	CPL	5-14
Calculation mode	5-32	[CURSOR CHANGE]	5-8
Calibration Function	5-88	[CURSOR DELETE]	5-108
Calibration items	5-88		
Canceling the plot output	5-96		
		D	
[CAPS LOCK OFF]	5-76	DATE	5-111
[CAPS LOCK OFF]	5-99	DATE Function	5-111
[CAPS LOCK ON]	5-99	DAV (Data valid)	6-4
[CAPS LOCK ON]	5-76	[DAY]	5-111
[CENTER FREQ	5-2	[dB DOWN]	5-40
[Center Frequency	5-2	[dBc/Hz]	5-39
[CF STEP AUTO/MNL]	5-3	[dBm/Hz]	5-39
[CHANNEL LIST]	5-72	[dBmV]	5-13
[CHANNEL LIST]	5-83	[dBm]	5-13
Checking Accessories	1-4	[dBpW]	5-13
Checking the Fuse	1-7	[dB μ V/ \sqrt Hz]	5-39
Checking the Power Cable	1-8*	[dB μ Vemf]	5-13
Cleaning	1-6	[dB μ V]	5-13
[CNT RES 100Hz]	5-37	[DEFAULT SET]	5-80
[CNT RES 10Hz]	5-37	[DEFAULT SET]	5-72
[CNT RES 1Hz]	5-37	DEFINE	5-57
[CNT RES 1kHz]	5-37	[DELEE]	5-8

DELETE	5-81	Explanation on the Technical Terms	A-1
[DELETE]	5-108	External Mixer Correction	5-6
[DELETE]	5-72	[EXT]	5-21
[DELETE]	5-58		
Delimiter	6-8		
		F	
Detection mode menu	5-21	[FAST/NORMAL]	5-85
Detection mode of spectrum analysis	5-103	[FIELD STR]	5-102
Diagnosis	7-2*	[FIXED MKR ON/OFF]	5-36
[DIGITAL IF I/II/OFF]	5-18	[FIXED MKR PEAK]	5-39
[DIPOLE]	5-102	Fixed Synchronous Receiver	5-24
display line	5-31	fixed tuning receiver	4-11
drive lamp	5-61	FM modulation index	4-11
[DSP LEVEL REL/ABS]	5-43	FM wave peak shift	4-16
[DSP LINE ON/OFF]	5-31	[FREE RUN]	5-20
[DSP POSI UP/LOW]	5-43	[FREQ CNT/MKR CNT]	5-37
		[FREQ CORR ON/OFF]	5-89
		[FREQ OFS ON/OFF]	5-11
E			
[EACH ITEM]	5-89	FREQ SPAN	5-9
eject button	5-61	frequency counter mode	4-3
Electromagnetic compatibility	A-1	Frequency Response	A-3
Electromagnetic interference	A-1	frequency shift	4-11
EMC	5-102	Frequency Span	5-9
EMC Function	5-101	Front Panel	2-2
Entering a data table	5-104	[FRWQ OF SON/OFF]	5-3
[ENTER]	5-58	[FULL SPAN]	5-10
envelope	4-19		
Environmental Conditions	1-5	G	
[EOI (End of identify)]	6-5	Gain Compression	A-2
[EVEN FIELD]	5-21	Gated Sweep function	4-29*
EXAMPLES OF MEASUREMENT	4-2	GPIB	6-1
Executing the plot output	5-96	GPIB Address Setting	6-8
Explanation of the List	5-71	GPIB connector	6-5

GPIB extension and compatibility	6-2	INSPECTION	7-1
GPIB Setting	6-8	[INSTANT NORM A]	5-31
GPIB Specifications	6-4	Intensity of radiation interfering electric field	5-101
[GROUP ACTIVE]	5-57	Interfering power	5-101
[GROUP ACTIVE]	5-58	Internal back-up memory	5-65
H		L	
Higher Harmonic Spurious	A-4	LABEL	5-98
[HOUR]	5-111	[LABEL CLEAR]	5-100
How to Handle the Memory Card	5-67	[LABEL CLEAR]	5-77
I		Label Function	5-98
IF Bandwidth	A-1	[LAST SPAN]	5-10
[IF STEP AMPTD]	5-89	Last State	5-87
IFC (Interface clear)	6-5	Last State	5-86
[INITIAL GROUP]	5-58	Level Scalings	A-8
Initialize the Memory Card	5-61	[Limit Line 1]	5-105
Initializing the Memory Card	5-60	[Limit 1 ON/OFF]	5-105
Initializing the saved data	5-80	[Limit 2 ON/OFF]	5-105
[INPUT ATT]	5-89	[Limit Line 2]	5-105
[INPUT 50/75Ω]	5-26	Limit Line Function	5-104
Input and Output of Trace Data	6-20	[LIMIT LINE]	5-79
Input Attenuator	5-17	[LINEAR SPAN]	5-10
Input Format (Listener)	6-9	[LINEAR]	5-12
[INPUT RF/PI]	5-26	[LINE]	5-20
[INPUT/MODIFY]	5-108	List of GPIB Codes	6-34
[INPUT/MODIFY]	5-7	List of Saved Data	5-70
Input/Output Format	6-8	Listener	6-2
[INSERT ON/OFF]	5-7	Listing in the Order of Levels	5-48
[INSERT ON/OFF]	5-108	[LO.SWP 2V/GHz]	5-26
Inserting and Removing the Memory Card	5-61	Loading the title of the saved data	5-76
		[LOCATE AUTO/MNL]	5-95

[LOCATE X/Y]	5-116	[MEAS WD0 LOWER]	5-117
[LOCATION]	5-95	[MEAS WD0 OFF]	5-117
[LOG LINEAR]	5-89	[MEAS WD0 START]	5-117
[LOG PERD]	5-102	[MEAS WD0 STOP]	5-117
[LOG SPAN]	5-10	[MEAS WD0 UPPER]	5-117
[LOSS TABE]	5-79	Measurement Window Function	5-115
[LOSS: FREQ EDIT]	5-7	Measuring Adjacent Channel	4-24
[LOSS: FREQ EDIT]	5-6	Measuring FM Wave	4-11
[LOSS: FREQ ON/OFF]	5-6	Measuring Frequency	4-2
[LOSS:FREQ EDIT]	5-6	Measuring pulse-modulated wave	4-19
[LOW NOISE ON/OFF]	5-13	Measuring the Noise/Hz	5-38
[LVL CORR ON/OFF]	5-102	Measuring the power source terminal voltage	5-109
		[MEGA BIAS]	5-4
		[MEMBER ACTIVE]	5-57
		[MEMBER ACTIVE]	5-58
		Memory A	5-28
		Memory B	5-28
		Memory Card	5-60
		Menu Keys	5-20
		Menu Lists	A-9
		[MENU]	5-20
		[MIN ATT ON/OFF]	5-18
		MIN HOLD	5-27
		[MIN HOLD A]	5-32
		[MIN]	5-111
		[MIN]	5-45
		[MIX EXT]	5-4
		[MIX EXT]	5-3
		[MIX INT]	5-3
		[MKR * ON/OFF]	5-53
		[MKR LIST ON/OFF]	5-53
M			
Main lobe	4-19		
[MANUAL PEAKING]	5-42		
[MANUAL SWP]	5-22		
Marker counter mode	4-5		
Marker OFF	5-51		
Marker ON	5-34		
MARKER Section	5-34		
Marker to	5-50		
Marker →	5-50		
[MARK]	5-99		
[MARK]	5-77		
MAX HOLD	5-27		
[MAX HOLD A]	5-29		
MAX HOLD mode	5-29		
Maximum Input Level	A-2		
Maximum Input Sensitivity	A-2		
mean value detection	5-103		
[MEAN]	5-103		

[MKR No.]	5-53	Noise level measurement mode	5-38
[MKR ON]	5-42	noise power bandwidth	5-38
[MKR PAUSE ON/OFF]	5-22	Noise Sideband	A-5
[MKR PAUSE TIME]	5-23	[NOISE/X Hz]	5-39
[MKR STEP AUTO/MNL]	5-51	Non-higher Harmonic Spurious	A-4
[MKR Δ \rightarrow CF STEP]	5-51	[NORM A ON/OFF]	5-31
[MKR Δ \rightarrow CF]	5-51	[NORM A SAVE CORR]	5-31
MKR \rightarrow	5-50	[NORM/UP/LOW]	5-47
[MKR \rightarrow CF STEP]	5-51	normal marker	4-2
[MKR \rightarrow CF]	5-50	Normal marker	5-34
[MKR \rightarrow MKR STEP]	5-51	[NORMAL MKR]	5-34
[MKR \rightarrow REF]	5-50	[NORMALIZE A]	5-31
[MKR Δ \rightarrow MKR STEP]	5-51	[NORMALIZE CORR]	5-79
[MKR Δ \rightarrow SPAN]	5-50	Normalize mode	5-31
Modifying the Peak Search Level	5-47	[NORMAL]	5-103
modulation frequency	4-6	NRFD (Not ready for data)	6-4
modulation index	4-6		
[MONTH]	5-111		
Multi Marker function	5-52		
Multi Marker Listing	5-52		
MW	5-115		
		O	
		[OBW]	5-113
		occupied bandwidth	5-112
		Occupied Bandwidth	A-3
		Occupied Bandwidth	4-21
		[ODD FIELD]	5-21
		ON	5-34
		[ON(1/2/3)/OFF]	5-111
		[ON/OFF]	5-23
		OPERATION DESCRIPTION	8-2
		Outline of the Analyzer	5-34
		Outline of the Analyzer	1-2
		Output Format (Talker)	6-15
N			
NDAC (Not data accepted)	6-4		
NEGA mode	5-27		
Negative peak detection	5-21		
[NEGA]	5-21		
[NEXT MIN]	5-45		
[NEXT PK LEFT]	5-45		
[NEXT PK MAX/MIN]	5-45		
[NEXT PK RIGHT]	5-45		
[NEXT PK]	5-44		

P			
PANELS	2-1	Precautions when handling Memory card	5-68
[PBW]	5-89	Preselector	5-42
PEAK	5-44	[PRESELE]	5-42
Peak List Display	5-48	Preset	5-86
[PEAK LIST ON/OFF]	5-48	PRESET	5-80
Peak power	4-19	[PREV MENU]	5-33
Peak Search	5-44	[PREV MENU]	5-79
[PEAK SEARCH]	5-42	Protection switch	5-61
Peak value detection	5-103	Pulse repetition frequency	4-19
[PEAK Δ XY]	5-45	Pulse width	4-19
[PEAK]	5-103, 5-114	Q	
[PLOT CANCEL]	5-96	[QP]	5-103
[PLOT DIVISION]	5-94	Quasi peak detection	5-103
[PLOT EXECUTE]	5-96	Quasi Peak Value Measurements	A-3
[PLOT FORM]	5-94, 5-95	quasi-power source circuit	5-101
[PLOT MODE]	5-93	R	
Plot Output Function	5-91	R3265 Specifications	9-2
[PLOT SIZE]	5-94	R3271 Specifications	9-9
Plotter Operation Procedure	5-92	[RBW 120kHz]	5-103
Plotter Pen Assignment	5-97	[RBW 1MHz]	5-103
[PLOTTER TYPE]	5-93	[RBW 9kHz]	5-103
Plotters which can be connected	5-91	[RBW AUTO]	5-103
[POSI BIAS]	5-4	[RBW SWITCH]	5-89
POSI mode	5-27	[RBW:SPAN ON/OFF]	5-18
[POSI-NEGA]	5-21	[RBW]	5-14
Positive peak detection	5-21	Rear Panel	2-7
POSI]	5-21	[REAR PNL OUTPUT]	5-26
Power	4-24	RECALL	5-82
Power requirement	1-7	Recall Data in Detail	5-83
Power Source	1-7		

[RECALL EXECUTE]	5-82	[SAVE TITLE]	5-76
[RECALL EXECUTE]	5-83	Saving and Reading Memory Data	5-65
Recall function	5-82	Saving Data	5-73
Recall Function	5-69	Saving/Recalling the Soft Menu	5-60
REF LEVEL	5-12	[SEC ADJ]	5-111
[REF MKR PEAK]	5-41	Select the number of pens	5-94
[REF OFS ON/OFF]	5-13	Select the plot mode	5-93
Reference Level	5-12	Select the plotter	5-93
Reference Level Display Accuracy	A-2	Select the plotter form size	5-94
[REL/ABS.L /ABS.R]	5-40	Select the screen to be output	5-95
REMOTE PROGRAMMING	6-1	Select the table type	5-93
REN (Remote enable)	6-5	Selecting the Recall Data Mode	5-85
[REN]	5-94	Self check	3-5
[RESET SWP]	5-22	Service Request (SRQ)	6-27
Residual FM	A-2	Setting $\Delta X/\Delta Y$	5-45
Residual Response	A-3	Setting the External Mixer Conditions	5-4
Resolution Bandwidth	5-14	Setting the Plotter	5-92
		Setting X dB Down	5-40
		Side lobe	4-19
S		[SIG TRK ON/OFF]	5-38
Sample detection	5-21	[SIGNAL ID ON/OFF]	5-5
SAMPLE mode	5-27	Signal Track Mode	5-38
[SAMPLE]	5-21	[SINGLE SWP]	5-22
SAVE	5-72	Sound menu	5-23
[SAVE EXECUTE]	5-72	[SOUND OFF]	5-24
Save Function	5-70	[SOUND]	5-23
Save Function	5-69	[SPACE]	5-100
SAVE ITEM	5-73	[SPACE]	5-77
[SAVE ITEM]	5-72	span	5-9
[SAVE ITEM]	5-78, 5-79	SPECIFICATIONS	9-1
Save Menu	5-72	Specifications of the Memory Card	5-68
[SAVE TITLE]	5-72		

specified bandwidth	4-24	Trigger Menu	5-20
Spurious	A-4	[TRIG]	5-20
Spurious Response	A-4	TV signal (NTSC)	5-20
SQUELCH]	5-23	[TV-H]	5-20
SRQ (Service request)	6-5	[TV-V]	5-20
START	5-11		
Start Frequency	5-11	U	
status bit	6-27	[UNITS]	5-13
STOP	5-11	USER	5-57
Stop Frequency	5-11	User-Defined Function	5-57
Storage	1-6	using a quasi-power source circuit	5-109
Sweep mode menu	5-22	UTIL	5-113
[SWEEP MODE]	5-118	Utility function	5-112
[SWEEP MODE]	5-22		
[SWP NORM/MD0]	5-118	V	
[SWP NORM/WD0]	5-116	[VBW:RBW ON/OFF]	5-18
[SWP]	5-16	[VBW]	5-16
		Video Bandwidth	5-15
T		[VIDEO]	5-20
[TABLE COPY]	5-108	[VIEW A]	5-28
[TABLE INIT]	5-8	VIEW mode	5-28
[TABLE]	5-93	Voltage of the power source terminal	5-101
Talker	6-2	[VOLTS]	5-13
[TOTAL GAIN]	5-89	[VOLUME]	5-23
[TR17203]	5-102	VSWR: Voltage Standing Wave Ratio	A-7
TRACE	5-27		
[TRACE DET]	5-21		
Trace memory	5-27		
Trace mode	5-28		
Trace output range specification	6-21		
[TRACE]	5-79		
Transportation	1-6		

	W	[+/-]	5-3
[WATTS]	5-13	[+/-]	5-11
waveform calculation function	5-27	[1/ Δ MKR ON/OFF]	5-36
[WD0 Δ XY]	5-116	[10 MHz REFINT/EXT]	5-4
[WINDOW SWP]	5-118	[×10]	5-12
[WINDOW SWP]	5-22	[×1]	5-12
[WRITE A]	5-28	[×2]	5-12
WRITE mode	5-28	[×5]	5-12
[WRITE PROTECT]	5-77	[Δ MKR]	5-35
[WRITE PROTECT]	5-72	[Δf peak	4-16
		[ΔX and ΔY Resolution	5-46
	X		
[X AXIS]	5-26		
[X dB DOWN]	5-40		
[X dB LEFT]	5-40		
[X dB REF MKR	5-41		
[X dB RIGHT]	5-40		
[x dB/div]	5-12		
	Y		
[YEAR]	5-111		
YIG-tuned Oscillator	A-7		
	Z		
Zero Span	A-3		
[ZERO SPAN]	5-10		

GPIB CORD INDEX

	6-67	AGP	6-47
0 to 9	6-67	AGR	6-47
		AGS	6-47
A		AH1	6-7
AA	6-40	AI	6-48
AA?	6-40	AL	6-40
AAVG *	6-47	AL?	6-40
AAVG?	6-47	AM	6-47
AB	6-47	AMAX	6-47
ABA	6-48	AMIN	6-47
ABLANK	6-47	AN	6-47
AC	6-40	AN OFF	6-48
ACHB	6-48	AN ON	6-47
AD?	6-50	AN0	6-61
ADBS *	6-66	AN1	6-61
ADBS?	6-66	AN2	6-61
ADCH *	6-66	ANCORR OFF	6-61
ADCH?	6-66	ANCORR ON	6-61
ADG	6-66	ANCORR?	6-61
ADG OFF	6-66	ANF	6-48
ADH?	6-66	ANN	6-47
ADJ	6-66	ANNOT OFF	6-45
ADLA	6-48	ANNOT ON	6-45
AF	6-61	ANNOT?	6-45
AG *	6-47	ANORM	6-47
AG0	6-47	ANORM OFF	6-48
AG1	6-47	ANORM ON	6-47
AG?	6-47	ANT OFF	6-61
AGC	6-47	ANT0	6-61
AGL OFF	6-35	ANT1	6-61
AGL ON	6-35	ANT2	6-61
AGL?	6-35	ANT?	6-60

AR	6-48	BBLANK	6-49
AS	6-40	BDLB	6-50
AS?	6-40	BG *	6-49
AT *	6-40	BG0	6-49
AT?	6-40	BG1	6-49
ATAUTO	6-40	BG?	6-49
ATAUTO?	6-40	BGC	6-49
ATMIN *	6-40	BGP	6-49
ATMIN OFF	6-40	BGR	6-49
ATMIN ON *	6-40	BGS	6-49
ATMIN?	6-40	BI	6-50
ATT *	6-40	BM	6-49
ATT?	6-40	BMAX	6-49
AUNITS DBM	6-38	BMIN	6-49
AUNITS DBMV	6-38	BN	6-49
AUNITS DBUV	6-39	BN OFF	6-49
AUNITS V	6-39	BN ON	6-49
AUNITS W	6-39	BND *	6-35
AUNITS?	6-38	BND?	6-35
AV	6-47	BNDLC OFF	6-35
AVIEW	6-47	BNDLC ON	6-35
AW	6-47	BNDLC?	6-35
AWRITE	6-47	BNF	6-49
AXIS	6-46	BNN	6-49
		BNORM	6-49
		BNORM OFF	6-49
		BNORM ON	6-49
BA	6-40	BR	6-50
BA?	6-40	BS	6-67
BAA	6-48	BV	6-49
BANG?	6-49	BVIEW	6-49
BAVG *	6-49	BW	6-49
BB	6-49		

B

BWRITE	6-49	CLCORR?	6-64
		CLG	6-63
		CLLOG	6-63
		CLMAG	6-63
		CLN *	6-63
		CLPBW	6-63
		CLRBW	6-63
		CLREF *	6-63
		CLSTEP	6-63
		CLTOTAL	6-63
		CM?	6-60
		CMA	6-60
		CMB	6-60
		CN OFF	6-53
		CN ON	6-52
		CN0	6-53
		CN1	6-53
		CN2	6-53
		CN3	6-53
		CN?	6-52
		CNF	6-53
		CO	6-40
		COALL	6-40
		COALL?	6-40
		COAUTO	6-40
		CONTS	6-43
		CORS *	6-41
		CORS ?	6-41
		CORS OFF	6-41
		CORS ON *	6-41
		COUNT OFF	6-53
		COUNT ON	6-52

C

C0	6-7
CA	6-34
CA?	6-34
CAL	6-62
CARD	6-66
CC OFF	6-64
CC ON	6-64
CC?	6-64
CCF	6-64
CD	6-67
CDB OFF	6-55
CDB ON	6-55
CDB?	6-54
CENTER *	6-34
CENTER?	6-34
CF *	6-34
CF?	6-34
CFSTEP *	6-34
CFSTEP?	6-34
CH	6-48
CHD ON	6-45
CHD?	6-45
CL *	6-63
CL?	6-63
CLA	6-62
CLALL	6-62
CLATT	6-63
CLCORR OFF	6-64
CLCORR ON	6-64

			D	
COUNT?	6-52			
COUPLE	6-40	DB		6-67
COVR *	6-41	DBABSL		6-54
COVR OFF	6-41	DBABSR		6-54
COVR ON *	6-41	DBDOWN *		6-54
COVR?	6-41	DBLEFT *		6-54
CP OFF	6-58	DBREL		6-54
CP ON	6-58	DBRIGHT *		6-54
CP?	6-58	DC1		6-7
CPF	6-58	DC1		6-54
CPN	6-58	DC2		6-54
CR OFF	6-61	DC?		6-54
CR ON	6-61	DCO		6-54
CR?	6-61	DD *		6-37
CRDEL	6-61	DD1		6-69
CRF	6-61	DD?		6-37
CRIN *	6-61	DET NEG		6-43
CRN	6-61	DET NRM		6-42
CS *	6-34	DET POS		6-42
CS?	6-34	DET SMP		6-43
CSAUTO	6-34	DET?		6-42
CSAUTO?	6-34	DHC OFF		6-45
CT OFF	6-53	DIV *		6-37
CT ON	6-52	DIV?		6-37
CT?	6-52	DL *		6-45
CTFR	6-53	DL OFF		6-45
CTMD?	6-53	DL ON *		6-45
CTMK	6-53	DL0		6-69
CU	6-67	DL0		6-8
CWA	6-48	DL1		6-69
CWB	6-50	DL2		6-8
		DL2		6-69

R3265/3271
SPECTRUM ANALYZER
INSTRUCTION MANUAL

GPIB Cord Index

DL3	6-69	FB?	6-36
DL3	6-8	FC OFF	6-64
DL4	6-8	FC ON	6-64
DL4	6-69	FC?	6-64
DL?	6-45	FCCORR OFF	6-64
DLF	6-45	FCF	6-64
DLN *	6-45	FCN	6-64
DM?	6-42	FD	6-67
DN	6-67	FFT OFF	6-41
DS	6-59	FFT ON	6-41
DT1	6-7	FFT1	6-41
DTG	6-43	FFT2	6-41
DTMD?	6-42	FFT?	6-41
DTN	6-42	FIX OFF	6-52
DTP	6-42	FIX ON	6-52
DTS	6-43	FIX?	6-52
DX *	6-58	FLSP	6-36
DX?	6-58	FO *	6-34
DY *	6-58	FO OFF	6-34
DY?	6-58	FO ON *	6-34
		FO?	6-34
		FOF	6-34
		FON *	6-34
E1	6-7	FP *	6-36
EMC	6-60	FP?	6-36
ENT	6-68	FR	6-42
EX	6-42	FRCORR ON	6-64
EXT	6-42	FRCORR?	6-64
		FRD OFF	6-46
		FRD ON	6-46
		FRD?	6-46
		FREE	6-42

FROFS *	6-34	IT0	6-63
FROFS OFF	6-34	IT1	6-63
FROFS ON *	6-34	IT2	6-63
FROFS?	6-34	IT3	6-63
FS	6-36	IT4	6-63
FT *	6-36	IT6	6-63
FT?	6-36		
FU	6-67		
		K	
FX OFF	6-52	KSa	6-42
FX ON	6-52	KSA	6-38
FX?	6-52	KSb	6-42
FXP	6-54	KSB	6-38
		KSC	6-39
		KSd	6-43
	G	KSD	6-39
GF	6-46	KSe	6-43
GN	6-46	KZ	6-67
GPL?	6-69		
GR OFF	6-46		
GR ON	6-45		
		L	
GR?	6-45	L4	6-7
GRAT OFF	6-46	LAF	6-62
GRAT ON	6-45	LAN	6-62
GRAT?	6-45	LB OFF	6-66
GZ	6-67	LB ON****/	6-66
		LB?	6-66
		LBF	6-62
	H	LBN	6-62
HD0	6-69	LC	6-50
HZ	6-67	LG	6-36
		LGA *	6-36
	I	LGA?	6-36
IN?	6-46	LGB *	6-36
IP	6-51		

LGB?	6-36	LMTBIN *	6-62
LGSRT *	6-36	LN1	6-37
LGSRT?	6-36	LN10	6-38
LGSTART *	6-36	LN2	6-38
LGSTART?	6-36	LN5	6-38
LGSTOP *	6-36	LN?	6-37
LGSTOP?	6-36	LNI OFF	6-39
LGSTP *	6-36	LNI ON	6-39
LGSTP?	6-36	LNI?	6-39
LI	6-42	LOCAL	6-50
LIN1	6-37	LOF	6-66
LIN10	6-38	LOGSP	6-36
LIN2	6-38	LON/**/	6-66
LIN5	6-38	LOSWP	6-46
LIN?	6-37	LS *	6-36
LINE	6-42	LS?	6-36
LINSP *	6-36	LTSP	6-36
LINSP?	6-36	LVCORR OFF	6-61
LL1	6-37	LVCORR ON	6-61
LL10	6-38	LVCORR?	6-61
LL2	6-38	LVF OFF	6-35
LL5	6-38	LVF ON	6-35
LL?	6-37	LVF?	6-35
LMTA OFF	6-62	LVFDEL	6-35
LMTA ON	6-62	LVFIN *	6-35
LMTA?	6-62		
LMTADEL	6-62		
LMTAIN *	6-62	M	
LMTB OFF	6-62	M1	6-59
LMTB ON	6-62	M2	6-59
LMTB?	6-62	M3	6-59
LMTBDEL	6-62	MANSWP	6-43
		MC	6-58

MCINIT	6-66	MKPK HI	6-57
MCLOAD	6-66	MKR OFF	6-55
MCSTORE	6-66	MKR ON *	6-51
MDA	6-55	MKR?	6-51
MDL	6-55	MKRL	6-59
MDR	6-55	MKS *	6-59
MDU	6-55	MKS?	6-59
ME	6-41	MKSAUTO	6-59
MENU	6-41	MKSAUTO?	6-59
MF	6-55	ML?	6-51
MF or MO	6-55	ML?	6-56
MF?	6-56	MLF1	6-55
MF?	6-51	MLF2	6-55
MFL?	6-52	MLF3	6-55
MFL?	6-57	MLF4	6-56
MG	6-58	MLF5	6-56
MIN	6-58	MLF6	6-56
MIS	6-58	MLF7	6-56
MK *	6-52	MLF8	6-56
MK?	6-52	MLN1 *	6-55
MKCF	6-58	MLN2 *	6-55
MKCS	6-59	MLN3 *	6-55
MKD *	6-52	MLN4 *	6-56
MKDLT *	6-52	MLN5 *	6-56
MKDLT?	6-52	MLN6 *	6-56
MKMKS	6-59	MLN7 *	6-56
MKN *	6-51	MLN8 *	6-56
MKN *	6-52	MLSF?	6-57
MKNORM *	6-52	MLSL?	6-57
MKNORM?	6-52	MLT	6-55
MKOFF	6-55	MLT?	6-55
MKPK	6-57	MML	6-66

MMS	6-66	MXP?	6-35
MN *	6-51	MXPOSI *	6-35
MN* or MK*	6-55	MXPOSI ?	6-35
MN?	6-51	MZ	6-67
MND OFF	6-69		
MND ON	6-69		
MND?	6-69		
MO	6-55	NI *	6-53
MO	6-59	NI OFF	6-54
MPA	6-59	NI?	6-53
MPA?	6-59	NIC	6-54
MPM *	6-59	NIDBC	6-54
MPM?	6-59	NIDBM	6-53
MR	6-59	NIDBU	6-54
MS	6-68	NIF	6-54
MT *	6-52	NIM	6-53
MT?	6-52	NIU	6-54
MTCF	6-59	NKPK NH	6-57
MTCS	6-59	NKPK NL	6-57
MTMKS	6-59	NKPK NR	6-57
MTSP	6-59	NMM	6-58
MV	6-67	NOISE *	6-53
MW	6-67	NOISE OFF	6-54
MXE	6-35	NOISE?	6-53
MXEXT	6-35	NXL	6-57
MXI	6-34	NXLEFT	6-57
MXINT	6-34	NXM	6-58
MXN *	6-35	NXMAXMIN	6-58
MXN?	6-35	NXMIN	6-58
MXNEGA *	6-35	NXP	6-57
MXNEGA?	6-35	NXPEAK	6-57
MXP *	6-35	NXR	6-57
		NXRIGHT	6-57

N

O			
		PLPEN4	6-65
OBW *	6-66	PLPEN6	6-65
OBW?	6-66	PLPEN8	6-65
OHM50	6-46	PLPIC1	6-65
OHM75	6-46	PLPIC2	6-65
OHM?	6-46	PLPIC4	6-65
		PLRIGHT	6-65
P		PLS OFF	6-58
PAUSE *	6-44	PLS ON	6-58
PAUSE OFF	6-44	PLS?	6-58
PAUSE ON *	6-44	PLT	6-65
PAUSE?	6-44	PLTRACE	6-64
PI	6-46	PLTYPEA	6-64
PLA3	6-65	PLTYPEB	6-64
PLA4	6-65	PLTYPEC	6-64
PLALL	6-64	PLTYPED	6-64
PLANT	6-65	PLTYPEE	6-64
PLAUTO	6-65	PP0	6-7
PLCHAR	6-64	PPA	6-55
PLGRAT	6-64	PPM *	6-55
PLLEFT	6-65	PS	6-57
PLLMTA	6-65	PSL	6-58
PLLMTB	6-65	PSN	6-58
PLLO WRIGHT	6-65	PSU	6-58
PLLOSS	6-65	PU *	6-44
PLLOWLEFT	6-65	PU OFF	6-44
PLMAN	6-65	PU ON *	6-44
PLMID	6-65	PU?	6-44
PLMKR	6-64	PUF	6-44
PLMULTI	6-65	PUN *	6-44
PLOT	6-65	PWAK	6-57
PLPEN1	6-65		

Q				
QA		6-62	REDLT ON	6-52
QA?		6-62	REDLT?	6-52
QF		6-61	REF *	6-37
QN		6-61	REF?	6-37
QP OFF		6-61	REFOFS *	6-39
QP ON		6-61	REFOFS OFF	6-39
QP0		6-62	REFOFS ON*	6-39
QP1		6-62	REFOFS?	6-39
QP2		6-62	REV?	6-69
QP3		6-62	RF	6-50
QP?		6-61	RFE	6-35
QPAUTO		6-62	RFI	6-35
QPAUTO?		6-62	RFIN	6-46
			RL *	6-37
			RL1	6-7
			RL?	6-37
R				
RB *		6-40	RN *	6-50
RB?		6-40	RO *	6-39
RBAUTO		6-40	RO OFF	6-39
RBAUTO?		6-40	RO ON *	6-39
RBW *		6-40	RO?	6-39
RBW?		6-40	ROF	6-39
RC *		6-50	RON *	6-39
RC?		6-50		
RCFAST *		6-50		
RCNORM *		6-50		
RE *		6-37		
RE?		6-37		
RECALL *		6-50		
RECALL?		6-50		
REDLT		6-52		
REDLT OFF		6-52		
			S	
			S0	6-27
			S0	6-69
			S1	6-27
			S1	6-69
			S2	6-27
			S2	6-69
			SAM	6-44

R3265/3271
SPECTRUM ANALYZER
INSTRUCTION MANUAL

Alphabetical Index

SAVE *	6-51	SH4	6-66
SC	6-68	SH7	6-62
SD AM	6-44	SH8	6-64
SD FM	6-44	SH9?	6-66
SD OFF	6-44	SHLC?	6-50
SD?	6-43	SHRC *	6-51
SDAGC ON	6-44	SHTA	6-48
SDAGC?	6-44	SHTB	6-50
SDMD?	6-43	SI	6-43
SDV *	6-44	SIG OFF	6-53
SDV?	6-44	SIG ON	6-53
SDVOL *	6-44	SIG?	6-53
SDVOL?	6-44	SIGID OFF	6-35
SDW	6-43	SIGID ON	6-35
SF1	6-67	SIGID?	6-35
SF2	6-67	SM	6-43
SF3	6-67	SN	6-43
SF4	6-67	SNGLS	6-43
SF5	6-67	SOF	6-44
SF6	6-67	SON	6-44
SF7	6-67	SP *	6-36
SFM	6-44	SP?	6-36
SQ OFF	6-53	SPAN *	6-36
SG ON	6-53	SPAN?	6-36
SG?	6-53	SPM?	6-36
SGF	6-53	SPMD?	6-36
SGN	6-53	SQE *	6-44
SH0	6-59	SQE OFF	6-44
SH0?	6-59	SQE ON *	6-44
SH1	6-60	SQE?	6-44
SH1	6-7	SR	6-43
SH3	6-66	SR1	6-7

UE	6-39	VI	6-42
UEMF	6-39	VIDEO	6-42
UM	6-38	VN	6-44
UN?	6-38	VX	6-44
UNIT?	6-38		
UP	6-67		
		W	
UR	6-50	WDO	6-59
UR1	6-50	WDO?	6-59
UR2	6-50	WDO OFF	6-59
UR3	6-50	WDO ON	6-59
UR4	6-50	WDODX?	6-60
UR5	6-50	WDODY?	6-60
UR6	6-50	WDOLOW	6-60
UR7	6-50	WDOLOW *	6-60
US	6-68	WDOLX?	6-60
USER	6-50	WDOLY?	6-60
UU	6-39	WDOSRT *	6-60
UULT	6-39	WDOSRT?	6-60
UW	6-39	WDOSTP *	6-60
UWAT	6-39	WDOSTP?	6-60
		WDOSWP OFF	6-43
		WDOSWP ON	6-43
		WDOUP *	6-60
		WDOUP?	6-60
		WDX?	6-60
		WDY?	6-60
		WF	6-59
		WLL *	6-60
		WLL?	6-60
		WLX?	6-60
		WLY?	6-60
		WN	6-59

V

WN?	6-59
WPF *	6-60
WPF?	6-60
WTF *	6-60
WTF?	6-60
WUL *	6-60
WUL?	6-60

X

XDB *	6-54
XDL *	6-54
XDR *	6-54

Z

ZROSP	6-36
ZS	6-36

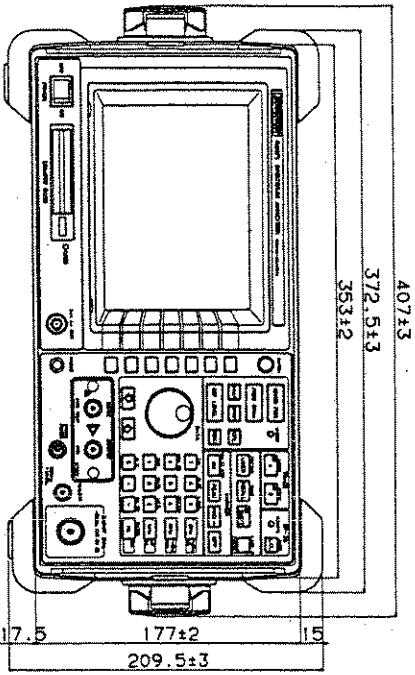

FRONT VIEW

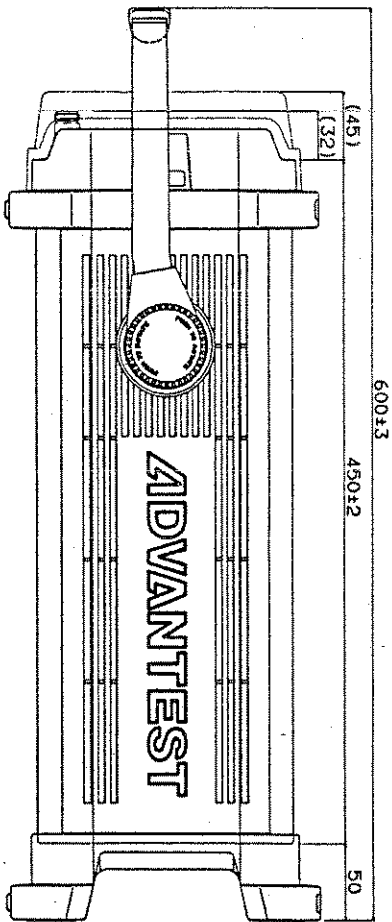

SIDE VIEW

Unit : mm

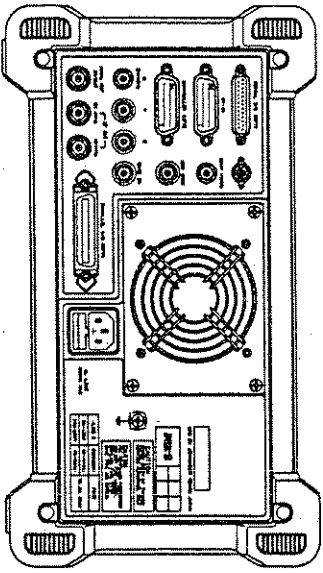

R3271 EXT 1-9011-A

R3271 R3265
EXTERNAL VIEW