

**MODEL
373XXA
VECTOR NETWORK ANALYZER
OPERATION MANUAL**

Software Version: 3.30

The Anritsu logo is rendered in a bold, sans-serif font. It is flanked by two horizontal lines on each side, which are part of a larger graphic element consisting of multiple parallel lines extending across the width of the page.

490 JARVIS DRIVE | MORGAN HILL, CA 95037-2809

P/N: 10410-00183
REVISION: G
PRINTED: FEBRUARY 2000
COPYRIGHT 1996 ANRITSU CO.

WARRANTY

The ANRITSU product(s) listed on the title page is (are) warranted against defects in materials and workmanship for one year from the date of shipment.

ANRITSU's obligation covers repairing or replacing products which prove to be defective during the warranty period. Buyers shall prepay transportation charges for equipment returned to ANRITSU for warranty repairs. Obligation is limited to the original purchaser. ANRITSU is not liable for consequential damages.

LIMITATION OF WARRANTY

The foregoing warranty does not apply to ANRITSU connectors that have failed due to normal wear. Also, the warranty does not apply to defects resulting from improper or inadequate maintenance by the Buyer, unauthorized modification or misuse, or operation outside of the environmental specifications of the product. No other warranty is expressed or implied, and the remedies provided herein are the Buyer's sole and exclusive remedies.

TRADEMARK ACKNOWLEDGEMENTS

V Connector and K Connector are registered trademarks of ANRITSU Company.

GPC-7 is a registered trademark of Amphenol Corporation.

ANACAT is a registered trademark of EEsof, Inc.

Ink Jet and Think Jet are registered trademarks of Hewlett-Packard Co.

MS-DOS is a registered trademark of Microsoft Corporation.

NOTICE

ANRITSU Company has prepared this manual for use by ANRITSU Company personnel and customers as a guide for the proper installation, operation and maintenance of ANRITSU Company equipment and computer programs. The drawings, specifications, and information contained herein are the property of ANRITSU Company, and any unauthorized use or disclosure of these drawings, specifications, and information is prohibited; they shall not be reproduced, copied, or used in whole or in part as the basis for manufacture or sale of the equipment or software programs without the prior written consent of ANRITSU Company.

DECLARATION OF CONFORMITY

Manufacturer's Name: WILTRON COMPANY

Manufacturer's Address: Microwave Measurements Division
490 Jarvis Drive
Morgan Hill, CA 95037-2809
USA

declares that the product specified below:

Product Name: Microwave Vector Network Analyzers

Model Number: 371XXA, 372XXA, 372XXB, 373XXA

conforms to the requirement of:

EMC Directive 89/336/EEC as amended by Council Directive 92/31/EEC & 93/68/EEC
Low Voltage Directive 73/23/EEC as amended by Council directive 93/68/EEC

Electromagnetic Interference:

Emissions: CISPR 11:1990/EN55011:1991 Group 1 Class A

Immunity: IEC 1000-4-2:1995/prEN50082-1:1995 - 4kV CD, 8kV AD
IEC 1000-4-3:1993/ENV50140:1994 - 3V/m
IEC 1000-4-4:1995/prEN50082-1:1995 - 0.5kV SL, 1kV PL
IEC 1000-4-5:1995/prEN50082-1:1995 - 0.5kV - 1kV LN
0.5kV - 1kV NG
0.5kV - 1kV GL

Electrical Safety Requirement:

Product Safety: IEC 1010-1:1990 + A1/EN61010-1:1993

Morgan Hill, CA

31-DEC-96
Date

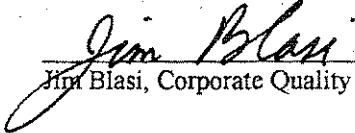
Jim Blasi, Corporate Quality Manager

European Contact:- For Wiltron product EMC & LVD information contact Wiltron Measurement LTD, Wiltron House, Rutherford Close, Stevenage Herts, SG1 2EF UK, (FAX 44-1438-740202)

Safety Symbols

To prevent the risk of personal injury or loss related to equipment malfunction, ANRITSU Company uses the following symbols to indicate safety-related information. For your own safety, please read the information carefully BEFORE operating the equipment.

Symbols used in manuals

DANGER	This indicates a very dangerous procedure that could result in serious injury or death if not performed properly.
WARNING	This indicates a hazardous procedure that could result in serious injury or death if not performed properly.
CAUTION	This indicates a hazardous procedure or danger that could result in light-to-severe injury, or loss related to equipment malfunction, if proper precautions are not taken.

Safety Symbols Used on Equipment and in Manuals

(Some or all of the following five symbols may or may not be used on all ANRITSU equipment. In addition, there may be other labels attached to products that are not shown in the diagrams in this manual.)

The following safety symbols are used inside or on the equipment near operation locations to provide information about safety items and operation precautions. Ensure that you clearly understand the meanings of the symbols and take the necessary precautions BEFORE operating the equipment.



This indicates a prohibited operation. The prohibited operation is indicated symbolically in or near the barred circle.



This indicates a compulsory safety precaution. The required operation is indicated symbolically in or near the circle.



This indicates warning or caution. The contents are indicated symbolically in or near the triangle.



This indicates a note. The contents are described in the box.



These indicate that the marked part should be recycled.

For Safety

WARNING



Always refer to the operation manual when working near locations at which the alert mark, shown on the left, is attached. If the operation, etc., is performed without heeding the advice in the operation manual, there is a risk of personal injury. In addition, the equipment performance may be reduced.

Moreover, this alert mark is sometimes used with other marks and descriptions indicating other dangers.

WARNING



or



When supplying power to this equipment, connect the accessory 3-pin power cord to a 3-pin grounded power outlet. If a grounded 3-pin outlet is not available, use a conversion adapter and ground the green wire, or connect the frame ground on the rear panel of the equipment to ground. If power is supplied without grounding the equipment, there is a risk of receiving a severe or fatal electric shock.

WARNING

Repair

WARNING

This equipment can not be repaired by the operator. DO NOT attempt to remove the equipment covers or to disassemble internal components. Only qualified service technicians with a knowledge of electrical fire and shock hazards should service this equipment. There are high-voltage parts in this equipment presenting a risk of severe injury or fatal electric shock to untrained personnel. In addition, there is a risk of damage to precision components.

WARNING



Use two or more people to lift and move this equipment, or use an equipment cart. There is a risk of back injury, if this equipment is lifted by one person.

Table Of Contents

Chapter 1 — General Information

This chapter provides a general description of the ANRITSU Model 373XXA Vector Network Analyzer System and its major units: network analyzer, test set, and frequency source. It also provides descriptions for the precision component kits, and equipment options. Additionally, it contains the listing of recommended test equipment.

Chapter 2 — Installation

This chapter provides instructions for performing an initial inspection, preparing the equipment for use; setting up for operation over the IEEE-488.2 (GPIB) Bus, using a printer; and preparing the units for storage and/or shipment. It also provides a listing of ANRITSU Customer Service Centers.

Chapter 3 — Network Analyzers, A Primer

This chapter provides an introduction to network analysis and the types of measurements that can be made using them. It provides general and introductory description.

Chapter 4 — Front Panel Operation

This chapter describes the front panel controls and provides flow diagrams for the menus called up using the front panel controls. It contains the following subchapters:

- Front Panel Control-Group Descriptions
- Calibration Keys and Indicators, Detailed Description
- Save/Recall Menu Key and Menus, Key Description and Menu Flow
- Measurement Keys and Menus, Key Descriptions and Menu Flow
- Channel Keys and Menu, Key Descriptions and Menu Flow
- Display Keys and Menus, Key Descriptions and Menu Flow
- Enhancement Keys and Menus, Key Descriptions and Menu Flow
- Output Keys and Menus, Key Descriptions and Menu Flow
- System State Keys and Menus, Key Descriptions and Menu Flow
- Markers/limits Keys and Menus, Key Descriptions and Menu Flow
- Disk Storage Interface, Detailed Description

Chapter 5 — Error And Status Messages

This chapter describes the type of error messages you may encounter during operation and provides a tabular listing. This listing describes and defines the error types.

Chapter 6 — Data Displays

This chapter provides a detailed description of the various data displays. It describes the graph types, frequency markers, measurement limit lines, status displays, and data display controls.

Chapter 7 — Measurement Calibration

This chapter provides a discussion and tutorial on measurement calibration. It contains step-by-step calibration procedures for the Standard (OSL), Offset-Short, TRM, and LRL/LRM methods. It also has a procedure for calibrating using a sliding termination.

Chapter 8 — Measurements

This chapter discusses measurements with the 373XXA VNA. It contains subchapters that provide a detailed descriptions for the following measurement types.

- Transmission and Reflection
- Low Level and Gain
- Group Delay
- Active Device
- Multiple Source Control
- Adapter Removal
- Gain Compression
- Receiver Mode

Chapter 9 — Time Domain

This chapter describes the Option 2, Time Domain feature. It provides an operational procedure and a flowchart of the time domain menus.

Chapter 10 — AutoCal

This chapter describes the Automatic Calibrator (AutoCal) feature and provides operational information and procedures.

Chapter 11 — Operational Checkout Procedures

This chapter provides a procedure for operational checkout.

Chapter 12 — Calibration Kits

This chapter provides a description and listing of components for the calibration kits.

Appendix A — Front Panel Menus, Alphabetical Listing

This appendix shows all of the menus that are called up using the front panel controls. It provides a replica of the menu and descriptive text for all of the various menu choices. The listing is alphabetical by the menu call letters mentioned and/or illustrated in Chapter 4.

Appendix B — Model 373XXA VNA Rear Panel Connectors

This appendix describes the rear panel connectors. It also provides pinout listing.

Appendix C — Performance Specifications

This appendix provides system performance specifications.

Index

Chapter 1

General Information

Table of Contents

1-1	SCOPE OF MANUAL	1-3
1-2	INTRODUCTION	1-3
1-3	IDENTIFICATION NUMBER	1-3
1-4	ONLINE MANUALS	1-3
1-5	SYSTEM DESCRIPTION	1-3
1-6	PRECISION COMPONENT KITS	1-4
	Model 3650 SMA/3.5 mm Calibration Kit	1-4
	Model 3651 GPC-7 Calibration Kit	1-5
	Model 3652 K Connector® Calibration Kit	1-5
	Model 3653 Type N Calibration Kit	1-6
	Model 3654B V Connector® Calibration Kit	1-6
	Model 36550 3.5 mm Calibration Kit	1-7
	Model 36552 K Connector Calibration Kit	1-7
	Model 3666 3.5 mm Verification Kit	1-8
	Model 3667 GPC-7 Verification Kit	1-8
	Model 3668 K Connector® Verification Kit	1-9
	Model 3669/3669B V Connector® Verification Kits	1-9
1-7	OPTIONS	1-9
1-8	PERFORMANCE SPECIFICATIONS	1-9
1-9	RECOMMENDED TEST EQUIPMENT	1-9
1-10	PREVENTIVE MAINTENANCE	1-10

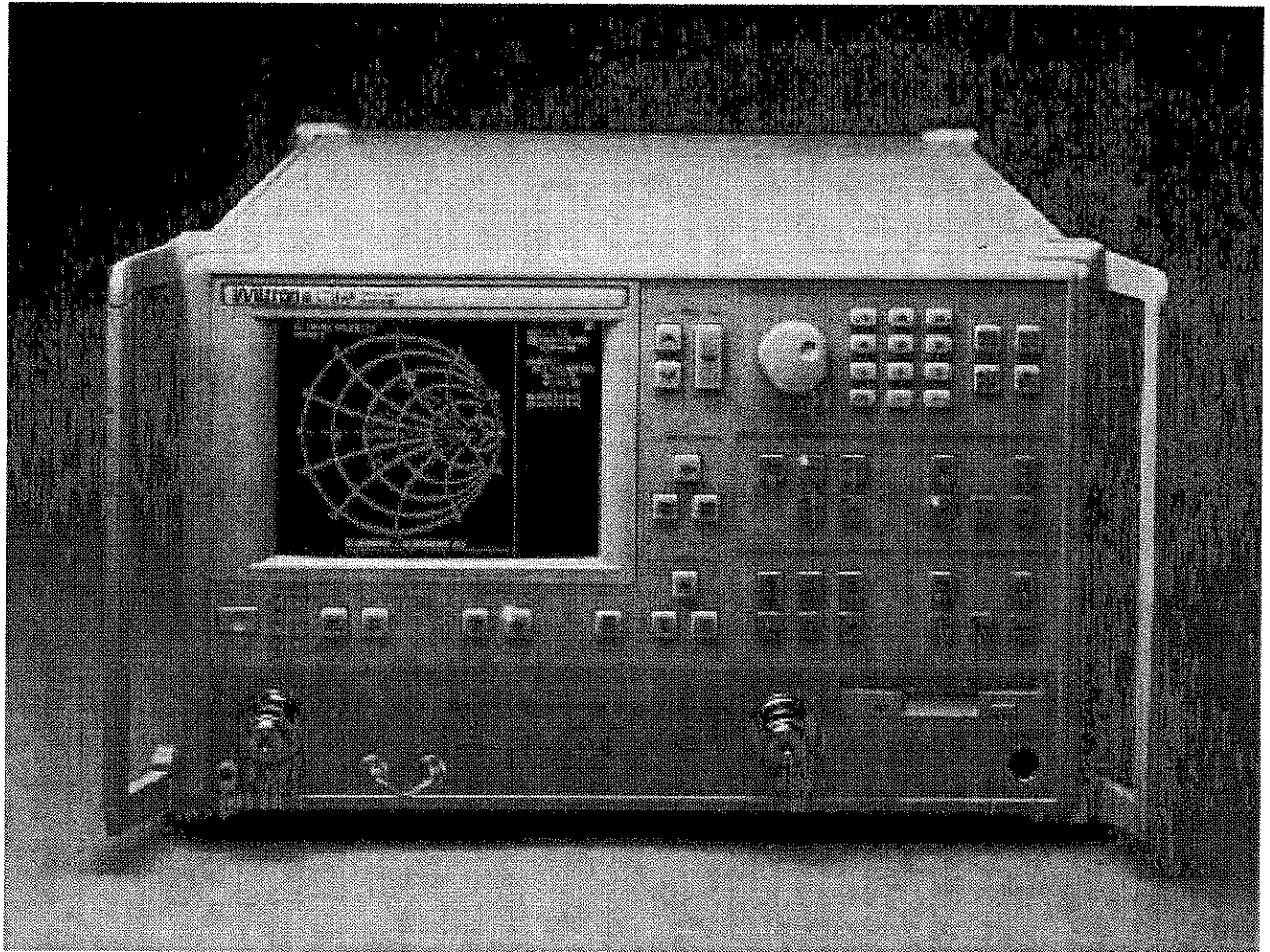

Figure 1-1. Model 373XXA Vector Network Analyzer System

Chapter 1

General Information

1-1 SCOPE OF MANUAL

This manual provides general information, installation, and operating information for the Model 373XXA Vector Network Analyzer (VNA) system. (Throughout this manual, the terms 373XXA VNA and 373XXA will be used interchangeably to refer to the system.) Manual organization is shown in the table of contents.

1-2 INTRODUCTION

This section provides general information about the 373XXA VNA system and one or more precision-component calibration or performance verification kits. The section also provides a listing of recommended test equipment.

1-3 IDENTIFICATION NUMBER

All ANRITSU instruments are assigned a unique six-digit ID number, such as "940101." This number is affixed to a decal on the rear panel of each unit. In any correspondence with ANRITSU Customer Service, please use this number.

1-4 ONLINE MANUALS

This manual is available on CD ROM as an Adobe Acrobat™ (*.pdf) file. The file can be viewed using Acrobat Reader™, a free program that is also available on the CD ROM. This file is "linked" such that the viewer can choose a topic to view from the displayed "bookmark" list and "jump" to the manual page on which the topic resides. The text can also be word-searched. CD ROM part numbers are available on ANRITSU's Internet home page (<http://www.global.anritsu.com>). You can also contact ANRITSU Customer Service for price and availability.

1-5 SYSTEM DESCRIPTION

The 373XXA Network Analyzer (Figure 1-1) is a single-instrument system that contains a built-in source, test set, and analyzer. It is produced in five models that cover a range of from 22.5 MHz to 65 GHz. It provides up to 1601 measurement data points, a built-in hard-disk drive for storing and recalling front panel setups and measurement and calibration data. It provides an on-screen display of total operational time and date of last system calibrations, and the number of power-off cycles since the last calibration. It supports operation over the IEEE 488.2 General Purpose Interface Bus (GPIB).

**1-6 PRECISION COMPONENT
KITS**

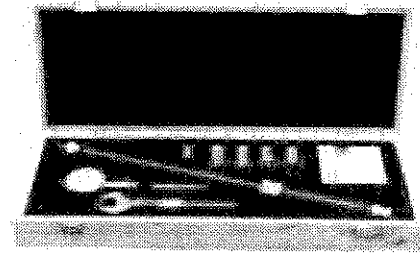

Figure 1-2. Typical Model 365X
Calibration Kit

Two types of precision-component kits are available: calibration and verification. Calibration kits contain components used to identify and separate error sources inherent in microwave test setups. Verification kits consist of components with characteristics traceable to the National Institute of Standards and Technology (NIST). This type of kit is usually kept in the metrology laboratory where it provides the most dependable means of checking system accuracy. Each of these kits contains a microfloppy disk providing coefficient or measurement data for each component. Details of these kits are described in the following paragraphs.

**Model 3650
SMA/3.5 mm
Calibration
Kit**

The 3650 Calibration Kit (Figure 1-2) contains all the precision components and tools required to calibrate the 373XXA VNA for 12-term error-corrected measurements of test devices with SMA or 3.5 mm connectors. Components are included for calibrating both male and female test ports. The kit supports calibration with broadband loads. Option 1 adds sliding loads. Kit consists of the following components:

- 23S50 Short, SMA/3.5 mm Male
- 23SF50 Short, SMA/3.5 mm Female
- 24S50 Open, SMA/3.5 mm Male
- 24SF50 Open, SMA/3.5 mm Female
- 28S50-2 Termination, SMA/3.5 mm Male, 2 ea. (dc-26.5 GHz)
- 28SF50-2 Termination, SMA/3.5 mm Female, 2 ea. (dc-26.5 GHz)
- 33SFSF50 Insertable, SMA/3.5 mm Female/Female, 2 ea.
- 33SS50 Insertable, SMA/3.5 mm Male/Male
- 33SSF50 Insertable, SMA/3.5 mm Male/Female, 2 ea.
- 34AS50-2 Adapter, GPC-7 to SMA/3.5 mm Male, 2 ea.
- 34ASF50-2 Adapter, GPC-7 to SMA/3.5 mm Female, 2 ea.
- 01-201 Torque Wrench
- 01-210 Reference Flat
- 01-222 Connector Gauge
- 01-223 Gauge Kit Adapter
- Data Disk

Option 1: Adds 17S50 Sliding Load, SMA/3.5 mm Male; 17SF50 Sliding Load, SMA/3.5 mm Female; 01-211 Female Flush Short; and 01-212 Male Flush Short.

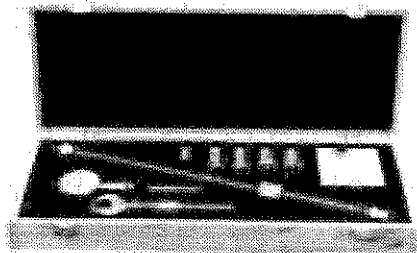

Figure 1-2. Typical Model 365X Calibration Kit (Repeated)

**Model 3651
GPC-7 Cali-
bration Kit**

The 3651 Calibration Kit (Figure 1-2) contains all the precision components and tools required to calibrate the 373XXA for 12-term error-corrected measurements of test devices with GPC-7 connectors. The kit supports calibration with broadband loads. Option 1 adds a sliding load and a pin depth gauge. Kit consists of the following components:

- 23A50 Short, GPC-7
- 24A50 Open, GPC-7
- 28A50-2 Termination, GPC-7, 2 ea. (dc-18 GHz)
- 01-200 Torque Wrench
- 01-221 Collet Extractor Tool and Vial of 4 Collets
- Data Disk

Option 1: Adds 17A50 Sliding Load, GPC-7; and 01-220 GPCP-7 Connector Gauge; and 01-210 Reference Flat.

**Model 3652
K Connector®
Calibration Kit**

The 3652 Calibration Kit (Figure 1-2) contains all the precision components and tools required to calibrate the 373XXA for 12-term error-corrected measurements of test devices with K Connectors. Components are included for calibrating both male and female test ports. The kit supports calibration with broadband loads. Option 1 adds sliding loads. Kit consists of the following components:

- 23K50 Short, K Male
- 23KF50 Short, K Female
- 24K50 Open, K Male
- 24KF50 Open, K Female
- 28K50 Termination, K Male, 2 ea. (dc-40 GHz)
- 28KF50 Termination, K Female, 2 ea. (dc-40 GHz)
- 33KK50 Insertable, K Male/Male
- 33KFKF50 Insertable K Female/Female, 2 ea.
- 33KKF50 Insertable, K Male/Female, 2 ea.
- 34AK50 Adapter, GPC-7/K Male, 2 ea.
- 34AKF50 Adapter, GPC-7/K Female, 2 ea.
- 01-201 Torque Wrench
- 01-210 Reference Flat
- 01-222 Connector Gauge
- 01-223 Gauge Kit Adapter
- Data Disk

Option 1: Adds 17K50 Sliding Load, K Male; 17KF50 Sliding Load, K Female; 01-211 Female Flush Short; and 01-212 Male Flush Short.

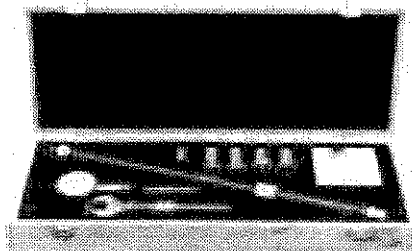

Figure 1-2. Typical Model 365X Calibration Kit (Repeated)

**Model 3653
Type N Cali-
bration Kit**

The 3653 Calibration Kit (Figure 1-2) contains all the precision components and tools required to calibrate the 373XXA for 12-term error-corrected measurements of test devices with Type N connectors. Components are included for calibrating both male and female test ports. The kit supports calibration with broadband loads. Option 1 for sliding loads is not available in this calibration kit. Kit consists of the following components:

- 23N50 Short, N Male
- 23NF50 Short, N Female
- 24N50 Open, N Male
- 24NF50 Open, N Female
- 28N50-2 Termination, N Male, 2 ea. (dc-18 GHz)
- 28NF50-2 Termination, N Female, 2 ea. (dc-18 GHz)
- 34AN50-2 Adapter, GPC-7/N Male, 2 ea.
- 34ANF50-2 Adapter, GPC-7/N Female, 2 ea.
- 01-213 Type N Reference Gauge
- 01-224 Type N Connector Gauge
- Data Disk

**Model 3654B
V Connector®
Calibration Kit**

The 3654B Calibration Kit (Figure 1-2) contains all the precision components and tools required to calibrate the 372XXB for 12-term error-corrected measurements of test devices with V Connectors. Components are included for calibrating both male and female test ports. Kit consists of the following components:

- 17VF50B female sliding termination
- 17V50B male sliding termination
- 33VVF50 male-female adapter (2)
- Calibration software, 2360-54B
- 28V50B male and 28VF50B female broadband terminations (2ea)
- 24V50B male and 24VF50B female opens
- 23V50B-5.1 male and 23VF50B-5.1 female shorts 5.1mm
- 33VV50 male-male adapter
- 33VVF50 female-female adapter (2)
- Connector thumb wheel (4)
- 01-201 torque wrench
- 01-323 female adapter for pin gauge
- 01-322 pin depth gauge
- 01-210 reference flat, 01-204 adapter wrench
- 01-312 male flush short
- 01-311 female flush short

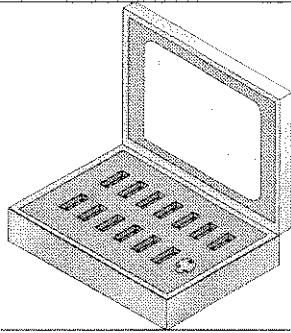

Figure 1-3. Model 3655x Calibration Kit

**Model 36550
3.5 mm Cali-
bration Kit**

The 36550 Calibration Kit (Figure 1-3) contains all the precision components and tools required to calibrate the 373XXA for 12-term error-corrected measurements of test devices with 3.5 mm connectors. Components are included for calibrating both male and female test ports. The kit supports calibration with broadband loads. Option 1 for sliding loads is not available in this calibration kit. Kit consists of the following components:

- 28LF50B 3.5mm Female 50 Ω Termination
- 28L50B 3.5mm Male 50 Ω Termination
- 23L50 3.5mm Male Short
- 23LF50 3.5mm Female Short
- 24L50 3.5mm Male Open
- 24LF50 3.5mm Female Open
- 33LFLF50 3.5mm Female-Female Phase-Equal Insertable
- 33LLF50 3.5mm Male-Female Phase-Equal Insertable
- 33LL50 3.5mm Male-Male Phase-Equal Insertable
- 01-204 Wrench

**Model 36552
K Connector
Calibration
Kit**

The 36552 Calibration Kit (Figure 1-3) contains precision components and tools required to calibrate the 373XXA for 12-term error-corrected measurements of test devices with K Connector® connectors. Components are included for calibrating both male and female test ports. The kit supports calibration with broadband loads. Option 1 for sliding loads is not available in this calibration kit. Kit consists of the following components:

- 28KF50B K Connector Female 50 Ω Termination
- 28K50B K Connector Male 50 Ω Termination
- 23K50 K Connector Male Short
- 23KF50 K Connector Female Short
- 24K50 K Connector Male Open
- 24KF50 K Connector Female Open
- 33KFKF50 K Connector Female-Female Phase-Equal Insertable
- 33KKF50 K Connector Male-Female Phase-Equal Insertable
- 33KK50 K Connector Male-Male Phase-Equal Insertable
- 01-204 Wrench

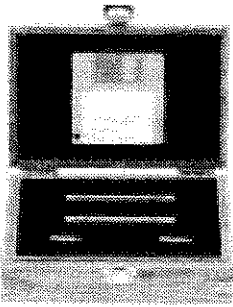

Figure 1-4. Typical Model 366x Verification Kit

**Model 3666
3.5 mm Veri-
fication Kit**

The 3666 Verification Kit (Figure 1-4) contains precision 3.5 mm components with characteristics that are traceable to the NIST. Used primarily by the metrology laboratory, these components provide the most dependable means of determining system accuracy. A disk containing factory-measured test data for all components is supplied for comparison with customer-measured data.

The 3666 consists of the following components:

- ❑ 19S50-7 7.5 cm Air Line
- ❑ 19S50-7B 7.5 cm Stepped Impedance Air Line (Beatty Standard)
- ❑ 42S-20 20 dB Attenuator
- ❑ 42S-50 50 dB Attenuator

**Model 3667
GPC-7 Veri-
fication Kit**

The 3667 Verification Kit (Figure 1-4) contains precision GPC-7 components with characteristics that are traceable to the NIST. Used primarily by the metrology laboratory, these components provide the most dependable means of determining system accuracy. A disk containing factory-measured test data for each component is supplied for comparison with customer-measured data. Kit consists of the following components:

- ❑ 18A50-10B 10 cm Stepped Impedance Air Line (Beatty Standard)
- ❑ 18A50-10 10 cm Air Line
- ❑ 42A-20 20 dB Attenuator
- ❑ 42A-50 50 dB Attenuator

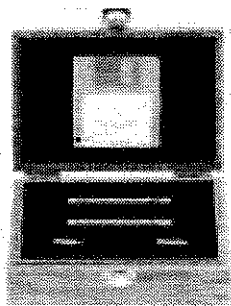

Figure 1-5. Typical Model 366x Verification Kit

**Model 3668
K Connector® Veri-
fication Kit**

The 3668 Verification Kit (Figure 1-5) contains precision K Connector components with characteristics that are traceable to the NIST. Used primarily by the metrology laboratory, these components provide the most dependable means of determining system accuracy. A disk containing factory-measured test data for each component is supplied for comparison with customer-measured data. Kit consists of the following components:

- 19K50-7 7.5 cm Air Line
- 19K50-7B 7.5 cm Stepped Impedance Air Line (Beatty Standard)
- 42K-20 20 dB Attenuator
- 42K-50 50 dB Attenuator

**Model
3669/3669B
V Connector® Veri-
fication
Kits**

The 3669 and 3669B Verification Kits (Figure 1-5) contain precision V Connector components with characteristics that are traceable to the NIST. Used primarily by the metrology laboratory, these components provide the most dependable means of determining system accuracy. A disk containing factory-measured test data for each component is supplied for comparison with customer-measured data. Kit consists of the following components:

- 19K50-7 7.5 cm Air Line
- 19K50-7B 7.5 cm Stepped Impedance Air Line (Beatty Standard)
- 42K-20 20 dB Attenuator
- 42K-50 50 dB Attenuator

1-7 OPTIONS

The following options are available.

- Option 2: Time (Distance) Domain Measurement Capability.
- Option 4: External SCSI Hard Disk
- Option 10: Ovenized Timebase
- Option 11: Reference Loop Extension Cables

1-8 PERFORMANCE SPECIFICATIONS

System performance specifications are provided in Appendix C.

1-9 RECOMMENDED TEST EQUIPMENT

Table 1-1 lists the recommended test equipment for maintaining and servicing the 373XXA VNA system.

Table 1-1. Recommended Test Equipment

Instrument	Critical Specification	Recommended Manufacturer/Model
Spectrum Analyzer, with Diplexer and External Mixers	<i>Frequency:</i> 0.01 to 40 GHz <i>Resolution:</i> 10 Hz	Tektronix, Inc. Model 2794P, with External Mixers: WM 780K (18 to 26.5 GHz) WM 780A (26.5 to 40 GHz) Diplexer PN: 015-0385-00
Power Meter, with Power Sensors	<i>Range:</i> -30 to +20 dBm (1 μ W to 100 mW) <i>Other:</i> GPIB-controllable	Hewlett-Packard Model 437B, with Power Sensors: HP 8487A (0.05 to 50 GHz)
Digital Multimeter	<i>Resolution:</i> 4--1/2 digits <i>DC Accuracy:</i> 0.002% +2 counts <i>DC Input Z:</i> 10 M Ω <i>AC Accuracy:</i> 0.07% +100 counts (to 20 kHz) <i>AC Input Z:</i> 1 M Ω	John Fluke, Inc. Model 8840A, with Option 8840A-09 (True RMS AC)
Frequency Counter, with External Mixers	<i>Range:</i> 0.01 to 40 GHz <i>Input Z:</i> 50 <i>Resolution:</i> 1 Hz <i>Other:</i> External Time Base Input	EIP Microwave, Inc. Model 578A, with External Mixers: Option 91 (26.5 to 40 GHz)
Oscilloscope	<i>Bandwidth:</i> DC to 150 MHz <i>Vertical Sensitivity:</i> 2 mV/ division <i>Horiz Sensitivity:</i> 50 ns/ division	Tektronix, Inc. Model 2445
Function Generator	<i>Output Voltage Range:</i> 300 mV to 10V <i>Functions:</i> 200 Hz Sine Wave 100 Hz Square Wave	Hewlett-Packard Model 3325B
Power Meter and Power Sensor	Frequency Range: to 65 GHz	Anritsu Model ML24xxA Power Meter and MA2474A (40 GHz and below) and Model SC6230 (to 65 GHz) Power Sensors

**1-10 PREVENTIVE
MAINTENANCE**

The 373XXA VNA system does not require any preventive maintenance.

Chapter 2

Installation

Table of Contents

2-1	INTRODUCTION	2-3
2-2	INITIAL INSPECTION	2-3
2-3	PREPARATION FOR USE	2-3
2-4	GPIB SETUP AND INTERCONNECTION	2-4
	Interface Connector	2-4
	Cable Length Restrictions	2-4
2-5	SYSTEM GPIB INTERCONNECTION	2-5
	GPIB Interface to an External Plotter	2-5
	GPIB Addresses	2-5
2-6	EXTERNAL MONITOR CONNECTOR	2-5
2-7	PREPARATION FOR STORAGE AND/OR SHIPMENT	2-5
	Preparation for Storage	2-5
	Preparation for Shipment	2-5
2-8	RACK MOUNT (OPTION 1) INSTALLATION	2-8

Chapter 2

Installation

2-1 INTRODUCTION

This chapter provides information for the initial inspection and preparation for use of the 373XXA Vector Network Analyzer. Information for interfacing the 373XXA to the IEEE-488 General Purpose Interface Bus and reshipment and storage information is also included.

2-2 INITIAL INSPECTION

Inspect the shipping container for damage. If the container or cushioning material is damaged, retain until the contents of the shipment have been checked against the packing list and the instrument has been checked for mechanical and electrical operation.

If the 373XXA is damaged mechanically, notify your local sales representative or ANRITSU Customer Service. If either the shipping container is damaged or the cushioning material shows signs of stress, notify the carrier as well as ANRITSU. Keep the shipping materials for the carrier's inspection.

WARNING

WARNING 

Use two or more people to lift and move this equipment, or use an equipment cart. There is a risk of back injury, if this equipment is lifted by one person.

2-3 PREPARATION FOR USE

No initial setup is required. After unpacking, the 373XXA is ready for use. The 373XXA is equipped with automatic line-power sensing, and will operate with any of the following line voltages: 100V, 120V, 220V, 240V +5%, -10%, 48-63 Hz, 350 VA. The 373XXA is intended for Installation Category (Overvoltage Category) II.

WARNING



or



When supplying power to this equipment, always use a three-wire power cable connected to a three-wire power line outlet. If power is supplied without grounding the equipment, there is a risk of receiving a severe or fatal electric shock.

**2-4 GPIB SETUP AND
INTERCONNECTION**

All functions of the 373XXA (except power on/off and initialization of the hard disk) can be controlled remotely by an external computer/controller via the IEEE-488.2 GPIB. The information in this section pertains to interface connections and cable requirements for the rear panel GPIB connector. Refer to the Model 373XXA Programming Manual, ANRITSU Part Number 10410-00184, for information about remote operation of the 373XXA using the GPIB.

The 373XXA GPIB operates with any IBM XT, AT, or PS/2 compatible computer/controller equipped with a National Instruments GPIB-PCII/IIA interface card and software.

**Interface
Connector**

Interface between the 373XXA and other devices on the GPIB is via a standard 24-wire GPIB interface cable. For proper operation, order WPN 2100-1, -2, -4, or -5 (1, 2, 4, or 0.5 meter length) cables through your local sales representative. This cable uses a double-sided connector; one connector face is a plug, the other a receptacle. These double-function connectors allow parallel connection of two or more cables to a single instrument connector. The pin assignments for the rear panel GPIB connector are shown in Figure B-1, located in Appendix B.

**Cable Length
Restrictions**

The GPIB system can accommodate up to 15 instruments at any one time. To achieve design performance on the bus, proper timing and voltage level relationships must be maintained. If either the cable length between separate instruments or the accumulated cable length between all instruments is too long, the data and control lines cannot be driven properly and the system may fail to perform. Cable length restrictions are as follows:

- ❑ No more than 15 instruments may be installed on the bus.
- ❑ Total accumulative cable length in meters may not exceed two times the number of bus instruments or 20 meters—whichever is less.

NOTE

For low EMI applications, the GPIB cable should be a fully shielded type, with well-grounded metal-shell connectors. (Use WPN 2100-series cables.)

**2-5 SYSTEM GPIB
INTERCONNECTION**

There are two rear panel GPIB IEEE-488 connectors. The IEEE 488.2 connector used to interface the 373XXA to an external computer/controller via a standard GPIB cable. The dedicated GPIB connector is used to interface to plotters and a second source for multiple source operation via a standard GPIB cable.

***GPIB Inter-
face to an
External
Plotter***

The 373XXA GPIB interface can be configured to control a suitable external plotter (refer to Chapter 6—Data Displays). In this mode of operation, the GPIB is dedicated to this application and only the 373XXA and the plotter are connected to the GPIB. Standard GPIB cables are used to interconnect to the plotter.

***GPIB Ad-
dresses***

The 373XXA leaves the factory with the default GPIB address set to 6. This address may be changed using the GP7 menu (see Appendix A).

**2-6 EXTERNAL MONITOR
CONNECTOR**

The rear panel EXTERNAL MONITOR connector allows the internal display information of the 373XXA to be connected to an external VGA monitor (either color or monochrome). The pinout of this 15-pin Type D connector is shown in Figure B-4, located in Appendix B.

**2-7 PREPARATION FOR
STORAGE AND/OR
SHIPMENT**

The following paragraphs describe the procedure for preparing the 373XXA for storage or shipment.

***Preparation
for Storage***

Preparing the 373XXA for storage consists of cleaning the unit, packing the inside with moisture-absorbing desiccant crystals, and storing the unit in a temperature environment that is maintained between -40 and +70 degrees centigrade (-40 to 156 degrees Fahrenheit).

***Preparation
for Shipment***

To provide maximum protection against damage in transit, the 373XXA should be repackaged in the original shipping container. If this container is no longer available and the 373XXA is being returned to ANRITSU for repair, advise ANRITSU Customer Service; they will send a new shipping container free of charge. In the event neither of these two options is possible, instructions for packaging and shipment are given below.

Use a Suitable Container

Obtain a corrugated cardboard carton with a 275-pound test strength. This carton should have inside dimensions of no less than six inches larger

than the instrument dimensions to allow for cushioning.

Protect the Instrument

Surround the instrument with polyethylene sheeting to protect the finish.

Cushion the Instrument

Cushion the instrument on all sides by tightly packing dunnage or urethane foam between the carton and the instrument. Provide at least three inches of dunnage on all sides.

Seal the Container

Seal the carton by using either shipping tape or an industrial stapler.

Address the Container

If the instrument is being returned to ANRITSU for service, mark the ANRITSU address and your return address on the carton in one or more prominent locations. For international customers, use the address of your local representative (Table 2-1). For U.S.A. customers, use the ANRITSU address shown below:

ANRITSU Company
ATTN: Customer Service
490 Jarvis Drive
Morgan Hill, CA 95037-2809

Table 2-1. ANRITSU Service Centers

UNITED STATES
ANRITSU COMPANY
490 Jarvis Drive
Morgan Hill, CA 95037-2809
Telephone: (408) 778-2000
Telex: 285227 ANRITSU MH
FAX: 408-778-0239

ANRITSU SALES
COMPANY
685 Jarvis Drive
Morgan Hill, CA 95037-2809
Telephone: (408) 776-8300
FAX: 408-776-1744

ANRITSU SALES
COMPANY
10 Kingsbridge Road
Fairfield, NJ 07004
Telephone: (201) 227-8999
FAX: 201-575-0092

AUSTRALIA
ANRITSU PTY. LTD.
Level 2, 410 Church Street
North Parramatta
NSW 2151 Australia
Telephone: 026-30-81-66
Fax: 026-83-68-84

BRAZIL
ANRITSU-ANRITSU
Anritsu Electronica Ltda.
Praia de Botafogo
440-Sa;a 2.401-Botafogo
2225 Rio de Janeiro RJ Brazil
Telephone: 021-28-69-141
Fax: 021-53-71-456

CANADA
ANRITSU INSTRUMENTS LTD.
215 Stafford Road, Unit 102
Nepean, Ontario K2H 9C1
Telephone: (613) 828-4090
FAX: (613) 828-5400

CHINA
ANRITSU BEIJING SERVICE
CENTER
416W Beijing Fortune Building
5 Dong San Huan Bei Lu
Chao Yang Qu, Beijing 100004, China
Telephone: 86-1-50-17-559
FAX: 86-1-50-17-558

FRANCE
ANRITSU S.A
9 Avenue du Quebec
Zone de Courtaboeuf
91951 Les Ulis Cedex
Telephone: 016-44-66-546
FAX: 016-44-61-065

GERMANY
ANRITSU GmbH
Rudolf Diesel Strabe 17
8031 Gilching
Telephone: 08-10-58-055
Telex: (841) 528523
FAX: 08-10-51-700

INDIA
MEERA AGENCIES (P) LTD.
Head Office
A-23 Hauz Khas
New Delhi 110
Telephone: 011-91-11-685-3959
FAX: 011-91-11-685-2275

ISRAEL
TECH-CENT, LTD
Haarad St. No. 7, Ramat Haahayal
Tel-Aviv 69701
Telephone: (03) 64-78-563
FAX: (03) 64-78-334

ITALY
ANRITSU Sp.A
Roma Office
Via E. Vittorini, 129
00144 Roma EUR
Telephone: (06) 50-22-666

FAX: (06) 50-22-4252

JAPAN
ANRITSU CORPORATION
1800 Onna Atsugi-shi
Kanagawa-Prf. 243 Japan
Telephone: 0462-23-1111
FAX: 0462-25-8379

KOREA
ANRITSU CORPORATION
#2103 Korea World Trade Center
159-1 Samsung-Dong
Kangnam-ku, Seoul
Telephone: (02) 551-2250
FAX: (02) 551-4941

SWEDEN
ANRITSU AB
Box 247
S-127 25 Skarholmen
Telephone: (08) 74-05-840
Telex: (854) 81-35-089
FAX: (08) 71-09-960

TAIWAN
ANRITSU CO., LTD.
8F, No. 96, Section 3
Chien Kuo N. Road
Taipei, Taiwan, R.O.C.
Telephone: (02) 515-6050
FAX: (02) 509-5519

UNITED KINGDOM
ANRITSU LTD.
200 Capability Green
Luton, Bedfordshire
LU1 3LU, England
Telephone: 05-82-41-88-53
Telex: (851) 826750
FAX: 05-82-31-303

**2-8 RACK MOUNT
(OPTION 1)
INSTALLATION**

To install the Option 1 Rack Mount rails, refer to the below-listed procedure.

- Step 1. Disconnect the line cord and any other attachments from the instrument.
- Step 2. Carefully place the instrument on its top (bottom-side up) on a secure and stable work surface.
- Step 3. Using a Phillips screwdriver, remove the two handles or four bumper assemblies (and tilt bail, if installed) from the front of the unit, and the four feet at the rear (Figure 2-1). Save the screws for later use.

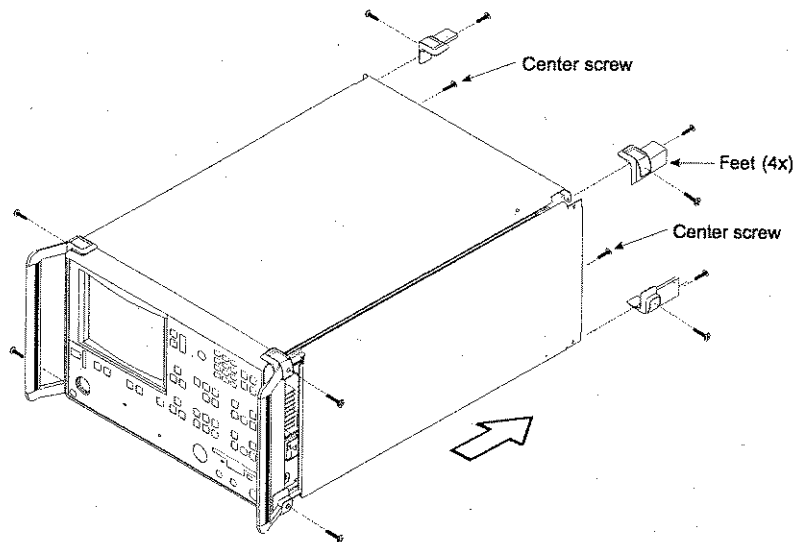

Figure 2-1 *Handles and Bumpers*

NOTES

- The green-headed screws are metric threads and must be used only in the appropriately tapped holes.
 - The feet, handles, and bumpers are not reused in this application.
- Step 4. Remove the center screws from the rear of the left and right side covers.
 - Step 5. Remove the two side carrying handle screws (if so equipped) located under the plastic handle ends.

- Step 6. Remove the left and right side covers. These side covers are not reused in this application.
- Step 7. Install the two Rack Mount Handles using the green-headed screws removed earlier.
- Step 8. Secure the new left cover (2) from this retrofit kit to the left side chassis of the instrument by installing the two center screws (6) to the top and bottom and the previously removed center screw at the rear of the left cover.
- Step 9. Secure the slide assembly (4) to the left cover by installing the four mounting screws (5) to the left chassis. (Figure 2-2).
-

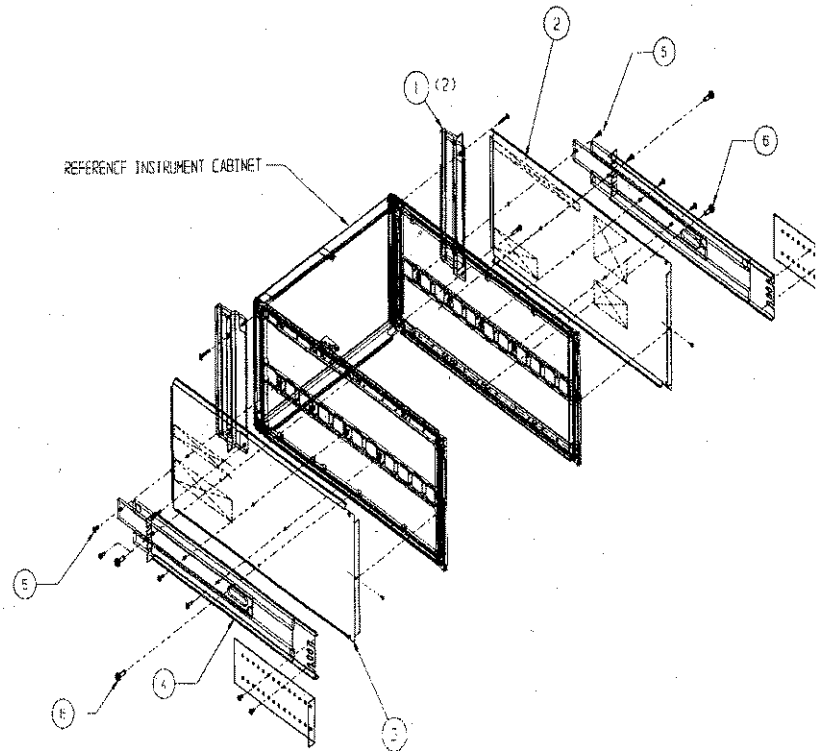

Figure 2-2 Rails

- Step 10. Secure the new right cover (3) from this retrofit kit to the right side chassis of the instrument by installing the center screw (6) through the center of the right side cover and the previously removed center screw at the rear of the right side cover.
- Step 11. Secure the slide assembly (4) to the right cover by installing the four mounting screws (5) to the right chassis.

This completes the installation of the slide assembly.

Chapter 3

Network Analyzers, A Primer

Table of Contents

3-1	INTRODUCTION	3-3
3-2	GENERAL DESCRIPTION	3-3
	Source Module	3-4
	Test Set Module.	3-4
	Analyzer Module	3-5
3-3	NETWORK ANALYZERS	3-5
	Scalar Analyzer Comparison	3-5
	Vector Network Analyzer Basics.	3-6
	Network Analyzer Measurements.	3-9
	Measurement Error Correction.	3-11
	Summary	3-11

Chapter 3

Network Analyzers, A Primer

3-1 INTRODUCTION

This section provides front panel operating and measurement application information and data. It includes discussions on the following topics:

- System description
- General discussion about network analyzers
- Basic measurements and how to make them
- Error correction
- General discussion on test sets

3-2 GENERAL DESCRIPTION

The Model 373XXA Vector Network Analyzer System measures the magnitude and phase characteristics of networks: amplifiers, attenuators, and antennas. It compares the incident signal that leaves the analyzer with either the signal that is transmitted through the test device or the signal that is reflected from its input. Figures 3-1 and 3-2 illustrate the types of measurements that the 373XXA can make.

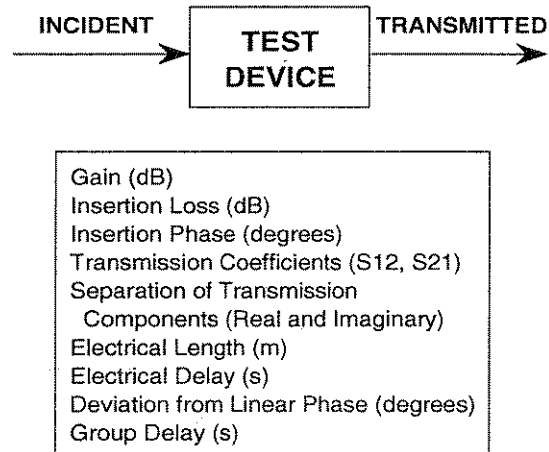

Figure 3-1. Transmission Measurements

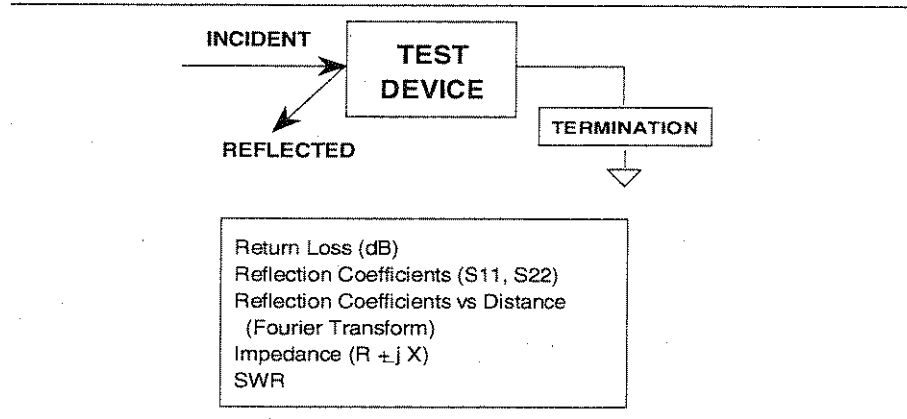

Figure 3-2. Reflection Measurements

The 373XXA is a self-contained, fully integrated measurement system that includes an optional time domain capability. The system hardware consists of the following:

- Analyzer
- Precision components required for calibration and performance verification.
- Optional use of ANRITSU 67XXB, 68XXXA/B, or 69XXXA as a second source.

The 373XXA internal system modules perform the following functions:

Source Module

This module provides the stimulus to the device under test (DUT). The frequency range of the source and test set modules establish the frequency range of the system. The frequency stability of the source is an important factor in the accuracy (especially phase accuracy) of the network analyzer. Hence, the 373XXA always phase locks the source to an internal 10 MHz crystal reference.

Test Set Module

The test set module routes the stimulus signal to the DUT and samples the reflected and transmitted signals. The type of connector used is important, as is the "Auto Reversing" feature. Auto Reversing means that it applies the stimulus signal in both the forward and reverse direction. The direction is reversed automatically. This saves you from having to reverse the test device physically to measure all four scattering parameters (S-parameters). Frequency conversion (1st and 2nd IFs) occurs in the test set module.

**Analyzer
Module**

The analyzer module down-converts, receives, and interprets the 3rd IF signal for phase and magnitude data. It then displays the results of this analysis on a large, 190 mm (7-1/2 inch) diagonal color display. This display can show all four S-parameters simultaneously. In addition to the installed display, you can also view the measurement results on an external color monitor.

3-3 NETWORK ANALYZERS

We will begin this discussion with a subject familiar to most ANRITSU customers: scalar network analysis. After showing comparisons, we will proceed to the fundamentals of network analyzer terminology and techniques. This discussion serves as an introduction to topics presented in greater detail later in this section. This discussion will touch on new concepts that include the following:

- Reference Delay
- S-parameters: what they are and how they are displayed
- Complex Impedance and Smith Charts

**Scalar
Analyzer
Comparison**

Network Analyzers do everything that scalar analyzers do except display absolute power. In addition, they add the ability to measure the phase characteristics of microwave devices and allow greater dynamic range.

If all a Network Analyzer added was the capability for measuring phase characteristics, its usefulness would be limited. While phase measurements are important in themselves, it is the availability of this phase information that unlocks many new features for complex measurements. These features include Smith Charts, Time Domain, and Group Delay. Phase information also allows greater accuracy through *vector error correction* of the measured signal.

First, let us look at scalar network analyzers (SNAs). SNAs measure microwave signals by converting them to a DC voltage using a diode detector (Figure 3-3). This DC voltage is proportional to the magnitude of the incoming signal. The detection process, however, ignores any information regarding the phase of the microwave signal.

In a network analyzer, access is needed to both the magnitude and phase of a microwave signal. There are several different ways to perform the measure-

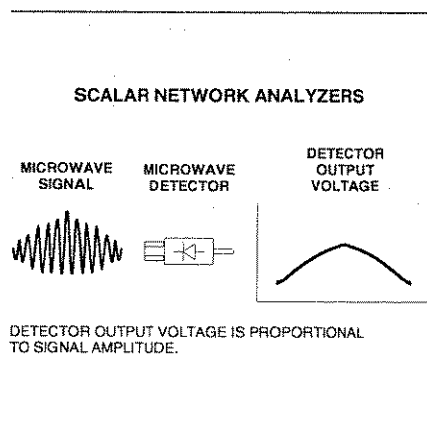

Figure 3-3. Scalar analyzer detection

A NETWORK ANALYZER IS A TUNED RECEIVER

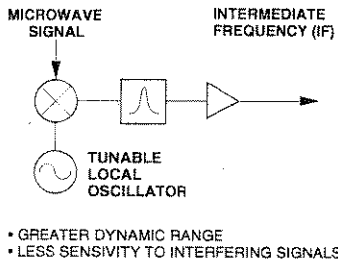

Figure 3-4. Network analyzer is a tuned receiver

PHASE MEASUREMENT

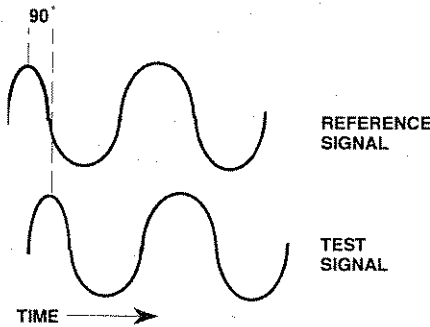

Figure 3-5. Signals with a 90 degree phase difference

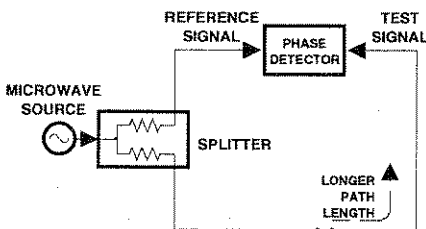

Figure 3-6. Split signal where a length of line replaces the DUT

Vector Network Analyzer Basics

ment. The method ANRITSU employs (called Harmonic Sampling or Harmonic Mixing) is to down-convert the signal to a lower intermediate frequency (IF). This signal can then be measured directly by a tuned receiver. The tuned receiver approach gives the system greater dynamic range. The system is also much less sensitive to interfering signals, including harmonics.

The network analyzer is a tuned receiver (Figure 3-5, left). The microwave signal is down converted into the passband of the IF. To measure the phase of this signal, we must have a reference to compare it with. If the phase of a signal is 90 degrees, it is 90 degrees different from the reference signal (Figure 3-6, left). The network analyzer would read this as -90 degrees, since the test signal is delayed by 90 degrees with respect to the reference signal.

This phase reference can be obtained by splitting off some of the microwave signal before the measurement (Figure 3-7, below).

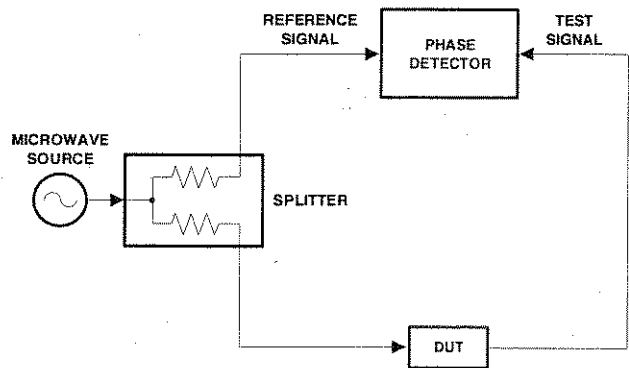

Figure 3-7. Splitting the microwave signal

The phase of the microwave signal after it has passed through the device under test (DUT) is then compared with the reference signal. A network analyzer test set automatically samples the reference signal, so no external hardware is needed.

Let us consider for a moment that you remove the DUT and substitute a length of transmission line (Figure 3-6, left). Note that the path length of the test signal is longer than that of the reference sig-

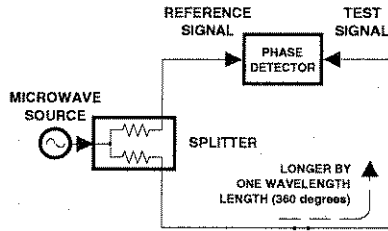

Figure 3-8. Split signal where path length differs by exactly one wavelength

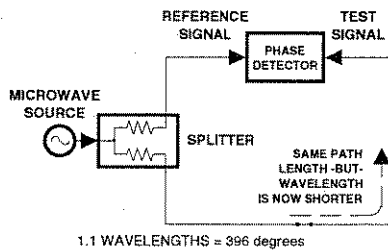

Figure 3-9. Split signal where path length is longer than one wavelength

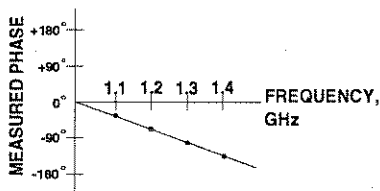

Figure 3-10. Electrical Delay

nal. Now let us see how this affects our measurement.

Assume that we are making a measurement at 1 GHz and that the difference in path-length between the two signals is exactly 1 wavelength. This means that test signal is lagging the reference signal by 360 degrees (Figure 3-8). We cannot really tell the difference between one sine wave maxima and the next (they are all identical), so the network analyzer would measure a phase difference of 0 degrees.

Now consider that we make this same measurement at 1.1 GHz. The frequency is higher by 10 percent so therefore the wavelength is shorter by 10 percent. The test signal path length is now 0.1 wavelength longer than that of the reference signal (Figure 3-9). This test signal is:

$$1.1 \times 360 = 396 \text{ degrees}$$

This is 36 degrees different from the phase measurement at 1 GHz. The network analyzer will display this phase difference as -36 degrees.

The test signal at 1.1 GHz is delayed by 36 degrees more than the test signal at 1 GHz.

You can see that if the measurement frequency is 1.2 GHz, we will get a reading of -72 degrees, -108 degrees for 1.3 GHz, etc. (Figure 3-10). There is an electrical delay between the reference and test signals. For this delay we will use the common industry term of reference delay. You also may hear it called phase delay. In older network analyzers you had to equalize the length of the reference arm with that of the test arm to make an appropriate measurement of phase vs. frequency.

To measure phase on a DUT, we want to remove this phase-change-vs.-frequency-due-to changes in the electrical length. This will allow us to view the actual phase characteristics. These characteristics may be much smaller than the phase-change-due-to-electrical length difference.

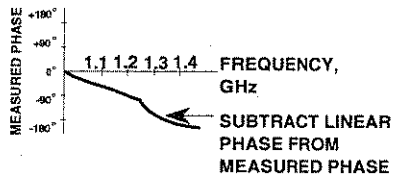

Figure 3-12. Phase difference increases linearly with frequency

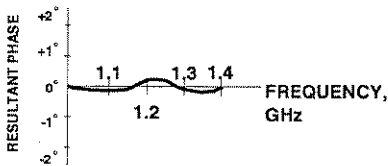

Figure 3-13. Resultant phase with path length compensation in place

There are two ways of accomplishing this. The most obvious way is to insert a length of line into the reference signal path to make both paths of equal length (Figure 3-11, below). With perfect transmission lines and a perfect splitter, we would then measure a constant phase as we change the frequency. The problem using this approach is that we must change the line length with each measurement setup.

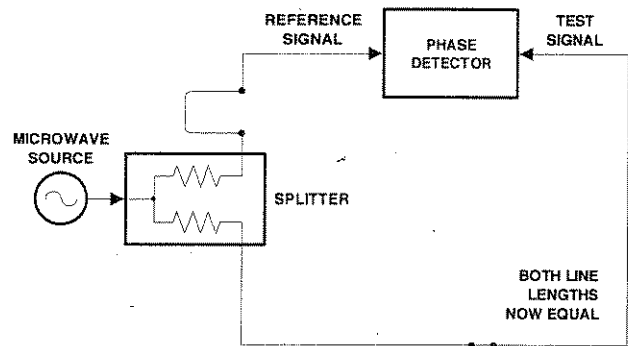

Figure 3-11. Split signal where paths are of equal length

Another approach is to handle the path length difference in software. Figure 3-12 (left) displays the phase-vs.-frequency of a device. This device has different effects on the output phase at different frequencies. Because of these differences, we do not have a perfectly linear phase response. We can easily detect this phase deviation by compensating for the linear phase. The size of the phase difference increases linearly with frequency so we can modify the phase display to eliminate this delay.

The 373XXA offers automatic reference delay compensation with the push of a button. Figure 3-13 (left) shows the resultant measurement when we compensate path length. In a system application you can usually correct for length differences; however, the residual phase characteristics are critical.

Network Analyzer Measurements

Now let us consider measuring the DUT. Consider a two port device; that is, a device with a connector on each end. What measurements would be of interest?

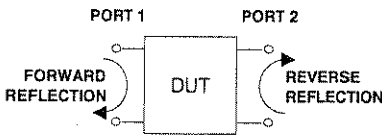
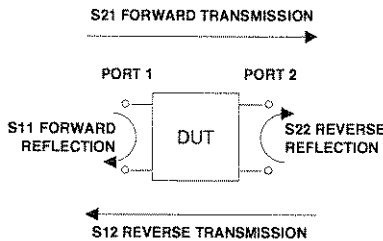

Figure 3-14. Forward and reverse measurements

First, we could measure the reflection characteristics at either end with the other end terminated into 50 ohms. If we designate one end as the normal place for the input that gives a reference. We can then define the reflection characteristics from the reference end as forward reflection, and those from the other end as reverse reflection (Figure 3-14).

Second, we can measure the forward and reverse transmission characteristics. However, instead of saying “forward,” “reverse,” “reflection,” and “transmission” all the time, we use a shorthand. That is all that S-parameters are, a shorthand! The “S” stands for scattering. The second number is the device port that the signal is being injected into, while the first is the device port that the signal is leaving. S_{11} , therefore, is the signal being injected into port 1 relative to the signal leaving port 1. The four scattering parameters (Figure 3-15):



- S_{11} Forward Reflection
- S_{21} Forward Transmission
- S_{22} Reverse Reflection
- S_{12} Reverse Transmission

Figure 3-15. S-parameters

S-parameters can be displayed in many ways. An S-parameter consists of a magnitude and a phase. We can display the magnitude in dB, just like a scalar network analyzer. We often call this term *log magnitude*.

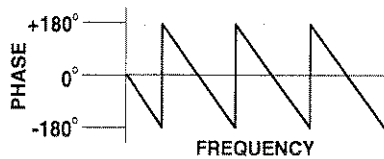

We can display phase as “linear phase” (Figure 3-16). As discussed earlier, we can’t tell the difference between one cycle and the next. Therefore, after going through 360 degrees we are back to where we began. We can display the measurement from -180 to +180 degrees. The -180 to +180 approach is more common. It keeps the display discontinuity removed from the important 0 degree area used as the phase reference.

Figure 3-16. Linear phase-with-frequency waveform

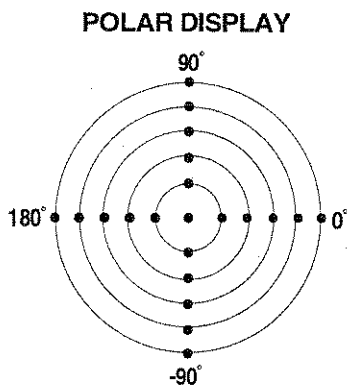

Figure 3-17. Polar display

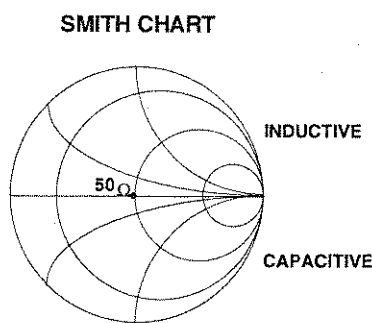

Figure 3-18. Smith chart

There are several ways in which all the information can be displayed on one trace. One method is a polar display (Figure 3-17). The radial parameter (distance from the center) is magnitude. The rotation around the circle is phase. We sometimes use polar displays to view transmission measurements, especially on cascaded devices (devices in series). The transmission result is the addition of the phase and log magnitude (dB) information of each device's polar display.

As we have discussed, the signal reflected from a DUT has both magnitude and phase. This is because the impedance of the device has both a resistive and a reactive term of the form $r+jx$. We refer to the r as the real or resistive term, while we call x the imaginary or reactive term. The j , which we sometimes denote as i , is an imaginary number. It is the square root of -1 . If x is positive, the impedance is inductive, if x is negative the impedance is capacitive.

The size and polarity of the reactive component x is important in impedance matching. The best match to a complex impedance is the complex conjugate. This complex-sounding term simply means an impedance with the same value of r and x , but with x of opposite polarity. This term is best analyzed using a Smith Chart (Figure 3-18), which is a plot of r and x .

To display all the information on a single S-parameter requires one or two traces, depending upon the format we want. A very common requirement is to view forward reflection on a Smith Chart (one trace) while observing forward transmission in Log Magnitude and Phase (two traces). Let us see how to accomplish this in the 373XXA.

The 373XXA has four channels. Each channel can display a complete S-parameter in any format on either one or two traces. All four S-parameters can be seen simultaneously in any desired format. A total of eight traces can be viewed at the same time. While this is a lot of information to digest, the 373XXA's large color display makes recognizing and analyzing the data surprisingly easy.

MAGNITUDE AND PHASE OF
EACH ERROR SIGNAL IS MEASURED

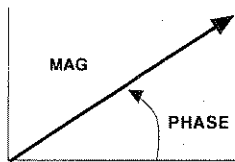

THEN THE RESULTANT VECTOR IS
APPLIED MATHEMATICALLY, HENCE
VECTOR ERROR CORRECTION

Figure 3-19. Magnitude and phase measurements

Another important parameter we can measure when phase information is available is group delay. In linear devices, the phase change through the DUT is linear-with-frequency. Thus, doubling the frequency also doubles the phase change. An important measurement, especially for communications system users, is the rate of change-of-phase-vs.-frequency (group delay). If the rate of phase-change-vs.-frequency is not constant, the DUT is nonlinear. This nonlinearity can create distortion in communications systems.

**Measurement
Error
Correction**

Since we can measure microwave signals in both magnitude and phase, it is possible to correct for six major error terms:

Source Test Port Match

- Load Test Port Match
- Directivity
- Isolation
- Transmission Frequency Response
- Reflection Frequency Response

We can correct for each of these six error terms in both the forward and reverse directions, hence the name 12-term error correction. Since 12-term error correction requires both forward and reverse measurement information, the test set must be *reversing*. “Reversing” means that it must be able to apply the measurement signal in either the forward or reverse direction.

To accomplish this error correction, we measure the magnitude and phase of each error signal (Figure 3-19). Magnitude and phase information appear as a vector that is mathematically applied to the measurement signal. This process is termed *vector error correction*.

Summary

A network analyzer is similar to a scalar network analyzer. The major difference is that it adds the capability for measuring phase as well as amplitude. With phase measurements comes scattering, or S-parameters, which are a shorthand method for identifying forward and reverse transmission and reflection characteristics. The ability to measure phase introduces two new displays, polar and Smith Chart. It also adds vector error correction to the measurement trace. With vector error correction,

errors introduced by the measurement system are compensated for and measurement uncertainty is minimized. Phase measurements also add the capability for measuring group delay, which is the rate of change-of-phase-vs.-frequency (group delay). All in all, using a network analyzer provides for making a more complete analysis of your test device.

Chapter 4

Front Panel Operation

Table of Contents

4-1	INTRODUCTION	4-3
4-2	FRONT PANEL KEY-GROUP DESCRIPTIONS	4-3
4-3	CALIBRATION KEY-GROUP, DESCRIPTIONS AND MENU FLOW.	4-9
4-4	SAVE/RECALL MENU KEY, DESCRIPTION AND MENU FLOW	4-19
4-5	MEASUREMENT KEY-GROUP , DESCRIPTION AND MENU FLOW	4-20
4-6	CHANNELS KEY-GROUP, DESCRIPTION AND MENU FLOW	4-23
4-7	DISPLAY KEY-GROUP, DESCRIPTION AND MENU FLOW	4-24
4-8	ENHANCEMENT KEY-GROUP, DESCRIPTION AND MENU FLOW	4-28
4-9	HARD COPY KEY-GROUP, DESCRIPTION AND MENU FLOW.	4-30
4-10	SYSTEM STATE KEY-GROUP, DESCRIPTION AND MENU FLOW	4-32
4-11	MARKERS/LIMITS KEY-GROUP, DESCRIPTION AND MENU FLOW	4-35
4-12	DISK STORAGE INTERFACE	4-36
	Disk Format	4-36
	Disk Files	4-36
	Disk File Output Device	4-41
	Formatting a Data File Disk	4-41
	Copying Data Files From Disk to Disk.	4-41
	Recovering From Disk Write/Read Errors	4-42
4-13	COMMAND LINE.	4-42
	Create Directory	4-42
	List Directory	4-42
	Change Directory	4-43
	Delete Files	4-43
	Remove Directory	4-43
	Copy Files	4-43
	Conventions	4-43

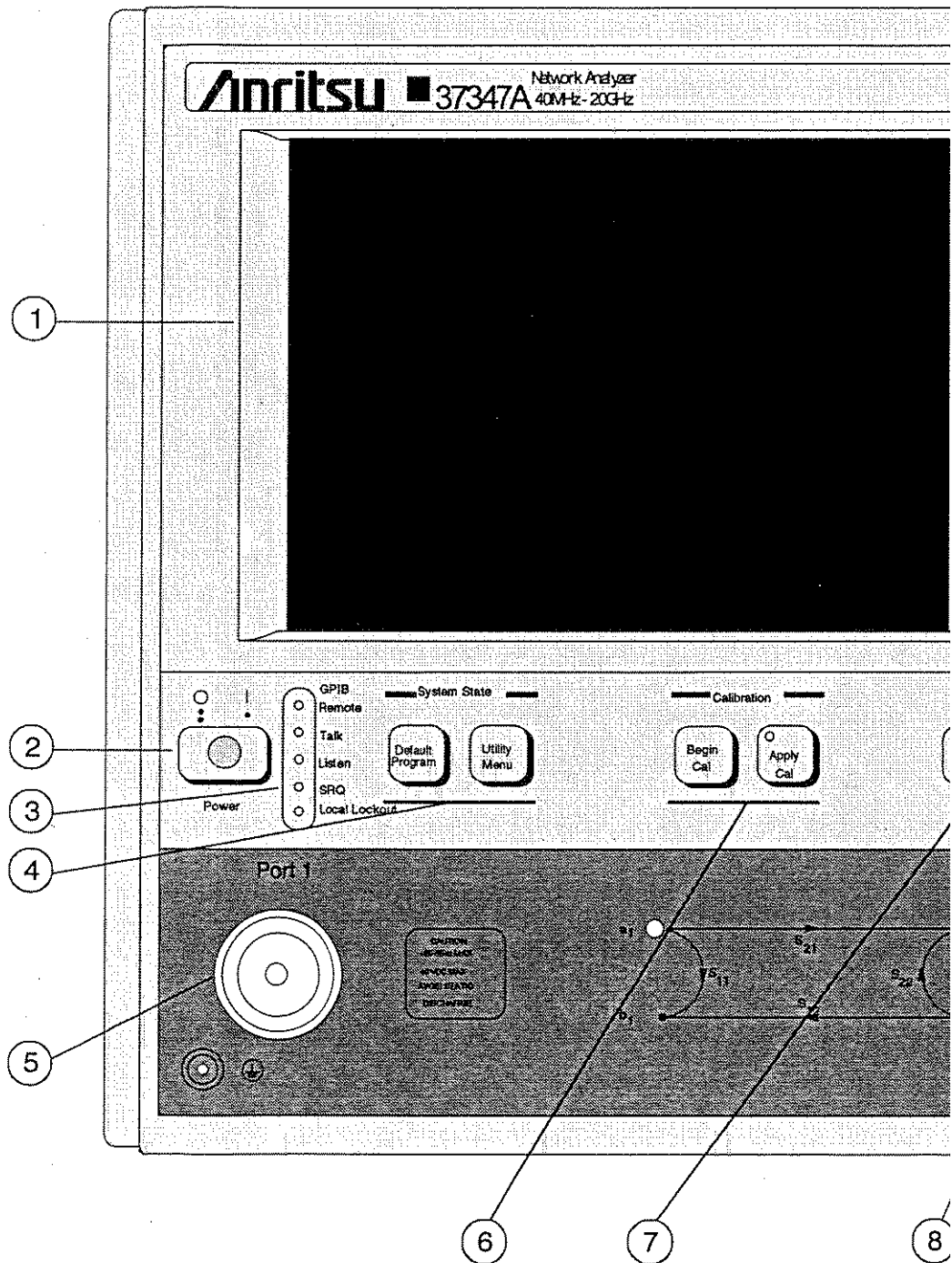

Figure 4-1. Model 373XXA Front Panel

Chapter 4

Front Panel Operation

4-1 INTRODUCTION

This chapter describes the front panel keys, controls, and menus. The chapter is organized into an overall description of the front panel key-groups and detailed descriptions of individual keys within the key-groups.

4-2 FRONT PANEL KEY-GROUP DESCRIPTIONS

The following pages provide descriptions of the front panel key-groups.

Index 1.

CRT display: Displays any or all of the four measurement channels, plus menus.

Index 2.

Power: Turns the 373XXA on and off. When on, the operating program runs a self test then recalls the parameters and functions in effect when powered down last.

Index 3.

GPIB Indicators

Remote: Lights when the 373XXA switches to remote (GPIB) control. It remains lit until the unit returns to local control.

Talk: Lights when you address the 373XXA to talk and remains lit until unaddressed.

Listen: Lights when you address the 373XXA to listen and remains lit until unaddressed.

SRQ: Lights when the 373XXA sends a Service Requests (SRQ) to the external controller. The LED remains lit until the 373XXA receives a serial poll or until the controller resets the SRQ function.

Local Lockout: Lights when a local lockout message is received. The LED remains lit until the message is rescinded. When lit, you cannot return the 373XXA to local control via the front panel.

Index 4.

System State keys

Default Program: Resets the front panel to the factory-preset state and displays Menu SU1 or SU3 (Appendix A). Pressing this key in conjunction with the "0" or "1" key resets certain internal memories and front panel key states (refer to paragraphs 4-5 and 4-10).

NOTE

Use of this key will destroy front panel and calibration setup data, unless they have been saved to disk.

Utility Menu: Displays the first in a series of menus that let you perform diskette and other utility-type functions and operations.

Index 5.

Port 1 Test Connector: Provides an input test connection for the device-under-test (DUT).

Index 6.

Calibration keys

Begin Cal: Calls up the first in a sequence of menus that guide you through a measurement calibration. Refer to paragraph 4-3 for a detailed discussion of the calibration keys, indicators, and menus.

Apply Cal: Turns on and off the applied error correction and tune mode.

Index 7.

Amplifier Loop: Provides for inserting additional amplification before the coupler.

Index 8.

Save/Recall Menu key: Displays the first of several menus that let you save the current calibration or front panel setup or recall a previously saved calibration or setup.

Index 9.

Hard Copy keys

Menu: Displays option menus that let you define what will happen each time you press the Start Print key. The displayed menu also selects disk I/O operations.

Start Print: Tells the printer or plotter to start output based on the current selections.

Index 10.

Stop Print: Immediately stops printing the data, clears the print buffer, and sends a form-feed command to the printer.

Markers/Limits keys

Marker Menu: Displays the first in a series of menus that let you set and manipulate marker frequencies, times, and distances.

Readout Marker: Displays a menu that lists all of the active markers. If no markers are active, the marker menu is displayed.

Limits: Displays one of the menus that let you manipulate the limit lines displayed on the CRT.

Index 11.

Port 2 Test Connector: Provides an input test connection for the device-under-test (DUT).

Index 12.**Display keys**

Graph Type: Displays the two menus that let you choose the graph type for the active channel.

Set Scale: Displays the appropriate scaling menu, based on the graph type for the active channel.

Auto Scale: Automatically scales the active channel for optimum viewing.

S Params: Displays Menu SP (Appendix A), which lets you choose between S11, S12, S21, or S22. You may display the same parameter on two or more channels.

Ref Plane: Displays the first of two menus that let you set the reference plane for the active channel in time or distance. For a correct distance readout, you must set the dielectric constant to the correct value. Refer to the discussion in menu RD2 (Appendix A).

Trace Memory: Displays the menus that let you do any of the following. (1) Store the measured data in memory. (2) View the stored data. (3) Add, subtract, multiply, or divide the measured data from the stored data (normalize to the stored memory). (4) View both the measured and the stored data simultaneously on the active channel. (5) Store/Recall saved data to disk. Four memories exist — one for

each channel. This lets you normalize the data in each channel independently. The LED on this button lights when the active channel is displaying memory data or measurement data normalized to memory.

Index 13.

Bias Input connectors

Port 1: Provides for supplying a bias voltage for the Port 1 input.

Port 2: Provides for supplying a bias voltage for the Port 2 input.

Index 14.

Enhancement keys

Option Menu: Displays a series of menus showing the choice of optional features.

Video IF BW: Displays a menu that lets you chose between 10 kHz, 1 kHz, 100 Hz, or 10 Hz intermediate frequency (IF) bandwidth filters.

Avg/Smooth Menu: Displays a menu that lets you enter values for Averaging and Smoothing.

Trace Smooth: Turns the trace smoothing function on and off.

Average: Turns the average function on and off.

Index 15.

Keyboard connector: Provides for connecting an external IBM-AT-type keyboard. All alphanumeric field entries can be input from this keyboard. These inputs include Device ID, Model, Date, Operator Identification, frequencies, filenames, as well as comment-type entries. The analog knob and keypad input for these entries remains active. The F1 thru F12 function keys can be used to access certain key and menu functions. A template is provided. Two versions of an actual-size template are provided in a folout page at the end of this chapter in the event a replacement is needed.

Index 16.

Diskette Drive: Provides a drive for the 3.5-inch, high-density (1.44 MB) floppy diskette used to store selected front panel setups and calibrations.

Index 17.**Channels keys**

Channel Menu: Displays a menu that lets you select the format for the number of channels displayed.

Ch 1: Makes Channel 1 the active channel. The active channel is the one acted on by the keys in the Display section. Only one channel can be active at any one time.

Ch 2: Makes Channel 2 the active channel.

Ch 3: Makes Channel 3 the active channel.

Ch 4: Makes Channel 4 the active channel.

Index 18.**Measurement keys**

Setup Menu: Displays the first of several menus that let you select functions affecting measurements.

Data Points: Displays a menu that lets you select between 1601, 801, 401, 201, 101, or 51 data points.

Hold: Toggles the instrument in and out of the hold mode; or it triggers a sweep, depending on the function selected in menu SU4 (Appendix A).

Domain: Displays the first in a series of menus that let you set the Time Domain display parameters. (This key is only active if your 373XXA is equipped with the Time Domain option.)

- If already in the Domain menus, pressing this key will return to the first menu in the sequence.
- If in the Domain menus and another (non-time domain) menu is displayed by pushing a menu key, the last displayed domain menu redisplay when the Domain key is next pressed.

Applications Menu: Displays the first in a series of menus that provide instructions for adapter removal and gain compression.

Index 19.**Data Entry keys**

Rotary Knob: Used to alter measurement values for the active parameter (Start Frequency, Stop Frequency, Offset, etc.).

Keypad: Provides for entering values for the active parameter. The active parameter is the one to which the menu cursor is pointing.

MHz/X1/ns/cm: Terminates a value entered on the keypad in the units shown—that is; megahertz for frequency, unity for dimensionless or angle entries, nanoseconds for time, or centimeters for length.

GHz/10³/ms/m: Terminates a value entered on the keypad in the units shown—that is; gigahertz for frequency, 1×10³ power for dimensionless or angle entries, microseconds for time, or meters for length.

kHz/10⁻³/ps/mm: Terminates a value entered on the keypad in the units shown—that is; kilohertz for frequency, 1×10⁻³ for dimensionless or angle entries, picoseconds for time, or millimeters for length.

Clear/Ret Loc:

- a. Local (Non-GPIB) Mode: (1) The key clears entries not yet terminated by one of the terminator keys above, which allows the previously displayed values to redisplay. Or (2) the key turns off the displayed menu and expands the data area to fill the entire screen, if you have not made any keypad entries needing termination.
- b. GBIB Mode: The key returns the instrument to local (front panel) control, unless the controller has sent a local lockout message (LLO) over the bus.

Index 20.**Menu keys**

Arrow keys: They move the menu cursor up and down to select items appearing in the menu area of the CRT.

Enter: Implements the menu selection chosen using the arrow keys.

**4-3 CALIBRATION
KEY-GROUP,
DESCRIPTIONS AND
MENU FLOW**

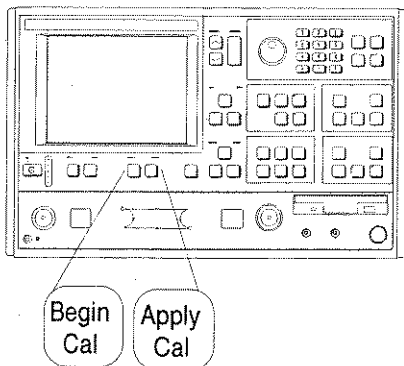

The Calibration keys (Begin Cal and Apply Cal, left) are described below. The calibration menus are diagrammed according to the method of calibration performed: Standard, Offset-Short, TRM or LRL/LRM. The menu sequencing is complex and looping and can be said to have two parts: setup and calibration. The setup flow for the four calibration methods is diagrammed in Figures 4-2 thru 4-5. Each setup flow chart leads to the main calibration sequence, which is diagrammed in Figure 4-6. A full description of each menu is provided in Appendix A, where the menus are arranged in alphabetical order by call letter (C1, C2, C3, etc).

Begin Cal Key: This key displays a menu that lets you initiate the calibration sequence. That is, to begin a sequence of steps that corrects for errors inherent in a measurement setup.

Apply Cal Key: This key displays a menu (left) that lets you turn on and off the error correction that may be applied to the displayed channel(s) using the currently valid error-correction indicator. Additionally, the menu lets you turn tune mode on and off and change the number of forward sweeps between reverse sweeps (or reverse sweeps between forward sweeps).

```

MENU CAL_APPLIED

  APPLY
  CALIBRATION

  FULL 12-TERM
  (S11, S21
  S22, S12)

  APPLY ON (OFF)
  CALIBRATION

  TUNE MODE ON (OFF)

  NO. OF FWD (REV)
  SWEEPS BETWEEN
  REV (FWD) SWEEPS
  XXXXX SWEEPS
  (XXXXX REMAINING)

  PRESS <APPLY CAL>
  TO TURN ON/OFF

  PRESS <ENTER>
  TO TURN ON/OFF
    
```

NOTE

Pressing the Clear key while in a calibration setup or sequencing will let you abort the calibration and return to the first setup menu.

Standard Calibration Setup Flow- Description

1. Pressing the Begin Cal key calls Menu C11.
2. With one exception, the flow is from left to right in the direction of the arrow head. The exception occurs in Menu C1, for the TIME DOMAIN choice. Here the flow direction reverses to Menu C2C then returns to a left-to-right flow on to Menu C3 or C3D.
3. Arrowheads that point both left and right indicate that the flow returns to the right-most menu after a choice had been made.
4. The group of menus to the left of Menu C3 and C3D are the initial selection set and are essentially the same for all four calibration types: Standard, Offset-Short, TRM, and LRL/LRM.
5. The group of menus that follow Menu C3 or C3D are, for the most part, type specific. The selection of Menu C3 or C3D depends upon the choice made in Menu C11A: COAXIAL or MICROSTRIP. For the Standard Calibration, the WAVEGUIDE selection in Menu C11A is not used.

FRONT PANEL OPERATION

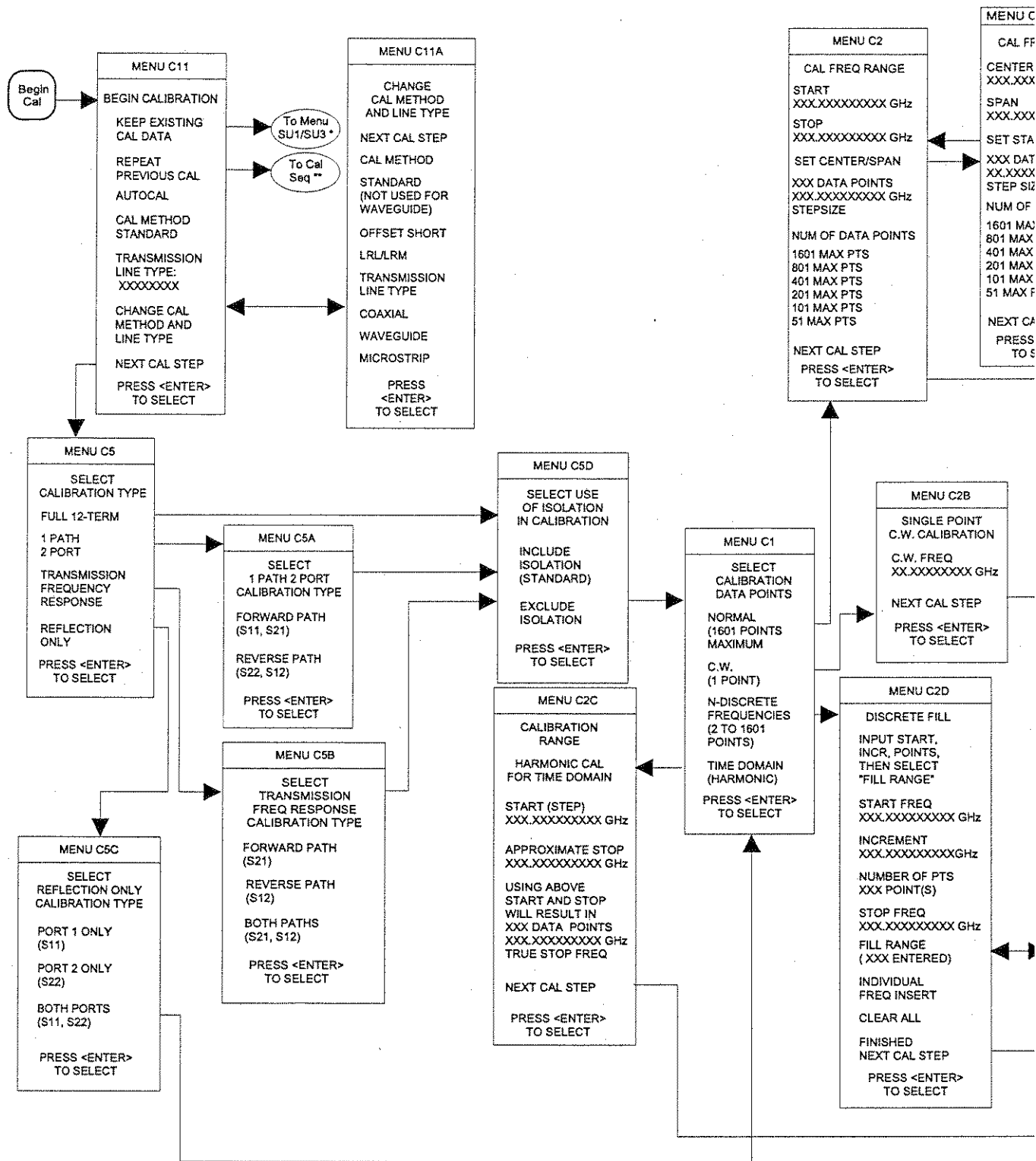

* Setup Menu SU1/SU3 – See Figure 4-6

** Cal Seq (Calibration Sequence) – See Figure 4-5

FRONT PANEL OPERATION

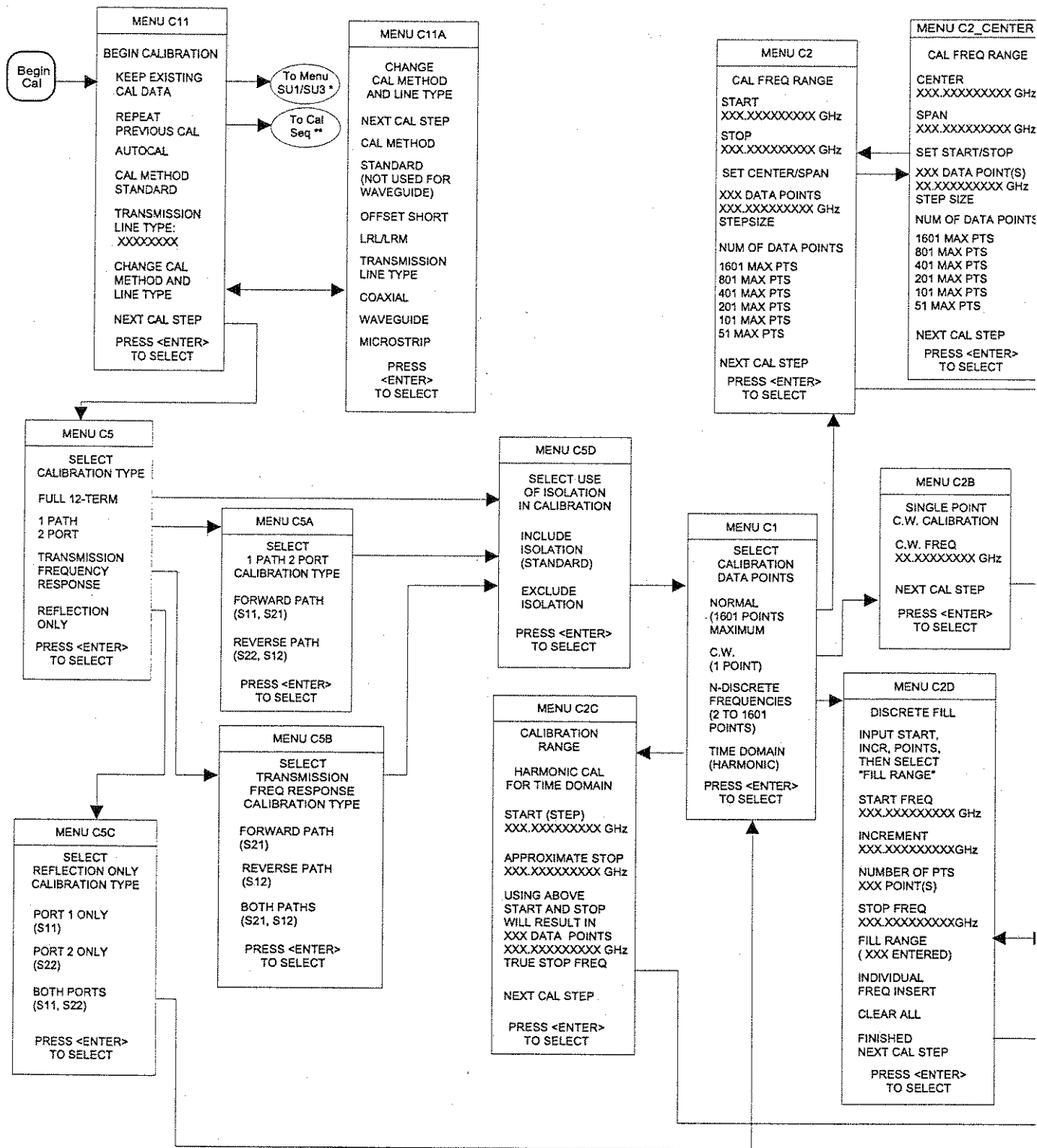

FRONT PANEL OPERATION

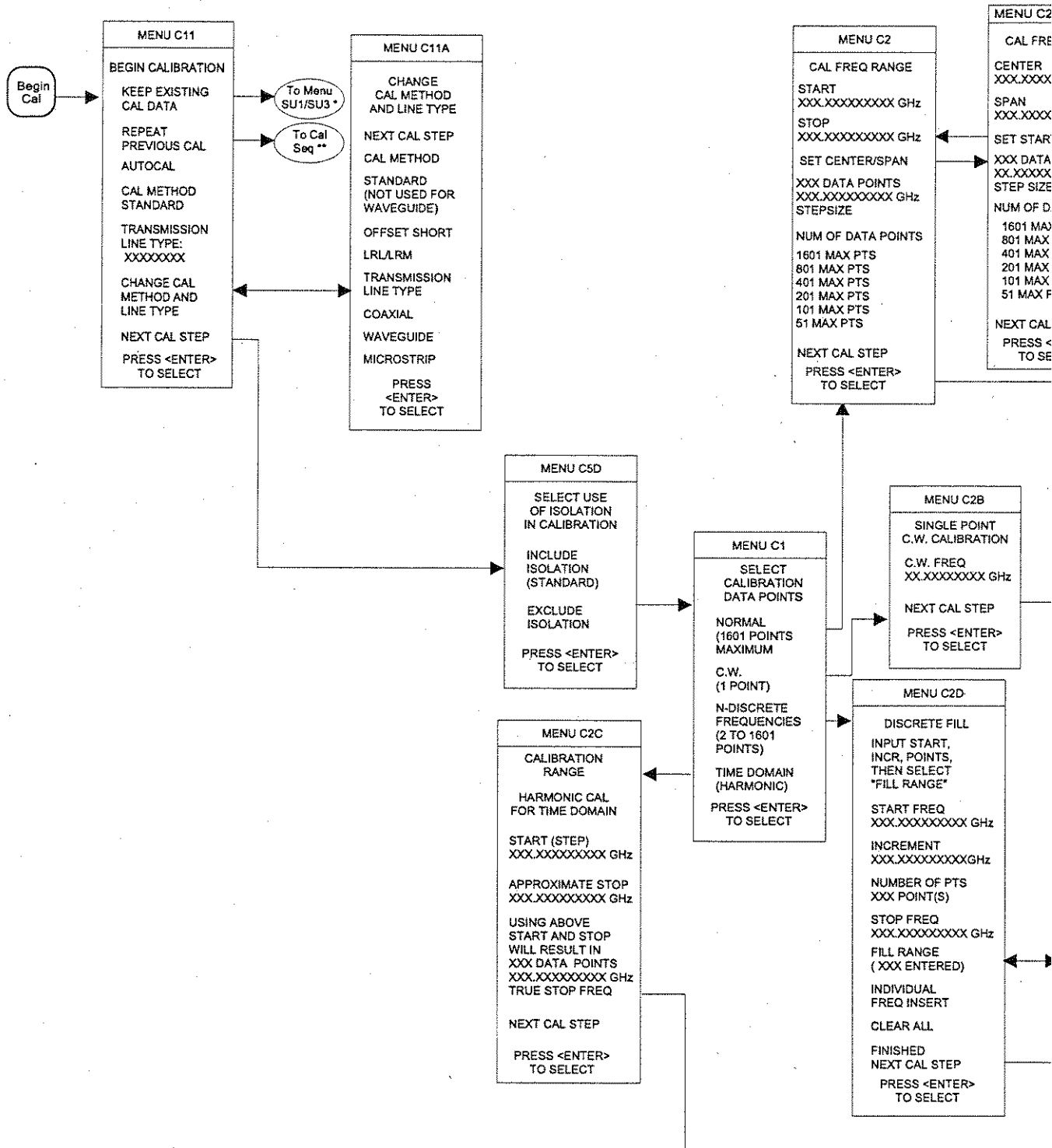

FRONT PANEL OPERATION

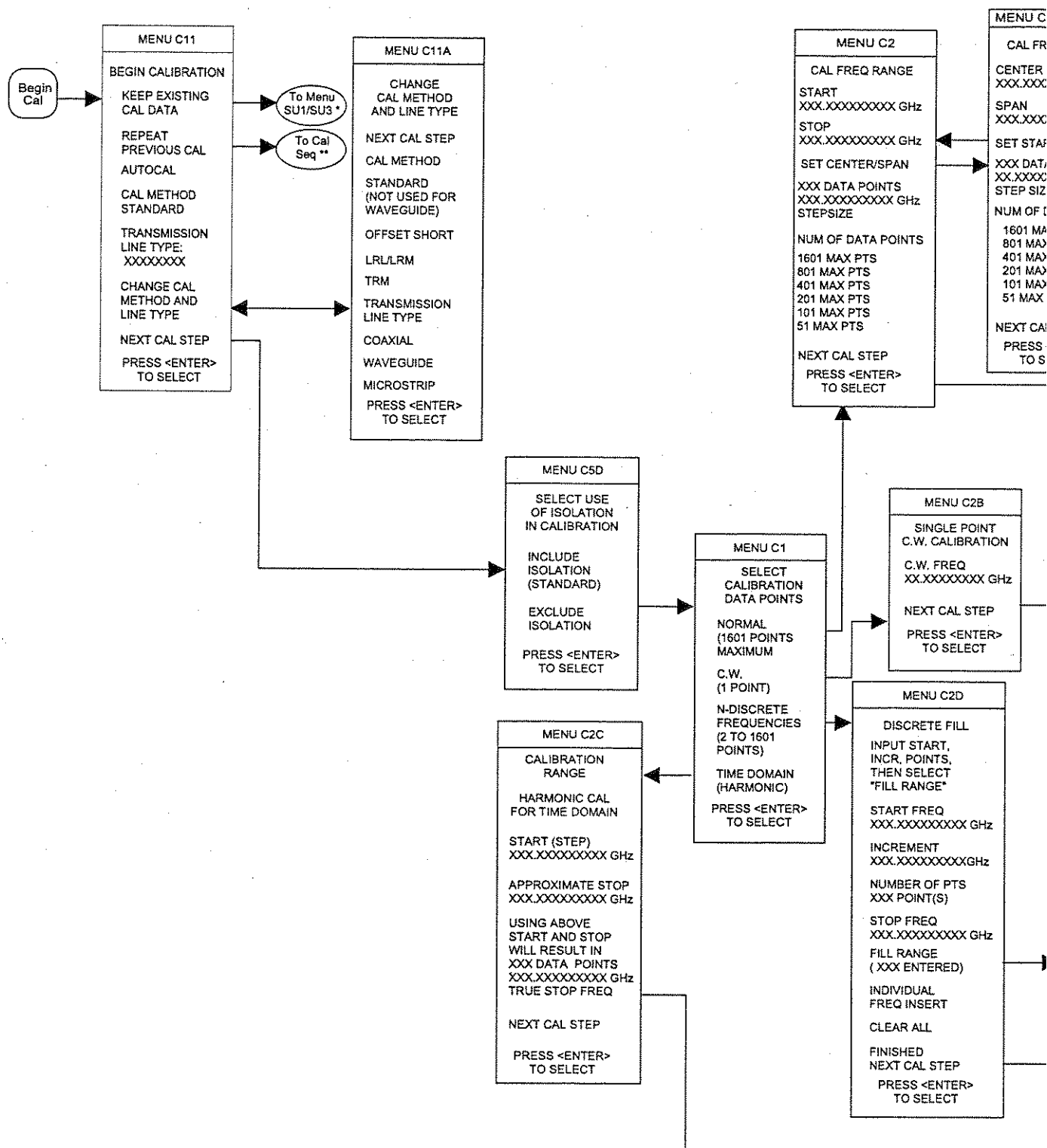

**4-4 SAVE/RECALL MENU
KEY, DESCRIPTION AND
MENU FLOW**

Pressing this key displays the first of a menu set (below) that lets you save or recall control panel setups and calibration data. Full menu descriptions can be found in the alphabetically ordered Appendix A under the menu's call letters (SR1, SR2, SR3, etc).

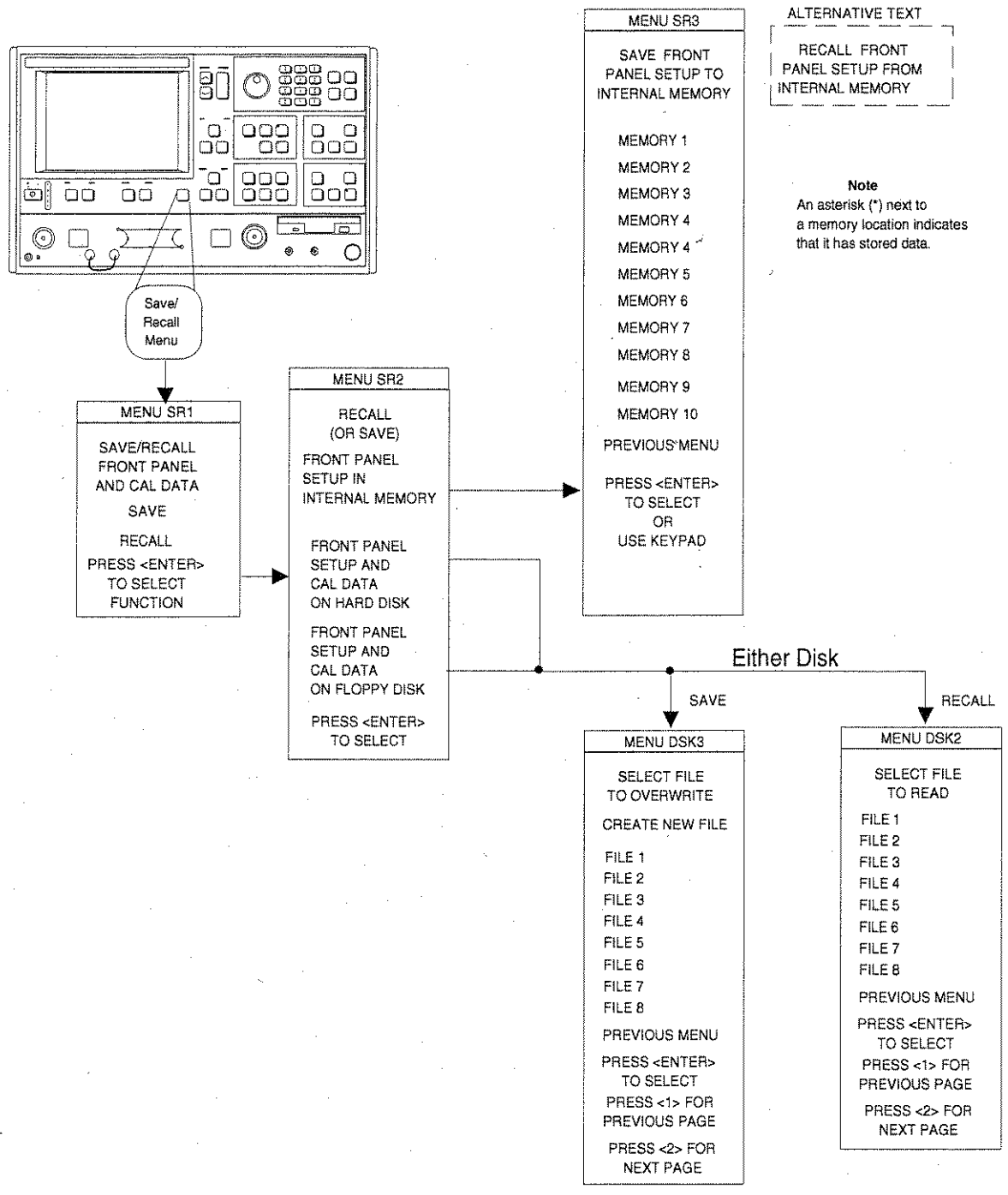

**4-5 MEASUREMENT
KEY-GROUP,
DESCRIPTION AND
MENU FLOW**

The individual keys within the Measurement key-group are described below. Flowcharts of the Setup Key and Data Points key menus are shown in Figure 4-7. As described for the calibration menus, the flow is left-to-right and the double arrowheaded lines indicate that the flow returns to the calling menu once a selection has been made. Full menu descriptions can be found in the alphabetically ordered Appendix A under the menu's call letters (SU1, SU2, DF, etc).

Setup Menu Key: Pressing this key calls Sweep Setup Menu SU1 or SU3. Depending upon which menu items you select, additional menus may also be called.

Data Points Key: Pressing this key calls Menu SU9 or SU9A. Menu SU9 provides for data point selection. Menu SU9A is called if the C.W. MODE selection in Menu SU1 is on.

Hold Key: If the instrument is sweeping, pressing this key results in an immediate halt of the sweep at the current data point. The LED on the button lights, indicating that the Hold Mode is active.

If you restart the sweep after performing any recall-from-disk operations in the Hold Mode (sweep stopped at some data point), the sweep restarts from the beginning. The instrument may be taken out of the hold mode as follows:

- By pressing the Default Program button. This causes the 373XXA to revert to a predefined state.
- By pressing the BEGIN CAL key. This causes the 373XXA to resume sweeping and begin the Calibration Menu sequence.

NOTE

See the description for Menu SU4 for a discussion of the interaction between the Hold Mode and the selection of "Single Sweep" or "Restart Sweep"

Domain Key: This key function is fully described in paragraph 4-2 (page 4-7). Additionally, if the Time Domain option is installed, making a selection other than "Frequency Domain" lets you display measured data in the time domain. It also calls a further sequence of Time Domain Menus. Refer to paragraph 9-2 for additional details.

AppI: Pressing this key calls a menu that lets you select the following applications: Adapter Removal, Swept Frequency Gain Compression, or Swept Power Gain Compression.

**4-6 CHANNELS KEY-GROUP,
DESCRIPTION AND
MENU FLOW**

The individual keys within the Channels key-group are described below.

Ch 1-4 Keys: These keys (below) define the active channel. One (and only one) must always be active as indicated by the associated LED. Pressing a button makes the indicated channel active. If channel indicated by the key is already active, pressing the key has no effect.

The active channel will be the channel acted upon by the S Params, Graph Type, Ref Plane, Trace Memory, Set Scale, Auto Scale, Markers/Limits and Domain keys. When in the single channel display mode, the active channel will be the one displayed.

Channel Menu : Pressing this key calls menu CM (below). Here, you select the number of channels to be displayed. When in the single display mode, only the active channel will be displayed. Full menu description can be found in the alphabetical listing (Appendix A) under the menu's call letters (CM).

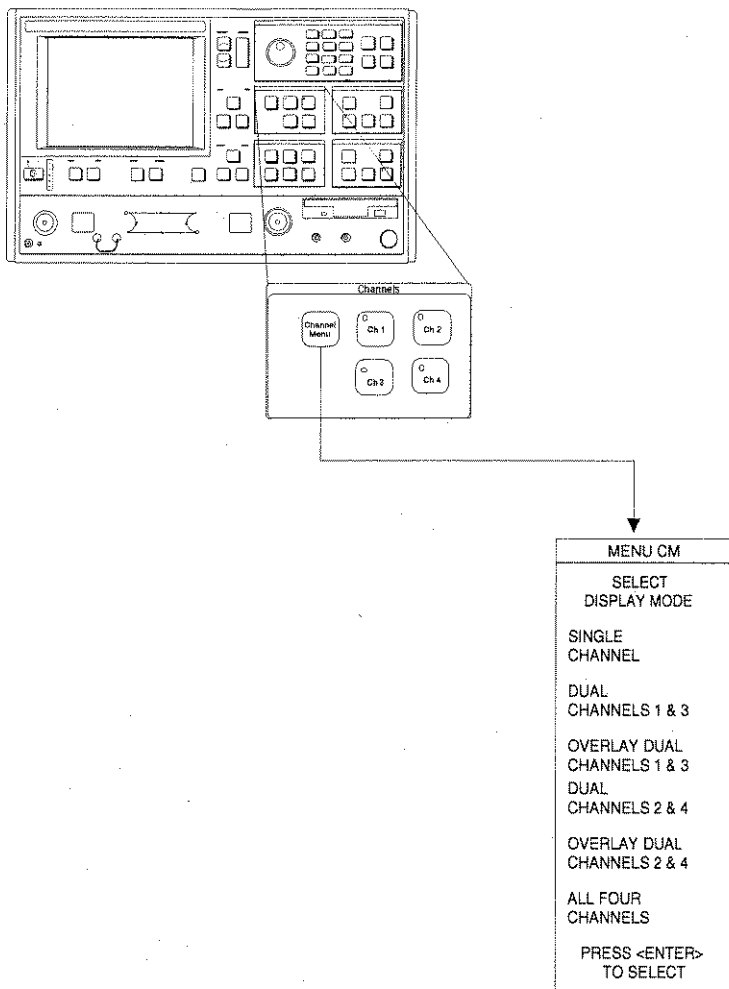

**4-7 DISPLAY KEY-GROUP,
DESCRIPTION AND
MENU FLOW**

The individual keys within the Display key-group are described below. Menu flow diagrams are shown in Figure 4-8. Full menu description(s) for menu SP and all others mentioned below can be found in the Appendix A alphabetical listing under the menu's call letters (SP, GT1, RD1, etc).

Graph Type Key: Pressing this key calls menu GT1 or GT2. These menus let you select the type of display to appear on the active channel for the selected S-Parameter.

Set Scale Key: Pressing this key calls the appropriate scaling menu (SS1, SS2, SS3, etc.) depending upon the graph type being displayed on the active channel for the selected S-Parameter.

Auto Scale Key: Pressing this key autoscales the trace or traces for the active channel. The new scaling values are then displayed on the menu (if it is displayed) and graticule. The resolution will be selected from the normal sequence of values you have available using the knob. When the active channel has a Real and Imaginary type display, the larger of the two signals will be used to autoscale both the real and imaginary graphs. Both graphs will be displayed at the same resolution.

S Params Key: Pressing this key calls menu SP. This menu allows you to select the S-Parameter to be displayed by the active channel for the selected S-Parameter.

Ref Plane Key: Pressing this key calls menu RD1. This menu lets you input the reference plane in time or distance. You do this by selecting the appropriate menu item. For a correct distance readout, the dielectric constant must be set to the correct value. This is accomplished by selecting SET DIELECTRIC, which calls menu RD2.

On menu RD1, selecting AUTO automatically adjusts the reference delay to unwind the phase for the active channel.

The 373XXA unwinds the phase as follows:

- First, it sums the phase increments between each pair of measured data points, then it takes the average “Pdelta” over the entire set of points.
- Next, it corrects the phase data by applying the following formula:

$$P_{correct} = P_{measured} - NxP_{delta}$$

Where P = phase

Assuming there are fewer than 360 degrees of phase rotation between each data point, the operation described above removes any net phase offset. The endpoints of the phase display then fall at the same phase value.

Trace Memory Key: Pressing this key brings up menu NO1. This menu—which relates to the active channel—allows you to store data to memory, view memory, perform operations with the stored memory, and view both data and memory simultaneously. Four memories exist, one for each channel. This allows each channel to be stored and normalized independent of the other channels. Data from the trace memory may be stored on the disk or recalled from it.

NOTE

Trace memory will automatically be set to “VIEW DATA” (that is, turned off), if a sweep with a greater number of points is selected while operating on a stored trace.

DISPLAY KEY-GROUP

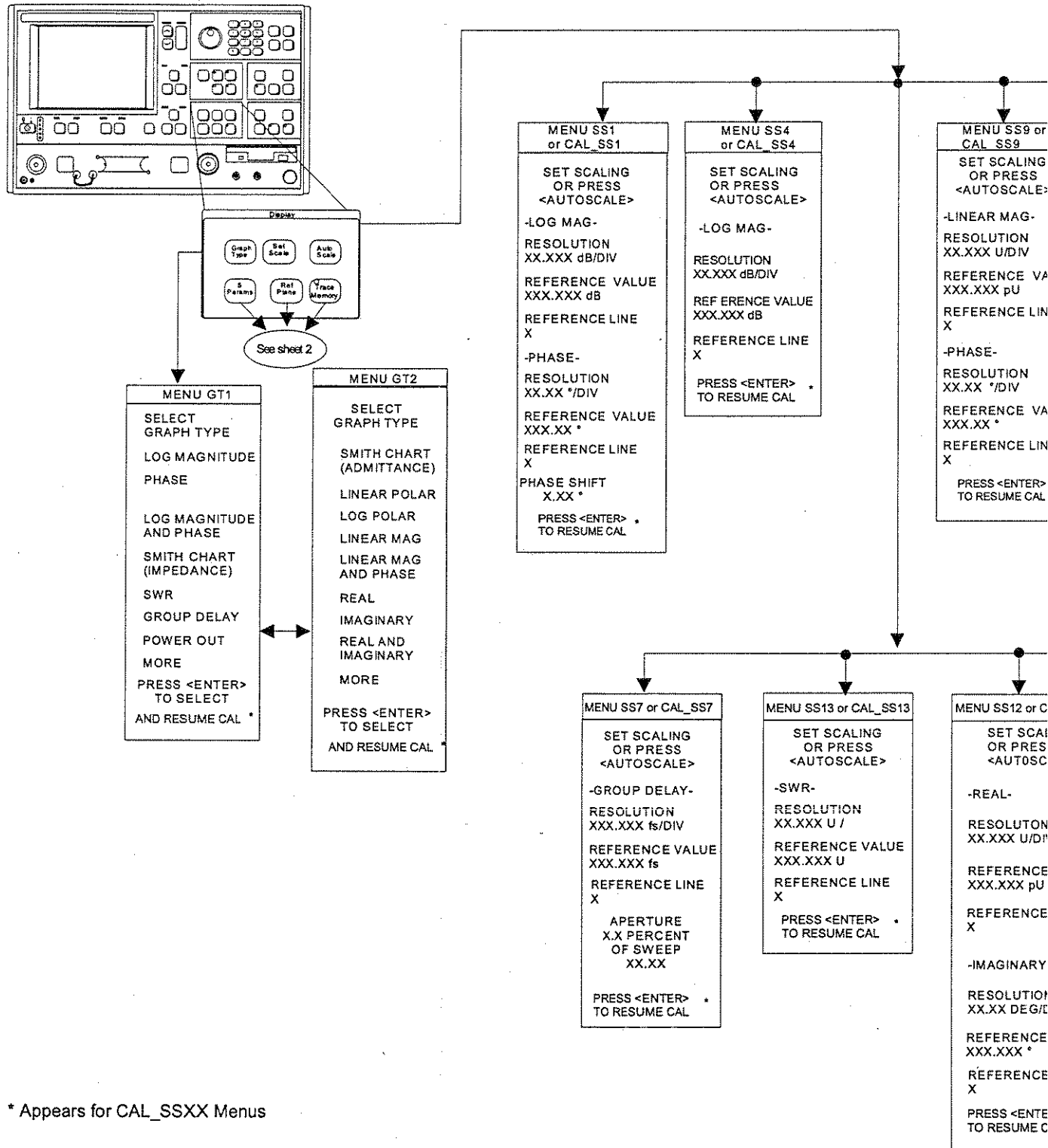

* Appears for CAL_SSXX Menus

FRONT PANEL OPERATION

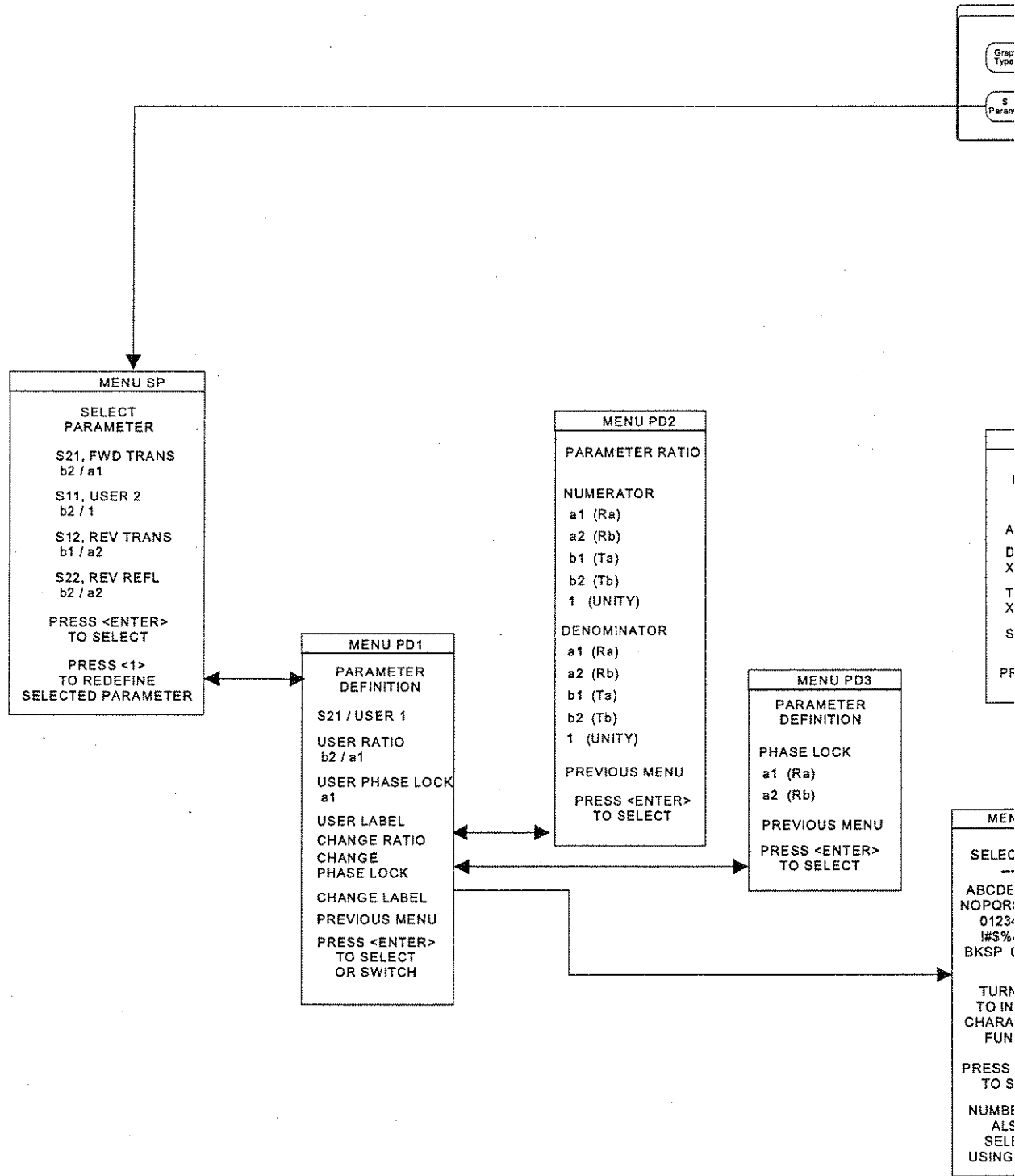

Figure 4-8. Display Key-Group Menus (2 of 2)

FRONT PANEL OPERATION

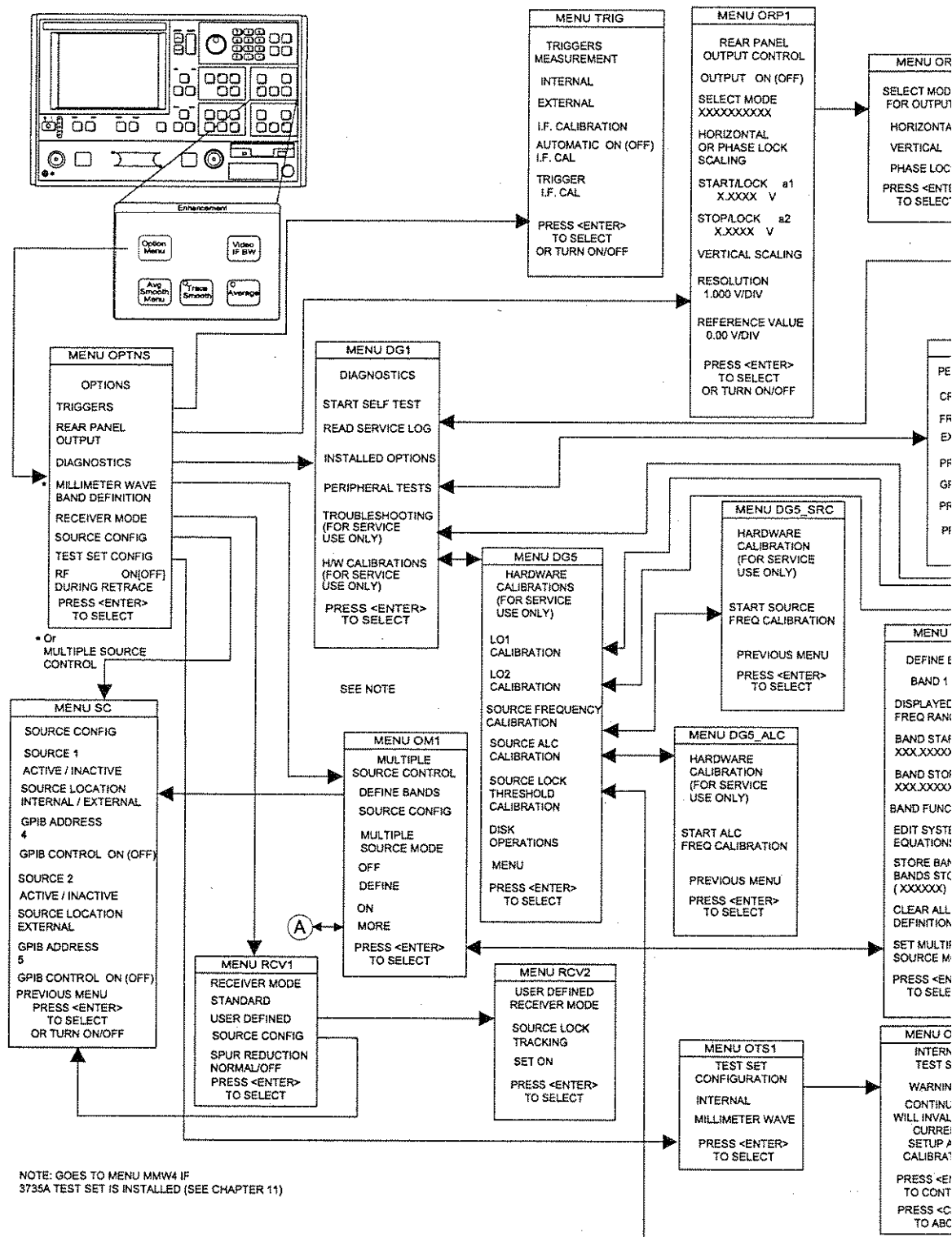

Figure 4-9. Enhancement Key-Group (Options Menu Key)

FRONT PANEL OPERATION

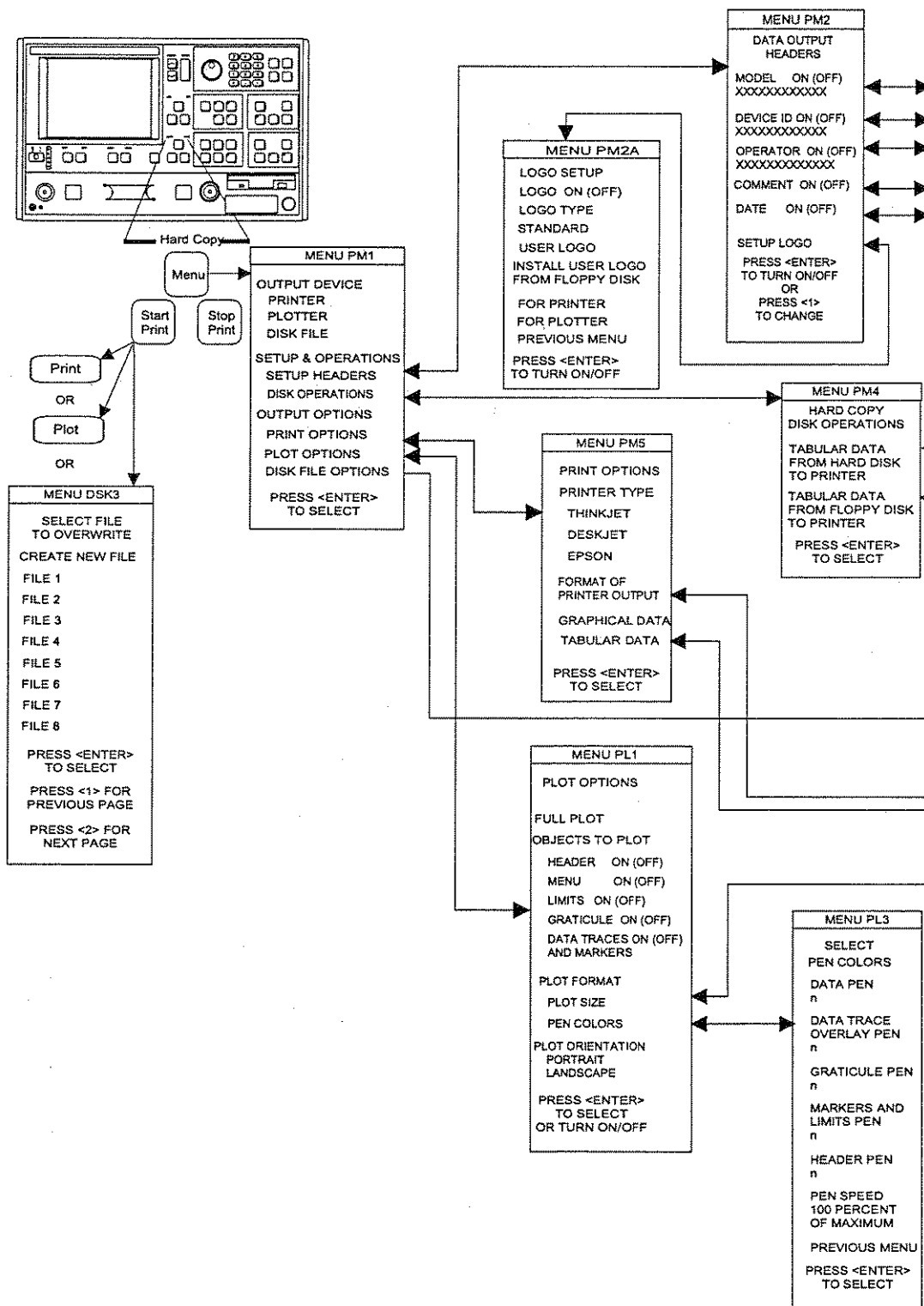

Figure 4-10. Hard Copy Key-Group Menus

4-11 **MARKERS/LIMITS KEY-GROUP, DESCRIPTION AND MENU FLOW**

The individual keys within the Markers/Limits key-group are described below. The menu flow for the Marker Menu key is shown in Figure 4-12. Full descriptions for these menus can be found in the alphabetical listing (Appendix A) under the menu's call letters (M1, M2, M3, etc.)

Marker Menu Key: Pressing the Marker Menu key calls Menu M1. This menu lets you toggle markers on and off and set marker frequencies, times, or distances.

Readout Marker Key: Pressing this key calls different menus, depending upon front panel key selections, as described below.

- It calls menu M1 if there are no markers available within the selected frequency range.
- It calls menu M3 if no Delta ref marker has been selected.
- It calls menu M4 if the DReference mode is off and the selected marker is in the current sweep range (or time/distance).
- It calls menu M5 if the DReference mode and marker are both on and the DReference marker is in the selected sweep range (or time/distance).
- It calls menu M6 if ACTIVE MARKER ON ALL CHANNELS has been previously selected in menu M9.
- It calls menu M7 if SEARCH has been previously selected in menu M9.
- It calls menu M8 if FILTER PARAMETER has been previously selected in menu M9.

Marker Readout Functions This menu choice, which appears on several marker menus, provides for several filter-related measurements. It also allows for performing a marker-value search and for reading the active marker value on all displayed channels.

Limit Frequency Readout Function The 373XXA has a Limit-Frequency Readout function. This function allows frequency values to be read at a specified level (such as the 3 dB point) on the data trace. This function is available for all rectilinear graph-types.

The graph-type and their menu call letters are listed below

Log Magnitude, Menu LF1

- Phase, Menu LF2
- Group Delay, Menu LF3
- Linear Magnitude, Menu LF4
- SWR, Menu LF5
- Real, Menu LF6
- Imaginary, menu LF7
- Power Out, menu LF8
- Full menu descriptions can be found in the alphabetical listing (Appendix A) under the menu call letters (LF1, LF2, LF3, etc.)
- Limits Key

Pressing this key calls the appropriate Limit menu, based on the graph type selected using the Graph Type key and menu.

4-12 DISK STORAGE INTERFACE

The 373XXA has two internally mounted disk drives: an 80 MB hard disk and a 3.5 inch floppy. The format, files, and directory are compatible with MS-DOS, Version 5.0 and above.

Disk Format Floppy diskettes are MS-DOS compatible and have a 1.44 MByte capacity.

Disk Files You may find any of the following file-types on the 373XXA disk.

- Program Files. These are binary files used to load the operating program. They are provided on the hard drive, and a backup copy is provided on floppy diskettes. Applications programs cannot read them.
- Calibration Data Files: These are binary files used to store and retrieve calibration and other data. Applications programs cannot read them. File size depends on calibration type.
- Text Files: These are tab-delimited ASCII files with the "txt" file extension. They can be read by application programs.
- S2P Parameter Data Files: These files define a 2-port file format that includes all four S parameters. They can be read by applications programs. They have a file extension of "S2P."
- Tabular Measurement Data Files. These are ASCII files used to store actual measurement data. They can be read by applications programs. File size depends on selected options.
- Trace Memory Files. These are binary files used to store trace data. Applications programs cannot read them. You use them to perform trace math operations on data.
- Cal Kit File for Coax or Waveguide.

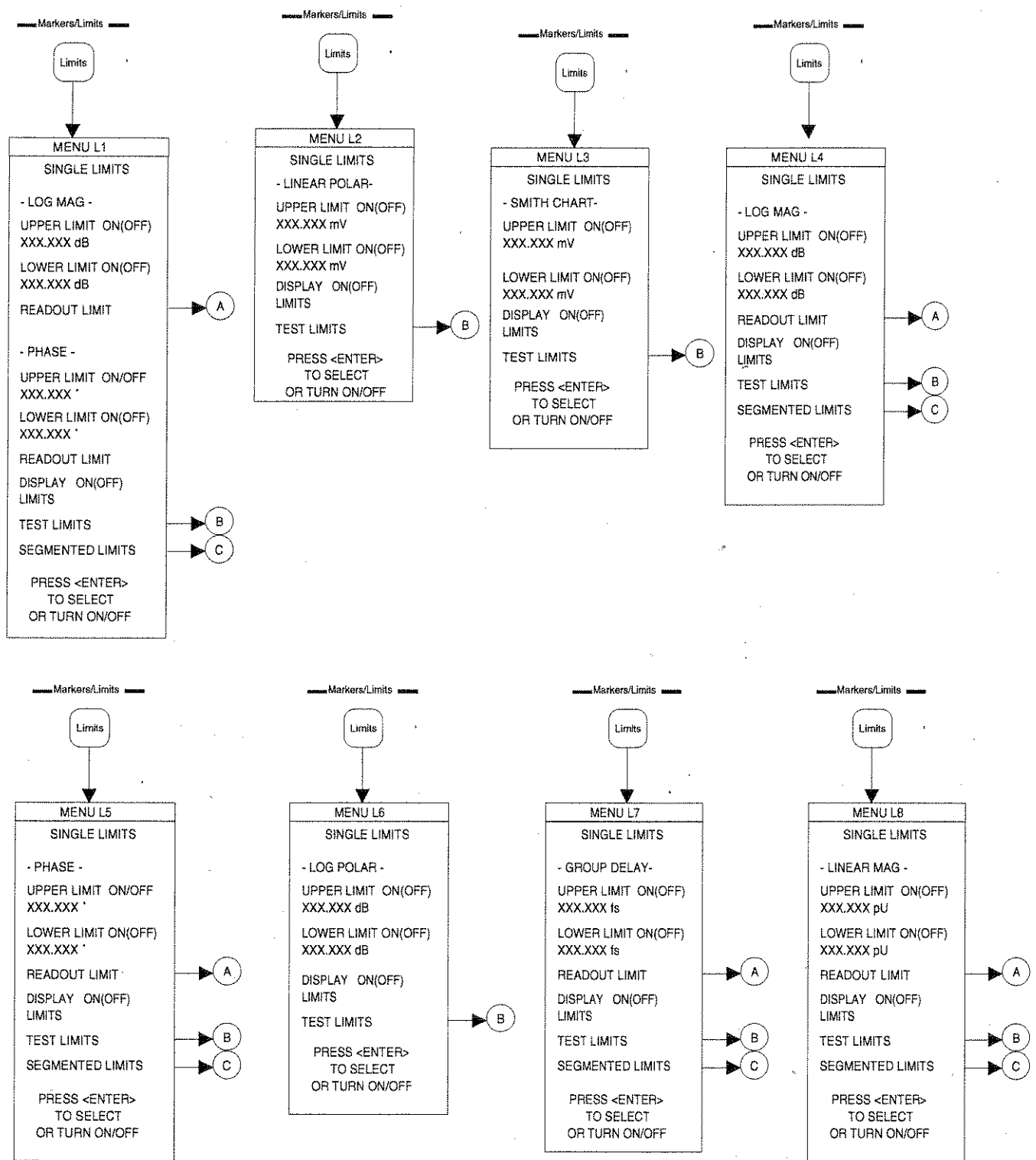

Figure 4-12. Markers/Limits Key-Group Menus (2 of 3)

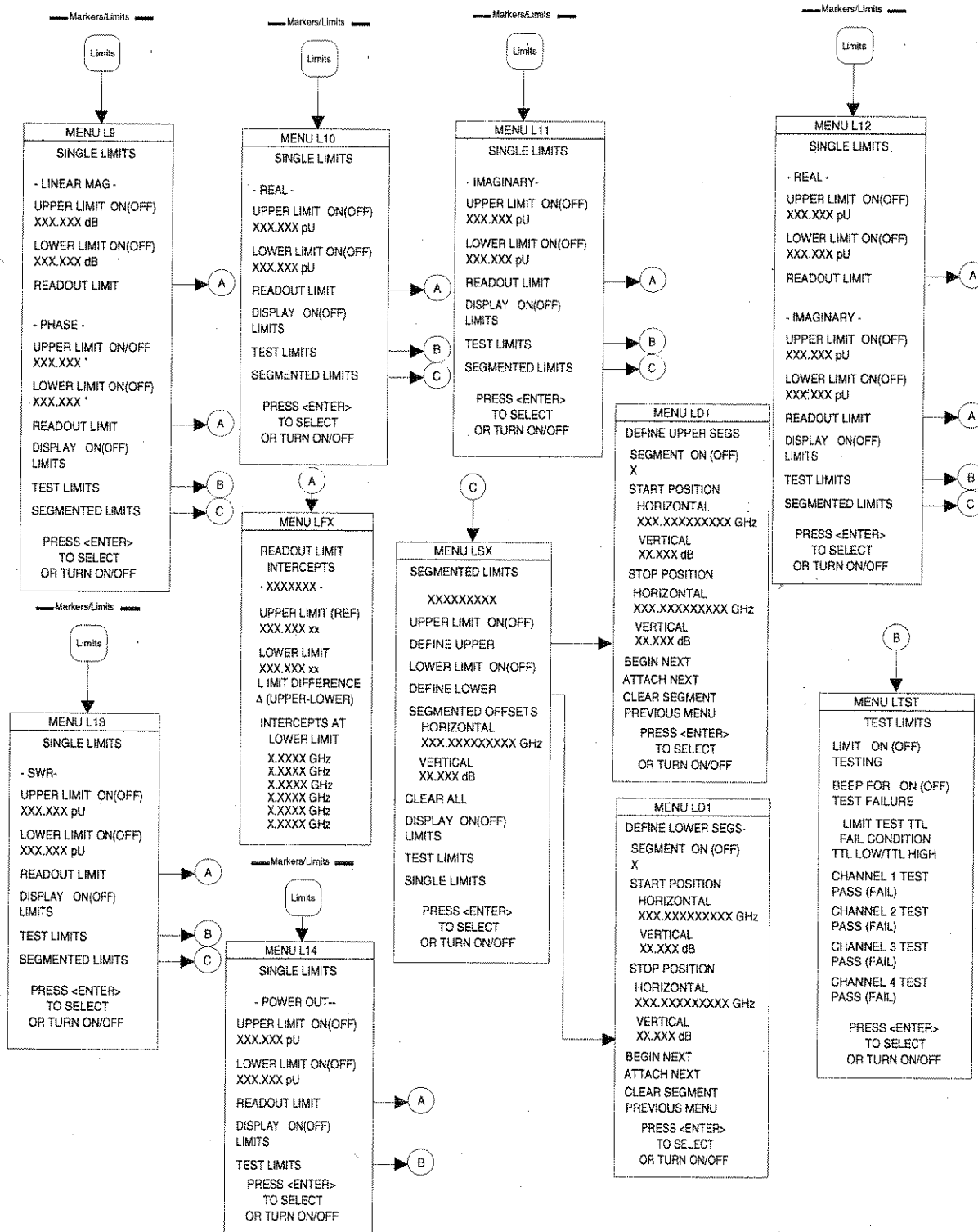

Figure 4-12. Markers/Limits Key-Group Menus (3 of 3)

***Disk File
Output
Device***

You can select the output drive destination for the disk file as either the hard disk (C:) or the floppy drive (A:). The format of the disk file is also selected. The default condition is text disk file to the hard disk.

You may then proceed with normal measurements. The Start Print key may then be used at the instant you intend to capture the data. Menu DISK 3 then appears and allows the creation of a new file or to overwrite an existing file in the current directory.

Note that the output for text and S2P files have pre-defined formats. Tabular data format is configured via the Print Options (Menu PM5) or Tabular Data (Menu PM3). Bitmap format is configured via the Print Options (Menu PM5), Options (Menu PM5), or Graphical Data (Menu PM3A). HPGL format is configured via the Plot Options (Menu PL1).

You are able to direct hard copy output to the HDD or floppy, in addition to the printer and plotter. In addition to text (*.txt), S2P (*.s2p), and tabular (*.dat) files, bitmaps (*.bmp) and HPGL (*.hgl) files are offered to satisfy your desktop publishing requirements. Specifically, color bitmaps and graphic language files can be imported into Windows applications, such as Cap3700.

***Formatting a
Data File
Disk***

You may format additional diskettes to hold calibration, tabular measurement, and trace-memory data files. Do this using the FORMAT DISK selection on the "Floppy Disk Utilities" menu. Using this selection will format the target disk and overwrite any existing data it contains.

A format hard disk utility is provided in case of hard disk failure. Using this feature overwrites your system software and requires booting from the backup floppy diskettes.

***Copying
Data Files
From Disk to
Disk***

Use the COPY FILES selection on the "Floppy Disk Utilities" and "Hard Disk Utilities" menus to copy data files between hard and floppy diskettes.

***Recovering
From Disk
Write/Read
Errors***

If you experience a read or write error during a disk operation, you should:

- Verify that the diskette has been properly formatted.
- Verify that the diskette is high density (1.44 MB). Low density (720 KB) diskettes are not supported.
- Verify that the write-protect tab on the disk is engaged.
- Retry the disk operation.

Repeated disk errors may indicate a defective diskette and format.

4-13 COMMAND LINE

The Command Line menu choice provides several DOS compatible commands.

Command line options are

- CREATE DIRECTORY (MD)
- LIST DIRECTORY (DIR)
- CHANGE DIRECTORY (CD)
- DELETE FILES (DEL)
- REMOVE DIRECTORY (RD)
- COPY FILES (COPY).

These options are NOT case sensitive.

***Create
Directory***

This command is performed by MD c:\pat-h\dir_name or md a:\path\dir_name. The c: is used to refer to the hard disk, and a: is for the floppy disk.

***List
Directory***

This command is performed by "DIR" command. This may be used as DIR c:\path or without any path specified. The syntax is:

DIR c:\path or DIR a:\path.

If c: or a: is not used, the default is the current hard disk directory. You may use wild cards as follows:

- DIR *.cal
- DIR filter?.cal

***Change
Directory***

This command is performed by CD c:\path or CD a:\path. Both of these options do not require a device name. The device name is referred to by c: or a:.

If you choose to do CD dir_name, this implies the current Hard disk directory.

Delete Files

This command is used to delete a particular file(s) in a directory, or delete the entire contents of the directory by using the wild card option. The command line is:

- DEL filename
- DEL c:\path\filename
- DEL a:\path*

***Remove
Directory***

This command is used to delete a particular directory. The command IS ONLY VALID when the entire directory is empty.

- RD c:\path\directory
- RD a:\path\directory

Copy Files

This command is performed by the command line COPY source: destination:

COPY c:\path\name a:\path\name

Any combination of the drive is allowed, except for the same directory, and the same name.

Once the COMMAND LINE is selected, the system will prompt a one line dialog box to allow command entry. The dialog box remains open only for the user interface.

Conventions

Be aware of the following conventions when using the Command Line choice.

There is a limitation of five sublevel directories in the 37xxx models.

- Any directory change will force the system to use that as the current directory for other menus that deal with the file system. For example, if the user changes the directory to c:\lib\junk, then any activity for saving hardcopy or calibration files will be saved on the junk directory.

- ❑ The default directory is the root directory.
- ❑ GPIB support: GPIB mnemonics will provide functionality for each of the above operations. The format is shown below.

Function	Path
List directory	DIR "[device:][path]name"
Make directory	MD "[device:][path]name"
Change directory	CD "[device:][path]name"
Delete File(s)	DEL "[device:][path]name"
Remove directory	RD "[device:][path]name"
Copy files	COPY "[device:][path][source]" "[device:][path][destination]"

FUNCTION KEYS TEMPLATE

 Vector Network Analyzer Clear/Ret Loc ____ Esc Start Print ____ Print Screen, F12 Hold ____ Pause <small>Copyright (c) 1994-98 by Anritsu Company</small>	Default Program		Utility Menu	Options Menu	<i>Ctrl</i>	Commar
	Avg/Smooth Menu	Trace Smooth	Average	Video IF BW	<i>Alt</i>	Line
Channel Menu	Marker Menu	Readout Marker	Limits	<i>Shift</i>		S Param
Ch 1	Ch 2	Ch 3	Ch 4			Graph Ty

F1

F2

F3

F4

F5

 Vector Network Analyzer Clear/Ret Loc ____ Esc Start Print ____ Print Screen, F12 Hold ____ Pause <small>Copyright (c) 1994-98 by Anritsu Company</small>	Default Program		Utility Menu	Options Menu	<i>Ctrl</i>	Commar
	Avg/Smooth Menu	Trace Smooth	Average	Video IF BW	<i>Alt</i>	Line
Channel Menu	Marker Menu	Readout Marker	Limits	<i>Shift</i>		S Param
Ch 1	Ch 2	Ch 3	Ch 4			Graph Ty

F1

F2

F3

F4

F5

Actual-Size Keyboard

Chapter 5

Error and Status Messages

Table of Contents

5-1	INTRODUCTION	5-3
5-2	ERROR MESSAGES	5-3

Chapter 5

Error and Status Messages

5-1 INTRODUCTION

This chapter lists, describes, and provides corrective action for the error messages that point to problems that the operator can correct. Any error messages that appear on the display but do not appear in this chapter will require action by a qualified service representative.

5-2 ERROR MESSAGES

Error messages are provided in Tables 5-1 and 5-2.

Table 5-1. General Error Messages (1 of 3)

Error Message	Description	Corrective Action
ATTENUATOR UNAVAILABLE	Option 6 Port 2 Test Step Attenuator is not installed.	Install Option 6 Step Attenuator.
BANDS MUST SEQUENCE	Frequency bands in Multiple Source mode must sequence in a 1-2-3-4-5 order.	None, no skipping is allowed.
BOTH LIMITS MUST BE ON	Must have both limits activated.	Turn on limits.
DIFFERENT H/W SETUP. RECALL ABORTED	Source or is different from the recalled setup.	Reconfigure system to duplicate the hardware setup that was used to store the saved data.
DIFFERENT S/W VERSION, RECALL ABORTED	Saved state not compatible with hardware or software version.	Load compatible software (S/W) version and retry.
DISCRETE FREQS LOST	Change in frequency caused discrete fill frequencies to be lost.	None.
DISPERSIVE MEDIUM, ONLY TIME USED	Distance does not apply for dispersive media.	None.
FREQUENCIES HAVE REACHED UPPER LIMIT	Frequencies being defined in Multiple Source mode have reached upper limits of Sources.	Redefine frequencies to not exceed limits of Sources.
ILLEGAL IN C.W. MODE	Attempted to readout limit frequency.	None, no limit lines are permitted in CW mode.
ILLEGAL IN TIME DOMAIN	Attempted to readout limit frequency	None.
LOGO FILE NOT FOUND	Attempted to read a non-existent logo file from disk.	Create user-defined logo using application on external controller.
MEAS DATA NOT AVAILABLE FOR STORAGE	Measurement data is not available for storage on floppy or hard disk.	None.
MEMORY LOCATION CORRUPTED	Requested memory location is corrupted.	None. If problem reoccurs after storing a new setup, contact ANRITSU Customer Service.
NO BANDS ARE STORED	No frequency bands have been defined and stored.	Need to define and store frequency bands to turn on Multiple Source mode.

Table 5-1. General Error Messages (2 of 3)

Error Message	Description	Corrective Action
NO STORED MEMORY DATA	No data is stored in floppy or hard disk memory.	None.
OPTION NOT INSTALLED	Selected an option that is not installed.	None.
OUT OF CAL RANGE	Entered values out of the selected calibration range.	Change calibration range or re-enter values that are within the current range.
OUT OF H/W RANGE	Entered value is out of the instrument's hardware range.	Re-enter values that are within range.
OUT OF RANGE	Entered value is out of range.	Re-enter values that are within range.
OUT OF RANGE, 10 PERCENT MIN	Entered value is out of the instrument's range by greater than 10 percent.	Re-enter frequency or power value.
OUT OF RANGE, 20 PERCENT MAX	Entered smoothing or group delay value exceeds the range by greater than 20 percent.	Re-enter values that are within range, 0 to 20%.
OUT OF SWEEP RANGE	Entered a frequency that is out of the instrument sweep range.	Re-enter frequency.
OUT OF WINDOW RANGE	Attempted to set marker outside start to stop range.	Redefine marker to be within frequency start/stop range.
POWER OUT OF CALIBRATED RANGE	Power range has been changed to be outside the range of the active linearity calibration. Linearity calibration is turned off.	Perform linearity calibration over new power range.
POWER RESTORED TO CAL RANGE	Power range is outside of the linearity calibration range when the calibration was turned on. The power range is changed to the calibration range.	If new power range is desired, perform new linearity calibration over new power range.
RECEIVER OUT OF RANGE BY EQUATION	Equation defined in Multiple Source mode places receiver frequency out of range when attempting to store band.	Redefine frequency.
SOURCE 1 OUT OF RANGE BY EQUATION	Equation defined in Multiple Source mode places Source 1 frequency out of range when attempting to store band.	Redefine frequency.
SOURCE 2 OUT OF RANGE BY EQUATION	Equation defined in Multiple Source mode places Source 2 frequency out of range when attempting to store band.	Redefine frequency.
STANDARD CAL NOT VALID FOR WAVEGUIDE	Cannot use waveguide when calibrating with the standard method.	Use the Offset Short method with waveguide.
START F FOLLOWS PREVIOUS STOP F	Start frequency of current band immediately follows stop frequency of previous band. Cannot be modified.	None.
START GREATER THAN STOP	Entered start frequency is greater than the stop frequency.	Re-enter frequency values such that the start frequency is lower than the stop frequency.
START MUST BE LESS THAN STOP	Entered start frequency is greater than the stop frequency.	Re-enter frequency values such that the start frequency is lower than the stop frequency.
STEP IS TOO LARGE	Entered discrete fill step extends the stop fill out of range.	Re-enter so that step is within range.

Table 5-1. General Error Messages (3 of 3)

Error Message	Description	Corrective Action
STOP IS OVER RANGE	Entered value exceeds the instrument's stop frequency.	Re-enter stop frequency.
SYSTEM BUS ADDRESSES MUST BE UNIQUE	GPIB address is being used by another bus instrument.	Select a different, unique GPIB address.
SYSTEM UNCALIBRATED	373XXA is uncalibrated for the selected measurement values.	Perform a measurement calibration.
TOO FEW POINTS, 2 MINIMUM	Entered too few discrete file points, 2 is minimum.	Re-enter data points.
TOO MANY POINTS, 1601 MAXIMUM	Entered too many discrete file points, 1601 points are the maximum allowed.	Re-enter data points.
UNDEFINED DIVIDE BY ZERO	Denominator cannot be zero in equation.	Make denominator a value other than zero.
WARNING: NO GPIB CONTROL OF SOURCE SWEEP	Neither Source power nor flat-port power can be modified when receiver mode is user-defined with NO Source GPIB control.	None.
WARNING: SET ON RECEIVER MODE	Phase-lock setting is undefined when VNA in Set-On Receiver mode.	None.
WARNING: SOURCE 2 DOES NOT EXIST	2nd, external, frequency source is not present.	Connect frequency source.
WINDOW TOO SMALL	Attempted to set start greater than or equal to stop.	Re-enter frequency values.

Table 5-2. *Disk Error Messages (1 of 1)*

Error Message	Description	Corrective Action
7140: FLOPPY DISK GENERAL ERROR	Invalid disk media or format.	Use 1.44 MB diskette and format in the 373XXA.
7142: FLOPPY DISK READ ERROR	Read error when accessing disk file.	Use 1.44 MB diskette and format in the 373XXA.
7143: DISK WRITE ERROR	Error in writing to disk file.	Use 1.44 MB diskette and format in the 373XXA.
7147: FLOPPY DISK UNAVAILABLE	Floppy disk is not available.	Install floppy diskette or floppy disk drive.
7170: HARD DISK GENERAL ERROR	General error in accessing hard disk.	Retry and if still fails, reformat the hard disk drive.
7172: HARD DISK READ ERROR	Read error when accessing disk file.	Retry and if still fails, reformat the hard disk drive.
7173: HARD DISK WRITE ERROR	Error in writing to disk file.	Retry and if still fails, reformat the hard disk drive.
7177: HARD DISK UNAVAILABLE	Hard disk is not available.	Install hard disk drive circuit board.
8140: GENERAL DISK BUFFER ERROR	Out of RAM.	Press the System State, Default Program key and retry.
FILE NOT FOUND	Disk file not found.	None.
FLOPPY DISK HAS NO ROOM FOR FILE	Floppy diskette is full.	Delete files or install new diskette.
FLOPPY DISK NOT READY	Floppy disk is not ready (or not installed.).	Install diskette in floppy drive.
FLOPPY DISK WRITE PROTECTED	Write protect tab in place on floppy diskette.	Remove write-protect tab.
HARD DISK HAS NO ROOM FOR FILE, DELETE EXISTING FILE(S) TO CREATE SPACE	Hard disk is full.	Delete files.

Chapter 6

Data Displays

Table of Contents

6-1	INTRODUCTION	6-3
6-2	DISPLAY MODES AND TYPES	6-3
	Single Channel Display — Ch 1, 2, 3, 4	6-3
	Dual Channel Display — Ch 1 and 3 or Ch 2 and 4	6-4
	Four Channel Display — Ch 1, 2, 3, 4	6-5
	Dual Trace Overlay	6-6
	Graph Data Types	6-7
6-3	FREQUENCY MARKERS	6-11
	Marker Designation	6-11
6-4	LIMITS	6-12
6-5	STATUS DISPLAY	6-12
	Reference Position Marker	6-12
	Scale Resolution	6-12
	Frequency Range	6-12
	Analog Instrument Status	6-12
	Measurement Status	6-13
	Sweep Indicator Marker	6-13
6-6	DATA DISPLAY CONTROL	6-13
	S-Parameter Selection	6-14
	Data Display Update	6-14
	Display of Markers	6-15
6-7	HARD COPY AND DISK OUTPUT	6-15
	Tabular Printout	6-15
	Screen-Image Printout	6-16
	Plotter Output	6-16
	Disk Output	6-16

Chapter 6

Data Displays

6-1 INTRODUCTION

This chapter provides discussion and examples of the various types of data displays.

6-2 DISPLAY MODES AND TYPES

The 373XXA displays measurement data using a "Channel Concept". This means that each channel can display both a different S-Parameter and a different graph type. As you select each channel the graph type, scaling, reference delay, S-Parameter, etc. associated with that channel appear on the screen. You can display the same S-Parameter on two or more channels.

Several graph-types are possible: polar, rectilinear, or Smith chart. The rectilinear graph-type may be magnitude, phase, magnitude and phase, SWR, group delay, real, imaginary, and real and imaginary. The Smith chart graph-type is specifically designed to plot complex impedances.

Single Channel Display— Ch 1, 2, 3, 4

You select this display type (Figures 6-1 and 6-2) by choosing "Single Display" on Menu CM (Appendix A). Possible graph types are Smith, polar, rectilinear, or dual (split) rectilinear (magnitude and phase).

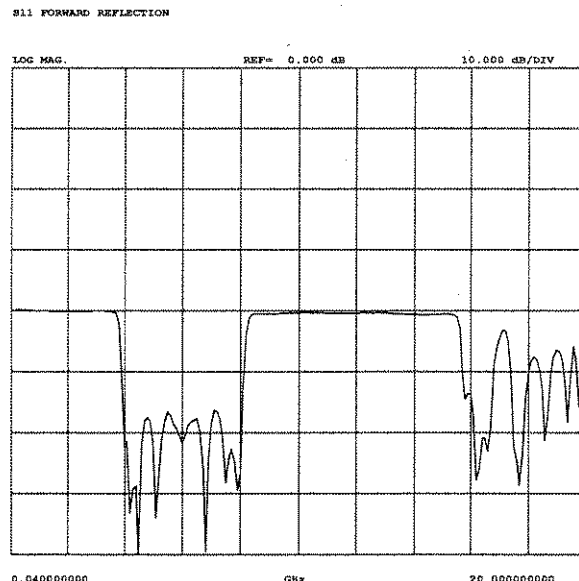

Figure 6-1. Single Channel Display, Log Magnitude

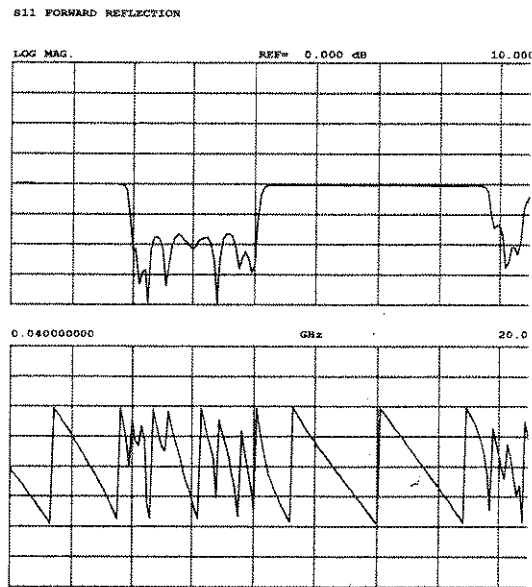

Figure 6-2. Single Channel Display, Magnitude and Phase

**Dual
Channel
Display—
Ch 1 and 3 or
Ch 2 and 4**

If you have chosen a dual display of magnitude and phase, the affected area of the CRT screen is subdivided into two smaller portions (Figure 6-3). You select this display type by choosing “Dual Display” in Menu CM (Appendix A).

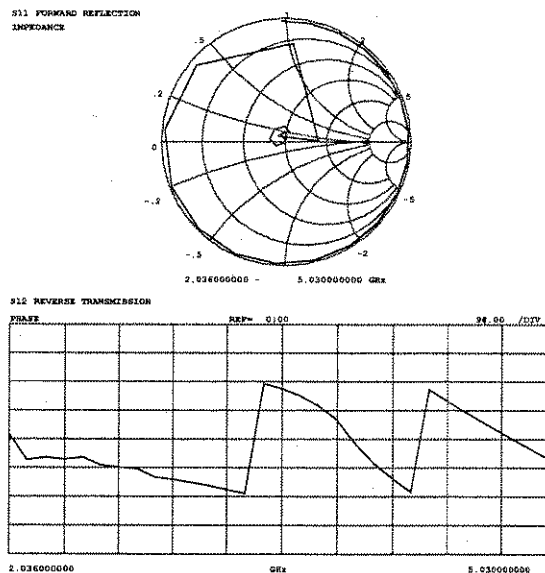

Figure 6-3. Dual Channel Display

**Four
Channel
Display—
Ch 1, 2, 3, 4**

From four-to-eight graph types are displayed. In each quadrant, the graph type can be any of the possible choices listed in the GT menu (Appendix A). If you have chosen to display magnitude and phase on a channel, the quadrant displaying that channel is further subdivided as described above. You select this display type by choosing "All Four Channels" in Menu CM. An example of a four-channel display appears in Figure 6-4, below.

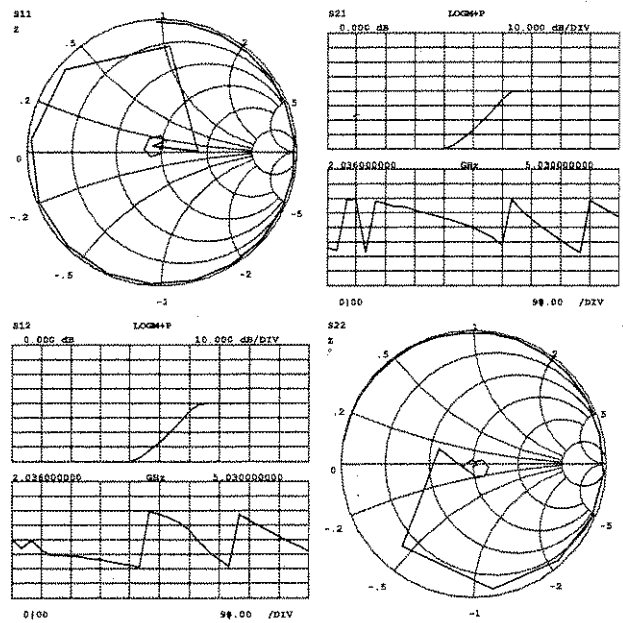

Figure 6-4. Four Channel Display

**Dual Trace
Overlay**

For rectilinear graph types, two traces can be displayed, one overlaid (superimposed) on the other (Figure 6-5). By menu selection, the two traces can be Channel 1 overlaid on Channel 3 or Channel 2 overlaid on Channel 4. Each trace is in a different color. Channels 1 and 2 are displayed in red, while Channels 3 and 4 are displayed in yellow.

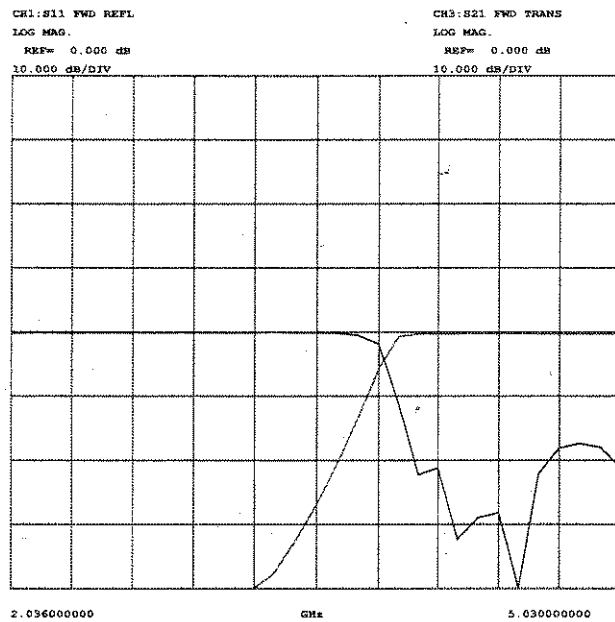

Figure 6-5. Dual Trace Overlay

***Graph Data
Types***

The data types (real, imaginary, magnitude, phase) used in the displayed graph-types reflect the possible ways in which S-Parameter data can be represented in polar, Smith, or rectilinear graphs. For example: Complex data—that is, data in which both phase and magnitude are graphed—may be represented and displayed in any of the ways described below:

- ❑ Complex Impedance; displayed on a Smith chart graph.
- ❑ Real and imaginary; displayed on a real and imaginary graph.
- ❑ Phase and magnitude components; displayed on a rectilinear (Cartesian) or polar graph.
- ❑ In addition to the above, the 373XXA can display the data as a group delay plot. In this graph-type, the group-delay measurement units are time. Those of the associated aperture are frequency and SWR.

The quantity group delay is displayed using a modified rectilinear-magnitude format. In this format the vertical scale is in linear units of time (ps-ns- μ s). With one exception, the reference value and reference line functions operate the same as they do with a normal magnitude display. The exception is that they appear in units of time instead of magnitude.

Examples of graph-data types are shown in Figure 6-6 through 6-11, on the following pages.

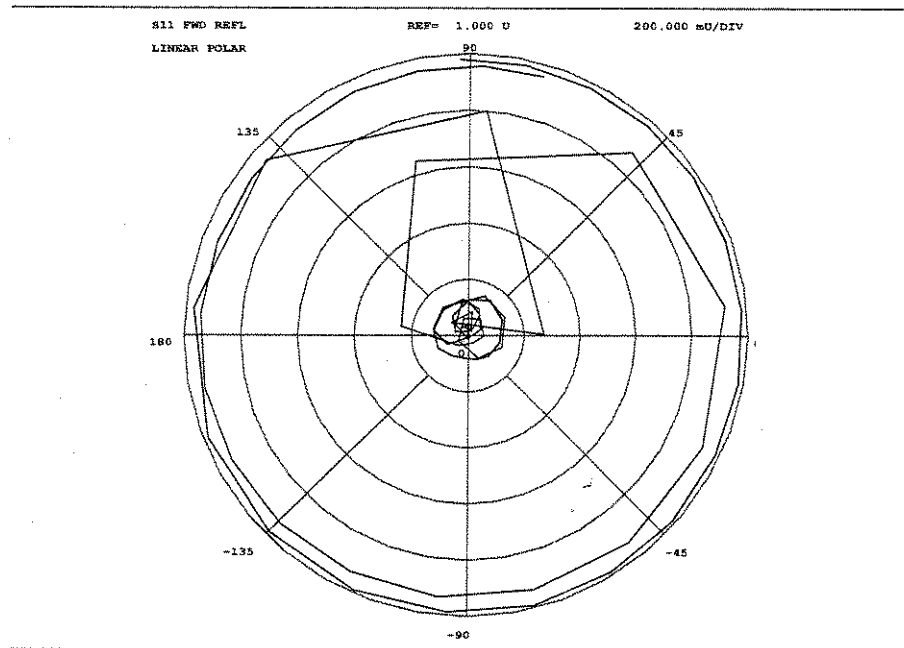

Figure 6-6. Linear Polar Graticule

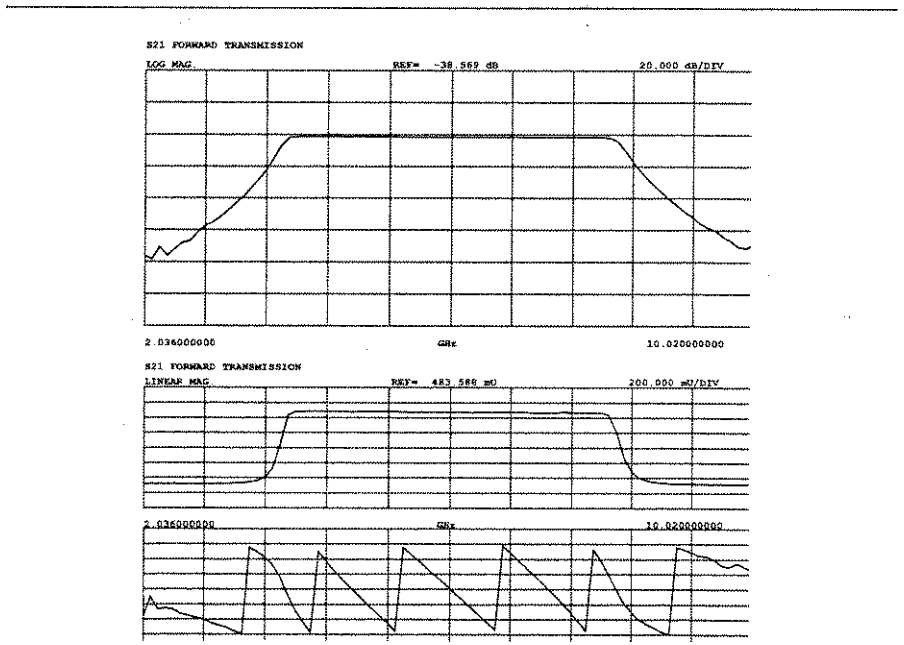

Figure 6-7. Dual Channel Rectilinear Graticule

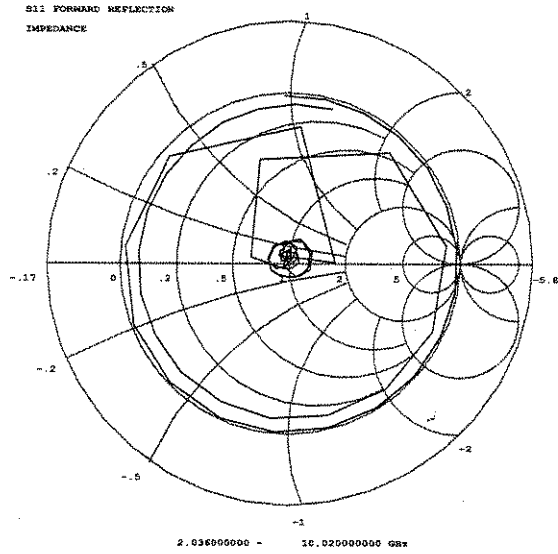

Figure 6-10. 3 dB Compressed Smith Chart

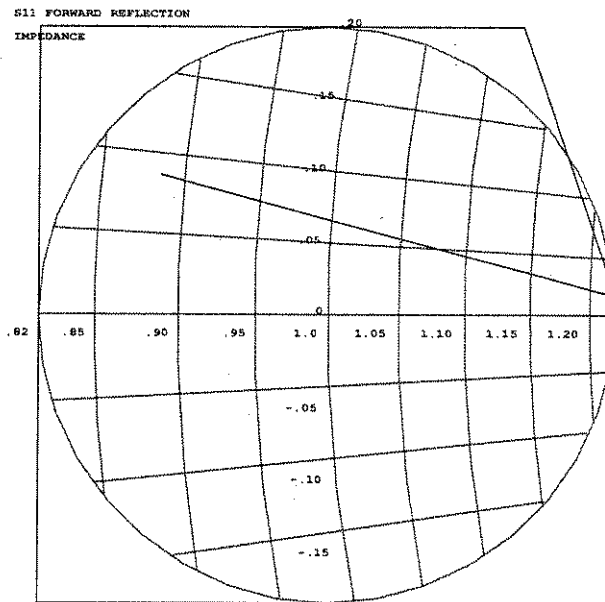
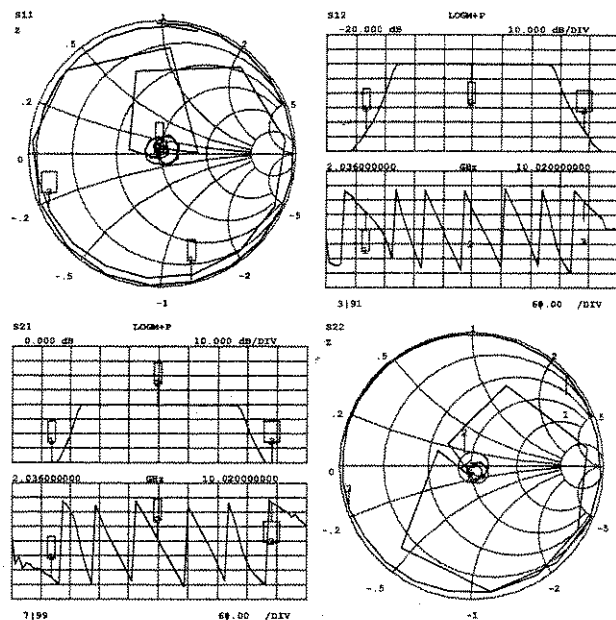

Figure 6-11. 20 dB Compressed Smith Chart

6-3 FREQUENCY MARKERS

**Marker
Annotation**

The example below shows how the 373XXA annotates markers for the different graph-types. Each marker is identified with its own number. When a marker reaches the top of its graticule, it will flip over and its number will appear below the symbol. When markers approach the same frequency, they will overlap. Their number will appear as close to the marker as possible without overlapping.



Marker Annotation

**Marker
Designation**

Depending on menu selection, you may designate a marker as the “active” or the “delta reference” marker. If you choose a marker to be active—indicated by its number being enclosed in a square box—you may change its frequency or time (distance) (or point number in CW Draw) with the Data Entry keypad or knob. If you have chosen it to be the delta-reference marker, a delta symbol (Δ) appears one character space above the marker number (or one character space below a “flipped” marker). If the marker is both active and the delta reference marker, the number and the delta symbol appear above (below) the marker. The delta symbol appears above (below) the number.

6-4 LIMITS

Limit lines function as settable maximum and minimum indicators for the value of displayed data. These lines are settable in the basic units of the measurement on a channel-by-channel basis. If the display is rescaled the limit line(s) will move automatically and thereby maintain their correct value(s).

Each channel has two limit lines (four for dual displays), each of which may take on any value. Limit lines are either horizontal lines in rectilinear displays or concentric circles around the origin in Smith and polar displays.

Each channel can produce segmented limits. They allow different upper and lower limit values to be set at up to ten segments across the measurement range.

6-5 STATUS DISPLAY

In addition to the graticules, data, markers, and marker annotation, the 373XXA displays certain instrument status information in the data display area. This information is described below.

**Reference
Position
Marker**

The Reference Position Marker indicates the location of the reference value. It is displayed at the left edge of each rectilinear graph-type. It consists of a green triangular symbol similar to the cursor displayed in the menu area. You can center this symbol on one of the vertical graticule divisions and move it up or down using the "Reference Position" option. When you do this, the data trace moves accordingly. If you also select the reference value option, the marker will remain stationary and the trace will move with the maximum allowable resolution. When changing from a full-screen display to half- or quarter-screen display, the marker will stay as close to the same position as possible.

**Scale
Resolution**

Each measurement display is annotated with the scale resolution. For log-magnitude displays resolution ranges from 0.001 to 50 dB per division. Linear displays of magnitude range from 0.001 to 50 units per division. Cartesian phase displays can range from 0.01 to 90 degrees per division. The polar display is 45 degrees per display graticule.

**Frequency
Range**

Each measurement display is annotated with the frequency range of the measurement.

**Analog
Instrument
Status**

The 373XXA displays analog-instrument-status messages (in red when appropriate) in the upper right corner of the data-display area (left). They appear at the same vertical position as line 2 of the

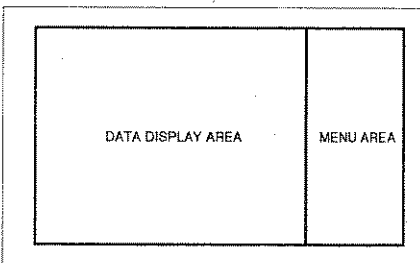

Display screen showing the data display and menu areas

menu area. If more than one message appears, they stack up below that line.

Measurement Status

The 373XXA displays measurement-status messages (in red when appropriate) in the upper-right corner of the graticule (channel) to which they apply.

Sweep Indicator Marker

A blue sweep-indicator marker appears at the bottom of each displayed graph-type. It indicates the progress of the current sweep. When measuring quiet data—that is, data having few or no perturbations—this indicator assures that the instrument is indeed sweeping. Its position is proportional to the number of data points measured in the current sweep. If the sweep should stop for any reason, the position of the indicator will stop changing until the sweep resumes.

6-6 DATA DISPLAY CONTROL

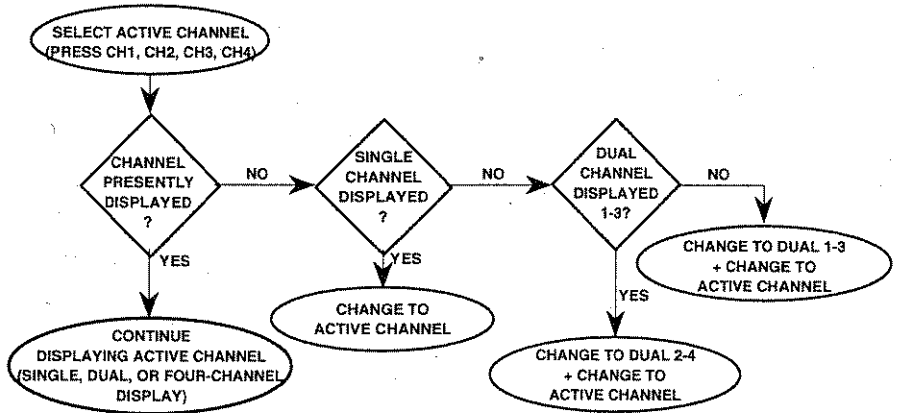

Active Channel Algorithm

Active Channel Selection

The following figure shows the algorithm that the 373XXA uses to display the active channel.

S-Parameter Selection

If you select a new S-Parameter using Menu SP (Appendix A), it appears on the then-active channel in the same graph-type in which it was last displayed. The following table shows the displayable S-Parameters based on the correction type you have in place. If you attempt to display other S-Parameters, an error message appears. In cases when there is no last-displayed S-Parameter stored, the display will default as shown. If an S-Parameter is selected for which there was no last-displayed graph-type, the display defaults to S₂₁, S₁₂ Log Magnitude and Phase and S₁₁, S₂₂ Smith.

Correction Type	Displayable S-Parameters	Default Display Position			
		CH1	CH2	CH3	CH4
None	All	S11	S12	S21	S22
Frequency Response					
Reverse Transmission	S12		S12		
Forward Transmission	S21			S21	
Both	S12, S21		S12	S21	
Port 1 Reflection Only	S11	S11			
Port 2 Reflection Only	S22				S22
Reflection Only, Both	S11, S22	S11			S22
Forward 1-Path 2-Port	S11, S21	S11		S21	
Reverse 1-Path 2-Port	S12, S22		S12		S22
12-Term	All	S11	S12	S21	S22

Data Display Update

When you change a control panel parameter that affects the appearance of the display, the entire display changes immediately to reflect that change. For example, if you press Autoscale, the entire display rescales immediately. You do not have to wait for the next sweep to see the results of the change. The following parameters are supported for this feature: Reference Delay, Offset, Scaling, Auto Scale, Auto Reference Delay, Trace Math, IF BW, and Smoothing. In the case of Averaging, the sweep restarts.

If the knob is used to vary any of the above parameters, the change occurs as the measurement progresses—that is, the continuing trace will reflect the new setting(s).

When you change a marker frequency or time (distance), the readout parameters will change. This change reflects the changes in measurement data at the marker's new frequency, using data stored from the previous sweep.

Display of Markers

Once you have selected a marker to display, it will appear on the screen. It does not matter what resolution you have selected. When you set a marker to another calibrated frequency and then lower the resolution, that frequency and the marker will continue to display. It will display even if its frequency is not consistent with the data points in the lower-resolution sweep.

6-7 HARD COPY AND DISK OUTPUT

In addition to the CRT display, the Model 373XXA is capable of outputting measured data as a

- Tabular Printout
- Screen-Image Printout
- Pen Plot,
- Disk Image Of The Tabular Data Values

The selection and initiation of this output is controlled by the Hard Copy keys.

Tabular Printout

An example of a tabular format is shown in Figure 6-12. The tabular formats are used as follows:

- Tabular Printout Format*: Used when printing three or four channels.
- Alternate Data Format*: Used when printing one or two channels.

In tabular printouts, the 373XXA shifts the data columns to the left when an S-Parameter is omitted. Leading zeroes are always suppressed. The heading (Model, Device ID, Date, Operator, Page) appears on each page.

Screen-Image Printout

In a Screen-Image Printout, the exact data displayed on the screen is dumped to the printer. The dump is in the graphics mode, on a pixel-by-pixel basis.

Plotter Output

The protocol used to control plotters is "HP-GL (Hewlett-Packard Graphics Language). HP-GL contains a comprehensive set of vector graphics type commands. These commands are explained in the Interfacing and Programming Manual for any current model Hewlett-Packard plotter, such as the 7470A.

When the plotter is selected as the output device, it is capable of drawing the graph shown on the screen or of drawing only the data trace(s), so that multiple traces may be drawn on a single sheet of paper (in different colors, if needed).

Disk Output

The 373XXA can write-to or read-from the disk all measured data. This data is stored as an ASCII file in the exact same format as that shown for the tabular printout in Figure 6-12. If read back from the disk, the data is output to the printer. There, it prints as tabular data.

Chapter 7

Measurement Calibration

Table of Contents

7-1	INTRODUCTION	7-3
7-2	MEASUREMENT CALIBRATION —DISCUSSION	7-3
	Establishing the Test Ports	7-3
	Understanding the Calibration System	7-6
	Calibrating for a Measurement	7-9
	Evaluating the Calibration	7-11
	Verification Kits	7-11
7-3	MEASUREMENT CALIBRATION —SLIDING TERMINATION	7-13
7-4	STANDARD (OSL) CALIBRATION PROCEDURE	7-19
	Calibration Procedure.	7-19
7-5	OFFSET-SHORT CALIBRATION PROCEDURE	7-28
	Calibration Procedure.	7-28
7-7	LRL/LRM CALIBRATION PROCEDURE	7-32
7-6	TRM CALIBRATION PROCEDURE	7-43

Chapter 7

Measurement Calibration

7-1 INTRODUCTION

This section provides discussion and examples for performing a measurement calibration. It also provides a detailed procedure for calibrating with a sliding termination.

7-2 MEASUREMENT CALIBRATION —DISCUSSION

Measurements always include a degree of uncertainty due to imperfections in the measurement system. The measured value is always a combination of the actual value plus the systematic measurement errors. Calibration, as it applies to network analysis, characterizes the systematic measurement errors and subtracts them from the measured value to obtain the actual value.

The calibration process requires that you establish the test ports, perform the calibration, and confirm its quality. Let us examine each of these steps.

Establishing the Test Ports

Figures 7-1 and 7-2 are two of the most common approaches used to make measurements on two-port devices. In many cases, you may need adapters to change between connector types (N, SMA, GPC-7, etc) or between genders (male [M] or female [F]).

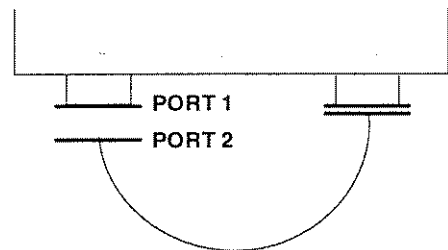

Figure 7-1. *Establishing the Test Port*

The use of cables and/or adapters does not effect the final measurement result, if they were in place for the calibration process. The vector error corrections established during the calibration process eliminates cable and/or adapter effects as long as the ports used are stable and exhibit good repeatability, which is the case if good quality components are used. Figure 7-2 shows such a configuration

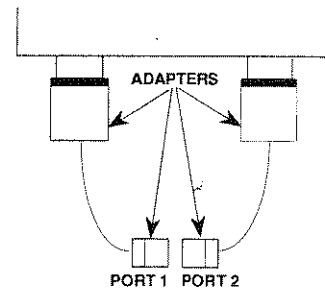

Figure 7-2. Using Adapters on the Test Port

Many calibration kits include adapters that are designed to have equal phase length. These parts are called phase equal adapters (PEA). Anritsu designs in-series adapters (e.g., K Connector M-M, M-F, F-F) to be phase insertable when technically possible.

When available, it is good practice to use PEAs to establish test ports (Figure 7-3).

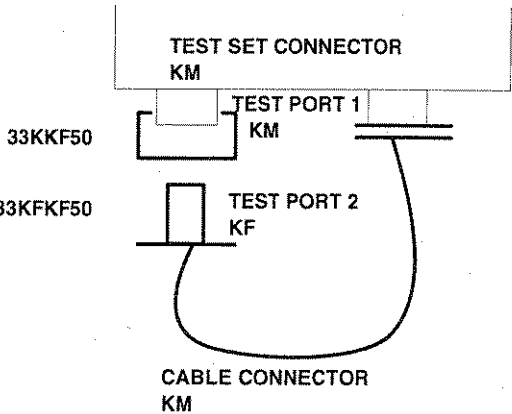

Figure 7-3. Use of PEAs to Establish Test Ports

This approach offers two advantages:

- It minimizes wear on the more expensive test set and cable connectors.
- It provides a simple solution to measuring non-insertable devices (e.g., a filter with K female input and output connectors), by merely swapping PEAs after calibration. See Figure 7-4.

USING THE PHASE-EQUAL INSERTABLE (PEI)

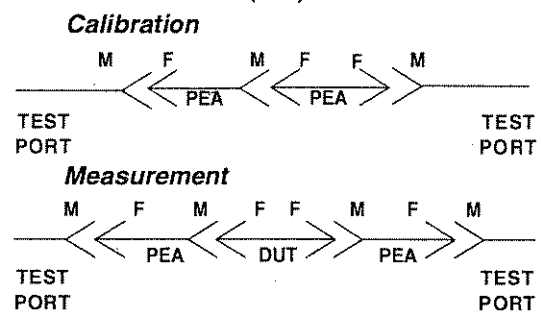

Figure 7-4. Using Phase-Equal Insertables

NOTE

In this and other discussions, we will talk about “insertable” and “non-insertable” devices. Insertable devices have an insertable connector pair (i.e., male input and female output connectors) and can be measured after a through calibration.. A non-insertable device has a non-insertable pair of connectors. This would be the case if it included female connectors on both ports or different connector types on each port. Therefore, “non-insertables” cannot be connected directly into the measurement path without an adapter.

ERRORS REDUCED BY CALIBRATION

- Directivity
- Source Match
- Load Match
- Frequency Sensitivity (Tracking)
- Isolation

INTERNAL SYSTEM ERRORS

- RF Leakage
- IF Leakage
- System Interaction

RANDOM ERRORS

- Frequency
- Repeatability
- Noise
- Connector Repeatability
- Temperature/Environmental Changes
- Calibration Variables

**TRANSMISSION MEASUREMENT
ERRORS**

- Source Match
- Load Match
- Tracking

Understanding the Calibration System

Measurement errors must be reduced by a process that uses calibration standards. The standards most commonly used are Opens, Shorts, and Z_0 (Characteristic Impedance) Loads. In conjunction with a through connection, these standards can correct for the major errors in a microwave test system. These errors are Directivity, Source Match, Load Match, Isolation, and Frequency Tracking (reflection and transmission).

Calibration also corrects for many internal system errors, such as RF leakage, IF leakage, and system component interaction.

Random errors such as noise, temperature, connector repeatability, DUT sensitive leakages, frequency repeatability, and calibration variables are not completely correctable. However, some of them can be minimized by careful control. For instance: temperature effects can be reduced by room temperature control, calibration variables can be reduced through improved technique and training, and frequency errors can be virtually eliminated by the fully synthesized internal source.

We know that adapters and cables degrade the basic directivity of the system, but these errors are compensated by vector error correction.

In general, transmission measurement errors are source match, load match, and tracking; while reflection measurement errors are source match, directivity, and tracking.

REFLECTION MEASUREMENT ERRORS

- Source Match
- Directivity
- Tracking

Error modeling and flowgraphs are techniques used to analyze the errors in a system. Error models describe the errors, while flowgraphs show how these errors influence the system. Error models (Figure 7-5, below) can become quite complex.

**DIRECTIVITY, SOURCE MATCH,
AND TRACKING ERRORS
DISTORTED MEASUREMENT**

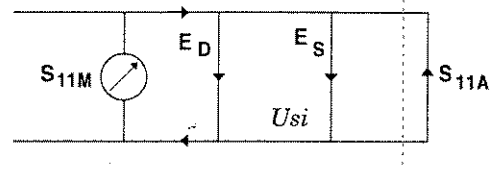

Figure 7-5. Example of Error Modeling

CALIBRATION TYPES

- Frequency Response
- Reflection Only—1 Port
- 1 Path, 2 Port
- 12 Term—2 Port, Both Directions

The 373XXA offers a selection of calibration possibilities depending on the user's needs. These possibilities are as follows:

- Frequency Response
- Reflection Only—1 Port
- 1 Path, 2 Port
- 12 Term—2 Port, Both Directions

These calibration types are described below.

Frequency Response: Corrects for one or both of the transmission error terms associated with measurements of S21, S12, or both

Reflection Only: Corrects for the three error terms associated with an S11 measurement (EDF, ESF, and ERF), an S22 measurement (EDR, ESR, and ERR), or both.

1 Path, 2 Port: Corrects for the four forward-direction error terms (EDF, ESF, ERF, and ETF), or the four reverse-direction error terms (EDR, ESR, ERR, and ETR).

Full 12 Term: Corrects for all twelve error terms associated with a two-port measurement. A 12-Term error model is shown in Figure 7-6.

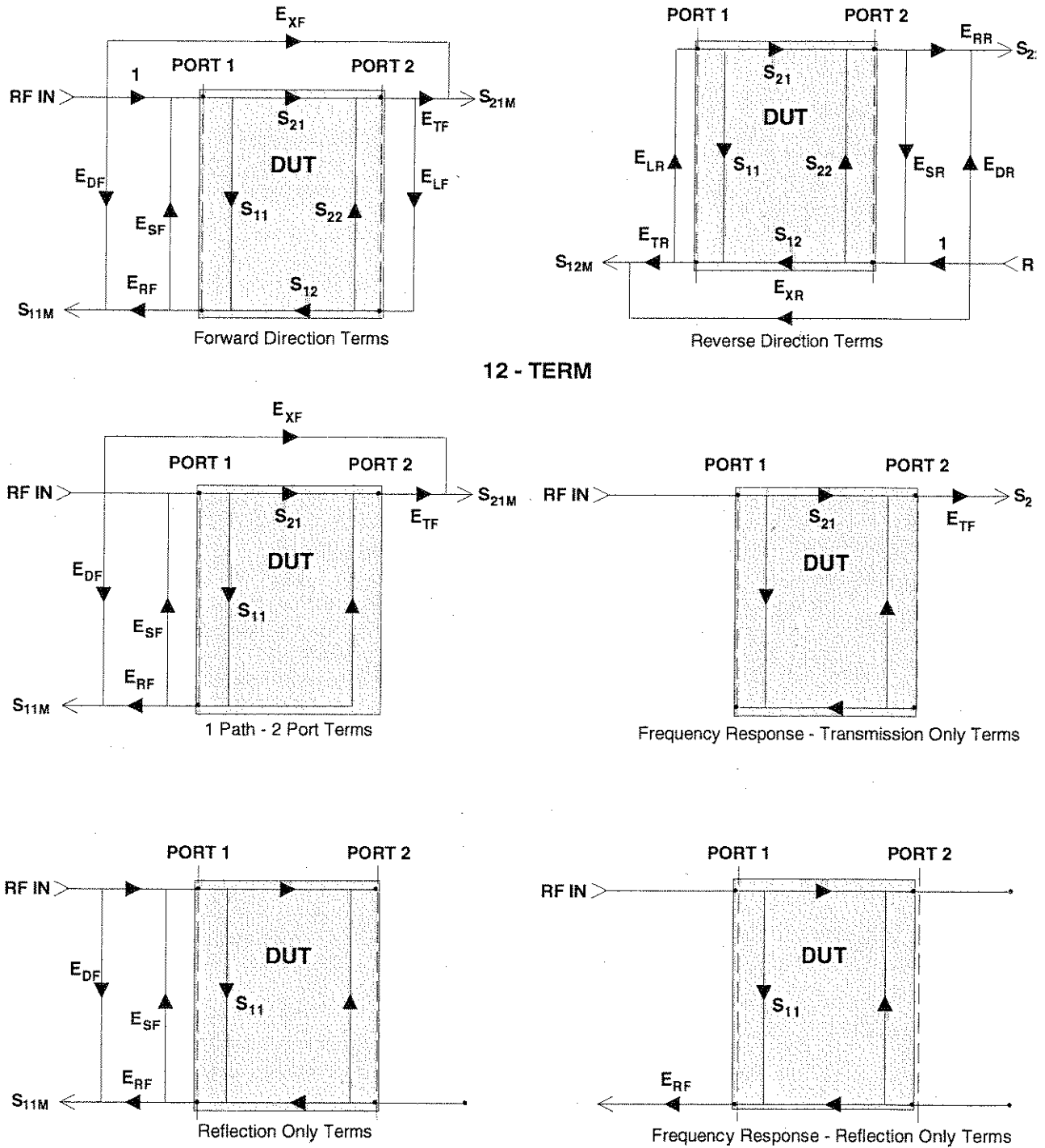

Figure 7-6. Error Models

Measurement calibration using the 373XXA is straightforward and menu directed. A short time spent in preparation and preplanning will make the process simple and routine. (Example: Adjusting the coaxial cables used in the measurement setup such that insertion of the DUT causes minimal flexing of these cables).

The screen prompts on the 373XXA guide you through the calibration process—a process that consists of connecting and disconnecting connectors and moving the slide on a sliding load (if one is used).

The most critical part of the calibration process is properly seating and torquing the connectors. Also, you will notice that the calibration takes longer when the ports are terminated with a load. This is intentional. It allows for more averaging during the isolation measurement.

Calibrating for a Measurement

Let us assume that we want to correct for three errors in the reflection measurement: source match, directivity, and tracking. We accomplish this using three standards.

CALIBRATING FOR A REFLECTION MEASUREMENT USES THREE STANDARDS:

Short

Open

Termination

Shorts are the easiest to visualize. They totally reflect all of the incident RF energy output at a precise phase. The terms zero-ohms impedance, voltage null, and 180° phase all define an RF Short.

Opens are similar to Shorts, but their response is more complex. The terms voltage maximum, infinite impedance, and 0° phase all define a perfect Open. A perfect Open, however, is only a concept. In reality Opens always have a small fringing capacitance.

To account for the fact that the Open will not predictably reflect impedance at an exact 0° phase reference, we alter its response using coefficients that accurately characterize the fringing capacitance. The coefficients are different for each coaxial line size, since each size has a different fringing capacitance. To maximize accuracy, ensure that these coefficients are installed prior to the calibration (Menu U3).

As Opens and Shorts provide two references for a full reflection, Z_0 terminations provide a zero-reflection reference.

IDEAL TERMINATIONS

Reflectionless

Perfect Connector

Infinite-Length, Dimensionally Exact, Reflectionless Transmission Line

PRACTICAL Z_0 TERMINATIONS

Broadband Load

Sliding Termination

BROADBAND LOAD

Easy to Use

Inexpensive

Adequate for Most Applications

SLIDING LOAD

Connector

Long Transmission Line

Movable Microwave Load

Ideal Z_0 terminations must consist of two parts, a perfect connector and an infinite-length perfect transmission line that absorbs all of the RF energy that enters it (no reflections).

Infinite length transmission lines are unwieldy at best, so you must use less-than-ideal terminations. For calibration purposes there are two common types: broadband loads and sliding terminations.

Broadband loads are widely used. An example is the ANRITSU 28 Series Termination. These terminations are easy to use as calibration tools, and they are adequate for most applications.

Sliding Loads are the traditional vector network analyzer Z_0 calibration reference. They provide the best performance when the application requires high-precision return loss measurements. Sliding loads consist of a connector, a long section of precision transmission line, and a microwave load that is movable within the transmission line. One thing to remember with sliding loads is that they have a low-frequency limit and must be used with a fixed load below this cutoff frequency for full frequency coverage. ANRITSU sliding loads cut off at 2 GHz. (V-connector sliding loads cut off at 4 GHz).

Pin depth—the relationship between the interface positions of the outer and center conductors—is the most critical parameter under your control in a sliding load. An example of its criticality is that an incorrect pin depth of 0.001 inch can cause a reflection return loss of 44 dB. And, since we are trying to calibrate to accurately measure a 40 dB return loss, correct pin depth makes a big difference!

Cables in the measurement system are another cause for concern. The main criteria for a cable are stability and repeatability. ANRITSU offers two types of cables that meet these criteria: semi-rigid and flexible. Our semi-rigid cables provide maximum stability with limited flexibility of movement. Our flexible cables allow more freedom of movement and provide good phase stability.

**Evaluating
the Calibration**

The 373XXA provides an accurate representation of complex data. However, it can only provide accuracy to the extent of the supplied calibration data. For this reason, it is necessary to periodically verify the calibration data and the 373XXA system performance.

Calibration verification reveals problems such as a poor contact with one of the calibration components, improper torquing, or a test port out of specification. Problems like these can easily occur during a calibration procedure. Anyone who has experienced one of these problems and stored bad data—after having performed a complete calibration procedure—knows the frustration it can cause. Additionally, it can be very costly to use incorrectly taken measurement data for design or quality assurance purposes.

The best way to confirm a calibration is to measure a precision, known-good device and confirm its specifications.

**Verification
Kits**

ANRITSU has developed several precision-component kits: for 3.5 mm connectors, for GPC-7 connectors, K Connectors® and V Connectors®. These are, respectively, the Models 3666, 3667, and 3668 and 3669 Verification Kits.

Each of the kits contain 20 dB and 50 dB attenuators, an airline, and a Beatty Standard. A Beatty Standard is a two-port mismatch similar to a beadless airline. It consists of a center conductor with a discontinuity in the middle providing the mismatch (Figure 7-7).

VERIFICATION KIT

Used by Calibration and Metrology
Labs

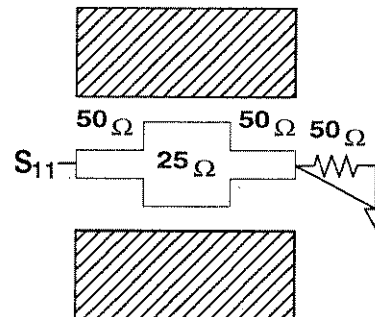

Figure 7-7. The Beatty Standard

Typically, these verification kits will be used by calibration or metrology labs. Each of the kits contain several precision components, all of which have been characterized at specified frequencies. The data on these components is stored on a disk provided with the verification kit.

The verification of the kit components is straight forward. The components are first measured with the 373XXA, then they are compared with the data recorded on the disk. If the measured data compares favorably with the recorded data (taking tolerances into consideration), then the system is known to be operating properly and providing accurate data.

There is one caution that you need to observe when using Verification Kits. Because the verification components have been characterized, you must handle them carefully so that you do not change their known characteristics. Consequently, you should not have them available for daily use. Rather, you should only use them for the accuracy verification checks taken every 6-to-12 months (or at any other time the system's integrity is in doubt).

This completes the discussion on calibration. Refer to paragraph 7-3 for a procedure showing how to calibrate the sliding load.

**7-3 MEASUREMENT
CALIBRATION —SLIDING
TERMINATION**

Sliding terminations (loads) are the traditional Z_0 calibration-reference devices for vector network analyzer calibration. When correctly used and perfectly aligned, they can be more accurate than precision fixed loads. However, sliding terminations have a 2 GHz (4 GHz for V-Connector sliding loads) low-frequency limit and must be used with a fixed load for full frequency-range coverage.

Sliding terminations consist of a connector, a long section of precision transmission line, and a microwave load that is movable within the transmission line. Pin depth—the relationship between the interface positions of the outer and center conductors—is the most critical parameter that you can control in a sliding termination. An example of its criticality is that an incorrect pin depth of 0.001 inch can cause a reflection return loss of 44 dB. Since you are usually calibrating to accurately measure a greater than 40 dB return loss, correct pin depth is essential.

Since setting an accurate pin depth is so important, this discussion centers on describing how to set the pin depth for male and female sliding terminations. Calibration with the sliding termination is essentially the same as described below for the broadband load.

The procedure below uses the Model 3652 Calibration Kit and its 17KF50 and 17K50 Sliding Terminations. Calibration is similar for the Model 3650 SMA/3.5mm, Model 3651 GPC-7 and Model 3654 V connector kits. For the 3651, the procedure is simpler: Because the GPC-7 connector is sexless, there is only one sliding termination.

Procedure

Step 1. Remove the Pin Depth Gauge from the kit, place it on the bench top.

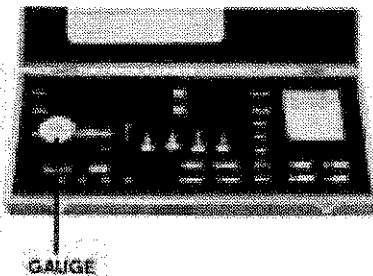
**NOTE**

The meter is convertible between male and female. The following procedure describes the zeroing process for the female fitting. The procedure for the male fitting begins with step 16.

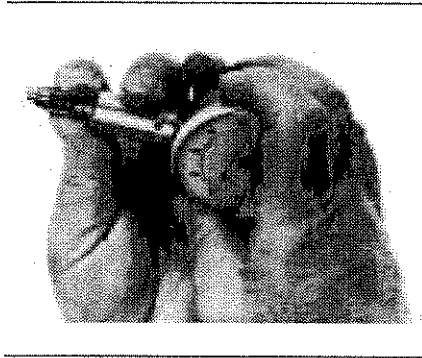

Step 2.

Push the outer locking ring towards the gauge to expose the center pin.

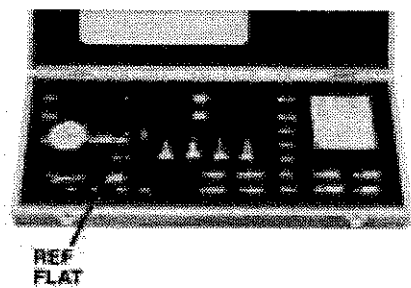

Step 3.

Take the 01-210 Ref Flat from the kit.

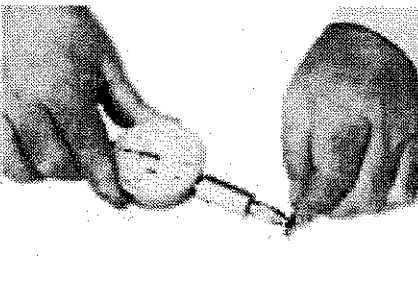

Step 4.

While holding the gauge as shown, press the Ref Flat firmly against the end of the exposed center pin.

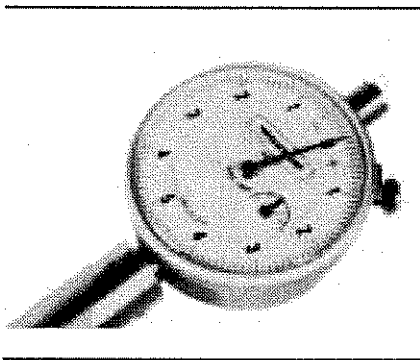

Step 5.

While pressing the Ref Flat against the center pin, check that the pointer aligns with the "0" mark. If it does not, loosen the bezel lockscrew and rotate the bezel to align the pointer with the "0" mark. Tighten the bezel lock screw.

NOTE

Gently rock the Ref Flat against the center pin to ensure that it is fully depressed and you have accurately set the gauge for zero.

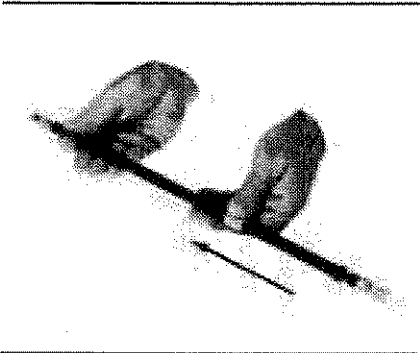

Step 6.

Remove the sliding termination with the female-connector (17KF50, for this example) from the kit, and slide the load all the way toward the end closest to the connector.

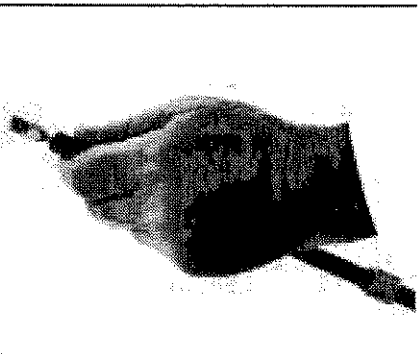

Step 7.

With either hand, pick up the sliding termination near its connector end.

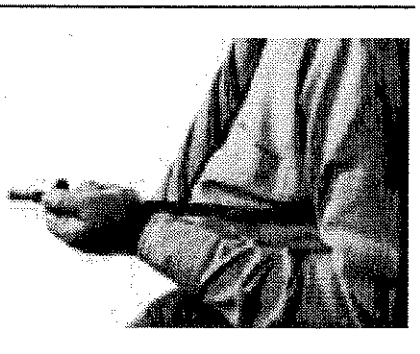

Step 8.

Cup the sliding termination in your palm, and support the barrel between your body and crooked elbow.

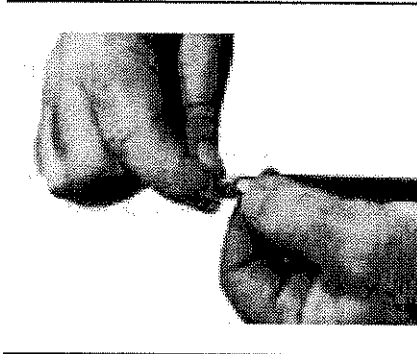

Step 9.

Remove the flush short by holding its body and unscrewing its connector.

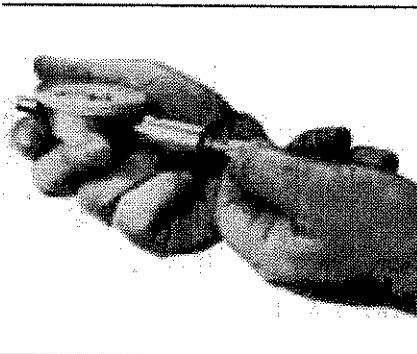

Step 10.

Install the gauge onto the end of the sliding termination.

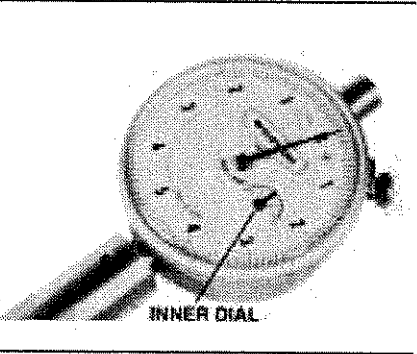

Step 11.

If the COARSE SET adjustment—which has been set at the factory—has not moved, the inner dial on the gauge will read “0.” If it doesn’t, perform the Coarse Set Adjustment in step 15.



Step 12.

Place the sliding termination, with the gauge attached, on the bench top.

Step 13.

Loosen the FINE LOCK ring and turn the FINE ADJ ring to position the gauge pointer 2-3 small divisions on the “-” side of zero.

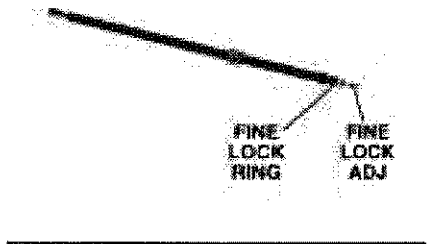

Step 14.

Turn the FINE LOCK ring clockwise to both tighten the adjustment and place the pointer exactly to “0.” The Sliding Termination is now ready to use.

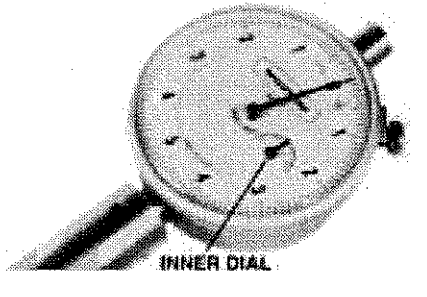

NOTES

- Ensure that the inner dial read “0.”
- The following step is not normally necessary. It needs to be done only if the adjustment has changed since it was set at the factory.

Step 15.

With the 01-211 Flush Short installed, loosen the COARSE LOCK and gently push the COARSE SET adjustment rod in as far as it will go. This coarsely sets the center conductor to be flush against the attached short. Return to step 2.

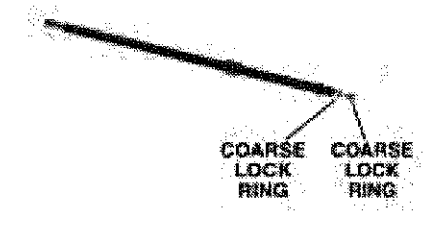

Step 16.

The procedure for adjusting the male-connector sliding termination is essentially the same as that described above. The only difference is that you must install the female adapter on the end of the gauge shaft, over the center conductor. To install this adapter, proceed as follows:

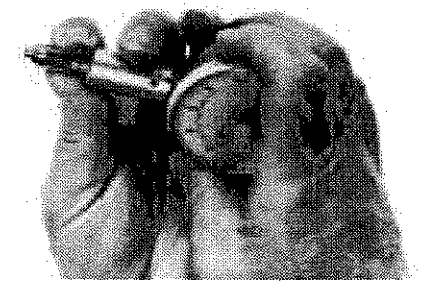

- Zero-set the gauge as described in step 2 above.



FEMALE
ADAPTER

- Push the outer locking ring back toward the gauge and turn it clockwise onto the exposed threads.

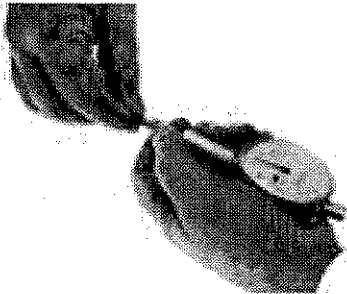

- Loosen the lock ring one turn in a counter-clockwise direction.



Step 17.

Remove the 01-223 Female Adapter (“F ADAPTER FOR PIN GAUGE”) from the kit.

Step 18.

Install the female adapter over the center pin and screw it into the locking ring, and tighten the outer ring until it is snug against the housing.

Step 19.

Inspect the end of the adapter, you should see no more than two exposed threads. If so, repeat steps 7 thru 10, above.

Step 20.

Connect the gauge to the sliding termination and zero set the center pin using the FINE ADJ as previously described in step 2 above.

**7-4 STANDARD (OSL)
CALIBRATION
PROCEDURE**

The standard calibration for the 373XXA Vector Network Analyzer system uses an Open, a Short, a Broadband and/or Sliding Load, and a throughline connection to categorize the inherent errors in the measurement system. These errors include those caused by connectors as well as internal system errors such as RF leakage, IF leakage, and component interaction. For maximum accuracy, install the capacitive coefficients (for the open device) using Menu U3.

Calibration Procedure A detailed, step-by-step procedure for performing a Open-Short-Load calibration is given below.

Step 1. Press the Begin Cal key.

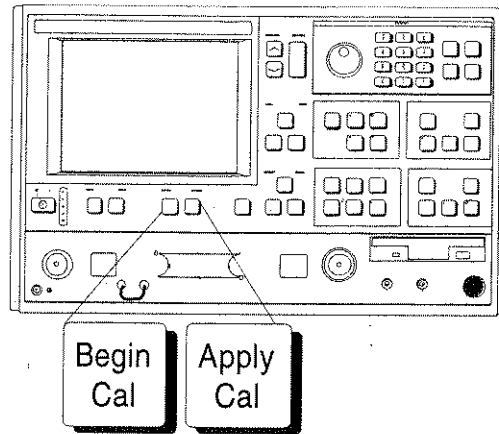

MENU C11
BEGIN CALIBRATION
KEEP EXISTING CAL DATA
REPEAT PREVIOUS CAL
AUTOCAL
CAL METHOD STANDARD
TRANSMISSION LINE TYPE: XXXXXXXX
CHANGE CAL METHOD AND LINE TYPE
NEXT CAL STEP
PRESS <ENTER> TO SELECT

Step 2. Select **CHANGE CAL METHOD AND LINE TYPE**, in menu C11 (left). (This assumes STANDARD and COAXIAL are not presently shown in blue as being selected.)

MENU C11A	
CHANGE CAL METHOD AND LINE TYPE	
NEXT CAL STEP	c.
CAL METHOD	
STANDARD (NOT USED FOR WAVEGUIDE)	a.
OFFSET SHORT	
LRL/LRM	
TRANSMISSION LINE TYPE	
COAXIAL	b.
WAVE GUIDE	
MICROSTRIP	
PRESS <ENTER> TO SELECT	

Step 3.

When menu C11A (left) appears, move cursor to the following:

- a. **STANDARD**, then press Enter key. This selects Standard (OSL) as the calibration method.
- b. **COAXIAL**, then press Enter key. This selects coaxial transmission line media.
- c. **NEXT CAL STEP**, then press Enter key. This causes menu C11 to return to the screen.

Step 4.

When menu C11 reappears, confirm that the **STANDARD** calibration method and **COAXIAL** line type have been selected. Select **NEXT CAL STEP** and press the Enter key to proceed. This brings up menu C5.

Step 5.

Menu C5 (left) lets you select the type of calibration. For this example, move the cursor to **FULL 12-TERM** and press the Enter key. This selection calibrates for all twelve error terms.

Step 6.

The next menu, C5D, lets you choose whether to include or exclude the error terms associated with leakage between measurement channels. For a normal calibration, you would choose to include these error terms. Therefore, move the cursor to **INCLUDE ISOLATION (STANDARD)** and press the Enter key.

MENU C5	
CALIBRATION TYPE	
FULL 12-TERM	
1 PATH	
2 PORT	
TRANSMISSION FREQUENCY RESPONSE	
REFLECTION ONLY	
PRESS <ENTER> TO SELECT	

MENU C5D	
SELECT USE OF ISOLATION IN CALIBRATION	
INCLUDE ISOLATION (STANDARD)	
EXCLUDE ISOLATION	
PRESS <ENTER> TO SELECT	

Step 7.

Next, menu C1 appears. It lets you select the number of frequency points at which calibration data is to be taken. The choices are:

```

MENU C1
-----
SELECT
CALIBRATION
DATA POINTS
NORMAL
(1601 POINTS
MAXIMUM)
C.W.
(1 POINT)
N-DISCRETE
FREQUENCIES
(2 TO 1601
POINTS)
TIME DOMAIN
(HARMONIC)
PRESS <ENTER>
TO SELECT
    
```

- a. **NORMAL:** Data is taken at up to 1601 equally spaced frequencies across the calibration frequency range. *Use this selection for this example.*
- b. **C.W. :** Data is taken at one point. This choice brings up menu C2B (below) that lets you select the single CW frequency point.

```

MENU C2B
-----
SINGLE POINT
CALIBRATION
C.W. FREQ
XX.XXXX GHz
FINISHED
ENTRY, NEXT
CAL STEP
INPUT FREQ AND
PRESS <ENTER>
TO SELECT
    
```

Step 8.

- c. **N-DISCRETE FREQUENCIES:** This selection lets you specify a discrete number of frequency points, from 2 to 1601.
- d. **TIME DOMAIN:** This selection is the calibration mode for low-pass time-domain processing. It lets you select frequencies at integer (harmonic) multiples of the start frequency.

The next menu, C2 (left), lets you set your start and stop frequencies. For this example, move cursor to **START**, press 40 on keypad, and hit the MHz terminator key. Perform like operations for the **STOP** choice, except make entry read 20 GHz. After setting the frequencies, select **NEXT CAL STEP** and press the Enter key.

```

MENU C2
-----
FREQ RANGE OF
CALIBRATION
START
0.0400000000GHz
STOP
20.000000000 GHz
201 DATA PTS
0.099800000 GHz
STEPSIZE
MAXIMUM NUMBER
OF DATA POINTS
1601 MAX PTS
801 MAX PTS
401 MAX PTS
201 MAX PTS
101 MAX PTS
51 MAX PTS
NEXT CAL STEP
PRESS <ENTER>
TO SELECT
    
```

MENU C3
CONFIRM CALIBRATION PARAMETERS
PORT 1 CONN K CONN (M)
PORT 2 CONN SMA (M)
REFLECTION PAIRING MIXED
LOAD TYPE SLIDING
THROUGHLINE PARAMETERS
REFERENCE IMPEDANCE
TEST SIGNALS
START CAL
PRESS <ENTER> TO SELECT OR CHANGE

Step 9.

When menu C3 (left) appears, if you want to change any of the parameters shown in blue letters, place the cursor on that parameter and press the Enter key. For this example, we will change them all, starting with the top one. Move the cursor to **PORT 1 CONN** and press the Enter key.

Step 10.

In menu C4 (below), which appears next, move the cursor to **K CONN (M)** and then press the Enter key. This choice presumes that you have a K-Female connector on the device-under-test (DUT). Remember, in this menu you choose the connector type on the test port, or the connector type that *mates* with the DUT connector. When menu C3 returns, observe that **K CONN (M)** is now shown in blue for the **PORT 1 CONN** choice.

MENU C4
SELECT PORT 1 CONNECTOR TYPE
SMA (M)
SMA (F)
K-CONN (M)
K-CONN (F)
TYPE N (M)
TYPE N (F)
GPC-3.5 (M)
GPC-3.5 (F)
GPC-7
USER DEFINED
MORE
PRESS <ENTER> TO SELECT

MENU C3
CONFIRM CALIBRATION PARAMETERS
PORT 1 CONN K CONN (M)
PORT 2 CONN K CONN (M)
REFLECTION PAIRING MIXED
LOAD TYPE SLIDING
THROUGH PARAMETERS
REFERENCE IMPEDANCE
TEST SIGNALS
START CAL
PRESS <ENTER> TO SELECT OR CHANGE

Step 11.

With menu C3 (left) displayed, move the cursor to **PORT 2 CONN** and press the Enter key. Following the procedure in step 10, select **K CONN (M)** for the Port 2 connector.

Step 12.

When menu C3 returns:

- a. Observe that **PORT 2 CONN** now reflects **K CONN (M)**.
- b. Move cursor to **REFLECTION PAIRING** and press the Enter key. This brings up menu C13 (below).

MENU C13
SELECT REFLECTION PAIRING
MIXED (OPEN-SHORT SHORT-OPEN)
MATCHED (OPEN-OPEN SHORT-SHORT)
PRESS <ENTER> TO SELECT

Reflection Pairing lets you mix or match the Open and Short reflection devices in the Calibration Sequence menus. The **MIXED** choice lets you calibrate using first an Open on one port and a Short on the other, then a Short on one port and an Open on the other. Conversely, **MATCHED** lets you calibrate first using an Open on both ports then using a Short on both ports. For this example, choose **MIXED** and press the Enter key.

Step 13.

When menu C3 returns:

- a. Observe that **REFLECTION PARING** now reflects **MIXED**.
- b. Move cursor to **LOAD TYPE** and press the Enter key. This brings up menu C6 (below).

MENU C3
CONFIRM CALIBRATION PARAMETERS
PORT 1 CONN TYPE N (M)
PORT 2 CONN TYPE N (F)
REFLECTION PARING MIXED
LOAD TYPE BROADBAND
THROUGH PARAMETERS
REFERENCE IMPEDANCE
TEST SIGNALS
START CAL
PRESS <ENTER> TO SELECT

MENU C6
SELECT TYPE OF LOAD
BROADBAND FIXED LOAD
SLIDING LOAD (MAY ALSO REQUIRE BROADBAND FIXED LOAD)
PRESS <ENTER> TO SELECT

This menu lets you select either of two load types, broadband or sliding. Broadband loads are adequate for all but the most demanding reflection measurements. They are easier to use and less expensive than sliding loads. If you choose a sliding load, refer to paragraph 7-3 for a procedure on setting pin depth.

For this example, select **BROADBAND LOAD** and press the Enter key.

- c. The next menu to appear, C6A (left), prompts you to enter an impedance value. For this example, use the rotary knob to change the displayed value to 50 Ω. Alternatively, you can key in 50 ohms. That is, press 50 on the keypad and the X1 terminator key. If the value were 1 μΩ, you would key in .001 and press 10⁻³. Conversely, if the value was 1 MΩ, you would key in 1000 and press the 10³ terminator key.

MENU C6A
ENTER BROADBAND LOAD IMPEDANCE
BROADBAND LOAD IMPEDANCE 50.000 Ω
PRESS <ENTER> TO SELECT

MENU C20
ENTER THROUGH LINE PARAMETERS
OFFSET LENGTH 0.0000 mm
THROUGHLINE IMPEDANCE 50.000 Ω
PRESS <ENTER> WHEN COMPLETE

Step 14.

When menu C3 again returns:

- a. Observe that **LOAD TYPE** now shows **BROADBAND**.
- b. Move cursor to **THROUGH PARAMETERS** and press the Enter key.

Step 15.

Menu C20 (left) appears next. It lets you define the length of the offset and the impedance of the throughline. For this example, enter 0 mm for length and 50 ohms for impedance.

Step 16.

When menu C3 reappears, move the cursor to **REFERENCE IMPEDANCE** and press the Enter key. This brings up menu C17 (left).

MENU C17
ENTER REFERENCE IMPEDANCE
REFERENCE IMPEDANCE 50.000 Ω
PRESS <ENTER> WHEN COMPLETE

Step 17.

Move cursor to **REFERENCE IMPEDANCE** and use the rotary knob to change the displayed value to 50 Ω .

Press the Enter key when you have completed your value entry.

Step 18.

When menu C3 returns, select **TEST SIGNALS** to bring up menu SU2 (left).

Step 19.

Menu SU2 lets you define the power level of the signals at the two test ports. Power delivered to the DUT by the test set must be such that the measured signals are well above the noise floor but below the 0.1 dB compression level of the Test Set samplers. (Noise floor and maximum signal into Port 2 levels are specified in Appendix C.)

MENU SU2
TEST SIGNALS
POWER CONTROL 0.0 dB (0 TO -20)
PORT 1 ATTN 20 dB (0 - 70)
PORT 1 POWER XX.XX dBm
PORT 2 ATTN X0 dB (0-40)
CALIBRATE FOR FLATNESS (CAL EXISTS)
FLATNESS CORRECTION AT XX.X dBm
SOURCE 2 PWR XX.X dBm
PREVIOUS MENU
PRESS <ENTER> TO SELECT

For measuring high power signals, a Port 2 attenuator in the forward transmission path allows up to 1 Watt of power (30 dBm) before 0.1 dB compression occurs.

Determine the required input power level and the expected output RF power level from the DUT. Ideally, the Port 2 step attenuator should be set so that the input to the test sampler (left) is less than -10 dBm. For example, if the input to the DUT is set for -20 dBm and the device gain is 40 dB, set the **PORT 2 ATTN** menu option for 20 dB.

(If you needed to calibrate the test port for power flatness, you would move the cursor to **FLATNESS CORRECTION** and press the Enter key.)

Finally, move the cursor to **PREVIOUS MENU** and press the Enter key. This returns you to menu SU1. When you get there, press the Enter key to return to menu C3.

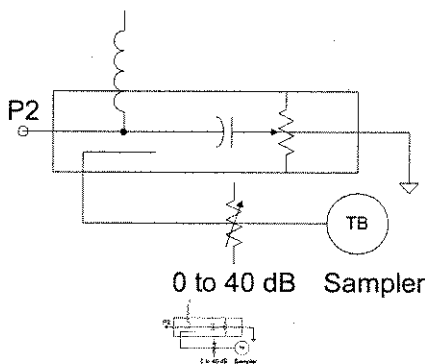

Step 20.

When menu C3 reappears, select **START CAL** and press the Enter key to begin the calibration procedure.

MENU C3
CONFIRM CALIBRATION PARAMETERS
PORT 1 CONN TYPE N (M)
PORT 2 CONN SMA (M)
REFLECTION PAIRING MIXED
LOAD TYPE SLIDING
THROUGH PARAMETERS
REFERENCE IMPEDANCE
TEST SIGNALS
START CAL
PRESS <ENTER> TO SELECT OR CHANGE

Continue the calibration sequence by following the prompts as they appear. Connect the appropriate Isolation Devices, Broadband Loads, Opens, Shorts, and Throughlines, when requested in the calibration sequence.

7-5 **OFFSET-SHORT
CALIBRATION
PROCEDURE**

The Offset-Short calibration is the standard technique for waveguide. It uses an offset Short and a flush Short to categorize the inherent errors in the waveguide measurement system. These errors include those caused by connectors as well as internal system errors such as RF leakage, IF leakage, and component interaction.

Calibration Procedure A detailed, step-by-step procedure for performing a Offset-Short calibration is given below.

Step 1. Press the Begin Cal key.

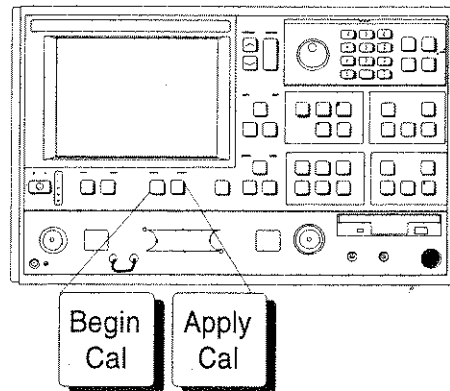

Step 2.

Select **CHANGE CAL METHOD AND LINE TYPE**, in menu C11 (left). (This assumes **OFFSET SHORT** and **WAVEGUIDE** are not presently shown in blue as being selected.)

MENU C11
BEGIN CALIBRATION
KEEP EXISTING CAL DATA
REPEAT PREVIOUS CAL
AUTOCAL
CAL METHOD XXXXXXX
TRANSMISSION LINE TYPE: XXXXXXX
CHANGE CAL METHOD AND LINE TYPE
NEXT CAL STEP
PRESS <ENTER> TO SELECT

```

MENU C11A
-----
CHANGE
CAL METHOD
AND LINE TYPE
NEXT CAL STEP
CAL METHOD
STANDARD
(NOT USED FOR
WAVEGUIDE)
OFFSET SHORT
LRL/LRM
TRANSMISSION
LINE TYPE
COAXIAL
WAVE GUIDE
MICROSTRIP
PRESS <ENTER>
TO SELECT
    
```

Step 3.

When menu C11A (left) appears, move cursor to the following:

- a. **OFFSET SHORT**, then press the Enter key. This selects Offset Short as the calibration method.
- b. **WAVEGUIDE**, then press the Enter key. This brings menu C5 (bottom left) to the screen.
- c. **NEXT CAL STEP**, then press the Enter key. This causes menu C11 to return to the screen.

Step 4.

When menu C11 reappears, confirm that the **OFFSET SHORT** calibration method and **WAVEGUIDE** line-type have been selected. Select **NEXT CAL STEP** and press the Enter key to proceed.

Step 5.

Menu C5 appears next. This menu (bottom left) lets you select the type of calibration. For this example, move the cursor to **FULL 12-TERM** and press the Enter key.

```

MENU C5
-----
SELECT
CALIBRATION TYPE
FULL 12-TERM
1 PATH
2 PORT

TRANSMISSION
FREQUENCY
RESPONSE
REFLECTION
ONLY
PRESS <ENTER>
TO SELECT
    
```

Step 6.

The next menu, C5D (below), lets you choose whether to include or exclude the error terms associated with leakage between measurement channels. For a normal calibration, you would choose to include these error terms. Therefore, move the cursor to **INCLUDE ISOLATION (STANDARD)** and press the Enter key.

```

MENU C5D
-----
SELECT USE
OF ISOLATION
IN CALIBRATION
INCLUDE
ISOLATION
(STANDARD)
EXCLUDE
ISOLATION
PRESS <ENTER>
TO SELECT
    
```

```

MENU C1
SELECT
CALIBRATION
DATA POINTS
NORMAL
(1601 POINTS
MAXIMUM)
C.W.
(1 POINT)
N-DISCRETE
FREQUENCIES
(2 TO 1601
POINTS)
TIME DOMAIN
(HARMONIC)
PRESS <ENTER>
TO SELECT
    
```

Step 7.

Menu C1 (left), which appears next, lets you select the number of frequency points at which calibration data is to be taken. Of these choices, which were described in paragraph 7-4, choose **NORMAL (1601 POINTS MAXIMUM)** for this example.

Step 8.

The next menu, C2 (below), lets you set your start and stop frequencies. For this example, move cursor to **START**, press 40 on keypad, and hit MHz terminator key. Perform like operations for the **STOP** choice, except make entry read 20 GHz. After setting the frequencies, select **NEXT CAL STEP** and press the Enter key.

```

MENU C2
FREQ RANGE OF
CALIBRATION
START
0.040000000GHZ
STOP
20.000000000 GHz
201 DATA PTS
0.099800000 GHz
STEP SIZE
MAXIMUM NUMBER
OF DATA POINTS
1601 MAX PTS
801 MAX PTS
401 MAX PTS
201 MAX PTS
101 MAX PTS
51 MAX PTS
NEXT CAL STEP
PRESS <ENTER>
TO SELECT
    
```

```

MENU C3B
CONFIRM
CALIBRATION
PARAMETERS
LOAD TYPE
BROADBAND
THROUGH LINE
PARAMETERS
WAVEGUIDE
PARAMETERS
XXXXXXXXX
TEST SIGNALS
START CAL
PRESS <ENTER>
TO SELECT
OR CHANGE
    
```

Step 9.

When menu C3B (bottom left) appears, if you want to change any of the parameters shown in blue letters, place the cursor on that parameter and press the Enter key. (These choices operate the same as was described for menu C3 in paragraph 7-4.) For this example, we change the waveguide parameters. Move the cursor to **WAVEGUIDE PARAMETERS** and press the Enter key.

```

MENU C15
SELECT
WAVEGUIDE
KIT TO USE
-INSTALLED KIT-
IDENTIFIER
XXXX
CUTOFF FREQ:
XXX.XXXXXXXXXX GHz
SHORT 1
XX.XXXX mm
SHORT 2
XX.XXXX mm
USE INSTALLED
WAVEGUIDE KIT
USER DEFINED
    
```

Step 10.

When menu C15 (left) appears, move cursor to one of the two available choices and press the Enter key. These choices are described below.

- a. **USE INSTALLED WAVEGUIDE KIT:** Selecting this choice uses the values shown in blue for IDENTIFIER, CUTOFF FREQ, SHORT 1, and SHORT 2. Select this choice, for this example.
- b. **USER DEFINED:** Selecting this choice brings up menu C15A (below), which lets you specify waveguide parameters. After defining your waveguide parameters, you are returned to menu C3B.

```

MENU C15A
ENTER
WAVEGUIDE
PARAMETERS
WAVEGUIDE
CUTOFF FREQ:
XXX.XXXXXXXXXX GHz
OFFSET LENGTH
OF SHORT 1
XX.XXXX mm
OFFSET LENGTH
OF SHORT 2
XX.XXXX mm
PRESS <ENTER>
WHEN COMPLETE
    
```

Step 11.

Continue the calibration sequence by following the prompts as they appear. Connect the appropriate Isolation Devices, Broadband Loads, Shorts, and Throughlines, when requested in the calibration sequence.

**7-7 LRL/LRM CALIBRATION
PROCEDURE**

The LRL/LRM (line-reflect-line/line-reflect-match) calibration* feature provides an enhanced capability for error compensation when making measurements in coaxial, microstrip and waveguide transmission media. Instead of using the standard Open, Short, and Load, the LRL/LRM calibration method uses two lines and a reflection or match. The difference in length between line 1 and line 2 creates the measurements necessary for the error solutions.

The LRL/LRM calibration technique uses the characteristic impedance of a length of transmission line or a precision match as the calibration standard. A full LRL/LRM calibration consists of two transmission line measurements, a high reflection measurement, and an isolation measurement. Using this technique full 12-term error correction can be performed with the 373XXA.

Three line LRL/LRM calibration can also be selected. In a two-line LRL measurement, the difference in length between line 1 and line 2 is necessary for calibration but limits the frequency range to a 9:1 span. The use of three lines in the calibration extends the frequency range to an 81:1 span. A combination of LRL and LRM can accommodate any broadband measurement.

1. Through the use of LRL/LRM calibration and an external computer, in conjunction with ANACAT software, multiple-level de-embedding is possible. This calibration allows you to make semi-conductor chip measurements up to 40 GHz with a single test fixture.
2. In addition, any non-coaxial transmission media, including mixed media interconnects, can be accommodated. For example, a test device with a waveguide input and a coplanar microstrip output can be measured. Software automatically compensates for the microstrip dispersion.

A detailed procedure for calibrating for a measurement using the LRL/LRM method is provided in the following pages.

*LRM Calibration Method of Rhode & Scharwz, Germany

**LRL/LRM Calibration
(Microstrip)**

Microstrip is a dispersive media. The 373XXA applies dispersion compensation during calibration for microstrip measurements. Because the 373XXA must know the specific microstrip parameters, during the calibration procedure menus are available for entering the

- width of the strip
- thickness of the substrate
- substrate dielectric constant
- effective dielectric constant Z_c
- characteristic impedance (reference)

When testing microstrip devices it is necessary to launch from coax to microstrip. In production testing this launching must be temporary, so that the device can easily be installed in and be removed from the fixture. The requirement for launching to 65 GHz is met by the ANRITSU Universal Test Fixture (UTF). The UTF provides accurate, repeatable launch to substrates from 5 to 70 mils thick, and from 0.15 to 2 inches long. Offset connections and right angles can be configured. DC bias probes can be mounted to the UTF to inject bias onto the substrate. UTF calibration/verification kits are available for alumina in 10 mil, 15 mil, and 25 mil microstrip, and for 25 mil coplanar waveguide. Although a UTF is not essential, the following calibration procedures presume its use.

Step 1. Select the desired LRL line substrates from the appropriate microstrip calibration kit. When called for in the calibration sequence, mount the LRL line substrates on the UTF following the procedure given in the 3680 OMM.

Step 2. Press the Begin Cal key.

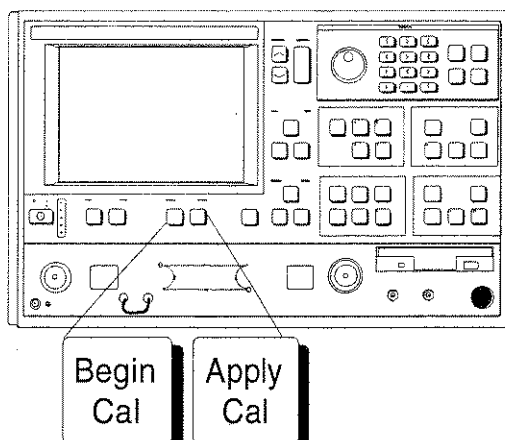

MENU C11
BEGIN CALIBRATION
KEEP EXISTING CAL DATA
REPEAT PREVIOUS CAL
AUTOCAL
CAL METHOD XXXXXXXX
TRANSMISSION LINE TYPE: XXXXXXXX
CHANGE CAL METHOD AND LINE TYPE
NEXT CAL STEP
PRESS <ENTER> TO SELECT

Step 3.

Select **CHANGE CAL METHOD AND LINE TYPE**, in menu C11 (left). (This assumes LRL and MICROSTRIP are not presently shown in blue as being selected.)

Step 4.

When menu C11A (bottom left) appears, highlight the following selections.

- a. LRL/LRM and press the Enter key.
- b. MICROSTRIP and press the Enter key.
- c. **NEXT CAL STEP** and press the Enter key.

Step 5.

When menu C11 reappears, confirm that the **LRL/LRM** calibration method and **MICROSTRIP** line-type have been selected. Select **NEXT CAL STEP** and press the Enter key to proceed.

Step 6.

Continue through the calibration sequence, and make the following selections from the menus that appear:

INCLUDE ISOLATION (STANDARD) (Menu C5D)

NORMAL (1601 POINTS MAXIMUM) (Menu C1)

MENU C11A
CHANGE CAL METHOD AND LINE TYPE
NEXT CAL STEP
CAL METHOD STANDARD (NOT USED FOR WAVEGUIDE)
OFFSET SHORT
LRL/LRM
TRANSMISSION LINE TYPE
COAXIAL
WAVE GUIDE
MICROSTRIP
PRESS <ENTER> TO SELECT

c.

a.

b.

MENU C5D
SELECT USE OF ISOLATION IN CALIBRATION
INCLUDE ISOLATION (STANDARD)
EXCLUDE ISOLATION
PRESS <ENTER> TO SELECT

MENU C1
SELECT CALIBRATION DATA POINTS
NORMAL (1601 POINTS MAXIMUM)
C.W. (1 POINT)
N-DISCRETE FREQUENCIES (2 TO 1601 POINTS)
TIME DOMAIN (HARMONIC)
PRESS <ENTER> TO SELECT

MENU C2
FREQ RANGE OF CALIBRATION
START
0.0400000000GHz
STOP
20.000000000 GHz
201 DATA PTS
0.099800000 GHz
STEPSIZE
MAXIMUM NUMBER OF DATA POINTS
1601 MAX PTS
801 MAX PTS
401 MAX PTS
201 MAX PTS
101 MAX PTS
51 MAX PTS
NEXT CAL STEP
PRESS <ENTER> TO SELECT

```

MENU C3G
-----
CONFIRM
CALIBRATION
PARAMETERS

LRL/LRM
PARAMETERS

MICROSTRIP
PARAMETERS
  USER DEFINED

TEST SIGNALS

START CAL

PRESS <ENTER>
  TO SELECT
  OR CHANGE
    
```

Step 7.

START (Your start frequency) (Menu C2)
STOP (Your stop frequency) (Menu C2)

When menu C3G appears, if you want to change microstrip parameters to be different from those shown in blue, place cursor on **MICROSTRIP PARAMETERS** and press the Enter key.

Step 8.

When menu C16 (left) appears, move cursor to the ANRITSU 3680 UTF calibration kit you wish to use or to **USER DEFINED**; then press the Enter key.

The calibration kit selections shown in menu C16 are for the following 3680 Connection Substrate Kits:

10 MIL KIT — 36804B-10M
15 MIL KIT — 36804B-15M
25 MIL KIT — 36804B-25M

If you choose **USER DEFINED**, the next menu that appears (C16A), lets you characterize your parameters. Move cursor to each selection, key in a value, then press the Enter key to return to menu C16.

```

MENU C16
-----
SELECT
MICROSTRIP
KIT TO USE

10 MIL KIT

15 MIL KIT

25 MIL KIT

USER DEFINED

PRESS <ENTER>
  WHEN COMPLETE
    
```

```

MENU C16A
-----
ENTER
MICROSTRIP
PARAMETERS

WIDTH OF
STRIP
XX.XXXX mm

THICKNESS OF
SUBSTRATE
XXXX.XXXX mm

Zc
XXX.XXX pΩ

SUBSTRATE
DIELECTRIC
XX.XX

EFFECTIVE
DIELECTRIC
XX.XX
(RECOMMENDE D
0.00)

PRESS <ENTER>
  WHEN COMPLETE
    
```

```

MENU C3G
CONFIRM
CALIBRATION
PARAMETERS
LRL/LRM
PARAMETERS
CHANGE
MICROSTRIP
PARAMETERS
XXXXXXXXX
START CAL
PRESS <ENTER>
TO SELECT
    
```

Step 9.

Select **LRL/LRM PARAMETERS**, when menu C3G returns.

Step 10.

When menu C18 appears, you have two choices to make: whether your calibration is to be two-line or three-line, and where you want to have your reference plane.

- a. *Select the reference plane:* Highlight **MIDDLE OF LINE 1 (REF)** or **ENDS OF LINE 1 (REF)** and press the Enter key.
- b. *Select the type of LRL/LRM calibration:* Highlight **ONE BAND**, for a two-line calibration; or **TWO BANDS**, for a three-line calibration.

As mentioned earlier, in a two-line measurement, the difference in length between line 1 and line 2 is necessary for calibration but limits the frequency range to a 9:1 span. By using three lines in the calibration, you extend the frequency range to an 81:1 span.

If you select **TWO BANDS**, skip to Step 12.

```

MENU C18
CHANGE LRL/LRM
PARAMETERS
NEXT CAL STEP
NUMBER OF
BANDS USED
ONE BAND
TWO BANDS
LOCATION OF
REFERENCE
PLANES
MIDDLE OF
LINE 1 (REF)
ENDS OF
LINE 1 (REF)
PRESS <ENTER>
TO SELECT
    
```

EITHER/OR

EITHER/OR

Step 11.

(2-Line

MENU C18A	
CHANGE LRL/LRM PARAMETERS	
NEXT CAL STEP	e.
CHARACTERIZE CAL DEVICES	
DEVICE 1 LINE 1 (REF) X.XXXX mm	a.
DEVICE 2 LINE /MATCH X.XXXX mm	b., c., d.
PRESS <ENTER> TO SELECT OR SWITCH	

When menu C18A (left) appears, make the following selections:

- a. Move the cursor to **DEVICE 1 LINE 1 (REF)** and key in the value.
- b. Move the cursor to **DEVICE 2 LINE/MATCH**. Here you have another decision to make: whether your calibration is to be LRL or LRM. For this selection, the Enter key acts as a toggle.
- c. If you toggle such that **LINE** turns red, then key in the value for line 2. This value depends on your frequency range.
- d. If you toggle **MATCH** red, observe that **FULLBAND** appears. This indicates that your reflective device covers the full calibration range.
- e. When you have made both selections, move the cursor to **NEXT CAL STEP** and press the Enter key to produce the next menu. Skip to step 13.

Step 12.

(3-Line

```

MENU C18B
-----
CHANGE LRL/LRM
PARAMETERS
NEXT CAL STEP
CHARACTERIZE
CAL DEVICES
  DEVICE 1
  LINE 1 (REF)
  XX.XXXX
  DEVICE 2
  LINE/MATCH
  XX.XXXX/LOWBAND
  DEVICE 3
  LINE/MATCH
  XX.XXXX/HIGHBAND
FREQ AFTER
WHICH THE USE
OF DEVICE 2
AND DEVICE 3
IS EXCHANGED
BREAKPOINT
XXX.XXXXXXXXXXGHZ
PRESS <ENTER>
TO SELECT
OR SWITCH
    
```

g.

a.

b., c., d.

e.

f.

When menu C18B (left) appears, make the following selections:

- a. Move the cursor to **DEVICE 1 LINE 1 (REF)** and key in the value (typically 1.00 cm). Press the Enter key to select.
- b. Move the cursor to **DEVICE 2 LINE/MATCH**. Both here, and for the next choice, you have another decision to make: whether your calibration is to be LRL or LRM. For this selection, the Enter key acts as a toggle.
- c. If you toggle such that **LINE** turns red, then key in the value for line 2. This value depends on your frequency range.
- d. If you toggle **MATCH** red, observe that **LOWBAND** appears. This indicates that your reflection device is a low-band load. This load must have a passband such that it passes all frequencies from the start to the breakpoint (see below).
- e. Move the cursor to **DEVICE 3 LINE/MATCH**. If device 3 is a line, key in the value. If it is a match, the term **HIGHBAND** will appear. This indicates that your match is a high-band load. This load must have a passband such that it passes all frequencies from the breakpoint to the stop frequency.
- f. Move the cursor to **BREAKPOINT** and enter your breakpoint frequency. For two-line LRL calibrations, select a breakpoint equal to the upper frequency of the low frequency LRL line. For a combined LRL and LRM calibration, select a breakpoint equal to the top frequency of the calibration divided by six; for instance, to cover the frequency range 0.04 to 60 GHz, select 10 GHz as the breakpoint.
- g. When you have made all selections, move the cursor to **NEXT CAL STEP** and press Enter to produce the next menu.

MENU C19	
CHANGE LRL/LRM PARAMETERS	
NEXT CAL STEP	c.
OFFSET LENGTH OF REFLECTIVE DEVICE	
OFFSET LENGTH X.XXXX mm	a.
TYPE OF REFLECTION	
GREATER THAN Z_0	b.
LESS THAN Z_0	
PRESS <ENTER> TO SELECT	

EITHER/OR

Step 13.

The next menu, C19, gives you choices for your reflective device.

- a. Move the cursor to **OFFSET LENGTH** and key in a value (typically 0.0000 mm).
- b. Move the cursor to **GREATER THAN Z_0** or **LESS THAN Z_0** , depending on whether your reflective device is an Open or a Short. Press the ENTER key to select.

NOTE

Choose **GREATER THAN Z_0** for an Open and **LESS THAN Z_0** for a Short.

- c. When you complete your choices, move the cursor to **NEXT CAL STEP** and press the Enter key.

Step 14.

When menu C3G reappears, move cursor to **START CAL** and press Enter.

MENU C3G	
CONFIRM CALIBRATION PARAMETERS	
CHANGE LRL/LRM PARAMETERS	
CHANGE MICROSTRIP PARAMETERS XXXXXXXXXX	
START CAL	

Step 15.

Continue the calibration sequence by following the prompts as they appear. Mount the appropriate LRL line substrates when requested in the calibration sequence.

For the **REFLECTIVE DEVICE** and **BROADBAND LOAD** prompts, remove all substrates from the UTF and allow the lower jaws to short the center conductor. Separate the connector blocks by at least an inch. (The **BROADBAND LOAD** prompt only appears if you selected to include isolation in menu C5B.)

Step 16.

Store the calibration.

**LRL/LRM Calibration
(Coaxial)**

An LRL cal kit is necessary to perform the coaxial calibration. Calibration kits for GPC-7 are available from Maury Microwave and Hewlett Packard.

Two line lengths are used as the impedance standard. The calibration frequency range is limited by the difference in the lengths of the two lines. Their length must be different by approximately 90 degrees at the mid-band frequency. A good calibration can be achieved over the range of 18 degrees to 162 degrees making it possible to calibrate LRL over a 9:1 frequency range.

```

MENU C3E
-----
CONFIRM
CALIBRATION
PARAMETERS
LRL/LRM
PARAMETERS
REFERENCE
IMPEDANCE
TEST SIGNALS
START CAL
PRESS <ENTER>
TO SELECT
OR CHANGE
    
```

LRL calibration is very sensitive to uncalibrated source match. If some padding is placed at the test ports, the directivity and source match will be improved. If the goal is high level measurements, then padding should be included. If low level measurements are being performed, then the padding must be left out.

Step 1. Same as Steps 1 through 6 in the Microstrip procedure, except choose **COAXIAL** in menu C11A.

Step 2. When menu C3E (left) appears, if you want to change line impedance, place cursor on **REFERENCE IMPEDANCE** and press the Enter key.

Step 3. When menu C17 (left) appears, move cursor to **REFERENCE IMPEDANCE**, key in the value, then press the Enter key.

Step 4. Same as Steps 9 through 16 in the microstrip procedure.

```

MENU C17
-----
ENTER
REFERENCE
IMPEDANCE
REFERENCE
IMPEDANCE
50.000 Ω
PRESS <ENTER>
WHEN COMPLETE
    
```

In the coaxial, three-line calibration there are factors you need to be aware of. Note that it is the line length *differences* that are important to the LRL calibration, namely $(L2-L1)$ and $(L3-L1)$ where $L1$ is the length of line 1, $L2$ is the length of line 2, and $L3$ is the length of line 3.

Longer length differences are used for longer wavelengths (lower frequencies). For frequencies up to and including the breakpoint frequency, the larger absolute value of the $(L2-L1)$ and $(L3-L1)$ differences is used. At frequencies above the breakpoint, the smaller absolute value of the $(L2-L1)$ and $(L3-L1)$ differences is used.

Consideration must also be given to selecting the breakpoint frequency. Divide the frequency range to satisfy the 9:1 rule for any given pair of lines. The range is thus divided by the frequency breakpoint into the intervals [f1, f2] and [f2, f3]. Based on these intervals, next determine the appropriate length differences; the longer difference is associated with the lower interval [f1, f2]. Note that if the differences are equal to each other, concurrent frequency ranges are implied and only two lines need be used.

Select a line 1 reference (L1) around which to place these two differences. Use any combination of positive or negative differences around line 1. The software selects which interval is associated with either of line 2 or line 3 by comparing the absolute values of the differences with line 1. Data from the two lines, which make up the larger absolute difference, are used for the interval [f1, f2]. Data from the two lines, which make up the smaller absolute difference, are used for the interval [f2, f3].

**LRL/LRM Calibration
(Waveguide)**

The waveguide procedure is very similar to the coaxial and microstrip procedures already described.

Step 1. Same as Steps 1 through 6 in the Microstrip procedure, except choose **WAVEGUIDE** in menu C11A.

The only difference is with menu C3F (left). For a waveguide calibration, move the cursor to **WAVEGUIDE CUTOFF FREQ** and press Enter. This action calls menu C15B, which lets you enter the waveguide cutoff frequency. After doing, so you are returned to menu C3F.

```
MENU C3F
-----
CONFIRM
CALIBRATION
PARAMETERS

LRL/LRM
PARAMETERS

WAVEGUIDE
CUTOFF FREQ

TEST SIGNALS

START CAL

PRESS <ENTER>
TO SELECT
OR CHANGE
```

Step 2. When menu C3F reappears, place cursor on **CHANGE LRL/LRM PARAMETERS** and press the Enter key.

Step 3. Same as Steps 9 through 13 in the Microstrip procedure.

```
MENU C15B
-----
ENTER
WAVEGUIDE
CUTOFF
FREQUENCY

WAVEGUIDE
CUTOFF FREQ
XX.XXXX GHz

PRESS <ENTER>
WHEN COMPLETE
```

**7-6 TRM CALIBRATION
PROCEDURE**

The TRM Calibration procedure is the same as the LRL/LRM procedure, except that certain parameters have been set by default so that the calibration is simpler to perform (e.g., the L parameter in the LRM calibration has been set to equal a length of 0 mm for a through, and the R parameter is set for a short).

Chapter 8

Measurements

Table of Contents

8-1	INTRODUCTION	8-3
8-2	TRANSMISSION AND REFLECTION	8-3
	Setup and Calibration	8-3
	Measurement Discussion.	8-7
8-3	LOW LEVEL AND GAIN	8-12
	373XXA System Considerations	8-12
	Test Device (DUT) Considerations	8-19
8-4	GROUP DELAY	8-20
8-5	ACTIVE DEVICE	8-24
8-6	MULTIPLE SOURCE CONTROL	8-29
	Control Formula.	8-29
	Bands	8-30
	Operation Procedures.	8-30
	Source Lock Polarity: Normal/Reverse.	8-34
8-7	ADAPTER REMOVAL	8-35
8-8	GAIN COMPRESSION	8-40
	Power and VNA'S	8-40
	Swept Power Gain Compression	8-42
	Swept Frequency Gain Compression	8-42
8-9	RECEIVER MODE	8-60
	Source Lock Mode.	8-60
	Tracking Mode.	8-60
	Set-on Mode	8-60
	Receiver Mode Block Diagram	8-61
	Receiver Mode Menus.	8-61
	Procedure, Receiver Mode Operation.	8-61

Chapter 8

Measurements

8-1 INTRODUCTION

This section discusses typical measurements that can be made with the Model 373XXA Vector Network Analyzer.

8-2 TRANSMISSION AND REFLECTION

This discussion provides information on general measurement considerations and transmission and reflection measurements using the 373XXA.

APPLY POWER TO THE SYSTEM

Then, Turn On the Analyzer

SETUP

System Should Be Warmed Up for
At Least 60 to 80 Minutes

DEFAULT PARAMETERS

Known-Good Starting Point

Selected With the Default
program Key

SWEEP TEST MENU

Start and Stop Frequencies

Source Power Level

Setup and Calibration

To get started, apply power to the system.

After turning on the power, allow the system to warm up for at least 60 minutes before operation.

In normal operation, the system comes on line in the state that it was in when last turned off. If you want to return the system to its default state, you can do so by pressing the Default Program key twice.

The default parameters provide a known starting point. For example, they reset the start and stop frequencies for maximum sweep width, the source control to 0 dB, and the display resolution to 401 data points.

The Sweep Setup menu should now appear on the display (it also can be displayed using the Setup Menu key). If you like, you can select a new start frequency, stop frequency, or source power.

You can further reduce the power level at Ports 1 and 2 with the built-in attenuators. Using the Reduced Test Signals option in the Sweep Setup menu, you can change the setting of the Port 1 source attenuator over a range of from 0 to 70 dB. The Port 2 test attenuator has a range of from 0 to 40 dB (in 10 dB steps) (if Option 6 is installed).

SWEEP SETUP MENU

Use the "Test Signals" Option to Add Attenuation

CALIBRATION

Select Begin Cal Key

Select Type of Calibration

Select Frequency Range of Calibration

Install Calibration Kit Devices As Instructed by the Menu

Store the Calibration Data Internally or to Disk

MEASUREMENT OPTIONS

Displays

Markers

Limits

Outputs

Sweeps

Enhancements

DISPLAYS

Four Channels

Each Channel Can Display Up to Two Graph Types

Calibration Parameters Can Be Selected By Any Channel

Install the calibration kit devices to the test ports as instructed by the U3 menu. Both the capacitance coefficients for the Open and the offset lengths for the Open and Short can be modified or defined.

Selecting the Begin Cal key starts the calibration process. The Calibration menus step you through the calibration process, as follows:

Select the type of calibration desired.

Select the frequency range of calibration. Using the Data Points key, you can choose between 1601 to 51 measurement data points.

When the calibration is completed, you can store the calibration data on a disk. You are now ready to install the test device and proceed with the measurement. At this point you have a number of measurement options to consider such as displays, markers, limits, outputs, sweeps, and enhancements.

You can select any of the available graph types and display them for any calibrated parameter on any of the four channels (if a 12-term calibration was performed).

MARKERS

Selectable User Marker Menu
6 Markers Available
Delta And Max/Min Modes

LIMITS

Selectable Using Limits Key
Two Limit Lines Available for Each Channel
Limit lines can be flat, sloped, or segmented with up to 10 discrete frequency segments
Functions With All Graph Types

OUTPUT

Select Start Print key to Output Display
Use the Hard Copy Menu to Choose Output Type and Output Device

OUTPUT HEADERS

Selected From the Output Menu Under the Setup Output Headers Option
Labels Output With Device/Serial Number, Date, Operator's Name, and comments

Up to six markers are available. Using the Marker Menu, you can set the frequency of each one, you can set each one in the delta marker mode, and you can set each marker's level to maximum or minimum.

In some cases—such as in a production environment—limit lines are desirable. Options within the menu called up using the Limits key, provide for one or two flat, sloped, or single-point-segmented limit lines for each channel. These limit lines function with all of the graph types, including Smith and admittance. The color of the limit lines (blue) differs from that of the measurement trace. This allows for easy analysis of results.

The Hard Copy Menu key menu (Figure 8-1) gives you a choice between a printer and a colored-pen plotter. It also lets you select menus from which you may choose from a variety of print or plot options.

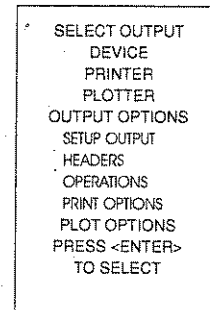

Figure 8-1. Output Menu

To output the display, press the Start Print key. The default setting provides for a full display printout from the associated printer.

To label the output, select Setup Output Headers in the Output Menu or press the Device ID key.

On the output to the printer, plotter, or disk, a menu then appears that lets you specify the device name/serial number, the date, the operator's name, and user comments (Figure 8-2).

Sweep frequencies can be changed with the calibration applied as long as the frequencies are between the calibration start and stop frequencies.

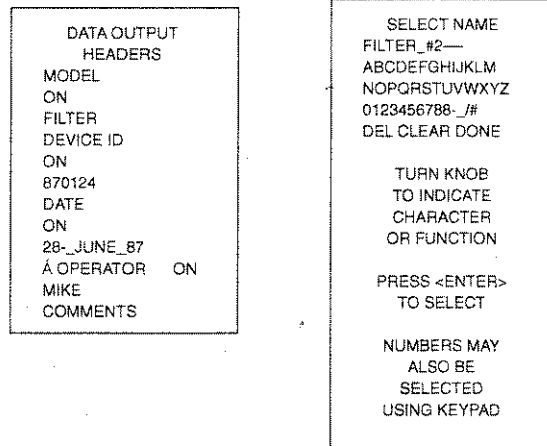

SWEEPS

Start/Stop Frequencies Can Be Changed With Calibration Applied

Marker Sweep Available From the Setup Menu

Data Points Selectable Using the Data Points key

Figure 8-2. Label Menus

Additionally, a marker sweep can be selected from the Setup Menu. This allows you to sweep between any two active markers as long as the frequency of each falls between the calibrated start and stop frequencies.

Using the Data Points key, you can select the number of data points for optimal resolution-vs-speed.

ENHANCEMENTS

Intermediate Frequency Bandwidth
Changed Using the Video IFBW
Key

Averaging and Smoothing Values
Set Using Ave/Smooth Menu Key

Averaging and Smoothing Turned
On or Off Using Trace Smooth and
Average keys

Finally, you can enhance the measurement data by reducing the IF bandwidth and using averaging and/or smoothing.

- ❑ Change the IF bandwidth by selecting the Video IF BW key.
- ❑ Set the averaging and smoothing values by selecting the Avg/Smooth Menu key.
- ❑ Turn on the averaging and smoothing using the Trace Smooth and Average keys, which have LED's to let you know that the enhancement is being applied.

**Measurement
Discussion**

Before going any further, let us take a few moments to review some basic principles of network measurements. First, we apply incident energy to the input of a test device. If the device's input impedance differs from the measurement system's impedance, some of that energy is reflected. The remainder is transmitted through the device. We call the ratio of reflected-to-incident energy the reflection coefficient. The ratio of transmitted-to-incident energy we call the transmission coefficient (Figure 8-3).

BASIC MEASUREMENT PRINCIPLES

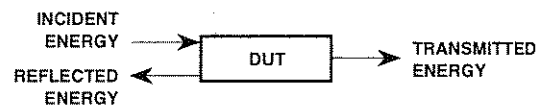

$$\text{REFLECTION COEFFICIENT} = \frac{\text{REFLECTED ENERGY}}{\text{INCIDENT ENERGY}}$$

$$\text{TRANSMISSION COEFFICIENT} = \frac{\text{TRANSMITTED ENERGY}}{\text{INCIDENT ENERGY}}$$

Figure 8-3. Basic Measurement Principles

These ratios are complex quantities that have magnitude and phase components. Using vector representation, the vector magnitude is the ratio of reflected-to-incident magnitude (or transmitted-to-incident magnitude), while the vector phase is the difference in phase between the incident energy and the reflected/transmitted energy (Figure 8-4).

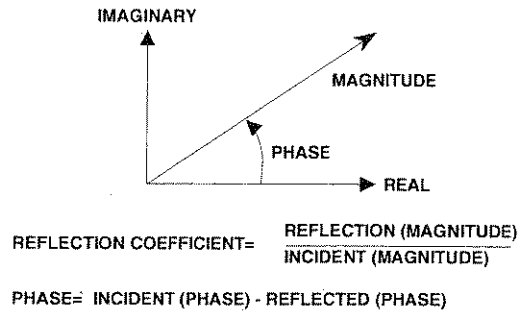

Figure 8-4. Magnitude/Phase Vector

REFERENCE PLANE

Defined At the Test Port Measurement Plane As

Magnitude = 1
Phase = 0 Degrees

Established During Calibration

The measurement reference for the incident energy is the point at which the device connects to the measurement system. We call this point the reference plane. The incident energy at the reference plane is defined as having a magnitude of 1 and a phase of 0 degrees. We establish this during the calibration.

The ratio of reflected and transmitted energy to the incident energy can be represented by a number of different measurements and units, as shown below.

MEASUREMENTS

- Log Magnitude
- Phase
- Smith Chart (Impedance)
- Group Delay (See paragraph 3-13)
- Admittance Smith Chart
- Linear Polar
- Log Polar
- Linear Magnitude
- Real and Imaginary
- Power Out

The default display for reflection measurements is the Smith chart. The default display for transmission measurements is the Log Magnitude and Phase graph.

The Smith chart is a convenient way to display device impedance and is a useful aid for the graphical design and analysis of microwave circuits (Figure 8-5).

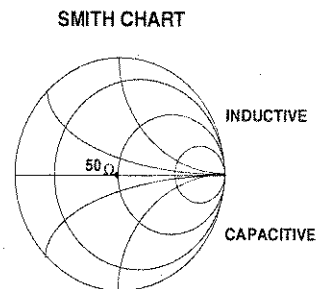

Figure 8-5 Smith Chart Display 1

DEFAULT DISPLAYS

Reflection

Smith Chart

Transmission

Log Magnitude and Phase Graph

Let us assume both that our system is already calibrated and that we have equalized the system for the test port in use. We would then

1. *Connect the Short.* A Short always appears as a dot at the left-most edge of the Smith chart's horizontal axis.
2. *Connect a Termination.* Now you will see another dot located at the center ($1+j0$) of the chart (this assumes a 50-ohm load).
3. *Connect the Open.* An Open appears as an arc on the chart's right edge. This is due to the fringing capacitance of the Open standard (Figure 8-6).

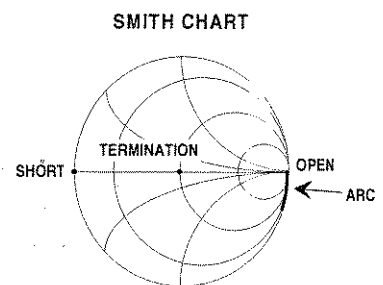

Figure 8-6. *Smith Chart Display 2*

Now let us perform a reflection measurement on a 20 dB attenuator over the 1-to-18 GHz range.

We need to determine the setup, calibration, and measurement requirements.

REFLECTION MEASUREMENT**Example: 20 dB Attenuator**

Setup
Calibration
Measurement

SETUP

Reset With the Default Parameters
Key
Set the Start Frequency to 1 GHz
Set the Stop Frequency to 18 GHz

CALIBRATION

Begin Cal Key
Reflection Only

MEASUREMENT

Select Log Magnitude Display
Install DUT
Autoscale
Set Marker 1 to Max, Marker 2 to
Min

A known good starting point is to reset with Default Program parameters. Since our measurement lies between 1 and 18 GHz, set the Start and Stop frequencies using the Sweep Setup menu that appears on the display following system reset.

Let us perform a simple calibration, Reflection Only, which uses an open, a short, and a broadband load. To do this, press the Begin Cal key and follow the directions in the menu area.

When you complete the calibration, the "CHANNEL 1 WITH S11" Smith chart appears on the display.
Now:

1. Select the Log Magnitude display and install the attenuator.
2. Select Auto Scale to optimize the display data.
3. Use Markers 1 and 2 to find the maximum and minimum impedance.

TRANSMISSION MEASUREMENT

Example: 20 dB Attenuator

Setup

Calibration

Measurement

SETUP

Use Default Program Settings

CALIBRATION

Begin Cal Key

Frequency Response (Transmission Response Only)

Now let us perform a transmission measurement on the same 20 dB attenuator over the same frequency range. We will follow the same steps as before, but this time we will use additional features.

Once again, reset the system using the Default Program key.

In this calibration we will select the N-Discrete Frequencies menu option and step all frequencies in increments of 50 MHz.

When the calibration is complete, Channel 1 will display "S21 FORWARD TRANSMISSION WITH LOG MAGNITUDE AND PHASE." You can use Markers 1 and 2 to find the maximum and minimum values of the attenuators insertion loss.

8-3 LOW LEVEL AND GAIN

This discussion provides methods and techniques for making gain and low-signal-level measurements. It is divided into 373XXA system considerations and test device considerations.

373XXA System Considerations

The 373XXA system is limited in its ability to test low-signal levels by its dynamic range and signal-to-noise-power ratio. First we will discuss receiver dynamic range, which is the difference between the maximum and minimum acceptable signal levels (Receiver Dynamic Range = $P_{max} - P_{min}$).

DYNAMIC RANGE LIMITS

High Level Accuracy Limited by the Compression of the Receiver

Low Level Accuracy Limited by Noise and Leakage Signals

Receiver Dynamic Range

The dynamic range of the 373XXA is limited by the 0.1 dB compression level of the samplers at high signal levels. It is further limited at low signal levels by leakage signals and noise.

Figure 8-7 shows the detected output signal as a function of the power level at the sampler. The 0.1 dB compression level is on the order of -10 dBm. The 373XXA is designed such that all other conversions compress at a much greater level, which leaves the samplers as the main source of nonlinearity.

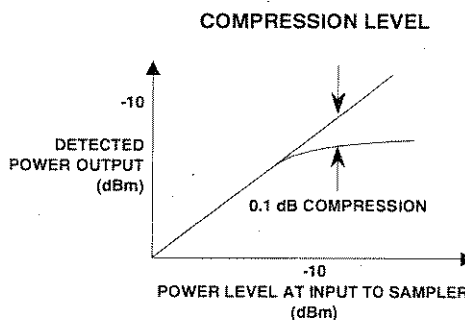

Figure 8-7. Compression at 0.1 dB

The small signal response is limited by errors due to noise and leakage signals. The leakage signals are both from within the 373XXA and at the device-under-test (DUT) connectors.

The detected signal is the vector sum of the desired signals, the noise signals, and the leakage signals. These signals introduce an error or uncertainty (Figure 8-8).

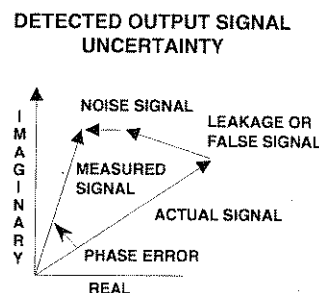

Figure 8-8. Amplitude and Phase Uncertainty

LEAKAGE PATHS

- Transfer Switch (120 db)
- Frequency Conversion Module
- DUT Leakage

DUT LEAKAGE

Should Be Greater Than 80 dB to Assure Accurate Measurements

Signal To Noise

S/N Ratio For Test or Reference Channel

$$SN = \frac{\text{SignalPower(dBm)}}{\text{NoisePower(dBm)}}$$

Some of the possible leakage paths for the 373XXA are the transfer switch, the frequency conversion module, and the DUT. The system limits these leakages to greater than 100 dB. The 12-term error correction can reduce this leakage to better than 110 dB at 18 GHz and 90 dB at 40 GHz.

NOTE

Recommend using an isolation cell to decrease leakage signals for sensitive measurements. For best results, increase the default averaging value and decrease the default IF bandwidth setting during calibration and measurement. Using higher enhancement during the measurement than the calibration will not result in any accuracy improvements.

The DUT connectors should have internally captivated center pins. Those connectors which use external pins to captivate the center conductor should have silver loaded epoxy on the pins to reduce radiation to better than 80 dB.

Signal-to-Noise-Power Ratio

The signal-to-noise-power ratio for each of the test or reference channels is as shown. The “signal power” is the power level of the 80 kHz IF signal at the internal synchronous detectors, and the “noise power” is the total power contained within the bandwidth of the bandpass filter at 80 kHz.

The uncertainty, or error, in a measurement is a function of the amplitude of leakage signals and of the noise level. The uncertainty in the measurement of magnitude and phase of the S-parameters are calculable and shown below in Figures 8-9- and 8-10.

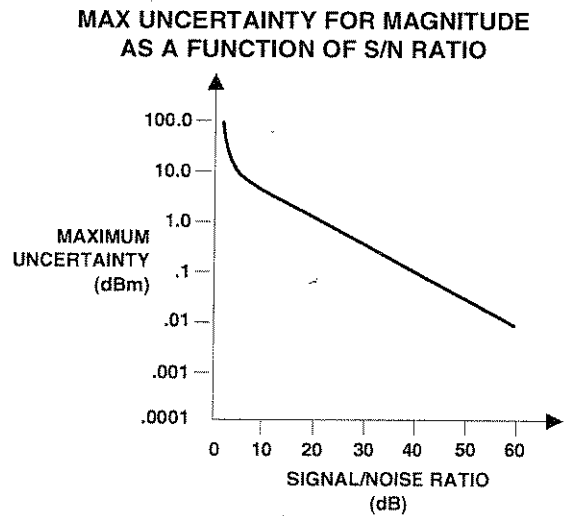

Figure 8-9. The Effect of S/N Ratio On Magnitude Measurements (Noise Only)

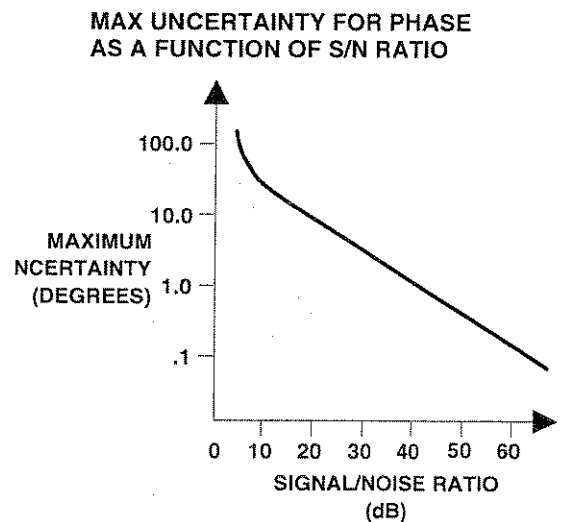

Figure 8-10. The Effect of S/N Ratio On Phase Measurements (Noise Only)

The most difficult types of measurements are those that exercise the full dynamic range of the 373XXA, such as filters (Figure 8-11). Filter measurements are examples of where one must observe both low-insertion loss (in the passband) and high attenuation (in the stop band).

TECHNIQUES TO MAXIMIZE THE S/N RATIO

- Maximize RF Signal Level
- Signal Enhancement

MAXIMIZE RF SIGNAL LEVEL

- Maximum Dynamic Range
- Optimum Linearity

ENHANCEMENTS

- IF Bandwidth Reduction
- Averaging

IF BANDWIDTH REDUCTION

- Four Bandwidths Available
- Noise is Decreased
- Faster Than Averaging

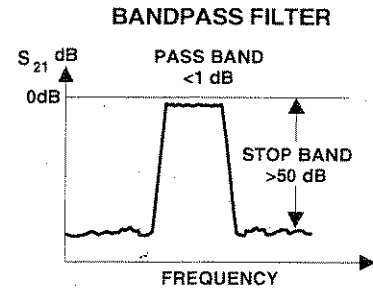

Figure 8-11. Filter Measurements

There are two techniques that you can use to optimize the signal-to-noise ratio. They are (1) maximizing the RF signal level and (2) using signal enhancement.

To maximize the RF signal level, use the default settings of the 373XXA.

The 373XXA provides two enhancements for improving the signal-to-noise ratio: IF bandwidth reduction and averaging.

Reducing the IF bandwidth is a primary method for enhancing accuracy. The 373XXA has a choice of four bandwidths available from the front panel: Maximum (10 kHz), Normal (1 kHz), Reduced (100 Hz), and Minimum (10 Hz). The noise level should decrease by a factor equal to the square root of the IF bandwidth. Using IF Bandwidth reduction makes for faster measurements than with the use of an equivalent amount of averaging.

AVERAGING

Up to 4096 Averages

Reduces Noise

Increases Sweep Time

Averaging is another way to improve accuracy. The improvement is proportional to the square root of the number of averages. The improvement from averaging, however, comes at the expense of increased sweep time.

Figure 8-12 shows the measured reduction in noise due to bandwidth and averaging.

**MEASUREMENTS ON A 70 dB ATTENUATOR
ALL DATA NORMALIZED TO
A 1 KHz IF BANDWIDTH AND 1 AVERAGE**

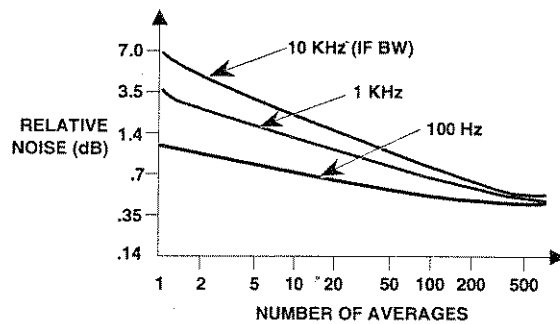

Figure 8-12. Reduction in Noise Using Averaging

Example: Using 1 kHz BW reduction and 10 averages, you would increase the signal-to-noise ratio by 7.6 dB but would lengthen the time required for the measurement by a factor of 4.3. This example assumes a constant signal power.

***Test Device
(DUT) Con-
siderations***

In order to test a device, the required input RF level and the expected device output RF level must be determined.

PORT 1 RF OUTPUT LEVEL

Set for required device input power

Can Add Up to 70db Attenuation in 10 dB Steps

Amplification may be added using front panel loop

The RF level at Port 1 must be set for the device input RF power level required. Attenuation can be added in steps of 10 dB up to 70 dB using the built-in source attenuator. Amplification can be added by removing the front panel loop and adding an external amplifier.

Before calibration, ensure that the test setup is correct by setting the power level and adding attenuation as needed.

PORT 2 RF INPUT LEVEL

-10 dBm Maximum

Can Add Up to 40 dB Attenuation in 10 dB Steps

CALIBRATION

Set Desired RF Signal Level
Include Attenuation As Needed

CALIBRATION

Video IF Bandwidth Reduced
Setting
Number of Averages Varies
With Calibration Device Meas-
ured

CALIBRATION

Can Select the Desired IF
Bandwidth and Averaging

TO MEASURE HIGH ATTENUATION

10 dBm Source Power
100 Averages in Calibration
100 Averages in Measurement

MEASUREMENT PROCEDURE

Determine DUT I/O RF Levels
Set Source RF Level
Set Port 1 Source Attenuator
and Port 2 Test Attenuator

The 373XXA uses enhancements in the calibration to ensure a wide dynamic range. It automatically selects 1 kHz IF bandwidth and varies the number of averages with the calibration device. Terminations require the most averages.

If desired, the Video IF bandwidth and number of averages can be specified for the calibration measurements. Using 100 averages (Avg = 100) appears to be sufficient for most measurements.

To obtain the maximum performance from the 373XXA for measurements of attenuation, you can use the capability of the N discrete frequency calibration to spot check measurements in the frequency band of interest.

The measurement procedure is straight forward, as shown at left.

EXAMPLE - FILTER

No Attenuator Needed

IF Bandwidth 1 kHz and
100 Averages

EXAMPLE - FET

Set Port 1 Source Attenuator to
30 dB (for 37247A and below)

No Port 2 Attenuator Is Needed

Calibrate

Use IF Bandwidth and Averag-
ing As Desired

EXAMPLE - AMPLIFIER

No Port 1 Attenuator

Port 2 Test Attenuator to 10dB

Wide Dynamic Range Device - Filter

Since you do both low-insertion-loss and high- attenuation measurements simultaneously, use the maximum RF signal level and no attenuation. Selecting the 1 kHz Video IF BW setting and 100 averages will likely suffice for this kind of measurement.

High Gain Device - FET

This device has a typical 15 dB gain and requires an input level of about -30 dBm. Set the Port 1 Source Attenuator to 30 dB. Since the device RF output level is -15 dBm ($-30 \text{ dBm} + 15 \text{ dB}[\text{gain}] = -15 \text{ dBm}$) no attenuation is needed at Port 2.

Medium Power Device - Amplifier

Measure the small signal parameters of a 10 dB gain device that requires an input power level of 0 dBm. Here, Port 1 will have no attenuation. The device RF output level is 10 dBm. This level equals 10 dBm ($0 \text{ dBm} + 10 \text{ dB}[\text{gain}] = 10 \text{ dBm}$) into Port 2 and will cause compression in the measurement. At least 10 dB of test attenuation will be needed at Port 2, which will reduce the Port 2 RF level to 0 dB.

8-4 GROUP DELAY

Group delay is the measure of transit time through a device at a particular frequency. Ideally, we want to measure a constant—or relatively constant—transit time over frequency. The top waveform shown in Figure 8-13 is measured at one frequency. The bottom waveform is identical to the first, simply delayed in time.

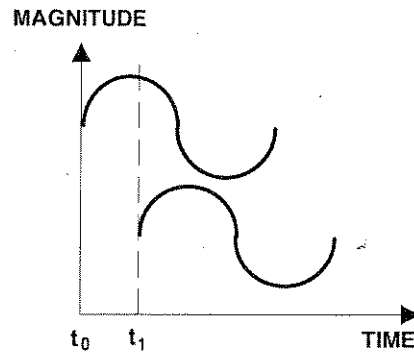

Figure 8-13. Two Waveforms Delayed in Time

Referring to Figure 8-14, the first waveform shown is the original waveform. It is made up of many frequency components. After traveling through a device the signal is delayed in time. Some frequencies are delayed more than others and thus our waveform does not have exactly the same shape as before.

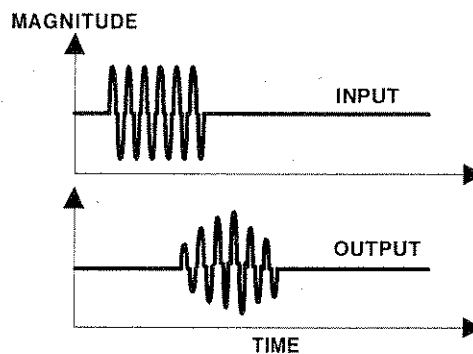

Figure 8-14. Waveform with Frequency Differences

NONLINEAR DELAY = DISTORTION

When delay is nonlinear, as shown above, distortion occurs. By measuring group delay with a network analyzer you can characterize the distortion that occurs from a signal traveling through your test device.

GROUP DELAY
Measure During Design
Avoid Distortion Later
GROUP DELAY
Measure During Test
Optimize Performance
HOW IS GROUP DELAY MEASURED
Mathematical Representation of the Phase Slope

When designing components it is important to measure group delay so that you can compensate for any distortion caused by the component. You may be able to tune the device so as to optimize the performance of group delay over the frequency range of interest. Outside of the specified frequency range, the group delay may or may not be linear.

So how is group delay measured? Signals travel too fast to enable measuring the input and output times of each frequency component. Consequently, we must use mathematical calculations to derive the group delay from the phase slope.

Group delay is mathematically represented by the following equations:

$$\tau = -\frac{d\theta}{d\omega} = \frac{-1}{2\pi} \frac{d\theta}{df} = \frac{-1}{360} \frac{d\theta}{df} = \frac{1}{2\pi} \frac{\Delta\theta}{\Delta f}$$

What this equation shows is that group delay is a measure of the change in phase with relation to the change in frequency.

The change in frequency is referred to as an aperture.

$$\Delta f = \text{Aperture}$$

To measure group delay the frequency aperture must be selected. Depending on the size of aperture, different levels of precision can result for the measurement of group delay.

$$\text{Aperture} = \frac{\text{Frequency Range}}{\# \text{ Of Data Points}}$$

A wide aperture results in a loss of fine-grain variations but gives more sensitivity in the measurement of time delay. A small aperture gives better frequency resolution, but at the cost of lost sensitivity. Thus, for any comparison of group delay data you must know the aperture used to make the measurement (Figure 8-15). Let us take a look

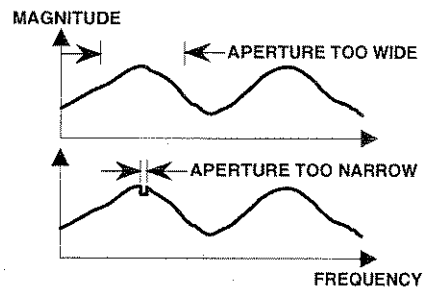

Figure 8-15. Waveforms With Aperture Differences

at a group delay measurement made on the ANRITSU 373XXA Vector Network Analyzer. Group delay, as a measurement option, can be found in the Graph Type menu. After selecting the option, the 373XXA displays the data in a time-vs-frequency graph, or to be more exact, a group-delay-vs-frequency graph (Figure 8-16).

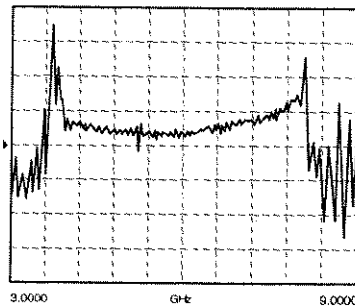

Figure 8-16. Group Delay-vs-Frequency Graph

The 373XXA automatically selects the frequency spacing between data points—that is, the aperture. Notice that this value is displayed on the screen with the measurement (Figure 8-17).

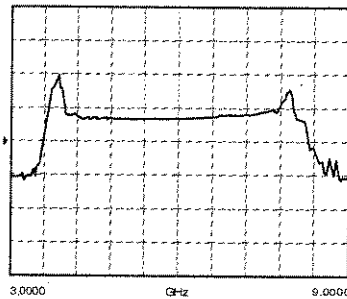

Figure 8-17. Group Delay Screen Showing Aperture

The aperture defaults to the smallest setting for the frequency range and number of data points selected. This value is displayed in the Set Scale key menu when measuring group delay (Figure 8-18).

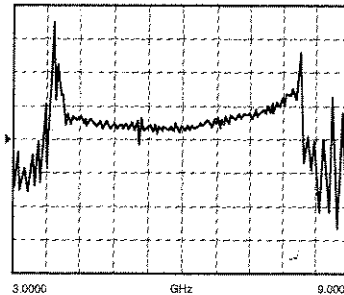

Figure 8-18. 373XXA Aperture

GROUP DELAY APPLICATIONS

Communications

Group delay applications are found throughout the microwave industry, although the majority of such measurements are made in the telecommunications area.

One occurrence of group delay that you may have experienced is with a long-distance telephone call. Occasionally a phone call can be disturbing because of the delay in time from when you speak and when the other person responds. If there is simply a delay, then time delay—or linear group delay—has occurred. But if the voices are also distorted, then non-linear group delay has occurred. It is this distortion that we must avoid. We can avoid linear group delay by measuring group delay both during the design and development stages and during recalibration in the field.

One final group-delay application is found in the development of components. In this application, group delay is measured for the transit time of a signal through the device. When time is of the essence in a fast switching system, as in a modern computer, the travel time through a device is critical.

8-5 ACTIVE DEVICE

Active devices are key components in microwave systems.

The measurements that are made on active devices are similar to those made on passive devices.

Active devices come in many shapes and sizes. In most cases we are going to have to develop a fixture in which to mount the device.

Active devices require bias voltages, and in many cases they are easily damaged. High gain amplifiers may saturate with input signals of -50 dBm! With active devices, we have a new set of measurement requirements.

The 373XXA has been designed to help you make these types of measurements. It includes one 70 dB step attenuator used to adjust the Port 1 power level. A second 40 dB step attenuator is also included (with Option 6) in the forward transmission path to allow measurement of high gain devices without sacrificing reverse transmission and reflection measurements (S_{12} , S_{22}). Bias tees on each port are used to bias the device via the test port center conductor. This approach to bias is useful for testing transistors; however, MMIC's usually require bias injection at other points (Figure 8-19).

ACTIVE DEVICES

- FETs
- Amplifiers
- MMIC's

COMMON MEASUREMENTS

- S11 Input Match
- S21 Gain
- S12 Reverse Isolation
- S22 Output Match

WHAT'S DIFFERENT?

- Connectors
 - There May Not Be Any
 - Instead You Will See:
Tabs-Leads-Pads

WHAT'S DIFFERENT?

- Voltage-Bias Requirements
- Signal Level Performance
 - Power Output
 - Max Input Level
- Non Linear
 - Gain Compression

**ATTENUATORS
Bias Tees**

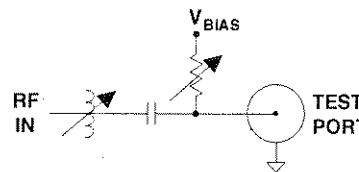

Figure 8-19. Bias Tee

Test fixtures are necessary for mounting the device so that it can be measured in our coaxial (or waveguide) measuring system (Figure 8-20).

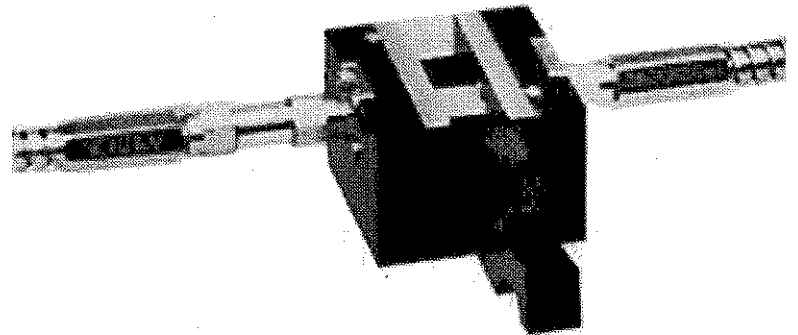

Figure 8-20. Active Device Test Fixture

Now we have an interesting situation. While we can measure the performance at the connector— which is the calibration plane— what we really want to know is how our device performs (Figure 8-21).

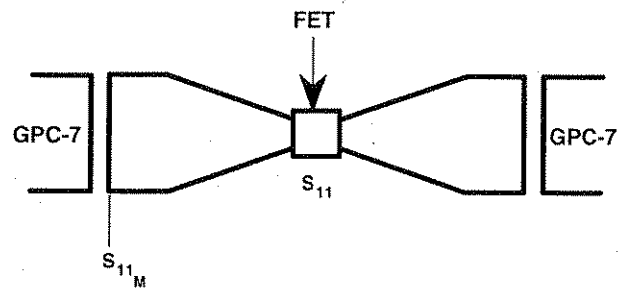

Figure 8-21. Test Device, What It Looks Like

DE-EMBEDDING

Remove or "De-embed" The Effects of the Fixture

You can consider the device embedded in the fixture and can measure the S-Parameters of the fixture with the device installed.

The most elementary situation is a system in which the test fixture is electrically ideal or transparent. In this case the solution is simple—merely move the reference plane out to the device (Figure 8-22).

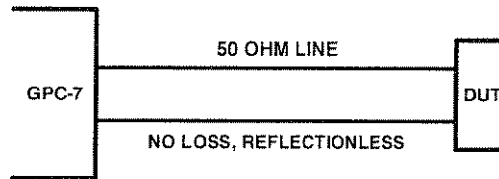

Figure 8-22. Simple Example of De-Embedding

In some cases—depending on the fixture or the device being measured—this is satisfactory. But when it is not, we need to employ other techniques.

One of the reasons that moving the reference plane out to the device does not always work, is that the test fixture includes a transition from coax to a structure such as microstrip, co-planer waveguide, or stripline (Figure 8-23).

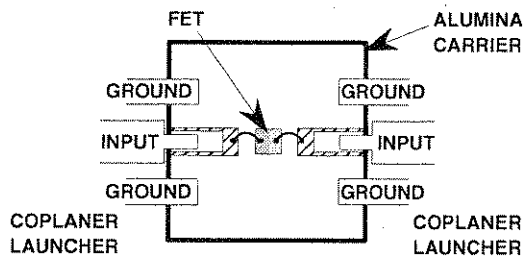

Figure 8-23. Coax-to-Substrate Transition

**WHAT DO WE DO?
TWO APPROACHES ARE COMMON**

Calibrate the Fixture As
"Part of the Analyzer"

Characterize the Fixture and Com-
pute the Desired Result

Engineers have come to grips with the general problem. However, there is no established standard approach. Two of the more common approaches are to calibrate the fixture as a part of the analyzer, and to characterize the fixture and compute the desired result.

**APPROACH NUMBER 1
CALIBRATE THE FIXTURE**

Special Calibration Devices Re-
quired

**SPECIAL CALIBRATION DEVICES
PROBLEMS**

Opens Are Difficult-Radiation Ef-
fects

Good Terminations Are Hard to
Find,
20-30 db Is Often the Best That We
Can Do and This Determines the
"Effective Directivity"

ON-WAFER CALIBRATION

Calibration Standards Are on a
Wafer

In the discussion on calibration we saw that the calibration compo-
nents establish the reference plane and determine the quality of the
measurement. If we have a good Open, Short and Z_0 load to place at
the end of a microstrip line, we can calibrate the system at the point of
measurement.

Figure 8-24 shows some of the special test-fixture calibration stan-
dards that are available.

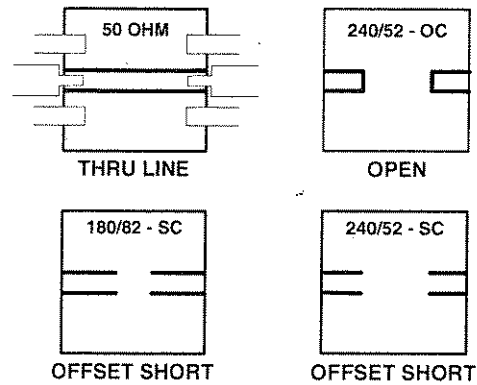

Figure 8-24. *Special Test Fixtures*

These special calibration kits are far from perfect, but they are supe-
rior to our perfect transmission line assumption.

You may also have heard of the probe stations built to permit on-wafer
calibration measurements.

The Open, Short, termination approach provides three known stan-
dards that permit the analyzer to solve for three unknowns (Figure
8-25).

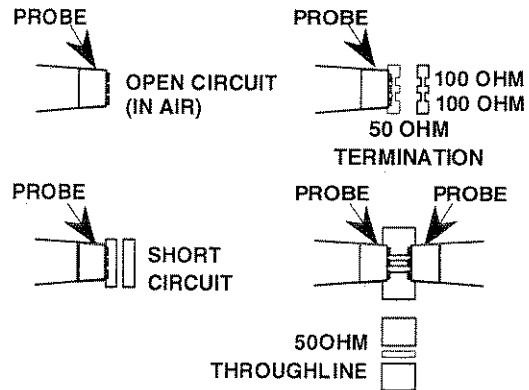

Figure 8-25. *Solving for Unknowns*

CAUTION

CAUTION 

You should turn off or disconnect the bias supplies during the calibration, since you are using a Short as the calibration standard.

It is also possible to use three known impedances. For instance, a varactor with three voltages applied (Figure 8-26).

SPECIAL CALIBRATION KITS

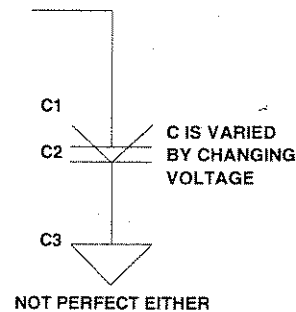

Figure 8-26. *Three Known Impedances*

APPROACH NUMBER 2
CHARACTERIZE THE FIXTURE

Model

Measure

Compute the Desired Result

The second approach is to model the fixture. Modeling is elegant but of limited use due to the non-ideal characteristics of the fixture. Modeling can be accomplished in a CAD system like Touchstone or Compass.

In summary, there are quite a variety of approaches—all with their own characteristic pitfalls. Engineers try to choose the most appropriate technique for their application.

8-6 MULTIPLE SOURCE
CONTROL

The Multiple Source Control mode permits independent control of the 373XXA source, receiver, and an external ANRITSU synthesizer (67XXB, 68XXXB), without the need of an external controller (Figure 8-27).

1. Remove loop between Reference Extension connectors RA In and RA Out.
2. Set up equipment as shown.
3. Normalize the data trace with the standard mixer installed.
4. Subsequent mixers can be tested for magnitude or phase match with respect to the "Standard Mixer."

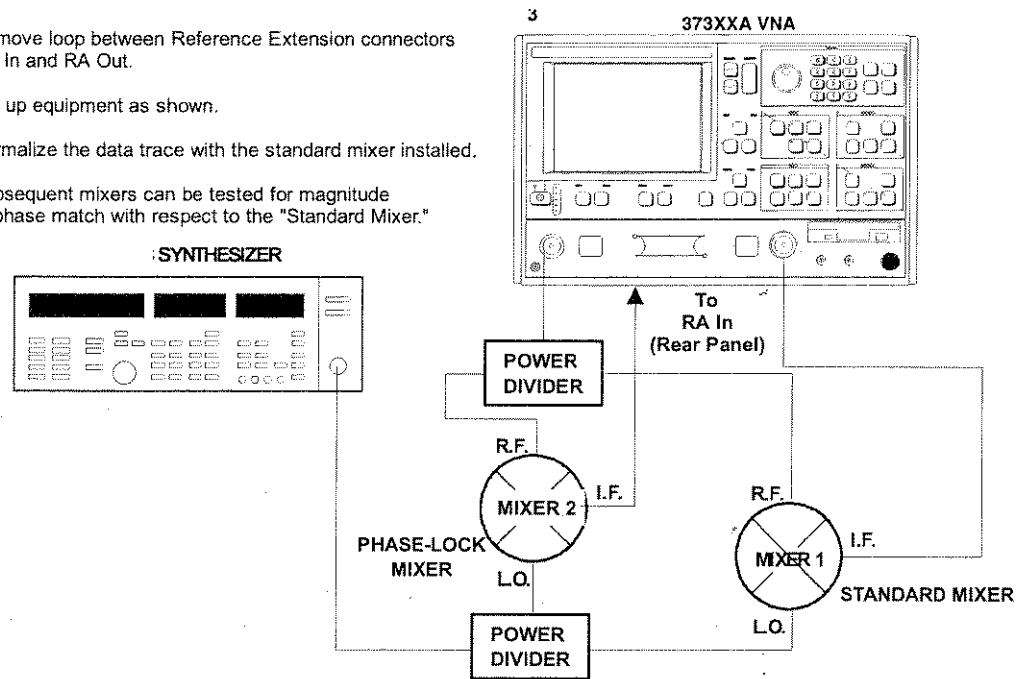

Figure 8-27. Test Setup for Multiple Source Control Operation

Operation in this mode requires Option 11. Removing the reference loop lets you isolate the receiver from the source. This permits testing of frequency converters such as mixers.

The software lets the frequency ranges and output powers of the two sources be specified. A frequency sweep can comprise up to five separate bands, each with independent source and receiver settings for convenient testing of frequency translation devices such as mixers. Up to five sub-bands (harmonics) can be tested in one sweep.

Control Formula

Multiple Source control is specified as a displayed frequency range partitioned into from one-to-five consecutive bands. For each band Source 1, Source 2, and receiver frequencies may be interdependently specified per the formula:

$$\text{Frequency} = \left(\frac{\text{Multiplier}}{\text{Divisor}} \right) \times \left(\frac{F}{\text{Offset Frequency}} \right)$$

Where:

- Multiplier and Divisor are integer constants
- F is the displayed frequency
- Offset Frequency is the offset frequency constant

The following rules apply:

- Multiplier, Divisor and Offset Frequency may be independently specified for each source and receiver.
- F is global, and is the same value in all formulas.
- Each source or receiver may, if desired, be set to a CW frequency, removing F from the equation.

NOTE

When a formula results in an unachievable frequency, such as $1/3 \times 1 \text{ GHz}$, the result is rounded to the nearest achievable frequency, defined by the source frequency resolution. Frequency resolution is 1 kHz, except for 67XXB sources with a high-end frequency above 20 GHz. For these models, the resolution is 2 kHz.

Bands

The displayed frequency range may be divided into up-to-five bands. Band 1 must start at the beginning of the frequency range and end at either the user-specified stop frequency or the end of the frequency range. Band 2 must begin at the next point after band 1 ends, and it must end at either the user-specified stop frequency or the end of the frequency range. Band 5 must end at the end of the frequency range. Independent source and receiver control formulas may be specified for each band.

***Operation
Procedures***

Procedures for performing preoperation and operation are given on pages 8-31 thru 8-34.

MENU U1
SELECT UTILITY FUNCTION OPTIONS
GPIB ADDRESSES
DISPLAY INSTRUMENT STATE PARAMS
GENERAL DISK UTILITIES
CAL COMPONENT UTILITIES
AUTOCAL UTILITIES
COLOR CONFIGURATION
DATA ON(OFF) DRAWING
BLANKING FREQUENCY INFORMATION
SET DATA/TIME
PRESS <ENTER> TO SELECT OR TURN ON/OFF

MENU 7
GPIB ADDRESSES
IEEE 488.2 GPIB INTERFACE
ADDRESS 6
DEDICATED GPIB INTERFACE
EXTERNAL SOURCE 1 4
EXTERNAL SOURCE 2 5
PLOTTER 8
POWER METER 23
FREQUENCY COUNTER 7

Multiple Source Control Preoperational Setup

The two sources receive control information from the 373XXA VNA. The GPIB address assigned to the external source must be identical to the address contained in the data directed to the source by the 373XXA VNA. Assure source/VNA address compatibility as follows:

- Step 1.** Install Sources 1 and 2 on the GPIB (IEEE-488 bus).
- Step 2.** Press the Utility Menu key.

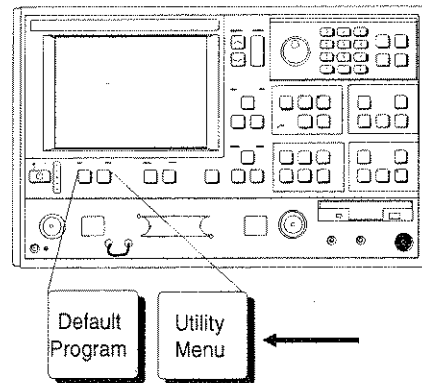

- Step 3.** Move cursor to **GPIB ADDRESSES** and press Enter, when menu U1 (left) appears.
- Step 4.** When menu GP7 (left) appears, observe that the address number is correct. If necessary, use keypad to enter new address.

Multiple Source Control Operation

Step 5. Press the Option Menu key.

MENU OPTNS
OPTIONS
TRIGGERS
REAR PANEL OUTPUT
DIAGNOSTICS
MULTIPLE SOURCE CONTROL
RECEIVER MODE
SOURCE CONFIG
RF ON/OFF DURING RETRACE
PRESS <ENTER> TO SELECT

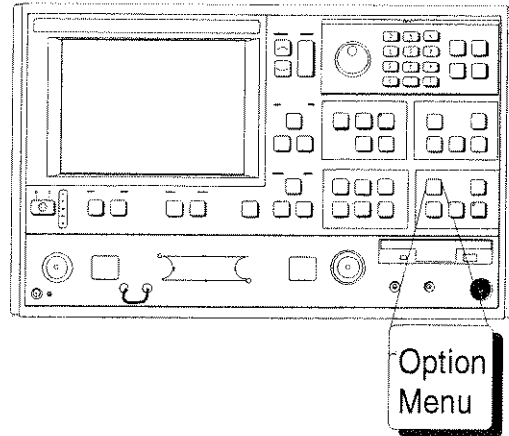

Step 6. When menu OPTIONS (left) appears, move cursor to **MULTIPLE SOURCE CONTROL** and press Enter.

MENU OM1
MULTIPLE SOURCE CONTROL
DEFINE BANDS
SOURCE CONFIG
MULTIPLE SOURCE MODE
OFF
STANDBY
ON
MORE
PRESS <ENTER> TO SELECT

Step 7. When menu OM1(left) appears, move cursor to **DE-FINE BANDS** and press Enter. This brings menu OM 1 to the screen.

```

MENU OM2
-----
DEFINE BANDS
BAND 1
DISPLAYED
FREQ RANGE
BAND START F
XXX.XXXXXX XXX GHz
BAND STOP F
XXX.XXXXXXXXXX GHz
BAND FUNCTIONS
EDIT SYSTEM
EQUATIONS
STORE BAND 1
BANDS STORED:
( 1 2 3 4 5 )
CLEAR ALL
DEFINITIONS
SET MULTIPLE
SOURCE MODE
PRESS <ENTER>
TO SELECT
    
```

Step 8.

Coincident with menu OM2 (left), the data display area of the screen presents a chart entitled "RANGES OF BANDS STORED." This chart shows the band start and band stop frequencies that have been stored for each of five bands.

Using menu OM2, the displayed frequency range can be divided into one to five bands.

Band 1 must start at the beginning of the frequency range and end at either the user-specified stop frequency or the end of the frequency range.

Band 2 must begin at the next point after band 1 ends and end at either the user-specified stop frequency or the end of the frequency range.

Step 9.

Move cursor to **BAND**; select **BAND 1** by entering "1" using the keypad or rotary knob.

Step 10.

Move cursor to **BAND START F**, and use keypad or rotary knob to enter the band 1 start frequency.

Step 11.

Move cursor to **BAND STOP F**, and enter the band 1 stop frequency.

Step 12.

Move cursor to **EDIT SYSTEM EQUATIONS** and press Enter.

Step 13.

When menu OM3 (left) appears, select **SOURCE 1**.

Step 14.

Move cursor to **MULTIPLIER** and use keypad or rotary knob to enter desired multiplier for Source 1. This is the multiplier term in the following equation:

$$\text{Freq} = (\text{Multiplier/Divisor}) \times (\text{F} + \text{Offset Frequency})$$

Step 15.

Move cursor to **DIVISOR** and use keypad or rotary knob to enter desired **DIVISOR** for source 1. This is the divisor term given in the above equation.

Step 16.

Move cursor to either **OFFSET FREQUENCY**, and use keypad or rotary knob to enter desired offset frequency for Source 1; or **C.W.**, and press Enter to toggle C.W. to OFF.

The Offset Frequency choice is the offset frequency given in the above equation. The C.W. choice re-

```

MENU OM3
-----
EDIT SYSTEM
EQUATIONS
EQUATION
TO EDIT
SOURCE 1
SOURCE 2
RECEIVER
EQUATION
SUMMARY
C.W. OFF
MULTIPLIER
XX
DIVISOR
XX
OFFSET FREQ
XXX.XXXXXXXXXX GHz
PREVIOUS MENU
PRESS <ENTER>
TO SELECT
    
```

MENU OM2
DEFINE BANDS
BAND 2
DISPLAYED
FREQ RANGE
BAND START F
XX.XXXXXX GHz
BAND STOP F
XX.XXXXXX GHz
BAND FUNCTIONS
EDIT SYSTEM
EQUATIONS
STORE BAND 1
BANDS STORED:
(NONE)
CLEAR ALL
DEFINITIONS
SET MULTIPLE
SOURCE STATE
PRESS <ENTER>
TO SELECT

Step 17.

moves F from the equation and places Source 1 in the CW mode.

Move the cursor to **PREVIOUS MENU** and press Enter. This returns you to menu OM2 (left).

Step 18.

Move cursor to **STORE BAND 1** and press Enter. This stores the band start frequency, the band stop frequency and the Source 1, Source 2 and Receiver equations.

Step 19.

Note that the **BAND** number has incremented to 2.

Step 20.

Repeat the above steps to define the start and stop frequencies for bands 2 thru 5. Set up the system equations for each band.

NOTE

Except for band 1, the system software constrains all start frequencies to follow the previous band's stop frequency. However, while frequency bands are being defined or the system equations are being edited, the system is automatically placed in the standby mode. In this mode, frequencies that may be entered are not supervised by the system software; any frequency can be entered and displayed. When the mode is switched to **ON** (in menu OM1, left), the system software restricts the frequencies to band limits. When the mode is switched to **OFF**, the frequencies are restricted to system limits.

MENU OM1
MULTIPLE SOURCE CONTROL
DEFINE BANDS
SOURCE CONFIG
MULTIPLE SOURCE MODE
OFF
STANDBY
ON
MORE
PRESS <ENTER>
TO SELECT

Source Lock Polarity: Normal/Reverse

When making frequency translated devices measurements using the Multiple Source Control mode, enter the RF (source 1) and LO (source 2) frequencies. If the LO frequency is lower than the RF frequency, no phase inversion is expected by the VNA. The opposite is true if the LO frequency is higher than the RF frequency. These determinations may be wrong if the DUT is a cascaded multiple conversion device. In that case, determine if the final phase polarity is inverse of what is assumed by the VNA, and set the Source Lock Polarity to Reverse. Failure to do so may cause the RF source to be erroneously locked at a 5 MHz offset.

8-7 ADAPTER REMOVAL

Using adapters in VNA measurement applications can introduce complex errors that add to measurement uncertainty. The VNA Adapter Removal procedure provides for adapter compensation. This on-screen, menu-driven procedure allows the use of a through-line device or adapter with different connector types (non-insertables) on either end to be used for measurement calibration. The electrical effects are subsequently compensated for. The Adapter Removal procedure is described below.

Procedure:

(Note: For purposes of explanation, assume that the adapter to be used is a length of rigid coax with a Type N male connector on one end and an SMA male connector on the other end. Further assume that the Test Port 1 connector is a Type N female and that the Test Port 2 connector is an SMA female (below)).

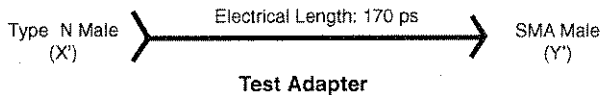
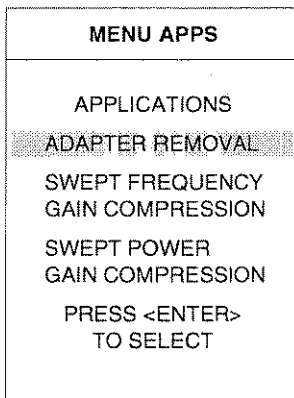

Step 1. Press the Appl key (below) to display the APPLICATIONS menu (top left).

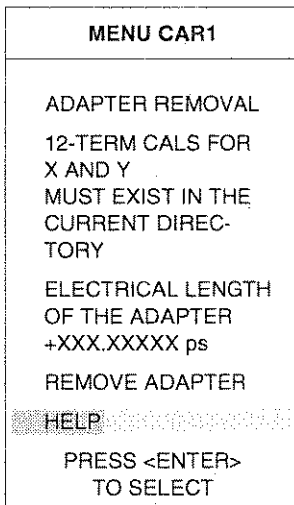
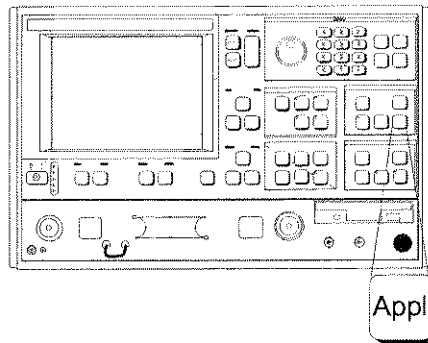

Step 2. Move the cursor to **ADAPTER REMOVAL** and press Enter.

Step 3. Select **HELP** in the next menu (bottom left) to produce the step-by-step procedure shown in Figure 8-27 (next page).

ADAPTER REMOVAL

THE ADAPTER REMOVAL APPLICATION PERMITS THE USER TO ACCURATELY MEASURE NON-INSERTABLE DEVICES. THE PROCESS INVOLVES USING AN ADAPTER OF KNOWN ELECTRICAL LENGTH AND PERFORMING TWO FULL 12-TERM CALIBRATIONS.

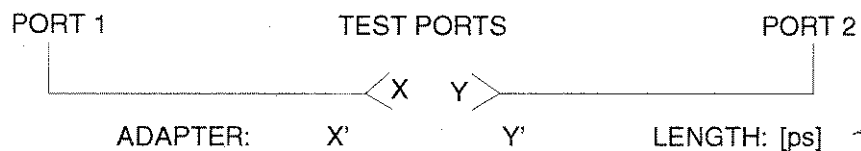

X AND Y ARE COAXIAL OR WAVEGUIDE CONNECTOR TYPES.
L IS THE LENGTH OF THE ADAPTER [ps].

- INSTRUCTIONS -

1. CONNECT ADAPTER TO PORT 1. PERFORM A FULL 12-TERM CALIBRATION USING Y' AND Y AS THE TEST PORTS AND STORE CALIBRATION TO DISK (e.g. YPRIME_Y.CAL).
2. CONNECT ADAPTER TO PORT 2. PERFORM A FULL 12-TERM CALIBRATION USING X AND X' AS THE TEST PORTS AND STORE CALIBRATION TO DISK (e.g. X_XPRIME.CAL).
3. BOTH X AND Y CAL FILES MUST BE PLACED IN THE CURRENT DIRECTORY OF THE HARD OR FLOPPY DISK.
4. ENTER THE ELECTRICAL LENGTH OF THE ADAPTER.
5. SELECT <REMOVE ADAPTER> TO READ THE X AND Y CAL FILES AND CALCULATE THE NEW SET OF 12-TERM ERROR COEFFICIENTS. IF DESIRED, SAVE RESULTS.

Figure 8-27. Adapter Removal Help Screen

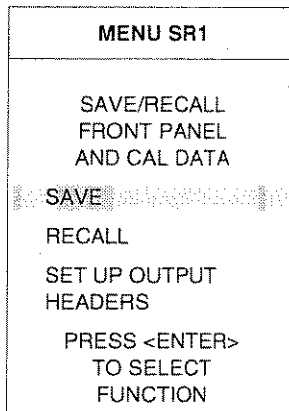

Step 4.

Follow the on-line procedure and connect the Adapter's N male connector (X) to the N female connector on the VNA's Test Port 1.

Step 5.

Press the Begin Cal key (below).

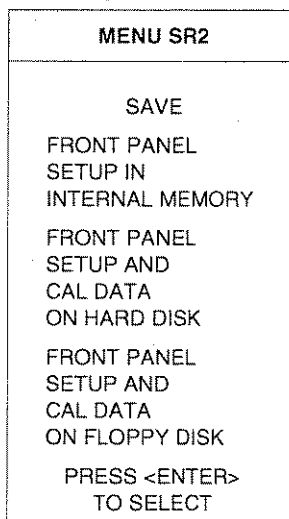
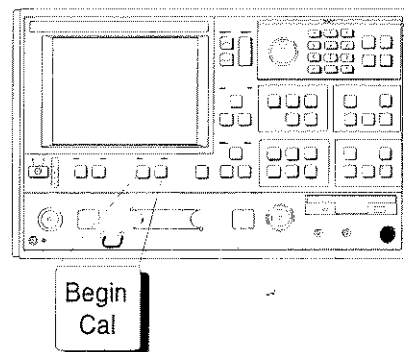

Step 6.

Follow the menu prompts and choose to perform a full 12-term calibration. Use the Adapter's SMA male connector (Y) as Test Port 1 and the VNA's Test Port 2 connector as Test Port Y (Figure 8-27).

Step 7.

Press the Save/Recall Men key (below).

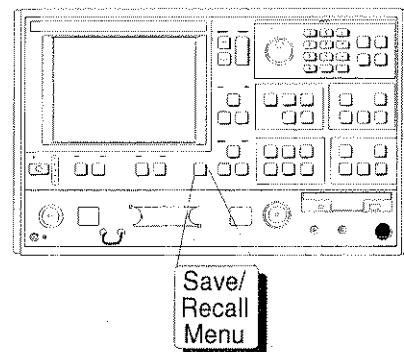

Step 8.

Choose **SAVE** from the displayed menu (top left).

Step 9.

Choose the appropriate hard or floppy disk location, based on individual preference (Menu SR2, bottom left).

Step 10.

When prompted, select **CREATE NEW FILE** and enter a conventional DOS filename, such as YP-RIME_Y.CAL. (Store this file in the current directory.)

```
MENU CAR1

ADAPTER REMOVAL
12-TERM CALS FOR
X AND Y
MUST EXIST IN THE
CURRENT DIREC-
TORY

ELECTRICAL LENGTH
OF THE ADAPTER
+170.0000 ps
REMOVE ADAPTER
HELP
PRESS <ENTER>
TO SELECT
```

```
MENU CAR2

ADAPTER REMOVAL
READ CAL FILE OF
THE X TEST PORT
FROM HARD DISK
(ADAPTER ON
PORT 2)

READ CAL FILE OF
THE X TEST PORT
FROM FLOPPY DISK
(ADAPTER ON
PORT 2)

PRESS <ENTER>
TO SELECT

PRESS <CLEAR>
TO ABORT
```

- Step 11.** Now connect the Adapter's SMA male end to the VNA's Test Port 2 SMA female connector.
- Step 12.** Press the Begin Cal key again.
- Step 13.** Follow the menu prompts; again choose to perform a full 12-term calibration. Now use the Adapter's Type N male connector (X') as Test Port 2. Use the VNA's Test Port 1 connector as Test Port X.
- Step 14.** Save the calibration as described in steps 7 and 8, above. Give this file a unique filename, such as X_XPRIME.CAL. (Store this file in the current directory.)
- Step 15.** Press the Appl key and chose **ADAPTER REMOVAL** to return to Menu CAR1 (top left).
- Step 16.** Enter the electrical length of the Adapter (170 ps for the test adapter) in the appropriate place in Menu CAR1.

NOTE

Electrical length does not have to be precise. Plus or minus 5 ps is adequate for this procedure.

- Step 17.** Move the cursor to REMOVE ADAPTER, and press Enter .
- Step 18.** Move the cursor to the appropriate **READ CAL FILE OF THE X TEST PORT . . .**, depending on where the calibration data is stored (hard or floppy disk). Press Enter.

NOTE

At this juncture, the "X" calibration file is marked for reading, but not actually read. Both the "X" and "Y" files will be read into the VNA together in the next step.

MENU CAR3
ADAPTER REMOVAL
READ CAL FILE OF THE Y TEST PORT FROM HARD DISK (ADAPTER ON PORT 2)
READ CAL FILE OF THE Y TEST PORT FROM FLOPPY DISK (ADAPTER ON PORT 2)
PRESS <ENTER> TO SELECT
PRESS <CLEAR> TO ABORT

Step 19.

Move the cursor to the appropriate **READ CAL FILE OF THE Y TEST PORT...** choice (top left). Press Enter.

Step 20.

Observe that the the text **READING... FROM DISK** appears in the menu area.

Step 21.

When the file has finished reading, the procedure is complete and the program returns to the **SWEEP SETUP** menu (below).

If the adapter is still connected, the display will show the S-parameters of the adapter. Any device to be measured with that same connector configuration will be measured in an absolute sense.

Also, you may wish to store the resulting Adapter Removal calibration for later use.

MENU SU1
SWEEP SETUP
START XX.XXXXXXXXX GHz
STOP XX.XXXXXXXXX GHz
SET CENTER/SPAN XXX DATA POINT(S) XX.XXXXXXXXX GHz STEP SIZE
C.W. MODE ON (OFF) XX.XXXXXXXXX GHz
MARKER SWEEP
DISCRETE FILL
HOLD BUTTON FUNCTION
TEST SIGNALS
PRESS <ENTER> TO SELECT OR TURN/OFF

8-8 GAIN COMPRESSION

There are a number of ways to measure Gain Compression. With a VNA two approaches are possible: Swept Frequency Gain Compression (SFGC) and Swept Power Gain Compression (SPGC). The 373XXA offers a very straightforward approach to each of these measurements.

It is normally desirable to make S-parameter measurements in the linear operating region of an amplifier and then observe Compression or amplitude-modulation/phase-modulation (AM/PM) characteristics by increasing the input power to drive the amplifier into it's nonlinear region. The characteristics of the amplifier-under-test (AUT) dictate the operating power levels required for the tests. Prior to making measurements on a specific amplifier the user must determine the desired operating levels. A recommended level for linear region operation is:

$$P = PG - \text{Gain} - 15\text{dB} \quad (\text{PGC} = \text{Nominal } 1 \text{ dB compression of the AUT})$$

The actual level is constrained by the power available from the VNA and the built in 70 dB step attenuator. (In the case of the 373XXA, available power is easily supplemented by the addition of an external amplifier/attenuator combination.) Power input to Port 2 must also be considered as the test should not drive the VNA into nonlinear operation. Typical specifications show 0.1dB compression at a VNA receiver input level of -10 dBm. The receiver signal is derived through a 13 dB coupler from the Port 2 signal. The 373XXA also includes a 40 dB step attenuator in this path that enables linear operation with input signals as high as 30 dBm (1 watt), the maximum signal level that should be input to Port 2. Higher power levels can be measured by attenuating the signal prior to Port 2.

A typical power configuration example that will also be used throughout this section is included in Figure 8-28. A 10 dB pad has been used at both Port 1 and Port 2 to minimize mismatch errors.

**Power and
VNA'S**

It is necessary to measure absolute power to determine Gain Compression. VNA receiver channels are typically down-converters and do not measure power directly. They are, however, linear so that an accurate power calibration at one level will result in a receiver channel that will accurately indicate power in dBm.

The 373XXA firmware supports calibration with the following power meters: Anritsu ML2430A, HP437B, HP438, and Gigatronics 8541C/8542C. These meters differ in the way they handle sensor efficiency (consult the power meter manual), and the 373XXA does expect to receive corrected data from the power meter. Errors can result if the

Gain Compression Power Configuration

Amplifier Specifications:

Frequency Range:	8 to 12 GHz
Gain	25 dB nominal
1 dB Gain Compression (GC)	12 dBm minimum

Gain Compression Formula: $P = 12 - 25 - 15 = -28 \text{ dBm}$

37369A Setup

Default Power:	-7 dBm
Power Control:	-8 dB
Port 1 Attenuator:	0 dB
External Port 1 Attenuator:	10 dB
The above setting result in Port 1 Power:	-25 dBm
Maximum Amplifier Output	$\cong 15 \text{ dBm}$
Coupler Loss:	$\cong 13 \text{ dB}$
Port 2 Attenuator:	10 dB

Figure 8-28. Gain Compression Measurement Plan (Example)

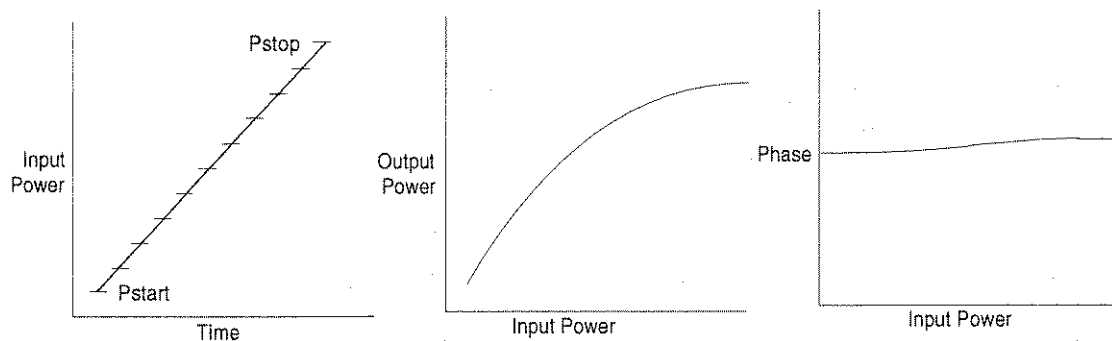

Figure 8-29. Power In (Pi) versus Power Out (Po) Graphical Example

proper correction factor is not applied by the power meter, as shown below.

Correction Factor (%)	Error (dB)
1	0.043
3	0.128
5	0.212
10	0.414

It is desirable to set the power control at or near the minimum (this varies from -20 to -30 dB, depending upon model) when establishing P, as this provides the full ALC range for a power sweep.

The vector error correction available in VNAs is dependent upon ratioed S-parameter measurements. Power is measured using a single, unratioed channel; therefore, when power is being measured error correction is turned off.

***Swept Power
Gain
Compression***

A swept power test is done at a CW frequency. The input power will be increased with a step sweep starting at *Pstart* and ending at *Pstop*. The step increment is also user defined. This lets you observe the conventional *Po* vs. *Pi* presentation or a display of *Phase* vs. *Pi*. Figure 8-29 (previous page) illustrates this process. The SPGC process is implemented in the 373XXA by following the procedure that begins on page 8-44. The test setup required for this procedure is shown in Figure 8-30 (page 8-43).

***Swept
Frequency
Gain
Compression***

This is a manual procedure that provides a normalized amplifier response as a function of frequency at *Pstart* and manually increases the input power while observing the decrease in gain as the amplifier goes into compression. This lets you easily observe the most critical compression frequency of a broadband amplifier. The SFGC process is implemented in the 373XXA by following the procedure that begins on page 8-52. The test setup required for this procedure is shown in Figure 8-30 (page 8-43).

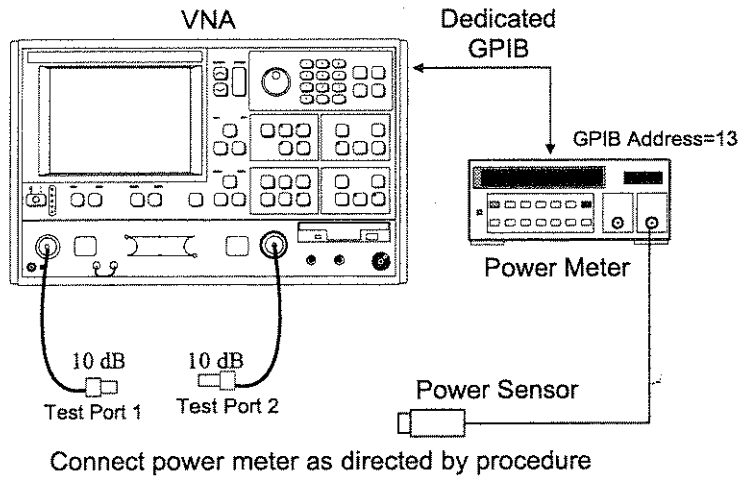

Figure 8-30. Test Setup for Gain Compression Measurements

Swept Power Gain Compression Measurement

The following procedures describes the Swept Power Gain Compression Measurement.

Step 1. Press the Appl key.

MENU APPL
ADAPTER REMOVAL
SWEPT FREQUENCY
GAIN COMPRESSION
SWEPT POWER
GAIN COMPRESSION
PRESS <ENTER> TO SELECT

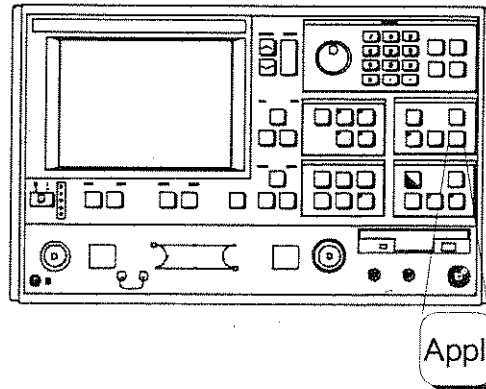

MENU GC2
SWEPT POWER
GAIN COMPRESSION
SET FREQUENCIES
P START
-25.00 dBm
P STOP
-5.00 dBm
STEPSIZE
1.00 dB
ATTENUATION
GAIN COMPRESSION
POINT (MAX REF)
1.00 dB
NOMINAL OFFSET
0.00 dB
MORE
PRESS <ENTER> TO SELECT

NOTE

A 12-Term S-parameter calibration is not necessary for gain compression calibration and measurement. If such a calibration is in place, it will be disabled during the gain compression operation.

Step 2. Move cursor to **SWEPT POWER GAIN COMPRESSION** and press Enter, when menu APPL (top left) appears.

Step 3. When menu GC2 (bottom left) appears, follow the directions that appear adjacent to the menu, as described below:

Move cursor to **SET FREQUENCIES**, press Enter and select from 1 to 10 frequencies.

Enter the frequency value, press a terminator key (e.g. GHz/10³/μs/m), then Enter to add the frequency to the list.

NOTE

The number of frequencies and step size, that is entered later, directly affect the time required for Linear Power Calibration, in a later step.

```

MENU GC_DF2
-----
SWEPT POWER
FREQUENCIES
INPUT A FREQ,
PRESS <ENTER>
TO INSERT
SWEPT POWER
FREQUENCY
12.000000000 GHz
CLEAR FREQ NUMBER
1
CLEAR ALL
FINISHED, RETURN TO
POWER SWEEP SETUP
PRESS <ENTER>
TO SELECT

```

```

MENU GC_DF2
-----
SWEPT POWER
GAIN COMPRESSION
PORT 1 ATTN
0*10 dB (0 - 70)
PORT 2 ATTN
2*10 dB (0 - 40)
PREVIOUS MENU
PRESS <ENTER>
TO SELECT

```

Move cursor to **FINISHED, RETURN TO POWER SWEEP SETUP** and press Enter.

Move cursor to **P START** (previous page), set per power plan (Figure 8-28), and press Enter.

Move cursor to **P STOP** (previous page), set per power plan, and press Enter.

Move cursor to **STEP SIZE** (previous page), enter a value, and press Enter.

The 1 dB default value is reasonable. This value, along with the number of frequencies entered in a previous step, directly affect the time required for Linear Power Calibration, in a later step.

Move cursor to **ATTENUATION** (previous page) and press Enter. Set power values (bottom left) per power plan. Move cursor to **PREVIOUS MENU** and press Enter when finished.

Move cursor to **GAIN COMPRESSION** (previous page), enter the desired value (1 dB is typical), and press Enter.

Move cursor to **NOMINAL OFFSET** (previous page), enter the value of any external device(s) connected between the front panel Input and Output connectors. Press Enter when done. In the example use -10 dB.

A setting of 0.00 dB is normal when no external devices are connected.

Move cursor to **MORE** (previous page) and press Enter to proceed to the next menu (GC3) (next page).

MENU GC3
SWEPT POWER GAIN COMPRESSION
CALIBRATE FOR LINEARITY ([NO] CAL EXIST)
LINEARITY ON [OFF] CORRECTION
CALIBRATE RECEIVER ([NO] CAL EXISTS)
NORMALIZE S21 ([NOT] STORED)
AUT TEST TYPES
GAIN COMPRESSION
AM/PM
MULTIPLE FREQ GAIN COMPRESSION
RETURN TO SWEPT FREQUENCY MODE
PREVIOUS MENU

Step 4.

Move cursor to **CALIBRATE FOR LINEARITY**, press Enter, and follow the instructions that (1) appear adjacent to the follow-on menu and (2) are described below.

If a calibration already exists, the menu choice will indicate CAL EXIST in blue letters.

NOTE

This step is not required for a successful gain compression measurement; however, linearizing the power from Port 1 (which is what this step does) provides increased accuracy.

Prepare the power meter as described in the instructions (below).

- | |
|--|
| <ol style="list-style-type: none"> 1. PRESET, ZERO, AND CALIBRATE THE POWER METER. 2. SET POWER METER OFFSET, IF REQUIRED. 3. CONNECT THE POWER METER TO THE DEDICATED GPIB INTERFACE AND THE POWER SENSOR TO THE TEST PORT. 4. SELECT <START LINEAR POWER CALIBRATION>. |
|--|

MENU GC_SU8A
CALIBRATE FOR LINEAR POWER
FORWARD DIRECTION ONLY
START LINEAR POWER CALIBRATION
PREVIOUS MENU
PRESS <ENTER> TO SELECT

Connect the power sensor to Test Port 1.

With **START LINEAR POWER CALIBRATION** highlighted (bottom left), press Enter to begin the calibration.

Step 5.

Observe **LINEARITY CORRECTION** choice (top left). If a linearity correction has been performed, it will indicate ON in blue letters.

Step 6.

Move cursor to **CALIBRATE RECEIVER** and follow the instructions, as follows:

Connect a through line between Test Port 1 and Test Port 2. Be sure to include all components that are part of the measurement path.

MENU GC3
SWEPT POWER GAIN COMPRESSION
CALIBRATE FOR LINEARITY ([NO] CAL EXIST)
LINEARITY ON [OFF] CORRECTION
CALIBRATE RECEIVER ([NO] CAL EXISTS)
NORMALIZE S21 ([NOT] STORED)
AUT TEST TYPES
GAIN COMPRESSION AM/PM
MULTIPLE FREQ GAIN COMPRESSION
RETURN TO SWEPT FREQUENCY MODE
PREVIOUS MENU

Step 7.

Wait until one complete sweep has completed, then press Enter to store the calibration.

NOTE

It is likely that the trace will be off screen at the bottom of the display. If so, press Autoscale to obtain a discernable trace. If this trace shows vertical instability,

- Press Video IF BW and select **REDUCED (100 Hz)** from the menu.
- Press Avg/Smooth Menu and select **AVERAGING 100 MEAS. PER POINT** from the menu.
- Press Average to turn averaging on.

Press Appl to return to the gain compression menu set, and follow the prompts to return to Menu GC3. Repeat Step 6.

Step 8.

Move the cursor to **NORMALIZE S21** (top left), press Enter, and follow the menu instructions (bottom left):

MENU GC_NORM
NORMALIZE S21
CONNECT AUT AND APPLY BIAS .
WAIT FOR ONE COMPLETE SWEEP BEFORE STORING
PRESS <ENTER> TO STORE
PRESS <CLEAR> TO ABORT

Step 9.

Remove the through line and connect the amplifier-under-test (AUT) between Port 1 and Port 2.

Apply bias to the AUT.

Wait until one complete sweep has completed, then press Enter to store the normalization measurement.

Move the cursor to the desired test and press Enter. The steps that follow presume that gain compression has been selected.

Step 10.

Observe that the SWEPT POWER SETUP menu and the dual-trace display resembles that shown below.

MENU SU3A
SWEPT POWER SETUP
SWEPT POWER FREQUENCY 9.00000000 GHz
P START -25.00 dBm
P STOP -5.00 dBm
STEPSIZE 1.00 dB
POWER SWEEP ON
HOLD BUTTON FUNCTION
MULTIPLE FREQ GAIN COMPRESSION
RETURN TO SWEPT FREQUENCY MODE
PRESS <ENTER> TO SELECT OR TURN ON/OFF

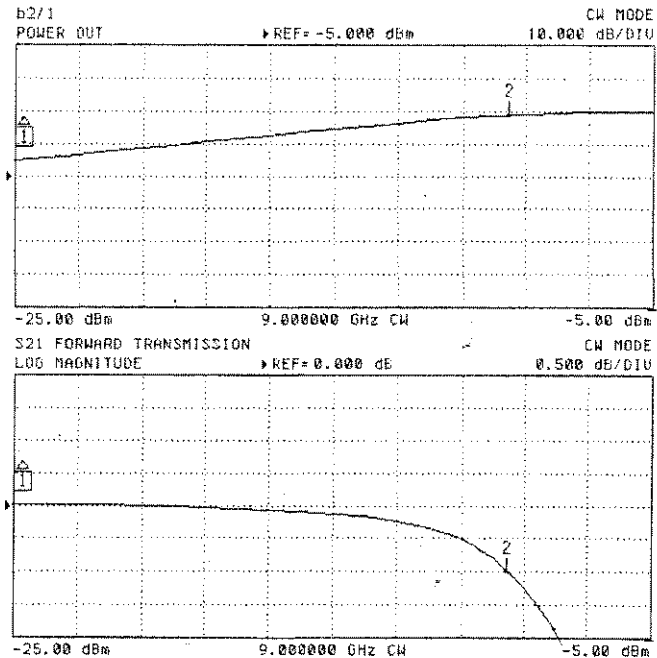

Step 11.

Press Readout Marker (below) for a display of gain compression at the marker frequency.

MENU M7
SEARCH
VALUE -1.000dB
REFERENCE MAXIMUM VALUE ΔREF MARKER 0 dB
VALUE AT REFERENCE -0.000 dB
SEARCH LEFT SEARCH RIGHT -9.56 dBm
SEARCH MRKR VALUES CH1: 13.753dBm CH2: CH3: -1.000 dB CH4:
TRACKING ON
MARKER READOUT FUNCTIONS

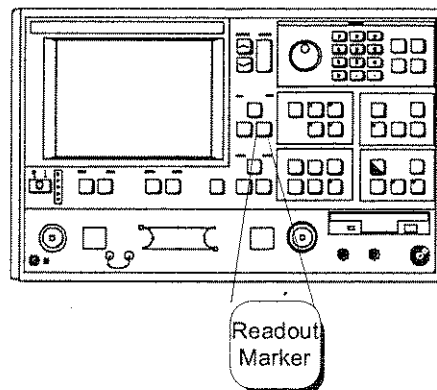

Step 12.

Observe the readout marker values from the displayed menu (left).

MENU SU3A
SWEPT POWER SETUP
SWEPT POWER FREQUENCY 9.000000000 GHz
P START -25.00 dBm
P STOP -5.00 dBm
STEPSIZE 1.00 dB
POWER SWEEP ON
HOLD BUTTON FUNCTION
MULTIPLE FREQ GAIN COMPRESSION
RETURN TO SWEPT FREQUENCY MODE
PRESS <ENTER> TO SELECT OR TURN ON/OFF

Step 13.

Press Setup Menu (below) to return to SWEPT POWER SETUP menu.

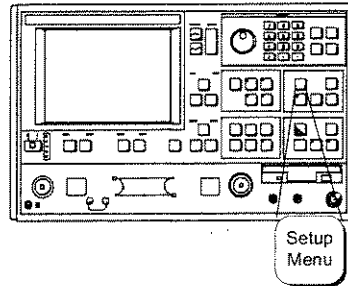

Step 14.

Move cursor to **SWEPT POWER FREQUENCY** (top left), select the next frequency from the SET FREQUENCY list, and press Enter.

Step 15.

Repeat steps 11 through 13.

Step 16.

Repeat steps 14 and 15 until all frequencies have been observed.

Step 17.

To examine the phase performance for a swept input power, **AM/PM** should be selected. This leads to the two channel display (Channels 2 and 4) with Channel 4 active shown below. The sweep mode is continuous to facilitate tuning, Markers are set to the Δ Reference mode on the active channel.

MENU
CH2 - 21
REFERENCE PLANE 0.0000mm
MARKER 1 -25.00 dBm
MARKER TO MAX
MARKER TO MIN
$\Delta(1-2)$ -15.44 dBm 4.17°
MARKER READOUT FUNCTIONS

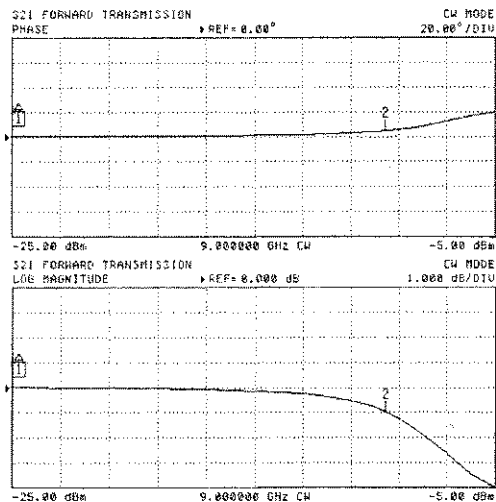

MENU GC4	
MULTIPLE FREQUENCY GAIN COMPRESSION	
TEST AUT	
TEXT DATA TO HARD DISK	
TEXT DATA TO FLOPPY DISK	
SWEPT POWER GAIN COMPRESSION	
RETURN TO SWEPT FREQUENCY MODE	
PRESS <ENTER> TO SELECT	

- Step 18.** Repeat steps 13 through 16 until all desired frequencies have been observed.
- Step 19.** If desired, a multiple frequency gain compression display can be obtained by selecting **MULTIPLE FREQUENCY GAIN COMPRESSION** (left) and pressing Enter.
- Step 20.** Move cursor to **TEST AUT** (top left) and press Enter.
- Step 21.** Observe that the Multiple Frequency Gain Compression display resembles that shown below.
- Step 22.** Make desired selection from menu to copy text and data to hard or floppy disk (top left).
- Step 23.** The power linearity calibration, receiver calibration, and DUT normalized data exists in volatile memory. At this time, the data can be stored for subsequent recall using the SAVE function.

- MULTIPLE FREQUENCY GAIN COMPRESSION POINT -

SWEPT POWER FREQUENCIES	POWER IN	POWER OUT
1. 9.000000 GHz	-9.62 dBm	13.59 dBm
2. 10.000000 GHz	-9.09 dBm	14.41 dBm
3. 11.000000 GHz	-8.71 dBm	14.69 dBm
4. 12.000000 GHz	-7.37 dBm	14.73 dBm
5.		
6.		
7.		
8.		
9.		
10.		

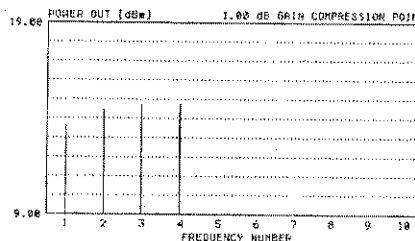

NOTE

It is prudent to save this calibration; otherwise, it will be destroyed if you move anywhere in the program except between this calibration and the S-Parameters menu.

Step 24.

Move cursor to **RETURN TO SWEPT FRE-
QUENCY MODE** and press Enter to exit the gain
compression mode.

**MAJOR
CAUTION**



CAUTION

When exiting the Swept Frequency Power Gain Compression mode, the DUT should be turned off, unless the user has selected the proper attenuator settings for standard swept frequency (S parameter) operation.

Swept Frequency Gain Compression Measurement

The following procedure describes the Swept Frequency Gain Compression Measurement.

Preliminary: Refer to Figure 8-28 and set the Power Control and Port 1 Attenuator for the values shown in the power plan for the example, or in the power plan constructed for measurement of a test device. These power plan values should also be used in the S-parameter calibration that may be performed using the Begin Cal key and menus.

MENU APPL

ADAPTER REMOVAL

**SWEPT FREQUENCY
GAIN COMPRESSION**

SWEPT POWER
GAIN COMPRESSION

PRESS <ENTER>
TO SELECT

Step 1. Press the Appl key.

Step 2. Move cursor to **SWEPT FREQUENCY GAIN COMPRESSION** and press Enter, when menu APPL (top left) appears.

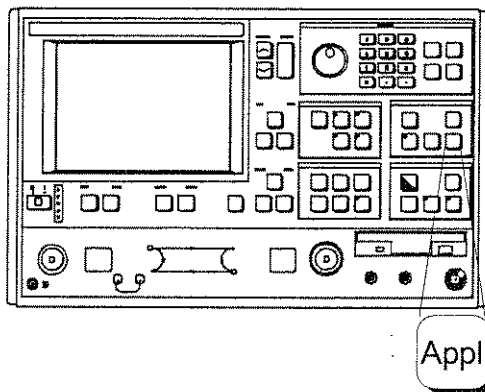

MENU GC3

SWEPT FREQUENCY
GAIN COMPRESSION

NONMINAL OFFSET
0.00 dB

CALIBRATE
FOR FLATNESS
(NO CAL EXISTS)

FLATNESS OFF
CORRECTON

CALIBRATE
RECEIVER
(NO CAL EXISTS)

NORMALIZE S21
(NOT STORED)

GAIN COMPRESSION
POINT (0 dB REF)
1.00 dB

TEST AUT

EXIT APPLICATION

Step 3. When menu GC3 (bottom left) appears, follow the directions that appear adjacent to the menu, as described below:

Move cursor to **NOMINAL OFFSET**, enter the value of any external device(s) connected between the front panel Input and Output connectors. Press Enter when done.

Optionally move cursor to **CALIBRATE FOR FLATNESS**, press Enter and follow the instruction menu and described below.

If a calibration already exists, the menu choice will indicate CAL EXIST in blue letters.

NOTE

This step is not required for a successful gain compression measurement; however, calibrating the power from Port 1 (which is what this step does) provides increased accuracy.

Prepare the power meter as described in the instructions (below)

1. PRESET, ZERO, AND CALIBRATE THE POWER METER.
2. SET POWER METER OFFSET, IF REQUIRED.
3. CONNECT THE POWER METER TO THE DEDICATED GPIB INTERFACE AND THE POWER SENSOR TO THE TEST PORT.
4. SELECT <START LINEAR POWER CALIBRATION>.

Connect the power sensor to Port 1.

Set the number of power calibration points.

If, in a previous menu, data points had been set to 401 points, entering 8 provides 50 power points (every 8th point); entering 4 provides 100 power point (every 4th point)s, and entering 1 provides 401 power points. The VNA interpolates between power calibration frequencies.

Enter a **POWER TARGET** value.

Make this value the same as resulting Port 1 power value shown in Figure 8-28: -25 dBm for the example.

With **START FLAT POWER CALIBRATION** highlighted (bottom left), press Enter to begin the calibration.

NOTE

When the above calibration finishes, the source power will have been accurately calibrated. In the next step, this power calibra-

MENU GC_SUBA

CALIBRATE FOR
FLAT PORT POWER

FORWARD
DIRECTION ONLY

101 POINTS
MEASURE 1 PWR
POINT EVERY
1 POINT(S)

POWER TARGET
-25.00 dBm

**START FLAT
POWER CALIBRATION**

PREVIOUS MENU

PRESS <ENTER>
TO SELECT

TURN KNOW TO
CHANGE NUMBER
OF POINTS

MENU GC1
SWEPT FREQUENCY GAIN COMPRESSION
NONMINAL OFFSET -10.00 dB
CALIBRATE FOR FLATNESS (ICAL EXISTS)
FLATNESS CORRECTON AT -25.00 dBm
CALIBRATE RECEIVER (CAL EXISTS)
NORMALIZE S21 ([NOT]STORED)
GAIN COMPRESSION POINT (0 dB REF) 1.00 dB
TEST AUT
EXIT APPLICATION

Step 4.

tion will be transferred via the through line to the receiver.

Move cursor to **CALIBRATE RECEIVER** and follow the instructions, as follows:

Connect a through line between Test Port 1 and Test Port 2. Be sure to include all components that are part of the measurement path.

Wait until one complete sweep has completed, then press Enter to store the calibration.

NOTE

It is likely that the trace will be off screen at the bottom of the display. If so, press Autoscale to obtain a discernable trace. If this trace shows vertical instability,

- Press Video IF BW and select **REDUCED (100 Hz)** from the menu.
- Press Avg/Smooth-Menu and select **AVERAGING 100 MEAS. PER POINT** from the menu.
- Press Average to turn averaging on.

MENU GC_SUBA
RECEIVER CALIBRATION
CONNECT TRHOUGHLINE BETWEEN TEST PORTS
INCLUDE ANY COMPONENTS WHICH ARE PART OF THE MEASUREMENT PATH
WAIT FOR ONE COMPLETE SWEEP BEFORE STORING
PRESS <ENTER> TO STORE
PRESS <CLEAR> TO ABORT

Step 5.

Press Appl to return to the gain compression menu, and follow the prompts to return to Menu GC1. Repeat Step 4.

Step 6.

Move the cursor to **NORMALIZE S21** (top left), press Enter, and follow the menu instructions (bottom left):

Remove the through line and connect the amplifier-under-test (AUT) between Port 1 and Port 2.

Apply bias to the AUT.

Wait until one complete sweep has completed, then press Enter to store the normalization measurement.

Step 7.

Move the cursor to **TEST AUT** (top left) and press Enter.

Step 8.

Observe that the dual-trace display resembles that shown below.

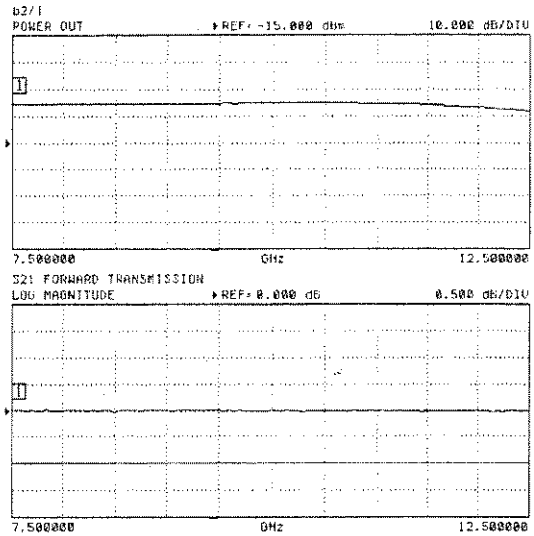

Step 9.

Note that the top display (Channel 1), shows the power out from the AUT. For the example test device, the nominal output power is about 0 dBm with the input at -25 dBm. To better evaluate this device, turn on markers and set the Channel 1 reference to 0 dB, as shown below.

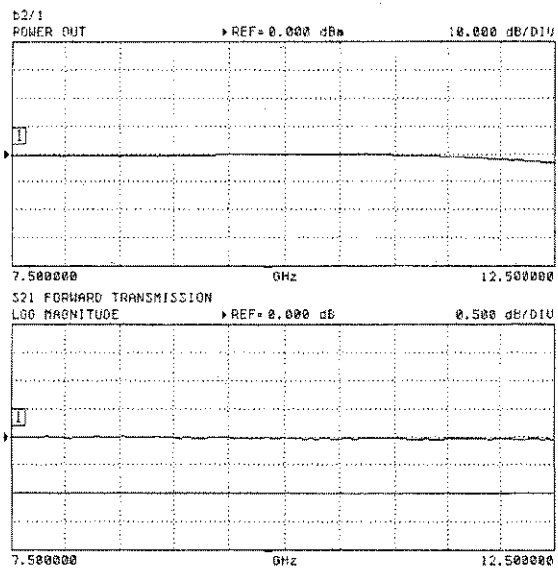

Step 10.

Press the Ch1 key (top left) to make channel 1 active.

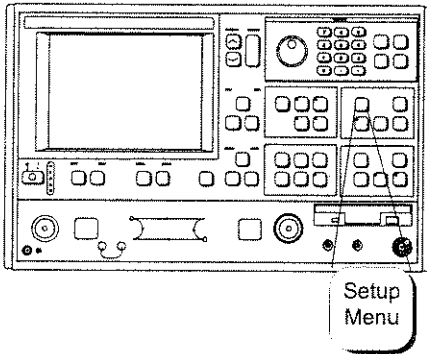

Step 11.

Press the Marker Menu key (middle left), turn on marker 1, and position it to a desired point on the trace (below). (Press the Readout Marker key for frequency and amplitude information.)

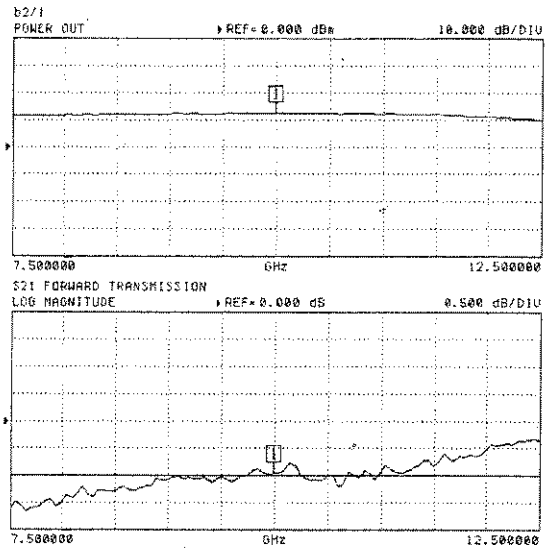
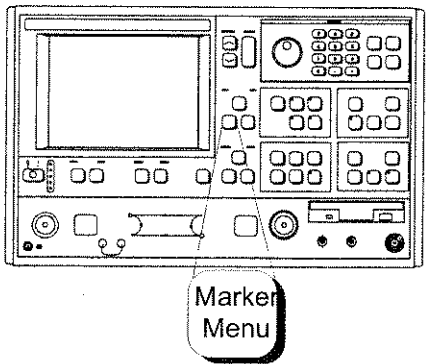

Step 12.

Press the Appl key to return to the TEST SIGNALS menu (Menu SU2, next page).

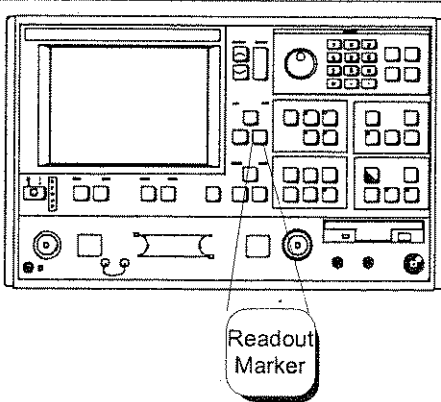

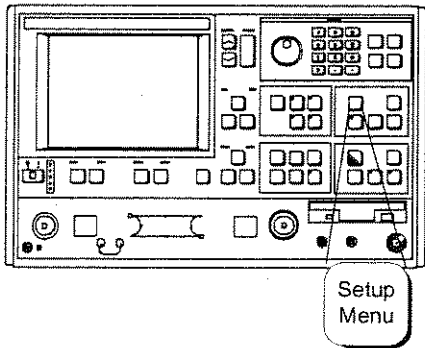

Step 13.

Press the Setup Menu key (top left), select **POWER CONTROL** (bottom left) and increase the value while observing compression in channel 3 (S₂₁).

NOTE

The rotary knob or the keypad can be used to set the POWER CONTROL value. In using the rotary knob, the displayed value does not change in real time with movement of the control. Change occurs after the rotation of the knob is complete.

Step 14.

Press the Marker Menu key again, and observe the displayed Ch 3 trace and the marker values from the displayed menu (below).

MENU SU2
TEST SIGNALS
POWER CONTROL
5.47 dB
0 TO -20.00 dB
PORT 1 ATTN
0 * 10 dB (0 - 70)
PORT 1 POWER
-1.53 dBm
PORT 2 ATTN
0 * 10 dB (0 - 40)
CALIBRATE
FOR FLATNESS
(CAL EXISTS)
FLATNESS
CORRECTION
AT -11.53 dBm
PORT 2 POWER
0.00 dBm
EXIT APPLICATION
PRESS <ENTER>
TO SELECT
OR TURN ON/OFF

MENU SU2
MARKER 1
ALL DISPLAYED
CHANNELS
CH 1 - S11 USER
10.000000 GHz
12.06 dBm
CH 2 - S12
CH 3 - S21
10.000000 GHz
-0.992 dB
CH 4 - S21
MARKER TO MAX
MARKER TO MIN
MARKER READOUT
FUNCTIONS
PRESS <ENTER>
TO SELECT

Step 15.

The power linearity calibration, receiver calibration, and DUT normalized data exists in volatile memory. At this time, the data can be stored for subsequent recall using the SAVE function.

NOTE

It is prudent to save this calibration; otherwise, it will be destroyed if you move anywhere in the program except between this calibration and the S-Parameters menu.

MENU SU2
TEST SIGNALS
POWER CONTROL 5.47 dB 0 TO -20.00 dB
PORT 1 ATTN 0 * 10 dB (0 - 70)
PORT 1 POWER -1.53 dBm
PORT 2 ATTN 0 * 10 dB (0 - 40)
CALIBRATE FOR FLATNESS (CAL EXISTS)
FLATNESS CORRECTION AT -11.53 dBm
PORT 2 POWER 0.00 dBm
EXIT APPLICATION
PRESS <ENTER> TO SELECT OR TURN ON/OFF

Step 16.

Move cursor to **RETURN TO SWEPT FREQUENCY MODE** and press Enter to exit the gain compression mode.

Step 17.

Press the Appl key to return to the TEST SIGNALS menu (left), highlight **EXIT APPLICATION** and press Enter to exit the gain compression measurement area.

CAUTION

When exiting the Swept Frequency Power Gain Compression mode, the DUT should be turned off, unless the user has selected the proper attenuator settings for standard swept frequency (S parameter) operation.



**MAJOR
CAUTION**

8-9 RECEIVER MODE

The Receiver Mode provides three distinct modes of operation:

- Sweep/Source Lock mode, phase locks the internal source.
- Synthesizer/Tracking mode, lets the receiver track a 67XXB, 68XXB, or 69XXXA synthesizer.
- Set-On mode, lets the VNA operate as a tuned receiver.

Source Lock Mode The Source Lock mode enables the 373XXA to phase lock to its internal source.

Tracking Mode In the Tracking Mode, the 373XXA steers its second local oscillator frequency and phase signal so as to phase-lock itself to the reference signal. Typically the source is a synthesizer, since it must be accurate to better than ± 10 MHz for the 373XXA to achieve lock. Due to the inherent resolution of the 373XXA, frequency resolution is limited to 1 kHz intervals. If Option 3 is installed frequency resolution is limited to 1 Hz.

For receive frequencies outside the indicated test set range, the use of external mixers and a synthesizer is required. Dual Source Control is required in this case.

Set-on Mode In the Set-On mode, the source lock circuitry of the 373XXA is completely by-passed. Reference signals are no longer necessary for system operation. This allows all of the 373XXA samplers to operate over their full dynamic range. As a result, the source and the 373XXA must be locked to the same 10 MHz time base, otherwise coherent detection is not possible. Only synthesized sources may be used in this mode. Dual source control is required.

Due to the inherent resolution of the 373XXA local oscillators, frequency resolution is limited to 1 kHz intervals over the frequency range of the VNA. If Option 3 is installed, frequency resolution is limited to 1 Hz.

**Receiver
Mode Block
Diagram**

The block diagram shown in Figure 8-31 shows how the system is configured for all of the possible modes of operation. With the switches set as shown, the system operates in the Set-On mode. LO1 and LO2 are pre-set to allow only a prescribed signal to be detected by the synchronous detector. With the switch in SOURCE LOCK position the system is operating in the internal source-lock mode. With the switch in the TRACKING position, the system is in the synthesizer tracking mode.

**Receiver
Mode Menus**

The menus associated with the Receiver Mode are described in the alphabetical listing (Appendix A) under their call sign: RCV1, RCV2, RCV3, etc.

**Procedure,
Receiver
Mode
Operation**

A detailed procedure for operation using the Receiver Mode option is provided in the following pages.

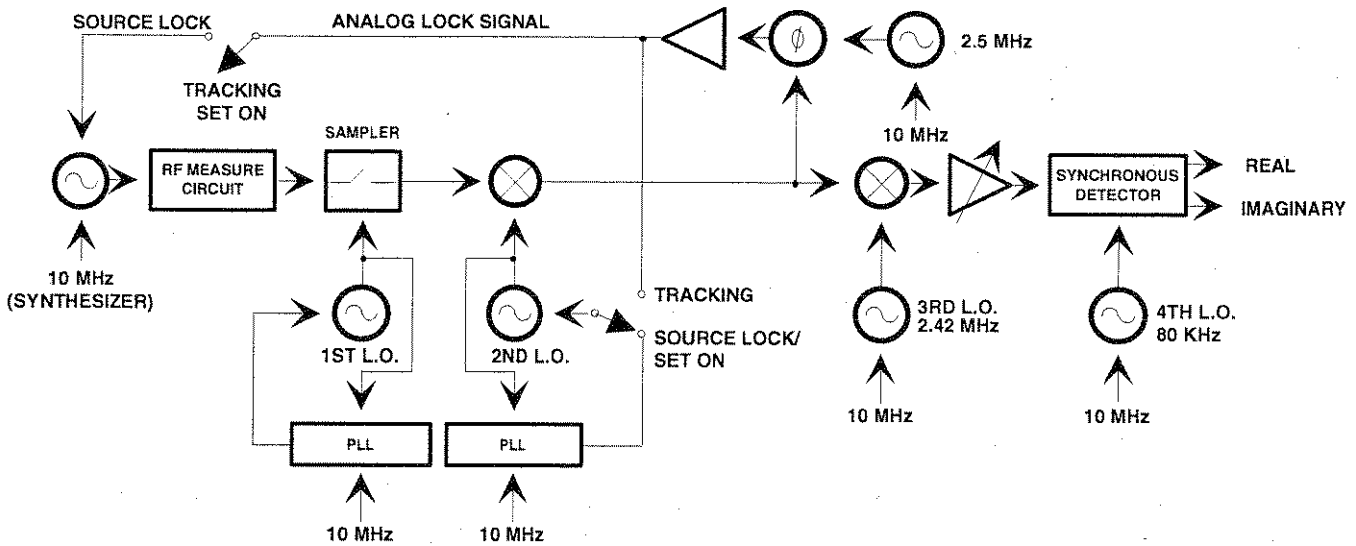

Figure 8-31. 373XXA Phase Lock Modes

MENU OPTNS
OPTIONS
TRIGGERS
REAR PANEL OUTPUT
DIAGNOSTICS
MULTIPLE SOURCE CONTROL
RECEIVER MODE
SOURCE CONFIG
RF ON/OFF DURING RETRACE
PRESS <ENTER> TO SELECT

Operating Procedure, Receiver Mode

The three operational modes that comprise the Receiver Mode can be set up as follows:

Step 1. Press the Option Menu key (below).

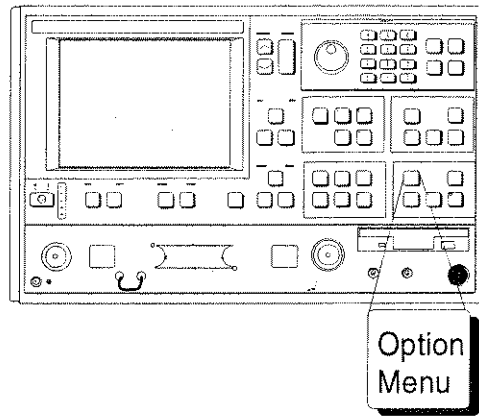

MENU RCV1
RECEIVER MODE
STANDARD
USER DEFINED
SOURCE CONFIG
SPUR REDUCTION NORMAL/OFF
PRESS <ENTER> TO SELECT

Step 2. When menu OPTNS (top left) appears, select **RECEIVER MODE**.

Step 3. When menu RCV1 (middle left) appears, select either **STANDARD** (step 4) or **USER DEFINED** (step 5). Your selection depends on the application.

Step 4. The Standard mode uses the Source Lock mode for operation with the internal source. The user has no control over selections within the Standard Mode.

Because entering the standard mode from the User Defined Mode erases the current stored calibration data, a warning menu (RCV3, bottom left) appears when **STANDARD** is selected. Press Enter to enter into the Standard mode or press Clear to abort.

MENU RCV3
STANDARD RECEIVER MODE
WARNING:
CONTINUING MAY INVALIDATE CURRENT SETUP AND CALIBRATION
PRESS <ENTER> TO CONTINUE
PRESS <CLEAR> TO ABORT

NOTE

Spur Reduction: Normal / OFF: Spur Reduction Off may be selected when making non-ratioed measurements or using the Set-On Receiver mode. Under those measurement conditions, it may reduce high level noise. In normal S-parameter measurement mode, Spur Reduction should remain "Normal," as the noise level is not affected.

Step 5.

Selecting **USER DEFINED RECEIVER MODE** in menu RCV1 brings menu RCV 2 to the screen. When menu RCV 2 appears, the last mode selected is highlighted in red. The default selection is **SOURCE LOCK**.

Source Lock, Tracking or Set-On modes can be selected from this menu. When a mode is selected, information about that mode is displayed on the screen. This information describes the mode and the capabilities required of the RF source.

```
MENU RCV1
-----
RECEIVER MODE
STANDARD
USER DEFINED
SOURCE CONFIG
SPUR REDUCTION
NORMAL/OFF
PRESS <ENTER>
TO SELECT
```

```
MENU RCV2
-----
USER DEFINED
RECEIVER MODE
SOURCE LOCK
TRACKING
SET ON
PRESS ENTER
TO SELECT
```

```
MENU RCV4
-----
USER DEFINED
RECEIVER MODE
WARNING:
CONTINUING
MAY INVALIDATE
CURRENT
SETUP AND
CALIBRATION
PRESS <ENTER>
TO CONTINUE
PRESS <CLEAR>
TO ABORT
```

Chapter 9

Time Domain

Table of Contents

9-1	INTRODUCTION	9-3
9-2	TIME DOMAIN MEASUREMENTS	9-3
9-3	OPERATING TIME DOMAIN	9-8
9-4	WINDOWING	9-11
9-5	GATING	9-12
9-6	ANTI-GATING	9-14
9-7	EXAMPLES, GATING AND ANTI-GATING	9-14
9-8	TIME DOMAIN MENUS	9-14

Chapter 9

Time Domain

9-1 INTRODUCTION

This chapter describes the optional Time Domain feature.

9-2 TIME DOMAIN MEASUREMENTS

The Option 2, Time Domain feature provides a useful measurement tool for determining the location of impedance discontinuities. Some typical applications are identifying and analyzing circuit elements, isolating and analyzing a desired response, locating faults in cables, and measuring antennas.

TIME DOMAIN A USEFUL TOOL FOR:

- Identifying and Analyzing Circuit Elements
 - Isolating a Desired Response
 - Locating Faults
 - Making Antenna Measurements
-

The relationship between the frequency-domain response and the time-domain response of a network is described mathematically by the Fourier transform.

The 373XXA makes measurements in the frequency domain then calculates the inverse Fourier transform to give the time-domain response. The time-domain response is displayed as a function of time (or distance). This computational technique benefits from the wide dynamic range and the error correction of the frequency-domain data.

373XXA TIME DOMAIN MODES

- Lowpass Mode
 - Bandpass Mode
-

Let us examine the time-domain capabilities. Two measurement modes are available: lowpass and bandpass.

We use the lowpass mode with devices that have a dc or low-frequency response. In the lowpass mode two responses to the device-under-test (DUT) are available: impulse or step response.

LOWPASS MODE

- Either Impulse or Step Response Available
 - Displays Impedance Information
 - Requires Harmonically Related Frequencies
-

The frequencies used for the test must be harmonically related (integer multiples) to the start frequency. The simplest way to calculate this relationship is to divide the highest frequency in the calibration by 1600 (the default number-of-points available); this is the start frequency. For example if the highest frequency is 40 GHz, the calculated start frequency is 0.025 GHz (40/1600). If the highest frequency is 65 GHz, the calculated start frequency is 0.040625 GHz (65/1600).

Used When Device Has a DC or Low Frequency Path

The lowpass impulse response displays the location of discontinuities as well as information useful in determining the impedance (R, L, or C) of each discontinuity.

The impulse response is a peak that goes positive for $R > Z_0$ and negative for $R < Z_0$. The height of the response is equal to the reflection coefficient

$$\rho = \frac{R - Z_0}{R + Z_0}$$

The impulse response for a shunt capacitance is a negative-then-positive peak and for a series inductance is a positive-then-negative peak (Figure 9-1).

An example of using impulse response is circuit impedance analysis. With an impulse response, we can observe the circuit response of a passive device, such as a multielement step attenuator (Figure 9-2), and make final, realtime adjustments during the test.

CIRCUIT ELEMENTS
Lowpass Impulse Response

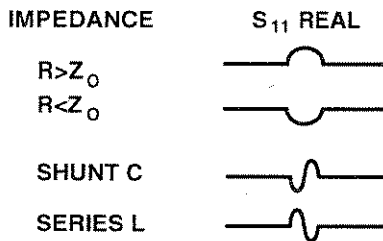

Figure 9-1. Lowpass Impulse Response

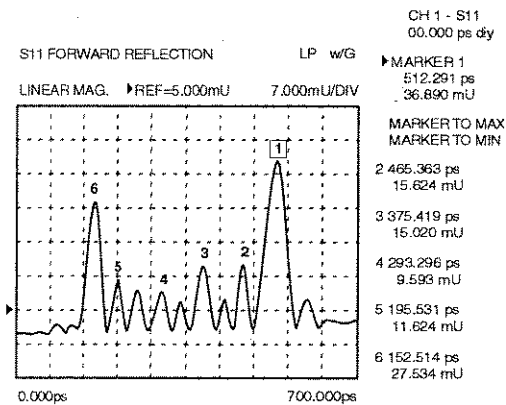
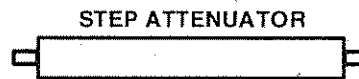

Figure 9-2. Example of Lowpass Impulse Response

In the above example, the connectors at each end have been gated out (page 9-12), which lets you better observe the internal circuit response. Each displayed marker has been manually set to the peak of the response at each adjustable circuit element. In this way, the data display lets you make the adjustment in realtime, while the marker menu shows the magnitude of the response at each marker.

The lowpass step response displays the location of discontinuities as well as information useful in determining the impedance (R, L, or C) of each discontinuity. If you are familiar with time-domain reflectometry

LOWPASS IMPULSE RESPONSE

Location of Discontinuities
Information on Type of Discontinuities

**CIRCUIT ELEMENTS
Lowpass Step Response**

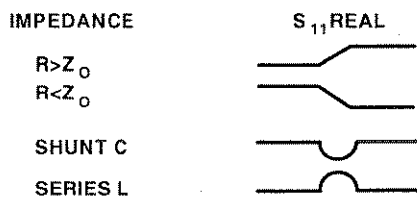

Figure 9-3. Lowpass Step Response

(TDR) you may feel more comfortable with step response, as the displays are similar.

The lowpass step response for a resistive impedance is a positive level shift for R > Z₀ and a negative level shift for R < Z₀. The height of the response is equal to the reflection coefficient

$$\rho = \frac{R - Z_0}{R + Z_0}$$

The step response for a shunt capacitance is a negative peak, and for a series inductance it is a positive peak (Figure 9-3).

An example of using the lowpass step response is cable-fault location. In the frequency domain a cable with a fault exhibits a much worse match than a good cable. Using lowpass step response, both the location of the discontinuity and the information about its type are available (Figure 9-4).

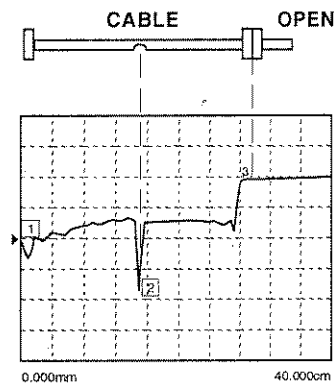

Figure 9-4. Example of Lowpass Step Response

In the above example, the dip in the display shows the shunt-capacitive response caused by a crimp in the cable. The response at the end of the cable shows the step-up that is typical of an open (Figure 9-3, left).

LOWPASS STEP RESPONSE

TDR Measurement
Location of Discontinuities
Information on Type of Discontinuities

The 373XXA bandpass mode gives the response of the DUT to an RF-burst stimulus. Two types of response are available: impulse and phasor-impulse. An advantage of the bandpass mode is that any frequency range can be used. Use this mode with devices that do not have a dc or low-frequency path.

BANDPASS MODE

Calculates Impulse or Phasor-Impulse Response

Uses Any Frequency Range

Used When Device Does Not Have a DC or Low-Frequency Path

Use the bandpass-impulse response to show the location of a discontinuity in time or distance, as indicated by changes in its magnitude. Unlike the lowpass mode, no information as to the type of the discontinuity is available. A typical use for this mode is to measure devices—such as, filters, waveguide, high-pass networks, bandpass networks—where a low-frequency response is not available.

The bandpass-impulse response for various impedance discontinuities is shown in Figure 9-5. As we can see, no information about the type of discontinuity is available.

An example of using the bandpass-impulse response, is the pulse height, ringing, and pulse envelope of a bandpass filter (Figure 9-6). Use the phasor-impulse response with bandpass response to determine the type of an isolated impedance discontinuity.

CIRCUIT ELEMENTS

Bandpass Impulse Response

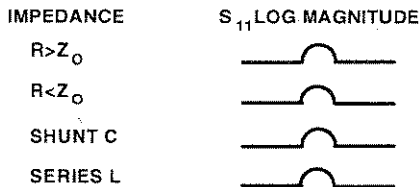

Figure 9-5. Bandpass Impulse Response

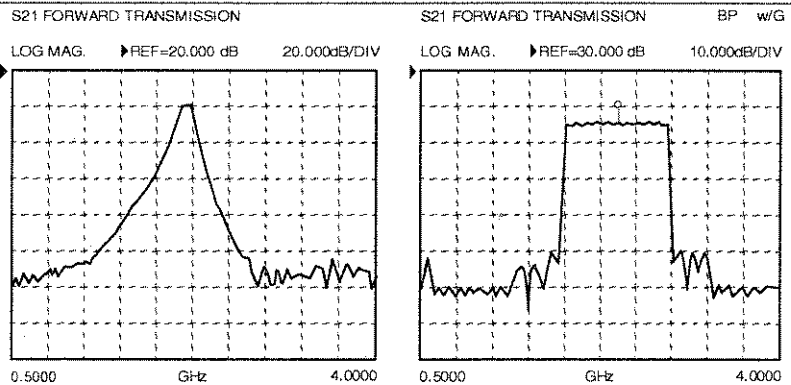

Figure 9-6. Example of Bandpass-Impulse Response

BANDPASS IMPULSE RESPONSE

Magnitude Measurement Only

Location of Discontinuities

After the bandpass-impulse response has been isolated, the phasor-impulse response for a resistive-impedance-level change is a peak that goes positive ($R > Z_0$) for the real part of S_{11} and negative for $R < Z_0$. The imaginary part remains relatively constant. In each case the peak is proportional to the reflection coefficient. The phasor-impulse response for a shunt capacitance is a negative-going peak in the imaginary part of S_{11} . For a series inductance, it is a positive going peak (Figure 9-7).

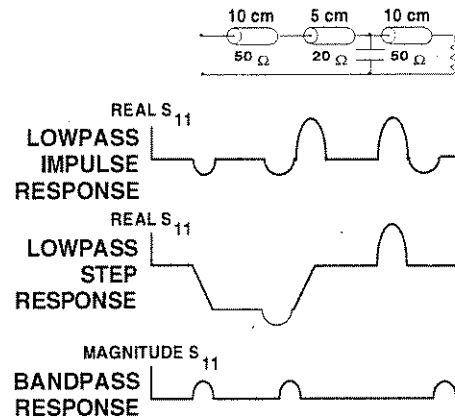

Figure 9-7. Complex Impedances

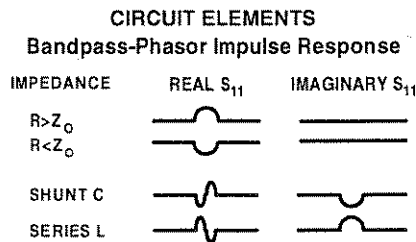

Figure 9-8. Bandpass Phasor Response

Next, let us look at a complex circuit. A resistive impedance change $R < Z_0$ and a shunt capacitance and series inductance. These impedance changes are shown in the time domain for the lowpass-impulse response, lowpass-step response, and bandpass-impulse response (Figure 9-8).

The 373XXA processes bandpass-impulse-response data to obtain phasor-impulse response. This becomes most advantageous where both a reactive reflection and an impedance change occur at the same location. The real part of the time-domain response shows the location of impedance level changes, while the imaginary part shows the type of reactive discontinuity. Phasor-impulse response displays one discontinuity at a time (Figure 9-9).

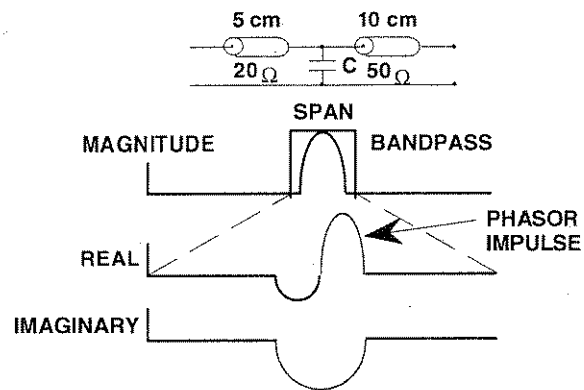
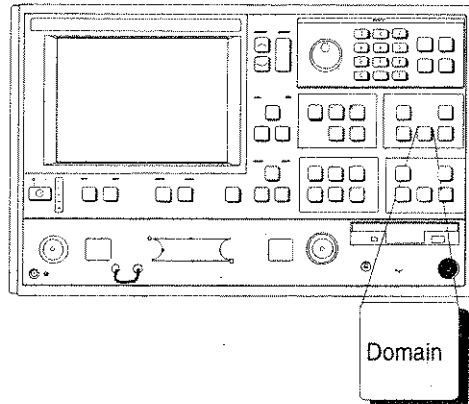

Figure 9-9. Phasor-Impulse Response Data

**9-3 OPERATING TIME
DOMAIN**

To operate in the time domain mode, press the Domain key (below). A domain menu (Figure 9-10) lets you select the frequency- or time-domain modes by simple cursor selection. The 373XXA defaults to the frequency domain.

Select time or distance for the horizontal axis. The 373XXA defaults to time axis.



SET
DIELECTRIC
CONSTANT
AIR
(1.000649)
POLYETHYLENE
(2.26)
TEFLON
(2.10)
MICROPOROUS
TEFLON
(1.69)
OTHER
XXXX.XX
PRESS <ENTER>
TO SELECT

NOTE

If you select distance, be sure to set the dielectric constant in the Reference Delay menu (Figure 9-11).

DOMAIN
FREQUENCY
FREQUENCY
WITH TIME
GATE
TIME
LOWPASS MODE
TIME
BANDPASS
MODE
DISPLAY
TIME/DISTANCE
SET RANGE
SET GATE
GATE ON/OFF
HELP
PRESS <ENTER>
TO SELECT
OR SWITCH

DOMAIN
FREQUENCY
FREQUENCY
WITH TIME
GATE
TIME
LOWPASS MODE
TIME
BANDPASS
MODE
DISPLAY
TIME/DISTANCE
SET RANGE
SET GATE
GATE ON/OFF
HELP
PRESS <ENTER>
TO SELECT
OR SWITCH

DOMAIN
FREQUENCY
FREQUENCY
WITH TIME
GATE
TIME
LOWPASS MODE
TIME
BANDPASS MODE
DISPLAY
TIME/DISTANCE
SET RANGE
SET GATE
GATE ON/OFF
HELP
PRESS <ENTER>
TO SELECT
OR SWITCH

**Figure 9-11. Reference Delay
Menu**

Figure 9-10. Domain Menu

Select **SET RANGE** and use the **START/STOP** or **GATE/SPAN** selections to set the range (Figure 9-12).

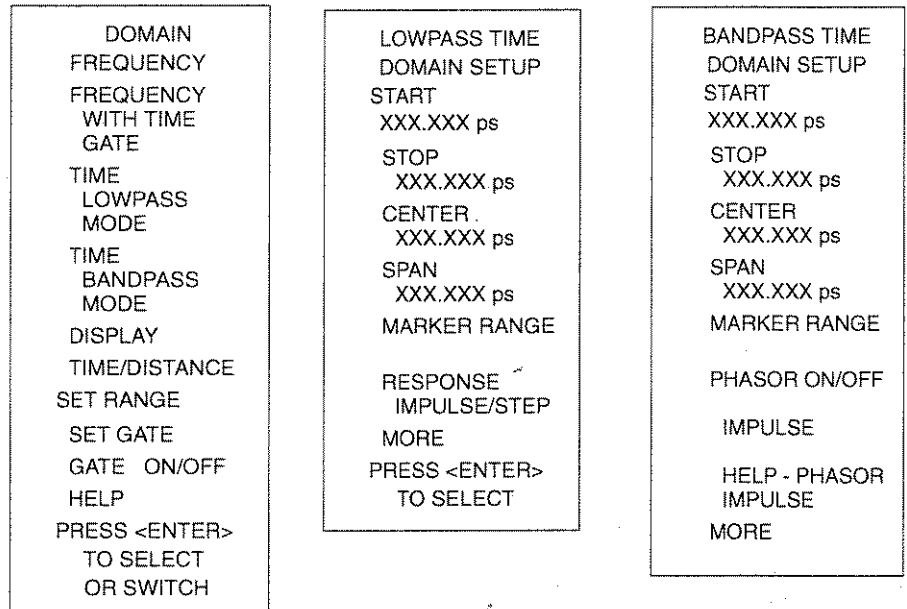

Figure 9-12. Set Range Menu

For the lowpass mode select either **IMPULSE** or **STEP** Response and set the DC term. The 373XXA defaults to the **IMPULSE** Response and the **AUTO EXTRAPOLATE** mode for the DC term (Figure 9-13).

NOTE

The bandpass mode displays Bandpass Impulse Response unless we select Phasor Impulse Response.

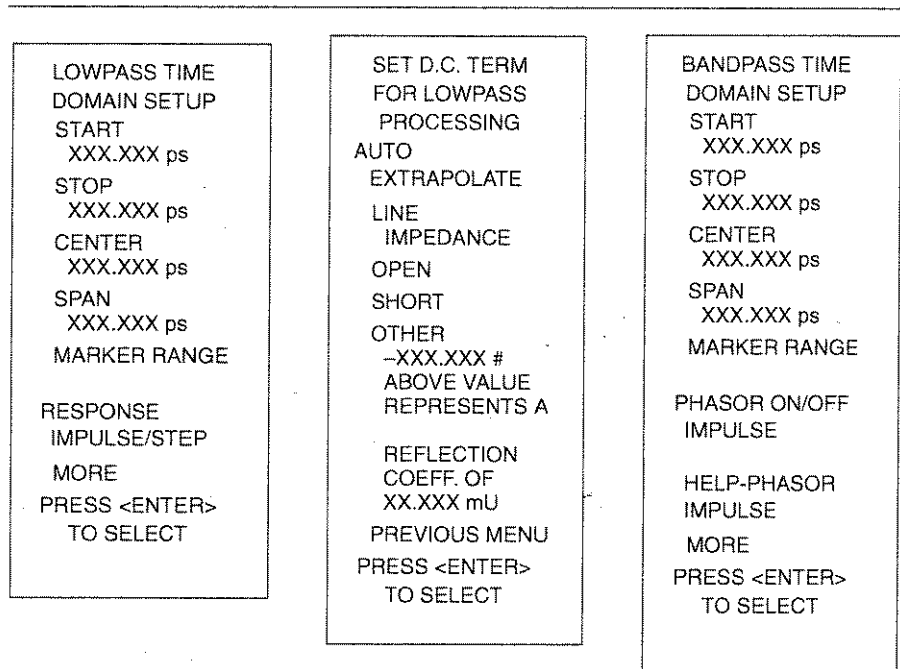

Figure 9-13. Response Menus

The Marker Range menu allows us to zoom in and display the range between two selected markers (Figure 9-14).

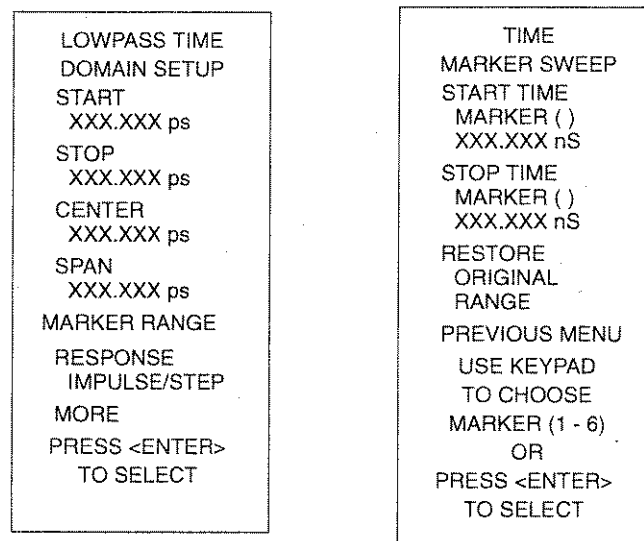

Figure 9-14. Marker Range Menus

9-4 WINDOWING

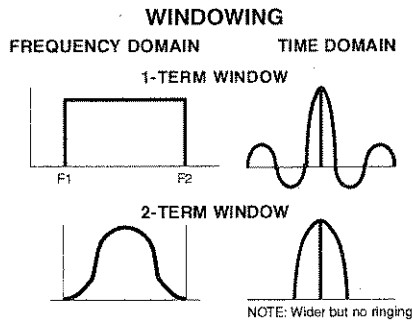

Figure 9-15. Windowing

Windowing is a frequency filter that we apply to the frequency-domain data when we convert it to time-domain data. This filtering rolls off the abrupt transition at F1 and F2. This effectively produces a time-domain response with lower sidelobes. Windowing allows a limited degree of control over the pulse shape, trading off ringing (sidelobes) for pulse width (Figure 9-15).

We select windowing from the Time Domain Setup menu. Four different windows are available: RECTANGLE, NOMINAL, LOW SIDELOBE, and MINIMUM SIDELOBE. The RECTANGLE option provides the narrowest pulse width, while the MINIMUM SIDELOBE option provides the least ringing (fewest sidelobes). The 373XXA defaults to the NOMINAL option, which is acceptable for most measurements. Windowing menus are shown in Figure 9-16.

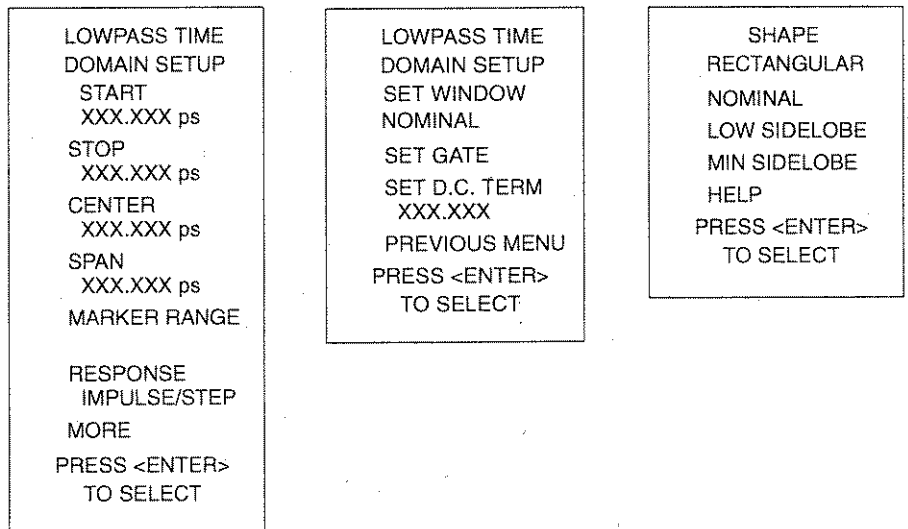

Figure 9-16. Window Shape Menus

9-5 GATING

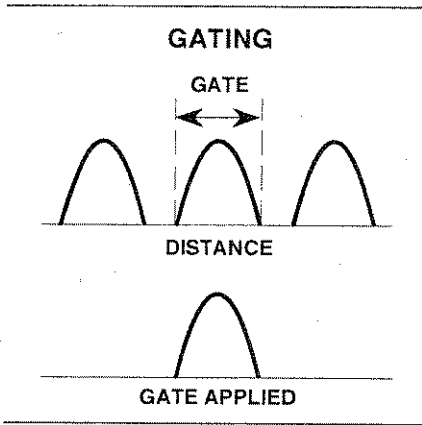

Figure 9-17. Gating

Gating is a time filter that allows for removing unwanted time-domain responses by gating the desired response. We can view the isolated response in both time domain—and in the frequency domain—using the FREQUENCY WITH TIME GATE selection (Figure 9-17).

There are four different gate shapes available: MINIMUM, NOMINAL, WIDE, and MAXIMUM (Figure 9-18). The 373XXA defaults to the NOMINAL gate. To specify a different shape simply enter the Gate menu and select the desired gating shape. The MINIMUM has the sharpest rolloff and some frequency domain ripple, while MAXIMUM has the least rolloff and best residual ripple. Figures 9-18A through 9-18D, on the next page, show gating shapes.

The combinations of gate/window shapes will be restricted. For the MINIMUM gate shape, the LOW and MIN SIDELOBE window shape will not be allowed. For the NOMINAL gate shape, the MIN SIDELOBE window will not be allowed. If the user has set the window shape to MIN or LOW SIDELOBE and changes the-gate shape to MINIMUM, the window will be reset to NOMINAL. If the user has set the window to MIN SIDELOBE and changes the gate shape to NOMINAL, the window will be reset to LOW SIDELOBE. Gate shapes will be adjusted in a similar manner.

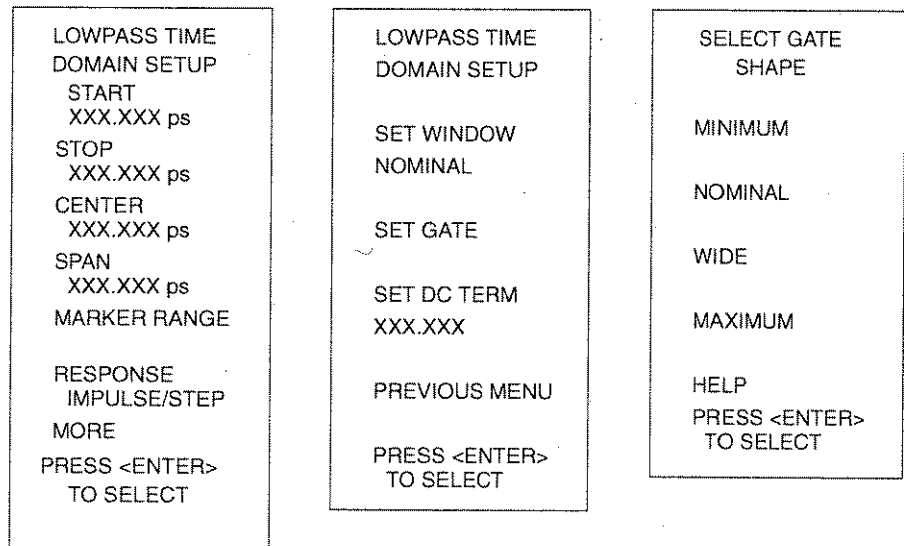

Figure 9-18. Gating Menus

An informational message will be displayed in the data area when the window or gate shape reset in this way. The message will last 2 sweeps, and will say:

“GATE SHAPE ADJUSTED” or “WINDOW SHAPE ADJUSTED” depending on which was changed by the software.

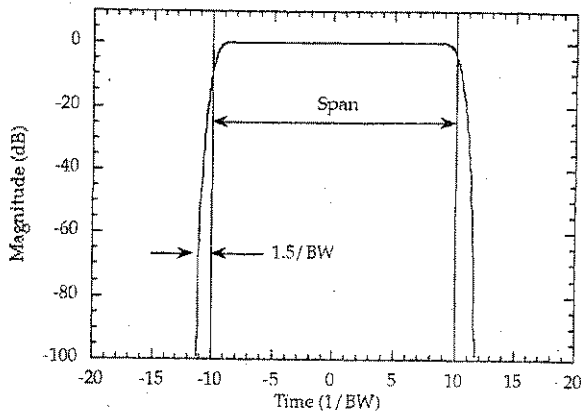

Figure 9-18A. Minimum Gate Shape

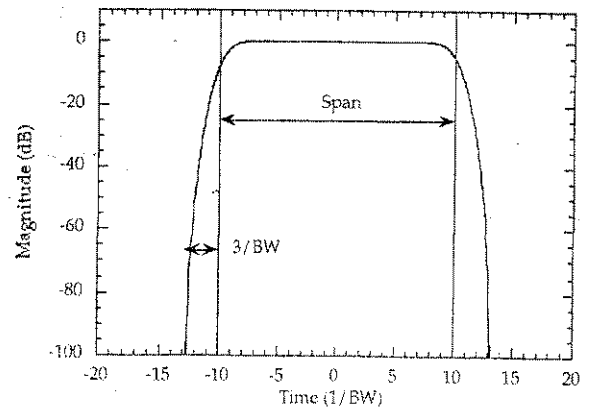

Figure 9-18B. Nominal Gate Shape

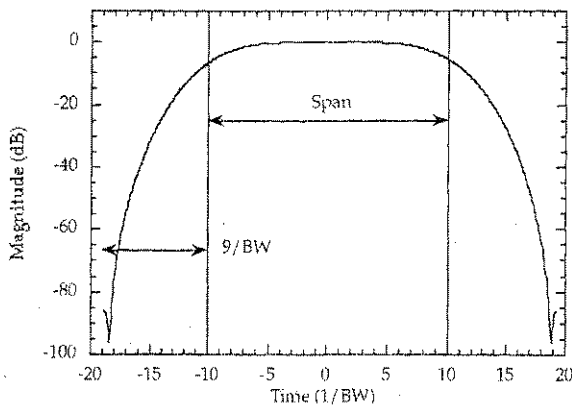

Figure 9-18C. Wide Gate Shape

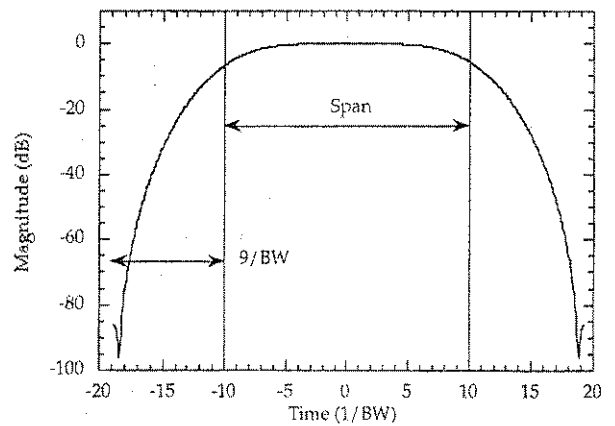

Figure 9-18D. Maximum Gate Shape

9-6 ANTI-GATING

Anti-gating is the opposite of gating. Whereby, gating provides for removing all but the desired response, anti-gating displays all but the desired response. To provide anti-gating, gate in the normal manner, except use a minus value for the SPAN width (middle left menu on next page).

9-7 EXAMPLES, GATING AND ANTI-GATING

Examples of anti-gating are shown in Figures 9-19 through 9-24. The figures, all captured from an actual VNA display, show a sequence of measurements using gating and anti-gating to enhance measurement technique and accuracy. The examples use a dented length of semi-rigid cable having a connector on one end and a connector-DUT on the other end, as shown below. The DUT has a smoothly varying 15 dB return loss.

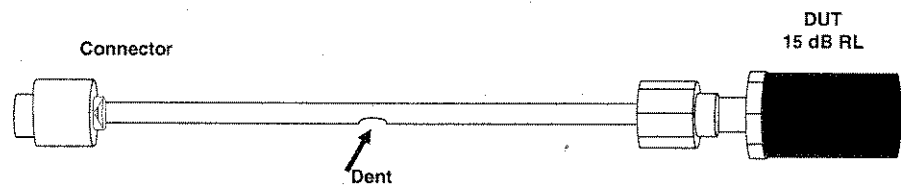

9-8 TIME DOMAIN MENUS

A flow diagram of the menus associated with the Time Domain Option is shown in foldout Figure 9-25. The menu choices are described in Appendix A. They appear in alphabetical order by their call letters: TD1, TD2, TD2dl, etc.

37369A

MODEL:
DEVICE:

DATE: 03/27/96 15:10
OPERATOR:

START: 4.000000000 GHz GATE START: ERROR CORR: REFL PORT1
STOP: 40.000000000 GHz GATE STOP: AVERAGING: 1 PT
STEP: 0.090000000 GHz GATE: IF BNDWDTH: 1 KHz
WINDOW:

S11 FORWARD REFLECTION

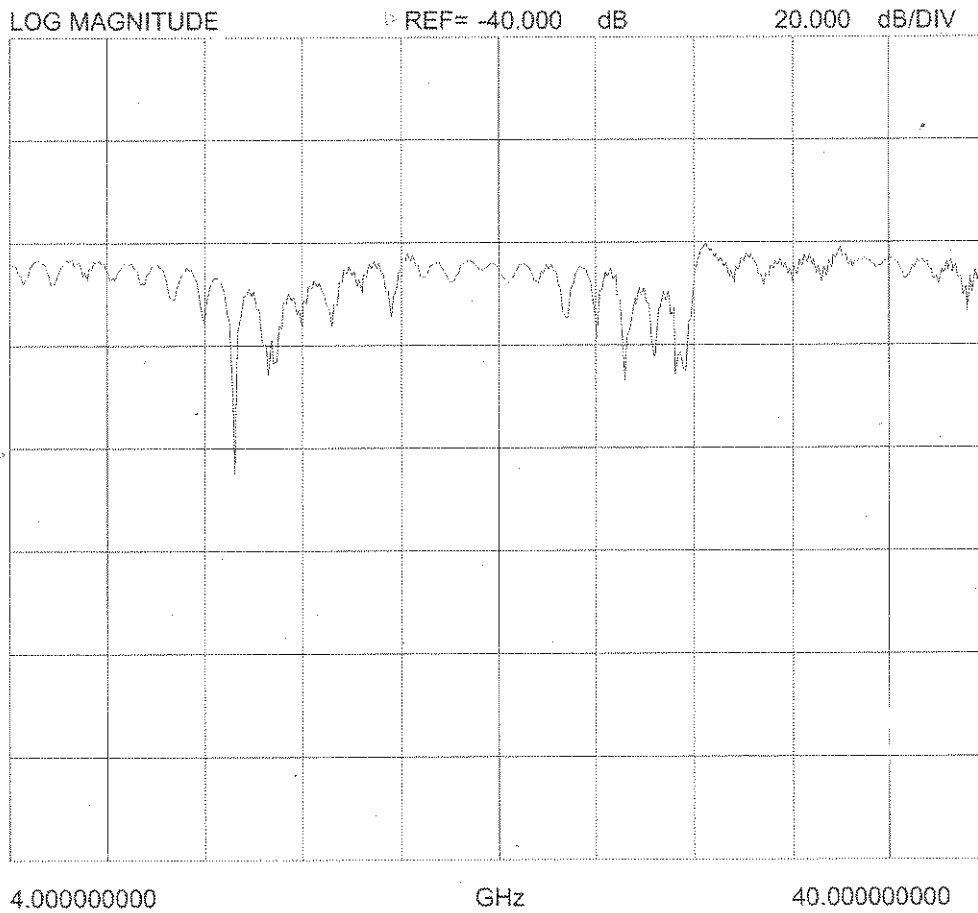

- DOMAIN
- ▷ FREQUENCY
 - FREQUENCY WITH TIME GATE
 - TIME LOWPASSMODE
 - TIME BANDPASSMODE
 - SETUP
 - DISPLAY TIME/ DISTANCE
 - SET RANGE
 - SET GATE
 - GATE OFF
 - HELP
 - PRESS <ENTER> TO SELECT OR SWITCH

Figure 9-19. Frequency Domain Trace Of Test Cable - Gating Off

37369A

MODEL: DATE: 03/27/96 15:12
 DEVICE: OPERATOR:

START: 4.000000000 GHz GATE START: 315.0000 ps ERROR CORR: REFL PORT1
 STOP: 40.000000000 GHz GATE STOP: 165.0000 ps AVERAGING: 1 PT
 STEP: 0.090000000 GHz GATE: NOMINAL IF BNDWDTH: 1 KHz
 WINDOW: NOMINAL

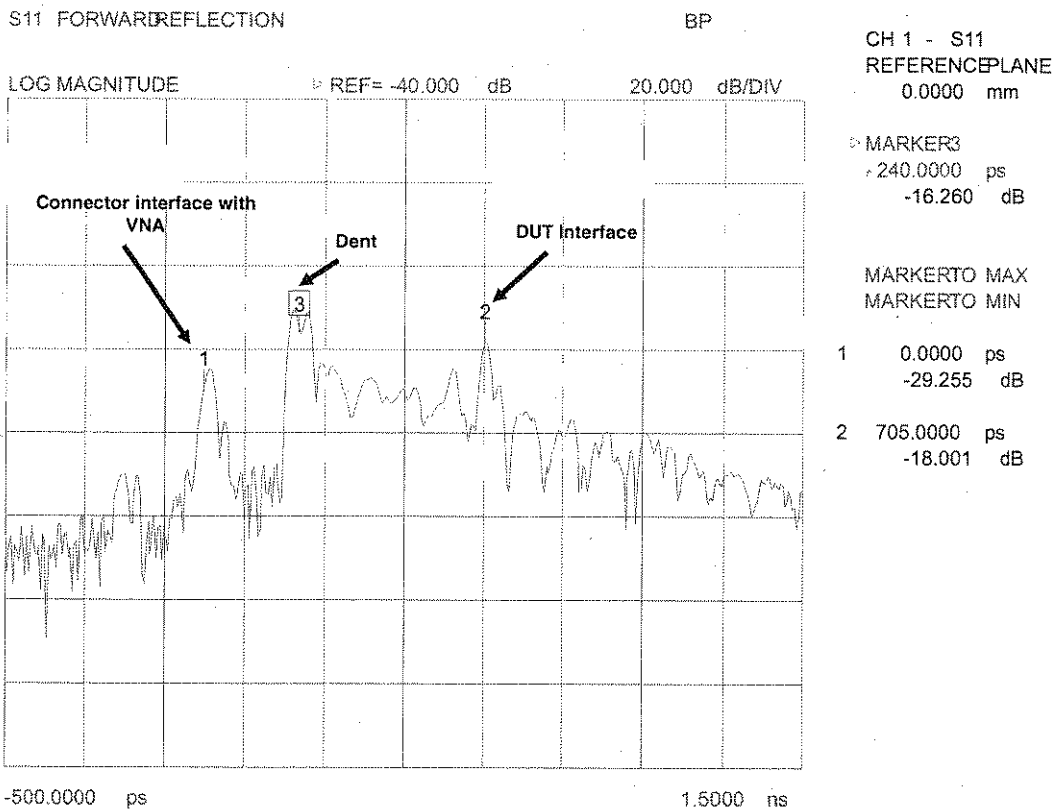

Figure 9-20. Time Domain Trace Of Test Cable - Gating Off

37369A

MODEL: DATE: 03/27/96 15:14
 DEVICE: OPERATOR:

START: 4.000000000 GHz GATE START: 642.5000 ps ERROR CORR: REFL PORT1
 STOP: 40.000000000 GHz GATE STOP: 767.5000 ps AVERAGING: 1 PT
 STEP: 0.090000000 GHz GATE: NOMINAL IF BNDWDTH: 1 KHz
 WINDOW: NOMINAL

S11 FORWARD REFLECTION

BP w/GATE

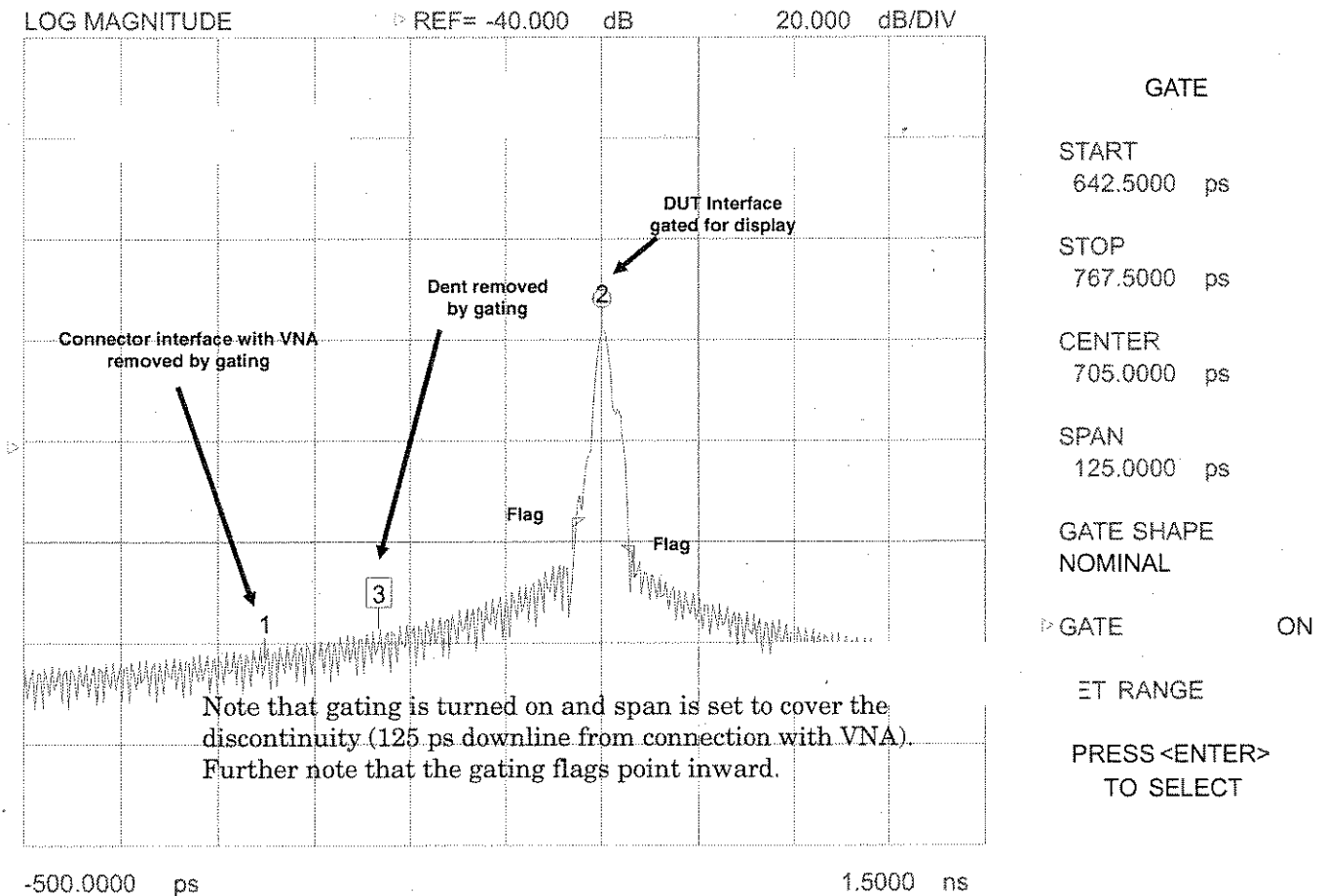

Figure 9-21. Time domain trace of test cable - Gating On and positioned over DUT interface discontinuity.

MODEL: DATE: 03/27/96 15:16
 DEVICE: OPERATOR:

START: 4.000000000 GHz GATE START: 642.5000 ps ERROR CORR: REFL PORT1
 STOP: 40.000000000 GHz GATE STOP: 767.5000 ps AVERAGING: 1 PT
 STEP: 0.090000000 GHz GATE: NOMINAL IF BNDWDTH: 1 KHz
 WINDOW: NOMINAL

S11 FORWARD REFLECTION

FGT

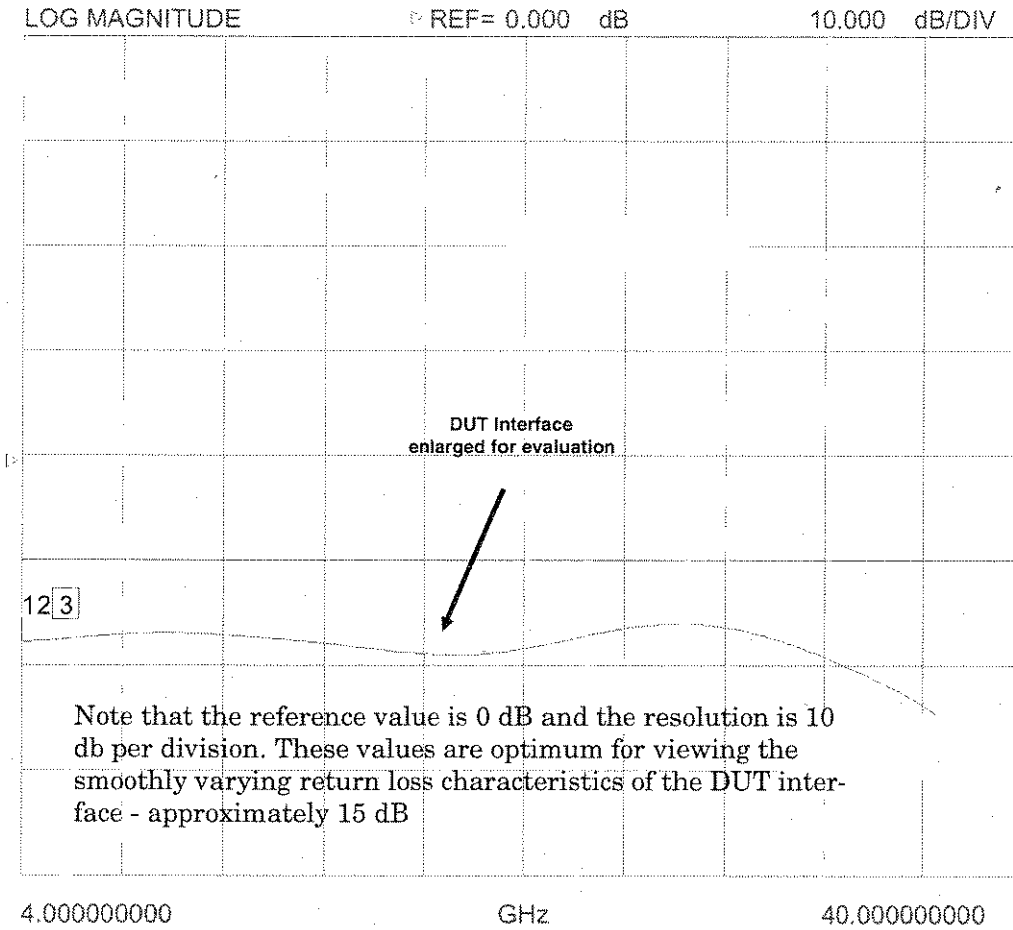

SET SCALING
 OR PRESS
 <AUTOSCALE>
 -LOG MAG-
 RESOLUTION
 10.000 dB/DIV
 REFERENCEVALUE
 0.000 dB
 REFERENCELINE
 4

Note that the reference value is 0 dB and the resolution is 10 db per division. These values are optimum for viewing the smoothly varying return loss characteristics of the DUT interface - approximately 15 dB

Figure 9-22. Frequency domain trace of DUT

MODEL: DATE: 03/27/96 15:19
 DEVICE: OPERATOR:

START: 4.00000000 GHz GATE START: 315.0000 ps ERROR CORR: REFL PORT
 STOP: 40.00000000 GHz GATE STOP: 165.0000 ps AVERAGING: 1 PT
 STEP: 0.09000000 GHz GATE: NOMINAL IF BNDWDTH: 1 KHz
 WINDOW: NOMINAL

S11 FORWARD REFLECTION

BP w/GATE

LOG MAGNITUDE

REF= -87.348 dB

20.000 dB/DIV

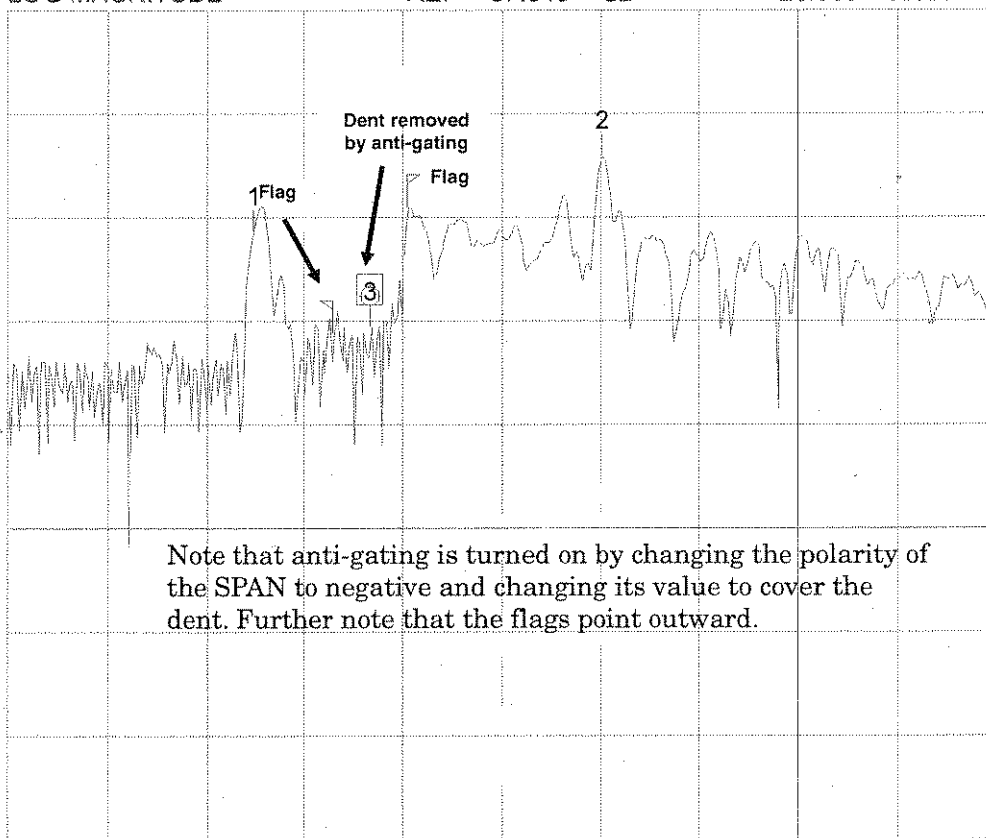

GATE

START 315.0000 ps

STOP 165.0000 ps

CENTER 240.0000 ps

SPAN -150.0000 ps

GATE SHAPE NOMINAL

▷ GATE

SET RANGE

PRESS <ENTER>
TO SELECT

-500.0000 ps

Figure 9-23. Time Domain Trace Of Test Cable - Gating On And Positioned Over Dent (Cable Fault) Interface Discontinuity.

MODEL: DATE: 03/27/96 15:23
DEVICE: OPERATOR:

START: 4.000000000 GHz GATE START: 340.0000 ps ERROR CORR: REFL PORT1
STOP: 40.000000000 GHz GATE STOP: 140.0000 ps AVERAGING: 1 PT
STEP: 0.090000000 GHz GATE: NOMINAL IF BNDWDTH: 1 KHz
WINDOW: NOMINAL

S11 FORWARD REFLECTION

FGT

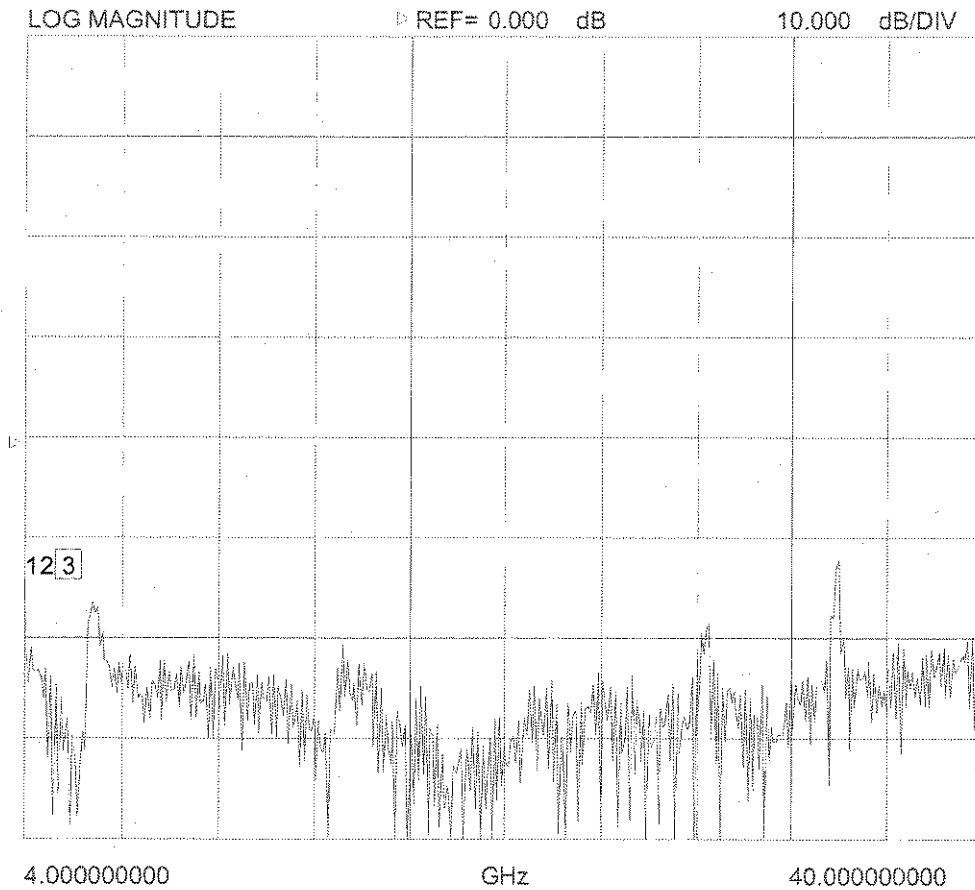

SET SCALING
OR PRESS
<AUTOSCALE>
-LOG MAG-
RESOLUTION
10.000 dB/DIV
▷ REFERENCEVALUE
0.000 dB
REFERENCELINE
4

Figure 9-24. Frequency Domain Trace Of Test Cable - Gating On

TIME DOMAIN

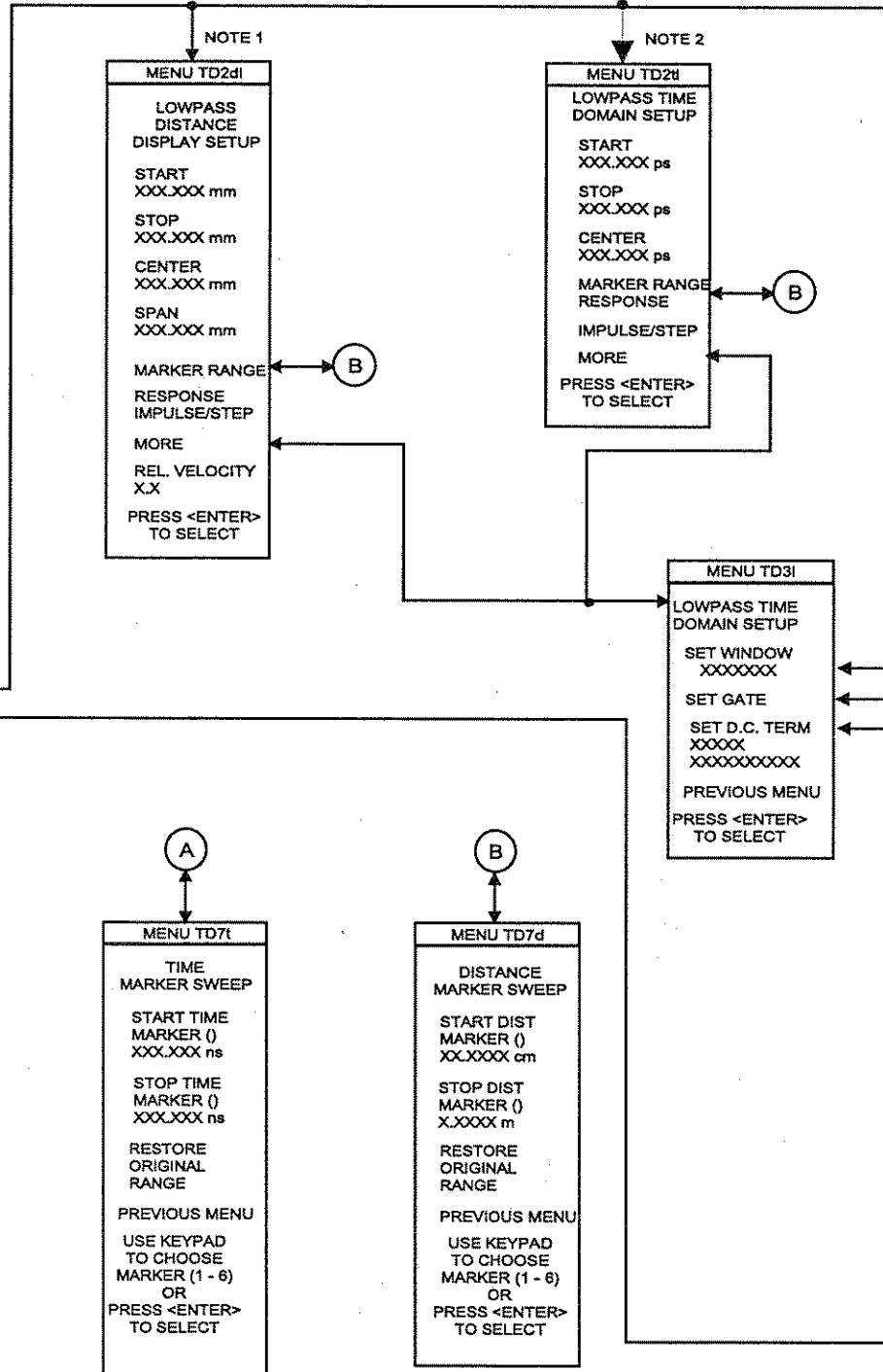
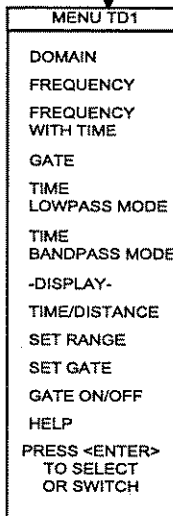
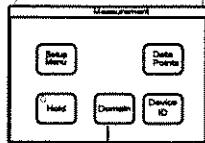
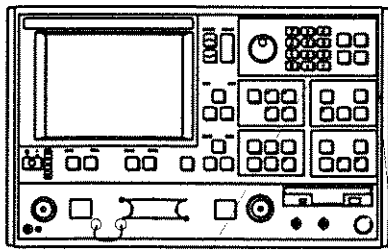

Chapter 10

AutoCal

Table of Contents

10-1	INTRODUCTION	10-3
10-2	DESCRIPTION	10-3
10-3	CALIBRATIONS	10-4
10-4	DEFINITION	10-4
10-5	PHYSICAL SETUP	10-6
10-6	CHARACTERIZATION FILES	10-7
10-7	USING AUTOCAL	10-9
10-8	PIN DEPTH SPECIFICATIONS	10-13
10-9	AUTOCAL MENUS FLOW DIAGRAM	10-14

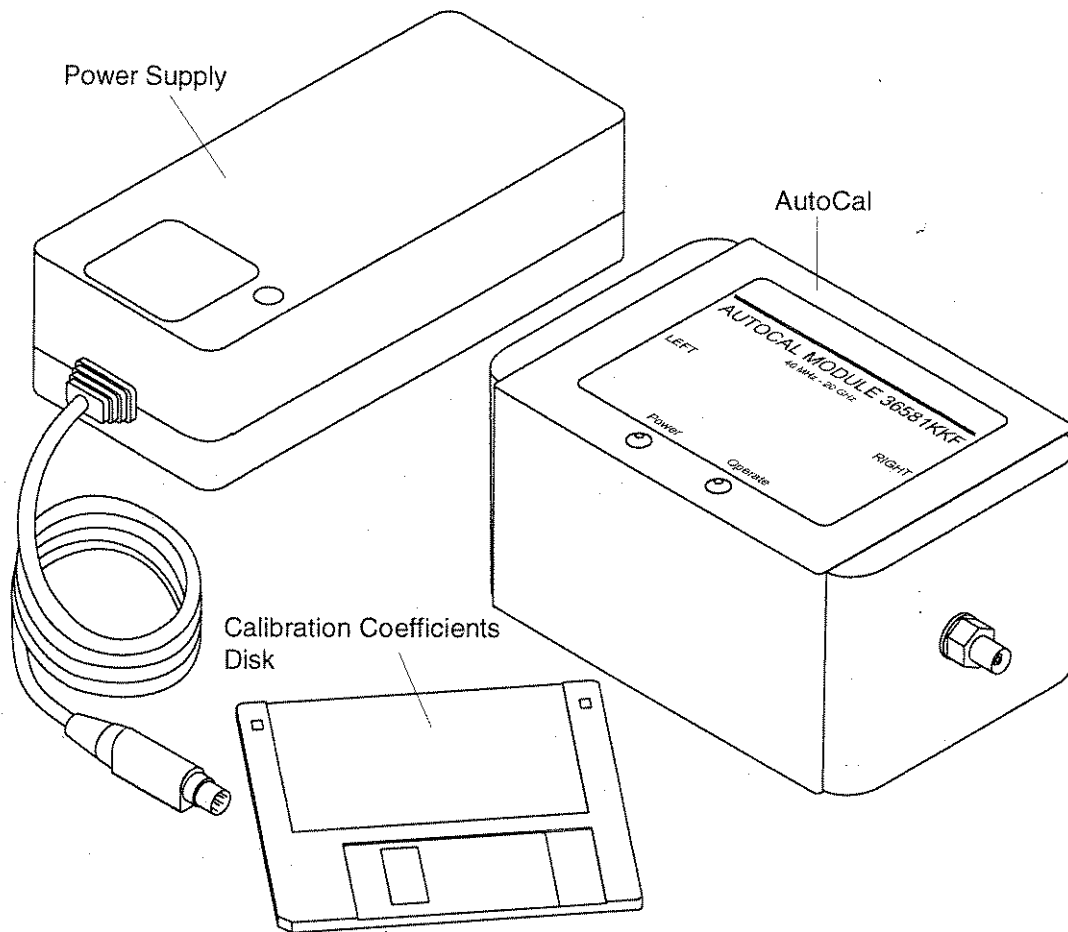

Figure 10-1. AutoCal Module, Power Supply, and Cables

Chapter 10

AutoCal

10-1 INTRODUCTION

This chapter provides a general description of the **AutoCal** calibrators, including specifications, setup, and the use of the associated software and on-line documentation. This series has three members, as shown below. Throughout this manual, the term **AutoCal** will refer to the series. Individual models will be referred to by model number. Figure 10-1 shows the **AutoCal** module and all of its attaching parts.

Model	Switch	Freq. Range	Connector.
36581NNF	Electronic	40MHz-18 GHz	N (Male)-N(Fem)
36581KKF	Electronic	40MHz-20 GHz	K(Male)-K(Fem)
36582KKF	Mechanical	40MHz-40 GHz	K(Male)-K(Fem)

10-2 DESCRIPTION

The **AutoCal** module provides an automatic system for fast, repeatable high-quality calibrations of a Vector Network Analyzer (VNA). The **AutoCal** module is inserted between the VNA test ports to perform the calibration. The **AutoCal** module is connected between Ports 1 and 2. Refer to Figure 10-2 for a diagram of the **AutoCal** connections.

The *electronic* **AutoCal** modules use solid state electronic switches to exchange the internal calibration standards. Note that these units have a lower frequency limit (18 and 20 GHz). The *mechanical* module uses electromechanical actuators to exchange the standards and has the highest frequency limit, but has a small non-repeatability error. The *mechanical* module contains internal standards used to measure port isolation; the *electronic* module does NOT contain isolation standards and requires a manual operation to perform this measurement.

A standard serial RS-232 interface cable is used to connect the **AutoCal** module to the 373XXA. Power is supplied by a connecting cable from a Universal power supply (+5V, +15V, -15V for the electronic modules; +5V, +24V for the mechanical modules). A power on-off switch is not provided.

Test Port Cable Converters (ANRITSU series 36583) are used during and after the calibration process to establish the desired test port connector type and sex.

10-3 CALIBRATIONS

Four types of calibration can be performed using **AutoCal**:

One-Port: S₁₁ 1-Port and S₂₂ 1-Port are 1-port calibrations performed on the indicated port of the VNA and are equivalent to the traditional Open-Short-Load calibrations.

Full 2-Port: This type is equivalent to the traditional Open-Short-Load-Thru (OSLT) calibration.

Thru Update: This type is a new form of calibration which is used to update an existing 12-term calibration in the VNA. This calibration could have been performed using any method of calibration which yields 12 terms (LRL, LRM, **AutoCal**, or OSLT). Due to cable movement and aging, the calibration may have degraded over time. The Thru Update refreshes the calibration by measuring a Thru connection and updating the Transmission Tracking and Load Match calibration coefficients.

Adapter Removal: This calibration measures the characteristics of male-male or female-female test port cables for subsequent measurement of non-insertable devices. An adapter is required for this calibration. Adapter Removal requires two calibration procedures in order to calculate the parameters and electrical length of the adapter.

10-4 DEFINITION

The following terms are used in explaining the calibration procedure using the **AutoCal** module:

Thru: A *thru* is a connection of the two test ports. Two kinds of thru connections are defined for the **AutoCal** calibration: (1) a *Calibrator* thru is an internal path through the calibrator. (2) a *True* thru is a direct cable connection between the test ports, with no intervening connectors. The calibrator thru is not as accurate as a true thru, so the you have the option during a calibration to use the more accurate method, if necessary.

Switch Averaging: The mechanical **AutoCal** module uses electromechanical switches to select calibration standards. These switches have a small amount of non-repeatability (typically less than -55 dB). For most calibrations, this is more than adequate because it is below connector repeatability error. If desired, you can choose to reduce the effect of this non-repeatability in the mechanical module by using *Switch Averaging*, which causes additional calibration measurements. By setting a Switch Averaging factor larger than 1, switch repeatability error will be reduced. The tradeoff is that calibration time will be proportionally increased.

Isolation: For certain measurements which require accurate S₂₁ or S₁₂ readings for very small values of those parameters, an *isolation*

step is required to characterize the leakage of the VNA and test setup. The isolation step can be performed automatically as part of a "Full 2-Port" calibration when using the *mechanical* module. The isolation step requires a manual operation for the *electronic* module. In order to achieve high accuracy for the characterization of the leakage, a high averaging factor is needed.

VNA Measurement Averaging Factor: This is used by the VNA when making measurements.

VNA Video IF Bandwidth: This can be set by using the Video IF BW key and selecting the desired IFBW.

Characterization File: Each calibrator module has a file containing data which characterizes each standard in the calibrator. This file also contains information (identification number, start and stop frequencies) concerning the capabilities of the calibrator. Each characterization file has the extension ".acd". When modules are changed, you must install the appropriate new characterization file. This file can be installed using the Utility key (AutoCal Utilities) to recall the characterization file from a disk. In addition, each AutoCal module can be re-characterized using the VNA. A valid 12-term calibration must be active, which is used to characterize the standards within the module.

10-5 PHYSICAL SETUP

See Figure 10-2 for an illustration of the connections necessary to perform an automatic calibration using the **AutoCal** module. Note that the connection is very simple. Different power cable connectors are used with the mechanical modules and the electronic modules to prevent connecting the wrong power supply in error.

There is no on-off switch. When power is connected to the **AutoCal** module, the LED labeled **POWER** should come on immediately. The second LED, labeled **OPERATE**, should come on in about five minutes, after the internal temperature control oven has stabilized. (Internal temperature is held within a 5 °C window.)

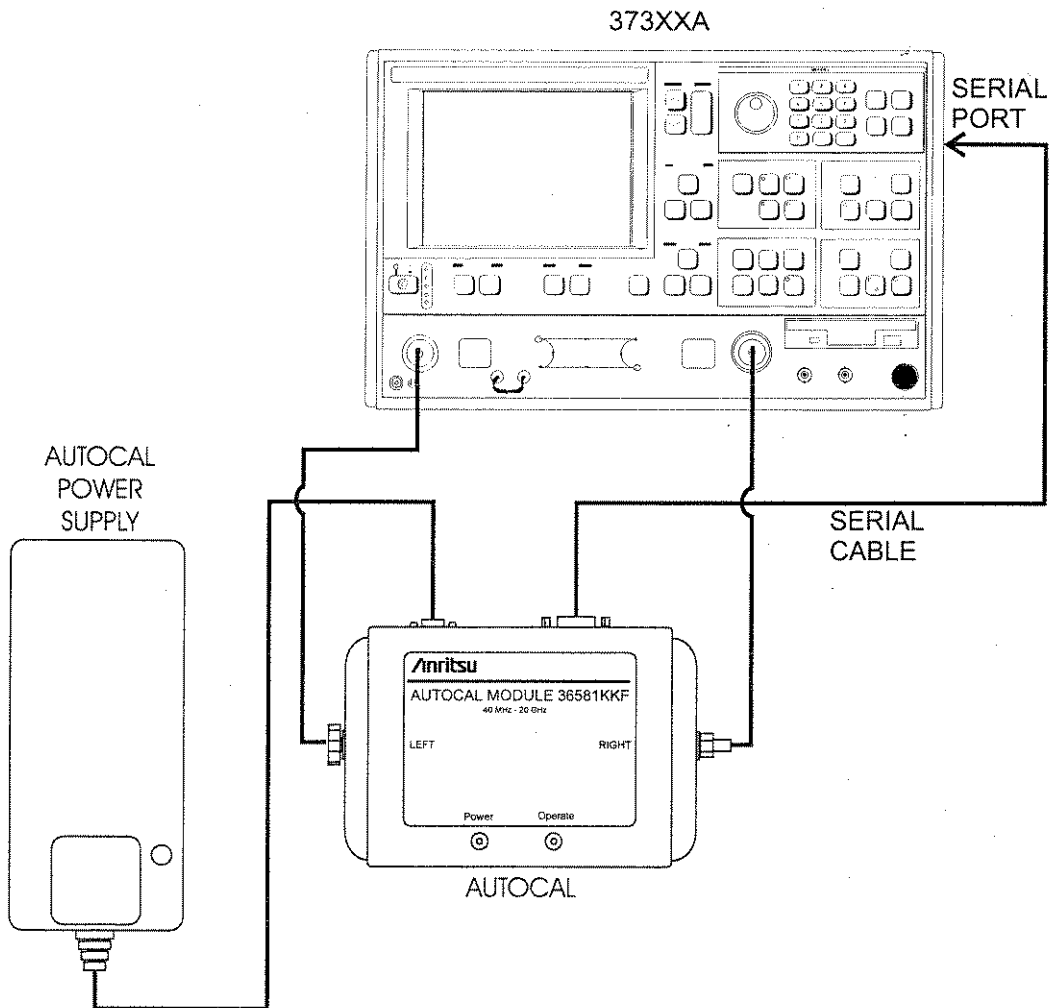
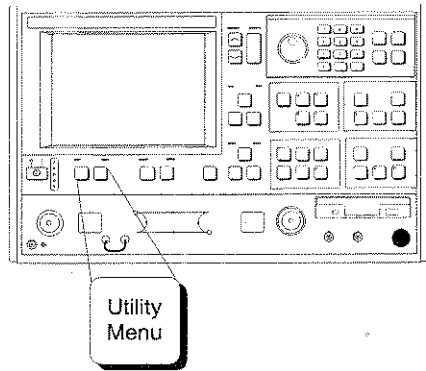

Figure 10-2. AutoCal Equipment Setup

10-6 CHARACTERIZATION FILES



Before performing an AutoCal on a 373XXA, the Characterization File for the AutoCal Module has to be loaded. This file may be recalled from the floppy disk accompanying the Module. It may also be recalled from one generated using the user's specialized manual calibration.

Insert the **AutoCal Module Characterization Disk** into the floppy drive. Press the Utility Menu key (left), then select the following menu options, in turn: **AUTOCAL UTILITIES, RECALL FROM FLOPPY DISK**. Select the file "Lxxxxxx.ACD".

If a copy of the Characterization File is in the hard-disk, you can recall it by choosing **RECALL FROM HARD DISK** instead. Select the same file "Lxxxxxx.ACD".

NOTE

The "xxxxxx" in the above paragraphs correspond to the serial number of the AutoCal module.

Should you desire to re-characterize the module (recommended every six months of usage), perform the following procedure:

Step 1. Using a 365x or 375x Calibration Kit, perform a 12-Term calibration over the desired frequency range of characterization, but within the range of the AutoCal module and the VNA.

Any calibration method may be used (Standard, Offset Short, LRL/LRM, or TRM) along with either the Coaxial or Waveguide line types.

Step 2. Upon completion of the calibration, press the Utility Menu key.

MENU UTIL
SELECT UTILITY FUNCTION OPTIONS
GPIB ADDRESSES
DISPLAY INSTRUMENT STATE PARAMS
GENERAL DISK UTILITIES
CAL COMPONENT UTILITIES
AUTOCAL UTILITIES
COLOR CONFIGURATION
DATA ON (OFF) DRAWING
BLANKING FREQUENCY INFORMATION
SET DATE/TIME
PRESS <ENTER> TO SELECT OR TURN ON/OFF

Step 3. Select **AUTOCAL UTILITIES** then **AUTOCAL CHARACTERIZATION**, from the next menu to appear.

```

AUTOCAL
CHARACTERIZATION
SWITCH AVERAGING
XXXX

PORT CONFIG
L=1, R=2
R=1, L=2

NUMBER OF
AVERAGES

REFLECTION
XXXX

LOAD
XXXX

THRU
XXXX

ISOLATION
XXXX

START AUTOCAL
CHARACTERIZATION
PRESS <ENTER>
TO SELECT
OR SWITCH
    
```

```

AUTOCAL
UTILITIES
AUTOCAL
CHARACTERIZATION

SAVE
TO HARD DISK

SAVE
TO FLOPPY DISK

RECALL
FROM HARD DISK

RECALL
FROM FLOPPY DISK

PRESS <ENTER>
TO SELECT
    
```

- Step 4.** Select an appropriate amount of **SWITCH AVERAGING** (recommend 4 for the electronic modules, and 16 for the electromechanical modules).
- Step 5.** Ensure the Module Configuration is correct (**L=1, R=2** or **R=1, L=2**)
- Step 6.** If desired, you may change the amount of averaging during characterization of each standard, by entering the **NUMBER OF AVERAGES**.
- Step 7.** Ensure the Autocal Module is connected between the Test Ports, power is applied, and the serial cable is connected to the VNA. Verify that both the "Power" and "Operate" LED's are ON.
- Step 8.** Select **START AUTOCAL CHARACTERIZATION**. The VNA will proceed through a characterization of the attached Autocal Module. Upon completion, you may save the characterization to hard or floppy disk. The characterization is automatically stored for future use by the VNA. Many characterizations may be kept on disk under unique file names.

10-7 USING AUTOCAL

An example procedure for using the **AutoCal** module is given below. This example assumes a frequency range of 40 MHz to 40 GHz, a power level of -7 dBm, and use of a Series 36582 **AutoCal** module.

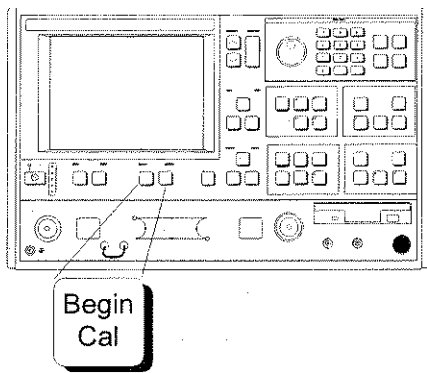

- Step 1.** Press the Begin Cal key (top left).
- Step 2.** Select **AUTOCAL** from the displayed menu (C11, left).

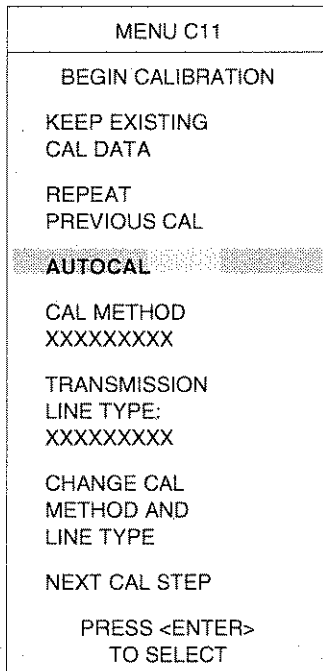

```

MENU ACAL
-----
AUTOCAL
AUTOCAL TYPE:
XXXXXXXX
CHANGE
AUTOCAL SETUP
START AUTOCAL
  THRU UPDATE
CONNECT THROUGH
LINE BETWEEN
PORTS 1 AND 2
THRU TYPE
CALIBRATOR/TRUE
NUMBER OF AVGS
XXX
START THRU UPDATE
USE PREVIOUS
AUTOCAL SETUP
PRESS <ENTER>
  TO SELECT
  OR SWITCH
    
```

Step 3.

The selections in the next menu to appear, MENU ACAL, will depend on current instrument conditions, as follows:

- a. **THRU UPDATE** lets you update the Thru calibration of an active 12-term Calibration. This updates the transmission frequency response and load match coefficients.
- b. **START AUTOCAL** lets you start a calibration using the current setup.
- c. **CHANGE AUTOCAL SETUP** lets you set up a new calibration, which is what we will do for this example. This example also assumes that you have selected the transmission medium and, if waveguide, identified the cutoff frequency.

```

MENU ACAL_SETUP
-----
AUTOCAL SETUP
LINE TYPE
COAXIAL/WAVEGUIDE
WAVEGUIDE CUTOFF
XX.XXXXXX GHz
SWITCH AVERAGING
8
NUMBER OF AVGS
REFLECTION
XXXX
LOAD
XXXX
THRU
XXXX
ISOLATION
XXXX
AUTOCAL TYPE
SII 1 PORT
S22 1 PORT
FULL 2 PORT
ADAPTER REMOVAL
    
```

Step 4.

Select **CHANGE AUTOCAL SETUP**. This causes MENU ACAL_SETUP (left) to appear.

Step 5.

Enter a **SWITCH AVERAGING** value of 8.

To improve the effect of switch repeatability error with the 36582 series (mechanical switch), you can change the switch averaging. Note, however, that switch averaging will have no effect on the 36581 series (electronic switch).

Step 6.

Select **FULL 2 PORT**. This displays a menu (MENU ACAL_FULL) that lets you set up the calibration (bottom left).

*You could have also selected **SII 1-PORT**, **S22 1-PORT**, or **ADAPTER REMOVAL**. The last of these lets you remove the effects of an adapter used in the calibration.*

Step 7.

Select the **PORT CONFIG** setting that matches the physical setup (**R=1, L=2** or **L=1, R=2**).

It is critical to ensure the correct module orientation is established. Each side (left and right) of the module is labeled.

Step 8.

Select the **THRU TYPE** to be either **CALIBRATOR** or **TRUE**.

*By default, the **CALIBRATOR** (internal) thru standard is used for the Thru Calibration. The transmission response of the calibration may be improved by selecting the **TRUE** thru standard. This will result in an added manual step.*

Step 9.

Observe that **OMIT** is shown for the **ISOLATION AVERAGING**.

*Isolation may be omitted (default). You may also select **DEFAULT** to use the default value during the isolation step. You may also use your own **AVERAGING FACTOR**. Including isolation involves a manual step for the 36581 models.*

Step 10.

Ensure the AutoCal module is properly connected between Ports 1 and 2, then select **START AUTOCAL**.

```

MENU ACAL_FULL
-----
AUTOCAL
FULL 2-PORT
ISOLATION
AVERAGING
OMIT
DEFAULT
AVERAGING
FACTOR
XXXX
THRU TYPE
CALIBRATOR/TRUE
PORT CONFIG
L=1, R=2
R=1, L=2
START AUTOCAL
PRESS <ENTER>
TO SELECT
OR SWITCH
    
```

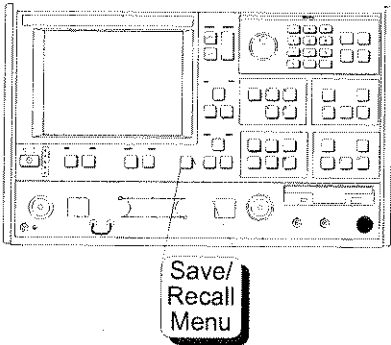

Follow the instructions and do not disturb the setup during the calibration. Please note that you should not start a calibration until both LED's on the AutoCal module are lit. This will ensure accurate calibration of the VNA.

After the Calibration, ...

Step 11.

Press the Save/Recall key.

Step 12.

Select **SAVE** then **FRONT PANEL SETUP AND CAL DATA TO HARD DISK** (middle and bottom left).

Step 13.

Enter a file name ...

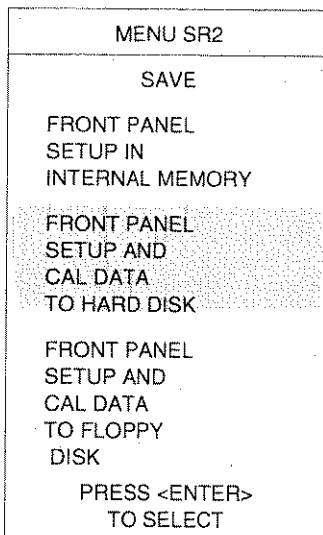
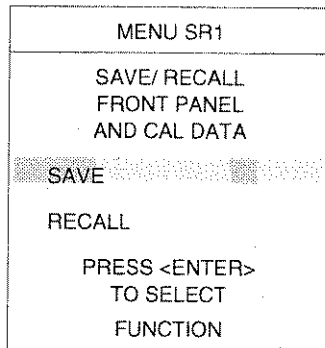

10-8 PIN DEPTH SPECIFICATIONS

The depth of the center pin on connectors is a critical specification, which if not met, can cause damage to mating connectors. Table 10-2 provides pin depth examples and Table 10-2 provides pin-depth specifications for associated **AutoCal** connectors.

Table 10-1. Checking Connector Pin Depth (Example)

<i>Example 1:</i>		
FEMALE MASTER GAUGE BLOCK (protrusion)		
	Desired nominal value:	0.2070
Case1	Actual value of master gauge	0.2071 (protrusions 0.0001 more than desired)
	Gauge should be set to indicate:	+0.0001
Case2	Actual value of master gauge	0.2069 (protrusions 0.0001 less than desired)
	Gauge should be set to indicate:	-0.0001
<i>Example 2:</i>		
MALE MASTER GAUGE BLOCK (cavity)		
	Desired nominal value:	0.2070
Case1	Actual value of master gauge	0.2071 (cavity 0.0001 deeper than desired)
	Gauge should be set to indicate:	-0.0001
Case2	Actual value of master gauge	0.2069 (cavity 0.0001 shallower than desired)
	Gauge should be set to indicate:	+0.0001

Table 10-2. AutoCal Module Connector Pin Depth Specifications

Device	Connector	Pin Depth (inches)
3658XXX	K-Female	+0.0000 to -0.005
3658XXX	K-Male	+0.0000 to -0.005
3658XXX	N-Female	*[0.207](+0.000, -0.005)
3658XXX	K-Female	*[0.207](+0.000, -0.005)
32K50 32KF50	K-Male (cable side)	**Negative Indication
	K-Female	+0.0000 to -0.0005
	K-Male (DUT side)	+0.0000 to -0.0005
32L50 32LF50	K-Male (cable side)	**Negative Indication
	3.5mm-Female (DUT side)	+0.006 to -0.008
	3.5mm-Male (DUT side)	+0.006 to -0.008
32S50 32SF50	K-Male (cable side)	**Negative Indication
	SMA-Female (DUT side)	+0.0005 to -0.0015
	SMA-Male (DUT side)	+0.0005 to -0.0015

*Gauging Type N Connectors: The actual value of a Type N master gauge block will always vary to some degree from the desired nominal value. The recorded measured value of the master gauge must be observed when calibrating the Pin Depth Gauge to the desired nominal value. Although the **AutoCal** Module Pin Depths are not critical, this information may be helpful in the measurement of Type N mating components. Examples are shown in Table 10-1, on the preceding page.

**10-9 AUTOCAL MENUS
FLOW DIAGRAM**

A flow diagram for the AutoCal menus is provided in Figure 10-3.

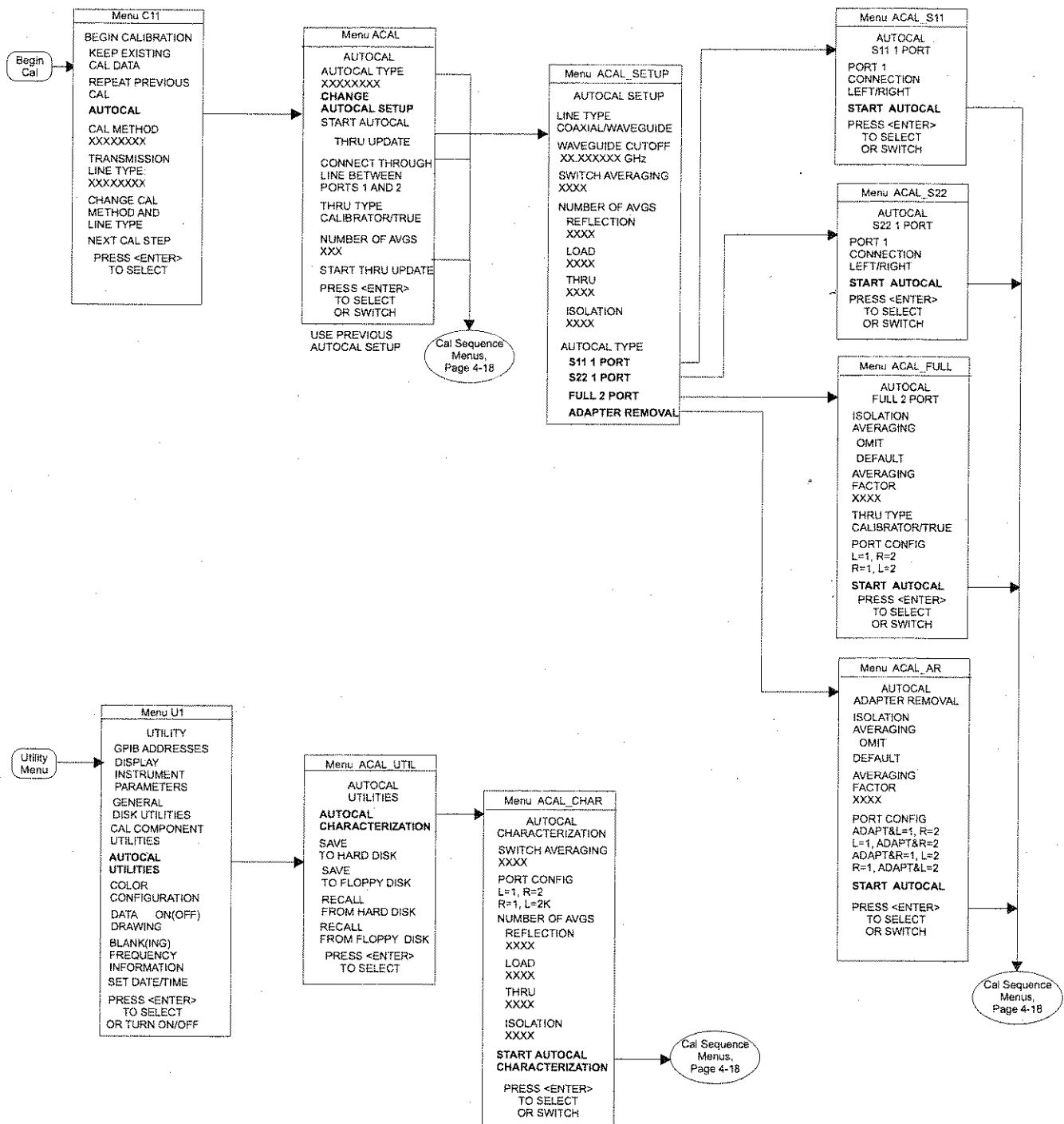

Figure 10-3. AutoCal Menus flow diagram

Chapter 11

Operational Checkout Procedures

Table of Contents

11-1	INTRODUCTION	11-3
11-2	REQUIRED EQUIPMENT	11-3
11-3	INITIAL SETUP	11-3
11-4	SELF TEST	11-3
11-5	NON-RATIO POWER	11-4
	Test Setup	11-5
	Test Procedure	11-5
11-6	HIGH LEVEL NOISE TEST	11-8
	Test Setup	11-8
	Test Procedure	11-8

Repair

WARNING 

WARNING

This equipment can not be repaired by the operator. DO NOT attempt to remove the equipment covers or to disassemble internal components. Only qualified service technicians with a knowledge of electrical fire and shock hazards should service this equipment. There are high-voltage parts in this equipment presenting a risk of severe injury or fatal electric shock to untrained personnel. In addition, there is a risk of damage to precision components.

Chapter 11

Operational Checkout Procedures

11-1 INTRODUCTION

This chapter provides quick operational checkout procedures that may be used by incoming inspectors to ensure that the Model 373XXA Vector Network Analyzer is operational. This is a quick-check procedure. For the full performance verification procedure, refer to the Series 373XXA Maintenance Manual, Anritsu Part Number 10410-00185

11-2 REQUIRED EQUIPMENT

Flexible microwave cable (through line).
Short

11-3 INITIAL SETUP

Perform the following steps before starting the performance tests.

- Press Power key (left) to On.

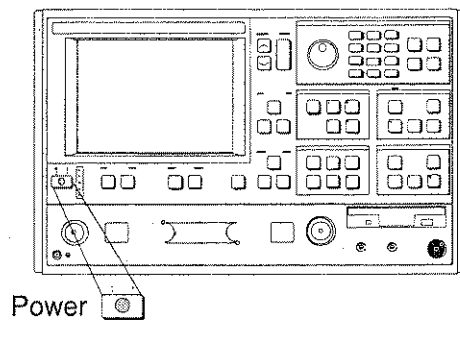

NOTE

Allow the system to warm up for at least 60 minutes to ensure operation to performance specifications.

11-4 SELF TEST

Perform an instrument self test to ensure that the 373XXA is operating properly. To start a self test, Press Option Menu key and make the menu choices shown in Figure 11-1.

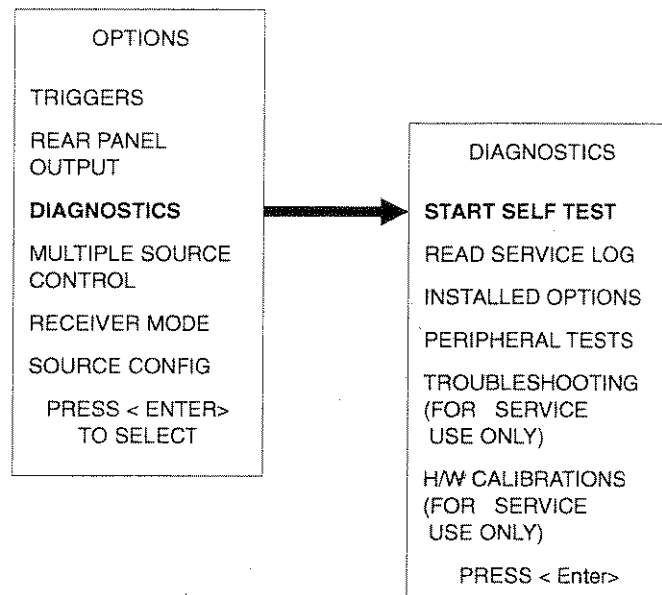
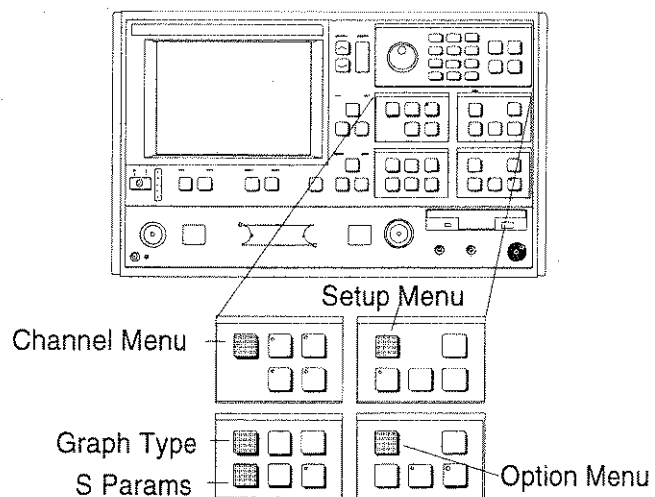

Figure 11-1. Performing a Self Test

11-5 NON-RATIO POWER

This test verifies that each individual receiver channel operates properly. Measurement calibration of the system is *not* required for this test.

This test requires that you press specified front panel keys and make choices from the displayed menu(s). The keys used in this test are shown below.



Key	Menu Choice
Options Menu	Non-Ratioed Parameters, see Figure 11-2
Setup Menu	START: 1 GHz STOP: Table 11-1, High-End Frequency
Channel Menu	FOUR CHANNELS
Graph Type	LOG MAGNITUDE (All channels)
S-PARAMS	USER 1: (Channel 3) Parameter: Ra/1 Phase Lock: Ra USER 2: (Channel 1) Parameter: Ta/1 Phase Lock: Ra USER 3: (Channel 2) Parameter: Tb/1 Phase Lock: Ra USER 4: (Channel 4) Parameter: Rb/1 Phase Lock: Rb (See Figure 3-7)
SET SCALE	RESOLUTION: 20 dB/DIV REF VALUE: 0 dB (All four channels)

Test Setup

Step 1.

Setup 373XXA as described below.

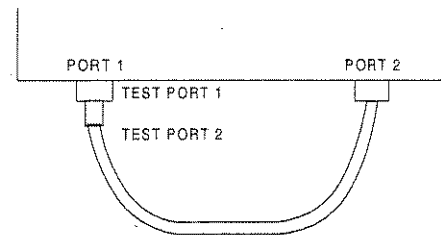

Connect Test Ports 1 and 2 together using a high-quality through line (below).

Step 2.

Reset the 373XXA using the Default Program key.

Step 3.

Set up the 373XXA as shown in table at left.

Test Procedure

Perform test as described below.

Step 4.

Observe sweep indicators and allow at least one complete sweep to occur on all four channels.

Step 5.

Verify that the maximum-value to minimum-value amplitude slope (Figure 11-3, page 11-7) meets the specifications shown below.

Model	High-End Frequency	Reference Channel Slope	Test Channels Slope
37311A	3 GHz	<5 dB	<8 dB
37317A	8.6 GHz	<5 dB	<8 dB
37325A	13.5 GHz	<7 dB	<9 dB
37347A	20 GHz	<7 dB	<9 dB
37369A	40 GHz	<16 dB	<18 dB
37397A	65 GHz	<45 dB	<45 dB

Step 1. Press OPTION MENU key.

Step 2. Make menu choices as shown below.

Step 3. Press SETUP MENU key; set START frequency to 1 GHz.

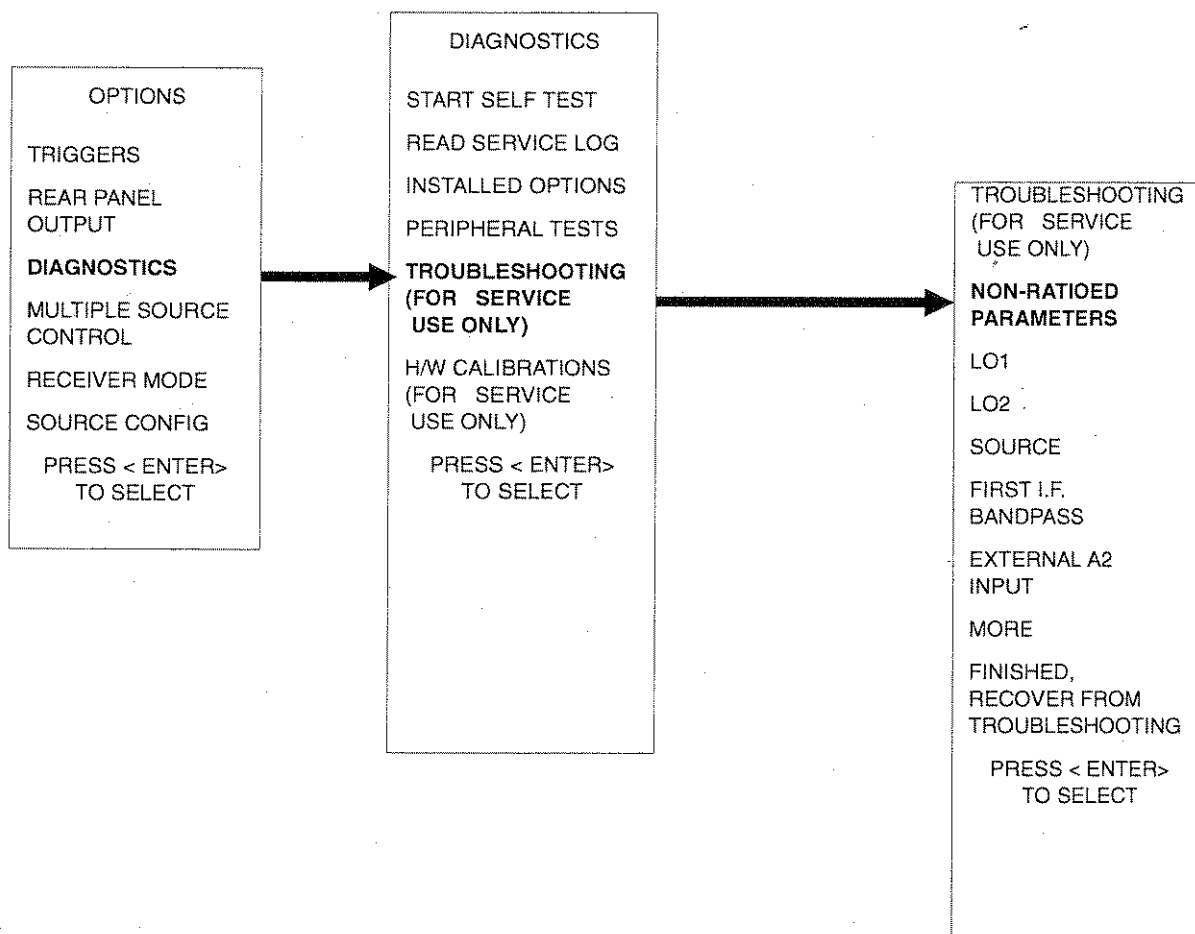
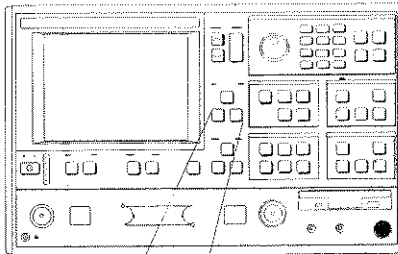

Figure 11-2. Redefining Selected Parameter Automatically for Sampler Efficiency Testing

Step 6.

Verify that the minimum amplitude meets the specifications shown below.



Marker Menu   Readout Marker

Model	Test Channels	Reference Channel
37311A	Y-25	Y-30
37317A	Y-28	Y-30
37325A	Y-34	Y-30
37347A	Y-35	Y-31
37369A	Y-40	Y-32
37397A	Y-60	Y-55

NOTE

Use the Marker Menu and Readout Marker keys (left) and menus to obtain precise frequency and amplitude values.

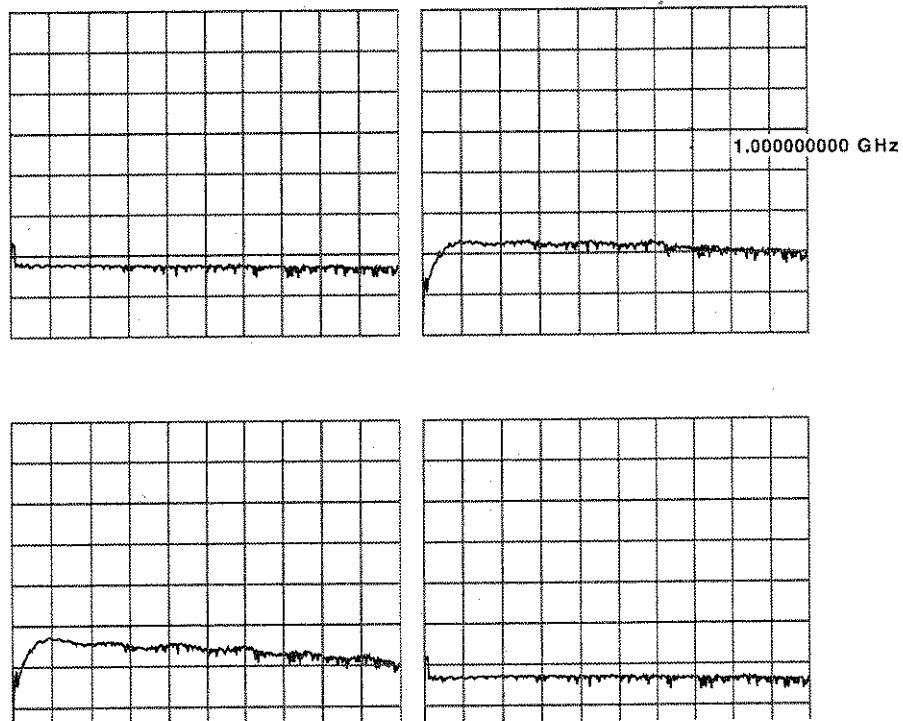

Figure 11-3. Sampler Efficiency Test Waveforms

11-6 HIGH LEVEL NOISE TEST

Key	Menu Choice
Setup Menu	START: 40 MHz STOP: High-end frequency
Channel Menu	DUAL CHANNELS 1-3
Graph Type	LOG MAGNITUDE (Both channels)
Set Scale	RESOLUTION: 0.020 dB/DIV REF VALUE: 0.0 dB (Both channels)
S-Params	Channel 1 – S12 Channel 3 – S21
Data Points	201
Video IF BW	NORMAL (1 kHz)
Limits	UPPER LIMIT ON 0.015 if less than 40 GHz 0.04 if 40 GHz (37369A) 0.14 if above 40 GHz LOWER LIMIT ON -0.015 if less than 40 GHz -0.04 if 40 GHz (37369A) -0.14 if above 40 GHz DISPLAY LIMITS ON

The following test verifies that the high-level signal noise in the 373XXA will not significantly affect the accuracy of subsequent measurements. Calibration of the system is *not* required for this test.

This test requires that you press specified front panel keys and make choices from the displayed menu(s). The keys used in this test are highlighted below.

Test Setup Setup 373XXA as described in table at left.

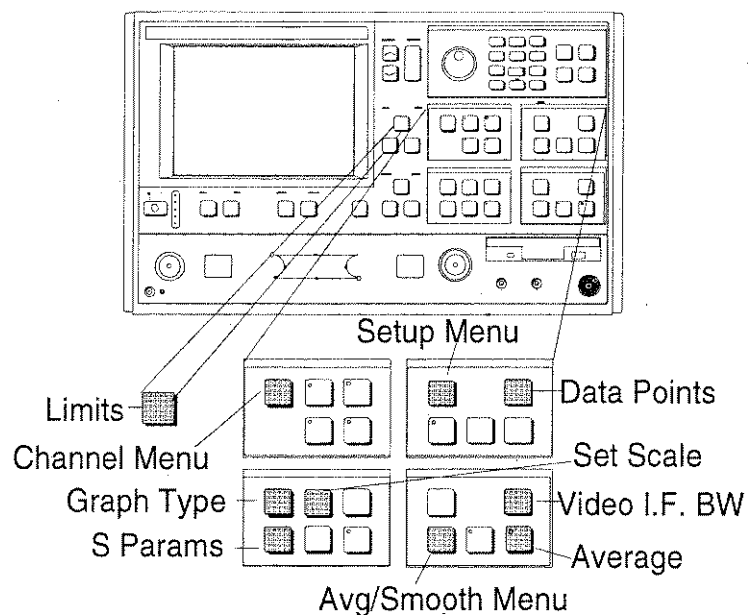

Test Procedure Perform test as described below.

- Step 1.** Reset the 373XXA using the Default Program key.
- Step 2.** Connect Test Port 1 and Test Port 2 (top left) together.
- Step 3.** Press Ch 1 key.
- Step 4.** Press Trace Memory key.
- Step 5.** Choose **VIEW DATA** (Figure 11-4) from menu and press Enter key.

- Step 6.** While observing sweep indicators, allow at least two complete sweeps to occur.
- Step 7.** Choose **STORE DATA TO MEMORY** from menu and press Enter key.
- Step 8.** Choose **VIEW DATA MEMORY** from menu and press Enter key.
- Step 9.** While observing sweep indicators, allow at least two complete sweeps to occur.
- Step 10.** Verify that the peak-to-peak High Level Noise falls within the area between the two limit lines (Figure 11-4).
- Step 11.** Press Ch 3 key.
- Step 12.** Repeat steps 4 thru 9 for channel 3.
- Step 13.** Press S Params key; set Ch 1 for S₁₁ and Ch 3 for S₂₂.
- Step 14.** Connect a Short to Test Port 1 and an Open to Test Port 2 (left).
- Step 15.** Repeat steps 2 thru 9;

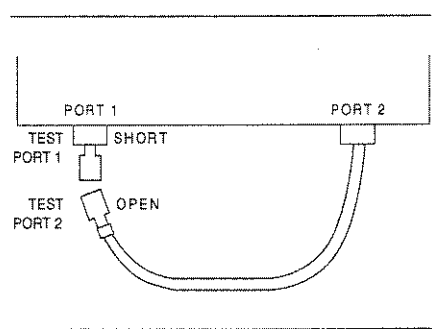
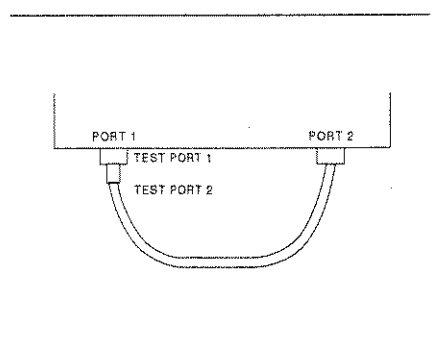

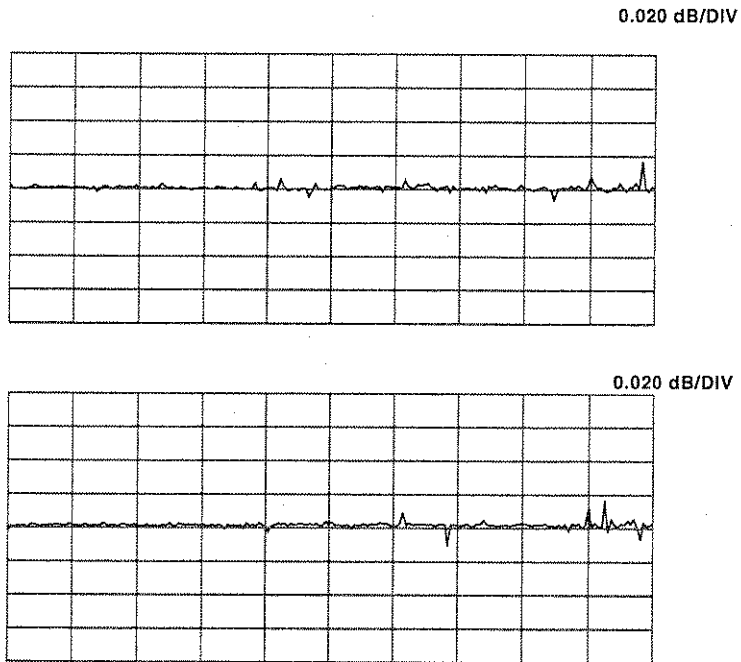

Figure 11-4. High Level Noise Test Waveform

Chapter 12

Calibration Kits

Table of Contents

12-1	INTRODUCTION	12-3
12-2	PURPOSE	12-3
12-3	KIT CONTENTS	12-3
	Model 3650 Calibration Kit	12-4
	Model 3651 Calibration Kit	12-6
	Model 3652 Calibration Kit	12-8
	Model 3653 Calibration Kit	12-10
	Model 3654/ 3654B Calibration Kit	12-12
	Model 36550 Calibration Kit	12-14
	Model 36552 Calibration Kit	12-16
12-4	PRECAUTIONS FOR USING CONNECTORS	12-18
	Pin Depth	12-18
	Pin Depth Tolerance	12-19
	Over Torquing Connectors	12-20
	Teflon Tuning Washers	12-20
	Mechanical Shock	12-20
12-5	CLEANING INSTRUCTIONS	12-21

Chapter 12

Calibration Kits

12-1 INTRODUCTION

This chapter provides illustrations and contents for the Models 3650, 3651, 3652, 3653, 3654/3654B, 36550 and 36552 Calibration Kits.

12-2 PURPOSE

The calibration kits contain all of the precision components and tools required to calibrate the 373XXA Vector Network Analyzer System for a 12-term error-corrected measurement.

12-3 KIT CONTENTS

Contents of the calibration kits are listed on the following pages.

**Model 3650
Calibration
Kit**

The SMA/3.5 mm kit (Figure 12-1) includes in the following items:

- Index 1.** 01-212 female flush short (Option 1)
- Index 2.** 01-211 male flush short (Option 1)
- Index 3.** 17SF50 female sliding termination
- Index 4.** 17S50 male sliding termination (Option 1)
- Index 5.** 34ASF50-2 female adapter (2)
- Index 6.** Calibration software diskette
- Index 7.** 33FSF50 female-female adapter (2)*
- Index 8.** 33SS50 male-male adapter*
- Index 9.** 28S50-2 B male termination (2)
- Index 10.** 28SF50-2 broadband female termination (2)
- Index 11.** 33SSF50-male-female adapter (2)*
- Index 12.** 24S50 male open
- Index 13.** 23SF50 female open
- Index 14.** 23S50 male short
- Index 15.** 23SF50 female short
- Index 16.** 34AS50-2 male adapter (2)
- Index 17.** Connector thumb wheel (4)
- Index 18.** 01-201 torque wrench
- Index 19.** 01-210 reference flat
- Index 20.** 01-222 pin depth gauge
- Index 21.** 01-223 pin depth gauge

* Phase Equal Adapters

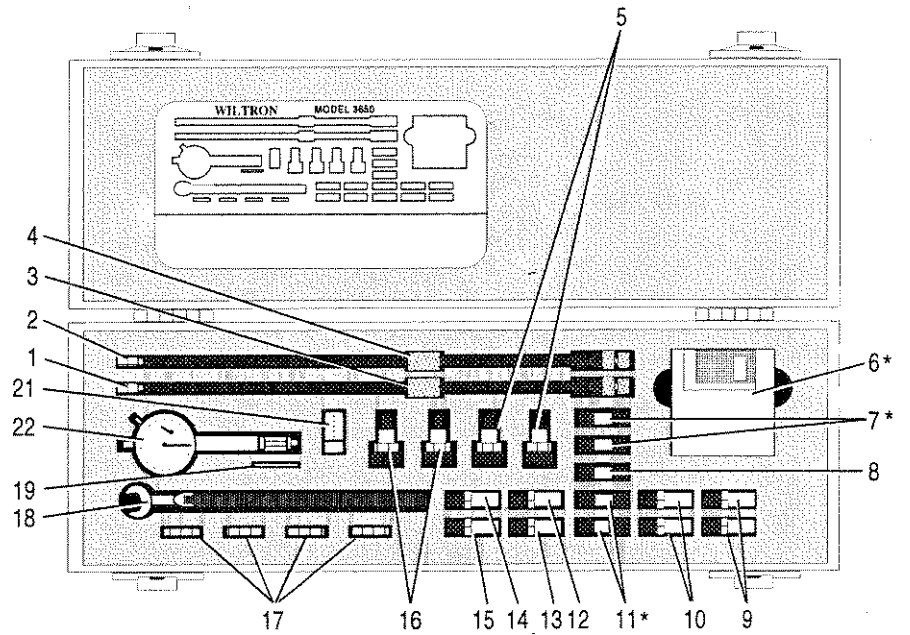

Figure 12-1. Model 3650 (SMA/3.5 mm) Calibration Kit Components

* Phase Equal

***Model 3651
Calibration
Kit***

The GPC-7 kit (Figure 12-3) includes in the following items:

- Index 1.** 01-221 collects and extract tools
- Index 2.** 28A50-2 broadband termination (2)
- Index 3.** 24A50 open
- Index 4.** 23A50 short
- Index 5.** Calibration software diskette
- Index 6.** 17A50 sliding termination (Option 1)
- Index 7.** 01-200 torque wrench
- Index 8.** 01-210 reference flat
- Index 9.** 01-220 pin depth gauge

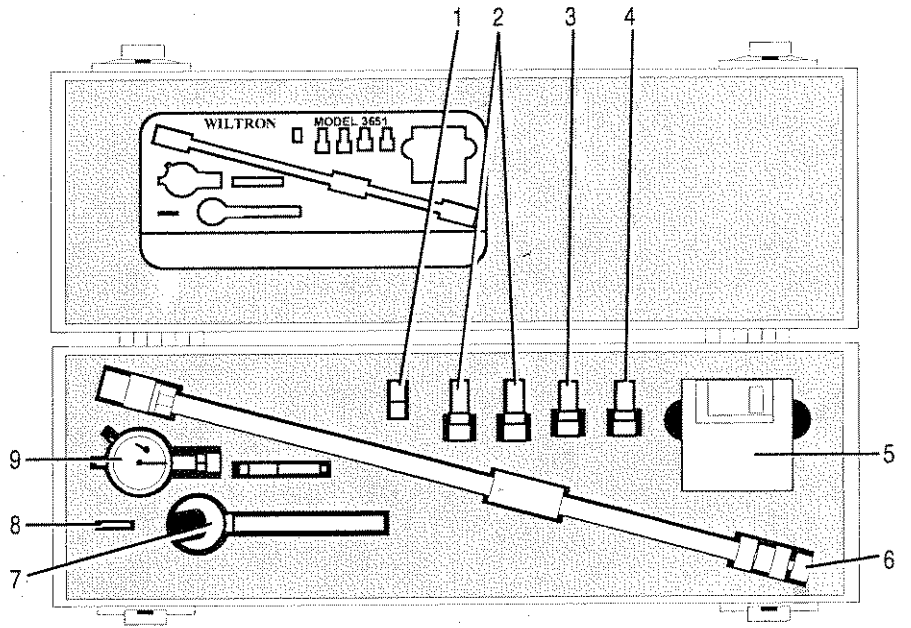

Figure 12-2. Model 3651 (GPC-7) Calibration Kit Components

**Model 3652
Calibration
Kit**

The K Connector kit (Figure 12-3) includes in the following items:

- Index 1.** 01-212 female flush short (Option 1)
- Index 2.** 01-211 male flush short (Option 1)
- Index 3.** 17KF50 female sliding termination
- Index 4.** 17K50 male sliding termination (Option 1)
- Index 5.** 34AKF50-2 female adapter (2)
- Index 6.** Calibration software diskette
- Index 7.** 33FKF50 female-female adapter (2)*
- Index 8.** 33KK50 male-male adapter*
- Index 9.** 28K50-2 male termination (2)
- Index 10.** 28KF50-2 broadband female termination (2)
- Index 11.** 33KKF50-male-female adapter (2)*
- Index 12.** 24K50 male open
- Index 13.** 23KF50 female open
- Index 14.** 23K50 male short
- Index 15.** 23KF50 female short
- Index 16.** 34AK50-2 male adapter (2)
- Index 17.** Connector thumb wheel (4)
- Index 18.** 01-201 torque wrench
- Index 19.** 01-210 reference flat
- Index 20.** 01-222 pin depth gauge
- Index 21.** 01-223 pin depth gauge

* Phase Equal Adapters

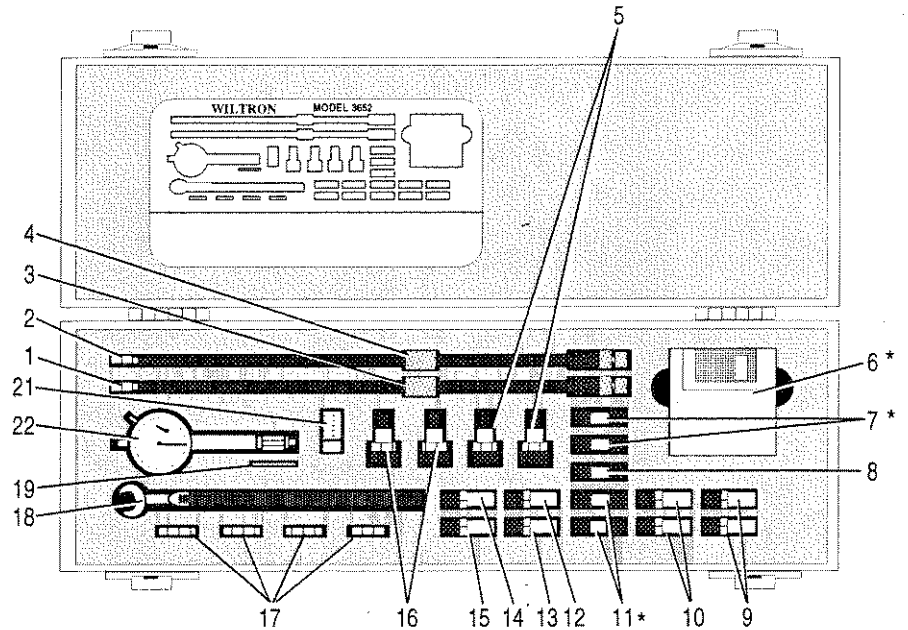

Figure 12-3. Model 3652 (K Connector) Calibration Kit Components

**Model 3653
Calibration
Kit**

The Type N kit (Figure 12-4) includes in the following items:

- Index 1.** 28N50-2 broadband male termination (2)
- Index 2.** 34AN50-2 male adapter (2)
- Index 3.** Calibration software diskette
- Index 4.** 34ANF50-2 female adapter (2)
- Index 5.** 28NF50-2 Broadband female termination (2)
- Index 6.** 24NF50 female open
- Index 7.** 24N50 male open
- Index 8.** 23NF50 female short
- Index 9.** 23N50 male short
- Index 10.** 01-213 reference gauge
- Index 11.** 01-224 pin depth gauge

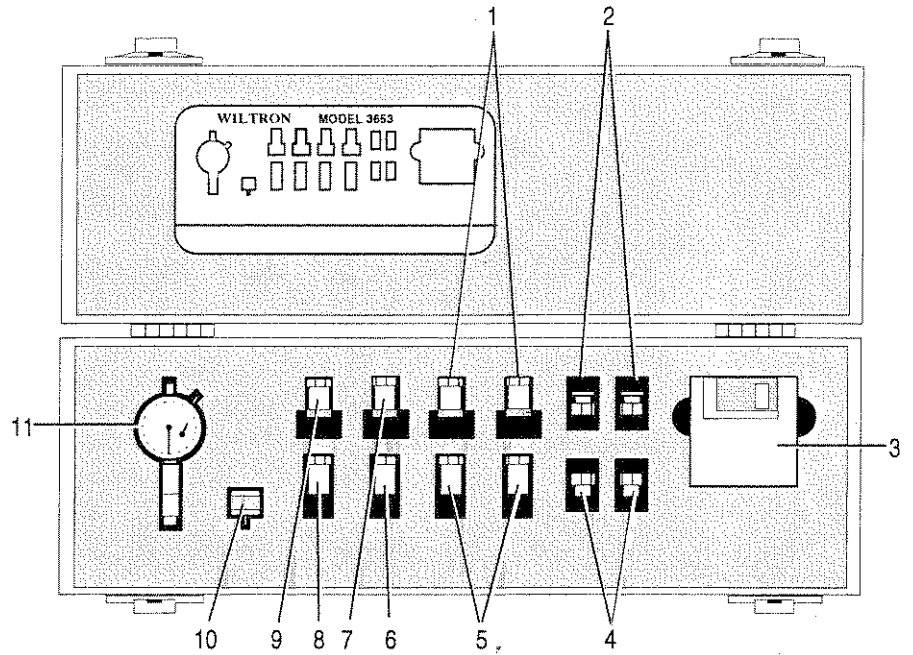

Figure 12-4. Model 3653 (Type N) calibration kit Components

**Model 3654/
3654B Cali-
bration Kit**

The V Connector kit (Figure 12-5) includes in the following items:

- Index 1.** 17VF50B female sliding termination
- Index 2.** 17V50B male sliding termination
- Index 3.** 33VVF50 male-female adapter (2)
- Index 4.** Calibration software, 2360-54B
- Index 5.** 28V50B male broadband termination (2)
- Index 6.** 28VF50B female broadband termination (2)
- Index 7.** 24V50B male open
- Index 8.** 24VF50B female open
- Index 9.** 23V50B-5.1 male short 5.1mm
- Index 10.** 23VF50B-5.1 female short 5.1mm
- Index 11.** 33VV50 male-male adapter
- Index 12.** 33VFVF50 female-female adapter (2)
- Index 13.** Connector thumb wheel (4)
- Index 14.** 01-201 torque wrench
- Index 15.** 01-323 female adapter for pin gauge
- Index 16.** 01-322 pin depth gauge
- Index 17.** 01-210 reference flat
- Index 18.** 01-204 adapter wrench
- Index 19.** 01-312 male flush short
- Index 20.** 01-311 female flush short

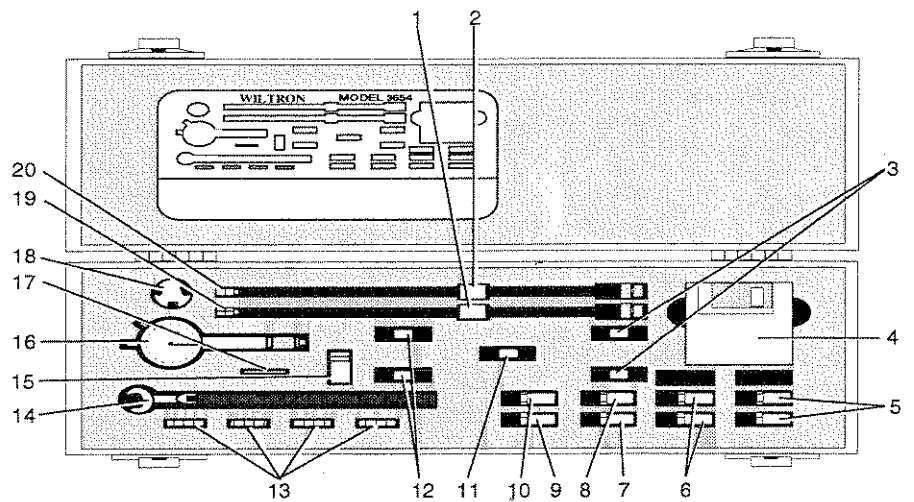

Figure 12-5. Model 3654 (V Connector) Calibration Kit Components

**Model 36550
Calibration
Kit**

The 3.5 mm kit (Figure 12-6) includes the following items:

- Index 1.** 3.5mm 28LF50B Female 50 Ω Termination
- Index 2.** 3.5mm 28LF50B Female 50 Ω Termination
- Index 3.** 3.5mm 28L50B Male 50 Ω Termination
- Index 4.** 3.5mm 28L50B Male 50 Ω Termination
- Index 5.** 3.5mm 23L50 Male Short
- Index 6.** 3.5mm 23LF50 Female Short
- Index 7.** 3.5mm 24L50 Male Open
- Index 8.** 3.5mm 24LF50 Female Open
- Index 9.** 3.5mm 33LFLF50 Female-Female Phase-Equal Insertable
- Index 10.** 3.5mm 33LFLF50 Female-Female Phase-Equal Insertable
- Index 11.** 3.5mm 33LLF50 Male-Female Phase-Equal Insertable
- Index 12.** 3.5mm 33LLF50 Male-Female Phase-Equal Insertable
- Index 13.** 3.5mm 33LL50 Male-Male Phase-Equal Insertable
- Index 14.** 01-201 Wrench

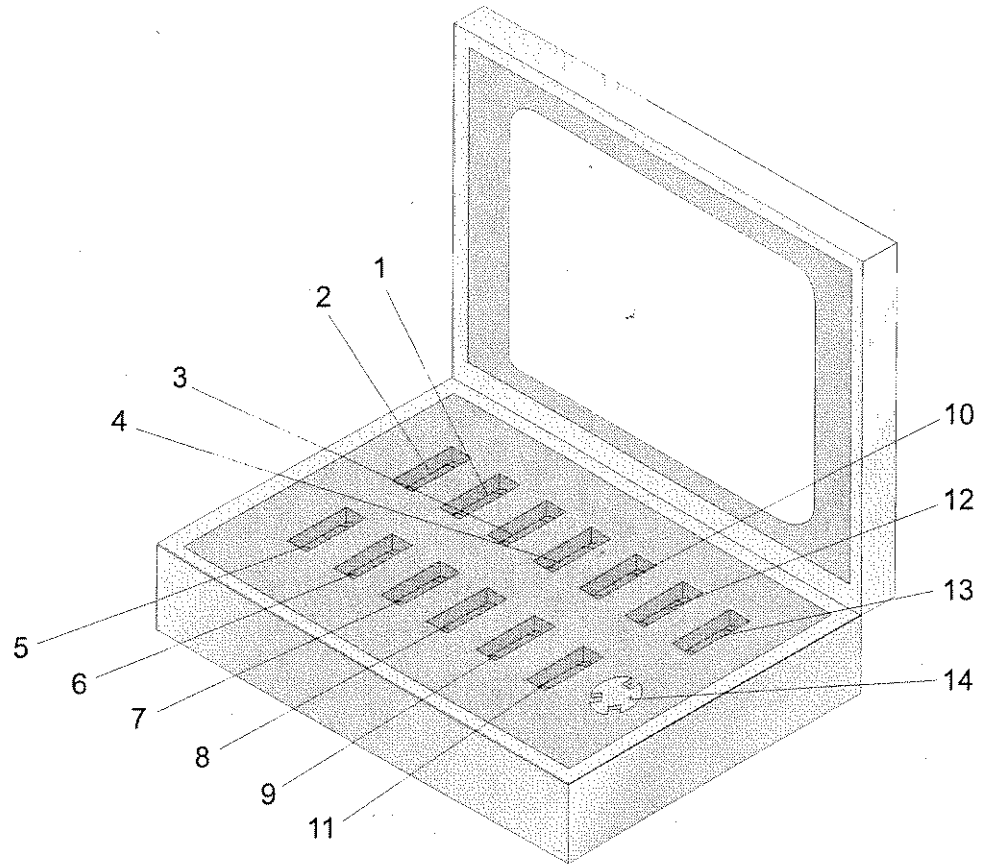

Figure 12-6. Model 36550 3.5mm Calibration Kit

**Model 36552
Calibration
Kit**

The K Connector kit (Figure 12-7) includes in the following items:

- Index 1.** 28KF50B K Connector Female Termination
- Index 2.** 28KF50B K Connector Female Termination
- Index 3.** 28K50B K Connector Male Termination
- Index 4.** 28K50B K Connector Male Termination
- Index 5.** 28K50B K Connector Male Termination
- Index 6.** 23K50 K Connector Male Short
- Index 7.** 23KF50 K Connector Female Short
- Index 8.** 24K50 K Connector Male Open
- Index 9.** 24KF50 K Connector Female Open
- Index 10.** 33KFKF50C K Connector Female-Female Phase-Equal Insertable
- Index 11.** 33KFKF50C K Connector Female-Female Phase-Equal Insertable
- Index 12.** 33KKF50C K Connector Male-Female Phase-Equal Insertable
- Index 13.** 33KKF50C K Connector Male-Female Phase-Equal Insertable
- Index 14.** 01-201 Wrench

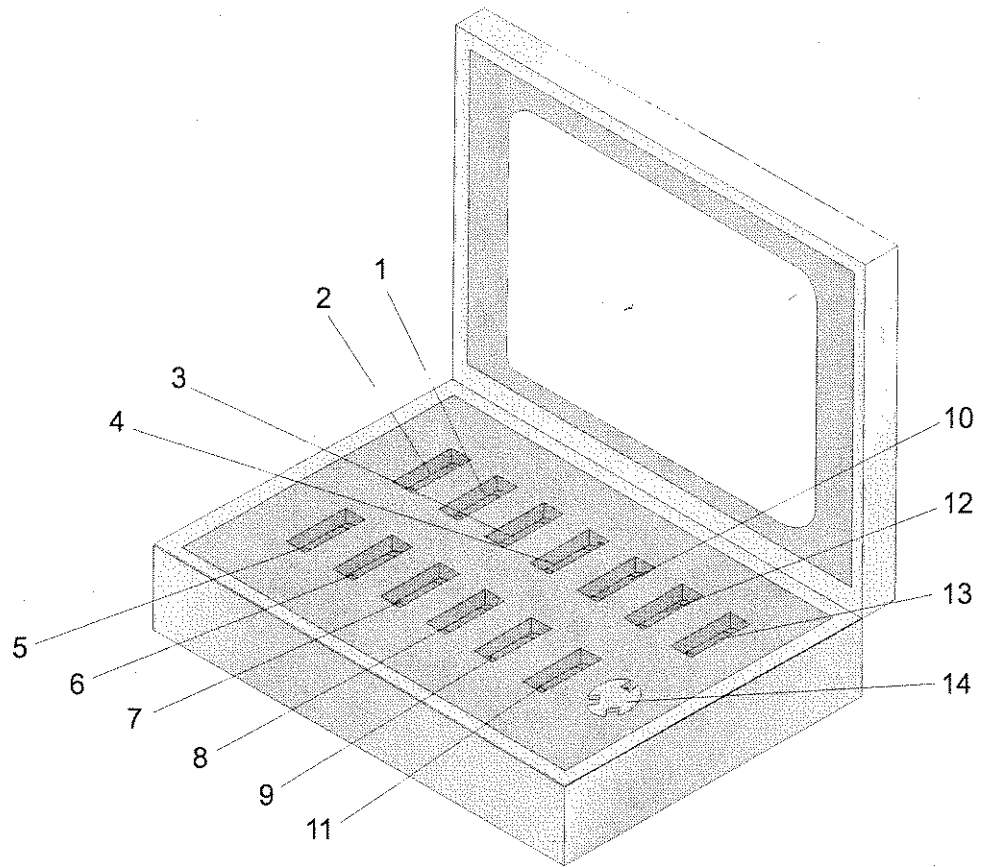

Figure 12-7. Model 36552 K Connector Calibration Kit

**12-4 PRECAUTIONS FOR
USING CONNECTORS**

The following are precautionary notes related to the use of connectors. For specific information on setting pin depths on sliding terminations, refer to the 373XXA Operation Manual, Chapter 7.

Pin Depth

Before mating, measure the pin depth (Figure 12-9) of the device that will mate with the RF component, using a ANRITSU Pin Depth Gauge or equivalent (Figure 12-10). Based on RF components returned for repair, destructive pin depth of mating connectors is the major cause of failure in the field. When an RF component is mated with a connector having a destructive pin depth, damage will likely occur to the RF component connector. (A destructive pin depth has a center pin that is too long in respect to the connector's reference plane.)

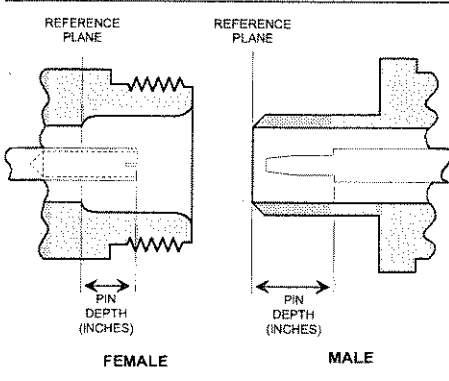

Figure 12-8. N Connector Pin Depth

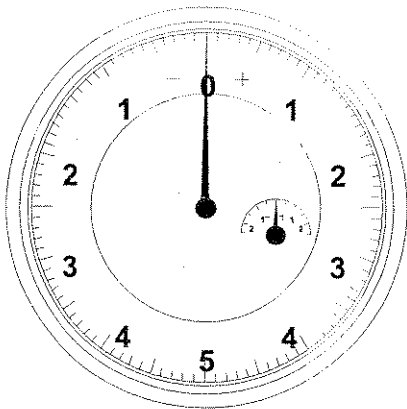

Figure 12-9. Pin Depth Gauge

***Pin Depth
Tolerance***

The center pin of RF component connectors has a precision tolerance measured in mils (1/1000 inch). Connectors on test devices that mate with RF components may not be precision types and may not have the proper depth. They must be measured before mating to ensure suitability. When gauging pin depth, if the test device connector measures out of tolerance (Table 12-1) in the “+” region of the gauge (Figure 12-9), the center pin is too long. Mating under this condition will likely damage the termination connector. On the other hand, if the test device connector measures out of tolerance in the “-” region, the center pin is too short. While this will not cause any damage, it will result in a poor connection and a consequent degradation in performance.

Table 12-1. *Pin Depth Tolerances*

Port/Connector Type	Pin Depth (mils)	ANRITSU Gauge Setting
GPC 7	+0.000 to -0.003	Same as pin depth
N Male	.207 +0.003 -0.003	Same as pin depth
N Female		
WSMA Male	-0.0025 -0.0035	Same as pin depth
WSMA Male		
K Male	+0.000 to -0.003	Same as pin depth
K Female		
V Male	+0.000 to -0.001	Same as pin depth
V Female	+0.000 to -0.001	

Over Torquing Connectors

Over torquing connectors is destructive; it may damage the connector center pin. Finger-tight is usually sufficient, especially on Type N connectors. *Never* use pliers to tighten connectors.

Teflon Tuning Washers

The center conductor on most RF components contains a small teflon tuning washer located near the point of mating (interface). This washer compensates for minor impedance discontinuities at the interface. The washer's location is critical to the RF component's performance. *Do not disturb it.*

Mechanical Shock

RF components are designed to withstand years of normal bench handling. However, do not drop or otherwise treat them roughly. They are laboratory-quality devices, and like other such devices, they require careful handling.

**12-5 CLEANING
INSTRUCTIONS**

Connector interfaces — especially the outer conductors on the GPC 7 and SMA connectors — should be kept clean and free of dirt and other debris.

Denatured alcohol is the recommended applicator. Figure 12-10 illustrates cleaning male and female connectors.

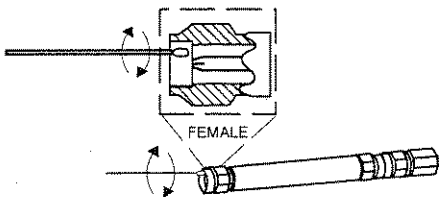
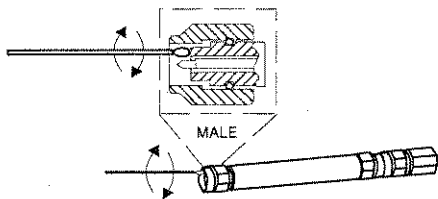
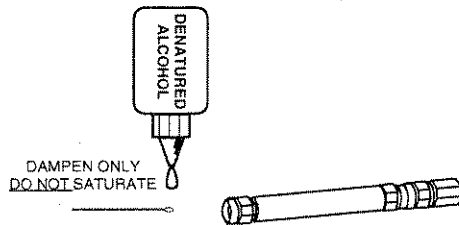

NOTE

Most cotton swabs are too large to fit in the smaller connector types. It is necessary to peel off most of the cotton and then twist the remaining cotton tight. Be sure that the remaining cotton does not get stuck in the connector.

The following are some important tips on cleaning connectors:

- Use only denatured alcohol as a solvent.
- Always use an appropriate size of cotton swab.
- Gently move the cotton swab around the center conductor.
- Never put lateral pressure on the connector's center pin.
- Verify that no cotton or other foreign material remains in the connector after cleaning.
- Only dampen the cotton swab. Do NOT saturate it.
- Compressed air can be used to remove foreign particles and to dry the connector.
- Verify that the center pin has not been bent or damaged.

Figure 12-11 illustrates how to clean connectors.

Figure 12-10. Cleaning Male and Female Connectors

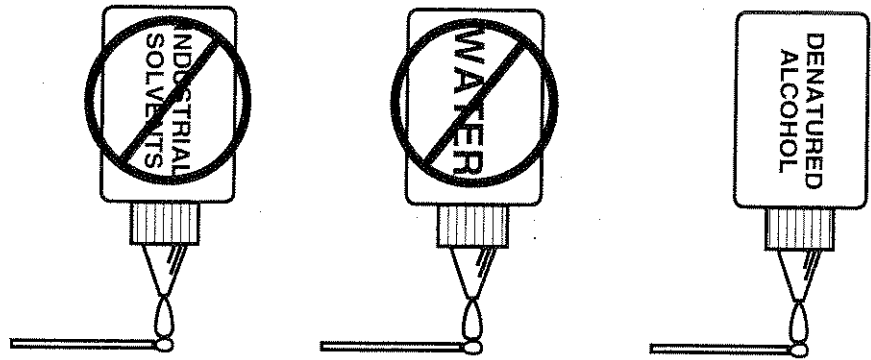

Do NOT use Industrial Solvents or Water on connector. Use only Denatured Alcohol.

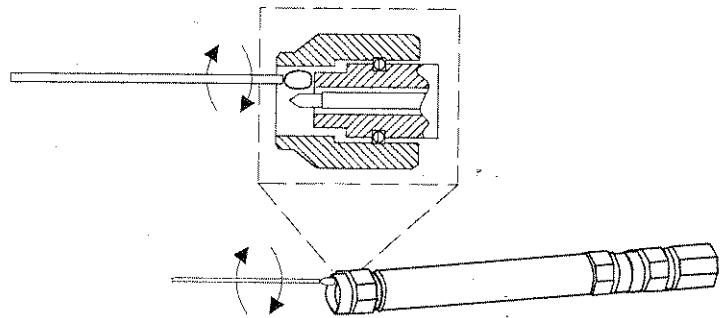

Use only denatured alcohol and the proper size of cotton swab. Gently rotate the swab around the center pin being careful not to stress or bend the pin or you will damage the connector.

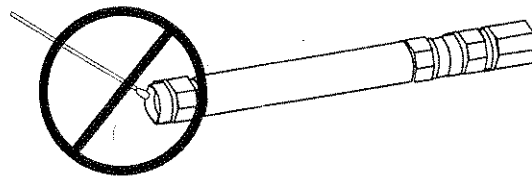

Do NOT put cotton swabs in at an angle, or you will damage the connectors.

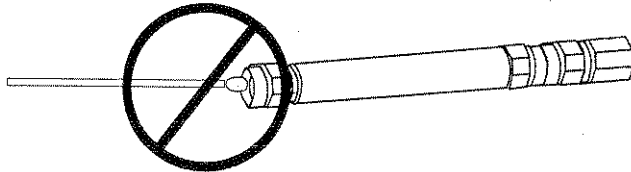

Do NOT use too large of cotton swab, or you will damage the connectors.

Figure 12-11. How to Clean Connectors

Appendix A

Front Panel Menus,

Alphabetical Listing

Contents

Menu ACAL, AutoCal Menu	A-10
Menu ACAL_SETUP, AutoCal Setup Menu	A-11
Menu ACAL_S11 1 PORT, AutoCal S11 1 Port Menu	A-12
Menu ACAL_S22 1 PORT, AutoCal S22 1 Port Menu	A-12
Menu ACAL_FULL, AutoCal Full Menu	A-13
Menu ACAL_AR, AutoCal Adapter Removal Menu	A-14
Menu ACAL_UTILS, AutoCal Utilities Menu	A-15
Menu ACAL_CHAR, AutoCal Characterization Menu	A-16
Menu APPS, Applications Menu	A-17
Menu BW1 or CAL_BW1, Select Video Bandwidth	A-18
Menu C1, Select Calibration Data Points	A-19
Menu C2, Frequency Range of Calibration (Start/Stop)	A-20
Menu C2_CENTER, Frequency Range of Calibration (Center/Span)	A-21
Menu C2A, Insert Individual Frequencies	A-22
Menu C2C, Calibration Range—Harmonic Cal for Time Domain	A-23
Menu C2B, Single Point Calibration	A-23
Menu C2D, Fill Frequency Ranges	A-24
Menu C3, Confirm Calibration Parameters	A-25
Menu C3A, Confirm Calibration Parameters	A-26
Menu C3B, Confirm Calibration Parameters	A-27
Menu C3C, Confirm Calibration Parameters	A-28
Menu C3D, Confirm Calibration Parameters	A-29
Menu C3E, Confirm Calibration Parameters	A-30
Menu C3F, Confirm Calibration Parameters	A-31

Menu C3G, Confirm Calibration Parameters	A-32
Menu C3H, Confirm Calibration Parameters	A-33
Menu C3I, Confirm Calibration Parameter 2	A-34
Menu C3J, Confirm Calibration Parameter 3	A-35
Menu C4_P1/C4_P2, Select Connector Type	A-36
Menu C4A_P1/C4A_P2, Select Connector Type	A-37
Menu C5, Select Calibration Type	A-38
Menu C5A, Select 1 Path 2 Port Calibration Type	A-39
Menu C5B, Select Transmission Freq Response Calibration Type	A-39
Menu C5C, Select Reflection Only Calibration Type	A-40
Menu C5D, Select Use of Isolation	A-40
Menu C6, Select Load Type	A-41
Menu C6A, Enter Broadband Load Impedance	A-41
Menu C7-Series, Begin Calibration Sequence	A-42
Menu C8, Slide Load to Position X	A-42
Menu C9A, Connect Device 1, Line	A-43
Menu C9, Connect Throughline	A-43
Menu C9C, Connect Device 2, Line	A-44
Menu C9B, Connect Device 2, Line/Lowband	A-44
Menu C11, Begin Calibration	A-45
Menu C11A, Select Calibration Method	A-46
Menu C12_P1/C12_P2, Enter the Capacitance Coefficients for Open Devices	A-47
Menu C12A_P1/C12A_P2, Enter the Offset Length	A-48
Menu C13, Set Reflection Pairing Menu	A-49
Menu C14, Enter Offset Lengths (Shorts)	A-50
Menu C15, Select Waveguide Kit to Use	A-51
Menu C15A, Enter Waveguide Parameters	A-52
Menu C15B, Enter Waveguide Parameters	A-52
Menu C16A, Enter Microstrip Parameters	A-53
Menu C16, Select Microstrip Parameters	A-53
Menu C17, Enter Line Impedance	A-54
Menu C18, Change LRL/LRM Parameters	A-54
Menu C18A, Change LRL/LRM Parameters	A-55

MENUS

ALPHABETICAL LISTING

Menu C18B, Change LRL/LRM Parameters—Two Band Calibration.	A-56
Menu C19, Change LRL/LRM Parameters	A-57
Menu C20, Change Through Parameters.	A-58
Menu Cal_Completed	A-58
Menu Cal_Applied	A-59
Menu Cal_EM, Enhancement Menu for Calibration.	A-60
Menu CAR1, Adapter Removal 1	A-61
Menu CAR2, Adapter Removal 2	A-61
Menu EXT_CAR, Adapter Removal Help Menu	A-62
Menu CAR3, Adapter Removal 3	A-63
Menu CAR4, Adapter Removal 4	A-63
Menu CM, Select Display Mode.	A-64
Menu DF1, Discrete Fill	A-65
Menu DF2, Insert Individual Frequencies	A-66
Menu DFLT, Default Program Selected.	A-67
Menu DG1, Diagnostics 1	A-68
Menu DG3, Diagnostics 3	A-69
Menu DG2, Troubleshooting.	A-69
Menu DSK_HD, Hard Disk Utilities	A-70
Menu DSK_FD, Floppy Disk Utilities	A-70
Menu DSK2, Select File to Read	A-71
Menu DSK3, Select File to Overwrite.	A-72
Menu DSK6, Type of Files to Delete	A-73
Menu DSK7, Select File to Delete.	A-74
Menu DSK8, Type of Files to Copy	A-75
Menu DSK9, Select File to Copy	A-76
Menu DSK10, Capture Tabular Data	A-76
Menu DSK11, Format Floppy Disk	A-77
Menu DSK12, Format Hard Disk	A-77
Menu EM, Enhancement Menu	A-78
Menu GC1, Swept Frequency Gain Compression	A-79
Menu EXT_GC1, Gain Compression Help Menu 1	A-80
Menu GC2, Swept Power Gain Compression 1	A-81

MENUS
ALPHABETICAL LISTING

Menu EXT_GC2, Gain Compression Help Menu 2	A-82
Menu GC3, Swept Power Gain Compression 2	A-83
Menu EXT_GC3, Gain Compression Help Menu 3	A-84
Menu GC4, Multiple Frequency Gain Compression 1	A-85
Menu GC4_ABORT, Multiple Frequency Gain Compression 2	A-85
Menu EXT_GC4, Gain Compression Help Menu 4	A-86
Menu GC_DF2, Swept Power Frequencies	A-87
Menu EXT_GC_DF2, Gain Compression Help Menu 5	A-88
Menu GC_SU2, Swept Power Gain Compression 2	A-88
Menu GC_SU8A, Calibrate for Linear Power	A-89
Menu GC_SU8A-ABORT, Abort Calibrate for Linear Power	A-89
Menu EXT_GC_SU8A, Gain Compression Help Menu 6	A-90
Menu GC_RCVR, Receiver Calibration	A-91
Menu GC_NORM, Normalize S21.	A-92
Menu GP5, Select Name.	A-93
Menu GP7, Display GPIB Status	A-94
Menu GT1/CAL_GT1, Select Graph Type.	A-95
Menu GT2/CAL_GT2, Select Graph Type.	A-96
Menu L1, Set Limits—Magnitude and Phase	A-97
Menu L2, Set Limits—Linear Polar.	A-98
Menu L3, Set Limits—Linear Polar/Smith Chart	A-99
Menu L4, Set Limits—Log Magnitude	A-100
Menu L5, Set Limits—Phase.	A-101
Menu L6, Set Limits—Log Polar.	A-102
Menu L7, Set Limits—Group Delay	A-103
Menu L8, Set Limits—Linear Magnitude	A-104
Menu L9, Set Limits—Linear Magnitude and Phase	A-105
Menu L10, Set Limits—Real Values	A-106
Menu L11, Set Limits—Imaginary Values	A-107
Menu L12, Set Limits—Real and Imaginary Values	A-108
Menu L13, Set Limits—SWR	A-109
Menu L14, Set Limits—Power Out	A-110
Menu LD1, Define Upper Limit Segment	A-111

MENUS

ALPHABETICAL LISTING

Menu LD2, Define Lower Limit Segment	A-112
Menu LF1, Set Limit Frequencies—Log Mag	A-113
Menu LF2, Set Limit Frequencies—Phase	A-114
Menu LF3, Set Limit Frequencies—Group Delay	A-115
Menu LF4, Set Limit Frequencies—Linear Mag	A-116
Menu LF5, Set Limit Frequencies—SWR	A-117
Menu LF6, Set Limit Frequencies—Real	A-118
Menu LF7, Set Limit Frequencies—Imaginary	A-119
Menu LF8, Set Limit Frequencies—Power Out	A-120
Menu LSX, Segmented Limits	A-121
Menu LTST, Test Limits	A-122
Menu M1, Set Markers	A-123
Menu M2, Select Δ REF Marker	A-124
Menu M3, Select Readout Marker	A-125
Menu M4, Readout Marker	A-126
Menu M5, Set Δ REF Marker Readout	A-127
Menu M6, Marker X All Displayed Channels	A-128
Menu M7, Search	A-129
Menu M8, Filter Parameters	A-130
Menu M8A, Filter Setup	A-131
Menu M9, Marker Readout Functions	A-132
Menu MMW1, Millimeter Wave Test Set Band	A-133
Menu MMW2, Millimeter Wave Test Set Modules	A-134
Menu MMW3, Millimeter Wave Test Set	A-135
Menu MMW4, mm Wave Band	A-136
Menu EXT_MMW4	A-137
Menu NO1, Trace Memory Functions	A-138
Menu NO2, Select Trace Math	A-139
Menu NO3, Trace Memory Disk Functions	A-139
Menu OM1, Multiple Source Control Menu	A-140
Menu OM1A, Source Lock Polarity Menu	A-141
Menu OM2, Define Bands Menu	A-142
Menu OM3, Edit System Equations	A-143

MENUS
ALPHABETICAL LISTING

Menu OPTNS, Select Options	A-144
Menu ORP1, Rear Panel Output Control	A-145
Menu ORP2, Select Output Mode	A-146
Menu OTS1, Test Set Configuration	A-146
Menu OTS2, Warning	A-147
Menu PC1, Select Polar Chart Mode	A-148
Menu PD1, Parameter Definition 1	A-149
Menu PD2, Parameter Ratio	A-150
Menu PD3, Parameter Definition 2	A-151
Menu PL1, Plot Options	A-152
Menu PL2, Select Plot Size	A-153
Menu PL3, Select Pen Colors	A-154
Menu PM1, Select Data Output Type	A-155
Menu PM2, Data Output Headers	A-156
Menu PM2A, Data Output Headers	A-157
Menu PM3, Tabular Printer Output Format	A-158
Menu PM3A, Graphical Printer Output Format	A-159
Menu PM4, Disk Output Operations	A-160
Menu PM4A, Disk File Options	A-161
Menu PM5, Printer Type, Options	A-162
Menu RCV1, Receiver Mode	A-163
Menu RCV1_WARN, Standard Receiver Mode Warning	A-163
Menu RCV2, User Defined Receiver Mode Menu	A-164
Menu RCV2_WARN, User Defined Receiver Mode Warning	A-165
Menu RCV3, Standard Receiver Mode Warning Menu	A-166
Menu RCV4, User Defined Receiver Mode Warning Menu	A-167
Menu RD1, Set Reference Delay	A-168
Menu RD2, Set Dielectric Constant	A-169
Menu SC, Source Configure	A-170
Menu SP, Select S Parameter	A-171
Menu SR1, Save/Recall Front Panel Information	A-172
Menu SR2, Recall or Save	A-173
Menu SR3, Save to Internal memory	A-174

MENUS

ALPHABETICAL LISTING

Menu SS1 or CAL_SS1, Set Scaling 1	A-175
Menu SS2 or CAL_SS2, Set Scaling 2	A-176
Menu SS3Z/SS3Y or CAL_SS3Z/CALSS3Y, Set Scaling 3	A-177
Menu SS4 or CAL_SS4, Set Scaling 4	A-178
Menu SS5 or CAL_SS5, Set Scaling 5	A-179
Menu SS6 or CAL_SS6, Set Scaling 6	A-180
Menu SS7 or CAL_SS7, Set Scaling 7	A-181
Menu SS8 or CAL_SS8, Set Scaling 8	A-182
Menu SS9 or CAL_SS9, Set Scaling 9	A-183
Menu SS10 or CAL_SS10, Set Scaling 10	A-184
Menu SS11 or CAL_SS11, Set Scaling 11	A-185
Menu SS12 or CAL_SS12, Set Scaling 12	A-186
Menu SS13 or CAL_SS13, Set Scaling 13	A-187
Menu SS14, Set Scaling 14	A-188
Menu SU1, Sweep Setup 1	A-189
Menu SU1_CENTER, Sweep Setup 1	A-190
Menu SU2 or CAL_SU2, Sweep Setup 2	A-191
Menu SU2A or CAL_SU2A, Sweep Setup 2A	A-192
Menu SU3, Single-Point Measurement Setup	A-193
Menu SU3A, Swept-Power Measurement Setup	A-194
Menu SU4, Select Function for Hold Button	A-195
Menu SU5, Frequency Marker Sweep	A-196
Menu SU6, Frequency Marker C.W.	A-197
Menu SU8 or CAL_SU8, Calibrate For Flat Test Port Power	A-198
Text Associated With Flat Power Calibration Menu SU8.	A-199
Menu SU9, Number of Data Points	A-200
Menu SU9A, Number of Data Points 2	A-201
Menu TD1, Domain (Frequency/Display)	A-202
Menu TD2_LP_TIME, Lowpass Time Domain Setup	A-203
Menu TD2_LP_DIST, Lowpass Distance Display Setup	A-204
Menu TD2_BP_TIME, Bandpass Time Domain Setup	A-205
Menu TD2_BP_DIST, Bandpass Distance Display Setup	A-206
Menu TD3_BP, Bandpass Time Domain Setup	A-207

MENUS
ALPHABETICAL LISTING

Menu TD3_LP, Lowpass Time Domain Setup	A-207
Menu TD4_TIME & TD4_DIST, Gate (Distance/Time)	A-208
Menu TD5_WINDOW, Shape	A-209
Menu TD5_GATE, Shape.	A-209
Menu TD6, Set D.C. Term for Low Pass Processing	A-210
Menu TD7_TIME, Time Marker Sweep.	A-211
Menu TD7_DIST, Distance Marker Range	A-212
Menu TRIG, Triggers Measurement.	A-213
Menu U1, Utility Menu.	A-214
Menu U2, Display Instrument State	A-215
Menu U3, Calibration Component Utilities	A-217
Menu U4, Display Installed Calibration Components Information 1	A-218
Menu U4A, Display Installed Calibration Components Information 2 . . .	A-219
Menu U5, Color Configuration.	A-220
Menu U6, Set Date/Time	A-221

Appendix A

Front Panel Menus,

Alphabetical Listing

A-1 INTRODUCTION

This appendix provide description for all menu choices. Menus are arranged in alphabetical order by call sign (C1, SU2, DSK1, etc).

A-2 MENUS

A listing of all of the menus contained in this appendix is provided in the contents section at the beginning of this appendix. This listing gives the call sign, name, and page number of the menus.

MENU	DESCRIPTION
AUTOCAL	
AUTOCAL TYPE XXXXXXXX	Indicates the current type of AutoCal setup.
CHANGE AUTOCAL SETUP	Calls Menu ACAL_SETUP, which lets you change the AutoCal setup.
START AUTOCAL	Calls Menu CAL_SEQ, which starts the AutoCal calibration sequencing immediately using the current AutoCal setup.
THRU UPDATE	
CONNECT THROUGH LINE BETWEEN PORTS 1 AND 2	Instruction for connecting the AutoCal to the VNA for Thru Update.
THRU TYPE CALIBRATOR/TRUE	Switch between the Thru in the AutoCal module (CALIBRATOR) and your own port-to-port Thru (TRUE) to be use in the Thru Update (default CALIBRATOR).
NUMBER OF AVGS XXX	Enter the number of averages to be used during the Thru Update process (default 4 averages).
START THRU UPDATE	Calls Menu CAL_SEQ, which starts the Thru calibration update.
PRESS <ENTER> TO SELECT OR SWITCH	Press the Enter key to select or switch.

Menu ACAL, AutoCal Menu

MENUS
ALPHABETICAL LISTING

A

MENU	DESCRIPTION
AUTOCAL SETUP	
LINE TYPE COAXIAL/WAVEGUIDE	Switch between the line type used with the AutoCal module.
WAVEGUIDE CUTOFF XX.XXXXXX GHz	Enter the Waveguide Cutoff frequency if the Waveguide Line Type is selected.
SWITCH AVERAGING XXXX	Enter an appropriate amount of SWITCH AVERAGING (recommend 4 for the electronic modules, and 16 for the electromechanical modules).
NUMBER OF AVGS	
REFLECTION XXXX	Enter the number of averages to be used with the reflection standards in the AutoCal module (default 10 averages).
LOAD XXXX	Enter the number of averages to be used with the load standard in the AutoCal module (default 10 averages).
THRU XXXX	Enter the number of averages to be used with the thru standard (default 4 averages).
ISOLATION XXXX	Enter the number of averages to be used with the isolation standard in the AutoCal module (default 32 averages).
AUTOCAL TYPES	Select the type of AutoCal calibration to perform.
S11 1 PORT	Calls menu ACAL_S11, for more setup.
S22 1 PORT	Calls menu ACAL_S22, for more setup.
FULL 2 PORT	Calls menu ACAL_FULL, for more setup.
ADAPTER REMOVAL	Calls menu ACAL_AR, for more setup.

Menu ACAL_SETUP, AutoCal Setup Menu

MENU	DESCRIPTION
<p style="text-align: center;">AUTOCAL S11 1 PORT</p> <p>PORT 1 CONNECTION LEFT/RIGHT</p> <p>START AUTOCAL</p> <p style="text-align: center;">PRESS <ENTER> TO SELECT OR SWITCH</p>	<p>Switch between the side of the AutoCal module which is connected to Port 1 (default LEFT).</p> <p>Calls Menu CAL_SEQ, which starts the AutoCal calibration sequencing.</p> <p>Press the Enter key to select or switch.</p>

Menu ACAL_S11 1 PORT, AutoCal S11 1 Port Menu

MENU	DESCRIPTION
<p style="text-align: center;">AUTOCAL S22 1 PORT</p> <p>PORT 2 CONNECTION LEFT/RIGHT</p> <p>START AUTOCAL</p> <p style="text-align: center;">PRESS <ENTER> TO SELECT OR SWITCH</p>	<p>Switch between the side of the AutoCal module which is connected to Port 2 (default RIGHT).</p> <p>Calls Menu CAL_SEQ, which starts the AutoCal calibration sequencing.</p> <p>Press the Enter key to select or switch.</p>

Menu ACAL_S22 1 PORT, AutoCal S22 1 Port Menu

MENU	DESCRIPTION
<p>AUTOCAL FULL 2 PORTS</p>	
<p>ISOLATION AVERAGING</p>	
<p>OMIT</p>	<p>Select to omit the isolation step.</p>
<p>DEFAULT</p>	<p>Select to use the Default value during the isolation step.</p>
<p>AVERAGING FACTOR XXXX</p>	<p>Select for user defined averaging factor during the isolation step.</p>
<p>THRU TYPE CALIBRATION/TRUE</p>	<p>Switch between the Thru in the AutoCal module (CALIBRATOR) and your own port-to-port Thru (TRUE) to be use in the Thru Update (default CALIBRATOR).</p>
<p>PORT CONFIG L=1, R=2 R=1, L=2</p>	<p>Switch between the side of the AutoCal module which is connected to Port 1 and Port 2 (default LEFT connected to Port 1, RIGHT connected to Port 2).</p>
<p>START AUTOCAL</p>	<p>Calls Menu CAL_SEQ, which starts the AutoCal calibration sequencing.</p>

Menu ACAL_FULL, AutoCal Full Menu

MENU	DESCRIPTION
AUTOCAL ADAPTER REMOVAL ISOLATION AVERAGING OMIT DEFAULT AVERAGING FACTOR XXXX PORT CONFIG ADAPT & L=1, R=2 L=1, ADAPT&R=2 ADAPT&R=1, L=2 R=1, ADAPT & L=2 START AUTOCAL PRESS <ENTER> TO SELECT OR SWITCH	 Select to omit the isolation step. Select to use the Default value during the isolation step. Select for user defined averaging factor during the isolation step. Switch between the side of the AutoCal module and adapter which is connected to Port 1 and Port 2 (default LEFT connected to Adapter which is then connected to Port 1, RIGHT connected to Port 2). Calls Menu CAL_SEQ, which starts the AutoCal calibration sequencing. Press the Enter key to select or switch.

Menu ACAL_AR, AutoCal Adapter Removal Menu

MENUS
ALPHABETICAL LISTING

A

MENU	DESCRIPTION
AUTOCAL UTILITIES	
AUTOCAL CHARACTERIZATION	Calls Menu ACAL_CHAR, which lets you set characterization values.
SAVE TO HARD DISK	Saves file to the hard disk.
SAVE TO FLOPPY DISK	Saves file to the floppy disk.
RECALL FROM HARD DISK	Recalls a file from the hard disk.
RECALL FROM FLOPPY DISK	Recalls a file from the floppy disk.
PRESS <ENTER> TO SELECT	Press the Enter key to select.

Menu ACAL_UTILS, AutoCal Utilities Menu

MENU	DESCRIPTION
AUTOCAL CHARACTERIZATION	
SWITCH AVERAGING XXXX	Enter an appropriate amount of SWITCH AVERAGING (recommend 4 for the electronic modules, and 16 for the electromechanical modules).
PORT CONFIG L=1, R=2 R=1, L=2	Switch between the side of the AutoCal module which is connected to Port 1 and Port 2 (default LEFT connected to Port 1, RIGHT connected to Port 2).
NUMBER OF AVGS	
REFLECTION XXXX	Enter the number of averages to be used with the reflection standards in the AutoCal module (default 10 averages).
LOAD XXXX	Enter the number of averages to be used with the load standard in the AutoCal module (default 10 averages).
THRU XXXX	Enter the number of averages to be used with the thru standard (default 4 averages).
ISOLATION XXXX	Enter the number of averages to be used with the isolation standard in the AutoCal module (default 32 averages).
START AUTOCAL CHARACTERIZATION	Calls Menu CAL_SEQ, which starts the AutoCal characterization sequencing.
PRESS <ENTER> TO SELECT OR SWITCH	Press the Enter key to select or switch.

Menu ACAL_CHAR, AutoCal Characterization Menu

MENUS
ALPHABETICAL LISTING

C

MENU	DESCRIPTION
APPLICATIONS ADAPTER REMOVAL SWEPT FREQUENCY GAIN COMPRESSION SWEPT POWER GAIN COMPRESSION PRESS <ENTER> TO SELECT	Calls Menu CAR1, which provides options for removing an adapter. Calls Menu GC1, which provides options for gain compression. Calls Menu GC2, which provides options for gain compression. Pressing the ENTER key implements your selection.

Menu APPS, Applications Menu

MENU	DESCRIPTION
SELECT VIDEO BANDWIDTH	
MAXIMUM (10 kHz)	Selects video bandwidth to be 10 kHz.
NORMAL (1 kHz)	Selects video bandwidth to be 1 kHz.
REDUCED (100 Hz)	Selects video bandwidth to be 100 Hz.
MINIMUM (10 Hz)	Selects video bandwidth to be 10 Hz.
PRESS <ENTER> TO SELECT AND RESUME CAL	Pressing the ENTER key implements your selection. The "AND RESUME CAL" text appears when menu is accessed during calibration.

Menu BW1 or CAL_BW1, Select Video Bandwidth

MENU	DESCRIPTION
<p data-bbox="321 365 505 457">SELECT CALIBRATION DATA POINTS</p> <p data-bbox="261 489 448 581">NORMAL (1601 POINTS MAXIMUM)</p> <p data-bbox="261 613 383 674">C.W. (1 POINT)</p> <p data-bbox="261 705 456 829">N-DISCRETE FREQUENCIES (2 TO 1601 POINTS)</p> <p data-bbox="261 861 440 921">TIME DOMAIN (HARMONIC)</p> <p data-bbox="298 953 521 1014">PRESS <ENTER> TO SELECT</p>	<p data-bbox="646 489 1520 581">Selects the standard calibration from a start to a stop frequency that provides for up to 1601 equally spaced (except the last) points of data for the defined frequency range.</p> <p data-bbox="646 613 1528 674">Selects the single frequency (C.W.) calibration sequence that provides for 1 data point at a selected frequency.</p> <p data-bbox="646 705 1500 766">Selects the discrete frequency calibration mode that lets you input a list of 2 to 1601 individual data point frequencies.</p> <p data-bbox="646 861 1435 890">Selects the calibration mode for low-pass time-domain processing.</p> <p data-bbox="646 953 1268 982">Pressing the ENTER key implements your selection.</p>

Menu C1, Select Calibration Data Points

MENU	DESCRIPTION
FREQUENCY RANGE OF CALIBRATION	
START XXX.XXXXXXXXXXGHZ	Enter the sweep-start frequency for calibration. If you desire, you can change this frequency for your measurement when you reach menu SU1, which follows the final calibration menu. The only restriction is that your start measurement frequency be greater than or equal to your start calibration frequency.
STOP XXX.XXXXXXXXXX GHz	Enter the sweep-stop frequency for calibration. Like the start frequency, this too can be changed for your measurement. The stop frequency must be lower than or equal to your stop calibration frequency. In other words, your measurement frequency span must be equal to or smaller than your calibration frequency span.
SET CENTER/SPAN	Calls Menu C2_CENTER, which lets you enter a center frequency and span range.
XXX DATA POINTS XXX.XXXXXXXXXXGHZ STEPSIZE	The program automatically sets the step size, based on the selected start and stop frequencies. The step size will be the smallest possible (largest number of points up to a maximum of 1601), based on the chosen frequency span.
MAXIMUM NUMBER OF DATA POINT(S)	
1601 MAX PTS 801 MAX PTS 401 MAX PTS 201 MAX PTS 101 MAX PTS 51 MAX PTS	
NEXT CAL STEP	Displays the next menu in the calibration sequence.
PRESS <ENTER> TO SELECT	Pressing the ENTER key implements your menu selection.

Menu C2, Frequency Range of Calibration (Start / Stop)

MENUS
ALPHABETICAL LISTING

C

MENU	DESCRIPTION
<p>CAL FREQ RANGE</p> <p>CENTER XXX.XXXXXXXXXXGHz</p> <p>SPAN XXX.XXXXXXXXXX GHz</p> <p>SET START/STOP</p> <p>XXX DATA POINTS XXX.XXXXXXXXXXGHz STEPSIZE</p> <p>MAXIMUM NUMBER OF DATA POINT(S)</p> <p>1601 MAX PTS 801 MAX PTS 401 MAX PTS 201 MAX PTS 101 MAX PTS 51 MAX PTS</p> <p>NEXT CAL STEP</p> <p>PRESS <ENTER> TO SELECT</p>	<p>Enter the center frequency for calibration. If you desire, you can change this frequency for your measurement when you reach menu SU1_CENTER, which follows the final calibration menu.</p> <p>Enter the span width for calibration. Like the start frequency, this too can be changed for your measurement.</p> <p>Calls Menu C2, which lets you enter a start and stop frequency.</p> <p>The program automatically sets the step size, based on the selected center and span frequencies. The step size will be the smallest possible (largest number of points up to a maximum of 1601), based on the chosen frequency span.</p> <p>Displays the next menu in the calibration sequence.</p> <p>Pressing the ENTER key implements your menu selection.</p>

Menu C2_CENTER, Frequency Range of Calibration (Center / Span)

MENU	DESCRIPTION
<p style="text-align: center;">INSERT INDIVIDUAL FREQUENCIES</p> <p>INPUT A FREQ, PRESS <ENTER> TO INSERT</p> <p>NEXT FREQ. XXX.XXXXXXXXXXGHZ</p> <p>XXXX FREQS. ENTERED, LAST FREQ WAS XXX.XXXXXXXXXXGHZ</p> <p>AUTO INCR ON (OFF) XXX.XXXXXXXXXXGHZ</p> <p style="text-align: center;">PREVIOUS MENU</p> <p style="text-align: center;">PRESS <ENTER> TO SELECT OR TURN ON/OFF</p>	<p>Move the cursor here and enter the next frequency for which you wish calibration data taken. If the AUTO INCR option is ON, pressing Enter automatically increments the calibration frequency by the interval in GHz that appears below the option.</p> <p>Shows the number of frequencies that you have entered and reports the value of the last frequency entered.</p> <p>Move the cursor here and press ENTER to switch the Auto-Increment mode on or off. If AUTO INCR is on, you may enter the frequency spacing.</p> <p>Calls menu C2D.</p> <p>Pressing Enter will cause actions as described above.</p>

Menu C2A, Insert Individual Frequencies

MENUS
ALPHABETICAL LISTING

MENU	DESCRIPTION
<p>SINGLE POINT C.W. CALIBRATION</p> <p>C.W. FREQ XXX.XXXXXXXXXXGHz</p> <p>NEXT CAL STEP</p> <p>PRESS <ENTER> TO SELECT</p>	<p>Move cursor here and enter the frequency for which calibration is to be done.</p> <p>Move cursor here and press ENTER when finished.</p> <p>Pressing the Enter key implements your menu selection.</p>

Menu C2B, Single Point Calibration

MENU	DESCRIPTION
<p>CALIBRATION RANGE</p> <p>HARMONIC CAL FOR TIME DOMAIN</p> <p>START (STEP) XXX.XXXXXXXXXXGHz</p> <p>APPROXIMATE STOP XXX.XXXXXXXXXX GHz</p> <p>USING ABOVE START AND STOP WILL RESULT IN XXX DATA POINTS XXX.XXXXXXXXXX GHz TRUE STOP FREQ</p> <p>NEXT CAL STEP</p> <p>PRESS <ENTER> TO SELECT</p>	<p>Move cursor here to enter the desired start frequency. This frequency also will be used as the frequency increment.</p> <p>Move the cursor here to enter the approximate desired stop frequency. The frequency will be adjusted to the nearest harmonic multiple of the start frequency.</p> <p>The program automatically indicates the number of data points and the true (harmonic) stop frequency.</p> <p>Move the cursor here and press Enter when finished.</p> <p>Pressing the Enter key implements your menu selection.</p>

Menu C2C, Calibration Range—Harmonic Cal for Time Domain

MENU	DESCRIPTION
DISCRETE FILL	
INPUT START, INCR, POINTS, THEN SELECT "FILL RANGE"	This menu is used to create one or more ranges of discrete equally spaced frequency points for calibration.
START FREQ XXX.XXXXXXXXXX GHz	Enter the first frequency of the range.
INCREMENT XXX.XXXXXXXXXX GHz	Enter the increment (step size) between one frequency and the next.
NUMBER OF PTS XXXX POINT(S)	Enter the number of frequency points in the range.
STOP FREQ XXX.XXXXXXXXXX GHz	Enter the stop frequency, in GHz.
FILL RANGE (XXXX ENTERED)	Moving the cursor here and pressing ENTER fills the range and shows the number of frequencies selected (in NUMBER OF PTS above).
INDIVIDUAL FREQ INSERT	Calls menu C2A, which allows you to set the individual frequencies.
CLEAR ALL	Clears all entries displayed above.
FINISHED NEXT CAL STEP	Calls menu C3, the next menu in the calibration sequence.
PRESS <ENTER> TO SELECT	Pressing the Enter key implements your menu selection.

Menu C2D, Fill Frequency Ranges

MENU	DESCRIPTION
<p>CONFIRM CALIBRATION PARAMETERS</p>	<p>Used for Standard OSL method, coaxial line type.</p>
<p>PORT 1 CONN XXXXXXXX</p>	<p>Calls Menu C4_P1 or C4A_P1, which displays the Port 1 test port connector type to be used during OSL calibration. This should agree with the connector type that both your calibration components and the test device mate with. Move cursor here and press Enter to display menu used to change connector type.</p>
<p>PORT 2 CONN XXXXXXXX</p>	<p>Calls Menu C4_P2 or C4A_P2, which displays the Port 2 test port connector type to be used during OSL calibration. This should agree with the connector type that both your calibration components and the test device mate with. Move cursor here and press Enter to display menu used to change connector type.</p>
<p>REFLECTION PAIRING XXXXXX</p>	<p>Calls menu C13, which lets you select the pairing (mixed or matched) for the types of reflection devices (open/short) that you will use on Ports 1 and 2 for calibration.</p>
<p>LOAD TYPE XXXXXXXX</p>	<p>Calls Menu C6, which displays type of load selected for calibration—broadband fixed or sliding. Move cursor here and press ENTER to display menu used to change load type.</p>
<p>THROUGH LINE PARAMETERS</p>	<p>Calls Menu C20, which lets you enter throughline parameters—including offset length and loss equation coefficients:</p>
<p>REFERENCE IMPEDANCE</p>	<p>Calls Menu C17, which lets you choose the reference impedance value (1 $\mu\Omega$ to 1 kΩ) for the devices connected to Ports 1 and 2 for calibration. Default value is 50Ω.</p>
<p>TEST SIGNALS</p>	<p>Calls menu CAL_SU2, which lets you enter calibrate Flat Test Port Power or change source power(s) and attenuator settings.</p>
<p>START CAL</p> <p>PRESS <ENTER> TO SELECT OR CHANGE</p>	<p>Starts the standard (OSL) calibration sequence using coaxial standards.</p> <p>Pressing the Enter key implements your menu selection.</p>

Menu C3, Confirm Calibration Parameters

MENU	DESCRIPTION
CONFIRM CALIBRATION PARAMETERS	Used for Offset-Short method, coaxial line type.
OFFSET LENGTHS OF SHORTS	Calls Menu C4, which lets you change the offset lengths of the shorts used for coaxial calibration.
LOAD TYPE XXXXXXXX	Calls Menu C6, which displays type of load selected for calibration—broadband fixed or sliding. Move cursor here and press Enter to display menu used to change load type.
THROUGH LINE PARAMETERS	Calls Menu C20, which lets you enter throughline parameters—including offset length and loss equation coefficients.
REFERENCE IMPEDANCE	Calls Menu C15, which lets you choose the reference impedance value (1 $\mu\Omega$ to 1 M Ω) for the devices connected to Ports 1 and 2 for calibration. Default value is 50 Ω .
TEST SIGNALS	Calls menu CAL_SU2, which lets you enter calibrate Flat Test Port Power or change source power(s) and attenuator settings.
START CAL	Starts the offset-short calibration sequence using coaxial standards.
PRESS <ENTER> TO SELECT OR CHANGE	Pressing the Enter key implements your menu selection.

Menu C3A, Confirm Calibration Parameters

MENU	DESCRIPTION
<p>CONFIRM CALIBRATION PARAMETERS</p> <p>LOAD TYPE XXXXXXXX</p> <p>THROUGH LINE PARAMETERS</p> <p>WAVEGUIDE PARAMETERS XXXXXX</p> <p>TEST SIGNALS</p> <p>START CAL</p> <p>PRESS <ENTER> TO SELECT OR CHANGE</p>	<p>Used for Offset-Short method, waveguide line type.</p> <p>Calls Menu C6, which displays type of load selected for calibration—broadband fixed or sliding.</p> <p>Calls Menu C20, which lets you enter throughline parameters—including offset length and loss equation coefficients.</p> <p>Calls Menu C15, which lets you enter waveguide parameters.</p> <p>Calls menu CAL_SU2, which lets you calibrate Flat Test Port Power or change source power(s) and attenuator settings.</p> <p>Starts the offset-short calibration sequence using waveguide standards.</p> <p>Pressing the Enter key implements your menu selection.</p>

Menu C3B, Confirm Calibration Parameters

MENU	DESCRIPTION
CONFIRM CALIBRATION PARAMETERS	Used for Offset-Short method, microstrip line type.
OFFSET LENGTHS OF SHORTS	Calls Menu C14, which lets you change offset lengths of shorts used for microstrip calibration.
LOAD IMPEDANCES	Calls Menu C6A, which lets you select an impedance type and/or enter an impedance value.
THROUGH LINE PARAMETERS	Calls Menu C20, which lets you enter throughline parameters—including offset length and loss equation coefficients.
MICROSTRIP PARAMETERS XXXXXXXXXXXX	Calls Menu C16, which lets you change microstrip parameters.
TEST SIGNALS	Calls menu CAL_SU2, which lets you enter calibrate Flat Test Port Power or change source power(s) and attenuator settings.
START CAL	Starts the offset-short calibration sequence using microstrip standards.
PRESS <ENTER> TO SELECT OR CHANGE	Pressing the Enter key implements your menu selection.

Menu C3C, Confirm Calibration Parameters

MENUS
ALPHABETICAL LISTING

C

MENU	DESCRIPTION
<p>CONFIRM CALIBRATION PARAMETERS</p>	<p>Used for Standard OSL method, microstrip line type.</p>
<p>PORT 1 OPEN/SHORT</p>	<p>Calls menu C12_P1, which is used to define the capacitive coefficients of the Open and offset length of the Short for Port 1.</p>
<p>PORT 2 OPEN/SHORT</p>	<p>Calls menu C12_P2, which is used to define the capacitive coefficients of the Open and offset length of the Short for Port 2.</p>
<p>REFLECTION PAIRING</p>	<p>Calls menu C13, which lets you select the pairing (mixed or matched) for the types of reflection devices (open/short) that you will use on Ports 1 and 2 for calibration.</p>
<p>LOAD IMPEDANCE XXXXXX</p>	<p>Calls Menu C6A, which lets you select an impedance type and/or enter an impedance value.</p>
<p>THROUGH LINE PARAMETERS XXXXXXXXXXXX</p>	<p>Calls Menu C20, which lets you enter throughline parameters—including offset length and loss equation coefficients.</p>
<p>MICROSTRIP PARAMETERS XXXXXXXXXXXX</p>	<p>Calls Menu C16, which lets you change microstrip parameters.</p>
<p>TEST SIGNALS</p>	<p>Calls menu CAL_SU2, which lets you enter calibrate Flat Test Port Power or change source power(s) and attenuator settings.</p>
<p>START CAL PRESS <ENTER> TO SELECT OR CHANGE</p>	<p>Starts the standard calibration sequence using microstrip standards. Pressing the Enter key implements your menu selection.</p>

Menu C3D, Confirm Calibration Parameters

MENU	DESCRIPTION
CONFIRM CALIBRATION PARAMETERS	Used for LRL/LRM method, coaxial line type.
LRL/LRM PARAMETERS	Calls Menu C18, which lets you change LRL/LRM parameters.
REFERENCE IMPEDANCE	Calls Menu C17, which lets you change the reference impedance of the coaxial line standard to other than 50 ohms (default).
TEST SIGNALS	Calls menu CAL_SU2, which lets you enter calibrate Flat Test Port Power or change source power(s) and attenuator settings.
START CAL	Starts the LRL/LRM calibration sequence using coaxial standards.
PRESS <ENTER> TO SELECT OR CHANGE	Pressing the Enter key implements your menu selection.

Menu C3E, Confirm Calibration Parameters

MENUS
ALPHABETICAL LISTING

C

MENU	DESCRIPTION
CONFIRM CALIBRATION PARAMETERS	Used for LRL/LRM method, waveguide line type.
LRL/LRM PARAMETERS	Calls Menu C18, which lets you change LRL/LRM parameters.
WAVEGUIDE CUTOFF FREQ	Calls Menu 15B, which lets you enter a waveguide cutoff frequency.
TEST SIGNALS	Calls menu CAL_SU2, which lets you enter calibrate Flat Test Port Power or change source power(s) and attenuator settings.
START CAL PRESS <ENTER> TO SELECT OR CHANGE	Starts the LRL/LRM calibration sequence using waveguide standards. Pressing the Enter key implements your menu selection.

Menu C3F, Confirm Calibration Parameters

MENU	DESCRIPTION
CONFIRM CALIBRATION PARAMETERS	Used for LRL/LRM method, microstrip line type.
LRL/LRM PARAMETERS	Calls Menu C18, which lets you change LRL/LRM parameters.
MICROSTRIP PARAMETERS USER DEFINED	Calls Menu C16, which lets you change microstrip parameters.
TEST SIGNALS	Calls menu CAL_SU2, which lets you enter calibrate Flat Test Port Power or change source power(s) and attenuator settings.
START CAL	Starts the LRL/LRM calibration sequence using microstrip standards.
PRESS <ENTER> TO SELECT OR CHANGE	Pressing the Enter key implements your menu selection.

Menu C3G, Confirm Calibration Parameters

MENU	DESCRIPTION
CONFIRM CALIBRATION PARAMETERS	
OFFSET LENGTH OF TRM REFLECTION XXXX	Enter the offset length of the TRM reflection.
TYPE OF TRM REFLECTION	
OPEN (GREATER THAN Z_0)	Specifies the reflection to have an impedance value greater than the reference impedance (Z_0). This is typically an open device.
SHORT (LESS THAN Z_0)	Selects the reflection to have an impedance value less than the reference impedance (Z_0). This is typically a short device.
REFERENCE IMPEDANCE	Calls Menu C17, which lets you change the reference impedance of the coaxial line standard to other than 50 ohms (default).
TEST SIGNALS	Calls menu CAL_SU2, which lets you enter calibrate Flat Test Port Power or change source power(s) and attenuator settings.
START CAL	Starts the standard calibration sequence using microstrip standards.
PRESS <ENTER> TO SELECT OR CHANGE	Pressing the Enter key implements your menu selection.

Menu C3H, Confirm Calibration Parameters

MENU	DESCRIPTION
<p data-bbox="261 394 448 485">CONFIRM CALIBRATION PARAMETERS</p> <p data-bbox="196 520 483 611">OFFSET LENGTH OF TRM REFLECTION XXXX</p> <p data-bbox="196 646 391 701">WAVEGUIDE CUTOFF FREQ</p> <p data-bbox="196 737 391 764">TEST SIGNALS</p>	<p data-bbox="578 520 1114 548">Enter the offset length of the TRM reflection.</p> <p data-bbox="578 646 1398 674">Calls Menu 15B, which lets you enter a waveguide cutoff frequency.</p> <p data-bbox="578 737 1463 800">Calls menu CAL_SU2, which lets you enter calibrate Flat Test Port Power or change source power(s) and attenuator settings.</p>

Menu C3I, ConfirmCalibration Parameter 2

MENUS
ALPHABETICAL LISTING

C

MENU	DESCRIPTION
CONFIRM CALIBRATION PARAMETERS	
OFFSET LENGTH OF TRM REFLECTION XXXX	Enter the offset length of the TRM reflection.
TYPE OF TRM REFLECTION	
OPEN (GREATER THN Z_0)	Specifies the reflection to have an impedance value greater than the reference impedance (Z_0). This is typically an open device.
SHORT (LESS THAN Z_0)	Selects the reflection to have an impedance value less than the reference impedance (Z_0). This is typically a short device.
MICROSTRIP PARAMETERS XXXXXXXX	Calls Menu C16 or 16A, which lets you change microstrip parameters.
TEST SIGNALS	Calls menu CAL_SU2, which lets you enter calibrate Flat Test Port Power or change source power(s) and attenuator settings.
START CAL	Starts the standard calibration sequence using microstrip standards.
PRESS <ENTER> TO SELECT OR CHANGE	Pressing the Enter key implements your menu selection.

Menu C3J, Confirm Calibration Parameter 3

MENU	DESCRIPTION
SELECT PORT X CONNECTOR TYPE	Applies the four capacitance-coefficient values to the Open and offset length to the Short. The data appears in the display area of the screen.
SMA (M)	Select for SMA (M) connector on Port X.
SMA (F)	Select for SMA (F) connector on Port X.
K-CONN (M)	Select for K-CONN (M) connector on Port X.
K-CONN (F)	Select for K-CONN (F) connector on Port X.
TYPE N (M)	Select for Type N (M) connector on Port X.
TYPE N (F)	Select for Type N (F) connector on Port X.
GPC-3.5 (M)	Select for GPC-3.5 (M) connector on Port X.
GPC-3.5 (F)	Select for GPC-3.5 (F) connector on Port X.
GPC-7	Select for GPC-7 connector on Port X.
USER DEFINED	Calls menu C12, which lets you specify the connector coefficients.
MORE	Calls additional connector types to screen.
PRESS <ENTER> TO SELECT	Pressing the Enter key implements your menu selection.

Menu C4_P1/C4_P2, Select Connector Type

MENUS
ALPHABETICAL LISTING

C

MENU	DESCRIPTION
SELECT PORT X CONNECTOR TYPE	Applies the four capacitance-coefficient values to the Open and offset length to the Short. The data appears in the display area of the screen.
V-CONN (M)	Select for V-CONN (M) connector on Port X.
V-CONN (F)	Select for V-CONN (F) connector on Port X.
TNC (M)	Select for TNC (M) connector on Port X.
TNC (F)	Select for TNC (F) connector on Port X.
2.4 mm (M)	Select for 2.4 mm (M) connector on Port X.
2.4 mm(F)	Select for 2.5 mm (F) connector on Port X.
TYPE N (M) 75Ω	Select for Type N (M) 75W connector on Port X.
TYPE N (F) 75Ω	Select for Type N (F) 75Ω connector on Port X.
SPECIAL (M)	Select for Special (M) connector on Port X.
SPECIAL (F)	Select for Special (F) connector on Port X.
USER DEFINED	Calls Menu C12, which lets you specify the connector coefficients.
MORE	Calls additional connector types to screen.
PRESS <ENTER> WHEN COMPLETE	Pressing the Enter key implements your menu selection.

Menu C4A_P1/C4A_P2, Select Connector Type

MENU	DESCRIPTION
<p data-bbox="217 365 472 422">SELECT CALIBRATION TYPE</p> <p data-bbox="188 457 378 485">FULL 12-TERM</p> <p data-bbox="188 550 285 606">1 PATH 2 PORT</p> <p data-bbox="188 642 391 732">TRANSMISSION FREQUENCY RESPONSE</p> <p data-bbox="188 766 358 823">REFLECTION ONLY</p> <p data-bbox="233 856 451 913">PRESS <ENTER> TO SELECT</p>	<p data-bbox="574 457 1406 514">Select calibration using all 12 error terms EDF, ESF, ERF, ETF, ELF, (EXF), EDR, ESR, ERR, ETR, FLR, (EXR).</p> <p data-bbox="574 550 1352 606">Calls Menu C5A, which lets select a correction for forward- or reverse-direction error terms.</p> <p data-bbox="574 642 1417 699">Calls Menu C5B, which lets select a correction for frequency response error terms.</p> <p data-bbox="574 766 1425 823">Calls Menu C5C, which lets select a correction for reflection-only error terms.</p> <p data-bbox="574 856 1247 884">Pressing the Enter key implements your menu selection.</p>

Menu C5, Select Calibration Type

MENUS
ALPHABETICAL LISTING

C

MENU	DESCRIPTION
<p>SELECT 1 PATH 2 PORT CALIBRATION TYPE</p> <p>FORWARD PATH (S11, S21)</p> <p>REVERSE PATH (S12, S22)</p> <p>PRESS <ENTER> TO SELECT</p>	<p>For the calibration-correction of the forward transmission and reflection error term, ETF, EDF, ESF, ERF, (EXF).</p> <p>For the calibration-correction of the reverse transmission and reflection error term, EDR, ESR, ERR, ETR, (EXR).</p> <p>Pressing the Enter key implements your selection.</p>

Menu C5A, Select 1 Path 2 Port Calibration Type

MENU	DESCRIPTION
<p>SELECT TRANSMISSION FREQ RESPONSE CALIBRATION TYPE</p> <p>FORWARD PATH (S21)</p> <p>REVERSE PATH (S12)</p> <p>BOTH PATHS (S21, S12)</p> <p>PRESS <ENTER> TO SELECT</p>	<p>For the calibration-correction of the forward transmission frequency-response error term, ETF. (EXF).</p> <p>For the calibration-correction of the reverse transmission-frequency-response error term, ETR, (EXR).</p> <p>For the calibration-correction of the forward and reverse transmission-frequency-response error terms ETF, ETR, (EXF, EXR).</p> <p>Pressing the Enter key implements your menu selection.</p>

Menu C5B, Select Transmission Freq Response Calibration Type

MENU	DESCRIPTION
SELECT REFLECTION ONLY CALIBRATION TYPE PORT 1 ONLY (S11) PORT 2 ONLY (S22) BOTH PORTS (S11, S22) PRESS <ENTER> TO SELECT	For the calibration-correction of the forward reflection-only error terms EDF, ESF, ERF. For the calibration-correction of the reverse reflection-only error terms EDR, ESR, ERR. For the calibration-correction of the forward and reverse reflection-only error terms EDF, ESF, ERF, EDR, ESR, ERR. Pressing the Enter key implements your menu selection.

Menu C5C, Select Reflection Only Calibration Type

MENU	DESCRIPTION
SELECT USE OF ISOLATION IN CALIBRATION INCLUDE ISOLATION (STANDARD) EXCLUDE ISOLATION PRESS <ENTER> TO SELECT	Includes isolation term(s). Excludes isolation term(s). Pressing the Enter key implements your menu selection.

Menu C5D, Select Use of Isolation

MENUS
ALPHABETICAL LISTING

C

MENU	DESCRIPTION
<p>SELECT TYPE OF LOAD</p> <p>BROADBAND FIXED LOAD</p> <p>SLIDING LOAD (MAY ALSO REQUIRE BROADBAND FIXED LOAD)</p> <p>PRESS <ENTER> TO SELECT</p>	<p>Selects calibration based on the broadband load being used, then calls menu C6A.</p> <p>Selects calibration based on the sliding load being used. If your low-end frequency is below 2 GHz (4 GHz for V Connector), a fixed broadband load is also required.</p> <p>Pressing the Enter key implements your menu selection.</p>

Menu C6, Select Load Type

MENU	DESCRIPTION
<p>BROADBAND LOAD PARAMETERS</p> <p>IMPEDANCE XX.XXX Ω</p> <p>INDUCTANCE XX.XXX pH</p> <p>PRESS <ENTER> WHEN COMPLETE</p>	<p>Enter the impedance of the load.</p> <p>Enter the inductance of the load.</p> <p>Pressing the Enter key implements your menu selection.</p>

Menu C6A, Enter Broadband Load Impedance

MENU	DESCRIPTION
CALIBRATION SEQUENCE CONNECT CALIBRATION DEVICE(S) PORT 1: XXXXXXXXXXXX PORT 2: XXXXXXXXXXXX PRESS <ENTER> TO MEASURE DEVICE(S) PRESS <1> FOR PORT 1 DEVICE PRESS <2> FOR PORT 2 DEVICE	 Connect the required component to Port 1. Connect the required component to Port 2. Pressing the Enter key sequentially measures the devices connected to Ports 1 and 2, beginning with Port 1. Pressing the 1 key, on the keypad, measures the device connected to Port 1. Pressing the 2 key, on the keypad, measures the device connected to Port 2.

Menu C7-Series, Begin Calibration Sequence

MENU	DESCRIPTION
CALIBRATION SEQUENCE SLIDE LOAD TO POSITION X PRESS <ENTER> TO MEASURE DEVICE (S)	 Slide the load to the next position, then press the Enter key. Moving the slide to six different positions provides sufficient data for the program to accurately calculate the effective directivity of the system. Pressing the Enter key begins the measurement.

Menu C8, Slide Load to Position X

MENUS
ALPHABETICAL LISTING

C

MENU	DESCRIPTION
CALIBRATION SEQUENCE CONNECT THROUGHLINE XXXXX BETWEEN TEST PORTS PRESS <ENTER> TO MEASURE DEVICE(S)	Connect Ports 1 and 2 together using the Throughline standard (zero or non-zero length). Pressing the Enter key begins the measurement.

Menu C9, Connect Throughline

MENU	DESCRIPTION
CALIBRATION SEQUENCE CONNECT DEVICE 1 LINE 1 (REF) XXXXX BETWEEN TEST PORTS PRESS <ENTER> TO MEASURE DEVICE(S)	Prompts you to connect reference line 1 between test ports. Pressing the Enter key begins the measurement.

Menu C9A, Connect Device 1, Line

MENU	DESCRIPTION
CALIBRATION SEQUENCE CONNECT DEVICE 2 LINE/ LOWBAND MATCHES BETWEEN TEST PORTS PRESS <ENTER> TO MEASURE DEVICE(S)	Connect device 2 between the test ports. This will be a LINE for LRL measurements or LOWBAND MATCHES for LRM measurements. Pressing the Enter key begins the measurement.-

Menu C9B, Connect Device 2, Line / Lowband

MENU	DESCRIPTION
CALIBRATION SEQUENCE CONNECT DEVICE 2 LINE XXXXX BETWEEN TEST PORTS PRESS <ENTER> TO MEASURE DEVICE(S)	Prompts you to connect the second line standard between the test ports. Pressing the Enter key begins the measurement.

Menu C9C, Connect Device 2, Line

MENUS
ALPHABETICAL LISTING

C

MENU	DESCRIPTION
BEGIN CALIBRATION	
KEEP EXISTING CAL DATA	Keep existing calibration data.
REPEAT PREVIOUS CAL	Repeats the previous calibration.
AUTOCAL	Call Menu ACAL, which lets you choose AutoCal settings.
CAL METHOD XXXXXXX	Displays the calibration method that you have selected—standard, offset short or LRL/LRM.
TRANSMISSION LINE TYPE: XXXXXXXX	Indicates type of transmission line currently selected, e. g. coaxial, waveguide, microstrip.
CHANGE CAL METHOD AND LINE TYPE	Calls menu C11A, which allows you to change calibration method and transmission line type.
NEXT CAL STEP	Selects the next calibration step.
PRESS <ENTER> TO SELECT	Pressing the Enter key implements your menu selection.

Menu C11, Begin Calibration

MENU	DESCRIPTION
CHANGE CAL METHOD AND LINE TYPE	
NEXT CAL STEP	Select next calibration step. Must move cursor to here after making below selections. Pressing the Enter key then moves you to the next step.
CAL METHOD	
STANDARD (NOT USED FOR WAVEGUIDE)	This option and the ones below allow you to select the method (procedure) to be used to calibrate. This method is independent of the calibration type, which may be 12 term, reflection only etc.
OFFSET SHORT	Selects offset-short method.
LRL/LRM	Selects LRL or LRM method.
TRM	Selects TRM method.
TRANSMISSION LINE TYPE	
COAXIAL	Selects coaxial cable as the transmission line type.
WAVEGUIDE	Selects waveguide as the transmission line type.
MICROSTRIP	Selects microstrip as the transmission line type.
PRESS <ENTER> TO SELECT	Pressing the Enter key implements your menu selection.

Menu C11A, Select Calibration Method

MENUS
ALPHABETICAL LISTING

C

MENU	DESCRIPTION
<p>PORT X OPEN DEVICE</p> <p>ENTER THE CAPACITANCE COEFFICIENTS</p> <p>TERM 1-C0 ± XX.XXe- 15</p> <p>TERM 2-C1 ±XXX.XX e - 27</p> <p>TERM 3-C2 ±XXX.XX e - 36</p> <p>TERM 4-C3 ±XXX.XX e - 45</p> <p>ENTER THE OFFSET LENGTH</p> <p>OFFSET LENGTH ±XX.XXXX mm</p> <p>PRESS <ENTER> WHEN COMPLETE</p>	<p>Enter the capacitance-coefficient values needed to correct for your Open device. The capacitive phase shift of the Open is characterized by the equation: $C_{Open} = C_0 + (C_1 \times f) + (C_2 \times f^2) + (C_3 \times f^3)$</p> <p>Enter the term 1 coefficient value (x 10⁻¹⁵ F).</p> <p>Enter the term 2 coefficient value (x 10⁻²⁷ F/Hz).</p> <p>Enter the term 3 coefficient value (x 10⁻³⁶ F/Hz²).</p> <p>Enter the term 4 coefficient value (x 10⁻⁴⁵ F/Hz³).</p> <p>Select to enter and display offset length of Open.</p> <p>Pressing the Enter key calls C12A_P1/C12A_P2.</p>

Menu C12_P1/C12_P2, Enter the Capacitance Coefficients for Open Devices

MENU	DESCRIPTION
PORT X SHORT DEVICE	
ENTER THE INDUCTANCE COEFFICIENTS	Provide inductance term entries for the short device such that the frequency dependent inductance is $L(w) = L0 + (L1 * f) + (L2 * f^2) + (L3 * f^3)$. These values default to zero. They are used in the standard calibration method in combination with the coaxial and microstrip line types. They are not used in the offset short and LRL/LRM calibration methods. The calibration kits provided by ANRITSU are not to support these terms.
TERM 1 - L0 - XXXX.XX e-12	Enter the term 1 value.
TERM 2 - L1 - XXXX.XX e-24	Enter the term 2 value.
TERM 3 - L2 - XXXX.XX e-33	Enter the term 3 value.
TERM 4 - L3 - XXXX.XX e-42	Enter the term 4 value.
ENTER THE OFFSET LENGTH	Enter the length of the offset device.
OFFSET LENGTH -XXX.XXXX mm	Displays the offset length value.
PRESS <ENTER> WHEN COMPLETE	Pressing the Enter key implements your menu selection.

Menu C12A_P1/C12A_P2, Enter the Offset Length

MENUS
ALPHABETICAL LISTING

C

MENU	DESCRIPTION
<p>SET REFLECTION PAIRING</p> <p>MIXED (OPEN-SHORT SHORT-OPEN)</p> <p>MATCHED (OPEN-OPEN SHORT-SHORT)</p> <p>PRESS <ENTER> TO SELECT</p>	<p>Selects different reflection devices (open/short or short/open) to be connected to Ports 1 and 2 for the calibration sequencing.</p> <p>Selects the same type of reflection device (open/open or short/short) to be connected to Ports 1 and 2 for the calibration sequencing.</p> <p>Pressing the Enter key implements your menu selection.</p>

Menu C13, Set Reflection Pairing Menu

MENU	DESCRIPTION
<p>SELECT WAVEGUIDE KIT TO USE</p> <p>-INSTALLED KIT-</p> <p>IDENTIFIER XXXX</p> <p>CUTOFF FREQ: XXX.XXXXXXXXXX GHz</p> <p>SHORT 1 XX.XXXXmm</p> <p>SHORT 2 XX.XXXXmm</p> <p>USE INSTALLED WAVEGUIDE KIT</p> <p>USER DEFINED</p> <p>PRESS <ENTER> TO SELECT</p>	<p>The lines below indicate the characteristics of the installed waveguide calibration kit, if applicable.</p> <p>Displays the type of waveguide used.</p> <p>Displays the cutoff frequency of the waveguide.</p> <p>Displays the offset length of the first calibration short.</p> <p>Displays the offset length of the second calibration short.</p> <p>Move the cursor to this line and press Enter to use the displayed kit.</p> <p>Calls menu C15A, which lets you modify the parameters.</p> <p>Pressing the Enter key implements your menu selection.</p>

Menu C15, Select Waveguide Kit to Use

MENU	DESCRIPTION
<p style="text-align: center;">ENTER WAVEGUIDE PARAMETERS</p> <p>WAVEGUIDE CUTOFF FREQ XXX.XXXXXXXXXX GHz</p> <p>OFFSET LENGTH OF SHORT 1 X.XXXX mm</p> <p>OFFSET LENGTH OF SHORT 2 X.XXXX mm</p> <p>PRESS <ENTER> WHEN COMPLETE</p>	<p>Move cursor to this line then press Enter to bring up menu that allows you to enter waveguide cutoff frequency.</p> <p>Move the cursor to this line and enter the offset length of Short 1.</p> <p>Move the cursor to this line and enter the offset length of Short 2.</p> <p>Pressing the Enter key implements your menu selection.</p>

Menu C15A, Enter Waveguide Parameters

MENU	DESCRIPTION
<p style="text-align: center;">ENTER WAVEGUIDE CUTOFF FREQUENCY</p> <p>WAVEGUIDE CUTOFF FREQ XXX.XXXXXXXXXX GHz</p> <p>PRESS <ENTER> WHEN COMPLETE</p>	<p>Enter waveguide cutoff frequency.</p> <p>Pressing the Enter key implements your menu selection.</p>

Menu C15B, Enter Waveguide Parameters

MENUS
ALPHABETICAL LISTING

MENU	DESCRIPTION
<p>SELECT MICROSTRIP KIT TO USE</p> <p>10 MIL KIT</p> <p>15 MIL KIT</p> <p>25 MIL KIT</p> <p>USER DEFINED</p> <p>PRESS <ENTER> TO SELECT</p>	<p>Selects parameters for 10 mil UTF kit.</p> <p>Selects parameters for 15 mil UTF kit.</p> <p>Selects parameters for 25 mil UTF kit.</p> <p>Calls menu C16A, which lets you modify the parameters.</p> <p>Pressing the Enter key implements your menu selection.</p>

Menu C16, Select Microstrip Parameters

MENU	DESCRIPTION
<p>ENTER MICROSTRIP PARAMETERS</p> <p>WIDTH OF STRIP XX.XXXX mm</p> <p>THICKNESS OF SUBSTRATE XXXX.XXXX mm</p> <p>Zc XXX.XXX Ω</p> <p>SUBSTRATE DIELECTRIC XX.XX</p> <p>EFFECTIVE DIELECTRIC XX.XX (RECOMMENDED 1.00)</p> <p>PRESS <ENTER> WHEN COMPLETE</p>	<p>Move the cursor to this line and enter the width of the microstrip you are using.</p> <p>Move the cursor to this line and enter the thickness of the substrate you are using.</p> <p>Move the cursor to this line and enter the characteristic impedance of the microstrip.</p> <p>Move the cursor to this line and enter the relative dielectric constant of the substrate you are using.</p> <p>Move the cursor to this line and enter the effective dielectric constant of the microstrip. A recommended value will also be displayed.</p> <p>Pressing the Enter key implements your menu selection.</p>

Menu C16A, Enter Microstrip Parameters

MENU	DESCRIPTION
<p style="text-align: center;">ENTER REFERENCE IMPEDANCE</p> <p>REFERENCE IMPEDANCE XXX.XXXΩ</p> <p style="text-align: center;">PRESS <ENTER> WHEN COMPLETE</p>	<p>Enter the reference impedance (Z_0) of the coaxial reference line standard.</p> <p>Pressing the Enter key implements your menu selection.</p>

Menu C17, Enter Line Impedance

MENU	DESCRIPTION
<p style="text-align: center;">CHANGE LRL/LRM PARAMETERS</p> <p>NEXT CAL STEP</p> <p>NUMBER OF BANDS USED</p> <p style="padding-left: 20px;">ONE BAND</p> <p style="padding-left: 20px;">TWO BANDS</p> <p>LOCATION OF REFERENCE PLANES</p> <p style="padding-left: 20px;">MIDDLE OF LINE 1 (REF)</p> <p style="padding-left: 20px;">ENDS OF LINE 1 (REF)</p> <p style="text-align: center;">PRESS <ENTER> TO SELECT</p>	<p>Selects next calibration step. Must move cursor to here after making below selections. Pressing the Enter key then moves you to the next step. Calls menu C18A for one band or C18B for two bands.</p> <p>Selects a one-band LRL or LRM calibration.</p> <p>Selects a two-band LRL or LRM calibration (that is, a three-line LRL or concatenated LRL and LRM calibrations).</p> <p>Select reference planes to be at middle of line 1.</p> <p>Select reference planes to be at end of line 1.</p> <p>Pressing the Enter key implements your menu selection.</p>

Menu C18, Change LRL / LRM Parameters

MENUS
ALPHABETICAL LISTING

C

MENU	DESCRIPTION
<p>CHANGE LRL/LRM PARAMETERS</p> <p>NEXT CAL STEP</p> <p>CHARACTERIZE CAL DEVICES</p> <p>DEVICE 1 LINE 1 (REF) X.XXXX mm</p> <p>DEVICE 2 LINE /MATCH X.XXXX mm/FULLBAND</p> <p>PRESS <ENTER> TO SELECT OR SWITCH</p>	<p>Selects next calibration step. Must move cursor to here after making below selections. Pressing the Enter key then moves you to the next step. Calls menu C19.</p> <p>Enter length of line 1.</p> <p>Select device 2—LINE or MATCH; if line is selected, enter length.</p> <p>Press Enter to select. If DEVICE 2 is chosen, pressing the Enter key toggles between LINE and MATCH.</p>

Menu C18A, Change LRL/LRM Parameters

MENU	DESCRIPTION
CHANGE LRL/LRM PARAMETERS	
NEXT CAL STEP	Selects next calibration step. Must move cursor to here after making below selections. Pressing the Enter key then moves you to the next step. Calls menu C19.
CHARACTERIZE CAL DEVICES	
DEVICE 1 LINE 1 (REF) XX.XXXX	Enter length of line 1.
DEVICE 2 LINE/MATCH XX.XXXX/LOWBAND	Press Enter to toggle between LINE and MATCH. If LINE is selected, enter line length. If match is selected, LOWBAND is displayed. This indicates that device 2 is the lowband match.
DEVICE 3 LINE/MATCH XX.XXXX/HIGHBAND	Press Enter to toggle between LINE and MATCH. If LINE is selected, enter line length. If match is selected, HIGHBAND is displayed. This indicates that device 3 is the high band match.
FREQ AFTER WHICH THE USE OF DEVICE 2 AND DEVICE 3 IS EXCHANGED	
BREAKPOINT XXX.XXXXXXXXXXGHZ	Enter breakpoint frequency: end of band 1, beginning of band 2.
PRESS <ENTER> TO SELECT OR SWITCH	Pressing the Enter key implements your menu selection.

Menu C18B, Change LRL/LRM Parameters—Two Band Calibration

MENU	DESCRIPTION
<p>CHANGE LRL/LRM PARAMETERS</p> <p>NEXT CAL STEP</p> <p>OFFSET LENGTH OF REFLECTIVE DEVICE</p> <p>OFFSET LENGTH X.XXXX mm</p> <p>TYPE OF REFLECTION</p> <p>GREATER THAN Z_0</p> <p>LESS THAN Z_0</p> <p>PRESS <ENTER> TO SELECT</p>	<p>Moves to the next calibration step. Must move cursor to here after making below selections. Pressing the Enter key then moves you to the next step.</p> <p>Enter the offset length of the reflective device.</p> <p>Specifies the reflection to have an impedance value greater than the reference impedance (Z_0). This is typically an open device.</p> <p>Selects the reflection to have an impedance value less than the reference impedance (Z_0). This is typically a short device.</p> <p>Pressing the Enter key implements the selection.</p>

Menu C19, Change LRL / LRM Parameters

MENU	DESCRIPTION
ENTER THROUGH LINE PARAMETERS OFFSET LENGTH X.XXXX mm THROUGHLINE IMPEDANCE X.XXXX Ω PRESS <ENTER> WHEN COMPLETE	<p>Enter offset length of through-line device.</p> <p>Enter the impedance of the through-line device.</p> <p>Pressing the Enter key brings the next calibration menu.</p>

Menu C20, Change Through Parameters

MENU	DESCRIPTION
CALIBRATION SEQUENCE COMPLETED PRESS <SAVE/RECALL> TO STORE CAL DATA ON DISK OR PRESS <ENTER> TO PROCEED	<p>Pressing the SAVE/RECALL MENU Key displays menu SR, which lets you save your calibration data onto a disk or recall previously saved calibration data from a disk. While this menu provides a convenient point at which to save the calibration data, it is not the only point allowed. You can use the SAVE/RECALL MENU key at any point in the measurement program.</p> <p>Pressing the Enter key implements your menu selection.</p>

Menu Cal_Completed

MENUS
ALPHABETICAL LISTING

C

MENU	DESCRIPTION
<p>APPLY CALIBRATION</p> <p>FULL 12-TERM (S11, S21 S22, S12)</p> <p>APPLY ON (OFF) CALIBRATION</p> <p>TUNE MODE ON (OFF)</p> <p>NO. OF FWD (REV) SWEEPS BETWEEN REV (FWD) SWEEPS XXXXX SWEEPS (XXXXX REMAINING)</p> <p>PRESS <APPLY CAL> TO TURN ON/OFF</p> <p>PRESS <ENTER> TO TURN ON/OFF</p>	<p>Reflects the type of calibration presently stored in internal memory.</p> <p>Turns calibration on or off.</p> <p>For applied Full 12-Term calibration only. When turned off, the ratio of forward to reverse sweeps is set to the normal 1:1. When turned on, you can set the ratio of forward sweeps to reverse sweep from 1:1 to 10,000:1 (below).</p> <p>Lets you enter a value for the number of forward (or reverse) sweeps. Alternatively, this option displays the number of forward sweep (or reverse) remaining before a reverse sweep will occur.</p> <p>Press the Apply Cal key to apply the stored calibration.</p> <p>Press the Enter key to turn selected mode on/off.</p>

Menu Cal_Applied

MENU	DESCRIPTION
<p style="text-align: center;">DATA ENHANCEMENT</p> <p>AVERAGING XXXX MEAS. PER POINT</p> <p>SAMPLERS USED PER SWEEP X SAMPLERS</p> <p>PRESS <ENTER> TO RESUME CAL</p>	<p>Averages the measured data over time, as follows:</p> <ol style="list-style-type: none"> 1. The sweep stops at the first frequency point and takes a number of readings, based on the selected number of points. 2. The program averages the readings and writes the average value for that frequency point in the displayed graph. 3. The sweep then advances to the next sequential frequency point and repeats the process. <p>In the normal mode of operation, three samplers are used per forward or reverse sweep; two test samplers and a reference sampler. This results in both transmission and reflection parameters simultaneously.</p> <p>When a device such as a filter with a deep reject-band is measured, having both test samplers on reduces the measurement dynamic range. A higher noise floor in the reject band of the filter is observed. Selecting two samplers per sweep turns off one of the test samplers. This eliminates channel interaction and thereby improves the dynamic range.</p> <p>The drawbacks of using two sampler per sweep are a doubling of measurement time, as two complete one-direction sweeps are needed for both transmission and reflection parameters.</p> <p>Pressing the Enter key implements your menu selection and returns you to the calibration setup or sequence.</p>

Menu Cal_EM, Enhancement Menu for Calibration

MENUS
ALPHABETICAL LISTING

C

MENU	DESCRIPTION
<p>ADAPTER REMOVAL</p> <p>12-TERM CALS FOR X AND Y MUST EXIST IN THE CURRENT DIRECTORY</p> <p>ELECTRICAL LENGTH OF THE ADAPTER +XXX.XXXX ps</p> <p>REMOVE ADAPTER</p> <p>HELP</p> <p>PRESS <ENTER> TO SELECT</p>	<p>Displays the electrical length of the adapter. The value of the electrical length is used when the two calibrations are merged. It has the same range as the time delay for reference plane extension and a default value of 0.0000 ps.</p> <p>Calls Menu CAR2, which leads you through the reading of the Y'-Y and X-X' calibration files and the computation of the new 12-term error coefficients.</p> <p>Calls Menu EXT_CAR, which provides help text for using this feature.</p> <p>Pressing the Enter key implements the selection.</p>

Menu CAR1, Adapter Removal 1

MENU	DESCRIPTION
<p>ADAPTER REMOVAL</p> <p>READ CAL FILE OF X TEST PORT FROM HARD DISK (ADAPTER ON PORT 2)</p> <p>READ CAL FILE OF X TEST PORT FROM FLOPPY DISK (ADAPTER ON PORT 2)</p> <p>PRESS <ENTER> TO SELECT</p> <p>PRESS <CLEAR> TO ABORT</p>	<p>Calls Menu DSK2, which provides instructions.</p> <p>Calls Menu DSK2, which provides instructions.</p> <p>Pressing the Enter key implements the selection.</p> <p>Pressing the Clear key aborts the selection.</p>

Menu CAR2, Adapter Removal 2

- ADAPTERREMOVAL-

THE ADAPTERREMOVALAPPLICATION PERMITS THE USER TO ACCURATELYMEASURENON-INSERTABLE DEVICES. THE PROCESSINVOLVES USING AN ADAPTEROF KNOWN ELECTRICAL LENGTHAND PERFORMINGTWOFULL 12-TERM CALIBRATIONS.

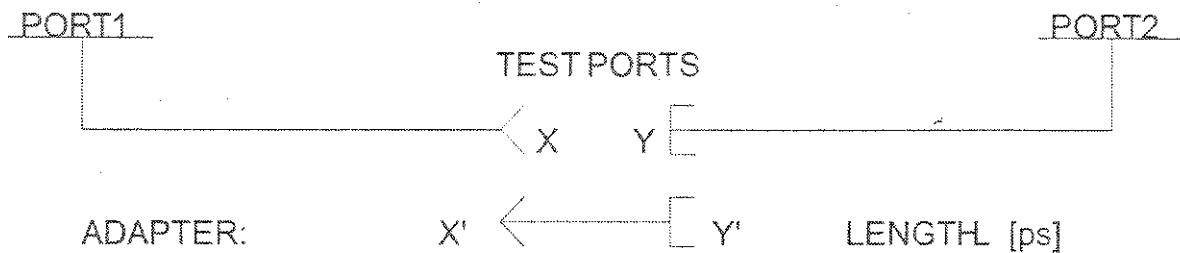

X AND Y ARE COAXIAL OR WAVEGUIDECONNECTORTYPES.
L IS THE LENGTHOF THE ADAPTER[ps].

- INSTRUCTIONS -

1. CONNECTADAPTERTO PORT 1. PERFORMA FULL 12-TERM CALIBRATION USING Y' AND Y AS THE TEST PORTSAND STORE CALIBRATION TO DISK (e.g. YPRIME_Y.CAL).
2. CONNECTADAPTERTO PORT 2. PERFORMA FULL 12-TERM CALIBRATION USING X AND X' AS THE TEST PORTSAND STORE CALIBRATION TO DISK (e.g. X_XPRIME.CAL).
3. BOTH X AND Y CAL FILES MUST BE PLACED IN THE CURRENT DIRECTORY OF THE HARD OR FLOPPY DISK.
4. ENTER THE ELECTRICAL LENGTH OF THE ADAPTER.
5. SELECT <REMOVEADAPTER> TO READ THE X AND Y CAL FILES AND CALCULATE THE NEW SET OF 12-TERM ERROR COEFFICIENTS. IF DESIRED, SAVE RESULTS.

Menu EXT_CAR, Adapter Removal Help Menu

MENUS
ALPHABETICAL LISTING

C

MENU	DESCRIPTION
<p>ADAPTER REMOVAL</p> <p>READ CAL FILE OF THE Y TEST PORT FROM HARD DISK (ADAPTER ON PORT 1)</p> <p>READ CAL FILE OF THE Y TEST PORT FROM FLOPPY DISK (ADAPTER ON PORT 1)</p> <p>PRESS <ENTER> TO SELECT</p> <p>PRESS <CLEAR> TO ABORT</p>	<p>Calls Menu DSK2, which provides instructions.</p> <p>Calls Menu DSK2, which provides instructions.</p> <p>Pressing the Enter key implements the selection.</p> <p>Pressing the Clear key aborts the selection.</p>

Menu CAR3, Adapter Removal 3

MENU	DESCRIPTION
<p>ADAPTER REMOVAL</p> <p>COMPUTING NEW 12-TERM ERROR COEFFICIENTS</p>	<p>Information text.</p>

Menu CAR4, Adapter Removal 4

MENU	DESCRIPTION
SELECT DISPLAY MODE	
SINGLE CHANNEL	Selects a single channel for display. You select the type of display in menu GT1 or GT2.
DUAL CHANNELS 1 & 3	Selects Channels 1 and 3 for display. You select the type of display in menu GT1 or GT2.
OVERLAY DUAL CHANNELS 1 & 3	Lets you simultaneously view the Channel 1 data superimposed over the Channel 3 data on a single display. Channel 1 trace displays in red and Channel 3 in yellow.
DUAL CHANNELS 2 & 4	Selects Channels 2 and 4 for display. You select the type of display in menu GT1 or GT2.
OVERLAY DUAL CHANNELS 2 & 4	Lets you simultaneously view the Channel 2 data superimposed over the Channel 4 data on a single display. Channel 2 trace displays in red and Channel 4 in yellow.
ALL FOUR CHANNELS	Selects all four channels for display. You select the type of display in menu GT1 or GT2.
PRESS <ENTER> TO SELECT	Pressing the Enter key implements your menu selection. The menu remains on the screen until another menu is selected for display or until the CLEAR/RET LOC key is pressed.

Menu CM, Select Display Mode

MENU	DESCRIPTION
<p>DISCRETE FILL</p> <p>INPUT START, INCR, POINTS, THEN SELECT " FILL RANGE"</p> <p>START FREQ XXX.XXXXXXXXXX GHz</p> <p>INCREMENT XXX.XXXXXXXXXX GHz</p> <p>NUMBER OF PTS XXXX POINT(S)</p> <p>STOP FREQ XXX.XXXXXXXXXX GHz</p> <p>FILL RANGE (XXXX ENTERED)</p> <p>INDIVIDUAL FREQ INSERT</p> <p>CLEAR ALL</p> <p>FINISHED RETURN TO SWP</p> <p>PRESS <ENTER> TO SELECT</p>	<p>This menu is used to create one or more ranges of discrete equally spaced frequency points.</p> <p>Enter the first frequency of the range.</p> <p>Enter the increment (step size) between one frequency and the next.</p> <p>Enter the number of frequency points in the range.</p> <p>Enter the stop frequency, in GHz.</p> <p>Moving the cursor here and pressing Enter fills the range and shows the number of frequencies selected (in NUM OF PTS above).</p> <p>Calls menu DF2, which allows you to set the individual frequencies.</p> <p>Clears all entries displayed above.</p> <p>Closes this menu.</p> <p>Pressing the Enter key implements your menu selection.</p>

Menu DF1, Discrete Fill

MENU	DESCRIPTION
<p>INSERT INDIVIDUAL FREQUENCIES</p> <p>INPUT A FREQ, PRESS <ENTER> TO INSERT</p> <p>NEXT FREQ XXX.XXXXXXXXXX GHz</p> <p>XXXX FREQS ENTERED LAST FREQ WAS XXX.XXXXXXXXXX GHz</p> <p>AUTO INCR ON (OFF) XXX.XXXXXXXXXX GHz</p> <p>PREVIOUS MENU</p> <p>PRESS <ENTER> THEN SELECT OR TURN ON/OFF</p>	<p>Enter the start frequency, increment frequency, and number of points; then select the FILL RANGE menu option, below.</p> <p>Enter the sweep start frequency, in GHz.</p> <p>Enter the frequency, in GHz, by which you want to increment the start frequency.</p> <p>Enter the number of points.</p> <p>Enter the stop frequency, in GHz.</p> <p>Press the Enter key to implements your menu selection or to turn a se- lection on or off.</p>

Menu DF2, Insert Individual Frequencies

MENUS
ALPHABETICAL LISTING

D
E

MENU	DESCRIPTION
<p>WARNING</p> <p>DEFAULT PROGRAM SELECTED</p> <p>CONTINUING WILL ERASE CURRENT SETUP AND CALIBRATION</p> <p>PRESS <DEFAULT PRGM> TO CONFIRM</p> <p>OR</p> <p>PRESS <CLEAR> TO ABORT</p>	<p>Pressing the DEFAULT PROGRAM key a second time resets the 360 VNA to its default settings. Press the DEFAULT PROGRAM key, the "0" key, then the DEFAULT PROGRAM key again clears all internal memories. This keying method can be used to clear memories of data used for classified operations.</p> <p>Pressing the CLEAR key implements your menu selection.</p>

Menu DFLT, Default Program Selected

MENU	DESCRIPTION
DIAGNOSTICS	
START SELF TEST	Starts a self test of the 371XXA.
READ SERVICE LOG	Calls Menu DG2, which gives you options for using the Service Log.
INSTALLED OPTIONS	Displays the fitted options.
PERIPHERAL TESTS	Calls Menu DG3, which provides tests for peripherals such as the CRT, front panel, external keyboard, printer and GPIB interfaces.
TROUBLESHOOTING (FOR SERVICE USE ONLY)	Calls Menu DG4, which provides options for troubleshooting the 371XXA hardware. This menu is intended for use by a qualified service technician. Refer to the Model 371XXA Maintenance Manual for additional information.
HW CALIBRATIONS (FOR SERVICE USE ONLY)	Calls Menu DG5, which provides for invoking calibration routines for use by a qualified service technician. Refer to the Model 371XXA Maintenance Manual for additional information.
AUTOCAL ASSURANCE	Calls Menu ACAL_ASSUR, which provides for performing AutoCal assurance routines.
PRESS <ENTER> TO SELECT	Pressing the Enter key implements your menu selection.

Menu DG1, Diagnostics 1

MENUS
ALPHABETICAL LISTING

D
E

MENU	DESCRIPTION
<p>WARNING</p> <p>DEFAULT PROGRAM SELECTED</p> <p>CONTINUING WILL ERASE CURRENT SETUP AND CALIBRATION</p> <p>PRESS <DEFAULT PROGRAM> TO CONFIRM</p> <p>PRESS <CLEAR> TO ABORT</p>	<p>Pressing the DEFAULT PROGRAM key a second time resets the VNA to its default settings. Press the DEFAULT PROGRAM key, the "0" key, then the DEFAULT PROGRAM key again clears all internal memories. This keying method can be used to clear memories of data used for classified operations.</p> <p>Pressing the CLEAR key implements your menu selection.</p>

Menu DG2, Troubleshooting

MENU	DESCRIPTION
<p>PERIPHERAL TESTS</p> <p>CRT</p> <p>FRONT PANEL</p> <p>EXTERNAL KEYBOARD</p> <p>PRINTER INTERFACE</p> <p>GPIB INTERFACE</p> <p>PREVIOUS MENU</p> <p>PRESS <ENTER> TO SELECT</p>	<p>Provides a graphic display for evaluating screen colors and linearity.</p> <p>Provides for testing the front panel keys.</p> <p>Provides for testing the external keyboard connected to the Keyboard connector on the front panel.</p> <p>Provides for testing the printer interface.</p> <p>Provides for testing the GPIB interface.</p> <p>Returns to Menu DG1.</p> <p>Pressing the Enter key implements your menu selection.</p>

Menu DG3, Diagnostics 3

MENU	DESCRIPTION
FLOPPY DISK UTILITIES	
DISPLAY DIRECTORY	Directory displays in the screen's data area. Press <1> for previous page, <2> for next page, <0> for first page, and <3> for last page.
DELETE FILES	Calls DSK6, which lets you delete data files.
COPY FILES TO HARD DISK	Calls DSK8, which lets you copy files to the hard disk.
FORMAT FLOPPY DISK	Formats the floppy disk.
COMMAND LINE	Prompts a one-line dialog box that allows you to enter a command. The dialog box remains open only for the user interface.
HARD DISK UTILITIES	Calls DSK1-HD, which provides hard disk utilities.
PRESS <ENTER> TO SELECT	Pressing Enter implements your menu selection. You will be returned to the previous menu when your selection is made.

Menu DSK_FD, Floppy Disk Utilities

MENU	DESCRIPTION
HARD DISK UTILITIES	
DISPLAY DIRECTORY	Directory displays in the screen's data area. Press <1> for previous page, <2> for next page, <0> for first page, and <3> for last page.
DELETE FILES	Calls DSK6, which lets you delete data files.
COPY FILES TO FLOPPY DISK	Calls DSK8, which lets you copy files to the floppy disk.
FORMAT HARD DISK	Formats the hard disk.
COMMAND LINE	Prompts a one-line dialog box that allows you to enter a command. The dialog box remains open only for the user interface.
FLOPPY DISK UTILITIES	Calls DSK1-FD, which provides floppy disk utilities.

Menu DSK_HD, Hard Disk Utilities

MENUS
ALPHABETICAL LISTING

D
E

MENU	DESCRIPTION
SELECT FILE TO READ	
FILE 1	Displays the data stored in file number 1.
FILE 2	Displays the data stored in file number 2.
FILE 3	Displays the data stored in file number 3.
FILE 4	Displays the data stored in file number 4.
FILE 5	Displays the data stored in file number 5.
FILE 6	Displays the data stored in file number 6.
FILE 7	Displays the data stored in file number 7.
FILE 8	Displays the data stored in file number 8.
PREVIOUS MENU	Returns to the previous menu.
PRESS <ENTER> TO SELECT	Pressing the Enter key implements your menu selection.
PRESS <1> FOR PREVIOUS PAGE	Pressing the "1" key on the keypad returns to the previous page.
PRESS <2> FOR NEXT PAGE	Pressing the "2" key on the keypad produces the next page.

Menu DSK2, Select File to Read

MENU	DESCRIPTION
SELECT FILE TO OVERWRITE	
CREATE NEW FILE	
FILE 1	Select file number 1 to be overwritten with new data.
FILE 2	Select file number 2 to be overwritten with new data.
FILE 3	Select file number 3 to be overwritten with new data.
FILE 4	Select file number 4 to be overwritten with new data.
FILE 5	Select file number 5 to be overwritten with new data.
FILE 6	Select file number 6 to be overwritten with new data.
FILE 7	Select file number 7 to be overwritten with new data.
FILE 8	Select file number 8 to be overwritten with new data.
PREVIOUS MENU	Returns to the previous menu.
PRESS <ENTER> TO SELECT	Pressing the Enter key implements your menu selection.
PRESS <1> FOR PREVIOUS PAGE	Pressing the "1" key on the keypad returns to the previous page.
PRESS <2> FOR NEXT PAGE	Pressing the "2" key on the keypad produces the next page.

Menu DSK3, Select File to Overwrite

MENU	DESCRIPTION
<p>TYPE OF FILES TO DELETE</p>	
<p>FRONT PANEL SETUP AND CAL DATA</p>	<p>Calls Menu DSK7, which provides a list of front panel and calibration data file.</p>
<p>TRACE DATA</p>	<p>Calls Menu DSK7, which provides a list of trace data files to delete.</p>
<p>TABULAR DATA</p>	<p>Calls Menu DSK7, which provides a list of tabular data files to delete.</p>
<p>TEXT DATA</p>	<p>Calls Menu DSK7, which provides a list of text files to delete.</p>
<p>S2P DATA</p>	<p>Calls Menu DSK7, which provides a list of S2P data files to delete.</p>
<p>BITMAP DATA</p>	<p>Calls Menu DSK7, which provides a list of bitmap files to delete.</p>
<p>HPGL DATA</p>	<p>Calls Menu DSK7, which provides a list of HPGL files to delete.</p>
<p>ALL TYPES (*.*)</p>	<p>Calls Menu DSK7, which provides a list of all file types.</p>
<p>PREVIOUS MENU</p>	<p>Returns to the previous menu.</p>
<p>PRESS <ENTER> TO SELECT</p>	<p>Pressing the Enter key implements your menu selection.</p>

Menu DSK6, Type of Files to Delete

MENU	DESCRIPTION
SELECT FILE TO DELETE	
FILE 1	Selects file number 1 data to be deleted.
FILE 2	Selects file number 2 data to be deleted.
FILE 3	Selects file number 3 data to be deleted.
FILE 4	Selects file number 4 data to be deleted.
FILE 5	Selects file number 5 data to be deleted.
FILE 6	Selects file number 6 data to be deleted.
FILE 7	Selects file number 7 data to be deleted.
FILE 8	Selects file number 8 data to be deleted.
PREVIOUS MENU	Returns to the previous menu.
PRESS <ENTER> TO SELECT	Pressing the Enter key implements your menu selection.
PRESS <1> FOR PREVIOUS PAGE	Pressing the "1" key on the keypad returns to the previous page.
PRESS <2> FOR NEXT PAGE	Pressing the "2" key on the keypad produces the next page.

Menu DSK7, Select File to Delete

MENUS
ALPHABETICAL LISTING

D
E

MENU	DESCRIPTION
TYPE OF FILES TO COPY	
FRONT PANEL SETUP AND CAL DATA	Calls Menu DSK9, which provides a list of front panel and calibration data file.
TRACE DATA	Calls Menu DSK9, which provides a list of trace data files to copy.
TABULAR DATA	Calls Menu DSK9, which provides a list of tabular data files to copy.
TEXT DATA	Calls Menu DSK9, which provides a list of text files to copy.
S2P DATA	Calls Menu DSK9, which provides a list of S2P files to copy.
BITMAP DATA	Calls Menu DSK9, which provides a list of bitmap files to copy.
HPGL DATA	Calls Menu DSK9, which provides a list of HPGL files to copy.
ALL TYPES (*.*)	Calls Menu DSK9, which provides a list of all file types.
PREVIOUS MENU	Returns to the previous menu.
PRESS <ENTER> TO SELECT	Pressing the Enter key implements your menu selection.

Menu DSK8, Type of Files to Copy

MENU	DESCRIPTION
<p>SELECT FILE TO COPY</p>	
<p>FILE 1</p>	<p>Selects file number 1 data to be copied.</p>
<p>FILE 2</p>	<p>Selects file number 2 data to be copied.</p>
<p>FILE 3</p>	<p>Selects file number 3 data to be copied.</p>
<p>FILE 4</p>	<p>Selects file number 4 data to be copied.</p>
<p>FILE 5</p>	<p>Selects file number 5 data to be copied.</p>
<p>FILE 6</p>	<p>Selects file number 6 data to be copied.</p>
<p>FILE 7</p>	<p>Selects file number 7 data to be copied.</p>
<p>FILE 8</p>	<p>Selects file number 8 data to be copied.</p>
<p>PREVIOUS MENU</p>	<p>Returns to the previous menu.</p>
<p>PRESS <ENTER> TO SELECT</p>	<p>Pressing the Enter key implements your menu selection.</p>
<p>PRESS <1> FOR PREVIOUS PAGE</p>	<p>Pressing the "1" key on the keypad returns to the previous page.</p>
<p>PRESS <2> FOR NEXT PAGE</p>	<p>Pressing the "2" key on the keypad produces the next page.</p>

Menu DSK9, Select File to Copy

MENU	DESCRIPTION
<p>CAPTURE TABULAR DATA</p>	<p>Captures the tabular data to a file when the Enter key is pressed.</p>
<p>PRESS <ENTER> TO CONTINUE</p>	<p>Pressing the Enter key implements your menu selection.</p>

Menu DSK10, Capture Tabular Data

MENUS
ALPHABETICAL LISTING

D
E

MENU	DESCRIPTION
<p>CAUTION: ALL FLOPPY DISK DATA WILL BE ERASED</p> <p>INSERT DISK TO FORMAT</p> <p>PRESS <ENTER> TO CONTINUE</p>	<p>Ensure that you have the correct floppy diskette for formatting, then press the Enter key to begin the formatting process.</p> <p>Pressing the Enter key implements your menu selection.</p>

Menu DSK11, Format Floppy Disk

MENU	DESCRIPTION
<p>CAUTION: ALL HARD DISK DATA WILL BE ERASED</p> <p>ASSUME HARD DISK READY TO FORMAT</p> <p>PRESS <ENTER> TO CONTINUE</p>	<p>Assumes that the hard disk is ready to be formatted; press the Enter key to begin the formatting process.</p> <p>Pressing the Enter key implements your menu selection.</p>

Menu DSK12, Format Hard Disk

MENU	DESCRIPTION
<p style="text-align: center;">DATA ENHANCEMENT</p> <p>AVERAGING XXXX MEAS. PER POINT</p> <p>SMOOTHING XX.X PERCENT OF SWEEP</p> <p>SAMPLERS USED PER SWEEP X SAMPLERS</p>	<p>Averages the measured data over time, as follows:</p> <ol style="list-style-type: none"> 1. The sweep stops at the first frequency point and takes a number of readings, based on the selected number of points. 2. The program averages the readings and writes the average value for that frequency point in the displayed graph. 3. The sweep then advances to the next sequential frequency point and repeats the process. <p>Smooths the measured data over frequency, as follows:</p> <ol style="list-style-type: none"> 1. The program divides the overall sweep into smaller segments, based on the selected percent-of-span. (Refer to paragraph 4-4c and Figure 4-23 for a description and example of smoothing.) 2. It takes a data reading at each frequency point within that percent-of-span segment. 3. It averages the readings with a raised Hamming window and writes that magnitude value at the mid-frequency point of the segment in the displayed graph or Smith chart. 4. It then advances the percent-of-span segment to encompass the next sequential group of frequency points and repeats the process. <p>In the normal mode of operation, three samplers are used per forward or reverse sweep; two test samplers and a reference sampler. This results in both transmission and reflection parameters simultaneously.</p> <p>When a device such as a filter with a deep reject-band is measured, having both test samplers on reduces the measurement dynamic range. A higher noise floor in the reject band of the filter is observed. Selecting two samplers per sweep turns off one of the test samplers. This eliminates channel interaction and thereby improves the dynamic range.</p> <p>The drawbacks of using two sampler per sweep are a doubling of measurement time, as two complete one-direction sweeps are needed for both transmission and reflection parameters.</p>

Menu EM, Enhancement Menu

MENUS
ALPHABETICAL LISTING

G

MENU	DESCRIPTION
<p>SWEPT FREQUENCY GAIN COMPRESSION</p>	
<p>NOMINAL OFFSET -XX.XX dB</p>	<p>Shows gain of nominal offset. This value is the approximate gain (or loss) of the external devices preceding the AUT (amplifier under test). Specifically, the gain of the amplifier and attenuator combination. This value is used whenever flat test port power is turned OFF (while still existing) to prevent an unexpected jump in the power to the AUT.</p>
<p>CALIBRATE FOR FLATNESS (NO CAL EXISTS)</p>	<p>Calls Menu GC_SU8, which provides calibration options.</p>
<p>FLATNESS CORRECTION AT -XX.XX dBm</p>	<p>Shows value of the flatness correction.</p>
<p>CALIBRATE RECEIVER (NO CAL EXISTS)</p>	<p>Calls Menu GC_RCVR, which provides calibration options.</p>
<p>NORMALIZE S21 (NOT STORED)</p>	<p>Calls Menu GC_NORM.</p>
<p>GAIN COMPRESSION POINT (0 dB REF) XX.XX dB</p>	<p>This option is used with marker search functions. Value has a range from 0.05 to 9.99 dB and a default value of 1.00 dB. The search value is [negative] the gain compression point value. The reference is based on (maximum) with tracking ON.</p>
<p>TEST AUT</p>	<p>Closes the extended menu and displays the dual channels 1 & 3, with channel 3 active.</p>
<p>EXIT APPLICATION</p>	<p>Exits the gain compression application and returns to S-parameter measurements. It restores the measurement setup.</p>

Menu GC1, Swept Frequency Gain Compression

- SWEPT FREQUENCY GAIN COMPRESSION

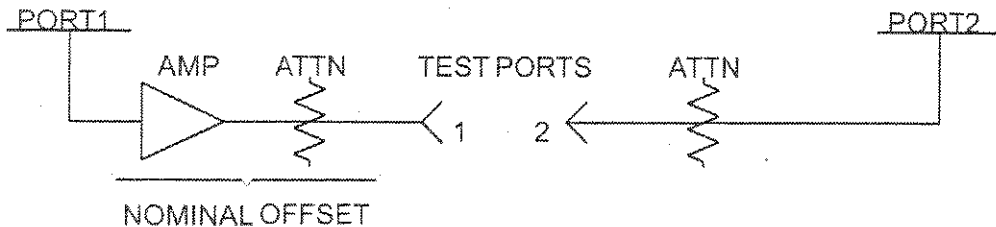

- CALIBRATION INSTRUCTIONS -

1. TEST PORT 1 POWER SHOULD BE APPROXIMATELY=
 $AUT(x \text{ dB compression spec}) - AUT(\text{gain}) - 15 \text{ dB}$
2. PORT 2 INPUT POWER SHOULD BE LESS THAN 0 dBm
 (UNLESS OPTION 6 IS INSTALLED).
3. NOMINAL OFFSET = APPROXIMATE GAIN (OR LOSS)
 OF EXTERNAL DEVICES PRECEDING THE AUT.
4. DEFAULT DISPLAY IS DUAL CHANNEL 1-3 IN WHICH
 CHANNEL 1 = b2/1 [dBm] AND CHANNEL 3 = S21.

- MEASUREMENT INSTRUCTIONS -

1. AFTER THE AUT IS CONNECTED, NORMALIZE S21.
2. INDICATE THE GAIN COMPRESSION POINT VALUE (x dB)
 AND SELECT <TEST AUT>.
3. INCREASE TEST PORT 1 POWER UNTIL A 1 dB (or x dB)
 DECREASE IN S21 IS OBSERVED.

Menu EXT_GC1, Gain Compression Help Menu 1

MENUS
ALPHABETICAL LISTING

MENU	DESCRIPTION
<p>SWEPT POWER GAIN COMPRESSION</p>	
<p>SET FREQUENCIES</p>	<p>Calls Menu GC_DF2, with it extended menu EXT_GC_DF2. There the you may enter from 1 to 10 discrete frequencies to be used by the application.</p>
<p>P START -XX.XX dBm</p>	<p>Defines the power sweep. The start and stop are limited by the actual power control range of the internal source. The stepsize resolution is limited to 0.05 dB.</p>
<p>P STOP -XX.XX dBm</p>	
<p>STEPSIZE X.XX dB</p>	
<p>ATTENUATION</p>	<p>Calls Menu GC_SU2, which lets you set attenuation values.</p>
<p>GAIN COMPRESSION POINT (MAX REF) XX.XX dB</p>	<p>This option is used with marker search functions. Value has a range from 0.05 to 9.99 dB and a default value of 1.00 dB. The search value is [negative] the gain compression point value. The reference is based on (maximum) with tracking ON.</p>
<p>NOMINAL OFFSET -XX.XX dB</p>	<p>This value is the approximate gain (or loss) of the external devices preceding the AUT. Specifically, the gain of the amplifier and attenuator combination. This value is used whenever power linearity is turned OFF (while still existing) to prevent an unexpected jump in the power to the AUT.</p>
<p>MORE PRESS <ENTER> TO SELECT</p>	<p>Calls Menu GC3, with is companion Menu EXT_CG3. Pressing the Enter key implements your menu selection.</p>

Menu GC2, Swept Power Gain Compression 1

- SWEPT POWER GAIN COMPRESSION -

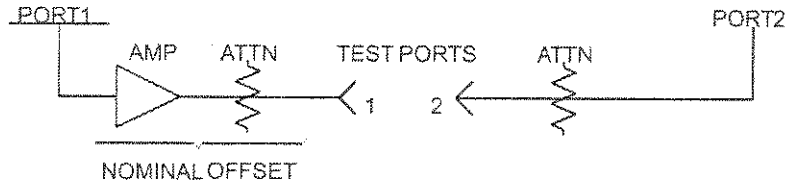

- CALIBRATION INSTRUCTIONS -

1. SET FREQUENCIES (FROM 1 TO 10 FREQS ALLOWED).
2. P START POWER SHOULD BE APPROXIMATELY =
 $AUT (x \text{ dB compression spec}) - AUT (\text{gain}) - 15 \text{ dB}$.
3. P STOP SHOULD BE 20 dB HIGHER THAN P START.
4. PORT 2 INPUT POWER SHOULD BE LESS THAN 0 dB
(UNLESS OPTION 6 IS INSTALLED).
5. INDICATE THE GAIN COMPRESSION POINT VALUE (x dB).
6. NOMINAL OFFSET = APPROXIMATE GAIN (OR LOSS)
OF EXTERNAL DEVICES PRECEDING THE AUT.

Menu EXT_GC2, Gain Compression Help Menu 2

MENUS
ALPHABETICAL LISTING

G

MENU	DESCRIPTION
<p>SWEPT POWER GAIN COMPRESSION</p>	
<p>CALIBRATE FOR LINEARITY (NO CAL EXISTS)</p>	<p>Calls Menu GC_SU8A with extended menu EXT_GC_SU8A and menu GC_SU8A_ABORT. Upon a successful power linearity calibration, menu GC2 reappears with (CAL EXISTS) and linearity correction ON.</p>
<p>LINEARITY ON (OFF) CORRECTION</p>	<p>Toggles the linearity correction on and off.</p>
<p>CALIBRATE RECEIVER (NO CAL EXISTS)</p>	<p>Calls Menu GC_RCVR.</p>
<p>NORMALIZE S21 (NOT STORED)</p>	<p>Calls Menu GC_NORM.</p>
<p>AUT TEST TYPES</p>	
<p>GAIN COMPRESSION</p>	<p>Closes the extended menu and displays the dual channels 1 & 3, with channel 3 active. Up to this point, the system is sweeping frequencies. Once <Test AUT> is pressed, the power sweep mode is turned ON and the system goes into single sweep and hold. One power sweep at the current power freq is done and the system goes into hold with Bias and RF ON. Pressing the Hold key will restart the sweep.</p>
<p>AM/PM</p>	<p>Closes the extended menu and displays dual channel 2 & 4, with Channel 4 becoming active. The power sweep mode is activated and the VNA goes into continuous sweep. The power sweeps at the current power frequency; the marker function is turned off, but markers remain. Channel 2 displays S21 on a Phase graph and Channel 4 displays S21 on a Log Magnitude graph.</p>
<p>MULTIPLE FREQ GAIN COMPRESSION</p>	<p>Calls Menu GC4.</p>
<p>RETURN TO SWEPT FREQUENCY MODE</p>	<p>Returns program to the swept frequency operational mode.</p>
<p>PREVIOUS MENU</p>	<p>Returns to previous menu.</p>
<p>PRESS <ENTER> TO SELECT OR TURN ON/OFF</p>	<p>Pressing the Enter key implements your menu selection.</p>

Menu GC3, Swept Power Gain Compression 2

- SWEPT POWER GAIN COMPRESSION -

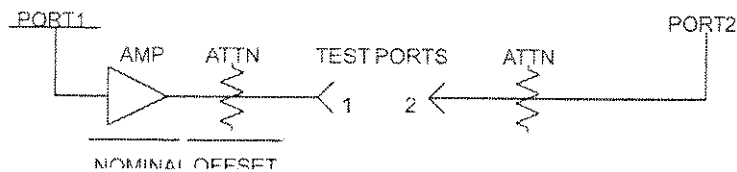

- CALIBRATION INSTRUCTIONS -

7. LINEARITY CALIBRATION IMPROVES ACCURACY.
8. RECEIVER CALIBRATION IS DONE AT P STOP.
NORMALIZE S21 IS DONE AT P START.
9. DEFAULT DISPLAY IS DUAL CHANNEL 1-3 IN WHICH
CHANNEL 1 = $b2/1$ [dBm] AND CHANNEL 3 = S21

-MEASUREMENT INSTRUCTIONS-

1. AFTER THE AUT IS CONNECTED, NORMALIZE S21.
2. SELECT <GAIN COMPRESSION> OR <AM/PM> AUT TEST.
3. MARKERS CAN BE USED TO LOCATE THE 1 dB (or x dB)
COMPRESSION POINT. CHANGE THE POWER FREQUENCY TO
MEASURE EACH OF THE OTHER POWER SWEEPS.
4. SELECT <MULTIPLE FREQ GAIN COMPRESSION> TO TEST
THE AUT AT ALL THE SWEPT POWER FREQUENCIES. THE
RESULTS ARE COMPUTED UNDER THE ASSUMPTION THAT
P OUTPUT AT P START IS IN THE AUT'S LINEAR REGION.

Menu EXT_GC3, Gain Compression Help Menu 3

MENU	DESCRIPTION
<p>MULTIPLE FREQUENCY GAIN COMPRESSION</p> <p>TEST AUT</p> <p>TEXT DATA TO HARD DISK</p> <p>TEXT DATA TO FLOPPY DISK</p> <p>SWEPT POWER GAIN COMPRESSION</p> <p>RETURN TO SWEPT FREQUENCY MODE</p> <p>PRESS <ENTER> TO SELECT</p>	<p>Calls Menu GC4_ABORT; and it turns on the power sweep mode and conducts a power sweep at each of the swept power frequencies. The gain compression points are computed under the assumption that P Output at P Start is in the AUT's linear region. The frequency, power in, and power out values are listed in a table. The power out versus frequency number is displayed in on a graph..</p> <p>When either Text Data to Hard Disk or Text Data to Floppy Disk are selected, the appropriate disk save file menu DSKx is displayed and the table is captured and recorded in a text file.</p> <p>Calls Menu CG3, which let you perform a Swept Power Gain Compression measurement.</p> <p>Pressing the Enter key implements your menu selection.</p>

Menu GC4, Multiple Frequency Gain Compression 1

MENU	DESCRIPTION
<p>MULTIPLE FREQUENCY GAIN COMPRESSION</p> <p>TESTING AUT</p> <p>PRESS <CLEAR> TO ABORT</p>	<p>Pressing the Clear key aborts the Multiple Frequency Gain Compression.</p>

Menu GC4_ABORT, Multiple Frequency Gain Compression 2

- MULTIPLE FREQUENCY GAIN COMPRESSION POINT -

SWEPT POWER FREQUENCIES	POWER IN	POWER OUT
1. XXX.XXXXXXXXXX GHz	-XX.XX dBm	-XX.XX dBm
2. XXX.XXXXXXXXXX GHz	-XX.XX dBm	-XX.XX dBm
3. XXX.XXXXXXXXXX GHz	-XX.XX dBm	-XX.XX dBm
4. XXX.XXXXXXXXXX GHz	-XX.XX dBm	-XX.XX dBm
5. XXX.XXXXXXXXXX GHz	-XX.XX dBm	-XX.XX dBm
6. XXX.XXXXXXXXXX GHz	-XX.XX dBm	-XX.XX dBm
7. XXX.XXXXXXXXXX GHz	-XX.XX dBm	-XX.XX dBm
8. XXX.XXXXXXXXXX GHz	-XX.XX dBm	-XX.XX dBm
9. XXX.XXXXXXXXXX GHz	-XX.XX dBm	-XX.XX dBm

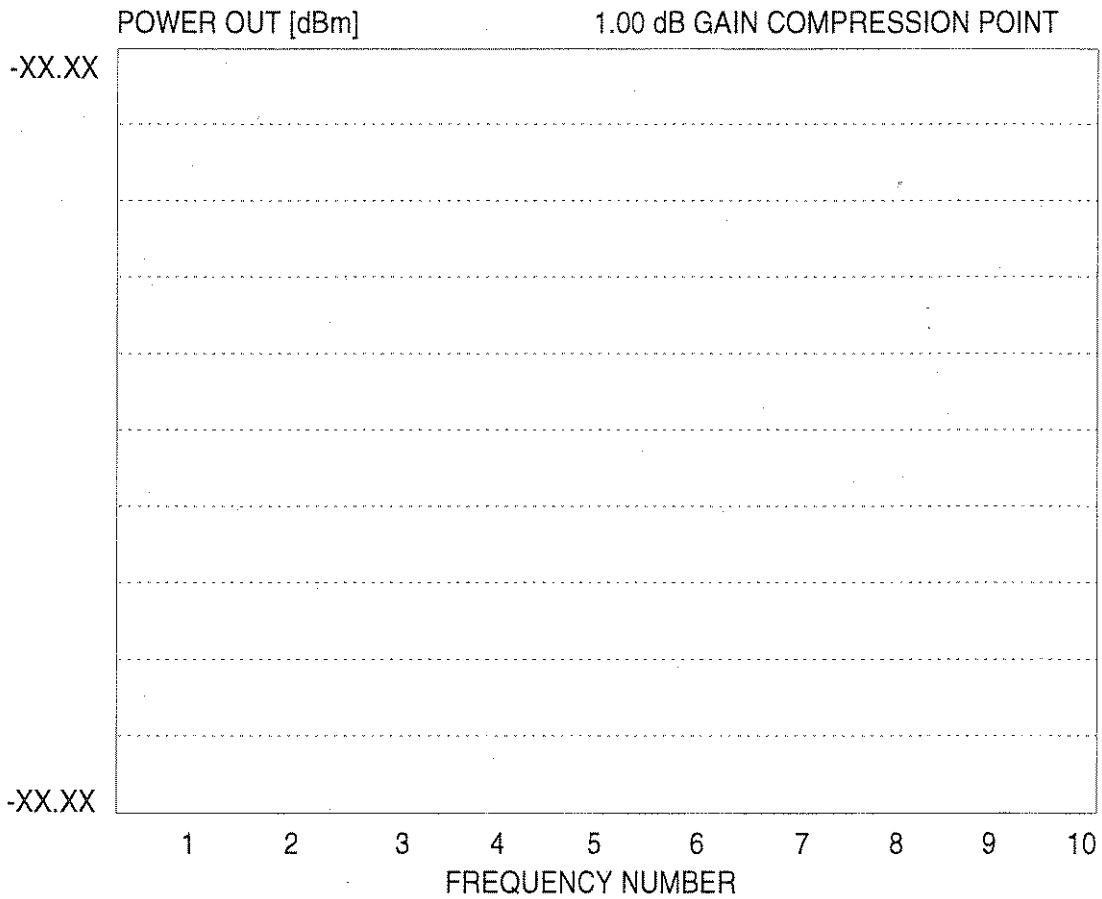

Menu EXT_GC4, Gain Compression Help Menu 4

MENU	DESCRIPTION
<p>SWEPT POWER FREQUENCIES</p> <p>INPUT A FREQ, PRESS <ENTER> TO INSERT</p> <p>SWEPT POWER FREQUENCY XXX.XXXXXXXXXX GHz</p> <p>CLEAR FREQ NUMBER XX</p> <p>CLEAR ALL</p> <p>FINISHED, RETURN TO POWER SWEEP SETUP</p> <p>PRESS <ENTER> TO SELECT</p>	<p>This menu performs in a similar manner to the Menu DF2, Insert Individual Frequencies. The list is updated and kept in ascending order. Any frequencies which are added or deleted force a resorting of the list. The user can enter from 1 to 10 swept power frequencies.</p> <p>Enter the swept power frequencies using the keypad or knob. Press <ENTER> to insert into the swept power frequency list</p> <p>Enter the number of the frequency to remove from the list using the keypad or knob. Press <ENTER> to remove the selection from the list.</p> <p>Press <ENTER> to remove all the frequencies from the swept power frequency list.</p> <p>After the swept power frequency list is entered, this returns to menu GC2.</p> <p>Pressing the Enter key implements your menu selection.</p>

Menu GC_DF2, Swept Power Frequencies

- MULTIPLE FREQUENCY GAIN COMPRESSION -

SWEPT POWER FREQUENCIES

1. XXX.XXXXXXXXXX GHz
2. XXX.XXXXXXXXXX GHz
3. XXX.XXXXXXXXXX GHz
4. XXX.XXXXXXXXXX GHz
5. XXX.XXXXXXXXXX GHz
6. XXX.XXXXXXXXXX GHz
7. XXX.XXXXXXXXXX GHz
8. XXX.XXXXXXXXXX GHz
9. XXX.XXXXXXXXXX GHz
10. XXX.XXXXXXXXXX GHz

Menu EXT_GC_DF2, Gain Compression Help Menu 5

MENU	DESCRIPTION
SWEPT POWER GAIN COMPRESSION	
PORT 1 ATTN 0*10 dB (0 - 70)	Attenuates the microwave source power at port 1 from 0 to 70 dB, in 10 dB steps. The power is attenuated before being applied to Port 1 for a forward transmission or reflection test (S_{21} or S_{11} , respectively).
PORT 2 ATTN 0*10 dB (0 - 40)	Attenuates from 0 to 40 dB (10 dB steps) the microwave power being input to Port 2 from the device-under-test (DUT).
PREVIOUS MENU	Returns to the previous menu.
PRESS <ENTER> TO SELECT	Pressing the Enter key implements your menu selection.

Menu GC_SU2, Swept Power Gain Compression 2

MENUS
ALPHABETICAL LISTING

G

MENU	DESCRIPTION
CALIBRATE FOR LINEAR POWER FORWARD DIRECTION ONLY START LINEAR POWER CALIBRATION PREVIOUS MENU PRESS <ENTER> TO SELECT	The power linearity calibration is done for each of the swept power frequencies across the power sweep range. The resolution of the calibration points is 0.25 dB. The maximum will be equal to the power sweep step size. The Linear Power Calibration is only done in the forward direction. Starts the linear power calibration. Returns to previous menu. Pressing the Enter key implements your menu selection.

Menu GC_SU8A, Calibrate for Linear Power

MENU	DESCRIPTION
LINEAR POWER CALIBRATION CALIBRATING FOR LINEAR POWER ... PRESS <CLEAR> TO ABORT	Pressing the Clear key aborts the Linear Power Calibration.

Menu GC_SU8A-ABORT, Abort Calibrate for Linear Power

- LINEAR POWER CALIBRATION -

- CALIBRATION INSTRUCTIONS -

LINEAR POWER CALIBRATION ADJUSTS THE SOURCE OUTPUT POWER FOR EACH POWER FREQUENCY POINT ACROSS THE POWER SWEEP RANGE TO PROVIDE A LINEAR POWER LEVEL AT THE TEST PORT (FORWARD DIRECTION ONLY).

- INSTRUCTIONS -

1. PRESET, ZERO, AND CALIBRATE THE POWER METER.
2. CREATE AND ACTIVATE THE POWER METER'S CAL FACTOR LIST FOR THE POWER SENSOR BEING USED.
3. CONNECT THE POWER METER TO THE DEDICATED GPIB INTERFACE AND THE POWER SENSOR TO THE TEST PORT.
4. SELECT <START LINEAR POWER CALIBRATION>.

XXX.X

Menu EXT_GC_SUSA, Gain Compression Help Menu 6

MENUS
ALPHABETICAL LISTING

G

MENU	DESCRIPTION
<p>RECEIVER CALIBRATION</p> <p>CONNECT THROUGHLINE BETWEEN TEST PORTS</p> <p>INCLUDE ANY COMPONENTS WHICH ARE PART OF THE MEASUREMENT PATH</p> <p>WAIT FOR ONE COMPLETE SWEEP BEFORE STORING</p> <p>PRESS <ENTER> TO STORE</p> <p>PRESS <CLEAR> TO ABORT</p>	<p>This menu lets you see if you have a good connection of the throughline before capturing the data by pressing <Enter>. The calibration may be aborted by pressing <Clear>. In both cases, menu GC1 or GC2 is displayed.</p> <p>Pressing the Enter key stores the receiver calibration.</p> <p>Pressing the Clear key aborts the Receiver calibration.</p>

Menu GC_RCVR, Receiver Calibration

MENU	DESCRIPTION
<p data-bbox="248 365 461 394">NORMALIZE S21</p> <p data-bbox="196 522 423 581">CONNECT AUT AND APPLY BIAS</p> <p data-bbox="196 615 454 705">WAIT FOR ONE COMPLETE SWEEP BEFORE STORING</p> <p data-bbox="240 739 467 798">PRESS <ENTER> TO STORE</p> <p data-bbox="240 831 467 890">PRESS <CLEAR> TO ABORT</p>	<p data-bbox="583 365 1458 491">This menu lets you see if you have a good connection of the throughline before capturing the data by pressing <Enter>. The calibration may be aborted by pressing <Clear>. In both cases, menu GC1 or GC3 is displayed.</p> <p data-bbox="583 739 1325 768">Pressing the Enter key stores the Normalized S21 calibration.</p> <p data-bbox="583 831 1317 861">Pressing the Clear key aborts the Normalized S21 calibration.</p>

Menu GC_NORM, Normalize S21

MENUS
ALPHABETICAL LISTING

G

MENU	DESCRIPTION
<p>SELECT LABEL ----- ABCDEFGHIJKLM NOPQRSTUVWXYZ 0123456789()- !#\$%&'@^_{}~</p> <p>* ? : \ . SP</p> <p>BKSP CLR DONE</p> <p>TURN KNOB TO INDICATE CHARACTER OR FUNCTION</p> <p>PRESS <ENTER> TO SELECT</p> <p>NUMBERS MAY ALSO BE SELECTED USING KEYPAD</p>	<p>Name your file using the rotary knob to select letters, numbers, or both. A letter or number turns red to indicate that the letter/number has been chosen for selection. Pressing the Enter key selects the letter or number. the name you spell out displays in the area below "SELECT NAME." You are allowed up to eight characters for a file name and twelve characters for a label.</p> <p>For keyboard command line entry.</p> <p>Selecting "BKSP" deletes the last letter in the name displayed above. Selecting "CLR" deletes the entire name. Selecting "DONE" signals that you have finished writing the name.</p> <p>Use the rotary knob to indicate the letter or number you wish to select. You can use the up-arrow and down-arrow keys to move between rows.</p> <p>Pressing the Enter key implements your menu selection. The menu remains on the screen until another menu is selected for display or until the CLEAR/RET LOC key is pressed.</p> <p>You may also select numbers and decimals using the keypad.</p>

Menu GP5, Select Name

MENU	DESCRIPTION
<p data-bbox="232 363 472 390">GPIB ADDRESSES</p> <p data-bbox="193 426 423 485">IEEE 488.2 GPIB INTERFACE</p> <p data-bbox="193 516 334 575">ADDRESS: 6</p> <p data-bbox="193 609 423 667">DEDICATED GPIB INTERFACE</p> <p data-bbox="193 699 480 758">EXTERNAL SOURCE 1 4</p> <p data-bbox="193 791 480 850">EXTERNAL SOURCE 2 5</p> <p data-bbox="193 884 318 942">PLOTTER 8</p> <p data-bbox="193 976 399 1035">POWER METER 13</p> <p data-bbox="193 1068 501 1127">FREQUENCY COUNTER 7</p>	<p data-bbox="578 516 1446 575">Selects the GPIB address for the 371XXA analyzer. The default address is 6.</p> <p data-bbox="578 699 1386 726">Selects the address for external source 1. The default address is 4.</p> <p data-bbox="578 791 1386 819">Selects the address for external source 2. The default address is 5.</p> <p data-bbox="578 884 1414 911">Selects the address for a compatible plotter. The default address is 8.</p> <p data-bbox="578 976 1446 1035">Selects the address for an HP4370 Power Meter. The default address is 13.</p> <p data-bbox="578 1068 1419 1127">Selects the address for an external frequency counter. The default address is 7.</p>

Menu GP7, Display GPIB Status

MENU	DESCRIPTION
SELECT GRAPH TYPE	
LOG MAGNITUDE	Selects a log magnitude graph for display on the active channel's selected S-parameter. The active channel is indicated by its key (CH1, CH2, CH3, CH4) being lit.
PHASE	Selects a phase graph for display on the active channel.
LOG MAGNITUDE AND PHASE	Selects log magnitude and phase graphs for display on the active channel.
SMITH CHART (IMPEDANCE)	Selects a Smith chart for display on the active channel.
SWR	Selects an SWR display for the active channel.
GROUP DELAY	Selects a Group Delay display for the active channel.
POWER OUT	Provides for measuring output power. The measurement of output power is accomplished by using the b2 (or Tb) measured value normalized to the power supplied to the AUT at Test Port 1. While the b2 parameter is the most meaningful for this graph type, you may use any other parameter.
MORE	Takes you to additional graph type selections on menu GT2.
PRESS <ENTER> TO SELECT AND RESUME CAL	Pressing the Enter key implements your menu selection (and resumes the calibration from where it left off, if in the calibration mode).

Menu GT1/CAL_GT1, Select Graph Type

MENU	DESCRIPTION
SELECT GRAPH TYPE	
SMITH CHART (ADMITTANCE)	Selects an Admittance Smith chart for display on the active channel's S-parameter.
LINEAR POLAR	Selects a Linear Polar graph for display on the active channel's S-parameter.
LOG POLAR	Selects a Log Polar graph for display on the active channel's S-parameter.
LINEAR MAG	Selects a Linear Magnitude graph for display on the active channel's S-parameter.
LINEAR MAG AND PHASE	Selects Linear Magnitude and Phase graphs for display on the active channel's S-parameter.
REAL	Selects Real data for display on the active channel's s-parameter.
IMAGINARY	Selects Imaginary data for display on the active channel's s-parameter.
REAL AND IMAGINARY	Selects both Real and Imaginary data for display on the active channel's S-parameter.
MORE	Takes you to additional graph type selections.
PRESS <ENTER> TO SELECT AND RESUME CAL	Pressing the Enter key implements your menu selection (and resumes the calibration from where it left off, if in the calibration mode).

Menu GT2/CAL_GT2, Select Graph Type

MENU	DESCRIPTION
SINGLE LIMITS	
—LOG MAG—	
UPPER LIMIT ON (OFF) XXX.XXX dB	Turns the Upper Limit line on or off for the active channel. For your convenience, the arbitrarily set limit lines allow you to delineate a go/no go line on your Log Mag display beyond which the measured values are unacceptable.
LOWER LIMIT ON(OFF) XXX.XXX dB	Turns the Lower Limit line on or off for the active channel on your Log Mag display.
READOUT LIMIT	Displays Menu LF1, which shows points where the current S-parameter intercepts the lower limit.
—PHASE—	
UPPER LIMIT ON (OFF) XXX.XXX°	Turns the Upper Limit line on or off for the active channel on your Phase display.
LOWER LIMIT ON(OFF) XXX.XXX °	Turns the Lower Limit line on or off for the active channel on your Phase display.
READOUT LIMIT	Displays Menu LF2, which shows points where the current S-parameter intercepts the lower limit.
DISPLAY ON (OFF) LIMITS	Enables both limit lines for the active channel on both the Log-Mag and Phase graphs.
TEST LIMITS	Calls Menu LTST, which provides choices for testing the limits.
SEGMENTED LIMITS	Calls a menu in the LS series (LSX), which lets you set segmented limit lines.

Menu L1, Set Limits—Magnitude and Phase

MENU	DESCRIPTION
SINGLE LIMITS	
--LINEAR POLAR--	
UPPER LIMIT ON (OFF) XXX.XXX mU	Turns the Upper Limit line on or off for the active channel. For your convenience, the arbitrarily set limit lines allow you to delineate a go/no go line on your Linear Polar display beyond which the measured values are unacceptable.
LOWER LIMIT ON(OFF) XXX.XXX mU	Turns the Lower Limit line on or off for the active channel on your Linear Polar display.
DISPLAY ON (OFF) LIMITS	Enables both previously set limit lines to appear for the active channel on your polar display.
TEST LIMITS	Calls Menu LTST, which provides choices for testing the limits.
PRESS <ENTER> TO SELECT OR TURN ON/OFF	Pressing the Enter key implements your menu selection.

Menu L2, Set Limits—Linear Polar

MENUS
ALPHABETICAL LISTING

L

MENU	DESCRIPTION
<p>SINGLE LIMITS</p> <p>-SMITH CHART-</p> <p>UPPER LIMIT ON (OFF) XXX.XXX mU</p> <p>LOWER LIMIT ON(OFF) XXX.XXX mU</p> <p>DISPLAY ON (OFF) LIMITS</p> <p>TEST LIMITS</p> <p>PRESS <ENTER> TO SELECT OR TURN ON/OFF</p>	<p>Turns the Upper Limit line on or off for the active channel. For your convenience, the arbitrarily set limit lines allow you to delineate a go/no go line on your Smith Chart display beyond which the measured values are unacceptable.</p> <p>Turns the Lower Limit line on or off for the active channel on your Smith Chart.</p> <p>Enables both previously set limit lines to appear for the active channel on your Smith Chart.</p> <p>Calls Menu LTST, which provides choices for testing the limits.</p> <p>Pressing the Enter key implements your menu selection.</p>

Menu L3, Set Limits—Linear Polar/Smith Chart

MENU	DESCRIPTION
SINGLE LIMITS	
-LOG MAG-	
UPPER LIMIT ON (OFF) XXX.XXX dB	Turns the Upper Limit line on or off for the active channel. For your convenience, the arbitrarily set limit lines allow you to delineate a go/no go line on your Log Mag display beyond which the measured values are unacceptable.
LOWER LIMIT ON(OFF) XXX.XXX dB	Turns the Lower Limit line on or off for the active channel on your Log Mag display.
READOUT LIMIT	Displays Menu LF1, which shows points where the current S-parameter intercepts the lower limit.
DISPLAY ON (OFF) LIMITS	Enables both previously set limit lines to appear for the active channel on your Log Mag display.
TEST LIMITS	Calls Menu LTST, which provides choices for testing the limits.
SEGMENTED LIMITS	Calls a menu in the LS series (LSX), which lets you set segmented limit lines.
PRESS <ENTER> TO SELECT OR TURN ON/OFF	Pressing the Enter key implements your menu selection.

Menu L4, Set Limits—Log Magnitude

MENU	DESCRIPTION
<p>SINGLE LIMITS</p> <p>-PHASE-</p> <p>UPPER LIMIT ON (OFF) XXX.XXX °</p> <p>LOWER LIMIT ON(OFF) XXX.XXX °</p> <p>READOUT LIMIT</p> <p>DISPLAY ON (OFF) LIMITS</p> <p>TEST LIMITS</p> <p>SEGMENTED LIMITS</p> <p>PRESS <ENTER> TO SELECT OR TURN ON/OFF</p>	<p>Turns the Upper Limit line on or off for the active channel. For your convenience, the arbitrarily set limit lines allow you to delineate a go/no go line on your Phase display beyond which the measured values are unacceptable.</p> <p>Turns the Lower Limit line on or off for the active channel on your Phase display.</p> <p>Displays Menu LF1, which shows points where the current S-parameter intercepts the lower limit.</p> <p>Enables both limit lines for the active channel on a phase graph.</p> <p>Calls Menu LTST, which provides choices for testing the limits.</p> <p>Calls a menu in the LS series (LSX), which lets you set segmented limit lines.</p> <p>Pressing the Enter key implements your menu selection.</p>

Menu L5, Set Limits—Phase

MENU	DESCRIPTION
SINGLE LIMITS	
-LOG POLAR-	
UPPER LIMIT ON (OFF) XXX.XXX dB	Turns the Upper Limit line on or off for the active channel. For your convenience, the arbitrarily set limit lines allow you to delineate a go/no go line on your Log Polar display beyond which the measured values are unacceptable.
LOWER LIMIT ON(OFF) XXX.XXX dB	Turns the Lower Limit line on or off for the active channel on your Log Polar display.
DISPLAY ON (OFF) LIMITS	Enables both previously set limit lines to appear for the active channel on your Log Polar display.
TEST LIMITS	Calls Menu LTST, which provides choices for testing the limits.
PRESS <ENTER> TO SELECT OR TURN ON/OFF	Pressing the Enter key implements your menu selection.

Menu L6, Set Limits—Log Polar

MENU	DESCRIPTION
<p>SINGLE LIMITS</p> <p>—GROUP DELAY—</p> <p>UPPER LIMIT ON (OFF) XXX.XXX fs</p> <p>LOWER LIMIT ON(OFF) XXX.XXX fs</p> <p>READOUT LIMIT</p> <p>DISPLAY ON (OFF) LIMITS</p> <p>TEST LIMITS</p> <p>SEGMENTED LIMITS</p> <p>PRESS <ENTER> TO SELECT OR TURN ON/OFF</p>	<p>Turns the Upper Limit line on or off for the active channel. For your convenience, the arbitrarily set limit lines allow you to delineate a go/no go line on your Group Delay display beyond which the measured values are unacceptable.</p> <p>Turns the Lower Limit line on or off for the active channel on your Group Delay display.</p> <p>Displays Menu LF1, which shows points where the current S-parameter intercepts the lower limit.</p> <p>Enables both previously set limit lines to appear for the active channel on your Group Delay display.</p> <p>Calls Menu LTST, which provides choices for testing the limits.</p> <p>Calls a menu in the LS series (LSX), which lets you set segmented limit lines.</p> <p>Pressing the Enter key implements your menu selection.</p>

Menu L7, Set Limits—Group Delay

MENU	DESCRIPTION
SINGLE LIMITS	
-LINEAR MAG-	
UPPER LIMIT ON (OFF) XXX.XXX pU	Turns the Upper Limit line on or off for the active channel. For your convenience, the arbitrarily set limit lines allow you to delineate a go/no go line on your Linear Mag display beyond which the measured values are unacceptable.
LOWER LIMIT ON(OFF) XXX.XXX pU	Turns the Lower Limit line on or off for the active channel on your Linear Mag display.
READOUT LIMIT	Displays Menu LF1, which shows points where the current S-parameter intercepts the lower limit.
DISPLAY ON (OFF) LIMITS	Enables both previously set limit lines to appear for the active channel on your Linear Mag display.
TEST LIMITS	Calls Menu LTST, which provides choices for testing the limits.
SEGMENTED LIMITS	Calls a menu in the LS series (LSX), which lets you set segmented limit lines.
PRESS <ENTER> TO SELECT OR TURN ON/OFF	Pressing the Enter key implements your menu selection.

Menu L8, Set Limits—Linear Magnitude

MENU	DESCRIPTION
SINGLE LIMITS	
-LINEAR MAG-	
UPPER LIMIT ON (OFF) XXX.XXX pU	Turns the Upper Limit line on or off for the active channel. For your convenience, the arbitrarily set limit lines allow you to delineate a go/no go line on your Linear Mag display beyond which the measured values are unacceptable.
LOWER LIMIT ON(OFF) XXX.XXX pU	Turns the Lower Limit line on or off for the active channel on your Linear Mag display.
READOUT LIMIT	Displays Menu LF4, which shows points where the current S-parameter intercepts the lower limit.
-PHASE-	
UPPER LIMIT ON (OFF) XXX.XXX °	Turns the Upper Limit line on or off for the active channel. For your convenience, the arbitrarily set limit lines allow you to delineate a go/no go line on your polar display beyond which the measured values are unacceptable.
LOWER LIMIT ON(OFF) XXX.XXX °	Turns the Lower Limit line on or off for the active channel on your Phase display.
READOUT LIMIT	Displays Menu LF2, which shows points where the current S-parameter intercepts the lower limit.
DISPLAY ON (OFF) LIMITS	Enables both previously set limit lines to appear for the active channel on your Phase display.
TEST LIMITS	Calls Menu LTST, which provides choices for testing the limits.
SEGMENTED LIMITS	Calls a menu in the LS series (LSX), which lets you set segmented limit lines.
PRESS <ENTER> TO SELECT OR TURN ON/OFF	Pressing the Enter key implements your menu selection.

Menu L9, Set Limits—Linear Magnitude and Phase

MENU	DESCRIPTION
SINGLE LIMITS	
-REAL-	
UPPER LIMIT ON (OFF) XXX.XXX pU	Turns the Upper Limit line on or off for the active channel. For your convenience, the arbitrarily set limit lines allow you to delineate a go/no go line on your Real display beyond which the measured values are unacceptable.
LOWER LIMIT ON(OFF) XXX.XXX pU	Turns the Lower Limit line on or off for the active channel on your Real display.
READOUT LIMIT	Displays Menu LF6, which shows points where the current S-parameter intercepts the lower limit.
DISPLAY ON (OFF) LIMITS	Enables both previously set limit lines to appear for the active channel on your Real values display.
TEST LIMITS	Calls Menu LTST, which provides choices for testing the limits.
SEGMENTED LIMITS	Calls a menu in the LS series (LSX), which lets you set segmented limit lines.
PRESS <ENTER> TO SELECT OR TURN ON/OFF	Pressing the Enter key implements your menu selection.

Menu L10, Set Limits—Real Values

MENU	DESCRIPTION
<p>SINGLE LIMITS</p> <p>–IMAGINARY–</p> <p>UPPER LIMIT ON (OFF) XXX.XXX pU</p> <p>LOWER LIMIT ON(OFF) XXX.XXX pU</p> <p>READOUT LIMIT</p> <p>DISPLAY ON (OFF) LIMITS</p> <p>TEST LIMITS</p> <p>SEGMENTED LIMITS</p> <p>PRESS <ENTER> TO SELECT OR TURN ON/OFF</p>	<p>Turns the Upper Limit line on or off for the active channel. For your convenience, the arbitrarily set limit lines allow you to delineate a go/no go line on your Imaginary display beyond which the measured values are unacceptable.</p> <p>Turns the Lower Limit line on or off for the active channel on your Imaginary display.</p> <p>Displays Menu LF7, which shows points where the current S-parameter intercepts the lower limit.</p> <p>Enables both previously set limit lines to appear for the active channel on your Imaginary values display.</p> <p>Calls Menu LTST, which provides choices for testing the limits.</p> <p>Calls a menu in the LS series (LSX), which lets you set segmented limit lines.</p> <p>Pressing the Enter key implements your menu selection.</p>

Menu L11, Set Limits—Imaginary Values

MENU	DESCRIPTION
SINGLE LIMITS	
-REAL-	
UPPER LIMIT ON (OFF) XXX.XXX pU	Turns the Upper Limit line on or off for the active channel. For your convenience, the arbitrarily set limit lines allow you to delineate a go/no go line on your Real display beyond which the measured values are unacceptable.
LOWER LIMIT ON(OFF) XXX.XXX pU	Turns the Lower Limit line on or off for the active channel on your Real display.
READOUT LIMIT	Displays Menu LF6, which shows points where the current S-parameter intercepts the lower limit.
-IMAGINARY-	
UPPER LIMIT ON (OFF) XXX.XXX pU	Turns the Upper Limit line on or off for the active channel. For your convenience, the arbitrarily set limit lines allow you to delineate a go/no go line on your Imaginary display beyond which the measured values are unacceptable.
LOWER LIMIT ON(OFF) XXX.XXX pU	Turns the Lower Limit line on or off for the active channel on your Imaginary display.
READOUT LIMIT	Displays Menu LF7, which shows points where the current S-parameter intercepts the lower limit.
DISPLAY ON (OFF) LIMITS	Enables both previously set limit lines to appear for the active channel on your Imaginary values display.
TEST LIMITS	Calls Menu LTST, which provides choices for testing the limits.
SEGMENTED LIMITS	Calls a menu in the LS series (LSX), which lets you set segmented limit lines.
PRESS TO SELECT OR TURN ON/OFF	Pressing the Enter key implements your menu selection.

Menu L12, Set Limits—Real and Imaginary Values

MENU	DESCRIPTION
SINGLE LIMITS	
—SWR—	
UPPER LIMIT ON (OFF) XXX.XXX pU	Turns the Upper Limit line on or off for the active channel. For your convenience, the arbitrarily set limit lines allow you to delineate a go/no go line on your SWR display beyond which the measured values are unacceptable.
LOWER LIMIT ON(OFF) XXX.XXX pU	Turns the Lower Limit line on or off for the active channel on your SWR display.
READOUT LIMIT	Displays Menu LF5, which shows points where the current S-parameter intercepts the lower limit.
DISPLAY ON (OFF) LIMITS	Enables both previously set limit lines to appear for the active channel.
TEST LIMITS	Calls Menu LTST, which provides choices for testing the limits.
SEGMENTED LIMITS	Calls a menu in the LS series (LSX), which lets you set segmented limit lines.
PRESS <ENTER> TO SELECT OR TURN ON/OFF	Pressing the Enter key implements your menu selection.

Menu L13, Set Limits—SWR

MENU	DESCRIPTION
SINGLE LIMITS	
—POWER OUT—	
UPPER LIMIT ON (OFF) XXX.XXX dBm	Turns the Upper Limit line on or off for the active channel. For your convenience, the arbitrarily set limit lines allow you to delineate a go/no go line on your power display beyond which the measured values are unacceptable.
LOWER LIMIT ON(OFF) XXX.XXX dBm	Turns the Lower Limit line on or off for the active channel on your power display.
READOUT LIMIT	Displays Menu LF5, which shows points where the current S-parameter intercepts the lower limit.
DISPLAY ON (OFF) LIMITS	Enables both previously set limit lines to appear for the active channel.
TEST LIMITS	Calls Menu LTST, which provides choices for testing the limits.
SEGMENTED LIMITS	Calls a menu in the LS series (LSX), which lets you set segmented limit lines.
PRESS <ENTER> TO SELECT OR TURN ON/OFF	Pressing the Enter key implements your menu selection.

Menu L14, Set Limits—Power Out

MENU	DESCRIPTION
<p>DEFINE UPPER SEGS</p>	<p>Define the upper limit segment.</p>
<p>SEGMENT ON (OFF) X</p>	<p>Enter the segment number that you want to define, and turn it on or off.</p>
<p>START POSITION</p>	
<p>HORIZONTAL XXX.XXXXXXXXXX GHz</p>	<p>Enter the start horizontal value in GHz, seconds, meter, or points (domain dependent).</p>
<p>VERTICAL XX.XXXXX dB</p>	<p>Enter the start vertical value in dB, degrees, units, or seconds (graph-type dependent).</p>
<p>STOP POSITION</p>	
<p>HORIZONTAL XXX.XXXXXXXXXX GHz</p>	<p>Enter the stop horizontal value in GHz, seconds, meter, or points (domain dependent).</p>
<p>VERTICAL XX.XXXXX dB</p>	<p>Enter the stop vertical value in dB, degrees, units, or seconds (graph-type dependent).</p>
<p>BEGIN NEXT</p>	<p>Turns the next segment on and sets its start and stop positions to the previous segment's stop position.</p>
<p>ATTACH NEXT</p>	<p>Turns the next segment on and sets its start positions to the previous segment's stop position.</p>
<p>CLEAR SEGMENT</p>	<p>Turns the current segment-to-define off and sets its start equal to its stop.</p>
<p>PREVIOUS MENU</p>	<p>Returns to the previous menu.</p>
<p>PRESS <ENTER> TO SELECT OR TURN ON/OFF</p>	<p>Pressing the Enter key implements your menu selection.</p>

Menu LD1, Define Upper Limit Segment

MENU	DESCRIPTION
DEFINE LOWER SEGS	Define the upper limit segment.
SEGMENT ON (OFF) X	Enter the segment number that you want to define, and turn it on or off.
START POSITION	
HORIZONTAL XXX.XXXXXXXXXX GHz	Enter the start horizontal value in GHz, seconds, meter, or points (domain dependent).
VERTICAL XX.XXXXX dB	Enter the start vertical value in dB, degrees, units, or seconds (graph-type dependent).
STOP POSITION	
HORIZONTAL XXX.XXXXXXXXXX GHz	Enter the stop horizontal value in GHz, seconds, meter, or points (domain dependent).
VERTICAL XX.XXXXX dB	Enter the stop vertical value in dB, degrees, units, or seconds (graph-type dependent).
BEGIN NEXT	Turns the next segment on and sets its start and stop positions to the previous segment's stop position.
ATTACH NEXT	Turns the next segment on and sets its start positions to the previous segment's stop position.
CLEAR SEGMENT	Turns the current segment-to-define off and sets its start equal to its stop.
PREVIOUS MENU	Returns to the previous menu.
PRESS <ENTER> TO SELECT OR TURN ON/OFF	Pressing the Enter key implements your menu selection.

Menu LD2, Define Lower Limit Segment

MENUS
ALPHABETICAL LISTING

L

MENU	DESCRIPTION
<p>READOUT LIMIT INTERCEPTS</p> <p>—LOG MAG—</p> <p>UPPER LIMIT (REF) XXX.XXX dB</p> <p>LOWER LIMITdB XXX.XXX dB</p> <p>LIMIT DIFFERENCE (UPPER-LOWER) XXX.XXX dB</p> <p>INTERCEPTS AT LOWER LIMIT</p> <p>XXX.XXXXXXXXXX GHz XXX.XXXXXXXXXX GHz XXX.XXXXXXXXXX GHz XXX.XXXXXXXXXX GHz XXX.XXXXXXXXXX GHz</p>	<p>Lets you set the UPPER LIMIT (REF) limit line. Changing this value also moves the lower limit line by the LIMIT DIFFERENCE amount.</p> <p>Lets you set the LOWER LIMIT dB limit line. Changing this value also changes the LIMIT DIFFERENCE amount relative to the UPPER LIMIT (REF) value.</p> <p>Lets you set the LIMIT DIFFERENCE amount. Changing this value also changes the lower limit value relative to the UPPER LIMIT (REF) value.</p> <p>Displays at which frequencies the data intercepts the lower limit. May be interpolated.</p>

Menu LF1, Set Limit Frequencies—Log Mag

MENU	DESCRIPTION
READOUT LIMIT INTERCEPTS —PHASE— UPPER LIMIT (REF) XXX.XXX ° LOWER LIMITdB XXX.XXX ° LIMIT DIFFERENCE (UPPER-LOWER) INTERCEPTS AT LOWER LIMIT XXX.XXXXXXXXXX GHz XXX.XXXXXXXXXX GHz XXX.XXXXXXXXXX GHz XXX.XXXXXXXXXX GHz XXX.XXXXXXXXXX GHz	<p>Lets you set the UPPER LIMIT (REF) limit line. Changing this value also moves the lower limit line by the LIMIT DIFFERENCE amount.</p> <p>Lets you set the LOWER LIMIT dB limit line. Changing this value also changes the LIMIT DIFFERENCE amount relative to the UPPER LIMIT (REF) value.</p> <p>Lets you set the LIMIT DIFFERENCE amount. Changing this value also changes the lower limit value relative to the UPPER LIMIT (REF) value.</p> <p>Displays at which frequencies the data intercepts the lower limit. May be interpolated.</p>

Menu LF2, Set Limit Frequencies—Phase

MENUS
ALPHABETICAL LISTING

L

MENU	DESCRIPTION
<p>READOUT LIMIT INTERCEPTS</p> <p>—GROUP DELAY—</p> <p>UPPER LIMIT (REF) XXX.XXX fs</p> <p>LOWER LIMIT XXX.XXX fs</p> <p>LIMIT DIFFERENCE (UPPER-LOWER)</p> <p>INTERCEPTS AT LOWER LIMIT</p> <p>XXX.XXXXXXXXXX GHz XXX.XXXXXXXXXX GHz XXX.XXXXXXXXXX GHz XXX.XXXXXXXXXX GHz XXX.XXXXXXXXXX GHz</p>	<p>Lets you set the UPPER LIMIT (REF) limit line. Changing this value also moves the lower limit line by the LIMIT DIFFERENCE amount.</p> <p>Lets you set the LOWER LIMIT dB limit line. Changing this value also changes the LIMIT DIFFERENCE amount relative to the UPPER LIMIT (REF) value.</p> <p>Lets you set the LIMIT DIFFERENCE amount. Changing this value also changes the lower limit value relative to the UPPER LIMIT (REF) value.</p> <p>Displays at which frequencies the data intercepts the lower limit. May be interpolated.</p>

Menu LF3, Set Limit Frequencies—Group Delay

MENU	DESCRIPTION
READOUT LIMIT INTERCEPTS —LINEAR MAG— UPPER LIMIT (REF) XXX.XXX pU LOWER LIMIT XXX.XXX pU LIMIT DIFFERENCE (UPPER-LOWER) XXX.XXX pU INTERCEPTS AT LOWER LIMIT XXX.XXXXXXXXXX GHz XXX.XXXXXXXXXX GHz XXX.XXXXXXXXXX GHz XXX.XXXXXXXXXX GHz XXX.XXXXXXXXXX GHz	<p>Lets you set the UPPER LIMIT (REF) limit line. Changing this value also moves the lower limit line by the LIMIT DIFFERENCE amount.</p> <p>Lets you set the LOWER LIMIT dB limit line. Changing this value also changes the LIMIT DIFFERENCE amount relative to the UPPER LIMIT (REF) value.</p> <p>Lets you set the LIMIT DIFFERENCE amount. Changing this value also changes the lower limit value relative to the UPPER LIMIT (REF) value.</p> <p>Displays at which frequencies the data intercepts the lower limit. May be interpolated.</p>

Menu LF4, Set Limit Frequencies—Linear Mag

MENUS
ALPHABETICAL LISTING

L

MENU	DESCRIPTION
<p>SET LIMIT FREQUENCIES</p> <p>—SWR—</p> <p>UPPER LIMIT (REF) XXX.XXX pU</p> <p>LOWER LIMIT XXX.XXX pU</p> <p>LIMIT DIFFERENCE (UPPER-LOWER) XXX.XXX pU</p> <p>INTERCEPTS AT LOWER LIMIT</p> <p>XXX.XXXXXXXXXX GHz XXX.XXXXXXXXXX GHz XXX.XXXXXXXXXX GHz XXX.XXXXXXXXXX GHz XXX.XXXXXXXXXX GHz</p>	<p>Lets you set the UPPER LIMIT (REF) limit line. Changing this value also moves the lower limit line by the LIMIT DIFFERENCE amount.</p> <p>Lets you set the LOWER LIMIT dB limit line. Changing this value also changes the LIMIT DIFFERENCE amount relative to the UPPER LIMIT (REF) value.</p> <p>Lets you set the LIMIT DIFFERENCE amount. Changing this value also changes the lower limit value relative to the UPPER LIMIT (REF) value.</p> <p>Displays at which frequencies the data intercepts the lower limit. May be interpolated.</p>

Menu LF5, Set Limit Frequencies—SWR

MENU	DESCRIPTION
SET LIMIT FREQUENCIES —REAL— UPPER LIMIT (REF) XXX.XXX pU LOWER LIMIT XXX.XXX pU LIMIT DIFFERENCE (UPPER-LOWER) INTERCEPTS AT LOWER LIMIT XXX.XXXXXXXXXX GHz XXX.XXXXXXXXXX GHz XXX.XXXXXXXXXX GHz XXX.XXXXXXXXXX GHz XXX.XXXXXXXXXX GHz	<p>Lets you set the UPPER LIMIT (REF) limit line. Changing this value also moves the lower limit line by the LIMIT DIFFERENCE amount.</p> <p>Lets you set the LOWER LIMIT dB limit line. Changing this value also changes the LIMIT DIFFERENCE amount relative to the UPPER LIMIT (REF) value.</p> <p>Lets you set the LIMIT DIFFERENCE amount. Changing this value also changes the lower limit value relative to the UPPER LIMIT (REF) value.</p> <p>Displays at which frequencies the data intercepts the lower limit. May be interpolated.</p>

Menu LF6, Set Limit Frequencies—Real

MENUS
ALPHABETICAL LISTING

L

MENU	DESCRIPTION
<p>SET LIMIT FREQUENCIES</p> <p>—IMAGINARY—</p> <p>UPPER LIMIT (REF) XXX.XXX pU</p> <p>LOWER LIMIT XXX.XXX pU</p> <p>LIMIT DIFFERENCE (UPPER-LOWER)</p> <p>INTERCEPTS AT LOWER LIMIT</p> <p>XXX.XXXXXXXXXX GHz XXX.XXXXXXXXXX GHz XXX.XXXXXXXXXX GHz XXX.XXXXXXXXXX GHz XXX.XXXXXXXXXX GHz</p>	<p>Lets you set the UPPER LIMIT (REF) limit line. Changing this value also moves the lower limit line by the LIMIT DIFFERENCE amount.</p> <p>Lets you set the LOWER LIMIT dB limit line. Changing this value also changes the LIMIT DIFFERENCE amount relative to the UPPER LIMIT (REF) value.</p> <p>Lets you set the LIMIT DIFFERENCE amount. Changing this value also changes the lower limit value relative to the UPPER LIMIT (REF) value.</p> <p>Displays at which frequencies the data intercepts the lower limit. May be interpolated.</p>

Menu LF7, Set Limit Frequencies—Imaginary

MENU	DESCRIPTION
READOUT LIMIT INTERCEPTS	
—POWER OUT—	
UPPER LIMIT (REF) XXX.XXX dBm	Lets you set the UPPER LIMIT (REF) limit line. Changing this value also moves the lower limit line by the LIMIT DIFFERENCE amount.
LOWER LIMIT XXX.XXX dBm	Lets you set the LOWER LIMIT dB limit line. Changing this value also changes the LIMIT DIFFERENCE amount relative to the UPPER LIMIT (REF) value.
LIMIT DIFFERENCE (UPPER-LOWER) XXX.XXX dBm	Lets you set the LIMIT DIFFERENCE amount. Changing this value also changes the lower limit value relative to the UPPER LIMIT (REF) value.
INTERCEPTS AT LOWER LIMIT XXX.XXXXXXXXXX GHz XXX.XXXXXXXXXX GHz XXX.XXXXXXXXXX GHz XXX.XXXXXXXXXX GHz XXX.XXXXXXXXXX GHz	Displays at which frequencies the data intercepts the lower limit. May be interpolated.

Menu LF8, Set Limit Frequencies—Power Out

MENU	DESCRIPTION
SEGMENTED LIMITS	
—XXXXXXX—	Displays the currently active channel's graph type.
UPPER LIMIT ON(OFF)	Turns the Upper Limit line on or off for the active channel.
DEFINE UPPER	Calls menu LD1, which lets you define an upper segment value.
LOWER LIMIT ON(OFF)	Turns the Lower Limit line on or off for the active channel.
DEFINE LOWER	Calls menu LD2, which lets you define a lower segment value.
SEGMENTED OFFSETS	
HORIZONTAL XXXX GHz	Enter the horizontal offset to be applied to all of the channel's segmented limits, in GHz, seconds, meters, or points (domain dependent).
VERTICAL XXXX dB	Enter the vertical offset to be applied to all of the channel's segmented limits, in dB, degrees, units, or seconds (graph-type dependent).
CLEAR ALL	Clears all segments.
DISPLAY ON (OFF) LIMITS	Toggle between on and off to display the active channel's limits.
TEST LIMITS	Calls menu LTST, which lets test for limits.
SINGLE LIMITS	Returns to the appropriate single limits menu.
PRESS <ENTER> TO SELECT OR TURN ON/OFF	Pressing the Enter key implements your menu selection.

Menu LSX, Segmented Limits

MENU	DESCRIPTION
TEST LIMITS	
LIMIT ON (OFF) TESTING	Turns limit testing for all displayed channels on or off.
BEEP FOR ON (OFF) TEST FAILURE	Turns beeper on or off when limit test fails.
LIMIT TEST TTL FAIL CONDITION TTL LOW/TTL HIGH	Selects between a TTL high or TTL low to indicate that the limit test has failed.
CHANNEL 1 TEST PASS (FAIL)	Displays result of Channel 1 limit test.
CHANNEL 2 TEST PASS (FAIL)	Displays result of Channel 2 limit test.
CHANNEL 3 TEST PASS (FAIL)	Displays result of Channel 3 limit test.
CHANNEL 4 TEST PASS (FAIL)	Displays result of Channel 4 limit test.
PRESS <ENTER> TO SELECT OR TURN ON/OFF	Pressing the Enter key implements your menu selection.

Menu LTST, Test Limits

MENU	DESCRIPTION
<p>SET MARKERS</p> <p>MARKER 1 ON (OFF) XXX.XXXXXXXXXX GHz</p> <p>MARKER 2 ΔREF ON (OFF) XXX.XXXXXXXXXX GHz</p> <p>MARKER 3 ON (OFF) XXX.XXXXXXXXXX GHz</p> <p>MARKER 4 ON (OFF) XXX.XXXXXXXXXX GHz</p> <p>MARKER 5 ON (OFF) XXX.XXXXXXXXXX GHz</p> <p>MARKER 6 ON (OFF) XXX.XXXXXXXX GHz</p> <p>DISPLAY ON (OFF) MARKERS</p> <p>ΔREF MODE ON (OFF)</p> <p>SELECT ΔREF MARKER</p> <p>READOUT MARKER FUNCTIONS</p>	<p>Turns Marker 1 on or off (activates or deactivates). When on (active), the frequency, time, or distance may be set using the keypad or rotary knob.</p> <p style="text-align: center;">NOTE</p> <p>In this text, markers are referred to as being active and as being selected. Any marker that has been turned on and assigned a frequency is considered to be selected. The marker to which the cursor presently points is considered to be active. The active marker is the only one for which you can change the frequency.</p> <p>Turns Marker 2 on or off (activates or deactivates). When on (active), the frequency, time, or distance may be set using the keypad or rotary knob.</p> <p>Turns Marker 3 on or off (activates or deactivates). When on (active), the frequency, time, or distance may be set using the keypad or rotary knob.</p> <p>Turns Marker 4 on or off (activates or deactivates). When on (active), the frequency, time, or distance may be set using the keypad or rotary knob.</p> <p>Turns Marker 5 on or off (activates or deactivates). When on (active), the frequency, time, or distance may be set using the keypad or rotary knob.</p> <p>Turns Marker 6 on or off (activates or deactivates). When on (active), the frequency, time, or distance may be set using the keypad or rotary knob.</p> <p>Displays selected markers.</p> <p>Selects the ΔREF Mode to be on or off.</p> <p>Calls Menu M2, which lets you select the ΔREF Marker.</p> <p>Calls Menu M9, which lets you select readout marker parameters.</p>

Menu M1, Set Markers

MENU	DESCRIPTION
<p>SELECT ΔREF MARKER</p> <p>MARKER 1 XXX.XXXXXXXXXX GHz</p> <p>MARKER 3 XXX.XXXXXXXXXX GHz</p> <p>MARKER 4 XXX.XXXXXXXXXXGHz</p> <p>PRESS <ENTER> TO SELECT</p>	<p>Marker 1 only appears if it has been activated in Menu M1. Placing the cursor on Marker 1 and pressing the Enter key here selects it as the ΔREF marker. The ΔREF marker is the one from which the other active markers are compared and their difference frequency measured and displayed in Menu M3. The marker frequency may be set using the keypad or rotary knob.</p> <p>Same as above, but for Marker 3. <i>This display is representative if Markers 1, 3, and 4 are selected. Markers 2, 5, and 6 would also show, if they had been selected.</i></p> <p>Same as above, but for Marker 4</p> <p>Pressing the Enter key implements your menu selection.</p>

Menu M2, Select REF Marker

MENUS
ALPHABETICAL LISTING

M

MENU	DESCRIPTION
<p style="text-align: center;">SELECT READOUT MARKER</p> <p>MARKER 1 XXX.XXXXXXXXXX GHz</p> <p>MARKER 2 XXX.XXXXXXXXXX GHz</p> <p>MARKER 5 XXX.XXXXXXXXXX GHz</p> <p>ΔREF MODE IS ON (OFF)</p> <p style="text-align: center;">PRESS <ENTER> TO SELECT</p>	<p>Displays the frequency and S-Parameter value(s) of Marker 1 on all CRT-displayed graphs and Smith Charts. The frequency of Marker 1 also displays here. If Marker 1 was activated in Menu M2 as the REF marker, REF appears as shown for Marker M5 below.</p> <p>Same as above, but for Marker 2.</p> <p>Same as above, but for Marker 5 <i>This display is representative if Markers 1, 2, and 5 are selected. Markers 3, 4, and 6 would also show, if they had been selected.</i></p> <p>Indicates the status of the ΔREF mode.</p> <p>Pressing the Enter key implements your menu selection.</p>

Menu M3, Select Readout Marker

MENU	DESCRIPTION
CH 1 — S 1 1	Selects channel for readout
REFERENCE PLANE X.XXXX mm	
MARKER 1 XXX.XXXXXXXXXX GHz XX.XXX dB XXX.XXX °	The selected marker—that is, the one to which the cursor points in Menu M1—and its frequency, time, or distance display here. This could be any one of the six available markers: Marker 1 thru Marker 6.
MARKER TO MAX	Causes the active marker to go to the frequency with the <i>greatest</i> S-Parameter value on the active channel.
MARKER TO MIN	Causes the selected marker to go to the frequency with the <i>smallest</i> S-Parameter value on the active channel.
2 XXX.XXXXXXXXXX GHz XX.XXX dB XXX.XXX °	Displays the frequency, magnitude, and phase of the active S-Parameter at marker 2, if the marker is enabled.
3 XXX.XXXXXXXXXX GHz XX.XXX dB XXX.XXX °	Displays the frequency, magnitude, and phase of the active S-Parameter at marker 3, if the marker is enabled.
4 XXX.XXXXXXXXXX GHz XX.XXX dB XXX.XXX °	Displays the frequency, magnitude, and phase of the active S-Parameter at marker 4, if the marker is enabled.
5 XXX.XXXXXXXXXX GHz XX.XXX dB XXX.XXX °	Displays the frequency, magnitude, and phase of the active S-Parameter at marker 5, if the marker is enabled.
6 XXX.XXXXXXXXXX GHz XX.XXX dB XXX.XXX °	Displays the frequency, magnitude, and phase of the active S-Parameter at marker 6, if the marker is enabled.
MARKER READOUT FUNCTIONS	Calls Menu M9, which lets you select readout marker parameters.

Menu M4, Readout Marker

MENUS
ALPHABETICAL LISTING

M

MENU	DESCRIPTION
<p>CH 1 – S11</p> <p>REFERENCE PLANE X.XXXX mm</p> <p>MARKER 1 XXX.XXXXXXXXXX GHz MARKER TO MAX MARKER TO MIN</p> <p>$\Delta(1 - 2)$ XXX.XXXXXXXXXX GHz XX.XXX dB XXX.XXX °</p> <p>$\Delta(1 - 3)$ XXX.XXXXXXXXXX GHz XX.XXX dB XXX.XXX °</p> <p>$\Delta(1 - 4)$ XXX.XXXXXXXXXX GHz XX.XXX dB XXX.XXX °</p> <p>$\Delta(1 - 5)$ XXX.XXXXXXXXXX GHz XX.XXX dB XXX.XXX °</p> <p>$\Delta(1 - 6)$ XXX.XXXXXXXXXX GHz XX.XXX dB XXX.XXX °</p> <p>MARKER READOUT FUNCTIONS</p>	<p>The selected marker—that is, the one to which the cursor points in Menu M1—and its frequency, time, or distance display here. This could be any one of the six available markers: Marker 1 thru Marker 6.</p> <p>The marker numbers of the REF marker and the next lowest-numbered selected marker appear between the parentheses. This example assumes Marker 1 as the Ref marker and Marker 2 as the next lowest-numbered selected marker. The lines below display the difference frequency, (or time/distance) and trace value(s) between these two markers on the active channel.</p> <p>Same as above, except Marker 3 is the next lowest-numbered selected marker.</p> <p>Same as above, except Marker 4 is the next lowest-numbered selected marker.</p> <p>Same as above, except Marker 5 is the next lowest-numbered selected marker.</p> <p>Same as above, except Marker 6 is the next lowest-numbered selected marker.</p> <p>Calls Menu M9, which lets you select readout marker parameters.</p>

Menu M5, Set REF Marker Readout

MENU	DESCRIPTION
MARKER X ALL DISPLAYED CHANNELS	<p>Displays the active marker number. For each channel being displayed, the channel, S-Parameter, frequency, time, distance or point number, and the current readout value for the marker is shown (below). No marker information is provided for channels that are not displayed.</p>
CH 1 — S11 XX.XXXXXXXXXX GHz -XXX.XXX dB -XXX.XX °	<p>Displays the measured value for the active marker on all channels currently being displayed. You can set the marker on the active channel in this menu. The active channel is displayed in GREEN; when not active it is displayed in BLUE.</p>
CH 2 — S21	<p>See above.</p>
CH 3 — S12 XX.XXXXXXXXXX GHz -XXX.XXX dB -XXX.XX °	<p>See above.</p>
CH 4 — S22	<p>See above.</p>
MARKER TO MAX	<p>Causes the active marker to go to the frequency with the <i>greatest</i> S-Parameter value on the active channel.</p>
MARKER TO MIN	<p>Causes the selected marker to go to the frequency with the <i>smallest</i> S-Parameter value on the active channel.</p>
MARKER READOUT FUNCTIONS	<p>Calls Menu M9, which lets you select readout marker parameters.</p>
PRESS <ENTER> TO SELECT	<p>Pressing the Enter key implements menu selection.</p>

Menu M6, Marker X All Displayed Channels

MENU	DESCRIPTION
<p>SEARCH</p> <p>VALUE -XXX.XXX dB</p> <p>REFERENCE</p> <p>MAXIMUM VALUE</p> <p>Δ REF MARKER</p> <p>0 dB</p> <p>VALUE AT REFERENCE -XXX.XXX dB</p> <p>SEARCH LEFT</p> <p>SEARCH RIGHT</p> <p>XX.XXXXXXXXXX GHz</p> <p>SEARCH MRKR VALUES CH1: XX.XXX dB CH2: XX.XXX dB CH3: XX.XXX dB CH4: XX.XXX dB</p> <p>TRACKING ON (OFF)</p> <p>MARKER READOUT FUNCTIONS</p>	<p>This menu provides control and readout for the marker search function. When this function is selected, the graph type for the active channel is automatically set to LOG MAGNITUDE (other graph types are not allowed), and taken out of time domain low pass or band pass display. Frequency with time gate display is allowed.</p> <p>Target search value. A value from -999.999 to 999.999 dB may be entered.</p> <p>These menu choices let you enter the reference value for the search. The reference may be: -Graticule "0 dB" -Position of Delta Ref. Marker (Marker 1 is used as the Δ Ref Marker) -Maximum value in Passband (default selection). Marker 1 is used to indicate maximum.</p> <p>Selects maximum value as the reference.</p> <p>Selects Δ Ref Marker (Marker 1) as the reference.</p> <p>Selects 0 dB as the reference.</p> <p>Displays the difference between the reference value and 0 dB.</p> <p>Goes to the next data point that is left (or right) of the search marker (Marker 2) and whose value is equal to VALUE plus the reference. If "TRACKING" is ON, Marker 2 will search both left and right, and go to the closest point whose value is equal to VALUE plus reference. If there is no such point, the message "VALUE NOT FOUND" is displayed in the data area. Otherwise the marker goes to that coordinate and the readout (under the search direction) is updated to reflect that frequency.</p> <p>When ON the active marker will change its frequency value after every sweep to maintain the user entered loss value. When OFF the marker stays at the same frequency and reads out the magnitude value at that frequency, except when a search is triggered.</p> <p>Calls Menu M9, which lets you select readout marker parameters.</p>

Menu M7, Search

MENU	DESCRIPTION
FILTER PARAMETERS	Provides the readouts for the filter measurement functions, as well as some selections. When this function is selected, the graph type for the active channel is automatically set to LOG MAGNITUDE, and taken out of time domain low pass or band pass display. Frequency with time gate display is allowed.
CENTER FREQ XX.XXXXXXXXXX GHz	Displays the value of Marker 2. Marker 1 displays the reference value (maximum filter response, or its set value if delta ref).
BANDWIDTH XXX.XXX dB Δ REF MARKER XX.XXXXXXXXXX GHz	Displays the difference between Markers 3 and 4.
LOSS AT REF -XXX.XXX dB	Displays the difference between the reference value and 0 dB.
Q XX.XXX	Displays the Q value.
	NOTE "Q" and "SHAPE FACTOR" are not displayed if they are toggled OFF in Menu M8A.
SHAPE FACTOR X.XXX	Displays the Shape Factor value.
TRACKING ON (OFF)	When ON the active marker will change its frequency value after every sweep to maintain the user entered loss value. When OFF the marker stays at the same frequency and reads out the magnitude value at that frequency, except when a search is triggered.
FILTER SETUP	Calls Menu M8A, which lets you set filter parameters.
MARKER READOUT FUNCTIONS	Calls Menu M9, which lets you select readout marker parameters.
PRESS <ENTER> TO SELECT OR TURN ON/OFF	Pressing the Enter key implements menu selection, or toggles selected option on or off.

Menu M8, Filter Parameters

MENUS
ALPHABETICAL LISTING

M

MENU	DESCRIPTION
<p style="text-align: center;">FILTER SETUP</p> <p>BANDWIDTH LOSS VALUE XXX.XXX dB</p> <p>REFERENCE</p> <p>MAXIMUM VALUE</p> <p>Δ REF MARKER 0 dB</p> <p>SHAPE FACTOR</p> <p>HIGH XXX.XXX dB</p> <p>LOW XXX.XXX dB</p> <p>READOUTS</p> <p>Q ON (OFF)</p> <p>SHAPE ON (OFF) FACTOR</p> <p>PREVIOUS MENU</p>	<p>A "loss" is a positive number. A value of 0 to 999.999 dB may be entered. The search value for bandwidth will be REF minus (-) LOSS. By default, the loss value is set to 3 dB.</p> <p>These menu choices let you enter the reference value for the search. The reference may be:</p> <ul style="list-style-type: none"> -Graticule "0 dB". -Position of Delta Ref. Marker. (Marker 1 is used as the Δ Ref Marker). -Maximum value in Passband (default selection). Marker 1 is used to indicate maximum. <p>Selects maximum value as the reference.</p> <p>Selects Δ Ref Marker (Marker 1) as the reference.</p> <p>Selects 0 dB as the reference.</p> <p>Enter high and low values for the Shape Factor. The LOW entry must be less than the HIGH entry. A value of 0 to 999.999 dB may be entered. The defaults are +6 dB for the HIGH, and +60 dB for the LOW value.</p> <p>Toggles Q on or off.</p> <p>Toggles the Shape Factor on or off.</p> <p style="text-align: center;">NOTE</p> <p>"Q" and "SHAPE FACTOR" are not displayed in Menu M8, if they are toggled to OFF.</p> <p>Returns to the M8 menu.</p>

Menu M8A, Filter Setup

MENU	DESCRIPTION
MARKER READOUT FUNCTIONS	
MARKERS ON ACTIVE CHANNEL	Calls Menu M3 directly — or causes it to be displayed when the Readout Marker key is pressed — if there is no active marker. Or to it calls or causes Menu M4 to be displayed if there is an active marker. If in delta reference mod, Menu M5 menu is displayed.
ACTIVE MARKERS ON ALL CHANNELS	Calls Menu M6 directly —or causes it to be displayed when the Read-out Marker key is pressed.
SEARCH	Calls Menu M7 directly —or causes it to be displayed when the Read-out Marker key is pressed.
FILTER PARAMETERS	Calls Menu M8 directly —or causes it to be displayed when the Read-out Marker key is pressed.
MARKER MODE	
CONTINUOUS	Marker values are interpolated between data points, Interpolated markers are allowed only when the horizontal axis of the display is FREQUENCY. Interpolated markers are not allowed in CW, Time Domain, or Power Sweep. If a channel has been set to interpolated markers and the sweep is changed to CW or Power Sweep, the markers will automatically revert to normal mode (DISCRETE). Time Domain will ignore CONTINUOUS mode. Interpolated markers are allowed in any graph type, as long as the sweep is by frequency.
DISCRETE	Markers are displayed only at actual measured data point values.
SET MARKERS	Calls Menu M1, which lets you set marker parameters.
PRESS <ENTER> TO SELECT	Pressing the Enter key implements menu selection.

Menu M9, Marker Readout Functions

MENUS
ALPHABETICAL LISTING

M

MENU	DESCRIPTION
MILLIMETER WAVE TEST SET BAND	
WR-22 (33 - 50 GHz)	Selects WR-22 (33 - 50 GHz) waveguide for use with millimeter wave system.
WR-15 (50 - 75 GHz)	Selects WR-15 (50 - 75 GHz) waveguide for use with millimeter wave system.
WR-12 (60 - 90 GHz)	Selects WR-12 (60 - 90 GHz) waveguide for use with millimeter wave system.
WR-12 EXTENDED (56 - 94 GHz)	Selects WR-12 Extended band (56 - 94 GHz) waveguide for use with millimeter wave system.
WR-10 (75 - 110 GHz)	Selects WR-10 (75 - 110 GHz) waveguide for use with millimeter wave system.
WR-10 EXTENDED (65 - 110 GHz)	Selects WR-10 Extended band (65 - 110 GHz) waveguide for use with millimeter wave system.
PRESS <ENTER> TO SELECT	Pressing the Enter key implements your menu selection and takes you to Menu MMW2.
PRESS <CLEAR> TO ABORT	Pressing the Clear key aborts your millimeter wave system selection and calls Menu OST1.

Menu MMW1, Millimeter Wave Test Set Band

MENU	DESCRIPTION
MILLIMETER WAVE TEST SET MODULES	
PORT 1 MODULE 3740/3741/NONE	Switch selection for Port 1 Module.
PORT 2 MODULE 3740/3741/NONE	Switch selection for Port 2 Module.
ACCEPT CONFIG	Accepts the selected configuration and calls Menu MMW3.
PRESS <ENTER> TO SELECT OR SWITCH	Pressing the Enter key implements your menu selection,
PRESS <CLEAR> TO ABORT	Pressing the Clear key aborts your millimeter wave system selection and calls Menu OST1.

Menu MMW2, Millimeter Wave Test Set Modules

MENUS
ALPHABETICAL LISTING

M

MENU	DESCRIPTION
<p>MILLIMETER WAVE TEST SET</p> <p>mm WAVE BAND: XXXXXXXXXXXX</p> <p>PORT 1 MODULE XXXXXXXXXXXX</p> <p>PORT 2 MODULE XXXXXXXXXXXX</p> <p>WARNING:</p> <p>CONTINUING MAY INVALIDATE CURRENT SETUP AND CALIBRATION</p> <p>PRESS <ENTER> TO SELECT</p> <p>PRESS <CLEAR> TO ABORT</p>	<p>Provides information for selections made in Menu MMW2 (previous menu).</p> <p>Pressing the Enter key implements your millimeter wave selection and calls Menu SU1 or SU3.</p> <p>Pressing the Clear key aborts your millimeter wave system selection and calls Menu OST1.</p>

Menu MMW3, Millimeter Wave Test Set

MENU	DESCRIPTION
mm WAVE BAND	
BAND START FREQ XXXXXXXXXXXX	Displays the start frequency of the millimeter wave band.
BAND STOP FREQ XXXXXXXXXXXX	Displays the stopfrequency of the millimeter wave band.
EQUATION TO EDIT	
SOURCE 1	Selects source 1 frequency equation for change.
SOURCE 2	Selects source 2 frequency equation for change.
RECEIVER	Selects receiver frequency equation for change.
EQUATION SUMMARY	
C.W. ON/OFF	Toggles frequency term (F) in equation ON or OFF.
MULTIPLIER XXX	Enables changing multiplier term of frequency equation via key pad or rotary knob.
DIVISOR XXX	Enables changing divisor term frequency equation via key pad or rotary knob.
OFFSET FREQ XXXXXXXXXX	Enables changing offset frequency term frequency equation via key pad or rotary knob.
DEFAULT EQUATIONS	Pressing the Enter key implements your menu selection.
ACCEPT EQUATIONS	Pressing the Clear key aborts your millimeter wave selection and calls Menu SU1 or SU3.

Menu MMW4, mm Wave Band

- MILLIMETER WAVE BAND DEFINITION SUMMARY -
BAND FREQUENCY RANGE

BAND START FBAND STOP F
XXX.XXXXXX XXXXXX.XXXXXX XXX

FREQUENCY = (MULTIPLIER/DIVISOR) * F + OFFSET FREQ)

SOURCE 1 = (1/ 6) * (F - 0.270000 GHz)

SOURCE 2 = (1/ 8) * (F+ 0.000000 GHz)

RECEIVER = (1/ 1) * (0.270000 GHz C.W.)

- NOTES -

1. SELECT <DEFAULT EQUATIONS> TO OVERWRITE DEFINITION WITH VALUES SUITABLE FOR THE MILLIMETER WAVE BAND.
 2. SELECT <ACCEPT EQUATIONS> TO CONFIRM ANY CHANGES.
 3. PERFORMANCE SPECIFICATIONS ARE VALID ONLY WHILE USING THE DEFAULT EQUATIONS OVER THE DEFAULT BAND FREQUENCY RANGE.
 4. DEVIATING FROM THE DEFAULT MAY CAUSE LOCK FAILURES.
- PRESS <ENTER> TO SELECT, PRESS <CLEAR> TO ABORT

Menu EXT_MMW4

MENU	DESCRIPTION
TRACE MEMORY FUNCTIONS	
VIEW DATA	Displays measured data; that is, the data presently being taken.
VIEW MEMORY	Displays stored data; that is, data that was previously taken and stored in memory.
VIEW DATA AND MEMORY	Displays measured data superimposed over stored data.
VIEW DATA (/) MEMORY	Displays measured data combined with stored data using selected math.
SELECT TRACE MATH	Takes you to menu NO2 for selection of the type of math operation to be performed.
STORE DATA TO MEMORY (STORED) (NOT STORED)	Stores the measured data to internal memory.
DISK OPERATIONS	Brings up menu NO3, which allows data to be stored to or recalled from the disk.
PRESS <ENTER> TO SELECT	Pressing the Enter key implements your menu selection.

Menu NO1, Trace Memory Functions

MENUS
ALPHABETICAL LISTING

N

MENU	DESCRIPTION
SELECT TRACE MATH	
ADD (+)	Selects DATA + MEMORY as the math function.
SUBTRACT (-)	Selects DATA - MEMORY as the math function.
MULTIPLY (*)	Selects DATA X MEMORY as the math function.
DIVIDE (/)	Selects DATA MEMORY as the math function.
PRESS <ENTER> TO SELECT	Pressing the Enter key implements your menu selection. The menu returns to the NO1 menu.

Menu NO2, Select Trace Math

MENU	DESCRIPTION
TRACE MEMORY DISK OPERATIONS	
CHANNEL X	Indicates the channel to be used (active channel).
SAVE MEMORY TO HARD DISK	Calls menu DSK3, which lets you save memory to the hard disk.
SAVE MEMORY TO FLOPPY DISK	Calls menu DSK3, which lets you save memory to the floppy disk.
RECALL MEMORY FROM HARD DISK	Calls menu DSK2, which lets you recall memory from the hard disk.
RECALL MEMORY FROM FLOPPY DISK	Calls menu DSK2, which lets you recall memory from the floppy disk.
PRESS <ENTER> TO SELECT	Pressing the Enter key implements your menu selection.

Menu NO3, Trace Memory Disk Functions

MENU	DESCRIPTION
MULTIPLE SOURCE CONTROL DEFINE BANDS SOURCE CONFIG MULTIPLE SOURCE MODE OFF DEFINE ON MORE PRESS <ENTER> TO SELECT	 Calls menu OM1, which lets you define a frequency band. Calls menu SC, which lets you configure the frequency source. Turns multiple source operating mode off placing 371XXA VNA in normal operating mode. Sets multiple source mode to ON. Calls Menu OM1A, which lets you select source-lock polarity. Pressing the Enter key implements your menu selection.

Menu OM1, Multiple Source Control Menu

MENUS
ALPHABETICAL LISTING

O

MENU	DESCRIPTION
<p>SOURCE LOCK POLARITY</p> <p>NORMAL REVERSE</p> <p>SELECT <REVERSE> SOURCE LOCK POLARITY IF</p> <p>THE DUT CONTAINS MULTI-CONVERSION STAGES, AND</p> <p>THE PHASE OF THE FINAL OUTPUT I.F. IS OPPOSITE OF NORMAL</p> <p>NORMAL POLARITY IS DEFINED BY THE SOURCE 1 AND 2 EQUATIONS</p> <p>IF SOURCE 1 FREQ IS GREATER THAN SOURCE 2 FREQ THEN THE I.F. IS ASSUMED TO BE POSITIVE POLARITY AND VICE VERSA</p>	<p>Calls menu OM1, which lets you define a frequency band.</p> <p>Calls menu SC, which lets you configure the frequency source.</p> <p>Turns multiple source operating mode off placing 371XXA VNA in normal operating mode.</p> <p>Sets multiple source mode to ON.</p>

Menu OM1A, Source Lock Polarity Menu

MENU	DESCRIPTION
DEFINE BANDS	
BAND 1	Displays the band number being defined.
DISPLAYED FREQ RANGE	
BAND START FREQ XX.XXXXXX GHz	Displays the start frequency for the band.
BAND STOP FREQ XX.XXXXXX GHz	Displays the stop frequency for the band.
BAND FUNCTIONS	
EDIT SYSTEM EQUATIONS	Calls menu OM3, which lets you edit system equations.
STORE BAND 1 BANDS STORED: (1 2 3 4 5)	Indicates the band that will be stored and, within the parenthesis, indicates the bands that have been stored.
CLEAR ALL DEFINITIONS	Clears all the band definitions that may have been previously stored.
SET MULTIPLE SOURCE STATE	Selects Multiple Source Control menu OM0.
PRESS <ENTER> TO SELECT	Pressing the Enter key implements your menu selection.

Menu OM2, Define Bands Menu

MENUS
ALPHABETICAL LISTING

O

MENU	DESCRIPTION
<p>EDIT SYSTEM EQUATIONS</p>	
<p>EQUATION TO EDIT</p>	
<p>SOURCE 1</p>	<p>Selects source 1 frequency equation for change.</p>
<p>SOURCE 2</p>	<p>Selects source 2 frequency equation for change.</p>
<p>RECEIVER</p>	<p>Selects receiver frequency equation for change.</p>
<p>EQUATION SUMMARY</p>	
<p>C.W. ON (OFF)</p>	<p>Toggles frequency term (F) in equation ON or OFF.</p>
<p>MULTIPLIER XX</p>	<p>Enables changing multiplier term of frequency equation via key pad or rotary knob.</p>
<p>DIVISOR XX</p>	<p>Enables changing divisor term frequency equation via key pad or rotary knob.</p>
<p>OFFSET FREQ XXX.XXXXXXXXXX GHz</p>	<p>Enables changing offset frequency term frequency equation via key pad or rotary knob.</p>
<p>PREVIOUS MENU</p>	<p>Recalls menu OM1.</p>
<p>PRESS <ENTER> TO SELECT</p>	<p>Pressing the Enter key implements your menu selection.</p>

Menu OM3, Edit System Equations

MENU	DESCRIPTION
OPTIONS	
TRIGGERS	Calls menu TRIG, which lets you define trigger source.
REAR PANEL OUTPUT	Calls menu ORP1, which lets you select an output for the rear panel AUX I/O connector.
DIAGNOSTICS	Calls menu DG1, which lets you implement system diagnostics.
MULTIPLE SOURCE CONTROL	Calls menu OM1, which lets you use and define multiple sources.
RECEIVER MODE	Calls menu RCV1, which gives you Receiver Mode control options.
SOURCE CONFIG	Calls menu SC, which lets you configure the frequency source.
RF ON/OFF DURING RETRACE	Turns RF during retrace and switch points ON or OFF. The user must keep the sweep range small, preferably below 2 GHz. Avoid including any switch points where RF would be blanked for delays due to hardware settling.
PRESS <ENTER> TO SELECT	Pressing the Enter key implements your menu selection.

Menu OPTNS, Select Options

MENUS
ALPHABETICAL LISTING

O

MENU	DESCRIPTION
REAR PANEL OUTPUT CONTROL	
OUTPUT ON (OFF)	Turns the rear panel ANALOG OUT output on or off.
SELECT MODE XXXXXXXXXX	Calls menu ORP2, which lets you select an output mode.
HORIZONTAL OR PHASE LOCK SCALING	
START/LOCK a1 X.XXXX V	Lets you enter a voltage for the start/lock frequency. Value will be a frequency start voltage if SELECT MODE choice is HORIZONTAL. It will be a phase-lock voltage if SELECT MODE choice is PHASELOCK.
STOP/LOCK a2 X.XXXX V	Lets you enter a voltage for the start/lock frequency. Value will be a frequency stop voltage if SELECT MODE choice is HORIZONTAL. It will be a phase-lock voltage if SELECT MODE choice is PHASELOCK.
VERTICAL SCALING	
RESOLUTION 1.000 V/DIV	Shows fixed value for VERTICAL mode.
REFERENCE VALUE 0.000 V/DIV	Shows fixed value for VERTICAL mode.
PRESS <ENTER> TO SELECT OR TURN ON/OFF	Pressing the Enter key implements your menu selection.

Menu ORP1, Rear Panel Output Control

MENU	DESCRIPTION
SELECT MODE FOR OUTPUT	
HORIZONTAL	Pressing Enter key selects horizontal drive for external chart recorder connected to ANALOG OUT connector.
VERTICAL	Pressing Enter key selects vertical drive for external chart recorder connected to ANALOG OUT connector.
PHASE LOCK	Pressing Enter key selects phase-lock for external chart recorder connected to ANALOG OUT connector.
PRESS <ENTER> TO SELECT	Pressing the Enter key implements your menu selection.

Menu ORP2, Select Output Mode

MENU	DESCRIPTION
TEST SET CONFIGURATION	
INTERNAL	Calls Menu OTS2.
MILLIMETER WAVE	Calls Menu MMW1.
PRESS <ENTER> TO SELECT	Pressing the Enter key implements your menu selection.

Menu OTS1, Test Set Configuration

MENUS
ALPHABETICAL LISTING

O

MENU	DESCRIPTION
<p>INTERNAL TEST SET</p> <p>WARNING:</p> <p>CONTINUING WILL INVALIDATE CURRENT SETUP AND CALIBRATION</p> <p>PRESS <ENTER> TO SELECT</p> <p>PRESS <CLEAR> TO ABORT</p>	<p>Pressing the Enter key implements internal test set configuration.</p> <p>Pressing the Clear key aborts internal test set configuration.</p>

Menu OTS2, Warning

MENU	DESCRIPTION
SELECT POLAR CHART MODE	
MAGNITUDE, PHASE	Selects Polar Chart Display to show magnitude and phase for the full frequency range—from start frequency to stop frequency.
MAGNITUDE, SWP POSITION	Selects Polar Chart Display to show magnitude information only for the phase data that falls between the start and stop angles selected below.
SET SWEEP POSITION BOUNDARIES	Sets the start and stop angles for the data display.
START ANGLE X.XX°	
STOP ANGLE X.XX°	
PRESS <ENTER> TO SELECT	Pressing the Enter key implements your menu selection.

Menu PC1, Select Polar Chart Mode

MENUS
ALPHABETICAL LISTING

P

MENU	DESCRIPTION
PARAMETER DEFINITION	
S21/USER 1	Lets you choose between displaying a pre-defined S-Parameter or a user-defined parameter.
RATIO b2 / a1	Displays the parameters chosen as numerator and denominator.
PHASE LOCK a1	Displays the phase-lock parameter.
USER LABEL: MY S11	Displays the name of the user-defined parameter.
CHANGE RATIO	Calls menu PD2, which lets you change the ratio.
CHANGE PHASE LOCK	
CHANGE LABEL	Calls menu GP5, which lets you name your newly defined parameter. The label appears at the top of the graph-type display and under the word "LABEL" in the menu.
PREVIOUS MENU	Returns to the previous menu, SP.
PRESS <ENTER> TO SELECT OR SWITCH	Pressing the ENTER key implements your menu selection.

Menu PD1, Parameter Definition 1

MENU	DESCRIPTION
PARAMETER RATIO	
NUMERATOR	
a1	Selects a1 as the numerator.
a2	Selects a2 as the numerator.
b1	Selects b1 as the numerator.
b2	Selects b2 as the numerator.
1 (UNITY)	Selects the numerator to be 1 (unity).
DENOMINATOR	
a1	Selects a1 as the demoniator.
a2	Selects a2 as the demoniator.
b1	Selects b1 as the demoniator.
b2	Selects b2 as the demoniator.
1 (UNITY)	Selects the numerator to be 1 (unity).
PREVIOUS MENU	Returns you to menu PD1.
PRESS <ENTER> TO SELECT	Pressing the ENTER key implements your menu selection.

Menu PD2, Parameter Ratio

MENU	DESCRIPTION
PARAMETER DEFINITION	
PHASE LOCK	
a1 (Ra)	Selects a1.
a2 (Rb)	Selects a2.
PREVIOUS MENU	Returns you to menu PD1.
PRESS <ENTER> TO SELECT	Pressing the ENTER key implements your menu selection.

Menu PD3, Parameter Definition 2

MENU	DESCRIPTION
PLOT OPTIONS	
FULL PLOT	The plotter will plot everything displayed on the screen (data traces, graticule, menu text) when START PRINT is pressed.
OPTIONS TO PLOT	
HEADER ON (OFF)	The plot will include an information header if this option is on and START PRINT is pressed.
MENU ON (OFF)	The plot will include the menu text if this option is on and START PRINT is pressed.
LIMITS ON (OFF)	The plot will include any limit lines if this option is on and START PRINT is pressed.
GRATICULE ON (OFF)	The plot will include the graticule and annotation if this option is on and START PRINT is pressed. The plotter plots the graticule.
DATA TRACE(S) ON(OFF) AND MARKERS	The plot will include the data and any marker that are present if this option is on and START PRINT is pressed. The plotter plots the graticule.
PLOT FORMAT	
PLOT SIZE	Calls menu PL2, which lets you select the size and location of the plot.
PEN COLORS	Calls menu PL3, which lets you select pen colors for the various elements of the plot: graticule, data traces, menu text and header. Also lets you select the relative pen speed.
PLOT ORIENTATION PORTRAIT LANDSCAPE	Select the orientation for your plot, either portrait or landscape.
PRESS <ENTER> TO SELECT OR TURN ON/OFF	Pressing the Enter key implements your menu selection.

Menu PL1, Plot Options

MENU	DESCRIPTION
PLOT SIZE FULL SIZE -QUARTER SIZE PLOTS- UPPER LEFT UPPER RIGHT LOWER LEFT LOWER RIGHT PRESS <ENTER> TO SELECT	Selects a full size (page) plot. Selects a quarter-size plot, upper-left quadrant. Selects a quarter-size plot, upper-right quadrant. Selects a quarter-size plot, lower-left quadrant. Selects a quarter-size plot, lower-right quadrant. Pressing the Enter key implements your menu selection.

Menu PL2, Select Plot Size

MENU	DESCRIPTION
SELECT PEN COLORS	
DATA PEN n	Selects the color in which the data will be plotted. The number of the pen displays where the "n" is shown.
DATA TRACE OVERLAY PEN n	Selects the color in which the 2nd trace in a dual trace overlay plot will be plotted. The number of the pen displays where the "n" is shown.
GRATICULE PEN n	Selects the color in which the graticule will be plotted. The number of the pen displays where the "n" is shown.
MARKERS AND LIMITS PEN n	Selects the color in which the markers and limits will be plotted. The number of the pen displays where the "n" is shown.
HEADER PEN n	Selects the color in which the header information will be plotted. The number of the pen displays where the "n" is shown.
PEN SPEED 100 PERCENT OF MAXIMUM	Selects the pen's speed as a percentage of the plotter's maximum speed. (Used to optimize plots on transparencies or with worn pens.)
PREVIOUS MENU	Recalls menu PL1.
PRESS <ENTER> TO SELECT	Pressing the Enter key implements your menu selection.

Menu PL3, Select Pen Colors

MENU	DESCRIPTION
HARD COPY	
OUTPUT DEVICE	Allows hard copy output to be directed to the HDD or floppy, in addition to the printer and plotter. In addition to text (*.txt), S2P (*.s2p), and tabular (*.dat) files, bitmaps (*.bmp) and HPGL (*.hgl) files are offered to satisfy desktop publishing requirements. Specifically, color bitmaps and graphic language files can be imported into Windows applications, such as Cap3700.
PRINTER	Selects the printer as your output device.
PLOTTER	Selects the plotter as your output device.
DISK FILE	Selects a disk file as your output device.
SETUP & OPERATIONS	
SETUP HEADERS	Calls menu PM2, which lets you define the output header information.
DISK OPERATIONS	Calls menu PM4, which lets you store/recall tabular data to/from disk.
OUTPUT OPTIONS	
PRINT OPTIONS	Calls menu PM5.
PLOT OPTIONS	Calls menu PL1.
DISK FILE OPTIONS	Calls menu PM4A.
PRESS <ENTER> TO SELECT	Pressing the ENTER key implements your menu selection. The menu remains on the screen until another menu is selected for display or until the CLEAR/RET LOC key is pressed.

Menu PM1, Select Data Output Type

MENU	DESCRIPTION
DATA OUTPUT HEADERS	
MODEL ON (OFF) XXXXXXXXXXXX	Selecting <1> displays menu GP5, which lets you select the letters and/or numbers in your model identifier.
DEVICE ID ON (OFF) XXXXXXXXXXXX	Selecting <1> displays menu GP5, which lets you select the letters and/or numbers in your Device I.D. identifier.
OPERATOR ON (OFF) XXXXXXXXXXXX	Selecting <1> displays menu GP5, which lets you select the letters identifying the operator.
COMMENT ON (OFF) XXXXXXXXXXXX	Selecting <1> displays menu GP5, which lets you enter a comment.
DATE ON (OFF)	Displays system date and time. Can be set in Menu U6.
SETUP LOGO	Selecting <1> displays menu PM2A which lets you select any of three logo options.
PRESS <ENTER> TO TURN ON/OFF PRESS < 1 > TO CHANGE	Pressing the Enter key selects between menu selections. Pressing the CLEAR/RET LOC key lets you change the between ON and OFF states. Pressing <1> lets you enter the desired label in menu GP5.

Menu PM2, Data Output Headers

MENU	DESCRIPTION
LOGO SETUP	Lets you turn off the Anritsu logo and select a user-define logo.
LOGO ON (OFF)	Turns the logo on and off.
LOGO TYPE	Lets you define the logo type.
STANDARD	Causes the standard logo to be displayed.
USER LOGO	Lets users display their own log.
INSTALL USER LOGO FROM FLOPPY DISK	
FOR PRINTER	Lets you define logo for printing.
FOR PLOTTER	Lets you define logo for plotting.
PREVIOUS MENU	Returns to previous menu.
PRESS <ENTER> TO SELECT	Pressing the Enter key selects between menu selections.

Menu PM2A, Data Output Headers

MENU	DESCRIPTION
TABULAR PRINTER OUTPUT FORMAT	
MARKER DATA ON (OFF)	Provides for printing marker data.
SWEEP DATA ON (OFF)	Provides for printing sweep data. If you choose to print the sweep data, you can then choose how many points of the total sweep to print.
HEADER AND ON (OFF) PAGE BREAKS	Provides for printing header and page-break data.
PRINT DENSITY	
XXX PRINT PT(S) OUTPUT PRINTS 1 POINT EVERY XXX POINT(S)	Outputs one point every X points. Use the rotary knob to select total number of points to output. Skipping points will reduce the total number of printed points.
PREVIOUS MENU	Returns to menu PM5.
PRESS <ENTER> TO SELECT OR TURN ON/OFF	Pressing the Enter key selects between menu selections. Pressing the CLEAR/RET LOC key lets you change the between ON and OFF states.
TURN KNOB TO CHANGE NUMBER OF POINTS	

Menu PM3, Tabular Printer Output Format

MENUS
ALPHABETICAL LISTING

P

MENU	DESCRIPTION
GRAPHICAL PRINTER OUTPUT FORMAT	
HEADER ON (OFF)	Provides for printing header data.
SCREEN AREA TO OUTPUT	
FULL SCREEN	Prints the full-screen data, including the menus.
GRAPH ONLY	Prints only the graph or Smith chart.
BITMAP FILE OUTPUT OPTIONS	
TRUE COLOR	Configures the bitmap disk-file format as true color.
COLOR ON WHITE BACKGROUND	Configures the bitmap disk-file format to be color on a white background.
BLACK ON WHITE BACKGROUND	Configures the bitmap disk-file format to be black on a white background.
PREVIOUS MENU	Returns to menu PM5.
PRESS <ENTER> TO SELECT OR TURN ON/OFF	Pressing the Enter key selects between menu selections. Pressing the <ENTER> key lets you change the between ON and OFF states.

Menu PM3A, Graphical Printer Output Format

MENU	DESCRIPTION
<p data-bbox="217 369 467 428">OUTPUT DISK OPERATIONS</p> <p data-bbox="188 462 428 554">TABULAR DATA FROM HARD DISK TO PRINTER</p> <p data-bbox="188 583 456 676">TABULAR DATA FROM FLOPPY DISK TO PRINTER</p> <p data-bbox="228 709 451 768">PRESS <ENTER> TO SELECT</p>	<p data-bbox="574 466 1442 525">Brings up DSK2 for selection of a measurement data file to be output to the printer.</p> <p data-bbox="574 588 1442 646">Brings up DSK2 for selection of a measurement data file to be output to the printer.</p> <p data-bbox="574 714 1250 743">Pressing the Enter key implements your menu selection.</p>

Menu PM4, Disk Output Operations

MENU	DESCRIPTION
DISK FILE OPTIONS	
DESTINATION	
HARD DISK	Selects the output drive destination for the disk file to the hard disk (C:).
FLOPPY DISK	Selects the output drive destination for the disk file to the floppy disk (A:).
FORMAT	
TEXT	Text format, predefined.
S2P	S2P format, predefined.
TABULAR DATA	Tabular data format is configured via the Print Options (Menu PM5) or Tabular Data (Menu PM3).
BITMAP	Bitmap format is configured via the Print Options (Menu PM5), Options (Menu PM5, or Graphical Data (Menu PM3A).
HPGL	HPGL format is configured via the Plot Options (Menu PL1).
PRESS <ENTER> TO SELECT	Pressing the Enter key implements your menu selection.
USE <START PRINT> TO CAPTURE DATA	Press the Start Print key at the moment data is to be captured. This calls Menu DSK3 to create a new file or overwrite an existing file in the current directory.

Menu PM4A, Disk File Options

MENU	DESCRIPTION
PRINT OPTIONS	
PRINTER TYPE	
THINKJET	Select when HP QuietJet or HP ThinkJet is connected to 372XXB VNA.
DESKJET	Select when HP DeskJet (B/W) or HP LaserJet II and III series is connected to 372XXB VNA.
EPSON	Select when Epson FX, Epson MX, or Epson 9-pin compatible is connected to 372XXB VNA.
FORMAT OF PRINTER OUTPUT	
GRAPHICAL DATA	Prints only the graph or Smith chart, including any and all data it contains.
TABULAR DATA	Prints a tabulation of the measured data
PRESS <ENTER> TO SELECT	Pressing the Enter key implements your menu selection.

Menu PM5, Printer Type, Options

MENUS
ALPHABETICAL LISTING

R

MENU	DESCRIPTION
<p>RECEIVER MODE</p> <p>STANDARD</p> <p>USER DEFINED</p> <p>SOURCE CONFIG</p> <p>SPUR REDUCTION NORMAL/OFF</p> <p>PRESS <ENTER> TO SELECT OR SWITCH</p>	<p>Selects STANDARD mode (RECEIVER mode is not activated).</p> <p>Calls menu RCV2, which lets you define rEceiver Mode parameters.</p> <p>Calls menu SC, which lets you configure the frequency source.</p> <p>Switches between NORMAL and OFF for hardware spur reduction. Hardware control may not be available.</p> <p>Pressing the ENTER key implements or switches your menu selection.</p>

Menu RCV1, Receiver Mode

MENU	DESCRIPTION
<p>STANDARD RECEIVER MODE</p> <p>WARNING:</p> <p>CONTINUING MAY INVALIDATE CURRENT SETUP AND CALIBRATION</p> <p>PRESS <ENTER> TO CONTINUE</p> <p>PRESS <CLEAR> TO ABORT</p>	<p>Pressing the ENTER key implements your menu selection.</p> <p>Pressing the CLEAR key aborts the Receiver Mode.</p>

Menu RCV1_WARN, Standard Receiver Mode Warning

MENU	DESCRIPTION
USER DEFINED RECEIVER MODE	
SOURCE LOCK	Phase locks sources having phase control reference inputs.
TRACKING	Phase locks 72XXA receivers to a known frequency source.
SET ON	Disables source lock circuitry, local oscillators are phase locked to the 371XXA internal crystal reference oscillator.
PRESS ENTER TO SELECT	Pressing the Enter key implements your menu selection or turns GPIB control on or off.

Menu RCV2, User Defined Receiver Mode Menu

MENUS
ALPHABETICAL LISTING

R

MENU	DESCRIPTION
<p>USER DEFINED RECEIVER MODE</p> <p>SET ON WITH GPIB CONTROL</p> <p>WARNING:</p> <p>CONTINUING MAY INVALIDATE CURRENT SETUP AND CALIBRATION</p> <p>PRESS <ENTER> TO CONTINUE</p> <p>PRESS <CLEAR> TO ABORT</p>	<p>(Warning could also read "SOURCE LOCK," "TRACKING," or "WITHOUT" instead of "SET ON").</p> <p>Pressing the ENTER key implements your menu selection.</p> <p>Pressing the CLEAR key aborts the Receiver Mode.</p>

Menu RCV2_WARN, User Defined Receiver Mode Warning

MENU	DESCRIPTION
STANDARD RECEIVER MODE WARNING: CONTINUING WILL ERASE CURRENT SETUP AND CALIBRATION	Indicates that Standard Receiver mode has been selected. Indicates that continuing (by pressing the Enter key) will erase current setup and calibration stored in the VNA.

Menu RCV3, Standard Receiver Mode Warning Menu

MENUS
ALPHABETICAL LISTING

R

MENU	DESCRIPTION
<p>USER DEFINED RECEIVER MODE</p> <p>XXXXXXXX</p> <p>WARNING:</p> <p>CONTINUING WILL ERASE CURRENT SETUP AND CALIBRATION</p> <p>PRESS <ENTER> TO CONTINUE</p> <p>OR</p> <p>PRESS <CLEAR> TO ABORT</p>	<p>Indicates selected mode</p> <p>Indicates that continuing (by pressing the Enter key) will erase current setup and calibration stored in the VNA.</p> <p>Pressing Enter key implements selected mode.</p> <p>Pressing the CLEAR key aborts the selected mode; current setup and calibration data stored in the VNA is preserved.</p>

Menu RCV4, User Defined Receiver Mode Warning Menu

MENU	DESCRIPTION
<p style="text-align: center;">SET REFERENCE PLANE</p> <p>AUTO</p> <p>DISTANCE XXX.XXXX mm</p> <p>TIME XXX.XXXX ms</p> <p>SET DIELECTRIC XXX</p> <p style="text-align: center;">PRESS <ENTER> TO SELECT</p>	<p>Automatically sets the reference delay so that the cumulative phase shift is zero. This selection unwinds the phase in a Smith chart display or reduces the phase revolutions in a rectilinear display to less than one.</p> <p>Electrically repositions the measurement reference plane, as displayed on the active channel, by a distance value entered in millimeters. This selection lets you compensate for the phase reversals inherent in a length of transmission line connected between the test set's Port 1 connector and the device-under-test (DUT).</p> <p>Electrically repositions the measurement reference plane by a distance value that corresponds to the time in milliseconds.</p> <p>Displays menu RD2, which lets you enter a value for the dielectric constant of your transmission line.</p> <p>Pressing the Enter key implements your menu selection.</p>

Menu RD1, Set Reference Delay

MENUS
ALPHABETICAL LISTING

R

MENU	DESCRIPTION
<p>SET DIELECTRIC CONSTANT</p> <p>AIR (1.000649)</p> <p>POLYETHYLENE (2.26)</p> <p>TEFLON (2.10)</p> <p>MICROPOROUS TEFLON (1.69)</p> <p>OTHER XXXX.XX</p> <p>PRESS <ENTER> TO SELECT</p>	<p>Calculates reference delay based on dielectric constant of air (1.000649).</p> <p>Calculates reference delay based on the dielectric constant of polyethylene (2.26).</p> <p>Calculates reference delay based on the dielectric constant of teflon (2.1).</p> <p>Calculates reference delay based on the dielectric constant of microporous teflon (1.69).</p> <p>Calculates reference delay based on the value you enter. Terminate your entry using any terminator and select with the Enter key.</p> <p>Pressing the Enter key implements your menu selection and returns you to the RD1 menu.</p>

Menu RD2, Set Dielectric Constant

MENU	DESCRIPTION
SOURCE CONFIG	
SOURCE 1	
ACTIVE/ INACTIVE	Enables and disables the internal source.
SOURCE LOCATION INTERNAL / EXTERNAL	Changes location of source 1 from internal to external (NOT CURRENTLY SUPPORTED).
GPIB ADDRESS 4	Changes GPIB address of external source 1.
GPIB CONTROL ON (OFF)	Disables GPIB control of external source 1.
SOURCE 2	
ACTIVE/ INACTIVE	Enables and disables the external source 2.
SOURCE LOCATION EXTERNAL	
GPIB ADDRESS 5	4 Changes GPIB address of external source 2.
GPIB CONTROL ON (OFF)	Disables GPIB control of external source 2.
PRESS <ENTER> TO SELECT OR TURN ON/OFF	Pressing the Enter key implements your menu selection.

Menu SC, Source Configure

MENUS
ALPHABETICAL LISTING

S

MENU	DESCRIPTION
<p>SELECT PARAMETER</p> <p>S21, FWD TRANS b2 / a1</p> <p>S11, USER 2 b2 / 1</p> <p>S12, REV TRANS b1 / a2</p> <p>S22, REV REFL b2 / a2</p> <p>PRESS <ENTER> TO SELECT</p> <p>PRESS <1> TO REDEFINE SELECTED PARAMETER</p>	<p>Selects the S₂₁ parameter to be displayed on the active channel. The parameter can be displayed in any of the available formats.</p> <p>Selects the S₁₁ parameter to be displayed on the active channel. The parameter can be displayed in any of the available formats.</p> <p>Selects the S₁₂ parameter to be displayed on the active channel. The parameter can be displayed in any of the available formats.</p> <p>Selects the S₂₂ parameter to be displayed on the active channel. The parameter can be displayed in any of the available formats.</p> <p>Pressing the Enter key implements your menu selection.</p> <p>Calls menu PD1, which lets you redefine the selected parameter.</p>

Menu SP, Select S Parameter

MENU	DESCRIPTION
SAVE/RECALL FRONT PANEL AND CAL DATA SAVE RECALL PRESS <ENTER> TO SELECT FUNCTION	Displays menu SR2, which asks you to select a storage location—internal memory or disk. Pressing the Enter key implements your selection.

Menu SR1, Save / Recall Front Panel Information

MENU	DESCRIPTION
<p>RECALL (OR SAVE)</p> <p>FRONT PANEL SETUP IN INTERNAL MEMORY</p> <p>FRONT PANEL SETUP AND CAL DATA ON HARD DISK</p> <p>FRONT PANEL SETUP AND CAL DATA ON FLOPPY DISK</p> <p>PRESS <ENTER> TO SELECT</p>	<p>Calls menu SR3, which lets you save the front panel setup into or recall it from internal memory.</p> <p>Calls menu DKS2 or DSK3, which let you recall or save to hard disk memory.</p> <p>Calls menu DKS2 or DSK3, which let you recall or save to floppy disk memory.</p> <p>Pressing the Enter key implements your selection. The menu remains on the screen until another menu is selected for display or until the Clear/Ret Loc key is pressed.</p>

Menu SR2, Recall or Save

MENU	DESCRIPTION
SAVE FRONT PANEL SETUP TO (RECALL FRONT PANEL SETUP FROM) INTERNAL MEMORY	
MEMORY 1*	Causes the current front panel setup to be saved to memory location 1. If an asterisk appears beside the selection, the memory is full. Select a different memory location.
MEMORY 2	Same as above, except the setup saves to memory location 2.
MEMORY 3	Same as above, except the setup saves to memory location 3.
MEMORY 4*	Same as above, except the setup saves to memory location 4.
MEMORY 5*	Same as above, except the setup saves to memory location 5.
MEMORY 6	Same as above, except the setup saves to memory location 6.
MEMORY 7	Same as above, except the setup saves to memory location 7.
MEMORY 8	Same as above, except the setup saves to memory location 8.
MEMORY 9	Same as above, except the setup saves to memory location 9.
MEMORY 10	Same as above, except the setup saves to memory location 10.
PRESS <ENTER> TO SELECT OR USE KEYPAD	Pressing the Enter key implements your menu selection.

Menu SR3, Save to Internal memory

MENUS
ALPHABETICAL LISTING

MENU	DESCRIPTION
SET SCALING OR PRESS <AUTOSCALE>	
-LOG MAG-	
RESOLUTION XX.XXX dB/DIV	Sets the resolution for the vertical axis of the active channel's displayed graph. Resolution can be set incrementally using the keypad or rotary knob.
REFERENCE VALUE XXX.XXX dB	Sets the value at the reference line for the active channel amplitude measurement on the log-magnitude graph. The value can be set in increments of 0.001 dB using the keypad or rotary knob.
REFERENCE LINE X	Sets the reference line for the active channel's amplitude measurement on the log-magnitude graph. This is the line about which the amplitude expands with different resolution values. The reference line can be set to any vertical division using the rotary knob.
-PHASE-	
RESOLUTION XX.XX ° /DIV	Sets the resolution for the vertical axis of the active channel's displayed phase graph. Resolution can be set incrementally using the keypad or rotary knob.
REFERENCE VALUE XXX.XX °	Sets the value at the reference line for the active channel amplitude measurement on the phase graph. The value can be set in increments of 0.001 dB using the keypad or rotary knob.
REFERENCE LINE X	Sets the reference line for the active channel's phase measurement on the phase graph. This is the line about which the phase expands with different resolution values. The reference line can be set to any vertical division using the rotary knob.
PHASE SHIFT X.XX °	Sets the value by which the active channel's phase measurement is shifted on the phase graph. The shift can be set in increments of 0.01 degrees using the keypad or rotary knob. This is useful when phase data is near the 180 degree rollover value.
PRESS <ENTER> TO RESUME CAL	On the CAL_SS1 menu, pressing the Enter key returns you to the calibration setup or sequence.

Menu SS1 or CAL_SS1, Set Scaling 1

MENU	DESCRIPTION
SET SCALING OR PRESS <AUTOSCALE> --LINEAR POLAR-- RESOLUTION XX.XXX U/DIV REFERENCE VALUE XXX.XXX U FIXED REFERENCE LINE SELECT POLAR CHART MODE MAGNITUDE PHASE PRESS <ENTER> TO SELECT AND RESUME CAL	<p>Sets the resolution for the vertical axis of the active channel's displayed graph. Resolution can be set incrementally using the keypad or rotary knob. The center is fixed at 0 units; therefore, changing the resolution also changes the reference value and vice versa</p> <p>Sets the value at the reference line for the active channel amplitude measurement on the displayed graph. The value can be set in increments of 0.001 U using the keypad or rotary knob.</p> <p>Sets the reference line for the active channel's amplitude measurement. This is the line about which the amplitude expands with different resolution values. The reference line can be set to any vertical division using the rotary knob.</p> <p>Calls menu PC1, which lets you define the phase angles between which your polar chart will display data.</p> <p>Pressing the Enter key implements your menu selection and resumes the calibration from where it left off, if in the calibration mode.</p>

Menu SS2 or CAL_SS2, Set Scaling 2

MENUS
ALPHABETICAL LISTING

MENU	DESCRIPTION
<p>SET SCALING OR PRESS <AUTOSCALE></p>	
<p>IMPEDANCE (ADMITTANCE) SMITH CHART</p>	<p>Scales an Impedance Smith chart for display in the active channel.</p>
<p>NORMAL SMITH (REFL = 1.0000000 FULL SCALE)</p>	<p>Selects a normal Smith chart for display in the active channel.</p>
<p>EXPAND 10 dB (REFL = 0.3162278 FULL SCALE)</p>	<p>Selects a 10 dB expansion of the Smith chart being displayed for the active channel.</p>
<p>EXPAND 20 dB (REFL = 0.1000000 FULL SCALE)</p>	<p>Selects a 20 dB expansion of the Smith chart being displayed for the active channel.</p>
<p>EXPAND 30 dB (REFL = 0.0316228 FULL SCALE)</p>	<p>Selects a 30 dB expansion of the Smith chart being displayed for the active channel.</p>
<p>COMPRESS 3 dB (REFL = 1.425375 FULL SCALE)</p>	<p>Selects a 3 dB compression of the Smith chart being displayed for the active channel.</p>
<p>PRESS <ENTER> TO SELECT AND RESUME CAL</p>	<p>On the CAL_SS3Z or Y menu, pressing the Enter key returns you to the calibration setup or sequence.</p>

Menu SS3Z/SS3Y or CAL_SS3Z/CALSS3Y, Set Scaling 3

MENU	DESCRIPTION
SET SCALING OR PRESS <AUTOSCALE> –LOG MAG– RESOLUTION XX.XXX dB/DIV REFERENCE VALUE XXX.XXX dB REFERENCE LINE X PRESS <ENTER> TO RESUME CAL	<p>Sets the resolution for the vertical axis of the active channel's displayed graph. Resolution can be set incrementally using the keypad or rotary knob.</p> <p>Sets the value at the reference line for the active channel amplitude measurement on the displayed graph. The value can be set in increments of 0.001 dB using the keypad or rotary knob.</p> <p>Sets the reference line for the active channel's amplitude measurement on the log-magnitude graph. This is the line about which the amplitude expands with different resolution values. The reference line can be set to any vertical division using the rotary knob.</p> <p>On the CAL_SS4 menu, pressing the Enter key returns you to the calibration setup or sequence.</p>

Menu SS4 or CAL_SS4, Set Scaling 4

MENUS
ALPHABETICAL LISTING

MENU	DESCRIPTION
<p>SET SCALING OR PRESS <AUTOSCALE></p> <p>-PHASE-</p> <p>RESOLUTION XX.XXX °/DIV</p> <p>REFERENCE VALUE XXX.XXX °</p> <p>REFERENCE LINE X</p> <p>PHASE SHIFT X.XX °</p> <p>PRESS <ENTER> TO RESUME CAL</p>	<p>Sets the resolution for the vertical axis of the active channel's displayed graph. Resolution can be set incrementally using the keypad or rotary knob.</p> <p>Sets the value at the reference line for the active channel amplitude measurement on the displayed graph. The value can be set in increments of 0.01 ° using the keypad or rotary knob.</p> <p>Sets the reference line for the active channel's amplitude measurement. This is the line about which the amplitude expands with different resolution values. The reference line can be set to any vertical division using the rotary knob.</p> <p>Sets the value by which the active channel's phase measurement is shifted on the phase graph. The shift can be set in increments of 0.01 degrees using the keypad or rotary knob. This is useful when phase data is near the 180 degree rollover value.</p> <p>On the CAL_SS5 menu, pressing the Enter key returns you to the calibration setup or sequence.</p>

Menu SS5 or CAL_SS5, Set Scaling 5

MENU	DESCRIPTION
<p style="text-align: center;">SET SCALING OR PRESS <AUTOSCALE></p> <p style="text-align: center;">-LOG POLAR-</p> <p style="text-align: center;">RESOLUTION XX.XXX dB/DIV</p> <p style="text-align: center;">REFERENCE VALUE XXX.XXX dB</p> <p style="text-align: center;">FIXED REFERENCE LINE</p> <p style="text-align: center;">SELECT POLAR CHART MODE MAGNITUDE PHASE</p> <p style="text-align: center;">PRESS <ENTER> TO SELECT AND RESUME CAL</p>	<p>Sets the resolution for the vertical axis of the active channel's displayed graph. Resolution can be set incrementally using the keypad or rotary knob.</p> <p>Sets the value at the reference line for the active channel amplitude measurement on the displayed graph. The value can be set in increments of 0.001 dB using the keypad or rotary knob.</p> <p>Sets the reference line for the active channel's amplitude measurement. This is the line about which the amplitude expands with different resolution values. The reference line can be set to any vertical division using the rotary knob.</p> <p>Calls menu PC1, which lets you define the phase angles between which your polar chart will display data.</p> <p>Pressing the Enter key implements your menu selection and resumes the calibration from where it left off, if in the calibration mode.</p>

Menu SS6 or CAL_SS6, Set Scaling 6

MENUS
ALPHABETICAL LISTING

S

MENU	DESCRIPTION
<p>SET SCALING OR PRESS <AUTOSCALE></p> <p>–GROUP DELAY–</p> <p>RESOLUTION XX.XXX fs/DIV</p> <p>REF VALUE XXX.XXX fs</p> <p>REFERENCE LINE X</p> <p>APERTURE X.X PERCENT OF SWEEP</p> <p>PRESS <ENTER> TO RESUME CAL</p>	<p>Sets the resolution for the vertical axis of the active channel's displayed graph. Resolution can be set incrementally using the keypad or rotary knob.</p> <p>Sets the value at the reference line for the active channel amplitude measurement on the displayed graph. The value can be set in increments of 0.0001 s using the keypad or rotary knob.</p> <p>Sets the reference line for the active channel's amplitude measurement. This is the line about which the amplitude expands with different resolution values. The reference line can be set to any vertical division using the rotary knob.</p> <p>Sets and displays the percent of frequency span over which group delay is calculated.</p> <p>On the CAL_SS7 menu, pressing the Enter key returns you to the calibration setup or sequence.</p>

Menu SS7 or CAL_SS7, Set Scaling 7

MENU	DESCRIPTION
SET SCALING OR PRESS <AUTOSCALE> -LINEAR MAG- RESOLUTION XX.XXX U/DIV REFERENCE VALUE XXX.XXX pU REFERENCE LINE X PRESS <ENTER> TO RESUME CAL	<p>Sets the resolution for the vertical axis of the active channel's displayed graph. Resolution can be set incrementally using the keypad or rotary knob.</p> <p>Sets the value at the reference line for the active channel amplitude measurement on the displayed graph. The value can be set in increments of 0.001 U using the keypad or rotary knob.</p> <p>Sets the reference line for the active channel's amplitude measurement. This is the line about which the amplitude expands with different resolution values. The reference line can be set to any vertical division using the rotary knob.</p> <p>On the CAL_SS8 menu, pressing the Enter key returns you to the calibration setup or sequence.</p>

Menu SS8 or CAL_SS8, Set Scaling 8

MENU	DESCRIPTION
SET SCALING OR PRESS <AUTOSCALE>	
-LINEAR MAG-	
RESOLUTION XX.XXX U/DIV	Sets the resolution for the vertical axis of the active channel's displayed graph. Resolution can be set incrementally using the keypad or rotary knob.
REFERENCE VALUE XXX.XXX μ U	Sets the value at the reference line for the active channel amplitude measurement on the displayed graph. The value can be set in increments of 0.001 U using the keypad or rotary knob.
REFERENCE LINE X	Sets the reference line for the active channel's amplitude measurement. This is the line about which the amplitude expands with different resolution values. The reference line can be set to any vertical division using the rotary knob.
-PHASE-	
RESOLUTION XX.XX $^{\circ}$ /DIV	Sets the resolution for the vertical axis of the active channel's displayed phase graph. Resolution can be set incrementally using the keypad or rotary knob.
REF VALUE XXX.XX $^{\circ}$	Sets the value by which the active channel's phase measurement is offset on the phase graph. The offset can be set in increments of 0.01 degrees using the keypad or rotary knob.
REFERENCE LINE X	Sets the reference line for the active channel's phase measurement on the phase graph. This is the line about which the phase expands with different resolution values. The reference line can be set to any vertical division using the rotary knob.
PHASE SHIFT X.XX $^{\circ}$	Sets the value by which the active channel's phase measurement is shifted on the phase graph. The shift can be set in increments of 0.01 degrees using the keypad or rotary knob. This is useful when phase data is near the 180 degree rollover value.
PRESS <ENTER> TO RESUME CAL	On the CAL_SS9 menu, pressing the Enter key returns you to the calibration setup or sequence.

Menu SS9 or CAL_SS9, Set Scaling 9

MENU	DESCRIPTION
SET SCALING OR PRESS <AUTOSCALE>	
-REAL-	
RESOLUTION XX.XXX U/DIV	Sets the resolution for the vertical axis of the active channel's displayed graph. Resolution can be set incrementally using the keypad or rotary knob.
REFERENCE VALUE XXX.XXX pU	Sets the value at the reference line for the active channel amplitude measurement on the displayed graph. The value can be set in increments of 0.001 U using the keypad or rotary knob.
REFERENCE LINE X	Sets the reference line for the active channel's amplitude measurement. This is the line about which the amplitude expands with different resolution values. The reference line can be set to any vertical division using the rotary knob.
PRESS <ENTER> TO RESUME CAL	On the CAL_SS10 menu, pressing the Enter key returns you to the calibration setup or sequence.

Menu SS10 or CAL_SS10, Set Scaling 10

MENUS
ALPHABETICAL LISTING

MENU	DESCRIPTION
<p>SET SCALING OR PRESS <AUTOSCALE></p> <p>-IMAGINARY-</p> <p>RESOLUTION XX.XXX U/DIV</p> <p>REFERENCE VALUE XXX.XXX pU</p> <p>REFERENCE LINE X</p> <p>PRESS <ENTER> TO RESUME CAL</p>	<p>Sets the resolution for the vertical axis of the active channel's displayed graph. Resolution can be set incrementally using the keypad or rotary knob.</p> <p>Sets the value at the reference line for the active channel amplitude measurement on the displayed graph. The value can be set in increments of 0.001 U using the keypad or rotary knob.</p> <p>Sets the reference line for the active channel's amplitude measurement. This is the line about which the amplitude expands with different resolution values. The reference line can be set to any vertical division using the rotary knob.</p> <p>On the CAL_SS11 menu, pressing the Enter key returns you to the calibration setup or sequence.</p>

Menu SS11 or CAL_SS11, Set Scaling 11

MENU	DESCRIPTION
SET SCALING OR PRESS <AUTOSCALE>	
-REAL-	
RESOLUTION XX.XXX U/DIV	Sets the resolution for the vertical axis of the active channel's displayed graph. Resolution can be set incrementally using the keypad or rotary knob.
REFERENCE VALUE XXX.XXX pU	Sets the value at the reference line for the active channel amplitude measurement on the displayed graph. The value can be set in increments of 0.001 U using the keypad or rotary knob.
REFERENCE LINE X	Sets the reference line for the active channel's amplitude measurement. This is the line about which the amplitude expands with different resolution values. The reference line can be set to any vertical division using the rotary knob.
-IMAGINARY-	
RESOLUTION XX.XX °/DIV	Sets the resolution for the vertical axis of the active channel's displayed graph. Resolution can be set incrementally using the keypad or rotary knob.
REFERENCE VALUE XXX.XX °	Sets the value by which the active channel's phase measurement is offset on the phase graph. The offset can be set in increments of 0.01 degrees using the keypad or rotary knob.
REFERENCE LINE X	Sets the reference line for the active channel's phase measurement on the phase graph. This is the line about which the phase expands with different resolution values. The reference line can be set to any vertical division using the rotary knob.
PRESS <ENTER> TO RESUME CAL	On the CAL_SS12 menu, pressing the Enter key returns you to the calibration setup or sequence.

Menu SS12 or CAL_SS12, Set Scaling 12

MENUS
ALPHABETICAL LISTING

S

MENU	DESCRIPTION
SET SCALING OR PRESS <AUTOSCALE>	
-SWR-	
RESOLUTION XX.XXX U /DIV	Sets the resolution for the vertical axis of the active channel's displayed graph. Resolution can be set incrementally using the keypad or rotary knob.
REFERENCE VALUE XXX.XXX U	Sets the value at the reference line for the active channel amplitude measurement on the displayed graph. The value can be set in increments of 0.001 U using the keypad or rotary knob.
REFERENCE LINE X	Sets the reference line for the active channel's amplitude measurement. This is the line about which the amplitude expands with different resolution values. The reference line can be set to any vertical division using the rotary knob.
PRESS <ENTER> TO RESUME CAL	On the CAL_SS13 menu, pressing the Enter key returns you to the calibration setup or sequence.

Menu SS13 or CAL_SS13, Set Scaling 13

MENU	DESCRIPTION
SET SCALING OR PRESS <AUTOSCALE> -POWER OUT- RESOLUTION XX.XXX dB/DIV REFERENCE VALUE XXX.XXX dBm REFERENCE LINE X	Sets the resolution for the vertical axis of the active channel's displayed graph. Resolution can be set incrementally using the keypad or rotary knob. Sets the value at the reference line for the active channel amplitude measurement on the displayed graph. Sets the reference line for the active channel's amplitude measurement. This is the line about which the amplitude expands with different resolution values. The reference line can be set to any vertical division using the rotary knob.

Menu SS14, Set Scaling 14

MENUS
ALPHABETICAL LISTING

S

MENU	DESCRIPTION
SWEEP SETUP	
START XXX.XXXXXXXXXX GHz	Enter the sweep-start frequency in GHz. The start frequency must be lower than the stop frequency.
STOP XXX.XXXXXXXXXX GHz	Enter the sweep-stop frequency in GHz. The stop frequency must be higher than the start frequency.
SET CENTER/SPAN	Calls menu SU1_CENTER, which lets you set values for center frequency and span width.
XXX DATA POINTS XXX.XXXXXXXXXX GHz STEPSIZE	Displays the number of frequency points and the spacing between points for the start and stop frequencies selected above. The number of points shown provides the finest frequency resolution possible, based on your Data Points key menu selection.
C.W. MODE ON (OFF) XXX.XXXXXXXXXX GHz	Move cursor here and press Enter to enable the CW mode. Enter CW frequency for measurements.
MARKER SWEEP	Move cursor here and press Enter to set the start and stop frequencies (menu SU5) of the CW frequency (menu SU6) to the values of any marker.
DISCRETE FILL	Calls Discrete Fill Menu (menu DF1).
HOLD BUTTON FUNCTION	Calls menu SU4, which lets you set the action of the HOLD key.
TEST SIGNALS	Calls menu SU2, which lets you set the source power and the values for the attenuators in the 371XXA. It also provides entry into the Flat Test Port Power calibration.
PRESS <ENTER> TO SELECT OR TURN ON/OFF	Pressing the ENTER key implements your menu selection.

Menu SU1, Sweep Setup 1

MENU	DESCRIPTION
SWEEP SETUP	
CENTER XXX.XXXXXXXXXX GHz	Enter the center frequency in GHz.
SPAN XXX.XXXXXXXXXX GHz	Enter the span frequency in GHz.
SET START/STOP XXX DATA POINT(S) XXX.XXXXXXXXXX GHz STEPSIZE	Calls menu SU1, which lets you set values for start and stop frequencies. Displays the number of frequency points and the spacing between points for the center and span frequencies selected above. The number of points shown provides the finest frequency resolution possible, based on your Data Points key menu selection.
C.W. MODE ON (OFF) XXX.XXXXXXXXXX GHz	Move cursor here and press Enter to enable the CW mode. Enter CW frequency for measurements.
MARKER SWEEP	Move cursor here and press Enter to set the start and stop frequencies (menu SU5) of the CW frequency (menu SU6) to the values of any marker.
DISCRETE FILL	Calls Discrete Fill Menu (menu DF1).
HOLD BUTTON FUNCTION	Calls menu SU4, which lets you set the action of the HOLD key.
TEST SIGNALS	Calls menu SU2, which lets you set the source power and the values for the attenuators in the 371XXA. It also provides entry into the Flat Test Port Power calibration.
PRESS <ENTER> TO SELECT OR TURN ON/OFF	Pressing the ENTER key implements your menu selection.

Menu SU1_CENTER, Sweep Setup 1

MENU	DESCRIPTION
<p>TEST SIGNALS</p> <p>POWER CONTROL +XX.X dB 0 TO -15.0 dB)</p> <p>PORT 1 ATTN XX10 dB (0 - 70)</p> <p>PORT 1 POWER -XX.XX dBm</p> <p>PORT 2 ATTN XX10 dB (0-X0)</p> <p>CALIBRATE FOR FLATNESS (CAL EXISTS)</p> <p>FLATNESS ON(OFF) CORRECTION AT XX.X dBm</p> <p>SOURCE 2 POWER -XX.XX dBm</p> <p>EXIT APPLICATION</p> <p>PRESS <ENTER> TO SELECT</p>	<p>Enter the delta-power level for the Port 1 output in dB.</p> <p>Attenuates the microwave source power at port 1 from 0 to 70 dB, in 10 dB steps. The power is attenuated before being applied to Port 1 for a forward transmission or reflection test (S₂₁ or S₁₁, respectively).</p> <p>Displays the Port 1 power, in dBm.</p> <p>Attenuates from 0 to 40 dB (10 dB steps) the microwave power being input to Port 2 from the device-under-test (DUT).</p> <p>Calls menu SU8 or CAL_SU8, depending on whether valid Flat Test Port Power calibration data exists. Both of these menus provide selection control for the Flat Test Port Power feature.</p> <p>Enter the power level, in dBm, of the 2nd, external frequency source.</p> <p>Exits the Gain Compression application and returns to S parameter measurements. It restores the measurement setup.</p> <p>Pressing the Enter key implements your menu selection.</p>

Menu SU2 or CAL_SU2, Sweep Setup 2

MENU	DESCRIPTION
TEST SIGNALS	
SOURCE 1 PWR +XX.XX dBm	Enter and display the power level, in dBm, of the internal frequency source.
SOURCE 2 PWR +XX.XX dBm	Enter and display the power level, in dBm, of the 2nd, external frequency source.
PORT 1 ATTN 0 * 10 dB (0 - 70)	Attenuates the microwave source power at port 1 from 0 to 70 dB, in 10 dB steps. The power is attenuated before being applied to Port 1 for a forward transmission or reflection test (S_{21} or S_{11} , respectively). (NO STEP ATTENUATOR IN MODEL 372XXB)
PORT 2 ATTN 0 * 10 dB (0 - 00)	Attenuates from 0 to 40 dB (10 dB steps) the microwave power being input to Port 2 from the device-under-test (DUT).
PREVIOUS MENU	Returns you to the previous menu. (RESUME CAL may be used instead of PREVIOUS MENU, when accessed during a calibration.)
PRESS <ENTER> TO SELECT OR TURN ON/OFF	Pressing the Enter key implements your menu selection.

Menu SU2A or CAL_SU2A, Sweep Setup 2A

MENUS
ALPHABETICAL LISTING

MENU	DESCRIPTION
<p>SINGLE POINT MEASUREMENT SETUP</p> <p>C.W. FREQ XXX.XXXXXXXXXX GHz</p> <p>HOLD BUTTON FUNCTION</p> <p>TEST SIGNALS</p> <p>RETURN TO SWEEP MODE</p> <p>PRESS <ENTER> TO SELECT</p>	<p>Enter the measurement frequency in GHz for continuous wave (CW) operation.</p> <p>Calls menu SU4, which lets you set the action of the HOLD key.</p> <p>Calls menu SU2, which lets you set values for the source power and attenuators. It also provides entry into the Flat Test Port Power calibration.</p> <p>Move cursor here and press Enter to return to the F1-F2 sweep mode (Menu SU1).</p> <p>Pressing the Enter key implements your menu selection.</p>

Menu SU3, Single-Point Measurement Setup

MENU	DESCRIPTION
SWEPT POWER SETUP	
SWEPT POWER FREQUENCY XXX.XXXXXXXXXX GHz	Enter the swept-power frequency in GHz.
P START -XX.XX dBm	Displays the start power value in dBm.
P STOP -XX.XX dBm	Displays the stop power value in dBm.
STEPSIZE -XX.XX dB	Displays the power step size value in dB.
POWER SWEEP ON(OFF) -XX.XX dBm	Turns power sweep on or off.
HOLD BUTTON FUNCTION	Calls Menu SU4.
SWEPT POWER GAIN COMPRESSION	Calls Menu GC3 and extended menu EXT_GC3.
RETURN TO SWEPT FREQUENCY MODE	Calls Menu SU1.
PRESS <ENTER> TO SELECT OR TURN ON/OFF	Pressing the Enter key implements your menu selection.

Menu SU3A, Swept-Power Measurement Setup

MENUS
ALPHABETICAL LISTING

MENU	DESCRIPTION
<p>SELECT FUNCTION FOR HOLD BUTTON</p>	
<p>HOLD/CONTINUE</p>	<p>Causes the hold key (button) to stop and start the sweep.</p>
<p>HOLD/RESTART</p>	<p>Causes the hold key to stop and restart the sweep.</p>
<p>SINGLE SWEEP AND HOLD</p>	<p>Causes the hold key to trigger a single sweep and hold when finished. (Two sweeps, one from Port 1 to 2 and another from Port 2 to 1, are accomplished for a 12-Term measurement.)</p>
<p>BIAS/RF HOLD CONDITIONS</p>	
<p>BIAS ON (OFF)</p>	<p>Select bias to be on or off (test sets having bias input only) while system is in hold.</p>
<p>RF ON (OFF)</p>	<p>Selects RF to be on or off while system is in hold.</p>
<p>DUT/AUT ON (OFF) PROTECTION DEFAULT RESET TURNS ON HOLD WITH BIAS/RF TURNED OFF</p>	<p>When on, a default reset places the system in hold with RF and bias turned off. This choice is initialized to OFF when the software version changes or after a Default Program key press, so that the system comes up in the sweep mode.</p>
<p>PRESS <ENTER> TO SELECT</p>	<p>Pressing the Enter key implements your menu selection.</p>

Menu SU4, Select Function for Hold Button

MENU	DESCRIPTION
<p>FREQUENCY MARKER SWEEP</p> <p>START SWEEP MARKER (n) XXX.XXXXXXXXXX GHz</p> <p>STOP SWEEP MARKER (n) XXX.XXXXXXXXXX GHz</p> <p>USE KEYPAD TO SELECT MARKER (1-6)</p>	<p>Pressing a number on the keypad causes the associated marker to be the start frequency of the sweep.</p> <p>Pressing a number on the keypad causes the associated marker to be the stop frequency of the sweep.</p> <p>Use the keypad to select markers 1, 2, 3, 4, 5, or 6.</p>

Menu SU5, Frequency Marker Sweep

MENUS
ALPHABETICAL LISTING

S

MENU	DESCRIPTION
FREQUENCY MARKER C.W. C.W. FREQ MARKER (n) XXX.XXXXXXXXXX GHz USE KEYPAD TO SELECT MARKER (1-6)	Pressing a number on the keypad causes the associated marker to be the C.W. frequency. Use the keypad to select markers 1, 2, 3, 4, 5, or 6.

Menu SU6, Frequency Marker C.W.

MENU	DESCRIPTION
<p style="text-align: center;">CALIBRATE FOR FLAT PORT POWER</p> <p>FORWARD DIRECTION ONLY</p> <p>XXX POINTS MEASURE 1 PWR POINT EVERY XX POINT(S)</p> <p>POWER TARGET -XXX.X dBm</p> <p>START FLAT POWER CALIBRATION</p> <p>PREVIOUS MENU</p>	<p>Displays the number of power points (0 – 50) to be skipped during the power sweep. The points not measured are interpolated to provide a flat sweep.</p> <p>Lets users set a flat output-power value (power target). The VNA defaults to Port 1 power.</p> <p>Begins the calibration. If calibration is successful, you are returned to menu SU8. If the calibration unsuccessful due to a fatal error (Source or power meter inoperable or not connected), this menus remains displayed. At any time, you can abort the calibration by pressing the DE-FAULT PROGRAM or CLEAR/RET LOC keys. All other keys are locked out.</p> <p>Returns you to previous menu.</p>

Menu SU8 or CAL_SU8, Calibrate For Flat Test Port Power

- FLAT POWER CALIBRATION -

FLAT POWER CALIBRATION ADJUSTS THE SOURCE OUTPUT POWER AT EACH MEASUREMENT POINT ACROSS A FREQUENCY SPAN TO PROVIDE A CONSTANT POWER LEVEL AT THE TEST PORT (FORWARD DIRECTION ONLY).

- INSTRUCTIONS -

1. PRESET, ZERO, AND CALIBRATE THE POWERMETER.
2. CREATE AND ACTIVATE THE POWERMETER'S CAL FACTOR LIST FOR THE POWER SENSOR BEING USED.
3. CONNECT THE POWERMETER TO THE DEDICATED GPIB INTERFACE AND THE POWER SENSOR TO THE TEST PORT.
4. SELECT <START FLAT POWER CALIBRATION>.

000.0

Text Associated With Flat Power Calibration Menu SU8

MENU	DESCRIPTION
PRESS <ENTER> TO SELECT TURN KNOB TO CHANGE NUMBER OF POINTS	Pressing the Enter key implements your menu selection or turns the function on/off.

Menu SU9, Number of Data Points

MENUS
ALPHABETICAL LISTING

S

MENU	DESCRIPTION
NUMBER OF DATA POINTS POINTS DRAWN IN C.W. XXXX POINT(S)	Displays the number of data point, when in the CW mode. This number can be between 1 and 1601.

Menu SU9A, Number of Data Points 2

MENU	DESCRIPTION
DOMAIN	
FREQUENCY	Displays the data in normal frequency domain format.
FREQUENCY WITH TIME GATE	Displays the data in the frequency domain after a specific time range has been sampled by the gate function.
TIME LOWPASS MODE	Displays the data in the time (distance) domain, using true lowpass processing. Data must be taken using a harmonic series calibration and sweep in order to use this mode.
TIME BANDPASS MODE	Displays the data in the time (distance) domain using bandpass processing. Any data sweep range using normal calibration can be used.
-SETUP-	
DISPLAY TIME/DISTANCE	Switches the mode of display between time and distance. This does not affect the actual displayed data, but only the annotation.
SET RANGE	Call a menu that lets you set range and other display parameters.
SET GATE	Calls a menu that lets you set gate parameters.
GATE ON/OFF/DISP	Switches the gate on or off each time Enter is pressed.
HELP	Displays an informational help menu.
PRESS <ENTER> TO SELECT OR SWITCH	Pressing the Enter key implements your menu selection.

Menu TD1, Domain (Frequency/Display)

MENUS

ALPHABETICAL LISTING

T

MENU	DESCRIPTION
LOWPASS TIME DOMAIN SETUP	
START XXX.XXX ps	Sets the start time of the display.
STOP XXX.XXX ps	Sets the stop time of the display..
CENTER XXX.XXX ps	Sets the center time of the display.
SPAN XXX.XXX ps	Sets the span (Stop - Start) of the display.
MARKER RANGE	Takes you to a menu that lets you set the display to a range determined by two of the markers.
RESPONSE IMPULSE/STEP	Switches between Impulse and Step response each time Enter is pressed.
MORE	Takes you to a menu that contains additional selections for display setup.

Menu TD2_LP_TIME, Lowpass Time Domain Setup

MENU	DESCRIPTION
LOWPASS DISTANCE DISPLAY SETUP	
START XXX.XXX mm	Sets the start time of the display.
STOP XXX.XXX mm	Sets the stop time of the display.
CENTER XXX.XXX mm	Sets the center time of the display.
SPAN XXX.XXX mm	Sets the span (Stop - Start) of the display.
MARKER RANGE	Takes you to a menu that lets you set the display to a range determined by two of the markers.
RESPONSE IMPULSE/STEP	Switches between Impulse and Step response each time Enter is pressed.
MORE	Takes you to a menu that contains additional selections for display setup.
RELATIVE VELOCITY X.X	Indicates the relative velocity of light, as set by the dielectric constant in menu RD2.
PRESS <ENTER> TO SELECT	Pressing the Enter key implements your menu selection.

Menu TD2_LP_DIST, Lowpass Distance Display Setup

MENUS

ALPHABETICAL LISTING

T

MENU	DESCRIPTION
BANDPASS TIME DOMAIN SETUP	
START XXX.XXX ps	Sets the start time of the display.
STOP XXX.XXX ps	Sets the stop time of the display.
CENTER XXX.XXX ps	Sets the center time of the display.
SPAN XXX.XXX ps	Sets the span (Stop - Start) of the display.
MARKER RANGE	Takes you to a menu that lets you set the display to a range determined by two of the markers.
PHASOR ON/OFF IMPULSE	Switches Phasor Impulse processing on or off each time Enter is pressed.
HELP – PHASOR IMPULSE	Displays an informational help menu.
MORE	Takes you to a menu that contains additional selections for display setup.
PRESS <ENTER> TO SELECT OR TURN ON/OFF	Pressing the Enter key implements your menu selection.

Menu TD2_BP_TIME, Bandpass Time Domain Setup

MENU	DESCRIPTION
BANDPASS DISTANCE DISPLAY SETUP	
START XXX.XXX mm	Sets the start time of the display.
STOP XXX.XXX mm	Sets the stop time of the display.
CENTER XXX.XXX mm	Sets the center time of the display.
SPAN XXX.XXX mm	Sets the span (Stop - Start) of the display.
MARKER RANGE	Takes you to a menu that lets you set the display to a range determined by two of the markers.
PHASOR ON/OFF IMPULSE	Switches Phasor Impulse processing on or off each time Enter is pressed.
HELP – PHASOR IMPULSE	Displays an informational help menu.
MORE	Takes you to a menu that contains additional selections for display setup.
RELATIVE VELOCITY X.X	Indicates the relative velocity of light, as set by the dielectric constant in menu RD2.
PRESS <ENTER> TO SELECT OR TURN ON/OFF	Pressing the Enter key implements your menu selection.

Menu TD2_BP_DIST, Bandpass Distance Display Setup

MENUS
ALPHABETICAL LISTING

MENU	DESCRIPTION
BANDPASS TIME DOMAIN SETUP WINDOW SHAPE NOMINAL SET GATE PREVIOUS MENU PRESS <ENTER> TO SELECT	Takes you to a menu that lets you change the window type. Takes you to a menu that lets you set the gate parameters. Returns you to the previous menu. Pressing the Enter key implements your menu selection.

Menu TD3_BP, Bandpass Time Domain Setup

MENU	DESCRIPTION
LOWPASS TIME DOMAIN SETUP WINDOW SHAPE NOMINAL SET GATE D.C. TERM XXXXX XXXXXXXXXXXX PREVIOUS MENU PRESS <ENTER> TO SELECT	Takes you to a menu that lets you change the window type. Takes you to a menu that lets you set the gate. Takes you to a menu that lets you set the D.C. term for lowpass processing. Returns you to the previous menu. Pressing the Enter key implements your menu selection.

Menu TD3_LP, Lowpass Time Domain Setup

MENU	DESCRIPTION
GATE	
START XXX.XXX xx	Sets the start time of the gate.
STOP XXX.XXX xx	Sets the stop time of the gate.
CENTER XXX.XXX xx	Sets the center time of the gate.
SPAN XXX.XXX xx	Sets the span (Stop - Start) of the gate. Also, provides for an anti-gate if a negative value is entered. Refer to Chapter 9, paragraphs 9-6 and 9-7 for additional information.
SET SHAPE XXXXXXXXXX	Takes you to a menu that lets you set the shape of the gate.
GATE ON/OFF/DISP	Switches the gate on or off each time Enter is pressed.
SET RANGE	Takes you back to menu TD2_XX_XXXX (LP_TIME, LP_DIST, BP_TIME, BP_DIST), depending on the type of measurement you selected in menu TD1.
PRESS <ENTER> TO SELECT	Pressing the Enter key implements your menu selection.

Menu TD4_TIME & TD4_DIST, Gate (Distance/Time)

MENUS
ALPHABETICAL LISTING

T

MENU	DESCRIPTION
<p>SELECT WINDOW SHAPE</p>	
RECTANGULAR	Selects a Rectangular (one-term) shape.
NOMINAL	Selects a two-term Hamming shape.
LOW SIDELOBE	Selects a three-term Blackman-Harris shape.
MIN SIDELOBE	Selects a four-term Blackman-Harris shape.
HELP	Displays an informational help menu.
<p>PRESS <ENTER> TO SELECT</p>	Pressing the Enter key implements your menu selection.

Menu TD5_WINDOW, Shape

MENU	DESCRIPTION
<p>SELECT GATE SHAPE</p>	
MINIMUM	Selects minimum shape. Sharpest rolloff, some frequency domain ripple. Not allowed with low or minimum sidelobe window.
NOMINAL	Selects a nominal shape. Good results in most applications. Not allowed with minimum sidelobe window.
WIDE	Selects wide shape. Gradual rolloff and better residual ripple.
MAXIMUM	Selects a maximum shape. Least rolloff and best residual ripple.
HELP	Displays an informational help menu.
<p>PRESS <ENTER> TO SELECT</p>	Pressing the Enter key implements your menu selection.

Menu TD5_GATE, Shape

MENU	DESCRIPTION
SET D.C. TERM FOR LOWPASS PRO- CESSING	Since it is impossible to measure the true D.C. term required for lowpass processing, a value must be estimated. This menu allows a choice between five different selections for this value.
AUTO EXTRAPOLATE	Sets the D.C. term to a value determined by extrapolating the data points near the zero frequency.
LINE IMPEDANCE	Sets the D.C. term to the characteristic impedance of the transmission medium (Z_0).
OPEN	Sets the D.C. term to correspond to an open circuit.
SHORT	Sets the D.C. term to correspond to a short circuit.
OTHER XXX.XXX (REFLECTION COEFFICIENT X.XXX pU)	Sets the D.C. term to the value entered.
PREVIOUS MENU	Returns you to the previous menu.
PRESS <ENTER> TO SELECT	Pressing the Enter key implements your menu selection.

Menu TD6, Set D.C. Term for Low Pass Processing

MENUS
ALPHABETICAL LISTING

T

MENU	DESCRIPTION
TIME MARKER SWEEP	
START TIME MARKER () XXX.XXX ns	Sets the start time to the value of the selected marker.
STOP TIME MARKER () XXX.XXX ns	Sets the stop time to the value of the selected marker.
RESTORE ORIGINAL RANGE	Returns the display to the original time range that was in effect before the marker range was selected.
PREVIOUS MENU	Returns you to the previous menu.
USE KEYPAD TO CHOOSE MARKER (1 - 6)	Select marker number from keypad.
PRESS <ENTER> TO SELECT	Pressing the Enter key implements your menu selection.

Menu TD7_TIME, Time Marker Sweep.

MENU	DESCRIPTION
DISTANCE MARKER SWEEP	
START DIST MARKER () XX.XXXX cm	Sets the start time to the value of the selected marker.
STOP DIST MARKER () X.XXXX m	Sets the stop time to the value of the selected marker.
RESTORE ORIGINAL RANGE	Returns the display to the original time range that was in effect before the marker range was selected.
PREVIOUS MENU	Returns you to the previous menu.
USE KEYPAD TO CHOOSE MARKER (1 - 6)	Select marker number from keypad.
PRESS <ENTER> TO SELECT	Pressing the Enter key implements your menu selection.

Menu TD7_DIST, Distance Marker Range

MENUS
ALPHABETICAL LISTING

T

MENU	DESCRIPTION
TRIGGERS MEASUREMENT	
INTERNAL	Internally triggers a point-by-point measurement. Choosing this option always turns AUTOMATIC I.F. CALIBRATION off.
EXTERNAL	Provides for externally triggering a point-by-point measurement via the rear panel External Trigger connector. Choosing this option always turns AUTOMATIC I.F. CALIBRATION off.
I.F. CALIBRATION AUTOMATIC ON (OFF) I.F. CAL	Turns on or off the timer for I.F. calibration. The timer automatically triggers an I.F. calibration at regular intervals for internal hardware calibrations. It can be set on or off when in either INTERNAL or EXTERNAL trigger measurement mode.
TRIGGER I.F. CAL	Immediately triggers an I.F. calibration, which calibrates the internal hardware. A "CALIBRATING IF..." message is displayed.
PRESS <ENTER> TO SELECT OR TURN ON/OFF	Pressing the Enter key implements your menu selection.

Menu TRIG, Triggers Measurement

MENU	DESCRIPTION
SELECT UTILITY FUNCTION OPTIONS	
GPIB ADDRESSES	Calls menu GP7, which displays the current GPIB addresses of the various dedicated instruments.
DISPLAY INSTRUMENT STATE PARAMS	Calls menu U2, which lets you display the various instrument state parameters.
GENERAL DISK UTILITIES	Calls menu DSK1-FD, which lets you select between several disk utilities.
CAL COMPONENT UTILITIES	Calls menu U3, which lets you select between several calibration-component utilities.
AUTOCAL UTILITIES	Calls Menu ACAL_UTIL, which lets you select various AutoCal utilities.
COLOR CONFIGURATION	Calls menu U5, which lets you configure the screen colors.
DATA ON (OFF) DRAWING	Turns data drawing on or off for all channels.
BLANKING FREQUENCY INFORMATION	Blanks all frequency-identifier information from the 371XXA displays, if such information is presently being displayed. Hides the frequency value with X's, such as XXX.XXXXXXXXXX GHz.
SET DATE/TIME	Lets users set the date and time.
PRESS <ENTER> TO SELECT OR TURN ON/OFF	Pressing the Enter key implements your menu selection.

Menu U1, Utility Menu

MENUS
ALPHABETICAL LISTING

U

MENU	DESCRIPTION
DISPLAY INSTRUMENT STATE PARAMETERS	
SYSTEM	Displays all of the system parameters (Readout Text for U2, on the following pages).
CALIBRATION	Displays the calibration parameters.
OPERATING	Displays the global operating parameters.
CHANNEL 1 & 2	Displays the Channel 1-2 operating parameters.
CHANNEL 3 & 4	Displays the Channel 3-4 operating parameters.
NEXT PARAM PAGE	Alternately displays Readout Text U3 a thru e.
PRESS <ENTER> TO SELECT	Pressing the Enter key implements your menu selection.

Menu U2, Display Instrument State

U

Readout Text U2, Global Operating Parameters

Parameter	Display Format
Number of Points	
Power Control	xx.x dB
Port 1 Attenuation	xx.x dB
Port 2 Attenuation	xx.x dB
Source 2 Power	xx.x dB
Reference Impedance	xx.xxx Ω
Averaging	xxx Meas. per point
Smoothing	Off/On x.x percent of sweep Off/On

Readout Text U2, Channel Parameters

Parameter	Display Format
Number of Points	
Power Control	xx.x dB
Port 1 Attenuation	xx.x dB
Port 2 Attenuation	xx.x dB
Source 2 Power	xx.x dB
Reference Impedance	xx.xxx Ω
Averaging	xxx Meas. per point
Smoothing	Off/On x.x percent of sweep Off/On

Readout Text U2, System Parameters

Parameter	Display Format
<i>Model</i>	xxxxxxxx
<i>Serial Number</i>	xxx
<i>Software Version</i>	xxxxxxxx
<i>Options</i>	xxxxxxxx
<i>IEEE 488.2 GPIB Interface</i>	
Address	xx
Enable Registers	xx
Service Request	xx
Standard Event Status	
Parallel Poll	
Extended Event Status	
Limits Testing Status	
<i>Dedicated GPIB Interface</i>	
External Source 1 Address	xxxxx
External Source 2 Address	xxxxx
Plotter Address	xxxxx
Power Meter Address	xxxxx
Frequency Counter	xxxxx
<i>Measurement Trigger</i>	xxxxxx
<i>Automatic I.F. Calibration</i>	xxxxxxxx
<i>Diagnostic Mode</i>	
Troubleshooting	xxx
Receiver Mode	xxxxxxxxxxxx
Search for Lock	xxx

Readout Text U2, Calibration Parameters

Parameter	Display Format
Cal Method	xxxxxxxx
Line Type Medium	xxxxxxxx
Cal Type	xxxxxxxx
Number of Points	xxxxxxxx
Start Freq	xxxxxxxx
Stop Freq	xxxxxxxx
Power Control	xx.x dB
Port 1 Attenuator	xx.x dB
Port 2 Attenuator	xx.x dB
Source 2 Power	xx.x dB
Load Type	xxxxxxxx
Through Offset	xxxxxxxx

MENUS
ALPHABETICAL LISTING

U

MENU	DESCRIPTION
<p>CALIBRATION COMPONENT UTILITIES</p> <p>INSTALL KIT INFORMATION FROM FLOPPY DISK</p> <p>DISPLAY COAXIAL INFORMATION</p> <p>DISPLAY WAVEGUIDE INFORMATION</p> <p>PRESS <ENTER> TO SELECT</p>	<p>Reads into memory the coefficient data from the calibration-components disk supplied with the calibration kits.</p> <p>Calls menu U4 and U4A, which lets you display the connector information for the various coaxial connectors supported.</p> <p>Displays the waveguide information loaded from the floppy diskette.</p> <p>Pressing the Enter key implements your menu selection.</p>

Menu U3, Calibration Component Utilities

MENU	DESCRIPTION
DISPLAY INSTALLED TEST PORT CONNECTOR INFORMATION	This menu lets you view coefficient data on components. The data appears in the display area of the screen (See readout text on next page).
SMA (M)	Select to display coefficient data for the SMA male components.
SMA (F)	Select to display coefficient data for the SMA female components.
K – CONN (M)	Select to display coefficient data for the K Connector male components.
K – CONN (F)	Select to display coefficient data for the K Connector female male components.
TYPE N (M)	Select to display coefficient data for the Type N male components.
TYPE N (F)	Select to display coefficient data for the Type N female components.
GPC - 3.5 (M)	Select to display coefficient data for the GPC-3.5 male components.
GPC - 3.5 (F)	Select to display coefficient data for the GPC-3.5 female components.
GPC - 7	Select to display coefficient data for the sexless GPC-7 components.
NEXT CONNECTOR	Cycles through selections SMA (M) to GPC 7.
MORE CONNECTORS	Calls up menu U4A and lets you select more connectors.
PREVIOUS MENU	Displays menu U3.
PRESS <ENTER> TO SELECT	Pressing the Enter key implements your menu selection.

Menu U4, Display Installed Calibration Components Information 1

MENU	DESCRIPTION
<p>DISPLAY INSTALLED CALIBRATION COMPONENT INFORMATION</p>	<p>This menu lets you view coefficient data for connectors. The data appears in the display area of the screen.</p>
<p>V-CONN (M)</p>	<p>Select to display coefficient data for the V Connector male components.</p>
<p>V-CONN (F)</p>	<p>Select to display coefficient data for the V Connector female components.</p>
<p>TNC (M)</p>	<p>Select to display coefficient data for the TNC male components.</p>
<p>TNC (F)</p>	<p>Select to display coefficient data for the TNC female components.</p>
<p>2.4 mm (M)</p>	<p>Select to display coefficient data for the 2.4 mm male components.</p>
<p>2.4 mm (F)</p>	<p>Select to display coefficient data for the 2.4 mm female components.</p>
<p>TYPE N (M) 75Ω</p>	<p>Select to display coefficient data for the Type N male 75Ω components.</p>
<p>TYPE N (F) 75Ω</p>	<p>Select to display coefficient data for the Type N female 75Ω components.</p>
<p>SPECIAL (M)</p>	<p>Select to display coefficient data for special male components.</p>
<p>SPECIAL (F)</p>	<p>Select to display coefficient data for special female components.</p>
<p>NEXT CONNECTOR</p>	<p>Cycles through selections V Connector to SPECIAL.</p>
<p>MORE CONNECTORS</p>	<p>Calls up menu U4A and lets you select more connectors.</p>
<p>PREVIOUS MENU</p>	<p>Returns you to menu U3.</p>
<p>PRESS <ENTER> TO SELECT</p>	<p>Pressing the Enter key implements your menu selection.</p>

Menu U4A, Display Installed Calibration Components Information 2

MENU	DESCRIPTION
COLOR CONFIGURATION	
DATA 10 RED	Sets the color for the data drawn on the CRT. Use rotary knob to cycle between the available colors. Default color is shown.
OVERLAY DATA 15 YELLOW	Sets the color for the overlay data drawn on the CRT. Use rotary knob to cycle between the available colors. Default color is shown.
MEMORY DATA 24 GREEN	Sets the color for the memory data drawn on the CRT. Use rotary knob to cycle between the available colors. Default color is shown.
MARKERS AND LIMITS 32 CYAN	Sets the color for the markers and limits drawn on the CRT. Use rotary knob to cycle between the available colors. Default color is shown.
GRATICULE 24 GREEN	Sets the color for the CRT graticule. Use rotary knob to cycle between the available colors. Default color is shown.
ANNOTATION AND MENU TEXT 24 GREEN	Sets the color for the annotation and menu text. Use rotary knob to cycle between the available colors. Default color is shown.
MENU HEADERS (TITLES & INFO) 32 CYAN	Sets the color for the menu headers and information. Use rotary knob to cycle between the available colors. Default color is shown.
BACKGROUND 0 BLANK	Sets the color for the background. Use rotary knob to cycle between the available colors. Default color is shown.
RESET COLORS	Resets colors to the default values.

Menu U5, Color Configuration

MENUS
ALPHABETICAL LISTING

U

MENU	DESCRIPTION
<p>SET DATE/TIME</p> <p>MINUTE XX</p> <p>HOUR XX</p> <p>DAY XX</p> <p>MONTH XX</p> <p>YEAR XXXX</p> <p>DONE, (SET DATE/TIME)</p> <p>PREVIOUS MENU (DATE/TIME NOT SET)</p> <p>PRESS <ENTER> TO SELECT</p>	<p>Sets the minute.</p> <p>Sets the hour.</p> <p>Sets the day.</p> <p>Sets the month.</p> <p>Sets the year.</p> <p>Prompts to set a new time.</p> <p>Returns to the previous menu.</p> <p>Pressing the Enter key implements your menu selection.</p>

Menu U6, Set Date/Time

Appendix B

Rear Panel Connectors

B-1 INTRODUCTION

This appendix provides descriptions and pinout diagrams for the 373XXA rear panel connectors .

B-2 373XXA REAR PANEL

The 373XXA rear panel connectors are described on page B-2 and B-3.

B-3 CONNECTOR PINOUT DIAGRAMS

Figures B-1 through B-4 provide pinout diagrams for the rear panel connectors.

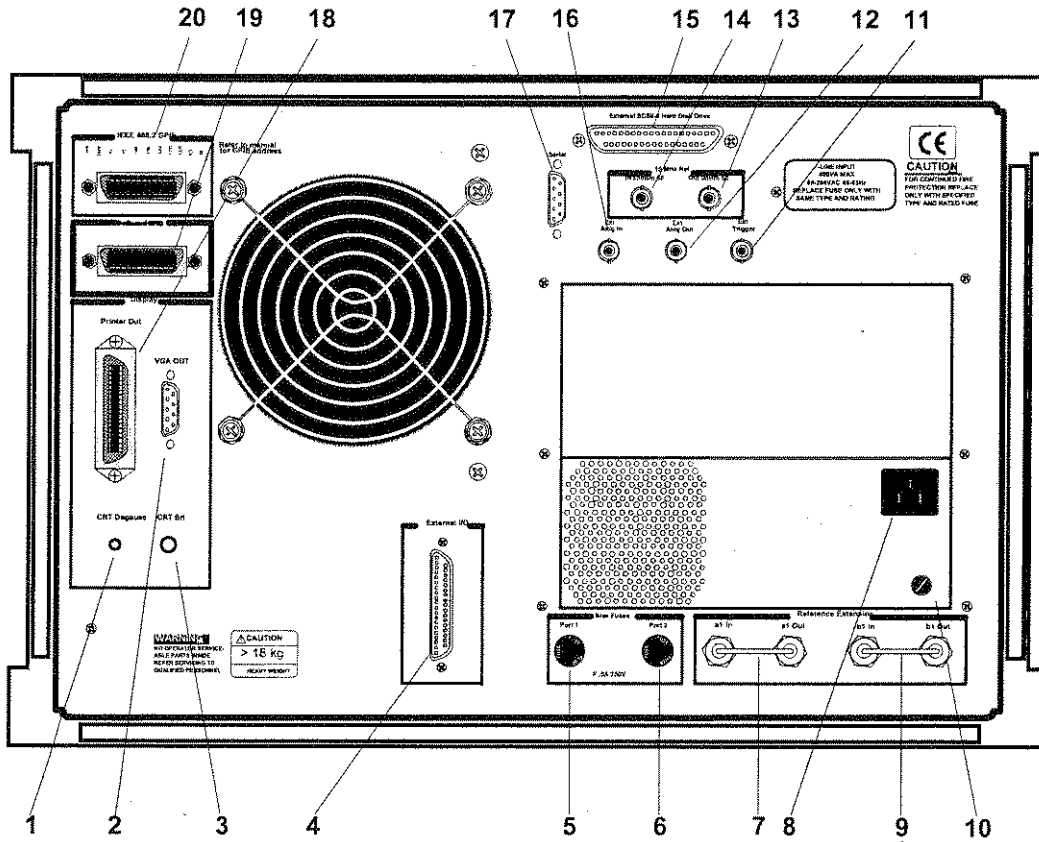

1. **CRT Degauss (CRT Only):** Momentary-on pushbutton that degausses the internal color monitor. It has no effect on an external monitor.
2. **VGA OUT:** 15-pin connector provides VGA output of 373XXA video display. Figure B-4 provides a pinout diagram.
3. **CRT Brt:** Adjustment for CRT/LCD brightness. For CRT, counterclockwise rotation increases brightness; for LCD, clockwise rotation increases brightness.
4. **External I/O:** Provide I/O access for Channel 1 through 4 limit and Port 1 and 2 bias voltages. Figure B-3 provides a pinout diagram.
5. **Bias Fuses, Port 1:** Fuse, 0.5A, 3AG, 250V, provides protection for external bias being applied to the active device connected to test port 1 without disturbing the accuracy of the 373XXA measurement.
6. **Bias Fuses, Port 2:** Fuse, 0.5A, 3AG, 250V, provides protection for external bias being applied to the active device connected to test port 2 without disturbing the accuracy of the 373XXA measurement.
7. **Reference Extension, a1 In to a1 Out:** Loop allows external reference to be used as a receiver. This provides for custom-defined user parameters with any combination of channels.
8. **Line Voltage Input:** Three-prong ac plug that provides input for the input-line power. The line voltage must be between 85 and 264 Vac rms, 43 to 63 Hz.
9. **Reference Extension, b1 In to b1 Out:** Loop allows attenuation to be added to prevent damage to the b1 sampler (when an amplifier is connected to the front panel loop).
10. **Line Fuse:** 3 AG fuse cartridge that protects for an input overcurrent condition. The fuse is slow blow, 8A, 250V.
11. **External Trigger:** Allows an external signal to sync the 373XXA measurements; $\approx 1V$ trigger.
12. **External Anlg Out:** Provides an up-to- $\approx 10V$ signal for use in driving an external plotter or antenna (CW draw).
13. **10 MHz Ref OUT 0dBm 50W:** BNC connector that allows the internal 10 MHz reference to be used to phase lock an external counter or other measuring instrument. Level is typically 0 dBm into 50 Ω impedance.

14. **10 MHz Ref IN 0dBm 50W:** BNC connector that allows an external 10 MHz signal (-5 to +5 dBm) to be used as the frequency reference for phase locking the source frequency. 50W impedance.
15. **External SCSI-2 Hard Disk Drive:** Provides for connecting an external SCSI-2 hard disk drive (Option 4).
16. **Ext Anlg In:** Provides input to the A5 A/D Converter PCB. BNC connector allows an external dc voltage to be measured by the internal analog-to-digital converter circuit. Intended for use in troubleshooting by a qualified service technician.
17. **Serial:** Provides control for AutoCal module. Figure B-5 provides a pinout diagram.
18. **Printer Out:** 36-pin connector that provides a parallel interface to the companion printer. Figure B-2 describes the signal lines and shows the connector pinout.
19. **Dedicated GPIB:** IEEE 488 standard 24-pin connector that allows the 373XXA to remotely control a 2nd frequency source, an external plotter, analyzer, or other peripheral. Figure B-1 provides a pinout diagram.
20. **IEEE 488.2 GPIB:** IEEE 488 standard 24-pin connector that provides for remotely controlling the 373XXA from an external computer/controller via the IEEE-488 bus (GPIB). Figure B-1 provides a pinout diagram.

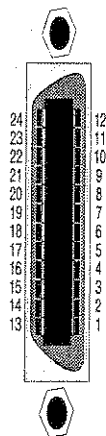

Pinout Diagram

PIN	NAME	DESCRIPTION
1-4	DIO 1 thru DIO 4	Data Input/Output. Bits are HIGH with the data is logical 0 and LOW when the data is logical 1.
5	EOI	End Or Identify. A low-true state indicates that the last byte of a multibyte message has been placed on the line.
6	DAV	Data Valid. A low-true state indicates that the talker has (1) sensed that NRFD is LOW, (2) placed a byte of data on the bus, and (3) waited an appropriate length of time for the data to settle.
7	NRFD	Not Ready For Data. A high-true state indicates that valid data has not yet been accepted by a listener.
8	NDAC	Not Data Accepted. A high-false state indicates that the current data byte has been accepted for internal processing by a listener.
9	IFC	Interface Clear. A low-true state places all bus instruments in a known state—such as, unaddressed to talk, unaddressed to listen, and service request idle.
10	SRQ	Service Request. A low-true state indicates that a bus instrument needs service from the controller.
11	ATN	Attention. A low-true state enables the controller to respond to both it's own listen/talk address and to appropriate interface messages — such as, device clear and serial poll.
12	Shield	Chassis ground.
13-16	DIO 5 thru DIO 8	Data Input/Output. Bits are high with the data is logical 0 and LOW when the data is logical 1.
17	REN	Remote Enable. A low-true state enables bus instruments to be operated remotely, when addressed.
18-		

Figure B-1. Pinout Diagram, GPIB and Dedicated GPIB Connectors

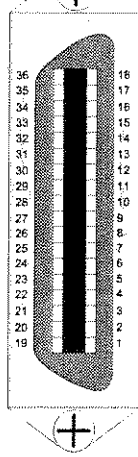

Pinout Diagram

PIN	NAME	DESCRIPTION
1	STROBE	Printer Strobe. A low-true pulse that tells the printer valid data has been placed on the bus.
2-9	DATA1 thru DATA8	Data Lines. Bits are HIGH when the data is logical 1 and LOW when the data is a logical 0.
10	ACK NLG	Printer Acknowledgement. A low-true (it varies from printer to printer) pulse sent back by the printer to acknowledge that the data has been accepted and the printer is ready to accept more data.
11	BUSY	Printer Busy. High-true level sent by the printer to indicate that it is not available. This line is HIGH at the following times: (1) During data entry. (2) While printing. (3) When off-line. (4) When a printer-error has been signaled.
12	PE	Printer Error. High-true level sent by the printer to indicate that it is out of paper.
13	SLCT	Select. A high-true logic level.
14	AUTO FEED XT	Automatic Paper Feed. A low-true level that tells the printer to feed the paper automatically.
15	NC	No Connection.
16	OV	Logic GND Level.
17	CHASSIS GND	Chassis ground, which is isolated from logic ground.
18	NC	No Connection.
19	STROBE RTN	Return line for STROBE signal.
20-27	DATA RTN	Return lines for DATA1 thru DATA8 lines.

Figure B-2. Pinout Diagram, Printer Connector (1 of 2)

PIN	NAME	DESCRIPTION
28	ACKNLG RTN	Return line for ACKNLG signal.
29	BUSY RTN	Return line for BUSY signal.
30	PE RTN	Return line for PE signal.
31	INIT	Printer Initial State. A low-true pulse that tells the printer to assume its initial state and clear its print buffer.
32	ERROR	Printer Error. A low-true signal that indicates the printer is (1) out of paper, (2) off-line, or (3) in an error state.
33	GND	Ground level.
34	NC	No Connection.
35	+5V	+5V dc level.
36	SLCT IN	Printer Select Input. A low-true level that permits the printer to accept data.

Figure B-2. Pinout Diagram, Printer Connector (2 of 2)

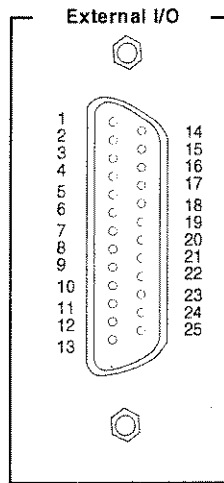

Pinout Diagram

PIN	NAME	DESCRIPTION
1	Channel 1 Limit	Signal indicating results of Channel 1 limit testing. User selectable TTL-high = Fail or TTL-low = Fail.
2	Limit 1 Rtn	Return for the Channel 1 limit signal
3	Channel 2 Limit	Signal indicating results of Channel 2 limit testing. User selectable TTL-high = Fail or TTL-low = Fail.
4	Limit 2 Rtn	Return for the Channel 1 limit signal
5	Channel 3 Limit	Signal indicating results of Channel 3 limit testing. User selectable TTL-high = Fail or TTL-low = Fail.
6	Limit 3 Rtn	Return for the Channel 3 limit signal
7	Channel 4Limit	Signal indicating results of Channel 4 limit testing. User selectable TTL-high = Fail or TTL-low = Fail. Pins 7 is also used as the TTL handshake for external trigger mode. TTL-high = VNA has completed a measurement and is ready for another trigger
8	Limit 4 Rtn	Return for the Channel 4 limit signal or VNA measurement complete signal. Pin 8 is also the return for pin 7.
9	Limit Fail	Signal indicating failure in any channel limit testing. User selectable TTL-high = Fail or TTL-low = Fail.
10	Spare	
11	Spare	
12	Limit Fail Rtn	Return for the Limit Fail signal
13	Spare	
14	Spare	
15	Ext Dig In	Allows an external signal to sync the 373XXA measurements; TTL level
16	Dig In Rtn	Return for External Dig In signal

Figure B-3. Pinout Diagram, External I/O Connector (1 of 2)

PIN	NAME	DESCRIPTION
17	Ext Ana Out	Provides an up-to-10V signal for use in driving an external plotter or antenna (CW draw).
18	Ana Out Rtn	Return for Ext Ana Out signal
19	Spare	
20	Spare	
21	Spare	
22	Gnd 1	Return for Port 1 Bias.
23	Port 1 Bias	Provides for applying an external bias to the active device connected to test port 1.
24	Port 2 Bias	Provides for applying an external bias to the active device connected to test port 2.
25	Gnd 2	Return for Port 2 Bias.

Figure B-3. Pinout Diagram, External I/O Connector (2 of 2)

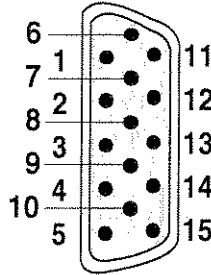

Pinout Diagram

PIN	NAME	DESCRIPTION
1	Red	Red signal
2	Green	Green signal
3	Blue	Blue signal
4	Not Used	
5	Not Used	
6	Red Return	Red return
7	Green Return	Green return
8	Blue Return	Blue return
9	Not Used	
10	Digital Ground	Sync ground
11	Not Used	
12	Not Used	
13	Hsync	Horizontal sync
14	Vsync	Vertical sync
15	Not Used	

Figure B-4. Pinout Diagram, VGA IN/OUT Connector

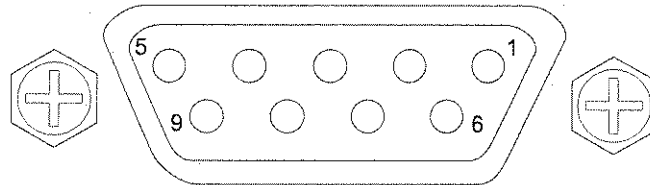

PIN	DESCRIPTION
1	CD
2	RXD
3	TXD
4	DTR
5	N.C.
6	N.C.
7	RTS
8	CTS
9	N.C.

Figure B-5. Pinout Diagram, Serial Port Connector

Appendix C

Performance Specifications

SYSTEM PERFORMANCE

Frequency Range:

RF Models:

37317A 22.5 MHz to 8.6 GHz

Microwave Models

37325A 40 MHz to 13.5 GHz

37347A 40 MHz to 20 GHz

37369A 40 MHz to 40 GHz

37397A 40 MHz to 65 GHz

Dynamic Range:

The following table gives dynamic range in two manners. "Receiver Dynamic Range" is defined as the ratio of the maximum signal level at Port 2 for 0.1 dB compression to the noise floor at Port 2.

"System Dynamic Range" is defined as the ratio of the power incident on Port 2 in a through line connection to the noise floor at Port 2 (forward measurements only).

In preparing the table, 10 Hz IF bandwidth and 512 averages were used in calibration and measurement.

High Level Noise (typical)

<0.04 dB and <0.5° peak-to-peak variation in a 1 kHz IF bandwidth up to 20 GHz. <0.08 dB and <1.0° peak-to-peak variation up to 40 GHz. <0.25 dB and <2.5° peak-to-

Model	Freq (GHz)	Max Signal Into Port 2 (dBm)	Noise Floor (dBm)	Receiver Dynamic Range	Port 1 Power (dBm)	System Dynamic Range
37317A	0.0225	+30	-95	125	0	95
	2	+30	-98	130	0	98
	8.6	+30	-98	130	0	98
37325A	0.04	+30	-65	100	+5	70
	2	+30	-93	128	+5	98
	13.5	+30	-93	128	+5	98
37347A	0.04	+30	-65	100	+5	70
	2	+30	-93	128	+5	98
	20	+30	-91	126	+5	96
37369A	0.04	+30	-65	100	+5	70
	2	+30	-93	128	+5	98
	20	+30	-90	125	0	90
	40	+30	-83	123	-7	76
37397A	0.04	+30	-77	107	+10	70
	2	+30	-105	135	+10	98
	20	+30	-97	127	-2	90
	40	+30	-95	125	-7	88
	65	+30	-87	117	-2	80

peak variation up to 65 GHz.

Measurement Throughput:

Measurement times are based on a single 40 MHz to 20 GHz sweep with 10 kHz IF bandwidth (no averages) after a full 12-term calibration. Sweep times include retrace and bandswitch times.

Measurement Time (ms) vs. Data Points (typical):

Calibration Type	Data Points				
	3	51	101	401	1601
1 Port (3 Term)	60	250	330	960	3300
Full 2 Port	60	270	400	1000	3600

Measurement Time vs. Sweep Mode for 101 Data Points (typical):

Sweep Mode	Time (ms)
Linear	350
List	350
CW	230

Measurement Time vs. IF Bandwidth for 101 Data Points (typical):

IF Bandwidth	Time (ms)
10 kHz	350
1 kHz	530
100 Hz	1900
10 Hz	14000

Measurement Time vs. Span for 101 Data Points (typical):

Frequency Span	Time (ms)
40 MHz to 40 GHz	500
20 GHz to 40 GHz	400
10 GHz to 11 GHz	250

TEST PORT CHARACTERISTICS

The specifications in the following table apply when the proper Model 34U Universal Test Port Adapters are connected, with or without phase equal insertables, to the test set ports and calibrated with the appropriate Anritsu or other designated calibration kit at 23°C ±3°C using the OSL calibration method with a sliding load to achieve 12-Term error correction (A 90 minute warm-up time is recommended.)

Connector	Frequency (GHz)	Directivity (dB)	Source Match (dB)	Load Match (dB)	Reflection Frequency Tracking (dB)	Transmission Frequency Tracking (dB)	Isolation (dB)
GPC-7	0.0225	>52	>44	>52	±0.003	±0.004	>105
	2.0	>52	>44	>52	±0.003	±0.004	>115
	18	>45	>38	>52	±0.004	±0.012	>112
GPC-7 LRL Calibration	2.0	>60	>60	>60	±0.001	±0.001	>115
	18	>60	>60	>60	±0.001	±0.001	>112
N-Type	0.0225	>46	>36	>46	±0.004	±0.004	>105
	2.0	>44	>36	>44	±0.004	±0.004	>115
	18	>40	>32	>40	±0.005	±0.012	>112
3.5 mm	0.0225	>44	>40	>44	±0.005	±0.030	>105
	2.0	>44	>40	>44	±0.005	±0.030	>115
	20	>44	>38	>44	±0.006	±0.050	>110
	26.5	>44	>34	>44	±0.006	±0.070	>102
K	0.0225	>42	>40	>42	±0.005	±0.030	>105
	2.0	>42	>40	>42	±0.005	±0.050	>115
	20	>42	>38	>42	±0.006	±0.070	>110
	40	>38	>34	>38	±0.006	±0.080	>100
V	0.04	>70	>36	>40	±0.050	±0.030	>105
	2.0	>40	>36	>40	±0.050	±0.050	>115
	20	>40	>36	>40	±0.060	±0.070	>110
	40	>36	>32	>36	±0.060	±0.080	>100
	50	>34	>30	>34	±0.080	±0.100	>90
	65	>34	>28	>34	±0.100	±0.120	>80

MEASUREMENT CAPABILITIES

Number of Channels: Four independent measurement channels.

Parameters: S11, S21, S22, S12, or user-defined combinations of a1, a2, b1, and b2. All measurements are made without the need to manually reverse the test device.

Measurement Frequency Range: Frequency range of measurement can be narrowed within the calibration range without recalibration. CW mode permits single frequency measurements, also without recalibration. In addition, the system accepts N discrete frequency points where $2 \leq N \leq 1601$.

Domains: Frequency Domain, CW Draw, and optional High Speed Time (Distance) Domain.

Formats: Log Magnitude, Phase, Log Magnitude and Phase, Smith Chart (impedance), Smith Chart (Admittance), Linear Polar, Log Polar, Group Delay, Linear Magnitude, Linear Magnitude and Phase, Real, Imaginary, Real and Imaginary, SWR, Power.

Data Points: 1601 maximum. Data points can be switched to a value of 801, 401, 201, 101, or 51 points without recalibration (if 1601 points were used in the calibration). In addition, the system accepts an arbitrary set of N discrete data points where: $2 \leq N \leq 1601$. CW mode permits selection of a single data point without recalibration.

Reference Delay: Can be entered in time or in distance (when the dielectric constant is entered). Automatic reference delay feature adds the correct electrical length compensation at the push of a button. Software compensation for the electrical length difference between reference and test is always accurate and stable since measurement frequencies are always synthesized. In addition, the system compensates reference phase delay for dispersive transmission media, such as waveguide and microstrip.

Markers: Six independent markers can be used to read out measurement data. In delta-reference marker mode, any one marker can be selected as the reference for the other five. Markers can be directed automatically to the minimum or maximum of a data trace.

Enhanced Markers: Marker search for a level or bandwidth, displaying an active marker for each channel, and discrete or continuous (interpolated) markers.

Marker Sweep: Sweeps upward in frequency between any two markers. Recalibration is not required during the marker sweep.

Limit Lines: Either single or segmented limit lines can be displayed. Two limit lines are available for each trace.

Single Limit Readouts: Interpolation algorithm determines the exact intersection frequencies of test data and limit lines.

Segmented Limit Lines: A total of 20 segments (10 upper and 10 lower) can be generated per data trace. Complete

segmented traces can be offset in both frequency and amplitude.

Test Limits: Both single and segmented limits can be used for PASS/FAIL testing. The active channel's PASS or FAIL status is indicated on CRT after each sweep. In addition, PASS/FAIL status is output through the rear panel I/O connector as selectable TTL levels (PASS=0V, FAIL=+5V, or PASS=+5V, FAIL=0V).

Tune Mode: Tune Mode optimizes sweep speed in tuning applications by updating forward S-parameters more frequently than reverse ones. This mode allows the user to select the ratio of forward sweeps to reverse sweeps after a full 12-term calibration. The ratio of forward sweeps to reverse sweeps can be set anywhere between 1:1 to 10,000:1.

DISPLAY CAPABILITIES

Display Channels: Four, each of which can display any S-parameter or user defined parameter in any format with up to two traces per channel for a maximum of eight traces simultaneously. A single channel, two channels (1 and 3, or 2 and 4), or all four channels can be displayed simultaneously. Channels 1 and 3, or channels 2 and 4 can be overlaid.

LCD: Color, 8.5-inch diagonal.

Trace Color: The color of display traces, memory, text, markers and limit lines are all user definable.

Trace Overlay: Displays two data traces on the active channel's graticule simultaneously. The overlaid trace is displayed in yellow and the primary trace is displayed in red.

Trace Memory: A separate memory for each channel can be used to store measurement data for later display or subtraction, addition, multiplication or division with current measurement data.

Scale Resolution (minimum):

Log Magnitude: 0.001 dB/div

Linear Magnitude: 1 pU

Phase: 0.01°

Group Delay: 0.001 ps

Time: 0.001 ms

Distance: 0.1 μm

SWR: 1 pU

Power: 0.05 dB

Autoscale: Automatically sets Resolution and Offset to fully display measurement data.

Reference Position: Can be set at any graticule line.

Annotation: Type of measurement, vertical and horizontal scale resolution, start/stop or center/span frequencies, and reference position.

Blank Frequency Information: Blanking function removes all references to displayed frequencies on the CRT. Frequency blanking can only be restored through a system reset or GPIB command.

MEASUREMENT ENHANCEMENT

Data Averaging: Averaging of 1 to 4096 averages can be selected. Averaging can be toggled on/off with front panel

button. A front panel button turns data averaging on/off, and a front panel LED indicates when averaging is active.

Video IF Bandwidth: Front panel button selects four levels of video IF bandwidth. MAXIMUM (10 kHz), NORMAL (1 kHz), REDUCED (100 Hz) and MINIMUM (10 Hz).

Trace Smoothing: Functions similarly to Data Averaging but computes an average over a percentage range of the data trace. The percentage of trace to be smoothed can be selected from 0 to 20% of trace. Front panel button turns smoothing on/off, and front panel LED indicates when smoothing is active.

SOURCE CONTROL

Frequency Resolution: 1 kHz (1 Hz standard on RF units and optional on Microwave units - Option 10A)

Source Power Level: The source power (dBm) may be set from the 373XXA front panel menu or via GPIB. Refer to Level Control Range table on next page.

In addition, the port 1 power may be attenuated in 10 dB steps, using the internal 70 dB step attenuator. Similarly, high input signals into port 2, not exceeding 1 watt, can be attenuated up to 40 dB, using the internal port 2 step attenuator.

Power Accuracy: ±0.5 dB at 2 GHz at default power.

Power Meter Correction: The 373XXA offers a user-selectable feature that corrects for test port power variations and slope (on Port 1) using an external Hewlett-Packard 437B or Anritsu ML8403 power meter. Power meter correction is available at a user-selectable power level, if it is within the power adjustment range of the internal source. Once the test port power has been flattened, its level may be changed within the remaining power adjustment range of the signal source.

Set-On Receiver Mode: The 373XXA can be configured to measure the relative harmonic level of test devices with Set-On Receiver Mode capability. The 373XXA's unique phase locking scheme allows it to operate as a tuned receiver by locking all of its local oscillators to its internal crystal reference oscillator. Set-On Receiver Mode capability significantly increases the versatility of the 373XXA VNA in applications that check for harmonics, intermodulation products, and signals of known frequency.

Dual Source Control Capability: Dual Source Control capability allows a user to independently control the frequencies of two sources and the receiver without the need for an external controller. The frequency ranges and output powers of the two sources may be specified. A frequency sweep may be comprised of up to five separate bands, each with independent source and receiver settings, for convenient testing of frequency translation devices such as mixers. Up to five sub-bands may be tested in one sweep. This feature enables users to easily

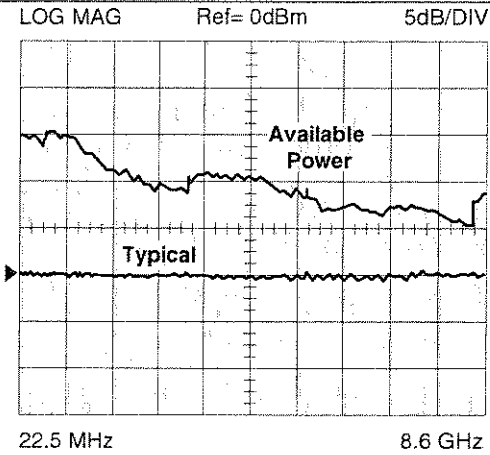

Model 37317A Port 1 Power

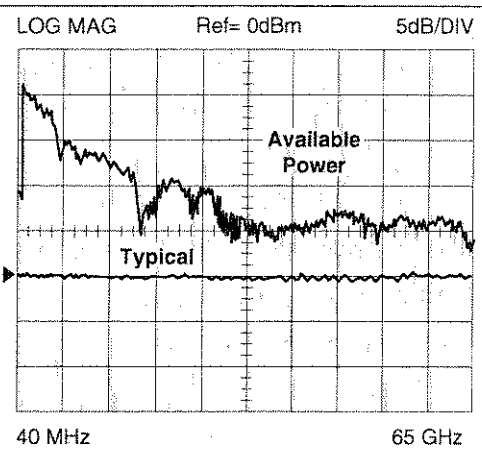

Model 37397A Port 1 Power

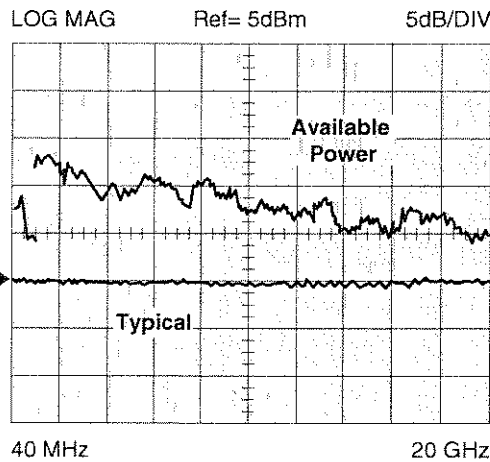

Model 37325A and 37347A Port 1 Power

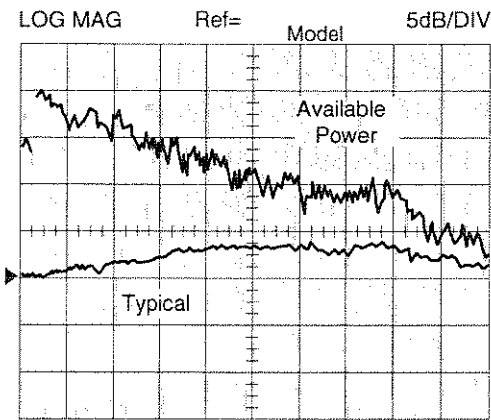

Model 37369A Port 1 Power

test mixers, up/down converters, multipliers, and other frequency conversion devices.

Source 1: The 373XXA internal source or any of the family of 68XXXB, 69XXXA, or 6700B synthesizers..

Source #2: Any of ANRITSU's family of 68XXXB, 69XXXA, or 6700B synthesizers.

Sweep Type: Linear, CW, Marker, or N-Discrete point sweep.

POWER RANGE

Model	Rated Power (dbm)	Minimum Power (dBm)	Resolution (dB)
37317A	0	-90	0.05
37325A	+5	-85	0.05
37347A	+5	-85	0.05
37369A	-7	-95	0.05
37397A	-7	-79	0.05

LEVEL CONTROL RANGE
(Without step attenuator)

	37317A	37325A	37347A	37369A	37397A
Above Reset Power*	+10 dB	+10 dB	+10 dB	+20 dB	+20 dB
Below Reset Power	-25 dB	-25 dB	-25 dB	-20 dB	-20 dB <47 GHz -12 dB ≥47 GHz

*Source power above the reset level is allowed but not guaranteed, especially over the full frequency range.

POWER FLATNESS

Frequency Range (GHz)	Flatness (dB)
0.0225 to 13.5	±1.5
13.5 to 20	±2.0
20 to 40	±3.0
40 to 65	±5.0

SOURCE PURITY

(Specifications apply for all models at maximum rated power.)

Harmonics & Harmonic Related:

15 dBc (37325A, 37347A, 37369A, 37397A)

35 dBc (37317A)

Nonharmonics: 35 dBc (standard)

Phase Noise: >60 dBc/Hz at 10 kHz offset and 20 GHz center frequency

SOURCE FREQUENCY ACCURACY

Standard Time Base:

Aging: <1 x 10⁻⁶/year

Stability: <1 x 10⁻⁶ over +15°C to +50°C range

High Stability Time Base (Option 10):

Aging: <1 x 10⁻⁹/day

Stability: <5 x 10⁻⁹ over 0°C to +55°C range

GROUP DELAY CHARACTERISTICS

Group Delay is measured by computing the phase change in degrees across a frequency step by applying the formula:

$$\tau_g = -1/ \frac{1}{360} \frac{d\Phi}{df}$$

Aperture: Defined as the frequency span over which the phase change is computed at a given frequency point. The aperture can be changed without recalibration. The minimum aperture is the frequency range divided by the number of points in calibration and can be increased to 20% of the frequency range without recalibration. The frequency width of the aperture and the percent of the frequency range are displayed automatically.

Range: The maximum delay range is limited to measuring no more than +180° of phase change within the aperture set by the number of frequency points. A frequency step size of 100 kHz corresponds to 10 ms.

Measurement Repeatability (sweep to sweep): For continuous measurement of a through connection, RSS fluctuations due to phase and FM noise are:

$$\frac{141 [(\text{Phase Noise in deg})^2 + (\tau_g \times \text{Residual FM Noise in Hz})^2]^{0.5}}{360 (\text{Aperture in Hz})}$$

Accuracy:

$$\text{Error in } \tau_g = \frac{\sqrt{\text{Error in Phase (deg)}^2}}{360} + \{ \tau_g \times \text{Aperture Freq. Error (Hz)} \}$$

Aperture (Hz)

VECTOR ERROR CORRECTION

There are five methods of calibration:

1) **Open-Short-Load (OSL).** This calibration method uses short circuits, open circuits, and terminations (fixed or sliding)

2) **Offset-Short (waveguide):** This calibration method uses short circuits and terminations.

3) **LRL/LRM:** The Line-Reflect-Line (LRL) or Line-Reflect-Match (LRM) calibration uses transmission lines and a reflective device or termination (LRM).

4) **TRM:** The Thru-Reflect-Match calibration uses short circuits and fixed termination.

5) **AutoCal:** The VNA will serially drive an external AutoCal module to perform a 2-port OSLT calibration. AutoCal is a single two port calibration module with built-in, switched, and characterized OSLT standards. AutoCal provides quick, reliable, and accurate calibrations that exceed the performance of a standard broadband load OSLT calibration.

There are four vector error correction models available:

1) **Full 12-Term**

2) **One Path/Two Port**

3) **Frequency Response (Transmission/Reflection)**

4) **Reflection Only**

Full 12-term can always be used, if desired, since all 373XXA-series models automatically reverse the test signal. Front-panel display indicates the type of calibration stored in memory. Front-panel button selects whether calibration is to be applied, and an LED lights when error correction is being applied.

Calibration Sequence: Prompts the user to connect the appropriate calibration standard to Port 1 and/or Port 2. Calibration standards may be measured simultaneously or one at a time.

Calibration Standards: For coaxial calibrations the user selects SMA, GPC-3.5, GPC-7, Type N, 2.4 mm, TNC, K, or V Connector from a calibration menu. Use of fixed or sliding loads can be selected for each connector type. User defined calibration standards allow for entry of open capacitance, load and short inductances, load impedance, and reflection standard offset lengths.

Reference Impedance: Modify the reference impedance of the measurement to other than 50 ohms (but not 0).

LRL/LRM Calibration Capability: The LRL calibration technique uses the characteristic impedance of a length of transmission line as the calibration standard. A full LRL calibration consists merely of two transmission line measurements, a high reflection measurement, and an isolation measurement. The LRM calibration technique is a variation of the LRL technique that utilizes a precision termination rather than a second length of transmission line. A third optional standard, either Line or Match, may be measured in order to extend the frequency range of the calibration. This extended calibration is achieved by mathematically concatenating either two LRL, two LRM, or one LRL and one LRM calibration(s). Using these

techniques, full 12-term error correction can be performed on the 373XXA VNA.

Adapter Removal Calibration: Built-in Adapter Removal application software accurately characterizes and "removes" any adapter used during calibration what will not be used for subsequent device measurements. This technique allows for accurate measurement of non-insertable devices.

Dispersion Compensation: Selectable as Coaxial (non-dispersive), Waveguide, or Microstrip (dispersive).

Reference Plane: Selectable as Middle of line 1 or Ends of line 1.

Corrected Impedance: Determined by Calibration Standards.

HARD COPY

Printer: Menu selects full screen, graphical, tabular data, S2P or Text output, and printer type. The number of data points of tabular data can be selected as well as data at markers only. Compatible with the 2225C InkJet, HP QuietJet, HP 310/320/340 DeskJet, HP 500 Deskjet, HP 560C DeskJet (b/w only), HP LaserJet II, III, & IV Series, and some Epson compatible printers with Parallel (Centronics) interfaces.

GPIB Plotters: The 37XXX VNA is compatible with HP Models 7440A, 7470A, 7475A, and 7550A (in standard mode) and Tektronix Model HC100 plotters. Menu selects plotting of full or user-selected portions of graphical data. Plotter is connected to the dedicated GPIB bus.

Performance: After selecting the Start Print button, front panel operation and measurement capability is restored to the user within 2 seconds.

STORAGE

Internal Memory: Ten front panel states (setup/calibration) can be stored and recalled from non-volatile memory locations. The current front panel setup is automatically stored in non-volatile memory at instrument power-down. When power is applied, the instrument returns to its last front panel setup.

Internal Hard Disk Drive: Used to store and recall measurement and calibration data and front-panel setups. All files are MS-DOS compatible. File names can be 1 to 8 characters long, and must begin with a character, not a number. Extensions are automatically assigned.

External SCSI Interface: Option 4 deletes the internal hard disk drive, and adds a SCSI Interface connector to the rear panel for connecting a SCSI-2 formatted hard disk drive.

Internal Floppy Disk Drive: A 3.5-inch diskette drive with 1.44 Mbytes formatted capacity is used to load measurement programs and to store and recall measurement and calibration data and front panel setups. All files are

MS-DOS compatible. File names can be 1 to 8 characters long, and must begin with a character, not a number. Extensions are automatically assigned.

Measurement Data: 102.8 kbytes per 1601 point S-parameter data file.

Calibration Data: 187.3 kbytes per 1601 point S-parameter data file (12-term cal plus setup).

Trace Memory File: 12.8 kbytes per 1601 point channel.

GPIB

GPIB INTERFACES - 2 PORTS

System GPIB (IEEE-488.2): Connects to an external controller for use in remote programming of the network analyzer. Address can be set from the front panel and can range from 1 to 30.

Interface Function Codes: SH1, AH1, T6, TE0, L4, LE0, SR1, RL1, PP1, DT1, DC0, C0.

Dedicated GPIB: Connects to external peripherals for network analyzer controlled operations (e.g. GPIB plotters, frequency counters, frequency synthesizers, and power meters).

GPIB Data Transfer Formats: ASCII, 32-bit floating point, or 64-bit floating point. 32-bit and 64-bit floating point data can be transferred with LSB or MSB first.

GPIB DATA COLLECTION SUMMARY

This section summarizes typical data collection times for automated measurements using the 37XXX IEEE 488.2 GPIB bus. Throughput measurements for both tables were made as follows: start the timer, trigger a sweep, wait for a full sweep, transfer data across the GPIB and stop the timer. Data throughput times are shown separately for measurements made without calibration and with full two-port, 12-term calibration.

Data Transfer Speed (with or without cal): 150 kbytes/second

Measurement conditions: 40 MHz to 20 GHz sweep, single channel, log magnitude display, 10 kHz IF bandwidth, and output final data.

Throughput Times (ms) without Correction (typical)

Data Format	3 Points*	101 Points	401 Points	1601 Points
32 Bit	230	650	1400	3600
64 Bit	230	680	1450	4000
ASCII	235	800	1700	5000

Throughput Times (ms) with Correction (typical)

Data Format	3 Points*	101 Points	401 Points	1601 Points
32 Bit	340	1200	2600	7800
64 Bit	350	1200	2700	8300
ASCII	350	1280	3000	9300

* Frequencies taken at 2, 4, and 6 GHz

GENERAL

37300A Front Panel Connectors and Controls:

Keyboard Input: An IBM-AT compatible keyboard can be connected to the front panel for navigating through front panel menus and disk directories, annotation of data files and display labels, printing displays and pausing instrument sweeps.

Test Ports: Universal/K, male, connectors are standard on all models except for 37397A, which has V Connector test ports as standard. For other configurations check Option 7. For additional configurations check Test Port Converters.

Bias Inputs: Port 1 and 2: 0.5 amps maximum through BNC connectors.

Port 1 Amplifier Loop: Access to insert an external amplifier, ahead of the port 1 coupler or bridge, to increase port 1 power output, up to +30 dBm (1 watt) maximum.

37300A Rear Panel Connectors and Controls:

PRINTER OUT: Centronics interface for an external printer.

VGA OUT: Provides VGA output of 373XXA video display.

10 MHz REF IN: Connects to external reference frequency standard, 10 MHz, +5 to -5 dBm, 50 ohms, BNC female.

10 MHz REF OUT: Connects to internal reference frequency standard, 10 MHz, 0 dBm, 50 ohms, BNC female.

EXT ANALOG OUT: -10V to +10V with 5 mV resolution, varying in proportion to user-selected data (e.g., frequency, amplitude). BNC female.

EXT ANALOG IN: ±50 volt input for displaying external signals on the CRT in Diagnostics mode. BNC female.

LINE SELECTION: Power supply automatically senses 100V, 120V, 220V or 240V lines.

EXTERNAL TRIGGER: External triggering for 373XXA measurement, ±1V trigger. 10 kohm input impedance. BNC female.

REFERENCE EXTENSION: Provides access to a1 and b1 samplers; K or V Connector, female.

EXTERNAL SCSI: Provides SCSI-2 connector for connection of an external SCSI hard disk drive (Opt. 4).

EXTERNAL I/O: 25-pin DSUB connector.

EXTERNAL SCSI: Provides SCSI-2 connector for connection of an external SCSI hard disk drive (Opt. 4).

SERIAL: Provides control for AutoCal module.

LIMITS PASS/FAIL: Selectable TTL levels (Pass=0V, Fail=+5V or Pass=+5V, Fail=0V. Additionally, 0 volts (all displayed channels pass) or +5V (any one of 4 displayed channels fail) output pass/fail status (1 line).

EXTERNAL TRIGGER: External triggering for 373XXA measurement, ±1V trigger. 10 kohm input impedance. BNC female.

EXT ANALOG OUT: -10V to +10V with 5 mV resolution, varying in proportion to user-selected data (e.g., frequency, amplitude). BNC female.

Power Requirements: 85-240V, 48-63 Hz, 540 VA maximum

Dimensions: 267H x 432W x 585D mm (10.5H x 17W x 23D in.)

Weight: 34 kg (75 lb) - Maximum amount specified for 2-man lift requirement.

ENVIRONMENTAL

Storage Temperature Range: -40°C to +75°C

Operating Temperature Range: -0°C to +50°C

Relative Humidity: 5% to 95% at +40°C

EMI: Meets the emissions and immunity requirements of EN55011/1991 Class A/CISPR-11 Class A EN 50082-1/1993

IEC 801-2/1984 (4 kV CD, 8kV AD)

IEC 1000-4-3/1995 (3 V/m, 80-1000 MHz)

IEC 801-4/1988 (500V SL, 1000V PL)

IEC 1000-4-5/1995 (2 kV L-E, 1kV L-L)

GAIN COMPRESSION MEASUREMENT CAPABILITY

The 373XXA simplifies amplifier Gain Compression and AM/PM measurements. Once an appropriate power and frequency schedule is selected, a power meter calibration, at a set level, will calibrate the linear VNA receiver channels, to accurately measure power in dBm. The 37300A supports the HP437B, and Giga-tronics 8540B series power meters. To measure power, b2/1, a user defined parameter, is automatically selected.

Swept Power Gain Compression: The 373XXA will display traditional Power out vs. Power in or Phase vs. Power in, at one of up to 10 selectable frequencies. A separate screen will easily show Power out and Power in at 1 dB, or selected level Gain Compression, for all entered frequencies. (Check figure below).

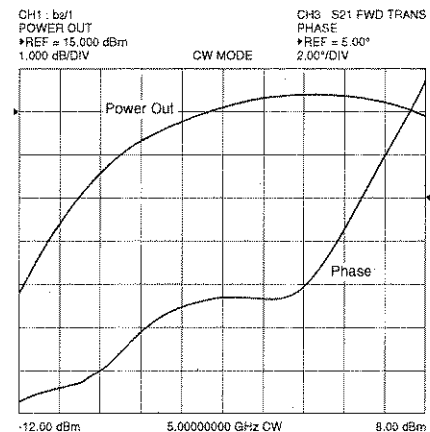

Shows Power Out and Phase performance as a function of Input Power at a CW frequency.

Swept Frequency Gain Compression: Once Gain is measured at the starting power, the user increments Power in, observing Normalized Gain vs. Frequency. This aids in analyzing the most critical compression frequencies of a broadband amplifier.

**HIGH SPEED TIME (DISTANCE) DOMAIN
MEASUREMENT CAPABILITY (OPTION 2)**

Option 2, High Speed Time (Distance) Domain software allows the conversion of reflection or transmission measurements from the frequency domain to the time domain. Measured S-parameter data is converted to the time domain by application of a Fast Fourier Transform (FFT) using the Chirp Z-Transform technique. Prior to conversion any one of several selectable windowing functions may be applied. Once the data is converted to the time domain, a gating function may be applied to select the data of interest. The processed data may then be displayed in the time domain with display start and stop times selected by the user or in the distance domain with display start and stop distance selected by the user. The data may also be converted back to the frequency domain with a time gate to view the frequency response of the gated data.

Lowpass Mode: This mode displays a response equivalent to the classic TDR (Time Domain Reflectometer) response of the device under test. Lowpass response may be displayed in either the impulse or step mode. This type of processing requires a sweep over a harmonic series of frequencies and an extrapolated or user-entered DC value.

Bandpass Mode: This mode displays a response equivalent to the time response of the device under test to a band limited impulse. This type of processing may be used with any arbitrary frequency sweep range, limited only by the test set range or device under test response.

Phasor Impulse Mode: This mode displays a response similar to the Lowpass impulse response, using data taken over an arbitrary (band limited) sweep range. Detailed information, similar to that contained in the lowpass impulse response may be used to identify the nature of impedance discontinuities in the device under test. Now, with Phasor Impulse, it is possible to characterize complex impedances on band-limited devices.

Windowing: Any one of four window functions may be applied to the initial frequency data, to counteract the effects of processing data with a finite bandwidth. These windows provide a range of tradeoffs of main lobe width versus sidelobe level (ringing).

The general type of function used is the Blackman-Harris window with the number of terms being varied from one to four. Typical performance follows:

Types of Window (Number of Terms)	First Side Lobe Relative to Peak	Impulse Width ¹
Rectangular (1)	-13 dB	1.2W
Nominal-Hamming (2)	-43 dB	1.8W
Low Side Lobe, Blackman-Harris (3)	-67 dB	2.1W
Minimum Side Lobe, Blackman-Harris (4)	-92 dB	2.7W

¹ W(Bin Width) = 1/2Δf sweep width
Example: When Δf = 40 MHz to 40 GHz, W = 12.5 ps
When Δf = 40 MHz to 65 GHz, W = 7.7 ps

Gating: A selective gating function may be applied to the time domain data to remove unwanted responses, either in a pass-band or reject-band (mask). This gating function may be chosen as the convolution of any of the above window types with a rectangular gate of user defined position and width. The gate may be specified by entering start and stop times or center and span. The gated data may be displayed in the time domain, or converted back to the frequency domain.

Time Domain Display: Data processed to time domain may be displayed as a function of time or as a function of distance, provided the dielectric constant of the transmission media is entered correctly. In the case of dispersive media such as waveguide or microstrip, the true distance to a discontinuity is displayed in the distance mode. The time display may be set to any arbitrary range by specifying either the start and stop times or the center time and span. The unaliated (non-repeating) time range is given by the formula:
$$\text{UnaliatedRange (ns)} = \frac{\text{Number of Frequency Data Points}}{\text{Frequency Sweep Range (GHz)}}$$

The resolution is given by the formula:

$$\text{Main Lobe Width (null \setminus null) in ns} = \frac{kW}{\text{Freq Sweep Range (GHz)}}$$

Where kW is two times the number of window terms (for example, four for a two-term window)

For a 40 GHz sweep range with 1601 data points, the unaliated range is 40.025 nanoseconds.

For a 65 GHz sweep with 1601 data points, the unaliated range is 24.646 nanoseconds.

Frequency with Time Gate: Data that has been converted to time domain and selected by the application of gating function may be converted back to the frequency domain.

This allows the display of the frequency response of a single element contained in the device under test. Frequency response accuracy is a function of window and gate type, and gate width. For a full reflection, minimum gate and window accuracy is within 0.2 dB of the ungated response over a 40 GHz range.

MEASUREMENT UNCERTAINTY

The graphs on pages C-10 through C-12 give measurement accuracy after 12-term vector error correction. The errors are worst case contributions of residual directivity, load and source match, frequency response, isolation, network analyzer dynamic accuracy, and connector repeatability. In preparing the following graphs, 10 Hz IF bandwidth and averaging of 512 points were used (measured at 23±3° C). Changes in the IF bandwidth or averaging can result in variations at low levels.

SYSTEM OPTIONS

OPTION 1, Rack Mounting: Rack mount kit containing a set of track slides (90 tilt capability), mounting ears, and front panel handles to let the instrument be mounted in a standard 19-inch equipment rack.

OPTION 1A, Rack Mounting: Rack mounting kit containing a set of mounting ears and hardware to permanently mount instrument in a standard 19-inch equipment rack.

OPTION 2, High Speed Time (Distance) Domain Measurement Capability

OPTION 4, External SCSI-2 Hard Disk Drive Compatibility: Provides SCSI-2 rear panel connector for connection of an external SCSI HDD. Remove internal HDD.

OPTION 7A/N/NF/S/K, Universal Test Port Configuration Replaces Universal/K Connector (standard) with:

- 7A - Universal/GPC-7
- 7N - Universal/N, male
- 7NF - Universal/N, female
- 7S - Universal/3.5 mm, male

OPTION 10A, High Stability Time Base: Replaces the standard temperature compensated crystal oscillator (with a temperature stability of 1ppm over a 0 to 55 °C range) with an ovenized crystal oscillator (aging stability of 1 x 10⁻⁹/day and temperature stability 5 x 10⁻⁹ over 0 to 55 °C range). Adds 1 Hz frequency resolution.

UPGRADE OPTIONS*

- 37200A** Upgrade to a higher frequency 37200A.
- 37200A** Upgrade to an equivalent or higher frequency 37300A.
- 37200B** Upgrade to a higher frequency 37200B.
- 37200B** Upgrade to an equivalent or higher frequency 37300A.
- 37300A** Upgrade to a higher frequency 37300A.

Please call your Anritsu representatives for pricing and delivery.

ON-SITE SUPPORT

- Option ES 31:** 3 year on-site repair.
- Option ES 37:** 3 year on-site verification
- Option ES 38:** 3 year on-site Mil-Std verification
- Option ES 51:** 5 year on-site repair.

Extended Service Options Additional, two year and four year return to Anritsu service is available, as an option for 373XXA systems and components. Prices and details are available from your Sales Representative or by contacting the factory.

CALIBRATION KITS

Standard

- 3650 SMA/3.5 mm Calibration Kit**
Option 1: Male and Female Sliding Terminations
- 3651 GPC-7 Calibration Kit**
Option 1: Sliding Terminations
- 3652 K Connector Calibration Kit**
Option 1: Male and Female Sliding Terminations
- 3653 Type N Calibration Kit**
- 3654B Type V Calibration Kit;** includes male & female sliding terminations
- Economy (8.6 GHz)**
- 3750 SMA Calibration Kit**
- 3751 GPC-7 Calibration Kit**
- 3753 Type N, 50 W, Calibration Kit**
- 3753-75 Type N, 75 , Calibration Kit**

VERIFICATION KITS

- 3663 Type N Verifications Kit**
- 3666 3.5 mm Verifications Kit**
- 3667 GPC-7 Verifications Kit**
- 3668 K Connector Verifications Kit**
- 3669B V Connector Verifications Kit**

SEMI-RIGID TEST PORT CABLES

- 3670A50-1,** DC to 18 GHz, GPC-7 connectors, 1 foot long, two required.
- 3670A50-2,** DC to 18 GHz, GPC-7 connectors, 2 feet long.
- 3670K50-1,** DC to 40 GHz, K connectors, 1 foot long, male/female, two required.
- 3670K50-2,** DC to 40 GHz, K connectors, 2 feet long, male/female.
- 3670V50-1,** DC to 65 GHz, V connectors, 1 foot long, male/female, two required.
- 3670V50-2,** DC to 65 GHz, V connectors, 2 feet long, male/female.

FLEXIBLE TEST PORT CABLES

- 3671A50-1 GPC-7 Flexible Cables,** 25 in. (1 pair).
- 3671A50-2 GPC-7 Flexible Cable,** 38 in.
- 3671S50-1 3.5mm Flexible Cables,** 25 in. (1 pair), male/male.
- 3671S50-2 3.5mm Flexible Cable,** 38 in., male.
- 3671K50-1 K Connector Flexible Cables,** 25 in. (1 pair), male/male.
- 3671K50-2 K Connector Flexible Cable,** 38 in., male.

Model 37347A (K Connectors)
Reflection Measurements:

Reflection Magnitude Uncertainty
37x47A/B/3652/Reflection Only

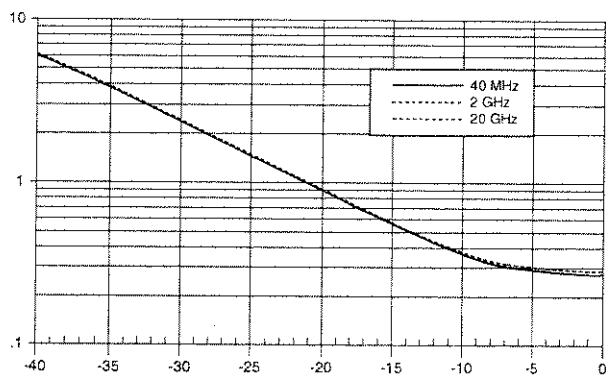

Reflection Phase Uncertainty
37x47A/B/3652/Reflection Only

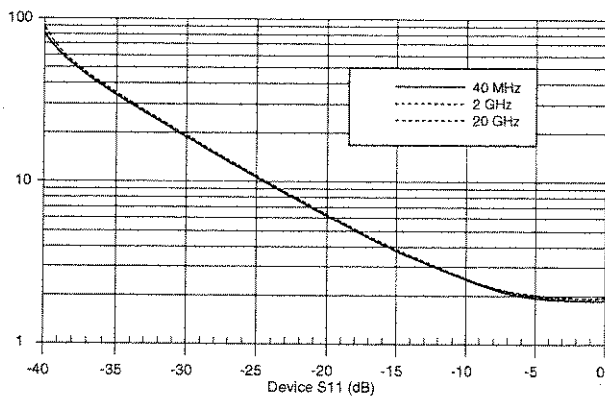

Model 37347A (K Connectors)
Transmission Measurements:

TRANSMISSION MAGNITUDE UNCERTAINTY
37X47A/B/3652/T TRANSMISSION ONLY

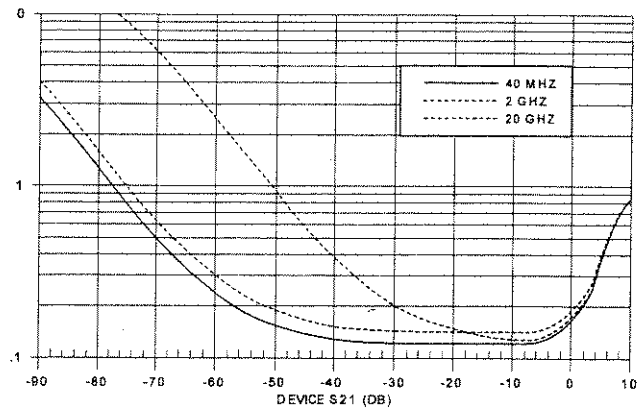

TRANSMISSION P HASE UNCERTAINTY
37X47A/B/3652/T TRANSMISSION ONLY

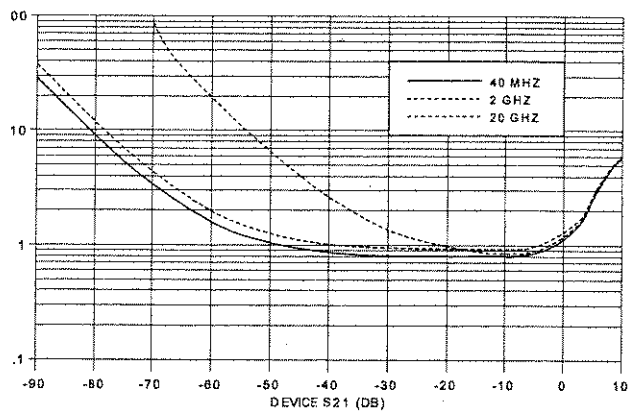

Model 37369A (K Connectors)
Reflection Measurements:

REFLECTION MAGNITUDE UNCERTAINTY
37X69A/B/3652/REFLECTION ONLY

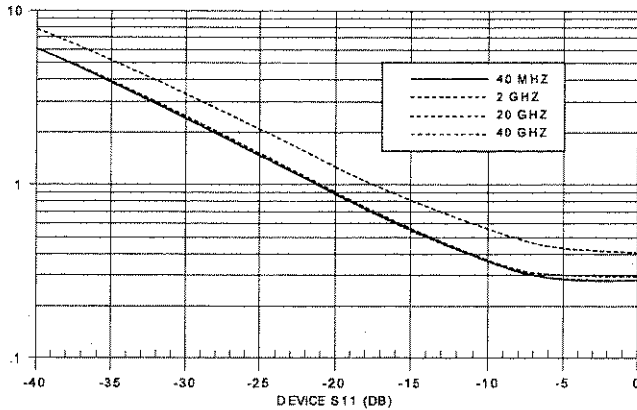

REFLECTION PHASE UNCERTAINTY
37X17A/B/3650/REFLECTION ONLY

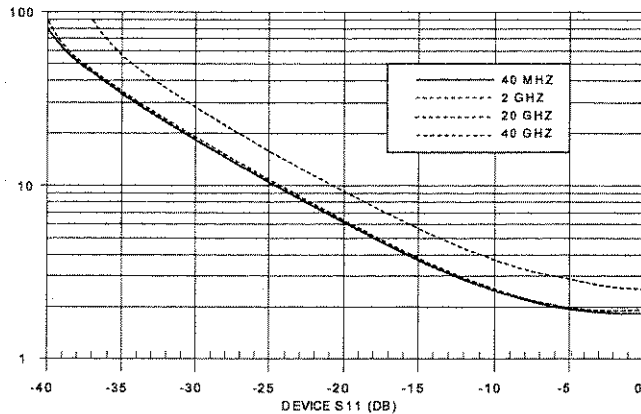

Model 37369A (K Connectors)
Transmission Measurements:

TRANSMISSION MAGNITUDE UNCERTAINTY
37X69A/B/3652/TRANSMISSION ONLY

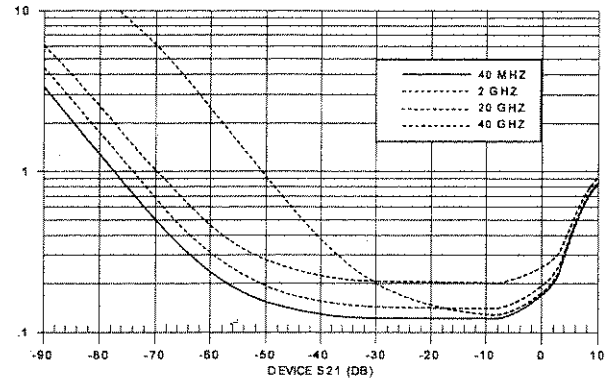

TRANSMISSION PHASE UNCERTAINTY
37X69A/B/3652/TRANSMISSION ONLY

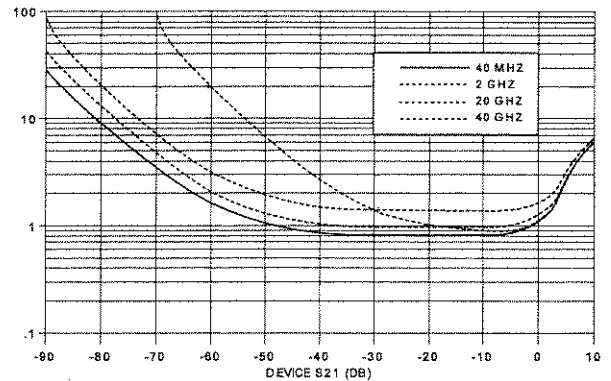

Model 37397A (V Connectors)
Reflection Measurements:

Reflection Magnitude Uncertainty
37x97A/B/3654B/Reflection Only

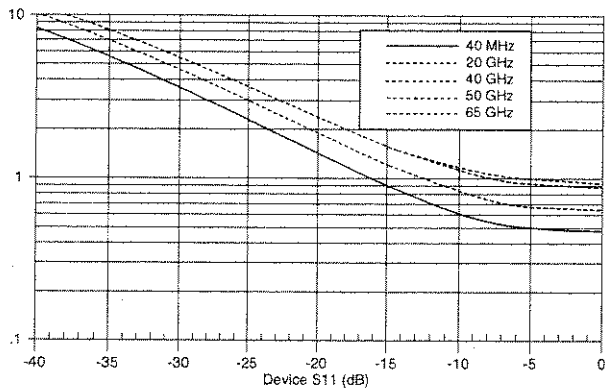

Reflection Phase Uncertainty
37x97A/B/3654B/Reflection Only

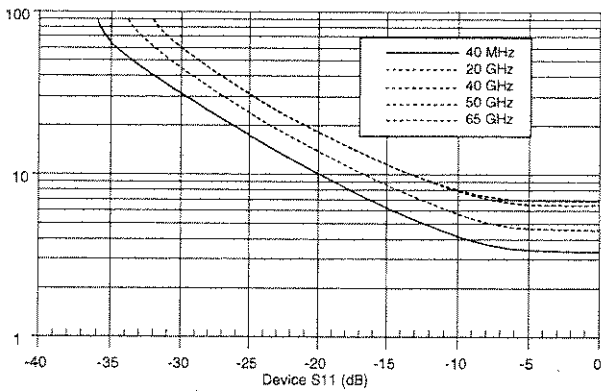

Model 37397A (V Connectors)
Transmission Measurements:

Transmission Magnitude Uncertainty
37x97A/B/3654B/Transmission Only

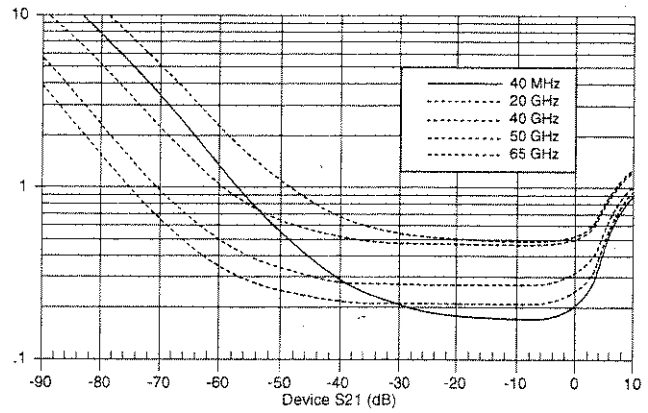

Transmission Phase Uncertainty
37x97A/B/3654B/Transmission Only

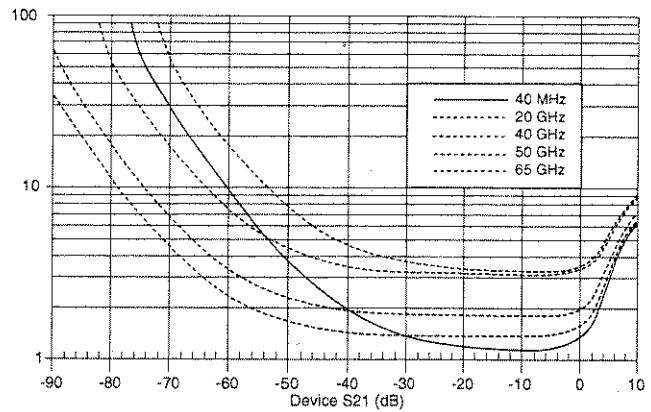

3671V50-1 Universal Test Port Converter On Each Side, moving the VNAs V-type test port converter to the end of the cable, 25 in., 2 each.

3671V50-2 Universal Test Port Converter On Each Side, moving the VNAs V-type test port converter to the end of the cable, 38 in., 1 each.

NOTE: All 3671-Series flexible test port cables mate to the standard 34UK50 Universal K Connector Test Port.

TEST PORT CONVERTERS

- 34UA50 Test Port Converter,** Universal/GPC-7
- 34UK50 Test Port Converter,** Universal/K Connector, male
- 34UN50 Test Port Converter,** Universal/N, male
- 34UNF50 Test Port Converter,** Universal/N, female
- 34UQ50 Test Port Converter,** Universal/2.4 mm, male
- 34US50 Test Port Converter,** Universal/3.5 mm, male
- 01-202, Wrench,** for changing test set Test Port Converters.

GPIB CABLES

- 2100-1 GPIB Cable,** 1 m (3.3 ft.)
- 2100-2 GPIB Cable,** 2 m (6.6 ft.)
- 2100-4 GPIB Cable,** 4 m (13.2 ft.)
- 2100-5 GPIB Cable,** 0.5 m (1.65 ft.)

ACCESSORIES

- 2000-660 HP 310 Deskjet Printer,** Printer Stand, Deskjet Printer Cartridge and Power cord.
- 2000-661 Extra Printer Cartridge**
- 2000-662 Rechargeable Battery**
- 2000-663 Power Cable,** Europe
- 2000-664 Power Cable,** Australia
- 2000-665 Power Cable,** U.K.
- 2000-666 Power Cable,** Japan
- 2000-667 Power Cable,** South Africa
- 2225-1 Spare Parallel Interface Printer Cable**

Index

<i>Number</i>	
Calibration Kits	1-4
3dB Compressed Smith Chart Display Mode	6-10
A	
Active Channel Selection	6-13
active device measurements	8-24
Active Device Measurements	
Discussion	8-24
Adapter Removal Measurements	
Discussion	8-35
Address, GPIB	2-5
Analog Instrument Status	6-12
Analyzer Module	3-5
Apply Cal key	4-4,4-9
Arrow key	4-8
Autoscale key	4-5,4-24
Average key	4-6
Avg/Smooth key	4-6
Avg/Smooth Menu key	4-28
B	
bandpass impulse response	9-5
Beatty Standard	1-8
Begin Cal key	4-4,4-9
Bias Input connectors	4-6
C	
Cable Length Restrictions	2-4
CAD system	8-28
Calibrating for a Measurement	7-9
calibration	
See measurement calibration	
Calibration Key_Group Description	4-9
calibration keys	4-9
Calibration keys	4-4,4-9
calibration kit	7-13
Calibration Kit	
3650	1-4
Calibration Kits	
3651	1-5
3652	1-5
3653	1-6
Contents	12-3
Model 3650	12-4
Model 3651	12-6
Model 3652	12-8
Model 3653	12-10
Model 3654/3654B.	12-12
Model 36550.	12-14
Model 36552.	12-16
Purpose	12-3
calibration sequence	4-9
Ch 1 key	4-7
Ch 2 key	4-7
Ch 3 key	4-7
Ch 4 key	4-7
Ch1 - Ch4 keys	4-23
Channel Menu key	4-7,4-23
Channels Key-Group	4-23
Channels keys	4-7
.	4-23
Cleaning Connectors.	12-21
Clear/Ret Loc key	4-8
Connector Pin Depth.	12-18
Connector Pin Depth Tolerance.	12-19
Connectors	
Cleaning	12-21
Copying Data Files	4-41
D	
Data Display	
Active Channel Selection.	6-13
Analog Instrument Status	6-12
Control	6-13
Frequency Range	6-12
Limits	6-12
Linear Phase	3-9
Log Magnitude.	3-9
Markers	6-15
Measurement Status	6-13

Plotter Output 6-16

Polar 3-10

Reference Position Marker 6-12

Scale Resolution 6-12

Screen-Image Printout 6-16

Smith 3-10

S-Parameter Selection 6-14

Status 6-12

Sweep Marker Indicator 6-13

Tabular Printout 6-15

Update 6-14

Data Display Modes

 3 dB Compressed Smith Chart 6-10

 Dual Channel 6-4

 Dual Channel Rectilinear Graticule 6-8

 Dual Trace Overlay 6-6

 Four Channel 6-5

 Graph Data Types 6-7

 Linear Polar Graticule 6-8

 Log Polar Graticule 6-9

 Marker Annotation 6-11

 Marker Designation 6-11

 Normal Smith Chart 6-9

 Single Channel 6-3

Data Display Modes and Types 6-3

Data Entry keys 4-8

data plotting 4-30

Data Points key 4-7,4-20

Default Parameters 8-3,8-10

Default Program key 4-4,4-32

Device ID key 4-20

Disk Files, Format 4-36

Disk Output 6-16

disk storage interface 4-36

Disk Storage Interface 4-36

Diskette drive 4-6

Display Key-Group 4-24

Display keys 4-5,4-24

Domain key 4-7,4-20

Dual Channel Display Mode 6-4

Dual Channel Rectilinear Display Mode 6-8

Dual Source Control

 Bands 8-30

 Operating Procedures 8-30

 Preoperational Setup 8-31

Dual Source Control Measurements

 Discussion 8-29

Dual Trace Overlay Display Mode 6-6

E

Enhancement keys 4-28

Enhancement Keys 4-6

Enter key 4-8

Error Messages 5-3

Error Modeling and Flowgraphs 7-7

Error Terms

 Description 3-11

Evaluating the Calibration 7-11

External Monitor Connector 2-5

F

Four Channel Display Mode 6-5

Fourier transform 9-3

Frequency

 Range 6-12

frequency domain 9-3,9-8,9-12

Front Panel

 Calibration Key-Group Description 4-9

 Channels Key-Group Description 4-23

 Display Key-Group Description 4-24

 Key_Group Descriptions 4-3

 Markers/Limits Key-Group Description 4-35

 Measurement Key-Group Description 4-20

 Output Key-Group Description 4-30

 Save/Recall Key, Description 4-19

 System State Key-Group Description 4-32

G

Gain Compression

 Swept Power Gain Compression Measurement 8-44

 Swept Frequency Measurement 8-52

Gain Compression Measurements

 Discussion 8-40

gating 9-12

General Description 3-3

GHz/10 3/Ms/m key 4-8

GPIB

 Indicators 4-3

 Addresses 2-5

 Interface to External Plotter 2-5

 Setup and Interconnection 2-4

Graph Data Types 6-7

Graph Type key 4-5,4-24

group delay
 applications 8-23
 discussion 8-20
 equation 8-21
 frequency aperture 8-21
 group delay measurements 8-20
 Group Delay Measurements
 Discussion 8-20

H

Hard Copy
 Plotter Output 6-16
 Screen-Image Printout 6-16
 Tabular Printout 6-15
 Hard Copy and Disk Output 6-15
 Hard Copy keys 4-4,4-30
 High Level Noise Test
 Test Procedure 11-8
 Test Setup 11-8
 High Level Noises Test 11-8
 Hold key 4-7,4-20

I

Identification number 1-3
 Identification Number 1-3
 impulse response 9-4
 Initial Inspection 2-3
 Initial Setup
 11-3
 insertables 7-5
 interface
 disk storage 4-36
 Interface Connector 2-4
 Introduction 11-3

K

Keyboard connector 4-6
 Keypad 4-8
 Keys
 Channel Key-Group 4-23
 Display Key-Group 4-24
 Markers/Limits 4-35
 Markers/Limits Key_Group 4-35
 Measurement Key-Group 4-20,4-23
 Output Key-Group 4-30

Save/Recall Menu 4-19
 System State 4-32
 System State Key-Group 4-32
 keys
 calibration 4-9
 kHz/10 _3/ps/mm key 4-8
 Kit Contents 12-3

L

Limit Frequency Readout Function 4-35
 Limits 6-12
 Limits key 4-5,4-36
 Linear Polar Graticule Display Mode 6-8
 load match 7-6
 Log Magnitude Display 3-9
 Log Polar Graticule Display Mode 6-9
 Low Level and Gain Measurements
 Discussion 8-12
 Receiver Dynamic Range 8-12
 Signal-to-Noise Power Ratio 8-13
 System Considerations 8-12
 Test Device (DUT) Considerations 8-19
 low level measurements 8-12
 LRL/LRM Calibration Procedure
 Coaxial 7-40
 General 7-32
 Microstrip 7-33
 Waveguide 7-42
 LRL/LRM Calibration Setup Menu Flow 4-14

M

Marker
 Reference Position 6-12
 Marker Annotation Data Display 6-11
 Marker Designation 6-11
 Marker Menu key 4-5,4-35
 Markers
 Display of 6-15
 Markers/Limits Key_Group 4-35
 Markers/Limits keys 4-5,4-35
 measurement
 group delay 8-20
 measurement calibration
 discussion 7-3
 Measurement Calibration
 Calibration Types 7-7
 Discussion 7-3

Error Modeling and Flowgraphs	7-7	Model 36552 Calibration Kit	12-16
Evaluating the Calibration	7-11	Multiple Source Control	
LRL/LRM Procedure	7-32	Control Formula	8-29
Offset-Short Procedure	7-28	Operation	8-32
Sliding Load, Procedure	7-13		
Standard (OSL) Procedure	7-19	N	
Understanding	7-6	network analyzer	7-13
Measurement Key-Group Description	4-20	Network Analyzer	
Measurement keys	4-7,4-20	Description	1-3
Measurement Status	6-13	Options	1-9
measurement uncertainty	7-3	Network Analyzers	
measurements		Basics	3-6
active device	8-24	Error Correction	3-11
high-gain devices	8-21	Measurements	3-9
low level	8-12	Primer	3-5
medium-power devices	8-21	non _insertables	7-5
time domain	9-3	Normal Smith Chart Display Mode	6-9
transmission and reflection	8-3		
wide-dynamic-range devices	8-21	O	
Measurements		Offset-Short Calibration Procedure	7-28
Active Device	8-24	Offset-Short Calibration Setup Menu Flow	4-12
Adapter Removal	8-35	open	8-27
Dual Source Control	8-29	Operational Checkout	
Gain Compression	8-40	High Level Noise Test	11-8
Group Delay	8-20	Initial Setup	11-3
Low Level and Gain	8-12	Required Test Equipment	11-3
Receiver Mode	8-60	Sampler Efficiency Test	11-4
Transmission and Reflection	8-3	Self Test.	11-3
Mechanical Shock	12-20	Option 2 Time Domain	
Menu Flow		Menus	9-14
Calibration Key_Group Menus	4-9	Option 2A Time Domain	
MARKER MENU Key	4-36	Gating	9-12
Save/Recall Key.	4-19	Gating Example	9-14
Menu key	4-4,4-30	Operating	9-8
Menu keys.	4-8	Windowing	9-11
Menus		Option 5 Receiver Mode	
Channels Key-Group	4-23	Menus	8-61
Display Key-Group	4-24	Operating Procedure	8-62
Markers/Limits Key_Group	4-35	Operation	8-61
Measurement Key-Group	4-20	Set-On Mode	8-60
Output Key-Group	4-30	Sweeper Source Lock Mode	8-60
System State Key-Group	4-32	Option Menu key	4-6,4-28
MHz/X1/ns/cm key	4-8	Options	1-9
microwave load	7-13	Output Key-Group	4-30
Model 3650 Calibration Kit	12-4	Over Torquing Connectors.	12-20
Model 3651 Calibration Kit	12-6		
Model 3652 Calibration Kit	12-8		
Model 3653 Calibration Kit	12-10		
Model 3654/3654B Calibration Kit	12-12		
Model 36550 Calibration Kit	12-14		

P

Performance Specifications 1-9
 phasor-impulse response 9-5
 pin depth 7-13
 Plotter Output 6-16
 plotting 4-30
 Polar Display 3-10
 Port 1 connector 4-6
 Port 1 Test Connector 4-4
 Port 2 connector 4-6
 Port 2 Test Connector 4-5
 Precision Component Kits 1-4
 Preparation for Storage and/or Shipment 2-5
 Preparation for Use 2-3
 printing
 stop/start 4-30
 Purpose 12-3

R

Readout Marker key 4-5,4-35
 Receiver Mode Measurements 8-60
 Operating Procedure 8-62
 Recommended Test Equipment 1-9
 Recovering from disk write/read errors 4-42
 Ref Plane key 4-5,4-24
 reference flat 7-15
 Reference Position Marker 6-12
 Rotary Knob 4-8

S

S Params key 4-5,4-24
 Sampler Efficiency Test
 11-4
 Test Procedure 11-5
 Test Setup 11-5
 Save/Recall Menu 4-19
 Save/Recall Menu key 4-4
 Save/Recall Menu key 4-19
 Scale Resolution 6-12
 Scattering parameters 3-9
 Screen-Image Printout 6-16
 Self Test
 11-3
 Service Centers 2-7
 Set Scale key 4-5,4-24

Setup Menu key 4-7,4-20
 short 8-27
 signal power 8-13
 signal-to-noise-power ratio 8-13
 Single Channel Display Mode 6-3
 sliding load
 pin depth 7-13
 Sliding load
 17K50, 17KF50 1-5
 17S50, 17SF50 1-4
 Sliding Load
 Calibration Procedure 7-13
 Used in Calibraton 7-6
 sliding loads 7-13
 SMA 7-13
 Smith Chart 8-10
 3 dB Compressed 6-10
 Measurement Discussion 8-8
 Normal 6-9
 Smith Chart Display 3-10
 source match 7-6
 Source Module
 General 3-4
 s-parameter 8-25
 S-Parameter
 Description 3-9 - 10
 Selection, Display of 6-14
 S-Parameters
 General 3-9
 Specifications, Performance 1-9
 Standard Calibration Setup Menu Flow 4-10
 start print 4-30
 Start Print key 4-4,4-30
 Status Display 6-12
 Stop Print key 4-5,4-30
 stop printing 4-30
 Sweep Marker Indicator 6-13
 System Description 1-3
 System GPIB Interconnection 2-5
 System State Key-Group 4-32
 System State keys 4-4,4-32

T

Tabular Printout 6-15
 Teflon Tuning Washers 12-20
 Test Equipment 1-9
 Test Ports
 Establishing, Discussion 7-3

Test Set
 Reversing 3-11
Test Set Module
 General 3-4
time delay
 linear 8-21
time domain measurements 9-3
Time Domain Measurements 9-3
Trace Memory key 4-5,4-25
Trace Smooth and Average keys 4-28
Trace Smooth key 4-6
tracking 7-6
transmission and reflection measurements 8-3
Transmission and Reflection Measurements
 Discussion 8-7
 General 8-3
 Setup and Calibration 8-3
 Smith Chart 8-8
TRM Calibration Setup Menu Flow 4-16

U

Using Connectors
 Mechanical Shock 12-20

Over Torquing 12-20
Pin Depth 12-18
Pin Depth Tolerance 12-19
Teflon Tuning Washers 12-20
Utility Menu key 4-4,4-32

V

Verification Kit
 3666 1-8
 3668 1-7,1-9
Verification Kits
 Used in Calibration 7-11
Video IF BW key 4-6,4-28

W

windowing 9-11

Z

Zo load 8-27
Zo reference 7-13

