

**MS2602A**  
**Spectrum Analyzer**  
**Operation Manual Vol.1**  
**(Basic Operating Instructions)**

**Tenth Edition**

**Read this manual before using the equipment.**  
**Keep this manual with the equipment.**

**Measuring Instruments Division**  
**Measurement Group**

**ANRITSU CORPORATION**

JUN.  
1999

Document No.: M-W0653AE-10.0

# Safety Symbols

To prevent the risk of personal injury or loss related to equipment malfunction, Anritsu Corporation uses the following safety symbols to indicate safety-related information. Insure that you clearly understand the meanings of the symbols **BEFORE** using the equipment.

## Symbols used in manual

### **DANGER**

This indicates a very dangerous procedure that could result in serious injury or death if not performed properly.

### **WARNING**

This indicates a hazardous procedure that could result in serious injury or death if not performed properly.

### **CAUTION**

This indicates a hazardous procedure or danger that could result in light-to-severe injury, or loss related to equipment malfunction, if proper precautions are not taken.

## Safety Symbols Used on Equipment and in Manual

(Some or all of the following five symbols may not be used on all Anritsu equipment. In addition, there may be other labels attached to products which are not shown in the diagrams in this manual.) The following safety symbols are used inside or on the equipment near operation locations to provide information about safety items and operation precautions. Insure that you clearly understand the meanings of the symbols and take the necessary precautions **BEFORE** using the equipment.



This indicates a prohibited operation. The prohibited operation is indicated symbolically in or near the barred circle.



This indicates an obligatory safety precaution. The obligatory operation is indicated symbolically in or near the circle.



This indicates warning or caution. The contents are indicated symbolically in or near the triangle.



This indicates a note. The contents are described in the box.



These indicate that the marked part should be recycled.

MS2602A Spectrum Analyzer

Operation Manual Vol.1 (Basic Operating Instructions)

December 1992 (First Edition)

April 1999 (Tenth Edition)

Copyright © 1992 – 1999 by Anritsu Corporation

All rights reserved. No part of this manual may be reproduced without the prior written permission of Anritsu Corporation.

The contents of this manual may be changed without prior notice.

Printed in Japan

## Strategies for the Year 2000 problem

This equipment does not suffer from the Year 2000 problem (Note). However, we recommend that you should check whether your application software, in which this equipment is used as a part, has any Year 2000 bugs because this equipment indicates a year using its last two digits.

### **Note: The Year 2000 problem**

The Year 2000 problem is defined as follow:

Systems computing date data has represented the year as a two-digit number (for example, 1997 is represented as "97"). When the Year 2000 comes or data of 2000 or later is to be computed, the year is indicated as "00", "01" and so on, which causes troubles in comparison of dates, sorting using dates and computation of date data.

Another problem is that Year 2000, a leap year, is not recognized as so:



## For Safety



### DANGER

NEVER touch parts where the label shown on the left is attached. Such parts have high voltages of at least 1 kV and there is a risk of receiving a fatal electric shock.



Repair

WARNING 

Falling Over

Battery Fluid

### WARNING

1. Always refer to the operation manual when working near locations at which the alert mark shown on the left is attached. If the operation, etc., is performed without heeding the advice in the operation manual, there is a risk of personal injury. In addition, the equipment performance may be reduced.

Moreover, this alert mark is sometimes used with other marks and descriptions indicating other dangers.

2. This equipment cannot be repaired by the user. DO NOT attempt to open the cabinet or to disassemble internal parts. Only Anritsu-trained service personnel or staff from your sales representative with a knowledge of electrical fire and shock hazards should service this equipment. There are high-voltage parts in this equipment presenting a risk of severe injury or fatal electric shock to untrained personnel. In addition, there is a risk of damage to precision parts.
3. This equipment should be used in the correct position. If the cabinet is turned on its side, etc., it will be unstable and may be damaged if it falls over as a result of receiving a slight mechanical shock.
4. DO NOT short the battery terminals and never attempt to disassemble it or dispose of it in a fire. If the battery is damaged by any of these actions, the battery fluid may leak.

This fluid is poisonous.

DO NOT touch it, ingest it, or get in your eyes. If it is accidentally ingested, spit it out immediately, rinse your mouth with water and seek medical help. If it enters your eyes accidentally, do not rub your eyes, irrigate them with clean running water and seek medical help. If the liquid gets on your skin or clothes, wash it off carefully and thoroughly.

## For Safety

### CAUTION

#### Cleaning



#### Check Terminal



1. Keep the power supply and cooling fan free of dust.
  - Clean the power inlet regularly. If dust accumulates around the power pins, there is a risk of fire.
  - Keep the cooling fan clean so that the ventilation holes are not obstructed. If the ventilation is obstructed, the cabinet may overheat and catch fire.
2. Use two or more people to lift and move this equipment, or use a trolley. There is a risk of back injury, if this equipment is lifted by one person.
3. Never input a signal of more than DC 0 V between the measured terminal and ground. Input of an excessive signal may damage the equipment.

Refer to the Section 2 in Basic operating instructions of Operation manual, except the above descriptions.

# Equipment Certificate

Anritsu Corporation certifies that this equipment was tested before shipment using calibrated measuring instruments with direct traceability to public testing organizations recognized by national research laboratories including the Electrotechnical Laboratory, the National Research Laboratory of Metrology and the Communications Research Laboratory, and was found to meet the published specifications.

## Anritsu Warranty

Anritsu Corporation will repair this equipment free-of-charge if a malfunction occurs within 1 year after shipment due to a manufacturing fault, provided that this warranty is rendered void under any or all of the following conditions.

- The fault is outside the scope of the warranty conditions described in the operation manual.
- The fault is due to mishandling, misuse, or unauthorized modification or repair of the equipment by the customer.
- The fault is due to severe usage clearly exceeding normal usage.
- The fault is due to improper or insufficient maintenance by the customer.
- The fault is due to natural disaster including fire, flooding, earthquake, etc.
- The fault is due to use of non-specified peripheral equipment, peripheral parts, consumables, etc.
- The fault is due to use of a non-specified power supply or in a non-specified installation location.

In addition, this warranty is valid only for the original equipment purchaser. It is not transferable if the equipment is resold.

Anritsu Corporation will not accept liability for equipment faults due to unforeseen and unusual circumstances, nor for faults due to mishandling by the customer.

## Anritsu Corporation Contact

If this equipment develops a fault, contact Anritsu Corporation or its representatives at the address in this manual.

---

'IBM' is a registered trademark of the IBM Corporation.  
'HP' is a registered trademark of the Hewlett-Packard Company.  
'MS-DOS' is a registered trademark of the Microsoft Corporation.  
'NEC' is a registered trademark of the NEC Corporation.



---

## ABOUT DETECTION MODE

---

This instrument is a spectrum analyzer which uses a digital storage system. The spectrum analyzer makes level measurements in frequency steps obtained by dividing the frequency span by the number of measurement data points (501 or 1002). This method of measurement cannot detect the signal peak level if the spectrum of a received signal is narrower than these frequency steps.

To resolve this problem, this instrument usually operates in positive peak detection mode. In this mode, the highest level within the frequency range between the sample points can be held and traced.

Positive peak detection mode should be used for almost all measurements including normal signal level measurement, pulsed noise analysis, and others. It is impossible to measure the signal level accurately in sample detection mode or in negative peak detection mode.

Use of sample detection mode is restricted to random noise measurement, occupied frequency bandwidth measurement for analog communication systems, and adjacent-channel leakage power measurement, etc.

Measurement item	Detection mode
● Normal signal level .....	POS PEAK
● Random noise .....	SAMPLE
● Pulsed noise .....	POS PEAK
● Occupied frequency bandwidth, adjacent-channel leakage power (for analog communication systems) .....	SAMPLE
● Occupied frequency bandwidth, adjacent-channel leakage power (for digital communication systems) .....	POS PEAK or SAMPLE

When a detection mode is specified as one of the measurement methods, make the measurement in the specified detection mode.

---

## MEMORY BACK-UP BATTERY REPLACEMENT

---

The power for memory back-up is supplied by a Poly-carbomonofluoride Lithium Battery. This battery should only be replaced by a battery of the same type; since replacement can only be made by Anritsu, contact the nearest Anritsu representative when replacement is required.

---

## STORAGE MEDIUM

---

This equipment stores data and programs using Plug-in Memory cards (PMC) and backed-up memories. Data and programs may be lost due to improper use or failure. ANRITSU therefore recommends that you back-up the memory.

### ANRITSU CANNOT COMPENSATE FOR ANY MEMORY LOSS.

Please pay careful attention to the following points. Do not remove the IC card and backed-up memory from equipment being accessed.

(PMC)

- Isolate the card from static electricity.
- The back-up battery in the SRAM card has a limited life; replace the battery periodically.

(Backed-up memory)

- Isolate the memory from static electricity.

*Note: The battery life is about 7 years. Early battery replacement is recommended.*

---

## Compatible Video Printers

---

Up until the present, this instrument recommended that you use the UA455A (Nippon Aleph corp.) as a video printer for measurement screen hard copies. However, a hardware upgrade for this instrument has made it possible to also use the following video printer:

Manufacturer: Seikosha Corp.

Model Name: VP-1500 II Video Printer

Release Date for Compatible Model: end of February 1996

Model Numbers: starting from MT81153

# CE Marking

Anritsu affix the CE Conformity Marking on the following product (s) in accordance with the Council Directive 93/68/EEC to indicate that they conform with the EMC directive of the European Union (EU).

## CE Conformity Marking



### 1. Product Name/Model Name

Product Name: Spectrum Analyzer

Model Name: MS2602A

### 2. Applied Directive

EMC: Council Directive 89/336/EEC

Safety: Council Directive 73/23/EEC

### 3. Applied Standards

EMC:

Electromagnetic radiation:

EN55011 (ISM, Group 1, Class A equipment)

Immunity:

EN50082-1

Performance criteria\*

IEC801-2 (ESD) 4 kVCD, 8 kVAD

B

IEC801-3 (Rad.) 3 V/m

A

IEC801-4 (EFT) 1 kV

B

\*: Performance criteria

A: No performance degradation or function loss

B: Self-recovered temporary degradation of performance or temporary loss of function

Harmonic current emissions:

EN61000-3-2 (Class A equipment)

Safety: EN61010-1 (Installation Category II, Pollution Degree 2)

# ABOUT THIS MANUAL

## (1) Composition of MS2602A Operation Manuals

The MS2602A Spectrum Analyzer operation manuals of the standard type are composed of the following three documents. Use them properly according to the usage purpose.

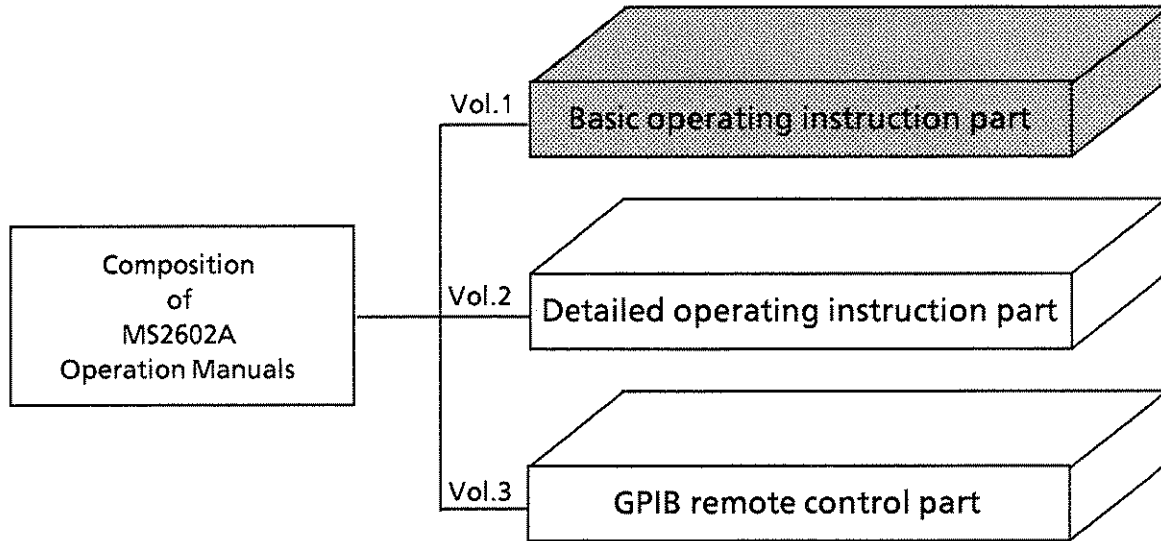

**Basic operating instruction part:**

**Basic Operating Instructions:** Provides information on the MS2602A outline, preparation before use, panel description, basic operation, performance tests, calibration, storage / transportation, and quick reference for functions other than PTA.

**Detailed operating instruction part:**

**Detailed Operating Instructions:** Provides information on the detailed operating instructions that expand on the panel description and basic operation in the Basic Operating Instruction Part of the separate Operation Manual. An index is available for the function menu to facilitate quick reference.

**GPIB remote control part:**

Provides information on the MS2602A remote control which conforms with IEEE488.2 standards. To assist creating GPIB programs, this manual gives examples of N<sub>88</sub> Basic language programs that run on the Nippon Electric Co.( NEC ) PC9800 series of personal computers.

## (2) GPIB Basic Guide ( sold separately )

The GPIB Basic Guide is sold separately in addition to the above GPIB operation manual. It is composed of two parts: GPIB Basic Knowledge, and GPIB Control statements in the ANRITSU PACKET V BASIC.

# TABLE OF CONTENTS

<b>For Safety</b> .....	iii
<b>SECTION 1 GENERAL</b> .....	1-1
1.1 Product Outline .....	1-3
1.2 Composition of Operation Manual .....	1-4
1.3 Equipment Configuration .....	1-5
1.3.1 Standard configuration .....	1-5
1.3.2 Options .....	1-6
1.4 Optional Accessories and Peripherals .....	1-7
1.5 MS2602A Specifications .....	1-10
<b>SECTION 2 PREPARATIONS BEFORE USE</b> .....	2-1
2.1 Installation Site and Environment Conditions .....	2-3
2.1.1 Locations to be avoided .....	2-3
2.1.2 Fan clearance .....	2-3
2.2 Safety Measures .....	2-4
2.2.1 Power-on .....	2-4
2.2.2 Input level to RF Input .....	2-4
2.2.3 Action in case of probe power failure .....	2-5
2.3 Installation .....	2-6
2.3.1 Rack mounting .....	2-6
2.3.2 Stacking .....	2-6
2.4 Preparations before Power-on .....	2-7
2.4.1 Protective grounding .....	2-8
2.4.2 Replacing fuse .....	2-9
2.5 Precautions for Handling Storage Media .....	2-11
2.5.1 Floppy disks .....	2-11
2.5.2 Plug-in memory cards ( PMC ) .....	2-12
<b>SECTION 3 PANEL DESCRIPTION</b> .....	3-1
3.1 Table of Front and Rear Panel Features .....	3-3

<b>SECTION 4</b>	<b>BASIC OPERATING INSTRUCTIONS</b> .....	4-1
4.1	Initial Power ON .....	4-3
4.2	Preparation for Check-Signal Measurement .....	4-6
4.2.1	500 MHz Output and RF Input connection .....	4-6
4.2.2	Initial CRT display .....	4-7
4.3	Check-Signal Level and Frequency Measurement .....	4-8
4.3.1	Center frequency setting .....	4-8
4.3.2	Frequency span setting .....	4-9
4.3.3	Reference level setting .....	4-10
<b>SECTION 5</b>	<b>PERFORMANCE TESTS</b> .....	5-1
5.1	Requirement for Performance Tests .....	5-3
5.2	Instruments Required for Performance Tests .....	5-4
5.3	Performance Test .....	5-6
5.3.1	Reference oscillator frequency stability .....	5-6
5.3.2	Center frequency readout accuracy .....	5-8
5.3.3	Frequency span readout accuracy .....	5-10
5.3.4	Resolution bandwidth ( RBW ) and selectivity .....	5-13
5.3.5	Sideband noise .....	5-19
5.3.6	Frequency measurement accuracy .....	5-21
5.3.7	CRT display amplitude scale linearity .....	5-23
5.3.8	Frequency response .....	5-26
5.3.9	Reference level accuracy .....	5-29
5.3.10	Average noise level .....	5-31
5.3.11	Second harmonic distortion .....	5-34
5.3.12	Resolution bandwidth ( RBW ) switching error .....	5-37
5.3.13	LOG / LIN scale switching error .....	5-40
5.3.14	Input attenuator switching error .....	5-42
5.3.15	Sweep time and time span accuracy .....	5-45
5.4	Service .....	5-50
<b>SECTION 6</b>	<b>CALIBRATION</b> .....	6-1
6.1	Requirement for Calibration .....	6-3
6.2	Equipment Required for Calibration .....	6-3
6.3	Calibration .....	6-4
6.3.1	Calibrating reference-crystal-oscillator frequency .....	6-4

<b>SECTION 7</b>	<b>STORAGE AND TRANSPORTATION</b> .....	7-1
7.1	Cleaning Cabinet .....	7-3
7.2	Storage Precautions .....	7-3
7.2.1	Precautions before storage .....	7-3
7.2.2	Recommended storage precautions .....	7-3
7.3	Repacking and Transportation .....	7-4
7.3.1	Repacking .....	7-4
7.3.2	Transportation .....	7-4
<b>APPENDIX A</b>	<b>MS2602A BLOCK DIAGRAM</b> .....	A-1
<b>APPENDIX B</b>	<b>LIST OF ABBREVIATIONS ON PANEL AND DISPLAY</b> .....	B-1
<b>APPENDIX C</b>	<b>FRONT AND REAR PANEL LAYOUT</b> .....	C-1



# SECTION 1

## GENERAL

This section outlines the MS2602A Spectrum Analyzer and explains the composition of this manual, the configuration of the MS2602A with the standard accessories, the options, optional accessories, and peripherals for expanding the MS2602A capabilities, and the MS2602A specifications.

### TABLE OF CONTENTS

1.1	Product Outline .....	1-3
1.2	Composition of Operation Manual .....	1-4
1.3	Equipment Configuration .....	1-5
1.3.1	Standard configuration .....	1-5
1.3.2	Options .....	1-6
1.4	Optional Accessories and Peripherals .....	1-7
1.5	MS2602A Specifications .....	1-10

(Blank)

# SECTION 1

## GENERAL

### 1.1 Product Outline

The MS2602A is a wide-band spectrum analyzer covering a wide frequency range from 100 Hz to 8.5 GHz. This instrument employs a fully-synthesized local oscillator with 1 Hz resolution as a local signal. It therefore provides stable measurement over the entire frequency range, even when a resolution bandwidth of 10 Hz is selected. It also allows sideband noise to be suppressed below  $-115$  dBc/Hz ( below 4 GHz frequency, at 50 kHz offset ).

This instrument also incorporates a 625 kHz calibration oscillator and a 1 dB step calibration attenuator as an internal calibration signal source. This accurately calibrates switching errors such as linear scale, resolution bandwidth, reference level as well as log scale linearity. This instrument, before delivery from the factory, is set so that the frequency response calibration for data compensation is stored in the EEPROM. This provides a highly accurate level measurement over a wide frequency range.

The MS2602A has not only a rotary knob, TEN ( numeric ) keys, and step keys for setting measurement conditions, but also a one-touch signal search key to make it easier to observe signals. It is also designed with emphasis placed on the waveform display function, which switches at one-touch from frequency domain to time domain and vice-versa to analyze signals efficiently on both the frequency axis and time axis. The MS2602A also provides a marker function that works with Anritsu's own original zone marker, and a multimarker function that can display up to ten markers simultaneously.

The MEASURE functions of the MS2602A allow various measurements to be made to meet a variety of applications without external calculation. In addition to general measurements such as frequency, noise, etc. this instrument facilitates measurements of radio equipment such as occupied frequency bandwidth and adjacent-channel leakage power. Moreover, the burst average power and burst waveform template measurements make it easier to measure various types of digital mobile communications equipment.

#### ■ Applications

The MS2602A Spectrum Analyzer can be used for a wide range of applications such as development, adjustment, inspection, and maintenance of electronic parts and equipment in the following fields:

- AM / FM radio equipment
- Digital cellular telephone / cordless telephone
- Satellite broadcasting and TV equipment

## 1.2 Composition of Operation Manual

This operation manual is composed of seven sections and three appendixes. Each section is outlined below.

Section composition	Explanation
SECTION 1 GENERAL	Provides information about product outline, composition of manual, equipment configuration with standard accessories, options, optional accessories, peripherals, and MS2602A specifications
SECTION 2 PREPARATIONS BEFORE MEASUREMENT	Provides information about all preparations to be performed before using MS2602A (before power-on)
SECTION 3 EXPLANATIONS OF PANELS	Provides information about locations and functions of front- and rear-panel keys, connectors, rotary knob, and indicators, etc.
SECTION 4 BASIC OPERATIONS	Provides information about basic operation methods for novice MS2602A operations
SECTION 5 PERFORMANCE TESTS	Provides information about equipment required for executing MS2602A performance tests, setup, and procedure of performance tests
SECTION 6 CALIBRATION	Provides information about equipment required for executing MS2602A calibration, setup, and procedure of calibration
SECTION 7 STORAGE AND TRANSPORTATIONS	Provides information about regular care and long-term storage as well as repacking and transportation
APPENDIX A	Provides information about list of initial settings
APPENDIX B	Provides information about list of abbreviations
APPENDIX C	Provides information about fold-out diagrams of MS2602A front- and rear-panels. When these diagrams are folded out, this manual can be read while looking at the panel operation diagrams.

### 1.3 Equipment Configuration

This paragraph describes the configuration of the MS2602A Spectrum Analyzer with standard accessories and the various options to expand the functions.

#### 1.3.1 Standard configuration

The table below shows the configuration of the MS2602A with the standard accessories.

**Standard Composition**

Item	Model † <sup>1</sup> / Order No.† <sup>1</sup>	Name † <sup>1</sup>	Qty.	Remarks
Main instrument	MS2602A	Spectrum Analyzer	1	
Accessories	J0114A	Coaxial cable	1	Approx. 1 m (UG-21D/U · RG9A/U · UG-21D/U)
	J0104A	Coaxial cable	1	Approx. 1 m (BNC-P · RG-55 / U · N-P)
	J0017F	Power cord	1	Approx. 2.5 m
	P0005	Memory card (32 Kbytes)	1	SRAM † <sup>2</sup> type plug-in memory card (PMC) for external memory of MS2602A. Memory capacity: 32 KB † <sup>3</sup>
	F0014 (6.3A) or F0012 (3.15A)	Fuse	2	For 100 V system  For 200 V system
	W0653AE	Operation manual	1 set	<ul style="list-style-type: none"> <li>● Basic operating instruction part</li> <li>● Detailed operating instruction part</li> <li>● GPIB remote control part</li> </ul>

†<sup>1</sup> Please specify the model / order number, name, and quantity when ordering.

†<sup>2</sup> SRAM: Static Random Access Memory

†<sup>3</sup> KB: kiloByte

### 1.3.2 Options

The table below shows the options for the MS2602A which are sold separately.

Model † / Order No. †	Name †	Remarks
MS2602A-01	Reference crystal oscillator	Stability: $\leq 5 \times 10^{-9}$ /day
MS2602A-02	GPIB / RS-232C interface	Combining GPIB 1 with RS-232C
MS2602A-03	GPIB / I/O Ports interface	Combining GPIB 1 with I/O port
MS2602A-04	PTA ( with PTA keyboard )	PTA (Personal Test Automation) provides a personal computer function enabling high-speed calculation and control for direct access to the measurement system. The program for the PTA can be created using the high level language, PTL (Personal Test Automation Language).
MS2602A-05	PTA (without PTA keyboard )	

† Please specify the model/order number, name, and quantity when ordering.

## 1.4 Optional Accessories and Peripherals

The following table shows the optional accessories and peripherals for the MS2602A which are all sold separately.

Optional Accessories (1 / 2)

Model † / Order No. †	Name †	Remarks
J0007	GPIB cable, 1 m	408JE-101
J0008	GPIB cable, 2 m	408JE-102
P0005	Plug-in memory card (32 Kbytes)	BS32F1-C-172 Battery life: approx. 5 years
P0006	Plug-in memory card (64 Kbytes)	BS64F1-C-173 Battery life: approx. 5 years
P0007	Plug-in memory card (128 Kbytes)	BS128F1-C-174 Battery life: approx. 4.3 years
P0008	Plug-in memory card (256 Kbytes)	BS256F1-C-1175 Battery life: approx. 2.2 years
P0009	Plug-in memory card (512 Kbytes)	BS512F1-C-1176 Battery life: approx. 1.1 year
MP614A	50 $\Omega$ to 75 $\Omega$ impedance transformer	N-type connector, 10 to 1200 MHz
MB-009	50 $\Omega$ to 75 $\Omega$ impedance transformer	N-type connector, DC to 2 GHz, Insertion loss: 6.2 dB
MP612A	RF fuse holder	DC to 1000 MHz, 50 $\Omega$
MP613A	RF fuse element	5 pcs / set, for MP612A
MA1607A	Coaxial switch	DC to 3 GHz, 50 $\Omega$ (externally controllable)
MP59B	Coaxial switch	N-type connector, DC to 3GHz
MP640A	Branch	DC to 1.7 GHz, 40 dB
MP654A	Coupler	0.8 to 3 GHz, 30 dB
MP655A	Coupler	3 to 4.4 GHz, 30 dB
MP520A	CM directional coupler	25 to 500 MHz, 75 $\Omega$ , NC-J
MP520B	CM directional coupler	25 to 1000 MHz, 75 $\Omega$ , NC-J
MP520C	CM directional coupler	25 to 500 MHz, 50 $\Omega$
MP520D	CM directional coupler	100 to 1700 MHz, 50 $\Omega$

† Please specify the model / order number, name, and quantity when ordering.

### Optional Accessories ( 2 / 2 )

Model † / Order No. †	Name †	Remarks
J0063	Fixed attenuator for high power	DC to 12.4 GHz, 30 dB, 10 W
J0078	Fixed attenuator for high power	DC to 18 GHz, 20 dB, 10 W
J0079	Fixed attenuator for high power	DC to 8 GHz, 30 dB, 25 W
J0395	Fixed attenuator for high power	DC to 9 GHz, 30 dB, 30 W
J0055	Coaxial adapter	NC-P · BNC-J
MR63J	Reflection bridge	5 MHz to 2GHz, 50 Ω, N-P
MP526A	High-pass filter	For 60 MHz band
MP526B	High-pass filter	For 150 MHz band
MP526C	High-pass filter	For 250 MHz band
MP526D	High-pass filter	For 400 MHz band
MP526G	High-pass filter	For 27 MHz band
MODEL 562	DC block	Recommended product, NARDA product, 10 MHz to 12.4 GHz
B0334C	Carrying case	Protective cover, with casters
B0329C	Protective cover	
B0331C	Front handle	2 pcs / set
B0333C	Rack mounting kit	
B0332	Coupling plate	4 pcs / set

† Please specify the model/order number, name, and quantity when ordering.



## Peripherals

Model † / Order No. †	Name †	Remarks
G0044	PTA keyboard	
VP-1500 II	Video Printer	Recommended product, Seikosha Corp.
VP-15052S	Synthetic Paper	VP-1500 II Recording Charts, five rolls / unit
CBL-15GC	Cable	VP-1500 II Connection Cable
CTM-800AN1 / AN2	Printer	AN1: 100 V System; AN2: 200 V System
FX-870	Printer	Recommended product, EPSON Corp. ( for use outside of Japan )
MC8104A	Data Storage Unit	
P6201	FET probe	Recommended product, Sony Tektronix product
MH648A	Pre-amplifier	0.1 to 1200 MHz, 30 dB
MA8610A	Pre-amplifier	9 kHz to 2.2 GHz, 20 dB
MP635A	Log-periodic antenna	80 to 1000 MHz
MB19A	Antenna tripod	With pole, for MP635A / MP636A
MP666A	Log-periodic antenna	200 to 2000 MHz
MB18B	Antenna pole	For MP666A
MB9A	Antenna tripod	For MP666A

† Please specify the model / order number, name, and quantity when ordering.

Contact dealers directly regarding further information on recommended products.

## 1.5 MS2602A Specifications

The MS2602A specifications are listed in the following table.

Frequency	Frequency range		100 Hz to 8.5 GHz
	Frequency bands composed		Band frequency allocation 0 0 to 2 GHz 1 <sup>-</sup> 1.7 to 7.5 GHz 1 <sup>+</sup> 6.5 to 8.5 GHz
	Preselector range		1.7 to 8.5 GHz
	Frequency setting	Range	100 Hz to 8.5 GHz
		Mode	CENTER-SPAN, START-SPAN, START-STOP
		Resolution	1 Hz
	Frequency accuracy	Indicated frequency	Resolution: A digit in thousandths of span (1 Hz min.), but fractions are rounded (rounded up if $\geq 5$ and rounded down if $< 5$ ) Accuracy: $\pm$ (Indicated frequency $\times$ reference frequency accuracy + span $\times$ span accuracy)
		Marker frequency	Resolution: 0.2% of span, but fractions are rounded Accuracy: Normal marker is identical to the indicated frequency accuracy. Delta marker is identical to the span accuracy.
	Frequency measurement †		Resolution: 1 Hz, 10 Hz, 100 Hz, and 1 kHz Accuracy: Indicated frequency $\times$ reference frequency accuracy $\pm$ 1 count (at S/N of $\geq 20$ dB)
	Span	Setting range	0 Hz, and 100 Hz to 8.5 GHz
		Setting resolution	TEN (numeric) keys and rotary knob: 3 digits (100 to 999) Step key: 1/2/5 sequence
		Accuracy	$\pm 2.5\%$ (span $\geq 1$ kHz), $\pm 5\%$ (100 Hz $\leq$ span $< 1$ kHz)
	Resolution bandwidth	Setting range	10 Hz to 3 MHz (3 dB), 1/3 sequence Can be set manually or automatically coupled with span
		Accuracy	$\pm 20\%$
		Selectivity (60 dB/3 dB)	$\leq 15:1$ (100 kHz to 3 MHz), $12:1$ (10 Hz to 30 kHz)
Video bandwidth (VBW)		1 Hz to 3 MHz, 1/3 sequence and OFF Can be set manually or automatically coupled with resolution bandwidth	

† Counts the frequency at the peak point in the zone

Frequency (Cont.)	Signal purity and stability	Sideband noise	At 1 MHz to 4 GHz frequency $\leq -105$ dBc/Hz (at 10 kHz offset) $\leq -115$ dBc/Hz (at 50 kHz offset) $\leq -120$ dBc/Hz (at 100 kHz offset)	
		Power source spurious	$\leq -60$ dBc (at $\leq 1$ GHz frequency, < 360 Hz offset) $\leq -70$ dBc (at $\leq 1$ GHz frequency, $\geq 360$ Hz offset)	
		Residual FM	$\leq 2$ Hz p-p/0.1 sec. (at $\leq 1$ GHz frequency, 0 Hz span)	
		Frequency drift	At constant ambient temperature one hour after power-on $\leq 20$ Hz/min. (at $\leq 1$ kHz span) $\leq 200$ Hz/min. (at $\leq 10$ kHz span)	
	Reference oscillator	Frequency	10 MHz	
		Starting characteristics	$\leq 5 \times 10^{-8}$ (referred to the frequency after 24-hour warm-up starting from 10 minutes after power-on) Option 01: $\leq 2 \times 10^{-8}$ (referred to the frequency after 24-hour warm-up starting from 30 minutes after power-on)	
		Aging rate	$\leq 2 \times 10^{-8}$ /day (option 01: $\leq 5 \times 10^{-9}$ /day) $\leq 2 \times 10^{-7}$ /day (option 01: $\leq 5 \times 10^{-8}$ /day) (referred to the frequency 24-hour warm-up after power-on)	
		Temperature characteristics	$\leq 5 \times 10^{-8}$ /day (option 01: $\leq 3 \times 10^{-8}$ /day) (referred to the frequency at 25°C, in the range of 0° to 50°C)	
	Amplitude	Level measure- ment	Measurement range	Average noise level to +30 dBm
			Maximum input level	Continuous wave average power: +30 dBm (Input attenuator $\geq 5$ dB) Direct current voltage: 0 VDC
Average noise level			For 10 Hz resolution bandwidth, 1 Hz video band width, and 0 dB input attenuator $\leq -135$ dBm (1 MHz to 1.7 GHz) $\leq -135$ dBm (1.7 to 7.5 GHz, ) $\leq -130$ dBm (7.5 to 8.5 GHz)	
Residual response			$\leq -100$ dBm (in the range of 1 MHz to 8.5 GHz, 0 dB input attenuator)	
Totalized level accuracy †		$\pm 1.1$ dB (100 Hz to 2 GHz) $\pm 1.6$ dB (2 to 8.5 GHz)		
Reference level		Setting range	LOG: -100 to +30 dBm (or equivalent level) LIN: 22.4 $\mu$ V to 7.07 V	
		Setting resolution	0.1 dB (or equivalent)	
	Level step setting range	0.1 to 100.0 dB		

† Totalized level accuracy: The level accuracy that contains reference level accuracy (0 to -50 dBm) + frequency response + Log scale linearity (0 to -20 dBm) + Calibration signal accuracy.

Amplitude (Cont.)		Unit	LOG: dBm, dB $\mu$ V, dBmV, V, dB $\mu$ V (emf), W LIN: V
	Reference level	Reference level accuracy	When the values of input attenuator, resolution bandwidth, video bandwidth, and sweep time are coupled automatically at a frequency of 100 MHz and a span of $\leq 2$ MHz after calibration $\pm 0.3$ dB (-50 to 0 dBm) $\pm 0.75$ dB (-70 to -50 dBm, 0 to +30 dBm) $\pm 1.5$ dB (-90 to -70 dBm)
		Resolution bandwidth switching deviation	$\pm 0.3$ dB (after calibration)
		LOG / LIN scale switching deviation	$\pm 0.3$ dB (after calibration)
		Input attenuator setting range	0 to 55 dB, 5 dB step Can be set manually or automatically coupled with reference level
		Input attenuator switching deviation	$\pm 0.3$ dB (referred to the attenuator of 10 dB at a frequency of 100 MHz)
		Pulse-quantized error	In pulse measurement mode, At the value of data point number / sweep time < PRF LOG: 1.2 dBp-p (RBW $\leq 1$ MHz) 3 dBp-p (RBW = 3 MHz) LIN: 4% of reference level (RBW $\leq 1$ MHz) 12% of reference level (RBW = 3 MHz)
		Frequency response	At 10 dB attenuator and temperature range of 18 $^{\circ}$ to 28 $^{\circ}$ C when referred to the frequency of 100 MHz, $\pm 0.5$ dB (100 Hz to 2 GHz, band 0) $\pm 1$ dB (1.7 to 8.5 GHz, band 1 $^{-}$ , band 1 $^{+}$ ); At 5 to 55 dB input attenuator, $\pm 1$ dB (100 Hz to 2 GHz, band 0) $\pm 1.5$ dB (1.7 to 8.5 GHz, band 1 $^{-}$ , band 1 $^{+}$ ) Provided 1 $^{-}$ and 1 $^{+}$ bands are used after a preselector is tuned
	Screen display	Graticule	10 div (during single scale) LOG (/div): 10 dB, 5 dB, 2 dB, 1 dB LIN (/div): 10%, 5%, 2%, 1%
		Linearity	After calibration LOG: $\pm 0.3$ dB (0 to -20 dB, resolution bandwidth $\leq 1$ MHz) $\pm 1$ dB (0 to -70 dB, resolution bandwidth $\leq 100$ kHz) $\pm 1.5$ dB (0 to -90 dB, resolution bandwidth $\leq 10$ kHz) LIN (/div): $\leq 3\%$ (compared to reference level)
Marker level resolution		LOG: 0.01 dB LIN: 0.01% (compared to reference level)	

Amplitude (Cont.)	Spurious response	Second harmonic distortion	$\leq -70$ dBc (at 5 to 800 MHz input frequencies, band 0, mixer input level $-30$ dBm †) $\leq -80$ dBc (at 800 to 850 MHz input frequencies, band 0, mixer input level $-30$ dBm) $\leq -100$ dBc (at 850 MHz to 4.25 GHz input frequencies, band 1 <sup>-</sup> , band 1 <sup>+</sup> , mixer input level $-20$ dBm)
		Two-signal third-intermodulation distortion	At two signal frequency difference of $\geq 50$ kHz and mixer input level of $-30$ dBm $\leq -70$ dBc (at 10 to 50 MHz input frequency) $\leq -85$ dBc (at 50 MHz to 2 GHz input frequency) $\leq -80$ dBc (at 2 to 7.5 GHz input frequency)
		Image response	$\leq -70$ dBc
		Multiple response	$\leq -70$ dBc (band 1 <sup>-</sup> , band 1 <sup>+</sup> )
	1 dB gain compression	At input level to mixer, $\geq -1$ dBm (at 18° to 28°C, $\geq 100$ MHz) $\geq -3$ dBm (at 0° to 50°C, $\geq 100$ MHz)	
	Maximum dynamic range	1 dB gain compression level to noise level	$>134$ dB (1 MHz to 7.5 GHz) $>129$ dB (7.5 to 8.5 GHz)
Distortion characteristics		Second harmonics: $>87.5$ dB (5 to 800 MHz) $>92.5$ dB (800 to 850 MHz) $>107.5$ dB ( $>850$ MHz) Third intermodulation: $>93.3$ dB (10 to 50 MHz) $>98.3$ dB (50 MHz to 2 GHz) $>96.6$ dB (2 to 7.5 GHz)	
General electrical specifications	Sweep	Sweep time	Setting range: 20 msec to 1000 sec (sets upper two-digit number) (trace A or B, data point: at 501) 50 msec to 1000 sec (sets upper two-digit number) (other than the above) Can be set manually or automatically coupled with span, resolution bandwidth, and video bandwidth Accuracy: $\pm 10\%$ (20 msec to 200 sec) $\pm 15\%$ (200 to 1000 sec)
		Sweep mode	CONTINUOUS, SINGLE
		Trigger Switch	FREE RUN, TRIGGERED
		Trigger source	VIDEO, LINE, EXT ( $\pm 10$ V), EXT (TTL), TV-H, TV-V
	Gate mode	OFF, random sweep mode Setting range: GATE DELAY: 0 to 65.5 msec (1 $\mu$ sec unit) GATE LENGTH: 20 $\mu$ sec to 65.5 msec (1 $\mu$ sec unit, GATE END: at INT) GATE END: INT/EXT	

† Mixer input level = input level (dBm) - input attenuator (dB)

General electrical specifications	Sweep	Zone sweep	Sweeps only the range indicated by the zone marker																				
		Tracking sweep	Sweep while tracking peak points within the zone marker (zone sweep is also possible)																				
	Displaying time axis waveform	Time span	Setting range: At data point of 501 50, 100 to 900 $\mu$ sec (sets upper one-digit number) 1 msec to 1000 sec (sets upper two-digit number) At data point of 1002 100, 200 to 800 $\mu$ sec (sets upper one-digit even number) 1 msec to 1000 sec (sets upper one-digit even number) Accuracy: $\pm 0.5\%$																				
		Delay time setting range	Pre-trigger: - time span to 0 sec (1 point unit) Post-trigger: 0 sec to 65.5 msec (1 $\mu$ sec unit)																				
		Amplitude resolution	50 $\mu$ sec to 49 msec: 10 bits (0.1% of full scale) 50 msec to 1000 sec: 14 bits (0.01% of full scale)																				
	Number of data points		501 points, 1002 points																				
	Detection mode		POS PEAK, SAMPLE, NEG PEAK																				
	CRT display		Size: 7 inch Display color: Green Waveform display: 501 points on the horizontal axis, 322 points on the vertical axis																				
	Display function		Trace A: Displays frequency spectrum Trace B: Displays frequency spectrum Trace Time: Displays the time axis waveform at center frequency Trace A / BG: Displays simultaneously both the band to be observed (background) and the signal band (foreground) chosen by the zone marker out of the BG band Trace A / Time: Displays simultaneously both the frequency spectrum and the time axis waveform at the center frequency of the frequency spectrum																				
	Storage function		NORMAL VIEX MAX HOLD (displays the maximum envelope) MIN HOLD (displays the minimum envelope) AVERAGE (displays average value) CUMULATIVE (displays cumulative waveform) OVER WRITE (displays waveform overwritten)																				
	AM / FM demodulation		Built-in speaker, with earphone terminal Frequency deviation measurement (displays demodulated waveform) <table border="1" data-bbox="609 1634 1307 1872"> <tr> <td colspan="2">Range</td> <td>2 kHz / div</td> <td>20 kHz / div</td> <td>200 kHz / div</td> </tr> <tr> <td colspan="2">Resolution</td> <td>50 Hz</td> <td>500 Hz</td> <td>5 kHz</td> </tr> <tr> <td rowspan="2">Demodulation frequency range (3 dB bandwidth)</td> <td>AC mode</td> <td colspan="2">50 Hz to 50 kHz</td> <td>50 kHz to 1 MHz</td> </tr> <tr> <td>DC mode</td> <td colspan="2">DC to 50 kHz</td> <td>DC to 1 MHz</td> </tr> </table>			Range		2 kHz / div	20 kHz / div	200 kHz / div	Resolution		50 Hz	500 Hz	5 kHz	Demodulation frequency range (3 dB bandwidth)	AC mode	50 Hz to 50 kHz		50 kHz to 1 MHz	DC mode	DC to 50 kHz	
Range		2 kHz / div	20 kHz / div	200 kHz / div																			
Resolution		50 Hz	500 Hz	5 kHz																			
Demodulation frequency range (3 dB bandwidth)	AC mode	50 Hz to 50 kHz		50 kHz to 1 MHz																			
	DC mode	DC to 50 kHz		DC to 1 MHz																			

General Electric Specifications [ Cont. ]	Input connector		50 $\Omega$ , N type connector (socket) VSWR $\leq$ 1.5 (input attenuator $\geq$ 5 dB)
	Auxiliary input/output terminal	500 MHz OUTPUT	-18 dBm $\pm$ 3 dB (terminated with 50 $\Omega$ ) (BNC connector)
		21.4 MHz OUTPUT	-10 dBm $\pm$ 2 dB (terminated with 50 $\Omega$ ) (at the top graticule of the screen display, BNC connector)
		521.4 MHz OUTPUT	Gain: 5 dB $\pm$ 2 dB (terminated with 50 $\Omega$ ) (at 0 dB input attenuator, 1 GHz frequency, and 18° to 28°C temperature) 3 dB bandwidth: 10 MHz (at $\geq$ 30 MHz, BNC connector)
		X OUTPUT	0 to 10 V $\pm$ 1 V (terminated with 100 k $\Omega$ or more, screen display ranges from 0 V at the left edge to +10 V at the right edge, BNC connector)
		Y OUTPUT	0 to 0.5 V $\pm$ 0.1 V (terminated with 75 $\Omega$ screen display ranges from 0 V at the bottom graticule to +0.5 V at the top graticule, BNC connector)
		Z OUTPUT	TTL level (LOW level during sweep, BNC connector)
		VIDEO OUTPUT	SEPARATE: 8-pin round DIN connector, adaptable to UA-455A Digital RGB: D-sub connector
		REF INPUT	10 MHz $\pm$ 10 Hz, 2 to 5 Vp-p, $\geq$ 50 $\Omega$ (BNC connector)
		BUFFERED OUTPUT	10 MHz, 2 to 3 Vp-p (terminated with 200 $\Omega$ , BNC connector)
		PROBE POWER	+5 V, +15 V, -15 V, respectively $\pm$ 10% (each 110 mA max., 4-pole connector)
		EXT TRIG GATE INPUT	$\pm$ 10 V max.(0.1 V step, selectable for rising or falling, pulse width $\geq$ 10 $\mu$ sec, BNC connector)
	EXT TRIG INPUT	TTL level (selectable for rising or falling, pulse width $\geq$ 10 $\mu$ sec, BNC connector)	
	Local leak		$\leq$ -50 dBm (at 0 dB input attenuator)
Interference radiation		$\leq$ 20 dB $\mu$ V (when measured beside the front panel using near-magnetic probe (MA2601B), provided the CRT horizontal synchronous signal including an integral multiple of 25 kHz is omitted)	

(Continued)

Function	Signal search	AUTO TUNE, PEAK → CF, PEAK → REF, SCROLL
	Zone marker	NORMAL, DELTA
	Marker →	MARKER → CF, MARKER → REF MARKER → CF STEP SIZE, Δ MARKER → SPAN ZONE → SPAN
	Peak search	PEAK, NEXT PEAK, NEXT RIGHT PEAK, NEXT LEFT PEAK MIN DIP, NEXT DIP
	Multi marker	HIGHEST 10, HARMONICS, MANUAL SET
	Measure (calculation)	Noise level measurement (dBm / Hz, dBm / ch) C / N measurement (dBc / Hz, dBc / ch) Occupied frequency bandwidth measurement Adjacent-channel leakage power measurement Burst-in average power measurement Template (limit lines) comparison measurement
	External memory	One slot for plug-in memory card (PMC) is provided. The MC8104A Data Storage Unit can be used.
	Save / recall	Can save and recall setting conditions and waveform data to and from internal memory (16 files) and external memory (PMC), respectively. PMC (32 Kbytes) can also save up to 11 files (setting conditions and waveform data).
	Direct plotting	Can hard-copy screen data via GPIB 2 (compatible models only)
	External control	GPIB1 (IEEE 488.2)
GPIB2 (IEEE 488.1)		Can control external devices when the main instrument is used as a controller. SH1, AH1, T6, L4, SR0, RL0, PP0, DC0, DT0, C1, C2, C3, C28
Dimensions		177 (H), 426 (W), 451 (D) mm
Mass		≤ 22 kg
Power requirements		200 to 230 VAC (or 100 to 120 VAC), 50/60/400 Hz, ≤ 300 VA
Ambient temperature, rated range of use		0 to 50°C

The specifications above are applicable to system settings and auto-sweep time of normal.



## SECTION 2

### PREPARATIONS BEFORE USE

This section explains the preparations and safety procedures that should be performed before using the MS2602A Spectrum Analyzer. The safety procedures are to prevent the risk of injury to the operator and damage to the equipment. Insure that you understand the contents of the pre-operation preparations before using the MS2602A. For the GPIB cable connection and the GPIB address setting, refer to the separate GPIB operation manual.

#### TABLE OF CONTENTS

2.1	Installation Site and Environment Conditions .....	2-3
2.1.1	Locations to be avoided .....	2-3
2.1.2	Fan clearance .....	2-3
2.2	Safety Measures .....	2-4
2.2.1	Power-on .....	2-4
2.2.2	Input level to RF input .....	2-4
2.2.3	Action in case of probe power failure .....	2-5
2.3	Installation .....	2-6
2.3.1	Rack mounting .....	2-6
2.3.2	Stacking .....	2-6
2.4	Preparations before Power-on .....	2-7
2.4.1	Protective grounding .....	2-8
2.4.2	Replacing fuse .....	2-9
2.5	Precautions for Handling Storage Media .....	2-11
2.5.1	Floppy disks .....	2-11
2.5.2	Plug-in memory cards ( PMC ) .....	2-12

(Blank)

## SECTION 2 PREPARATIONS BEFORE USE

### 2.1 Installation Site and Environmental Conditions

#### 2.1.1 Locations to be avoided

The MS2602A operates normally at temperatures from 0 to 50 °C. However, for the best performance, the following locations should be avoided.

- Where there is severe vibration
- Where the humidity is high
- Where the equipment will be exposed to direct sunlight
- Where the equipment will be exposed to active gases

In addition to meeting the above conditions, to insure long-term trouble-free operation, the equipment should be used at room temperature and in a location where the power supply voltage does not fluctuate greatly.

#### CAUTION

*If the MS2602A is used at normal temperatures after it has been used or stored for a long time at low temperatures, there is a risk of short-circuiting caused by condensation. To prevent this risk, do not turn the MS2602A on until it has been allowed to dry out sufficiently.*

#### 2.1.2 Fan clearance

To suppress any internal temperature increase, the MS2602A has a fan on the rear panel as shown in the diagram below. Leave a gap of at least 10 cm between the rear panel and the wall, nearby equipment or obstructions so that fan ventilation is not blocked.

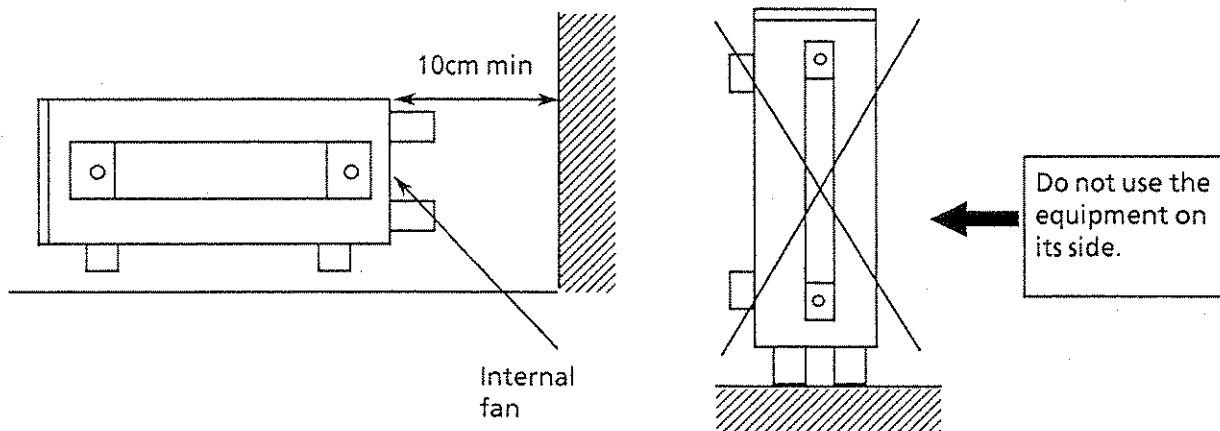

## 2.2 Safety Measures

This paragraph explains the safety procedures which should be followed under all circumstances not to counter the risk of an accidental electric shock, damage to the equipment or a major operation interruption.

### 2.2.1 Power-on

#### WARNING

- *Before power-on:* The MS2602A must be connected to protective ground. If the power is switched on without taking this countermeasure, there is a risk of receiving a accidental electric shock. In addition, it is essential to check the power supply voltage. If an abnormal voltage that exceeds the specified value is input, there is a accidental risk of damage to the MS2602A and fire.
- *During power-on:* To maintain the MS2602A, sometimes it is necessary to make internal checks and adjustments with the top, bottom or side covers removed while power is supplied. Very-high, dangerous voltages are used in the MS2602A; if insufficient care is taken, there is a risk of a accidental electric shock being received or of damage to the equipment. To maintain the MS2602A, request service by a service personnel who has received the required training.

In the following, special notes on safety procedures are extracted from sections other than Section 2. To prevent accidents, read this section together with the related sections before beginning operation.

### 2.2.2 Input level to RF Input

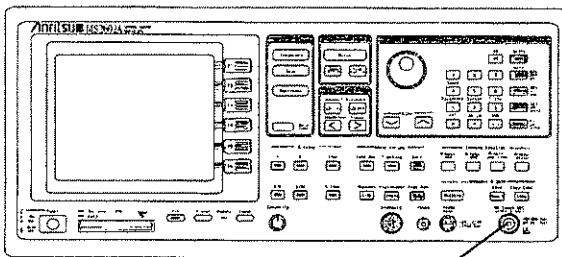

Frequency range: 100 Hz to 8.5 GHz  
Measurement level: Apply the measured signal with average noise level of up to +30 dBm to the N-type connector RF Input of 50  $\Omega$  input impedance

#### CAUTION

The RF Input circuit is not protected against excessive power. If a signal exceeding +30 dBm is applied, the input attenuator and input mixer may be burned.  $\triangleleft ! \triangleright$  is a warning mark to prevent such damage. The input circuit does not have a DC-blocking capacitor, so do not apply a signal containing a DC component. If DC voltage in excess of 0 V is applied, it will not be possible to properly maintain the bias of the input mixer.

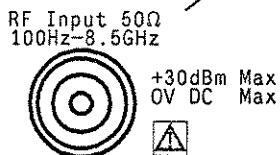

### 2.2.3 Action in case of Probe Power failure

A high-impedance probe is required for in-circuit measurement. As power supply terminal for this probe, the Probe Power connector (+5 V,  $\pm 15$  V, 110 mA max.) shown below are provided.

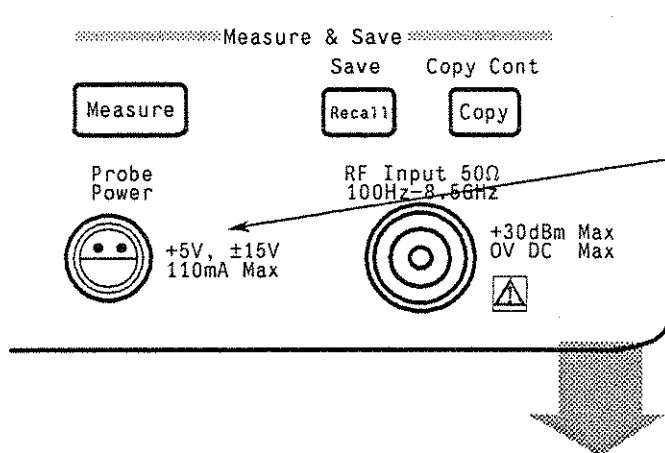

If the impedance at the measurement point is too low, the current may exceed 110 mA because of the overloaded condition. This will cause power source problems for the MS2602A main instrument. Therefore, the probe power should not exceed 110 mA.

#### CAUTION

*When current to the probe increases on the order of several amperes or when the check terminal of the probe is shorted for any reason, the protection circuit of the MS2602A power supply section operates and DC power supply is stopped. In this case, remove the power plug inserted into the Probe Power connector, eliminate the cause of the overload current, and insert the power plug again into the Probe Power connector. The MS2602A power supply section is restored to normal operating condition several minutes after the overload condition is eliminated. DC power can now be supplied again.*

## **2.3 Installation**

### **2.3.1 Rack mounting**

The B0333C Rack Mount Kit ( sold separately ) is required to mount the MS2602A in a rack.  
The installation method is included in the rack mount kit diagram.

### **2.3.2 Stacking**

When stacking several MS2602As or stacking the MS2602A with equipment of the same width as the MS2602A, the B0332 Stacking Legs ( sold separately ) are required.

## 2.4 Preparations before Power-on

The MS2602A operates normally when it is connected to an \*\*Vac AC power supply. To prevent the following problems, take the necessary procedures described on the following pages before power is supplied.

- Accidental electric shock
- Damage caused by abnormal voltage
- Ground current problems

**Note:** ● *The voltage and current ratings are indicated on the rear panel when the instrument is shipped from the factory.*

- *In this manual, the power supply voltage and current ratings are represented by \*\*Vac and \*\*\*A, respectively.*

To protect the operator, the following WARNING and CAUTION notices are attached to the rear panel of the MS2602A.

**WARNING**   
NO OPERATOR SERVICE-  
ABLE PARTS INSIDE.  
REFER SERVICING TO  
QUALIFIED PERSONNEL.

**CAUTION**   
FOR CONTINUED FIRE  
PROTECTION REPLACE  
ONLY WITH SPECIFIED  
TYPE AND RATED FUSE.

**WARNING**

*Disassembly, adjustment, maintenance, or other access inside this instrument by unqualified personnel should be avoided. Maintenance of this instrument should be performed only by Anritsu trained service personnel who are familiar with the risks involved of fire and electric shock. Potentially lethal voltages existing inside this instrument, if contacted accidentally, may result in personal injury or death, or in the possibly of damage to precision components.*

Always follow the instructions on the following pages.

## 2.4.1 Protective grounding

### (1) Grounding with 3-pole power outlet

When connecting to a 3-pole (grounded, 2-pole type) ac power-supply outlet, the frame of the MS2602A is connected to ground potential. As a result, it is not necessary to connect the FG terminal to ground.

### (2) Grounding with frame ground (FG) terminal

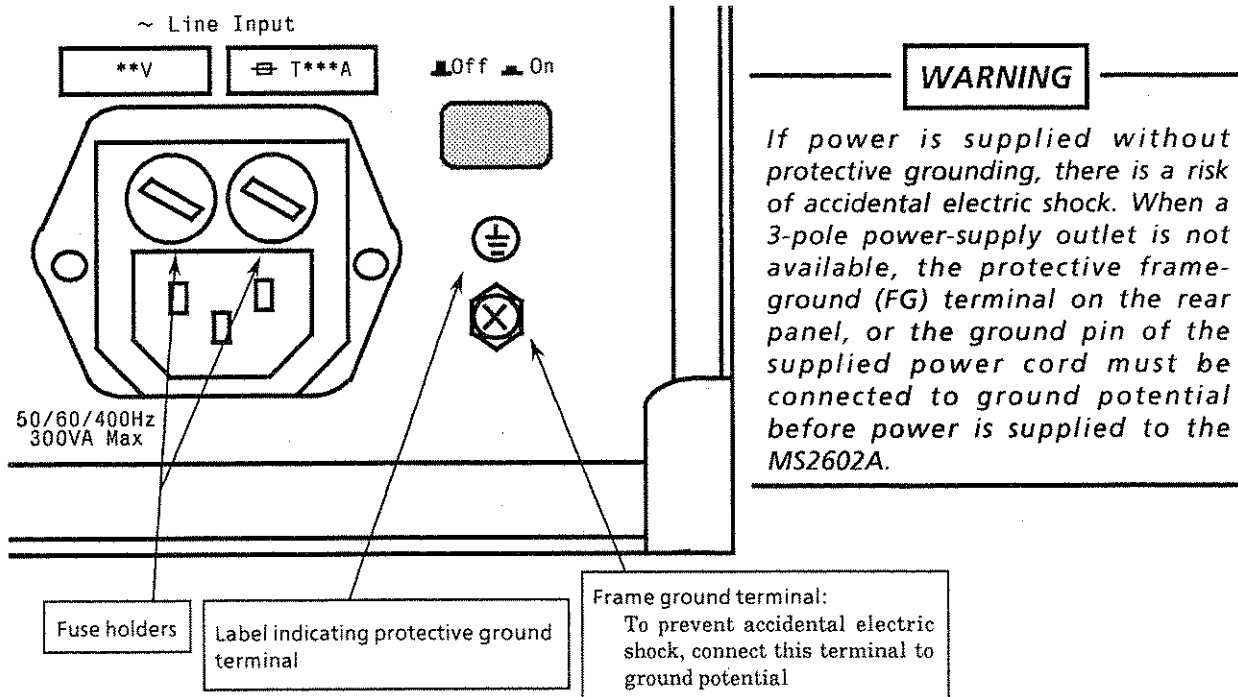

When there is no 3-pole ac power-supply outlet, the protective frame-ground (FG) terminal on the rear panel must be connected directly to ground potential.



## 2.4.2 Replacing fuse

---

### WARNING

---

- *If the fuses are replaced while power is being supplied, there is a serious risk of electric shock. Before replacing the fuses, set the power switch to OFF and remove the power cord from the power outlet.*
  - *If power is supplied without protective grounding, there is a risk of accidental electric shock. In addition, if the AC power supply voltage is unsuitable, there is a risk of the internal circuits of the MS2602A being damaged by the abnormal voltage. Before supplying power again after changing the fuses, check that the protective grounding described previously is still connected, and check that the AC power supply voltage is suitable. Then, set the power switch to ON.*
- 

---

### CAUTION

---

*When there are no supplied spare fuses, the replacement fuses must have the same rated voltage and current as the fuses in the fuse holders.*

- *If the replacement fuses are not of the same type, they may not fit correctly, there may be a faulty connection, or the time taken to for the fuses to blow may be too long.*
  - *If the voltage and current rating of the fuses is incorrect, when an abnormality occurs again, the fuses may not blow with a consequent risk of damage to the equipment by fire.*
-

The MS2602A with standard accessories has two spare \*\*\* A fuses. The fuses are mounted in the fuse holder as shown in the figure below and must be replaced if they blow. If the fuses must be replaced, locate and remedy the cause before replacing the blown fuses. In addition to this fuse replacement, make sure that each item shown in the table below is properly selected for the power supply system.

Power supply system	VOLTAGE SELECT	Line-voltage rating plate	Fuse rating plate	Fuse rating	Fuse name	Model/ Order No.
100 Vac	AC 100-120V	100 – 120V	T 6.3 A	6.3 A, 250V	T6.3A250V	F0012
200 Vac	AC 200-230V	200 – 230V	T 3.15 A	3.15 A, 250V	T3.15A250V	F0011

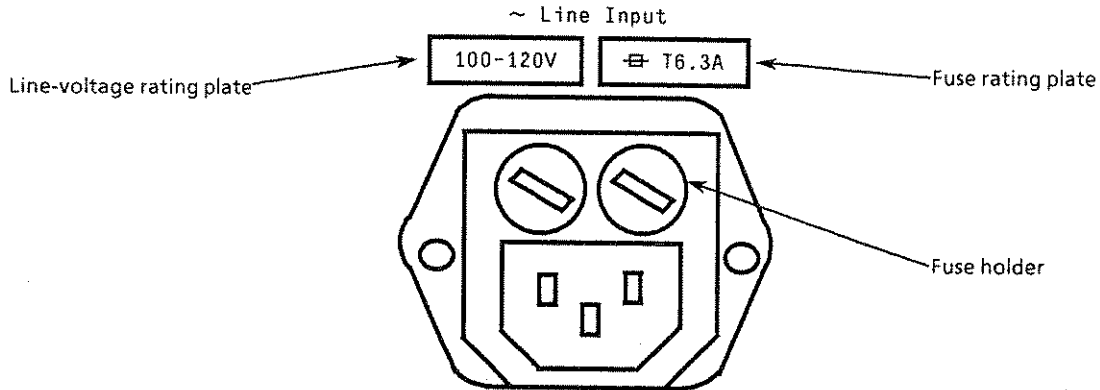

After performing the safety procedures described on the preceding page, replace the fuses according to the following procedure.

Step	Procedure
1	Set the front-panel [ Power ] switch to Stby and the rear-panel [ Line ] switch to OFF. Then, remove the power cord from the power-supply outlet.
2	Use a flat-bladed screwdriver to turn the fuse-holder cap counterclockwise. The cap and fuse are removed as a unit from the fuse holder.
3	Remove the fuse from the fuse cap and replace it with a spare fuse. (The direction does not matter.)
4	Return the fuse cap with fuse to the fuse holder and fasten it by turning it clockwise with the flat-bladed screwdriver.

## 2.5 Precautions for Handling Storage Media

---

**CAUTION**

---

*Storage media such as the plug-in memory card or floppy disk should never be removed from the equipment ( MS2602A / MC8104A ) while it is being accessed ( while the Busy lamp on the equipment is lit ), since this may damage the media.*

---

The MS2602A uses plug-in memory cards ( PMC ) as the storage media for data and programs. In addition, floppy disks ( in the MC8104A Data Storage Unit as a peripheral device ) can be used.

If an error is made in handling these storage media or an accident occurs, data may be lost. Anritsu recommends that you always back-up your data.

ANRITSU WILL NOT BE HELD RESPONSIBLE FOR LOST DATA.

Items that should be noted about handling floppy disks and PMCs are explained below.

### 2.5.1 Floppy disks

---

**CAUTION**

---

- *Store disks under the specified environmental conditions and do not use them in very dusty locations.*
  - *Do not expose disks to magnetic fields and do not bend them.*
- 

If the contents of the above CAUTION are not observed, reading and writing of floppy disks may be impossible so please pay attention to them.

## 2.5.2 Plug-in memory cards (PMC)

The following items are explained for plug-in memory cards ( PMCs ).

- Inserting PMC into MS2602A slot
- Precautions for handling PMC
- Using the cap
- Battery Installation and Replacement Method (Battery safety)
- Using the write-protection switch ( only for SRAM PMCs )

### (1) Inserting PMC into MS2602A slot

#### CAUTION

*If the PMC is forcibly inserted, the PMC connector pins may be damaged. Insert the PMC as shown in the diagram below.*

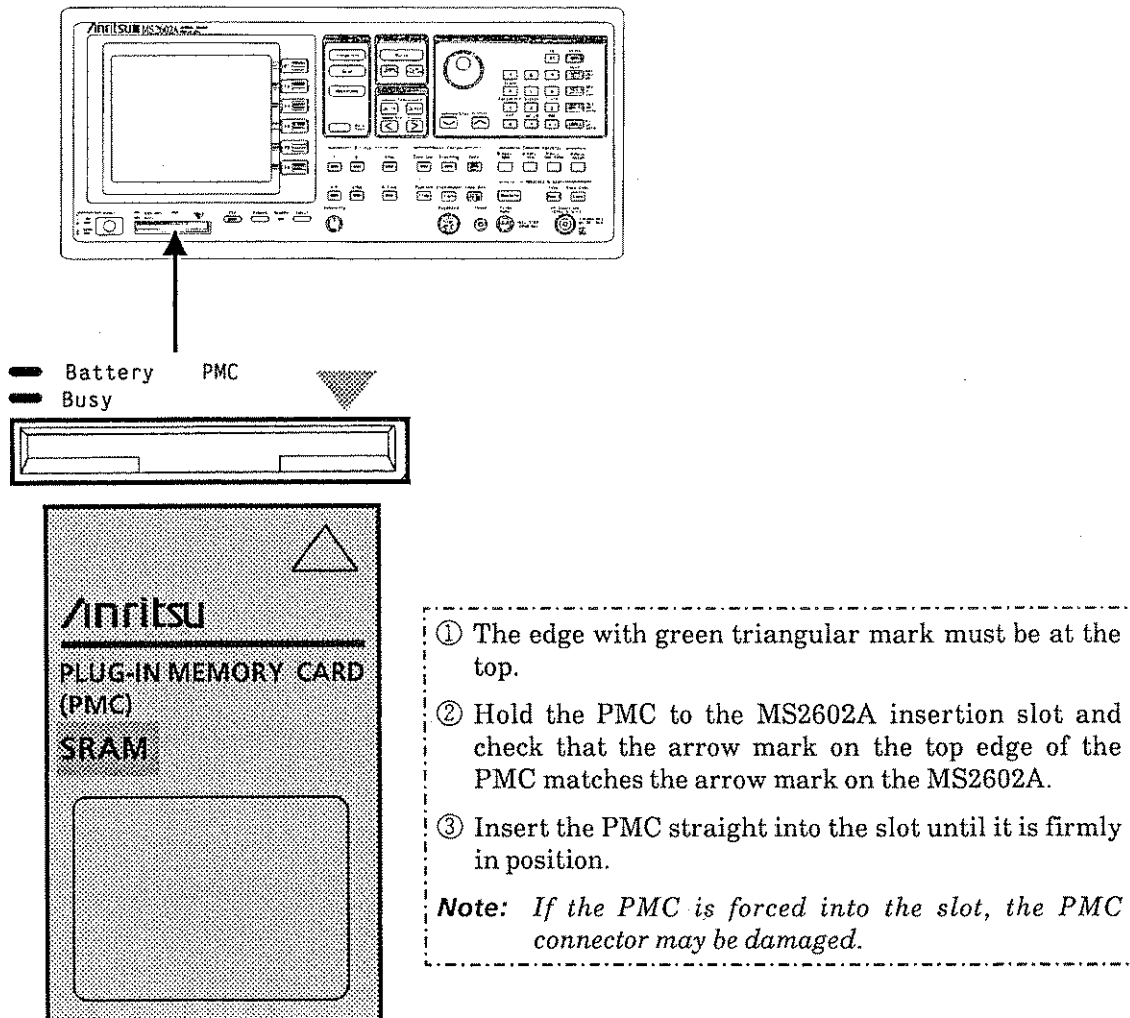

Insert the PMC into the MS2602A slot correctly according to the above procedure.

## (2) Precautions for handling PMC

- 1) Do not drop or bend the PMC or subject it to strong mechanical shock.
- 2) Do not let the PMC get wet.
- 3) Do not expose the PMC to high temperatures or humidity, or to direct sunlight.
- 4) Do not insert anything into the PMC connector.
- 5) Do not let foreign material or dust enter the PMC connector.
- 6) Do not insert anything other than the specified PMC into the PMC slot.
- 7) The 128, 256 and 512 KB PMCs are shipped without the battery installed so use them after installing the supplied battery.
- 8) The life of the PMC battery at normal temperature is shown in the table below. If this battery life is exceeded, saved data and programs may be lost. We recommend that the battery be replaced before the listed battery life expires.

As the following diagram shows, a line is provided on the rear side of the PMC for entry of the scheduled battery replacement date. After battery has been installed, we recommend that you refer to this table and enter the scheduled battery replacement data on the PMC.

PMC type	Memory capacity	Battery life	Battery
BS32F1-C	32 KB	5 years approx.	BR2325
BS64F1-C	64 KB	5 years approx.	
BS128F1-C	128 KB	4.3 years approx.	
BS256F1-C	256 KB	2.2 years approx.	
BS512F1-C	512 KB	1.1 years approx.	

After installing the battery, insert the scheduled battery replacement date on this line

**CAUTION**

- 電池寿命(32Kバイト): 約5年(常温)  
Battery life : About 5 years  
(at room temperature)
- 機器電源をONにして、プラグイン状態で電池を交換して下さい。  
Battery replacement must be done by inserting the card into the instrument while the power is on.
- 電池はBR2325を使用して下さい。  
Use only BR2325 battery.
- 強いショックを与えたり、折り曲げないこと。  
Do not drop or bend.
- 高温高湿・直射日光にさらさないこと。  
Do not expose to extreme temperature or wetness.

次回電池交換予定日  
Battery replacement Schedule  
Date : \_\_\_\_\_

**ANRITSU CORP. MADE IN JAPAN**

The MS2602A has a red 'Battery' lamp for monitoring the built-in battery voltage. When this lamp lights red, replace the discharged battery promptly.

### (3) Using the cap

Since the cap prevents the PMC from being inserted upside-down, it should be mounted whenever the PMC is used. However, it should be removed in the following cases:

- When the following type of PMC insertion slot is used, the cap should be removed.

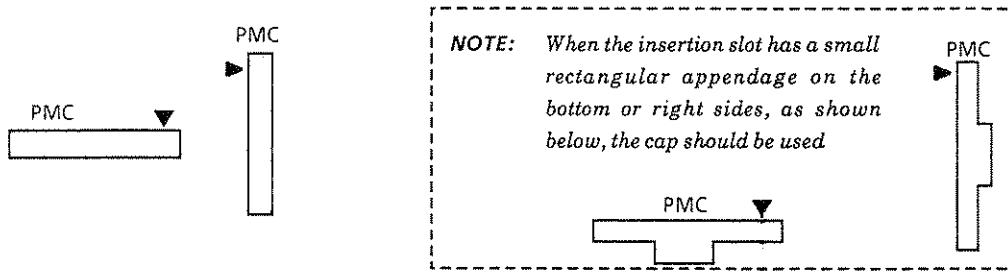

It is necessary to remove the cap when installing or replacing the battery.

#### [ Removing the cap ]

Position the PMC back-side up ( such that the CAUTION faces upwards ) so that the cap can be easily removed.

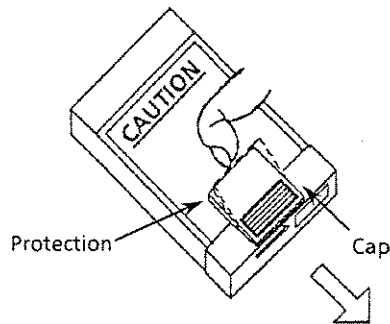

While slightly lifting the cap protection ( as indicated by the dotted line ), push the cap in the direction of the arrow

## (4) Battery Installation and Replacement Method

### ■ Installing the battery ( only for SRAM PMCs )

When using the PMC, be certain to install the lithium battery that has been included. When installing the battery, turn the PMC back-side up ( so that CAUTION faces upwards ), and follow this procedure:

- ① Take the cap off the PMC.
- ② Release the battery holder lock, and remove the battery holder.
- ③ Turn the lithium-battery so that the + side faces up, and install the battery in the battery holder.
- ④ Insert the battery holder into the PMC, and engage the battery holder lock. Then remount the cap.

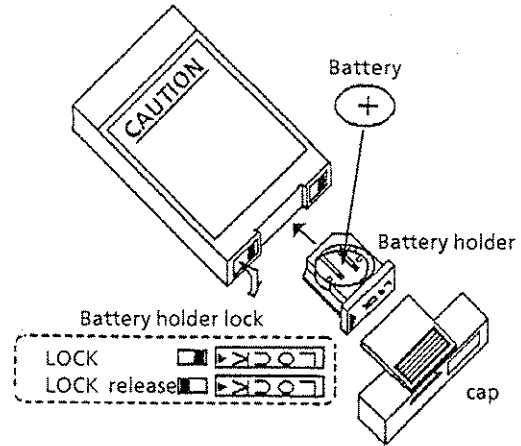

### ■ Replacing the battery ( only for SRAM PMCs )

When replacing the battery, first turn the instrument power ON, then mount the PMC in the instrument, before performing the following procedure:

( Attention: PMC data will be lost, if this procedure is not followed.)

Step	Procedure
1	Prepare the lithium battery.
2	Turn the instrument power ON.
3	Take the cap off the PMC, and mount the PMC in the instrument.( When mounting, align the ▼ marks. )
4	Release the battery holder lock.
5	Remove the battery holder, and replace the old battery with new one.
6	Reinsert the battery holder into the PMC, and engage the battery holder lock.
7	Take the PMC out of the instrument, and mount the cap.

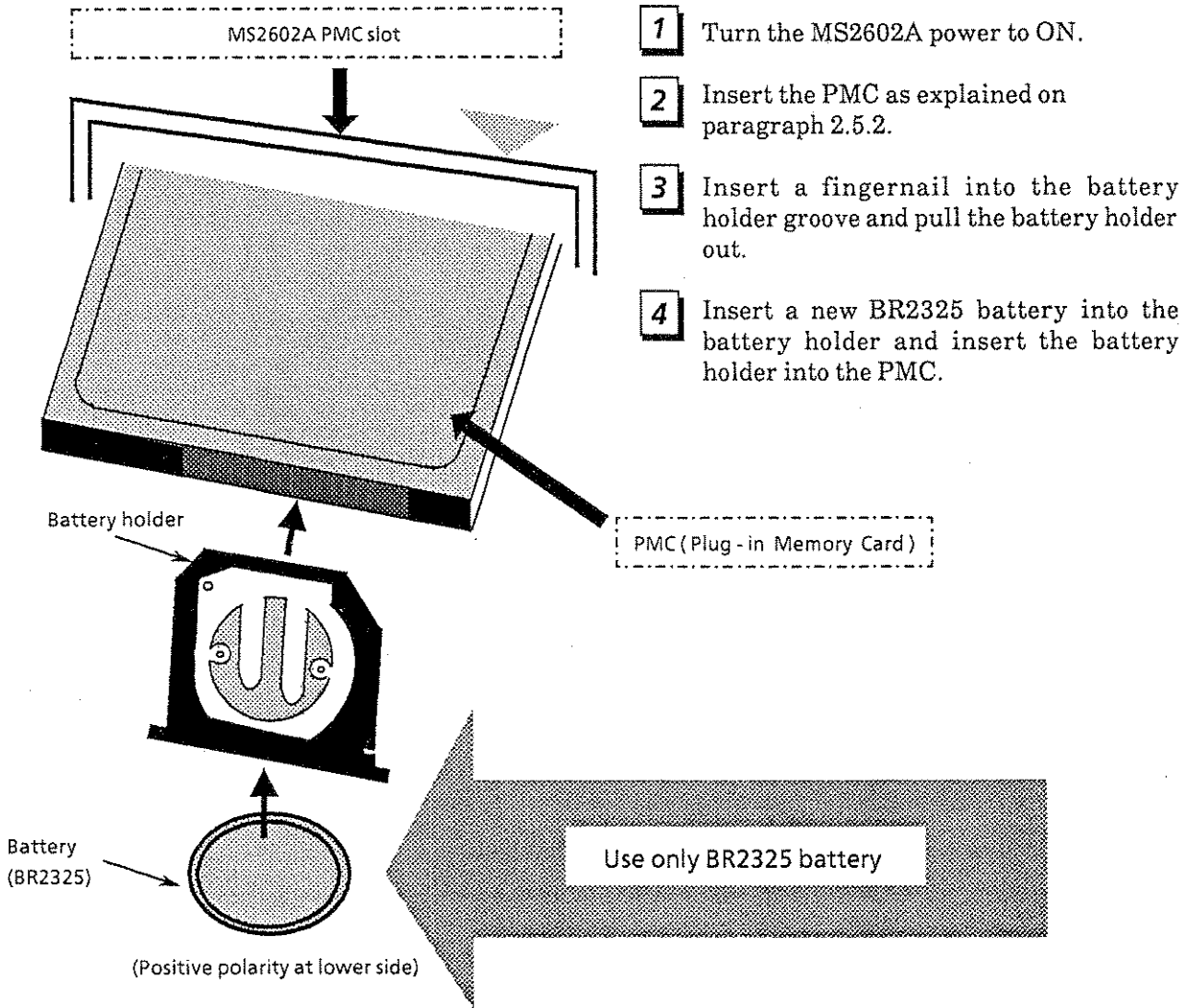

### ■ Locking Battery Holder

The PMC battery holder has a slide switch to lock it to PMC. To lock it, slide the switch to the left with the tip of a pencil etc.

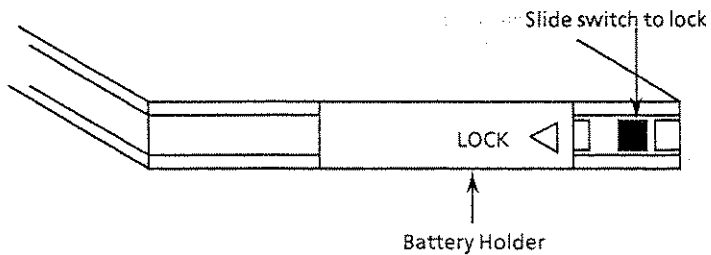



---

**WARNING**

---

**Battery safety**

- *When replacing the battery, make sure to use the BR2325 Lithium battery. If you use other type of battery, there is a risk explosion.*
  - *The BR2325 cannot be charged.*
  - *Insert the battery with the correct polarity (+ | -).*
- 

**(5) Using the write-protection switch ( only for SRAM PMCs )**

The write-protection switch has been preset at the factory to the “ OFF ” position. To enable write protection, move the switch to the ON position with a ball point pen.

If the software for the instrument performs write protection, set the write-protection switch to the “ OFF ” position.



( Blank )

## SECTION 3 PANEL DESCRIPTION

This section describes the front and rear panel features of the MS2602A.

The front and rear panel illustrations are shown in Appendix C at the back of this operation manual on fold-out page for easy reference while reading other sections.

### TABLE OF CONTENTS

3.1	Table of Front and Rear Panel Features .....	3-3
-----	--	-----

(Blank)

## SECTION 3 PANEL DESCRIPTION

### 3.1 Table of Front and Rear Panel Features

The front and rear panel illustrations are shown in Figs. 2 and 3 in Appendix C at the back of this operation manual. Controls and connector descriptions have index numbers that are linked to the panel illustrations. The following tables describe the control and connector functions.

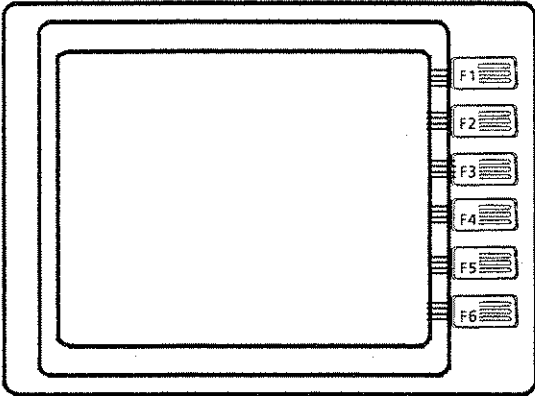
No.	Label	Explanation												
1		<p>The 400 × 600-dot 7-inch diagonal, monochrome CRT which displays the following items. Traces (graticules, markers, trace data, measurement data, etc) on the CRT are all displayed in green.</p> <ul style="list-style-type: none"> <li>■ Displays the information required for spectrum analysis together with signal waveform traces</li> <li>● Displays principal set values of parameter settings required for measurement</li> <li>● Digitally displays measured results executed with marker operations</li> <li>● Displays the procedure for setting parameter</li> <li>● Displays error messages</li> </ul>												
2	<p style="text-align: center;">GP-IB</p> <table border="1" style="width: 100%; border-collapse: collapse;"> <tr> <td style="padding: 2px;">ENTRY PORT1 MY ADDRESS: 1</td> <td style="text-align: center; vertical-align: middle;">F1</td> </tr> <tr> <td style="padding: 2px;">ENTRY PORT2 MY ADDRESS: 16</td> <td style="text-align: center; vertical-align: middle;">F2</td> </tr> <tr> <td style="padding: 2px;">ENTRY MC8104A ADDRESS: 19</td> <td style="text-align: center; vertical-align: middle;">F3</td> </tr> <tr> <td style="padding: 2px;">RS232C * (OPTION02)</td> <td style="text-align: center; vertical-align: middle;">F4</td> </tr> <tr> <td></td> <td style="text-align: center; vertical-align: middle;">F5</td> </tr> <tr> <td></td> <td style="text-align: center; vertical-align: middle;">F6</td> </tr> </table>	ENTRY PORT1 MY ADDRESS: 1	F1	ENTRY PORT2 MY ADDRESS: 16	F2	ENTRY MC8104A ADDRESS: 19	F3	RS232C * (OPTION02)	F4		F5		F6	<p>In Table 2 of Appendix C in this Operation Manual, the panel keys are listed in a function table corresponding to the soft keys. When one of these panel keys is pressed, the function menu corresponding to the [ F1 ] to [ F6 ] soft keys is displayed on the right of the screen. Then, press the soft key corresponding to the function menu, and the menu function is executed.</p> <p>&lt; Example: Checking the current GPIB address, then changing it 3 &gt;</p> <ol style="list-style-type: none"> <li>1. Press the TEN keys on the panel in order of [Shift] [ ● ] ( GP-IB ).</li> <li>2. On the right of the screen, the GPIB menu corresponding to the [ F1 ] to [ F6 ] keys is displayed as shown on the left.</li> <li>3. Check that the current GPIB address is 1; the [ F1 ] soft key label shows [ PORT1 MY ADDRESS: 1 ].</li> <li>4. Press the [ F1 ] soft key, and an address entry response is displayed in the communication field. Change the address value to 3 using the TEN keys numeric keypad.</li> </ol>
ENTRY PORT1 MY ADDRESS: 1	F1													
ENTRY PORT2 MY ADDRESS: 16	F2													
ENTRY MC8104A ADDRESS: 19	F3													
RS232C * (OPTION02)	F4													
	F5													
	F6													

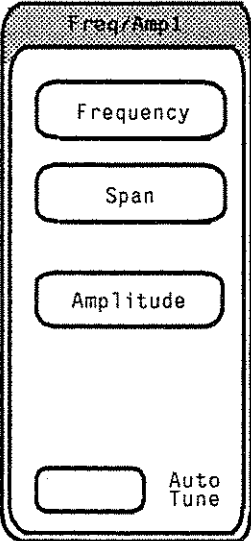
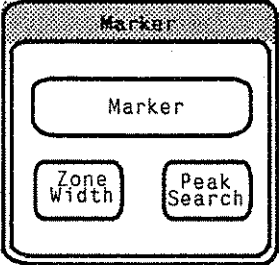

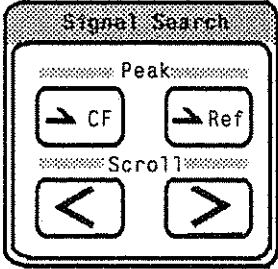
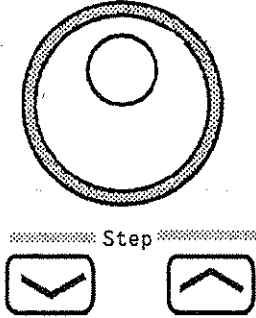

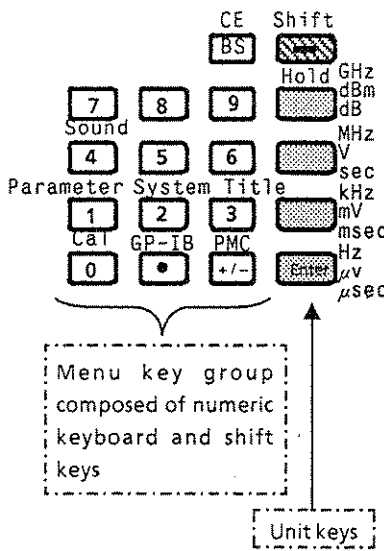
No.	Label	Explanation
3		<p><b>Freq/Ampl:</b> This section is used to enter the parameter data for frequency and level.</p> <ul style="list-style-type: none"> <li>• <b>[ Frequency ]:</b> When this key is pressed, the current CENTER FREQUENCY value is displayed in the communication field. Use the TEN keys, rotary knob, or [ √ ]/[ ^ ] keys to change the center frequency data. When the [ Frequency ] key is also pressed, the function menu for frequency setting is displayed on the right of the screen. From this menu, it possible to select the frequency setting mode, set the selected-mode frequency, or set the frequency step size using the [ √ ]/[ ^ ] keys.</li> <li>• <b>[ Span ]:</b> When this key is pressed, the current FREQUENCY SPAN value is displayed in the communication field. Use the TEN keys, rotary knob, or [ √ ]/[ ^ ] keys to change the frequency span data . When the [ Span ] key is also pressed, the function menu for frequency band is displayed on the right of the screen.</li> <li>• <b>[ Amplitude ]:</b> When this key is pressed, the current REFERENCE LEVEL value is displayed in the communication field. Use the TEN keys, rotary knob, or [ √ ]/[ ^ ] keys to change the reference level data. When the [ Amplitude ] key is also pressed, the function menu for level range setting such as reference level unit, vertical axis scale, and so on is displayed on the right of the screen.</li> <li>• <b>[ Auto Tune ]:</b> Automatically detects the maximum peak point within the preset frequency band ( BG band ) and moves the peak point to the horizontal axis center.</li> </ul>
4		<p><b>Marker:</b> This section is used to select and execute various marker functions ( marker position, peak search, marker mode, and zone marker ).</p> <ul style="list-style-type: none"> <li>• <b>[ Marker ]:</b> When this key is pressed, the current marker ZONE CENTER value is displayed in the communication field. Use the TEN keys, rotary knob, or [ √ ]/[ ^ ] keys to move the zone marker position. When the [ Marker ] key is also pressed, the function menu for the marker functions such as marker mode, marker-set parameters, and so on is displayed on the right of the screen.</li> </ul>

No.	Label	Explanation
4 (cont.)		<ul style="list-style-type: none"> <li>● [ Zone Width ]: When this key is pressed, the ZONE WIDTH of zone marker can be changed using the TEN keys, rotary knob, or [ √ ]/[ ^ ] keys. The zone width can be lengthened or shortened from the reference point of the zone center.</li> <li>● [ Peak Search ]: When this key is pressed, the marker moves to the maximum level of the currently-displayed spectrum. Select the appropriate function menu displayed on the right of the screen, then the marker moves to the next largest peak or smallest peak relative to the currently-detected peak.</li> </ul>
5	 <p>The diagram shows a rectangular menu titled "Signal Search". At the top, it says "Peak:" followed by a dotted line. Below this are two buttons: one with a right-pointing arrow and "CF", and another with a right-pointing arrow and "Ref". Below these is a dotted line with the word "Scroll". At the bottom are two buttons: one with a left-pointing arrow and one with a right-pointing arrow.</p>	<p><b>Signal Search:</b> This section is used to quickly and efficiently search for the point where a desired signal is obtained.</p> <ul style="list-style-type: none"> <li>● [ → CF ]: Searches for the maximum level signal frequency on the horizontal axis of the screen and sets its signal to the center.</li> <li>● [ → Ref ]: Searches for the maximum level signal on the horizontal axis of the screen and sets its signal to the reference level.</li> <li>● [ &lt; ] [ &gt; ]: When the [ &gt; ] key is pressed, the waveform being displayed is moved to the right; when the [ &lt; ] key is pressed, the waveform is moved to the left. The frequency width movement is specified by the frequency menu SCROLL STEP SIZE displayed when the [ Frequency ] key is pressed.</li> </ul>
6	 <p>The diagram shows a rotary knob with a central circle and an outer ring. Below it is a menu titled "Step" with two buttons: one with a downward-pointing chevron and one with an upward-pointing chevron.</p>	<ul style="list-style-type: none"> <li>● Rotary knob: Changes data for moving the marker, setting frequency and reference level in modes where data entry is permitted.</li> <li>● [ √ ] [ ^ ]: Steps up and down parameter data such as frequency, level, marker, and coupled function in modes where data entry is permitted.</li> </ul>



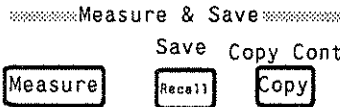
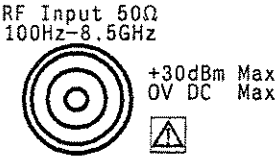

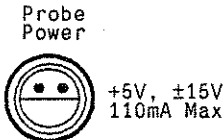

















No.	Label	Explanation
7		<p>These 18 keys including numeric keys, unit keys, BS ( Back Space ) key, and Shift key are called TEN keys for convenience.</p> <ul style="list-style-type: none"> <li>• [0]~[9],[•],[+/-]: Numeric keys used to set numeric data.</li> <li>• [ GHz/dBm/dB ] : These are unit keys and are used to complete numeric entries when pressed.</li> <li>• [ MHz/V/sec ]</li> <li>• [ kHz/mV/msec ]</li> <li>• [ Enter/Hz/μV/μsec ] The [ Enter ] key is used to complete the data entry without unit ( e.g. GPIB address etc ).</li> <li>• [ BS ]: This is a backspace key which erases the last character each time it is pressed, and is used to correct wrong spellings.</li> <li>• [ Shift ]: To execute the functions labelled with blue characters above the front panel keys, first press the [ Shift ] key, then press the appropriate blue character key for the desired function. The Shift key LED lights when the [Shift] key is pressed and goes off when the blue character key is pressed.</li> <li>• [ Cal ]: Displays the menu for correcting level and frequency errors. Press the [ Shift ] key, then the [ 0 ] key to display the menu. The menu also contains the 1<sup>-</sup> and 1<sup>+</sup> bands in which the pre-selector is used for band selection.</li> <li>• [ GP-IB ]: Displays the menu for setting the external interface conditions including the GPIB and other interfaces. Press the [ Shift ] key, then the [ • ] key to display the menu.</li> <li>• [ PMC ]: Displays the menu for managing the external and internal PMCs. Press the [ Shift ] key, then the [ + / - ] key to display the menu.</li> <li>• [ Parameter ]: Displays the menu for listing the MS2602A measurement conditions and the internal parameters settings. Press the [ Shift ] key, then the [ 1 ] key to display the menu.</li> <li>• [ System ]: Displays the menu for setting the MS2602A operating conditions such as sweep time settings, data point selection, and other settings. Press the [ Shift ] key, then the [ 2 ] key to display the menu.</li> </ul>



No.	Label	Explanation								
7 (cont.)		<ul style="list-style-type: none"> <li>• [ Title ]: Displays the menu for selecting the title ON / OFF, characters, and others displayed at the top of the graticule. Press the [ Shift ] key, then the [ 3 ] key to display the menu.</li> <li>• [ Sound ]: Displays the menu for selecting the modulation mode and volume control during modulated wave reception. Press the [ Shift ] key, then the [ 4 ] key to display the menu. When a modulated wave ( AM or FM ) is received, the MS2602A can detect and monitor voice-modulated signals. The voice can be heard from a built-in speaker, and earphone or an external speaker connected to the phone terminal.</li> </ul>								
8	<p style="text-align: center;">◆◆◆ Coupled Function ◆◆◆</p> <table style="margin-left: auto; margin-right: auto; border-collapse: collapse;"> <tr> <td style="text-align: center;">•Auto RBW</td> <td style="text-align: center;">•Auto VBW</td> <td style="text-align: center;">•Auto Swp Time</td> <td style="text-align: center;">•Auto Atten</td> </tr> <tr> <td style="text-align: center;">□</td> <td style="text-align: center;">□</td> <td style="text-align: center;">□</td> <td style="text-align: center;">□</td> </tr> </table>	•Auto RBW	•Auto VBW	•Auto Swp Time	•Auto Atten	□	□	□	□	<p><b>Coupled Function:</b> In an initial setting state, the four control settings between RBW ( Resolution Bandwidth ), VBW ( Video Bandwidth ), Swp Time ( Sweep Time ), and Atten ( Attenuator ) are set to AUTO mode so that the MS2602A itself can select optimum control settings automatically. In AUTO mode, each lamp over the four keys lights. If the coupled function is executed in manual mode as follows, then the lamps go off.</p> <ul style="list-style-type: none"> <li>• [ RBW ]: Displays the current RBW values in the communication field when this key is pressed. Use the TEN keys, rotary knob, or [ √ ]/[ ^ ] keys to change the data.</li> <li>• [ VBW ]: Displays the current VBW values in the communication field when this key is pressed. Use the TEN keys, rotary knob, or [ √ ]/[ ^ ] keys to change the data.</li> <li>• [ Swp Time ]: Displays the current Sweep Time values in the communication field when this key is pressed. Use the TEN keys, rotary knob, or [ √ ]/[ ^ ] keys to change the data.</li> <li>• [ Atten ]: Displays the current Attenuation values in the communication field when this key is pressed. Use the TEN keys, rotary knob, or [ √ ]/[ ^ ] keys to change the data.</li> </ul>
•Auto RBW	•Auto VBW	•Auto Swp Time	•Auto Atten							
□	□	□	□							



No.	Label	Explanation
9	 <p>Measure &amp; Save</p> <p>Measure Recall Copy Copy Cont</p>	<ul style="list-style-type: none"> <li>• [ Measure ]: Press this key to display the menu for optimizing measurements for various applications including frequency, noise, distortion, and other measurements. When this [ Measure ] key is pressed, the menu measurement items are displayed on the right of the screen.</li> <li>• [ Recall ]: Displays the menu for recalling setting parameters or waveform data from internal memory, PMC, or floppy disk.</li> <li>• [ Save ]: Displays the menu for saving setting parameters or waveform data to internal memory, PMC, or floppy disk. Press the [ Shift ] key, then the [ Recall ] key to display the menu.</li> <li>• [ Copy ]: Executes direct plotting in accordance with the conditions set by the [ Shift ] and [ Copy Cont ] keys.</li> <li>• [ Copy Cont ]: Displays the menu for setting the direct plotting conditions. Press the [ Shift ] key, then the [ Copy ] key to display the menu. The menu is used to select the printer and plotter models, paper size, and other items.</li> </ul>
10	 <p>RF Input 50Ω 100Hz-8.5GHz</p> <p>+30dBm Max 0V DC Max</p>	<p>Applies the signal to be measured to the RF Input N type connector. Signal with a frequency range of 100 Hz to 8.5 GHz and measurement level of -135 to +30 dBm can be measured. Since the input circuit is not protected, applying an excessive input signal which exceeds +30 dBm or 0 Vdc may burnout the input attenuator or input mixer.</p> <p>The  alert symbol is a warning not to apply such an excessive input signals.</p>
11	 <p>Probe Power</p> <p>+5V, ±15V 110mA Max</p>	<p>Supplies power to a probe, such as the Tektronix P6201 high impedance probe ( sold separately ).</p>
12	 <p>Phone</p>	<p>Outputs an AM or FM demodulation signal from the Phone terminal by pressing the [ Shift ] and [ Sound ] keys. The sound from the built-in speaker cuts off when an earphone ( 3.5 Ø miniature plug ) is plugged into this Phone terminal.</p>
13	 <p>Keyboard</p>	<p>Connector for connecting the G0044 PTA keyboard ( sold separately ) to control PTA. The keyboard can also be used to enter title characters.</p>

No.	Label	Explanation
14	<p style="text-align: center;">~~~~~ Sweep Control ~~~~~</p> <p style="text-align: center;">Zone Swp   Tracking   Gate</p> <div style="display: flex; justify-content: space-around; align-items: center;"> <div style="border: 1px solid black; width: 30px; height: 15px; background-color: black;"></div> <div style="border: 1px solid black; width: 30px; height: 15px; background-color: black;"></div> <div style="border: 1px solid black; width: 30px; height: 15px; background-color: black;"></div> </div> <p style="text-align: center;">Restart   Continuous   Free Run</p> <div style="display: flex; justify-content: space-around; align-items: center;"> <div style="border: 1px solid black; padding: 2px;">Stop</div> <div style="border: 1px solid black; padding: 2px;">Single</div> <div style="border: 1px solid black; padding: 2px;">Trig</div> </div>	<p><b>Sweep Control:</b> This section is used to set the MS2602A sweep conditions ( trigger, gate, zone sweep, tracking, and others ).</p> <ul style="list-style-type: none"> <li>• <b>[ Zone Swp ]:</b> Pressing this key provides zone sweep mode, which sweeps only the frequency range encircled by the zone marker. To release the zone sweep mode, press the [ Zone Swp ] key again. The LED on top of the key lights orange during zone sweep.</li> <li>• <b>[ Tracking ]:</b> Pressing this key provides tracking mode, which tracks the center frequency to the frequency change. To release the tracking mode, press the [ Tracking ] key again. The LED on top of the key lights orange during tracking mode.</li> <li>• <b>[ Gate ]:</b> Menu key for the gate used to analyze intermittent signals such as pulse-modulated waves and burst waves. The LED on top of the key lights orange during tracking mode.</li> <li>• <b>[ Stop ]:</b> Stops the sweep operation under sweep.</li> <li>• <b>[ Restart ]:</b> Restarts the sweep stopped by pressing the [ Stop ] key. Press the [ Shift ] key, then [ Stop ] key to restart.</li> <li>• <b>[ Single ]:</b> Executes a single sweep each time the [ Single ] key is pressed.</li> <li>• <b>[ Continuous ]:</b> Executes continuous sweep. Press the [ Shift ] key, then [ Single ] key. The MS2602A initially operates in continuous sweep mode.</li> <li>• <b>[ Trig ]:</b> Pressing this key sets the sweep-starting conditions to TRIGGERED. The sweep-starting mode is determined in accordance with the trigger conditions set by the function menus displayed on the right of the screen. Four types of trigger source can be selected: VIDEO, LINE, EXT, and TV.</li> <li>• <b>[ Free Run ]:</b> Pressing the [ Shift ] key, then the [ Trig ] key sets the sweep-starting condition to FREE RUN. The sweep-start condition is initially set to FREE RUN.</li> </ul>

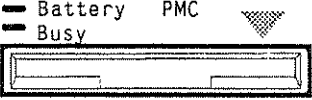
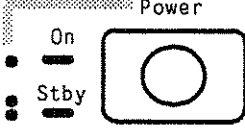
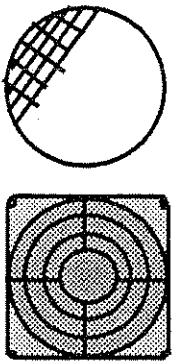
No.	Label	Explanation												
15	<p style="text-align: center;">Display</p> <table style="width: 100%; text-align: center;"> <tr> <td>A</td> <td>B</td> <td>Time</td> </tr> <tr> <td></td> <td></td> <td></td> </tr> <tr> <td>A/B</td> <td>A/BG</td> <td>A/Time</td> </tr> <tr> <td></td> <td></td> <td></td> </tr> </table>	A	B	Time				A/B	A/BG	A/Time				<p>This section is used to select the display mode for tracing a waveform on the screen. There are four types of display modes: BG, A, B, and Time. Either one or two types of waveform together can be displayed.</p> <ul style="list-style-type: none"> <li>• [A]: Displays Trace A alone. MAX / MIN HOLD, AVERAGING, DET MODE switching, and others can then be set using the function menus displayed on the right of the screen.</li> <li>• [B]: Displays Trace B alone. The same functions as for key [ A ] can be set using the function menus displayed on the right of the screen. ( The frequency relationship between Trace A and Trace B is the same. )</li> <li>• [Time]: Displays the time-domain waveform of the center frequency on a frequency spectrum waveform. Like the [ A ] and [ B ] keys, functions can be set using the function menus.</li> <li>• [A / B]: Simultaneously displays Trace A and Trace B.</li> <li>• [A / BG]: Detects the desired signal from a wide frequency range by simultaneously displaying Trace A and BG ( Background ).</li> <li>• [A / Time]: Simultaneously displays Trace A and the time-domain waveform of the center frequency of Trace A.</li> </ul>
A	B	Time												
														
A/B	A/BG	A/Time												
														
16	<p style="text-align: center;">Intensity</p> 	<p>Controls the brightness of the entire screen. Turning the knob clockwise brightens the screen; turning the knob counterclockwise darkens the screen.</p>												
17	<p style="text-align: center;">Remote    Local</p> 	<p>The Remote lamp comes on when the MS2602A is placed in remote mode to control the GPIB using software. Provided that this remote mode is not RWLS ( Remote With Lockout Status ), the MS2602A can be switched from remote mode to local mode and the lamp goes off when the [ Local ] key is pressed. If the remote mode is RWLS, the MS2602A cannot be returned to local mode even if the [ Local ] key is pressed. Conversely, it is impossible to switch from local mode to remote mode by using the [ Local ] key.</p>												
18	<p style="text-align: center;">Preset</p> 	<p>Initializes the MS2602A panel function parameters to a known, preset value regardless of their current values, except for some conditions such as interface conditions and system settings.</p>												
19	<p style="text-align: center;">PTA</p> 	<p>Displays the PTA function menus on the right of the screen and the LED on top of the PTA key lights when the [ PTA ] key is pressed.</p>												

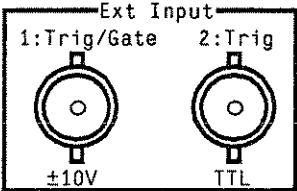
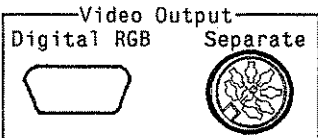
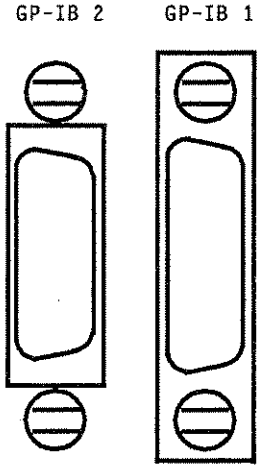
No.	Label	Explanation
20		<p><b>PMC ( Plug - in Memory Card ) slot:</b>            Plug the PMC into this slot with the PMC side facing the arrow shown on the left. The PMC is used as an external memory. It is also used as a PTA program memory or a data memory.</p> <ul style="list-style-type: none"> <li>● <b>Battery:</b> This warning lamp indicates the battery life built in the PMC while the SRAM type PMC is plugged into the PMC slot. When the Battery lamp lights red, it indicates that the battery has run out. Replace the battery with the PMC plugged into the slot.</li> <li>● <b>Busy:</b> The Busy lamp remains lit while the PMC is being accessed during reading and writing data from and to the MS2602A CPU.            Do not unplug PMC during access.</li> </ul>
21		<p>Switch for turning on and off the power to the MS2602A only when the rear-panel power switch ( No. 26 ) is ON.</p> <ul style="list-style-type: none"> <li>● <b>On:</b> When this button is pressed in while the rear panel power switch is ON, the power is turned on and the orange ON lamp lights. Power is supplied to all the MS2602A circuits and the MS2602A is then ready to be used.</li> <li>● <b>Stby:</b> When this button is pressed again during the power-on state, it pops out to the standby position. If the rear panel power switch is on, power is then supplied only to the internal reference crystal oscillator circuit and the green Stby lamp lights.</li> </ul>
22		<p>Fan for exhausting the heat generated inside the MS2602A to outside.</p> <p>Allow a clearance of 10 cm or more between the fan and nearby objects.</p>

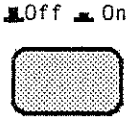
No.	Label	Explanation
23		<p><b>Ext Input:</b> This section is used for connectors to input external trigger signals used when the trigger source is set to EXT or the gate function is set to ON.</p> <ul style="list-style-type: none"> <li>• <b>1: Trig / Gate:</b> Connector for inputting an external trigger signal used when the external trigger input is set to INPUT 1: Trig / Gate ( ± 10 V ). The connector is also used for inputting a gate trigger signal when the gate function is set to ON.</li> <li>• <b>2: Trig:</b> Connector for inputting an external trigger signal when the external trigger input is set to INPUT 2: Trig ( TTL ).</li> </ul>
24		<p><b>Video Output:</b> This section is used for connectors to output screen information to an external monitor or video plotter.</p> <ul style="list-style-type: none"> <li>• <b>Digital RGB:</b> Connects a color monitor with the Digital RGB input. Six colors are used for the following display items: <ul style="list-style-type: none"> <li>Scale ..... Red</li> <li>Marker ..... Purple</li> <li>Text ..... Pale blue</li> <li>Trace A ..... White</li> <li>Trace B, BG, Time ..... Yellow</li> <li>PTA screen ..... Green</li> </ul> </li> <li>• <b>Separate:</b> Used for hard-copying using the UA-455A / VP-1500 II video printer with a separate video signal input.</li> </ul>
25		<p>The MS2602A has two types of GPIB interface: GP-IB 1 and GP-IB 2.</p> <p>For the GP-IB 1, connect the GPIB cable to the right connector, and for the GP-IB 2, connect the GPIB cable to the left connector.</p> <ul style="list-style-type: none"> <li>• <b>GP-IB 1:</b> Used for connecting a bus so that the MS2602A can be used as a talker or listener under an external system controller. The 13 characters from SH1 to C24 beside the connector indicate the GP-IB 1 interface functions ( subset ).</li> <li>• <b>GP-IB 2:</b> Used for connecting a bus so that the MS2602A can be used as a system controller to control other devices using a PTA program. The 13 characters from SH1 to C28 beside the connector indicate the GP-IB 2 interface functions ( subset ).</li> </ul>

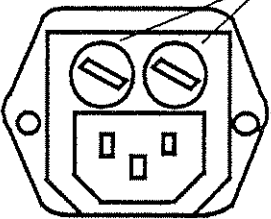
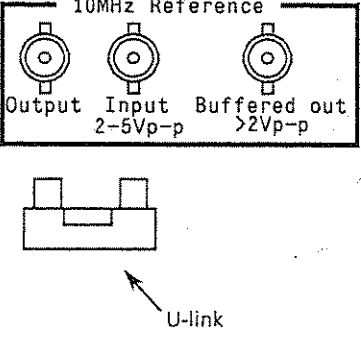
No.	Label	Explanation
26		<p>Line AC power switch, which is usually used in the power-on mode.</p> <ul style="list-style-type: none"> <li>• <b>On:</b> When this button is pressed in, the AC line is set to ON. If the front panel [ Power ] switch ( No.21 ) is ON, power is supplied to all the MS2602A circuits and the MS2602A is ready to be used. If the front panel [ Power ] switch is set to Stby, then power is supplied only to the internal reference crystal oscillator circuit, so that the reference crystal oscillator oven is pre-heated and the Stby lamp on the front panel is lit.</li> <li>• <b>Off:</b> When this button is popped out by being pressing in the ON state, the AC line is set to OFF even if the front panel [ Power ] switch is ON.</li> </ul>
27		<p>This terminal is connected to earth potential to prevent electric shocks. This is called the frame ground terminal-FG ( Frame Ground ).</p>
28		<p>Fuse capsules AC power inlet. Plug in the supplied power cord here.</p> <p>The T mark indicates the fuse characteristics. It means that there is a fixed time lag before the fuse blows. This fuse meets the IEC standards. For further details, refer to IEC Pub.127 sheet III.</p>
29		<p><b>10MHz Reference:</b> This section contains connectors used for synchronizing the MS2602A reference frequency with an external reference frequency or synchronizing other instruments with the MS2602A.</p> <ul style="list-style-type: none"> <li>• <b>Output:</b> Outputs a 10 MHz, TTL level signal from the internal reference crystal oscillator.</li> <li>• <b>Input:</b> Used to input the signal from an external reference oscillator. When the internal reference crystal oscillator is used, the Input connector is connected by the U-link with the Output connector as shown in the figure.</li> <li>• <b>Buffered out:</b> Outputs externally the reference signal via the buffer.</li> </ul>

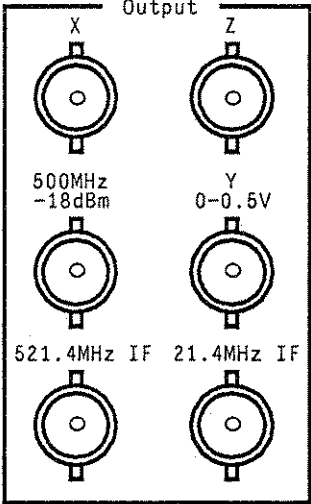
No.	Label	Explanation
30	 <p>The diagram shows six circular output connectors arranged in two columns. The top row has 'X' on the left and 'Z' on the right. The middle row has '500MHz -18dBm' on the left and 'Y 0-0.5V' on the right. The bottom row has '521.4MHz IF' on the left and '21.4MHz IF' on the right. The word 'Output' is centered above the top two connectors.</p>	<p><b>Output:</b> This section contains the X, Y, and Z axes output connectors used to drive the X-Y recorder, the IF output connector for using MS2602A as a converter, and the 500MHz signal output connector used for checking.</p> <ul style="list-style-type: none"> <li>• <b>X:</b> Outputs the X axis signal proportional to the swept voltage in the range of 0 V at the left end to 10 V at the right end.</li> <li>• <b>Y:</b> Outputs the Y axis signal proportional to the video detection voltage in the range of 0 V at the lower end to 0.5 V at the upper end.</li> <li>• <b>Z:</b> Outputs the signal in synchronization with the sweep in the TTL level. <ul style="list-style-type: none"> <li>Being swept ..... Low level</li> <li>Not being swept ..... High level</li> </ul> </li> <li>• <b>500MHz:</b> Used as a frequency signal source to check the instrument. The 500 MHz signal in synchronization with the reference input signal is output at approx. +18 dBm (50 Ω terminated).</li> <li>• <b>521.4MHz IF:</b> Outputs a 521.4 MHz IF signal. (Output level = Input level + 5 dB - Input attenuator setting value)</li> <li>• <b>21.4MHz IF:</b> Outputs a 21.4 MHz IF signal. This signal is bandwidth-limited by the setting value of RBW and logarithm-compressed during log-scale. The output level is more than -10 dBm at the top graticule.</li> </ul>



## SECTION 4

# BASIC OPERATING INSTRUCTIONS

This section explains the basic operation of the MS2602A for novice MS2602A Spectrum Analyzer operations. The operation range is confined to the basic items that allow quick and simple confirmation of the basic operation and basic functions of the MS2602A.

For more details, refer to the separate Operation Manual ( Detailed Operations ).

## TABLE OF CONTENTS

4.1	Initial Power ON .....	4-3
4.2	Preparation for Check-Signal Measurement .....	4-6
4.2.1	500 MHz Output and RF Input connection .....	4-6
4.2.2	Initial CRT display .....	4-7
4.3	Check-Signal Level and Frequency Measurement .....	4-8
4.3.1	Center frequency setting .....	4-8
4.3.2	Frequency span setting .....	4-9
4.3.3	Reference level setting .....	4-10

(Blank)

# SECTION 4 BASIC OPERATING INSTRUCTIONS

## 4.1 Initial Power ON

The MS2602A has two power switches: a front-panel [ Power On / Stby ] switch and a rear-panel [ LINE On / Off ] switch.

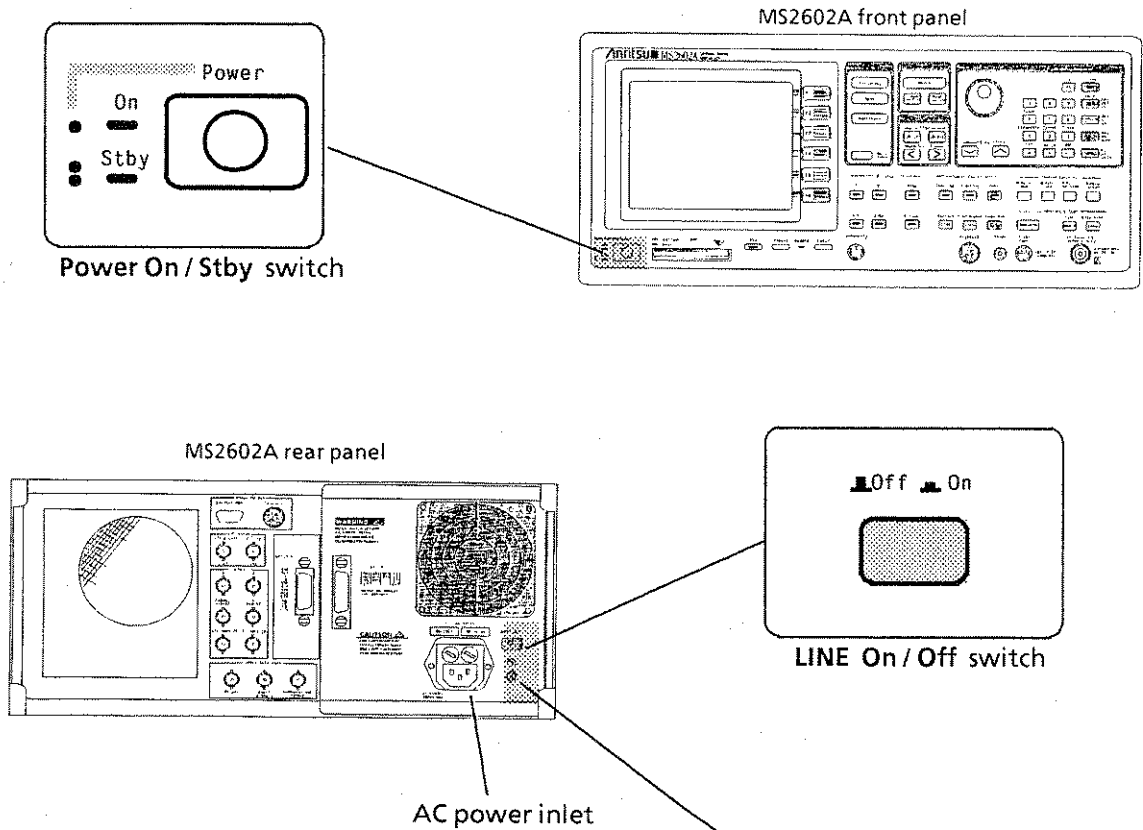

### WARNING

Turning the power on without protective grounding may result in injury from an accidental electric shock. When a 3-pole ( grounded 2-pole type ) power outlet is not available, before supplying power to the MS2602A, always connect the rear-panel frame ground ( FG ) terminal or power-cord ground line to ground potential.

Frame ground terminal:  
Connect this terminal to ground potential to prevent an accidental electric shock hazard

## CAUTION



If the AC line voltage is unsuitable, the MS2602A may be damaged by an abnormal voltage. Before turning on the power, confirm that the AC line voltage is the rated value \*\* Vac.

In normal use, to warm-up the internal reference oscillator, leave the [ LINE On / Off ] switch in the On position with the power cord connected to the MS2602A AC power inlet and line power outlet, and turn on the power with the front-panel [ Power On / Stby ] switch only.

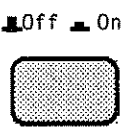
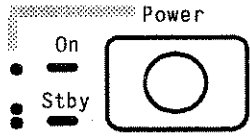
The procedure described below is for initial powering-up to normal use through internal reference oscillator warm-up.

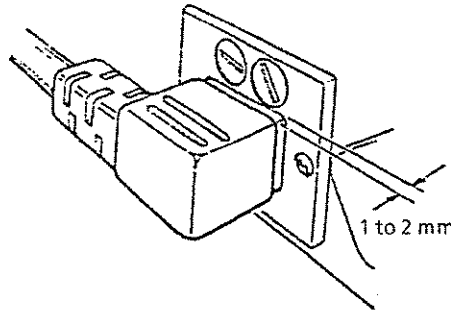
Step	Action	Verification
1	Ground the rear-panel frame ground terminal.	<ul style="list-style-type: none"><li>• When a 3-pole power cord with ground terminal is used, this grounding is unnecessary.</li></ul>
2	Check that the AC line voltage from the AC line outlet is correct.	<ul style="list-style-type: none"><li>• The allowable AC line voltage range is 100 to 120 Vac ( for 100 Vac system ) or 200 to 230 Vac ( for 200 Vac system ).</li></ul>
3	 Set the rear-panel [ Line On / Off ] switch to Off.	<ul style="list-style-type: none"><li>• When this button is depressed, the AC line is set to On. To turn the line Off, press the button again so that it pops out.</li></ul>
4	 Set the front-panel [ Power On / Stby ] switch to Stby.	<ul style="list-style-type: none"><li>• When this button is depressed, the power is set to On. To turn the power Off, press the button again so that it pops out.</li></ul>
5	Insert the power cord into the rear-panel power inlet.	<ul style="list-style-type: none"><li>• Insert the male end of the power cord firmly so that the gap is about 1 to 2 mm as shown in the figure below.</li></ul>
6	Plug the power cord plug into the AC line outlet.	
7	Check that the rear-panel 10 MHz Reference Output connector and Input connector are connected with the U-link.	

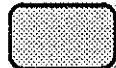
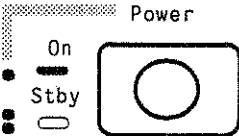

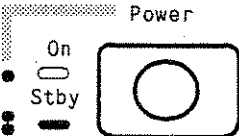
Step	Action	Verification
8	 <p>Set the rear-panel [ Line On / Off ] switch to On.</p>	<ul style="list-style-type: none"> <li>• The front-panel [ Power ] switch Stby lamp lights.</li> <li>• Warming-up of the internal reference crystal oscillator starts.</li> </ul> 
9	 <p>Set the front-panel [ Power On / Stby ] switch to On.</p>	<ul style="list-style-type: none"> <li>• The front-panel [ Power ] switch On lamp lights and the standby lamp goes Off.</li> <li>• Power is supplied to all the MS2602A circuits and the MS2602A enters the ready state.</li> </ul> 

## 4.2 Preparation for Check-Signal Measurement

The check signal of this analyzer is output from the 500 MHz Output connector of the rear panel. The procedure for measuring the fundamental frequency and its level of this check signal is described below. To make this measurement, it is first necessary to prepare for check signal display on the CRT screen. To prepare for measurement, execute the followings.

- ① Connect the 500 MHz Output connector to RF Input.
- ② Turn on power.

### 4.2.1 500 MHz Output and RF Input connection

#### ■ Equipment required for measurement

Standard furnished 50  $\Omega$  coaxial cable ..... BNC-P · RG-55 / U · N-P

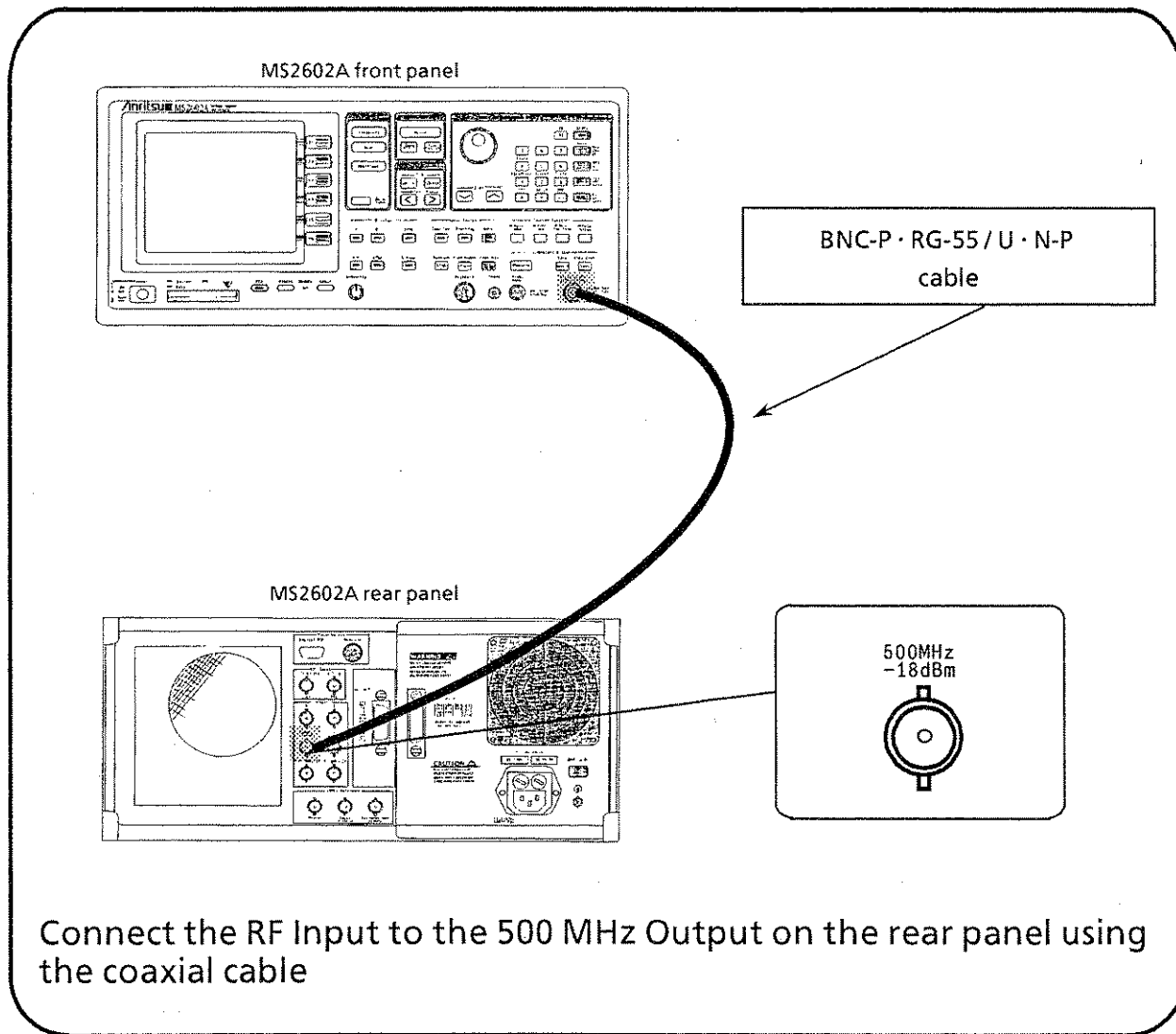

## 4.2.2 Initial CRT display

The CRT screen display appears as shown below when the power is first turned on after delivery. This is the initial CRT screen display. If this CRT screen display is desired after several panel operations, press the [Preset] key.

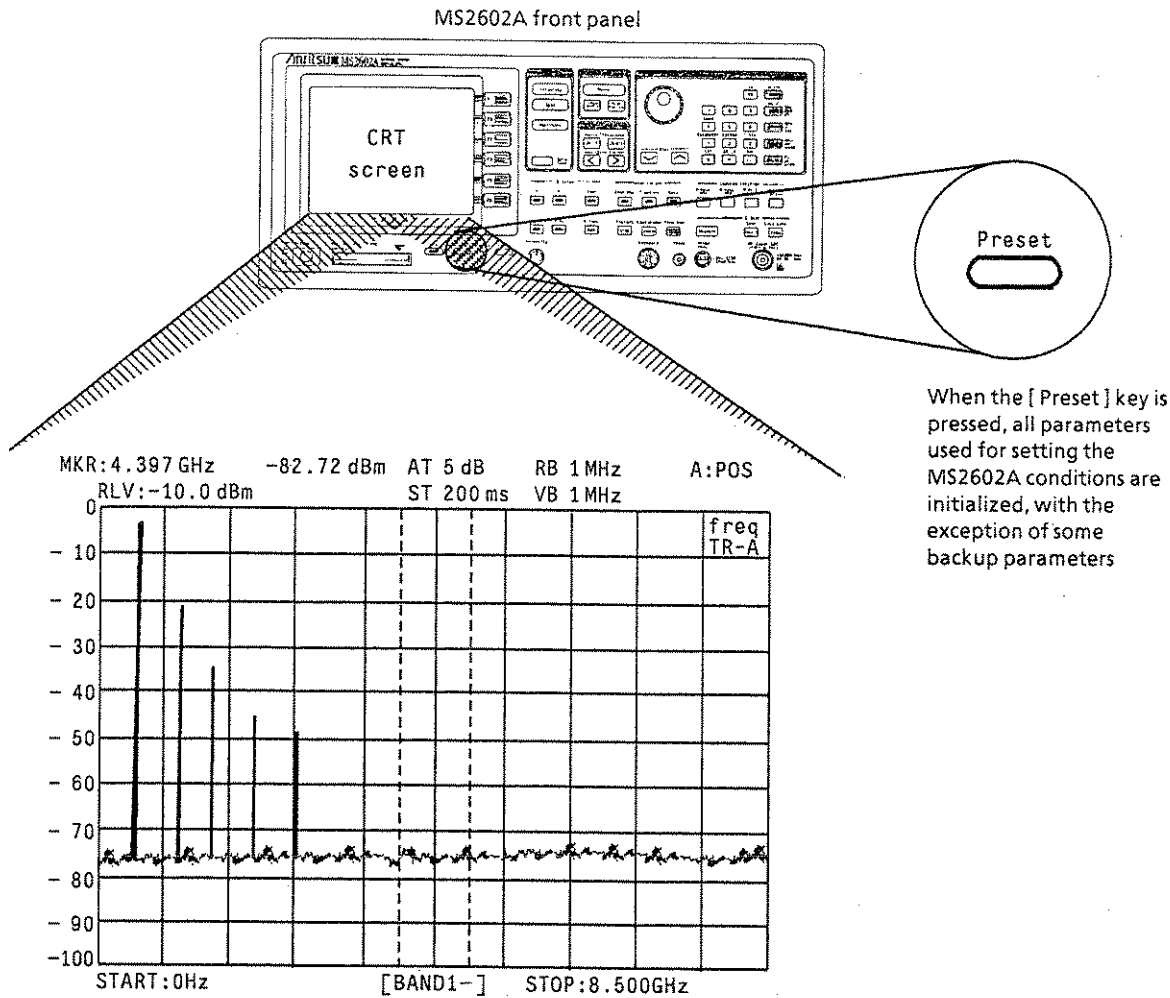

As shown on the lower end of the CRT screen, the initial sweep band is START: 0 Hz to STOP: 8.5 GHz. At this time, the signal applied to the RF Input connector is check signal 500 MHz, the 500 MHz signal response appears on the CRT screen.

### 4.3 Check-Signal Level and Frequency Measurement

Preparation for 500 MHz check signal measurement is now finished, so proceed with measurement. Operation is finished with the following three steps, and the objective 500 MHz signal level and frequency can be directly read from the CRT screen.

- Step 1. Center frequency setting
- Step 2. Frequency span setting
- Step 3. Reference level setting

#### 4.3.1 Center frequency setting

MS2602A front panel

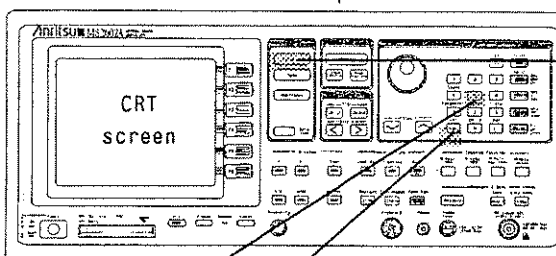

**1** Press the header key Frequency

- The current center frequency 4.25 GHz is displayed in the communication area at the lower end of the CRT screen.

CENTER FREQUENCY = 4.250 000 000GHz

**2** 5 0 0

Input 500 by numerical.

- The current input data 500 is shown in the communication area.

**3** Press MHz V sec key.

- 500 MHz is displayed in the communication area and at upper left above, and center frequency has been changed to 500 MHz. ( See following figure. )

Function Menu

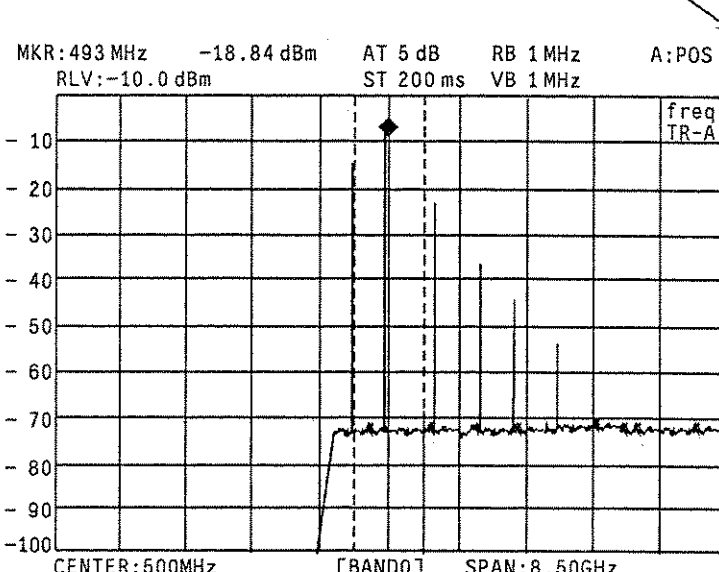

FREQUENCY

CENTER FREQ

START FREQ

STOP FREQ

START / SPAN \*

CF STEP SIZE \*

SCROLL STEP SIZE

( For how to read the function menu, see Appendix C. )

Communication area



### 4.3.2 Frequency span setting

MS2602A front panel

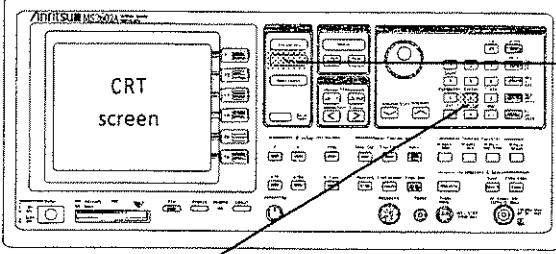

**1** Press the header key

Span

- The current frequency span is displayed in the communication area at the lower end of the CRT screen.

System

**2** Press **2** key.

- The current input data 2 is displayed in the communication area.

**3** Press **kHz** key.

- "2 kHz" is displayed in the communication area and at upper right. The frequency span has been changed to 2 kHz. ( See following figure. )
- The center frequency of 500 MHz is set in the center with a total of 2 kHz sweep frequency range with positive and negative sides of 1 kHz.
- SPAN: 2 kHz indicates the horizontal total frequency range. The frequency / div value is therefore 1 / 10 of the displayed value.

MKR: 499.999 98MHz -18.83dBm AT 5dB RB 100Hz A: POS  
 RLV: -10.0dBm ST 600ms VB 100Hz

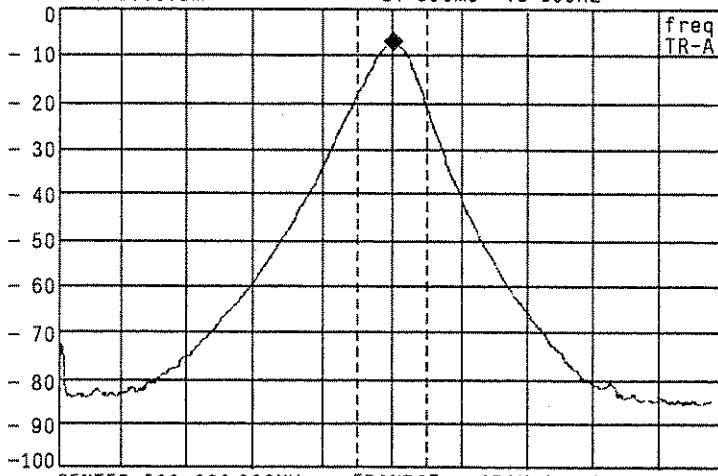

Communication area



FREQUENCY SPAN = 2.000kHz

- The "◆" seen at the top of the spectrum trace is the current marker. The measurement value of check-signal 500MHz fundamental frequency and the level can be read from the digital display at this marker point. MKR ( MARKER ) FREQ = 499.99998 MHz, MKR LEVEL = -18.83 dBm can be read directly from the top left of the CRT screen shown above.
- The most accurate signal level can be obtained by measuring the signal near the reference level. This operation is described on the next page.

### 4.3.3 Reference level setting

The PEAK → REF method and the MKR VAL method for setting the reference level are described below.

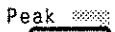
#### PEAK → REF method :

Peak   
 Press  key.

The highest peak point is detected from the spectrum shown on the CRT screen, and the level of this point is set as the reference level.

- The highest level point (−18.83 dBm) shown on the CRT screen is moved to the reference level line to obtain the reference level −18.8 dBm.
- There is a current marker at the highest level point, so the measured value 18.89 dBm can be obtained.

MS2602A front panel

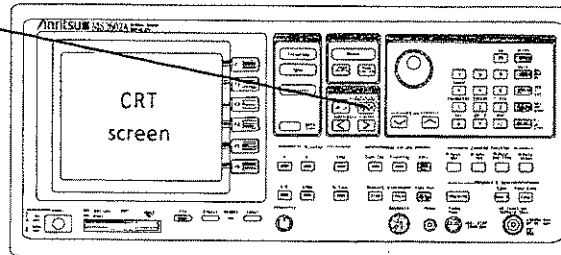

MKR:499.999 998MHz -18.89dBm AT 5dB RBW 100Hz A:POS  
 RLV:-18.8dBm ST 600ms VBW 100Hz

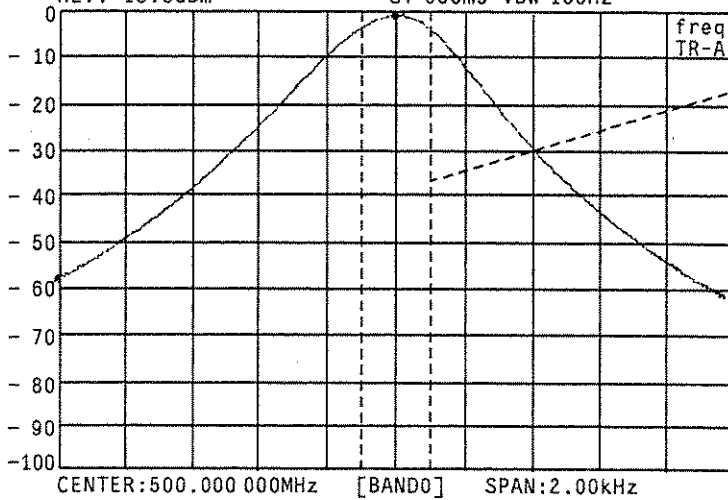

*Note: This dotted line frame is referred to as the ZONE marker. In this ZONE marker, a marker point always exists. Normally, this marker point detects the highest level point of the spectrum in the ZONE marker and moves to this point.*

## SECTION 5 PERFORMANCE TESTS

This section lists the equipment required for performing the performance tests, and explains each setup and the performance test items.

### TABLE OF CONTENTS

5.1	Requirement for Performance Tests .....	5-3
5.2	Instruments Required for Performance Tests .....	5-4
5.3	Performance Test .....	5-6
5.3.1	Reference oscillator frequency stability .....	5-6
5.3.2	Center frequency readout accuracy .....	5-8
5.3.3	Frequency span readout accuracy .....	5-10
5.3.4	Resolution bandwidth ( RBW ) and selectivity .....	5-13
5.3.5	Sideband noise .....	5-19
5.3.6	Frequency measurement accuracy .....	5-21
5.3.7	CRT display amplitude scale linearity .....	5-23
5.3.8	Frequency response .....	5-26
5.3.9	Reference level accuracy .....	5-29
5.3.10	Average noise level .....	5-31
5.3.11	Second harmonic distortion .....	5-34
5.3.12	Resolution bandwidth ( RBW ) switching error .....	5-37
5.3.13	LOG / LIN scale switching error .....	5-40
5.3.14	Input attenuator switching error .....	5-42
5.3.15	Sweep time and time span accuracy .....	5-45
5.4	Service .....	5-50

**(Blank)**

## SECTION 5

### PERFORMANCE TESTS

#### 5.1 Requirement for Performance Tests

Performance tests are used as preventive maintenance to prevent degradation of the MS2602A performance before it occurs. Use the performance tests whenever necessary such as at acceptance and periodic inspection of the MS2602A and to verify performance after repair.

Execute the performance tests listed below to verify the MS2602A performance at acceptance inspection, periodic inspection and after repair.

- Reference oscillator frequency stability
- Center frequency display accuracy
- Frequency span display accuracy
- Resolution bandwidth and selectivity
- Sideband noise level
- Frequency measurement accuracy
- CRT amplitude display linearity
- Frequency response
- Reference level accuracy
- Average noise level
- Second harmonic distortion
- Resolution bandwidth ( RBW ) switching error
- LOG / LIN scale switching error
- Input attenuator switching error
- Sweep time and time span accuracy

Execute the performance tests at regular intervals as preventive maintenance for important evaluation items.

We recommend that the performance be inspected regularly once or twice a year.

If the specifications are not met at the performance tests, please contact Anritsu Corporation.

## 5.2 Instruments Required for Performance Test

A list of instruments required for performance test is shown below.

### Instruments Required for Performance Test ( 1/2 )

Recommended instrument name ( Model name )	Required Performance †	Test item
Synthesized signal generator ( MG3633A )	<ul style="list-style-type: none"> <li>• Frequency range 100 MHz to 1 GHz Resolution of 1 Hz possible</li> <li>• Output level range - 20 to 0 dBm Resolution of 0.1 dB possible</li> <li>• SSB phase noise <math>\leq -130</math> dBc / Hz ( at 10 kHz offset )</li> <li>• Second harmonic <math>\leq -30</math> dBc</li> <li>• Amplitude modulation ( 0% to 100%, 0.1 to 400 Hz ) possible</li> <li>• External reference input ( 10 MHz ) possible</li> </ul>	Frequency-span display accuracy Resolution bandwidth, selectivity Sideband noise CRT amplitude display linearity Reference-level accuracy Second-harmonic distortion Resolution-bandwidth switching error LOG / LIN-scale switch error Input-attenuator switching error Sweep-time and time-span accuracy
Swept Frequency Synthesizer ( WILTRON 6769B with Option 2C )	<ul style="list-style-type: none"> <li>• Frequency range 10 MHz to 8.5 GHz Resolution of 2 kHz possible</li> <li>• Output level range - 20 to 0 dBm Resolution of 0.1 dB possible</li> <li>• Pulse modulation possible Pulse width: 0.5 to 10 <math>\mu</math>sec Repetitive cycle: 5 <math>\mu</math>sec to 5 msec</li> <li>• External reference input ( 10 MHz ) possible</li> </ul>	Center-frequency display accuracy Frequency-span display accuracy Frequency measurement accuracy Frequency response Time-span accuracy
Attenuator ( MN510C )	<ul style="list-style-type: none"> <li>• Frequency 100 MHz</li> <li>• Maximum attenuation 70 dB ( resolution 0.1 dB ) possible with calibrated data</li> </ul>	CRT amplitude display linearity Input-attenuator switching error

† Extracts part of performance which can cover the measurement range of the test item.

## Instruments Required for Performance Test ( 2/2 )

Recommended instrument name ( Model name )	Required performance †	Test item
Power meter ( ML4803A )	<ul style="list-style-type: none"> <li>• Main instrument accuracy <math>\pm 0.02</math> dB</li> <li>• Frequency range 100 kHz to 8.5 GHz ( depending on the power sensor type )</li> </ul>	Frequency response Reference-level accuracy Input-attenuator switching error
Power Sensor ( MA4701A )	<ul style="list-style-type: none"> <li>• Frequency range 2 to 8.5 GHz</li> <li>• Measurement power range <math>-30</math> to <math>+10</math> dBm</li> <li>• Input connector N type</li> </ul>	Frequency response
Power sensor ( MA4601A )	<ul style="list-style-type: none"> <li>• Frequency range 10 MHz to 2 GHz</li> <li>• Measurement power range <math>-30</math> to <math>+10</math> dBm</li> <li>• Input connector N type</li> </ul>	Frequency response Reference-level accuracy Input-attenuator switching error
50 $\Omega$ terminator ( MP752A )	<ul style="list-style-type: none"> <li>• Frequency range DC to 8.5 GHz</li> <li>• VSWR <math>\leq 1.2</math></li> </ul>	Average noise level
Low-pass filter (M-238C) (SAGE L20CA072)	<ul style="list-style-type: none"> <li>• Attenuation <math>\geq 70</math> dB ( at frequency: <math>2 \times ( 5.1</math> MHz and <math>1.76</math> GHz ) )</li> </ul>	Second-harmonic distortion
Frequency counter ( MF1601A )	10 MHz measurement possible Number of display digits: 10 <ul style="list-style-type: none"> <li>• External reference input ( 10 MHz ) possible</li> </ul>	Reference-oscillator frequency stability
Frequency standard	<ul style="list-style-type: none"> <li>• Frequency 10 MHz</li> <li>• Stability <math>\leq 1 \times 10^{-9}</math> /day</li> </ul>	Reference-oscillator frequency stability

† Extracts part of performance which can cover the measurement range of the test item.

### 5.3 Performance Test

The warm-up time depends on the test item. For test item other than oscillator frequency, warm-up the equipment for at least for thirty minutes and test the performance after the MS2602A stabilizes completely. Also, begin measurement after taking the warm-up time of the calibration instrument into full consideration. In addition, the test must be conducted at room temperature; there must be little AC power supply voltage fluctuation, and no noise, vibration, dust, humidity, etc.

#### 5.3.1 Reference oscillator frequency stability

The frequency stability of the 10 MHz crystal oscillator used as the reference oscillator is tested. Measure the frequency change after 24 hours and 48 hours after power-on (aging rate) at ambient temperatures of both 0 and 50°C (temperature characteristic).

##### (1) Specifications

###### ■ Reference oscillator

- Frequency: 10 MHz
- Aging rate:  $\cong \pm 2 \times 10^{-8}$  / day  
After 24 hour warm-up at  $25^\circ\text{C} \pm 5^\circ\text{C}$   
(Option 01  $\cong \pm 5 \times 10^{-9}$  / day, After 24-hour operation,  $25^\circ\text{C} \pm 5^\circ\text{C}$ )
- Temperature stability:  $\cong \pm 5 \times 10^{-8}$  at 0 and  $50^\circ\text{C}$  referred to frequency at  $25^\circ\text{C}$   
(Option 01  $\cong \pm 3 \times 10^{-8}$ , 0 to  $50^\circ\text{C}$  ( $25^\circ\text{C}$  reference))

##### (2) Test instruments

- frequency counter: MF1601A
- Frequency standard: with stability of  $\cong \pm 1 \times 10^{-9}$  / day

##### (3) Setup

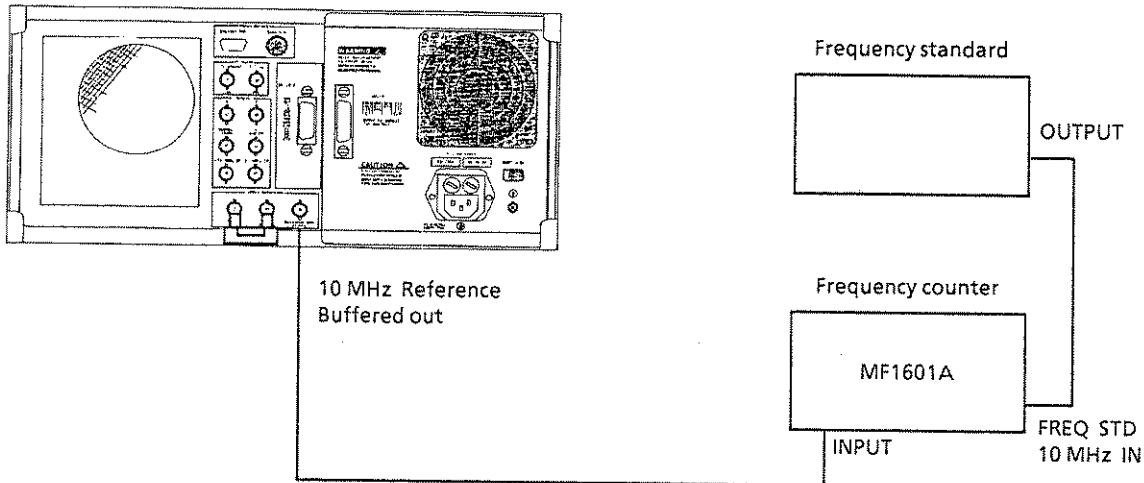

Reference Oscillator Frequency Stability Test



#### (4) Procedure

Aging rate / day: Test this at the ambient temperature  $\pm 2^{\circ}\text{C}$  in a vibration-free place.

Step	Procedure
1	Set the changeover switch ( FREQ STD: INT / EXT ) on the MF1601A counter rear panel to EXT.
2	Set the power supply switch on the MS2602A rear panel to On and then the Power switch on the MS2602A front panel to On.
3	Measure the frequency using the counter with 0.1 Hz resolution after 24 hours have passed after turning the power ON.
4	Measure the frequency using the counter after 24 more hours have passed from the step 3 measurement.
5	Calculate the stability by using the following equation.

$$\text{Frequency stability} = \frac{(\text{counter reading in step 4}) - (\text{counter reading in step 3})}{(\text{counter reading in step 3})}$$

Temperature stability: Test this performance in a vibration-free constant-temperature chamber.

Step	Procedure
1	Set up the MS2602A in a constant-temperature chamber at $25^{\circ}\text{C}$ in the same setup.
2	Set the LINE and Power switches on the MS2602A to On and wait until the MS2602A internal temperature stabilizes ( approx. 1.5 hours after the chamber temperature stabilizes ).
3	When the internal temperature stabilizes, measure the frequency by using the counter with 0.1 Hz resolution.
4	Change the chamber temperature to $50^{\circ}\text{C}$ .
5	When the chamber temperature and the MS2602A internal temperature re-stabilize, measure the frequency by using the counter.
6	Calculate the stability by using the following equation.

$$\text{Frequency stability} = \frac{(\text{counter reading in step 5}) - (\text{counter reading in step 3})}{(\text{counter reading in step 3})}$$

7	Change the chamber temperature to $0^{\circ}\text{C}$ and repeat steps 5 and 6.
---	---

### 5.3.2 Center frequency readout accuracy

Add the known frequency which serves as the center frequency reference to the MS2602A as shown in the figure below and set CF ( same value as the known reference frequency ) and SPAN. At this time, check that the difference between the reading of the marker readout frequency ( thick arrow in the figure ) of the center frequency peak point, and the CF set value is  $\leq \pm$  ( frequency span  $\times$  span accuracy ).

As shown in the figure, the Synthesized Signal Generator uses the signal source phase-locked with the same accuracy as the 10 MHz reference oscillator of the MS2602A.

#### (1) Specifications

- Center frequency accuracy:  $\pm$  ( Indicated frequency  $\times$  reference frequency accuracy + span  $\times$  span accuracy )

#### (2) Test instruments

- Synthesized signal generator: Wiltron 6769A

#### (3) Setup

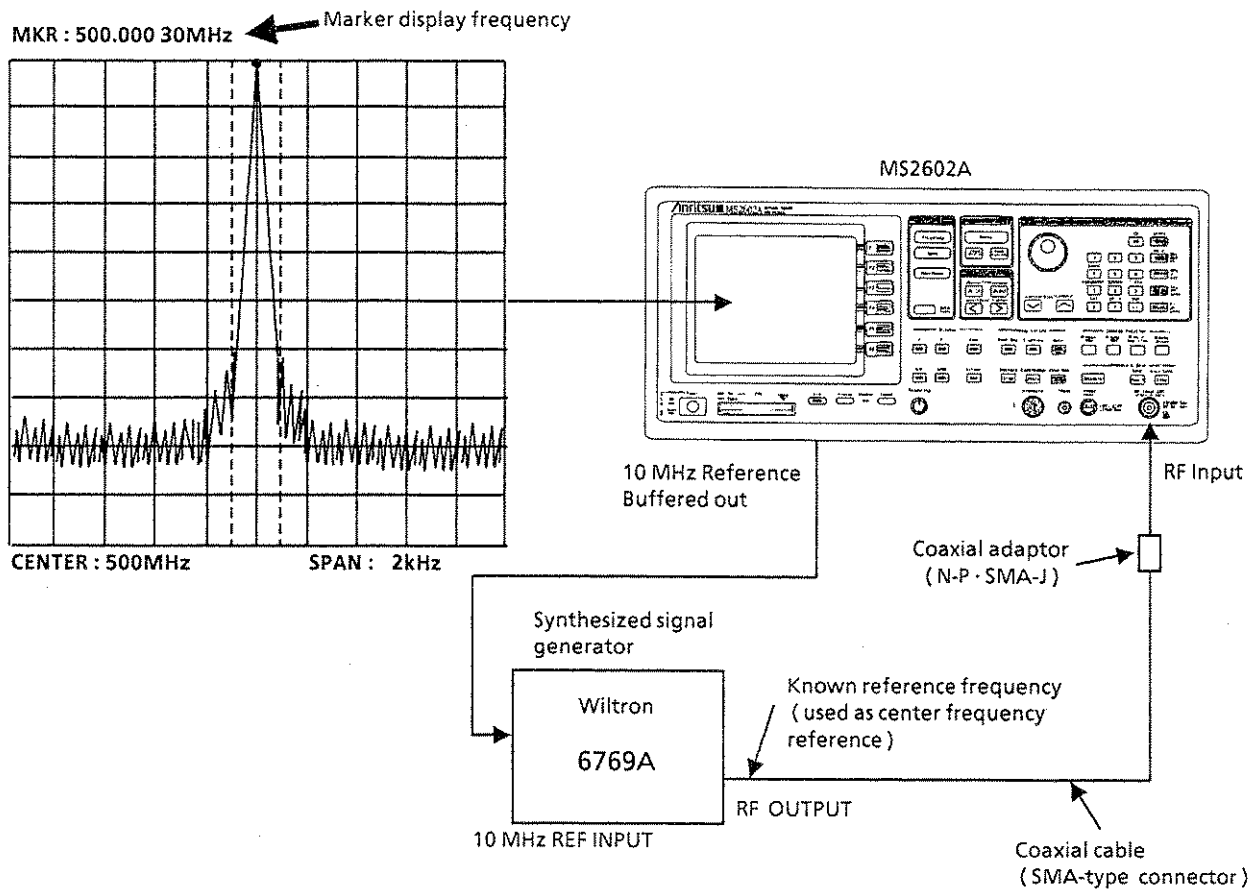

Center-Frequency Readout-Accuracy Test

#### (4) Precautions

Set the signal generator output level to approx. -10 to -20 dBm.

#### (5) Procedure

Step	Procedure
1	Press the MS2602A [ Preset ] key.
2	Perform frequency calibration ( FREQ CAL: Refer to SECTION 8 in the Detailed Operating Instruction Part of the separate operation manual ).
3	Set the signal generator output frequency equal to the center frequency ( 500 MHz ) in the following table.
4	Set the MS2602A to the center frequency in the following table.
5	Set the span (2 kHz) that corresponds to the center frequency ( 500 MHz ) in the table by using the numeric / unit keys.
6	Read the marker frequency ( indicated by thick arrow in the figure on the previous page ) and check that the value is within the range between the maximum and minimum values shown in the following table.
7	Repeat steps 3 to 6 for other combination of the center frequency and span according to the combinations shown in the following table.

#### Center-Frequency Readout-Accuracy Test

Signal generator output frequency	Center frequency	Span frequency	Band (Mixer order)	Center frequency readout		
				Minimum value	Marker value	Maximum value
500 MHz	500 MHz	2 kHz	0 ( 1 )	499.999 95 MHz		500.000 05 MHz
		200 kHz		499.995 MHz		500.005 MHz
		2 MHz		499.95 MHz		500.05 MHz
		10 MHz		499.75 MHz		500.25 MHz
		100 MHz		497.5 MHz		502.5 MHz
5 GHz	5 GHz	2 kHz	1 <sup>-</sup> ( 1 )	4.999 999 95 GHz		5.000 000 05 GHz
		200 kHz		4.999 995 GHz		5.000 005 GHz
		2 MHz		4.999 95 GHz		5.000 05 GHz
		10 MHz		4.999 75 GHz		5.000 25 GHz
		100 MHz		4.997 5 GHz		5.002 5 GHz
7.5 GHz	7.5 GHz	2 kHz	1 <sup>+</sup> ( 1 )	7.499 999 95 GHz		7.500 000 05 GHz
		200 kHz		7.499 995 GHz		7.500 005 GHz
		2 MHz		7.499 95 GHz		7.500 05 GHz
		10 MHz		7.499 75 GHz		7.500 25 GHz
		100 MHz		7.497 5 GHz		7.502 5 GHz

### 5.3.3 Frequency span readout accuracy

Using the setup shown in the figure below, set the frequencies corresponding the 1st and 9th division from the left side of the CRT scale with the SG. The frequency difference between the peak levels at the 1st and 9th divisions is equal to the frequency span  $\times 0.8$ .

#### (1) Specifications

- Frequency span accuracy:  $\pm 2.5\%$  (span  $\geq 1$  kHz)  
 $\pm 5\%$  (100 Hz  $\leq$  span  $< 1$  kHz)

#### (2) Test instrument

- Synthesized signal generator: MG3633A  
Wilton 6769A

#### (3) Setup

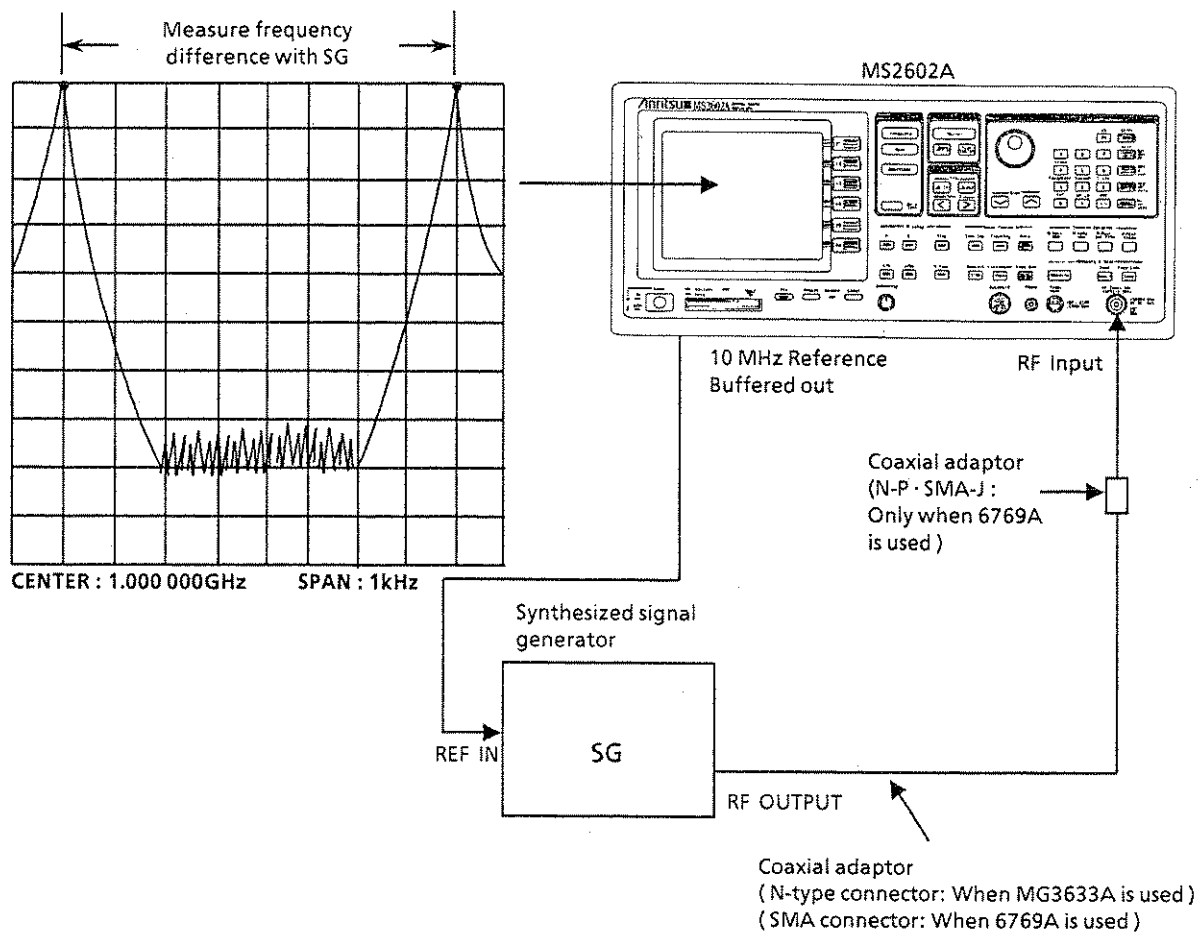

### Frequency Span Readout Accuracy Test

#### (4) Precautions

Set the signal generator output level to approx. 0 to -10 dBm.

#### (5) Procedure

Step	Procedure
1	Press the [ Preset ] key.
2	Perform frequency calibration ( FREQ CAL: Refer to SECTION 8 in the Detailed Operating Instruction Part of the separate operation manual ).
3	Connect the MG3633A output to the MS2602A RF Input.
4	Set the MS2602A as shown below: SPAN ..... 2 kHz CENTER FREQ ..... 1000 MHz
5	Set the MG3633A output frequency to the $f_1$ frequency ( 999.9992 MHz ) shown in the table on the next page.
6	Adjust the MG3633A output frequency to set the spectrum peak at the 1st division from the left end of the CRT scale. Remember the frequency as $f_1'$ .
7	After setting the MG3633A output frequency to the $f_2$ frequency ( 1000.000 8 MHz ), adjust it to set the spectrum peak at the 9th division. Remember the frequency as $f_2'$ .
8	Calculate ( $f_2' - f_1'$ ) and check that the value is within the specified range ( minimum to maximum values ) shown in the table on the next page.
9	Repeat steps 4 to 8 for frequencies other than the span 2 kHz and the center frequency 1000 MHz according to the combinations of frequency span and center frequency shown in the table on the next page.
10	Connect the Wiltron 6769A output to the MS2602A RF Input.
11	Repeat the steps 4 to 8 for each span of the 4.25 GHz center frequency.

### Frequency-Span Readout-Accuracy Test

MS2602A		Signal generator				
Center frequency	Span frequency	$f_1$	$f_2$	Minimum value	$\frac{f_2' - f_1'}{0.8}$	Maximum value
1 GHz	2 kHz	0.999 999 2 GHz	1.000 000 8 GHz	1.95 kHz		2.05 kHz
	20 kHz	0.999 99 2 GHz	1.000 008 GHz	19.5 kHz		20.5 kHz
	200 kHz	0.999 92 GHz	1.000 08 GHz	195 kHz		205 kHz
	2 MHz	0.999 2 GHz	1.000 8 GHz	1.95 MHz		2.05 MHz
	10 MHz	0.996 GHz	1.004 GHz	9.75 MHz		10.25 MHz
	100 MHz	0.96 GHz	1.04 GHz	97.5 MHz		102.5 MHz
	2 GHz	0.2 MHz	1.8 GHz	1.95 GHz		2.05 GHz
4.25 GHz	100 MHz	4.21 GHz	4.29 GHz	97.5 MHz		102.5 MHz
	1 GHz	3.85 GHz	4.65 GHz	0.975 GHz		1.025 GHz
	8.5 GHz	0.85 GHz	7.65 GHz	8.2875 GHz		8.7125 GHz

### 5.3.4 Resolution bandwidth ( RBW ) and selectivity

If there are two input signals with the frequency difference corresponding to 3 dB bandwidth ( of IF final stage ), these signals can be resolved as two spectrum waveforms. This is called the resolution bandwidth.

Selectivity can be improved by narrowing the 60 dB bandwidth. The selectivity is defined by the ratio of the filter width, in Hz, at the -60 dB point, to the filter width, in Hz, at the -3 dB point, as shown in the formula below.

$$\text{Selectivity} = \frac{60 \text{ dB bandwidth ( Hz )}}{3 \text{ dB bandwidth ( Hz )}}$$

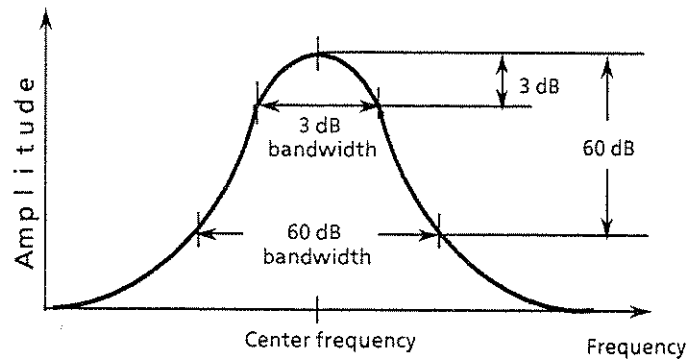

To test the resolution bandwidth and selectivity, first measure the resolution bandwidth ( 3dB bandwidth ), then the 60 dB bandwidth and calculate the 60 dB / 3 dB bandwidth ratio.

#### (1) Specifications

- Resolution bandwidth accuracy:  $\pm 20$
- Selectivity ( 60 dB / 3 dB bandwidth ):
  - $\leq 15:1$  ( 100 kHz to 3 MHz )
  - $\leq 12:1$  ( 10 Hz to 30 kHz )

#### (2) Test instrument

- Synthesized signal generator: MG3633A

### (3) Setup

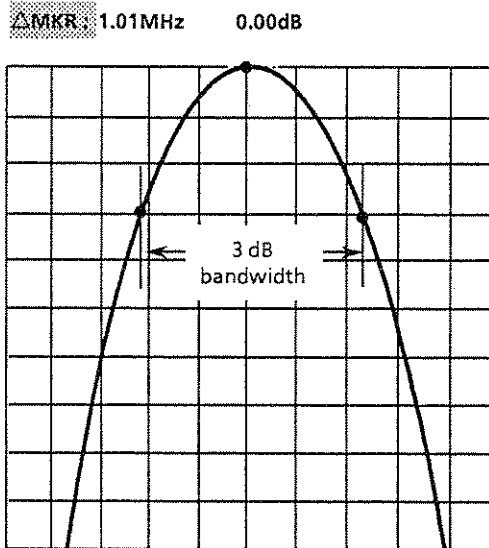
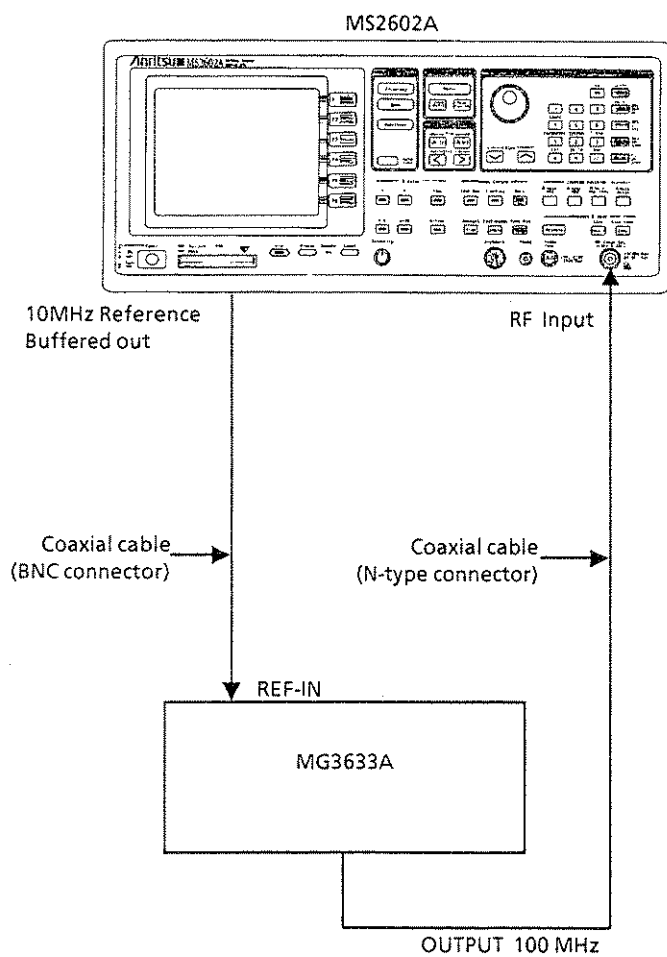

(a) Resolution bandwidth

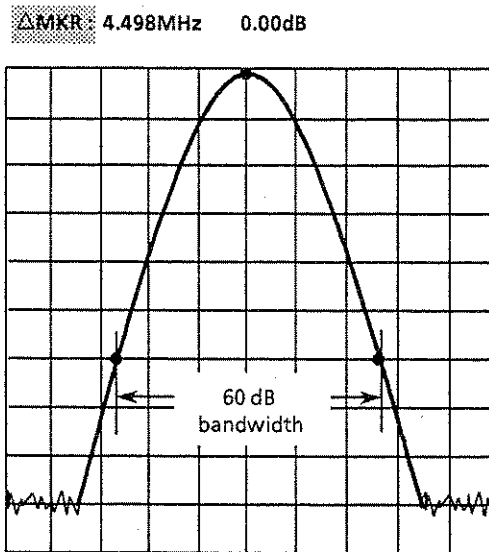

(b) 60 dB dropped bandwidth

### Resolution Bandwidth / Selectivity Test



#### (4) Procedure

##### (a) Resolution bandwidth accuracy

Step	Procedure
1	Press the [Preset] key.
2	Perform all calibration (ALL CAL: Refer to SECTION 8 in the Detailed Operating Instruction Part of the separate operation manual).
3	Set the MS2602A as shown below: CENTER FREQ ..... 100 MHz SPAN ..... 10 MHz RBW (MANUAL) ..... 3 MHz SCAL ..... LOG 1 dB/div
4	Press the Peak [→ Ref] key and match the peak of the signal trace to the top line (REF LEVEL) on the CRT.
5	Press the [Single] key to execute a single sweep, then check that the single sweep has been completed.
6	Press the [Measure] key, then etc [F6], OBW MEAS [F1], and SETUP [F5] keys in that order to display the occupied frequency bandwidth measurement SETUP menu.
7	Select X dB DOWN with the [F1] key, then set 3 dB with the [F3] key.
8	Press the RETURN [F6] key to return to the OBW MEAS menu, then press the EXECUTE [F1] key.
9	The 3 dB resolution bandwidth value is displayed in the upper right-hand corner of the CRT screen. Fill in this value in the table on the next page.
10	Repeat steps 3 to 9 for the frequencies other than the resolution bandwidth 3 MHz and the frequency span 10 MHz according to the combinations of resolution bandwidth and frequency span shown in the table on the next page.

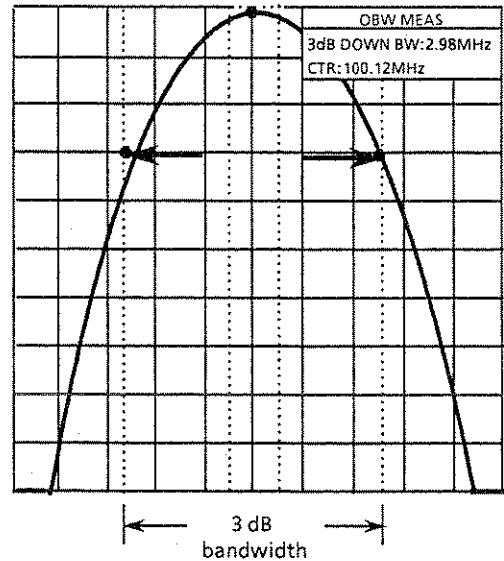

3 dB bandwidth Measurement

### Resolution Bandwidth ( 3 dB )

Resolution bandwidth	Frequency span	3 dB bandwidth		
		Minimum value		Maximum value
3 MHz	10 MHz	2.4 MHz	_____	3.6 MHz
1 MHz	5 MHz	0.8 MHz	_____	1.2 MHz
300 kHz	500 kHz	240 kHz	_____	360 kHz
100 kHz	200 kHz	80 kHz	_____	120 kHz
30 kHz	50 kHz	24 kHz	_____	36 kHz
10 kHz	20 kHz	8 kHz	_____	12 kHz
3 kHz	5 kHz	2.4 kHz	_____	3.6 kHz
1 kHz	2 kHz	0.8 kHz	_____	1.2 kHz
300 Hz	1 kHz	240 Hz	_____	360 Hz
100 Hz	1 kHz	80 Hz	_____	120 Hz
30 Hz	1 kHz	24 Hz	_____	36 Hz
10 Hz	100 Hz	8 Hz	_____	12 Hz

## (b) Resolution bandwidth selectivity

Step	Procedure
------	-----------

- 1 Set the MS2602A as shown below:

CENTER FREQ ..... 100 MHz  
SPAN ..... 100 MHz  
RBW (MANUAL) ..... 3 MHz  
SCALE ..... LOG 10 dB / div  
VBW ..... 100 Hz  
MARKER ..... NORMAL  
ZONE WIDTH ..... 10 MHz

- 2 Press the Peak [ → Ref ] key to match the peak of the signal trace to the top line ( REF LEVEL ) on the CRT.

- 3 Press the [ Single ] key to execute a single sweep, then check that the single sweep has been completed.

- 4 Press the [Measure] key, then etc [F6], OBW MEAS [F1], and SETUP [F5] keys in that order to display the occupied frequency bandwidth measurement SETUP menu.

- 5 Select X dB DOWN with the [F1] key, then set 60 dB with the [F3] key.

- 6 Press the RETURN [F6] key to return to the OBW MEAS menu, then press the EXECUTE [F1] key.

- 7 The 60 dB resolution bandwidth value is displayed in the upper right-hand corner of the CRT screen. Fill in this value in the table on the next page.

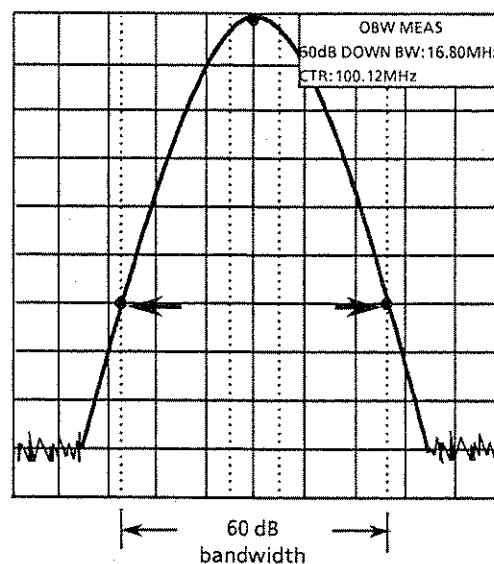

60 dB Bandwidth Measurement

- 8 Repeat steps 1 to 7 for the frequencies other than the resolution bandwidth 3 MHz and the frequency span 100 MHz according to the combinations of resolution bandwidth and frequency span shown in the table on the next page.
- 9 For the 3 dB bandwidth, write the value, recorded in the preceding table on the previous paragraph ( a ), in the table on the next page.
- 10 For each resolution bandwidth in the table on the next page, if the value calculated from ( 60 dB BW / 3 dB BW ) is  $\leq 15$  or  $\leq 12$ , it satisfies the MS2602A specifications.

### Selectivity Test ( 60 dB / 3 dB Bandwidth Ratio )

Resolution bandwidth	Frequency span	Video bandwidth	60 dB bandwidth	3 dB bandwidth	Selectivity ( 60 dB BW / 3dB BW )
3 MHz	100 MHz	100 Hz	_____	_____	_____
1 MHz	50 MHz	100 Hz	_____	_____	_____
300 kHz	20 MHz	100 Hz	_____	_____	_____
100 kHz	10 MHz	100 Hz	_____	_____	_____
30 kHz	200 kHz	100 Hz	_____	_____	_____
10 kHz	100 kHz	100 Hz	_____	_____	_____
3 kHz	20 kHz	100 Hz	_____	_____	_____
1 kHz	10 kHz	10 Hz	_____	_____	_____
300 Hz	2 kHz	1 Hz	_____	_____	_____
100 Hz	1 kHz	1 Hz	_____	_____	_____
30 Hz	200 kHz	1 Hz	_____	_____	_____
10 Hz	100 Hz	1 Hz	_____	_____	_____

### 5.3.5 Sideband noise

When the resolution bandwidth is set to a fixed value and a signal that has far less sideband-noise level than the equipment to be tested ( MS2602A ) is input, check the level of the noise as compared to the peak signal ( dBc ) at the specified frequency away from the peak.

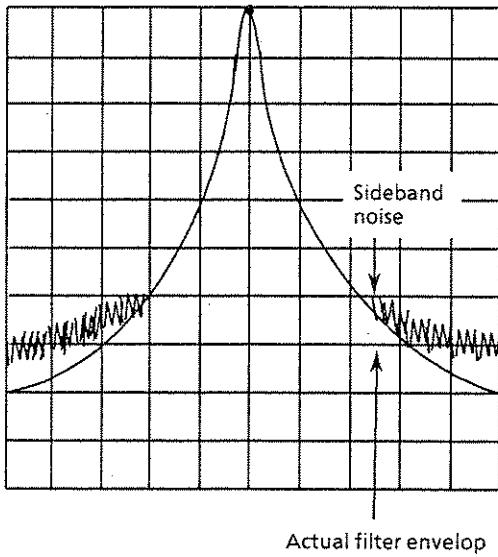

Since the average value is measured for the noise level, use a video filter for measurement.

This sideband noise is a spectrum response which is modulated by the internal noise of the MS2602A. If this response is large, the actual filter envelope is masked by the noise as shown, which makes measurement impossible.

#### (1) Specifications

- Sideband noise:
  - At 1 MHz to 4 GHz
  - $\leq -105$  dBc / Hz ( at 10 kHz offset )
  - $\leq -115$  dBc / Hz ( at 50 kHz offset )
  - $\leq -120$  dBc / Hz ( at 100 kHz offset )

#### (2) Test instruments

- Signal generator: MG3633A Synthesized Signal Generator

#### (3) Setup

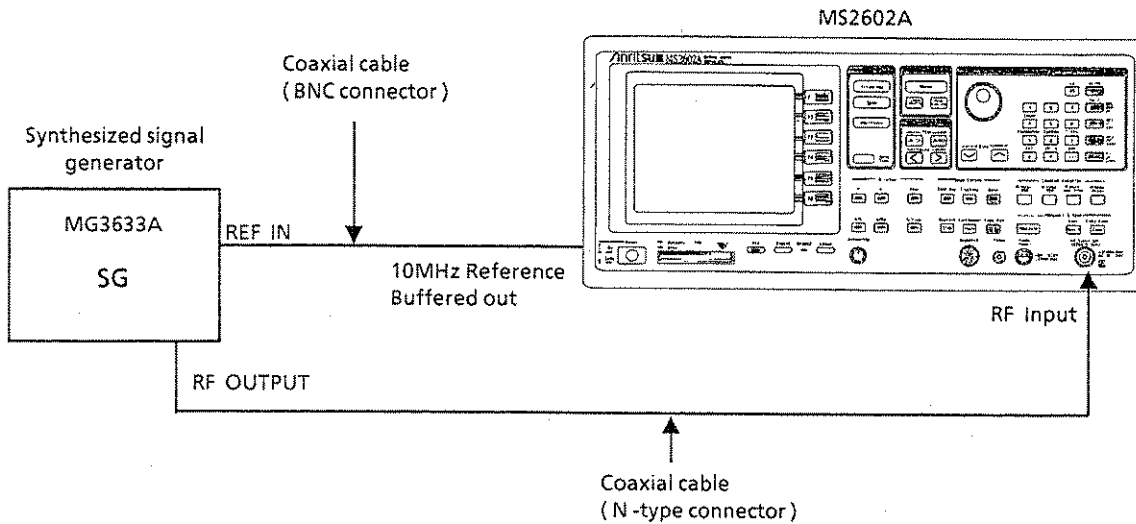

### Sideband Noise Test

#### (4) Procedure

- | Step | Procedure  |
|------|--|
| 1    | Press the [ Preset ] key.  |
| 2    | Perform all calibration ( ALL CAL: Refer to SECTION 8 in the Detailed Operating Instruction Part of the separate operation manual ). |
| 3    | Set the MG3633A output to 2000 MHz and 0 dBm.  |
| 4    | Set the MS2602A as shown below:  |

Item	at 10 kHz offset	at 50 kHz offset	at 100 kHz offset
CENTER FREQ	2.000008 GHz	2.00004 GHz	2.00008 GHz
SPAN	20 kHz	100 kHz	200 kHz
REF LEVEL	0 dBm	0 dBm	0 dBm
ATT	10 dB	10 dB	10 dB
RBW	300 Hz	1 kHz	3 kHz
VBW	10 Hz	10 Hz	10 Hz
DET MODE	SAMPLE	SAMPLE	SAMPLE

- Press the [ Peak Search ] key to search for a peak point so that the peak point on the signal trace is included in the zone marker.
- Press the Peak [ → Ref ] key to match the peak of the signal trace to the top line ( REF LEVEL ) on the CRT.
- Press the [ Measure ] key, then press the [ F2 ] key corresponding to the menu label [ NOISE MEAS ] to select the C/N RATIO with the [ F5 ] key.
- Press the [ F1 ] key to measure C/N.
- Set the zone-marker width to SPOT.
- Press the [ Marker ] key, then turn the rotary knob to move the zone marker to the right so that the zone center frequency is each offset value.

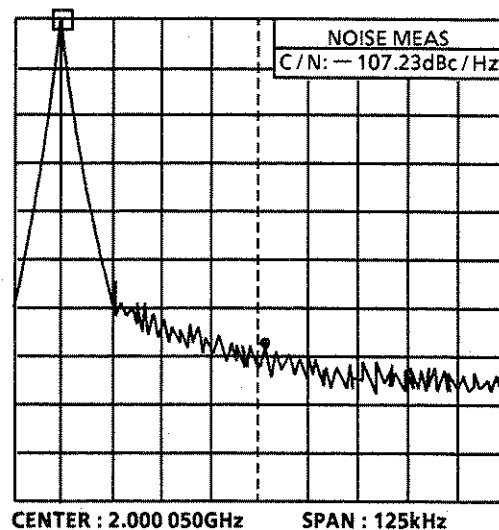

**Sideband Noise Measurement**

- Check that the C/N value is  $\leq -105$  dBc / Hz (at 10 kHz offset),  $\leq -115$  dBc / Hz (at 50 kHz offset) or  $\leq -120$  dBc / Hz (at 100 kHz offset).

### 5.3.6 Frequency measurement accuracy

Set the marker point to the position at least 20 dB higher than the noise ( or adjacent interference signal ) and test the frequency measurement accuracy using COUNT ON mode.

#### (1) Specifications

- Accuracy:  $\leq (\text{Readout frequency} \times \text{reference oscillator accuracy} \pm (1 \text{ count}))$
- Resolution: 1 Hz, 10 Hz, 100 Hz, 1 kHz

#### (2) Test instrument

- Signal generator: Wiltron 6769A

#### (3) Setup

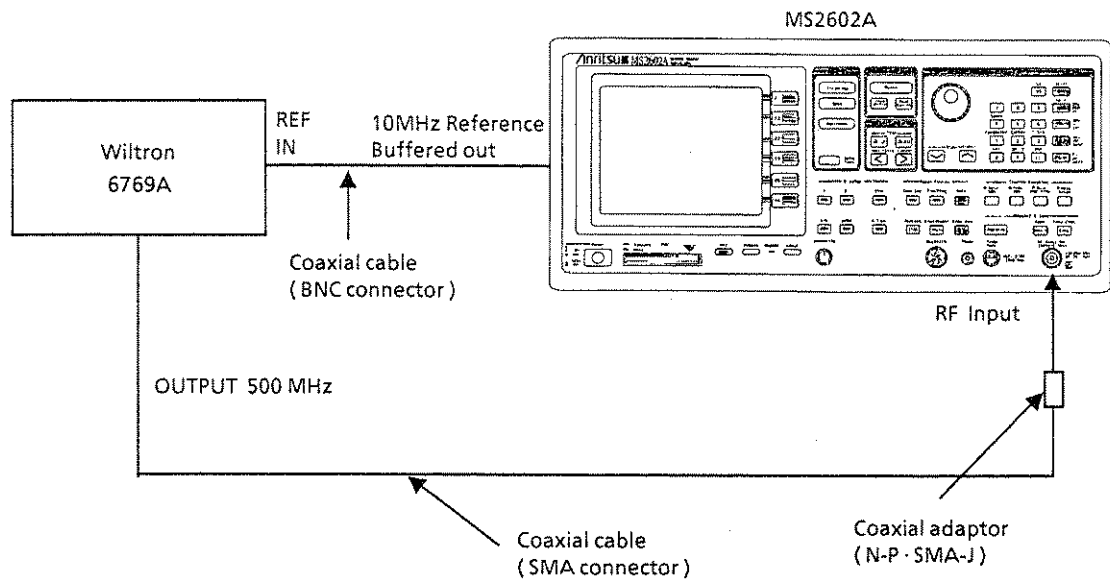

Frequency Measurement Accuracy Test

#### (4) Procedure

Step	Procedure
1	Press the [ Preset ] key.
2	Set the 6769A to 500 MHz and -10 dBm.
3	Set the MS2602A as shown below: CENTER FREQ ..... 500 MHz SPAN ..... 5 kHz
4	Press the [ Measure ] key, then the [ F1 ] key to set the FREQ MEAS to ON. Press the [ F5 ] key to set the COUNT RESOLUTION to 1 Hz, then press the [ F6 ] and [ F1 ] keys in that order to select COUNT ON.
5	Confirm that the FREQ reading at the upper-left of the CRT is the RF INPUT frequency 500 MHz $\pm$ 1 Hz or less.
6	Change the counter resolution to 10 Hz and confirm that the FREQ reading is 500 MHz $\pm$ 10 Hz or less.
7	Change the counter resolution to 100 Hz and confirm that the FREQ reading is 500 MHz $\pm$ 100 Hz or less.
8	Change the counter resolution to 1 kHz and confirm that the FREQ reading is 500 MHz $\pm$ 1 kHz or less.

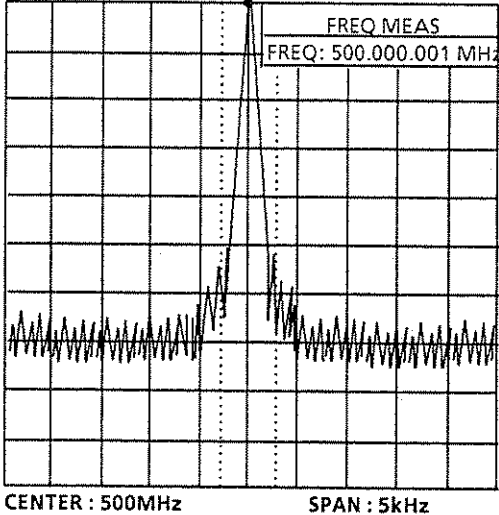

Frequency Measurement



### 5.3.7 CRT display amplitude scale linearity

Test the error per CRT vertical graduation for the LOG display. For the LOG display linearity, test that the graduation is equal to the logarithm (dB) of the input signal level.

Input the correct level signal to the RF Input via an external attenuator and calculate the error from the attenuation of the attenuator and the  $\Delta$  marker reading at the trace waveform peak.

#### (1) Specifications

- CRT display amplitude scale linearity: After automatic calibration
  - LOG:  $\pm 1.5$  dB for 0 to  $-90$  dB (RBW  $\leq 10$  kHz)
  - $\pm 1$  dB for 0 to  $-70$  dB (RBW  $\leq 100$  kHz)
  - $\pm 0.3$  dB for 0 to  $-20$  (RBW  $\leq 1$  MHz)

#### (2) Test instruments

- Signal generator: MG3633A
- Attenuator: MN510C

#### (3) Setup

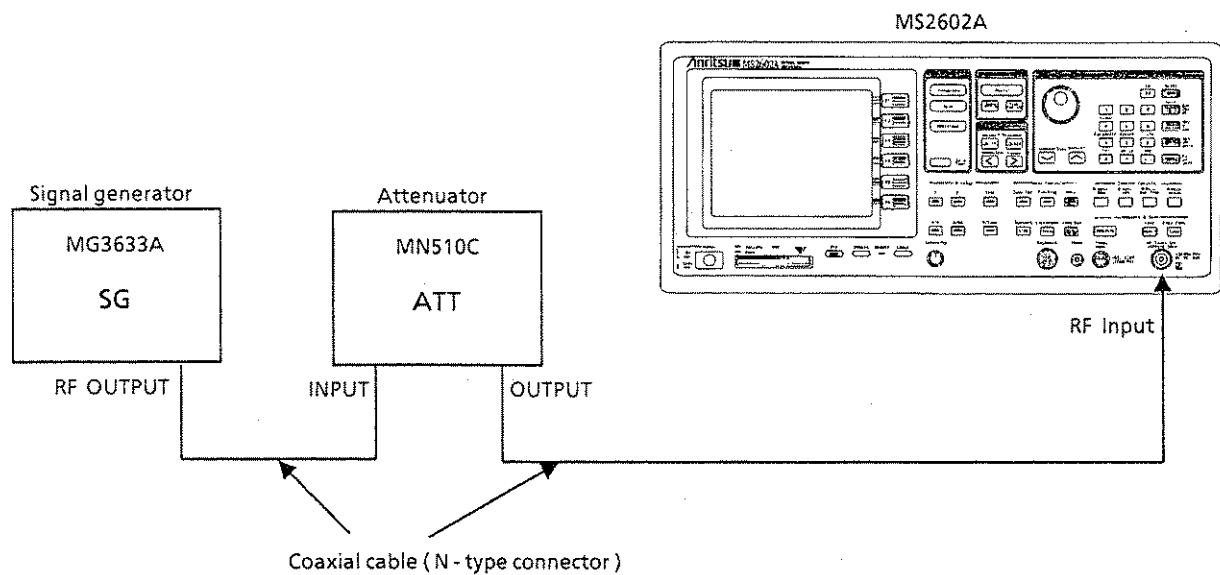

**CRT Display Amplitude Scale Linearity Test**

## (4) Procedure

### LOG display linearity

Step	Procedure
1	Press the [ Preset ] key.
2	Perform all calibration ( ALL CAL: Refer to SECTION 8 in the Detailed Operating Instruction Part of the separate operation manual ).
3	Set the MG3633A to 100 MHz and 0 dBm.
4	Set the MN510C to 0 dB.
5	Set the MS2602A as shown below: CENTER FREQ ..... 100 MHz SPAN ..... 10 kHz REF LEVEL ..... 0 dBm ATT ..... 15 dB RBW ..... 3 kHz VBW ..... 300 Hz
6	Press the Peak [ → CF ] key to set the spectrum waveform peak to the center of the CRT.
7	Adjust the MG3633A output level so that the marker level reading is 0.0 dBm.
8	Press the [ Marker ] and [ F2 ] keys sequentially to set the marker to $\Delta$ marker after the sweep is completed ( see figure ( a ) below ).
9	Read the current marker level when ATT is set to 5 dB ( figure ( b ) below ). Find the error by adding the ATT 5 dB corrected value to $\Delta$ marker level ( see the table on the next page ).
10	Find the error by adding the $\Delta$ marker level to the corresponding ATT corrected value when ATT is set to 10 to 90 dB ( 5 dB steps ) as shown in the figure on the next page.

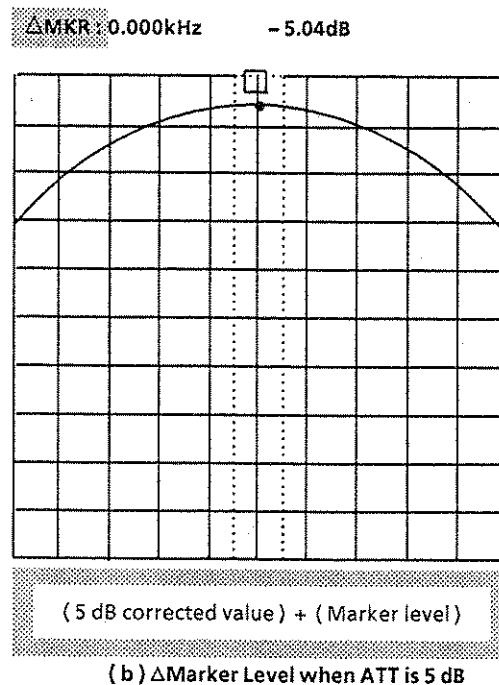
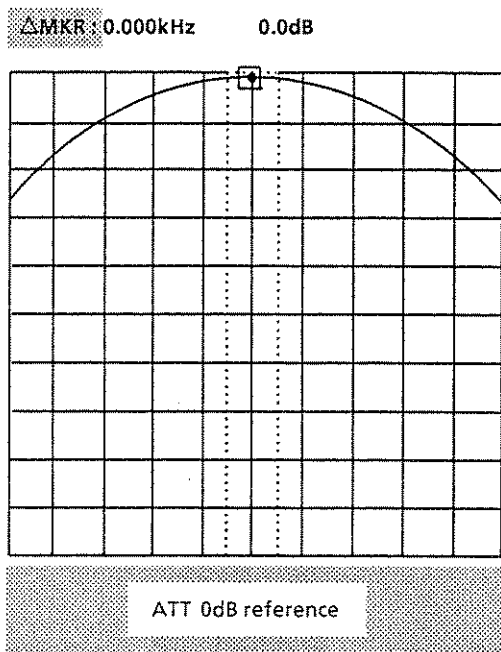

### LOG Display Linearity ( 10 dB / div )

ATT setting (dB)	A	B	Error ( dB ) = A + B
	ATT calibration value (dB)	$\Delta$ marker level (dB)	
0	0 ( reference )	0 ( reference )	0 ( reference )
5	_____	_____	_____
10	_____	_____	_____
15	_____	_____	_____
20	_____	_____	_____
25	_____	_____	_____
30	_____	_____	_____
35	_____	_____	_____
40	_____	_____	_____
45	_____	_____	_____
50	_____	_____	_____
55	_____	_____	_____
60	_____	_____	_____
65	_____	_____	_____
70	_____	_____	_____
75	_____	_____	_____
80	_____	_____	_____
85	_____	_____	_____
90	_____	_____	_____

### 5.3.8 Frequency response

Generally, when one or more signals with a different frequency but the same amplitude are input, the spectrum analyzer displays the same amplitude for each spectrum on the CRT.

#### (1) Specifications

- Frequency response: At Temperature 18° to 28°C for input ATT 10 dB  
± 0.5 dB ( 100 Hz to 2.0 GHz, band 0 )  
± 1 dB ( 1.7 GHz to 8.5 GHz, band 1<sup>-</sup>, band 1<sup>+</sup> )

#### (2) Test instruments

- Signal generator: Wiltron 6769A
- Power meter: ML4803A
- Power sensor: MA4701A

#### (3) Setup

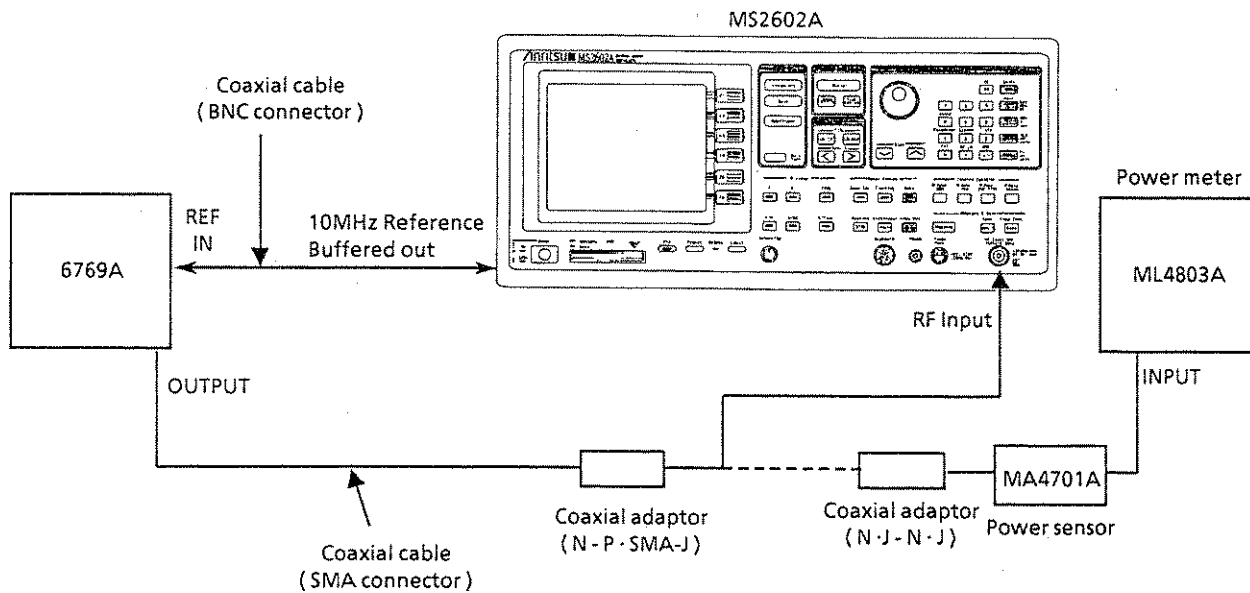

### Frequency Response Test

#### (4) Precautions

This test should be performed at an ambient temperature of 18° to 28°C after allowing the instrument to warm up for 60 minutes or more.

## (5) Procedure

### (a) Calibration of signal-generator 6769A

---

Step	Procedure
1	Set the 6769A as shown below: OUTPUT FREQ ..... 100 MHz OUTPUT LEVEL ..... -10 dBm
2	Connect the 6769A output to the power sensor input with a coaxial cable.
3	Read the power meter display.
4	Change the 6769A output frequency as shown in the tables on the next page and read the power meter display with level at 100 MHz as reference. This data is the calibration data.

---

### (b) Readout of measured amplitude deviation ( frequency response )

---

Step	Procedure
1	Connect the 6769A OUTPUT to MS2602A RF Input with a coaxial cable.
2	Press the MS2602A [ Preset ] key.
3	Perform all calibration ( ALL CAL: Refer to SECTION 8 in the Detailed Operating Instruction Part of the separate operation manual ).
4	Set the MS2602A as shown below: CENTER FREQ: ..... 100 MHz SPAN: ..... 200 kHz BAND: ..... 0 REF LEVEL: ..... -10 dBm
5	Press the Peak [ → CF ] key.
6	Set the marker mode to delta marker.
7	Set the MS2602A frequency band and center frequency as shown in the tables on the next page, then obtain the deviation from the formula below by reading the delta marker level at each frequency.  Deviation = Delta marker level reading - Measurement frequency calibration value  Perform peaking of the preselector for bands 1 <sup>+</sup> and 1 <sup>-</sup> . ( Refer to SECTION 8 in the Detailed Operating Instructions part of the separate Operation Manual. )

---

### Frequency Response ( Band 0 )

Frequency	Calibration value ( dBm )	Marker level ( dB )	Deviation ( dB )
100 MHz	0 dB (reference)	0 dB (reference)	0 dB (reference)
200 MHz	_____	_____	_____
500 MHz	_____	_____	_____
1 GHz	_____	_____	_____
1.5 GHz	_____	_____	_____
2 GHz	_____	_____	_____

### Frequency Response ( Band 1 - )

Frequency	Calibration value ( dBm )	Marker level ( dB )	Deviation ( dB )
1.7 GHz	_____	_____	_____
2 GHz	_____	_____	_____
3 GHz	_____	_____	_____
4 GHz	_____	_____	_____
5 GHz	_____	_____	_____
6 GHz	_____	_____	_____
7 GHz	_____	_____	_____
7.5 GHz	_____	_____	_____

### Frequency Response ( Band 1 + )

Frequency	Calibration value ( dBm )	Marker level ( dB )	Deviation ( dB )
6.5 GHz	_____	_____	_____
7 GHz	_____	_____	_____
7.5 GHz	_____	_____	_____
8 GHz	_____	_____	_____
8.5 GHz	_____	_____	_____

### 5.3.9 Reference level accuracy

Here the absolute amplitude level at only 100 MHz is tested. Confirm the level accuracy after inputting an SG output (calibrated by a standard power meter) to the MS2602A.

#### (1) Specifications

- Reference level accuracy: At 100 MHz frequency and  $\leq 2$  MHz span after automatic calibration (Resolution bandwidth, video bandwidth and sweep time set to AUTO)
  - $\leq \pm 0.3$  dB (0 to -50 dBm)
  - $\leq \pm 0.75$  dB (+30 to 0 dBm, -50 to -70 dBm)
  - $\leq \pm 1.5$  dB (-70 to -90 dBm)

#### (2) Test instruments

- Signal generator: MG3633A
- Attenuator: MN510C
- Power sensor: MA4601A
- Power meter: ML4803A

#### (3) Setup

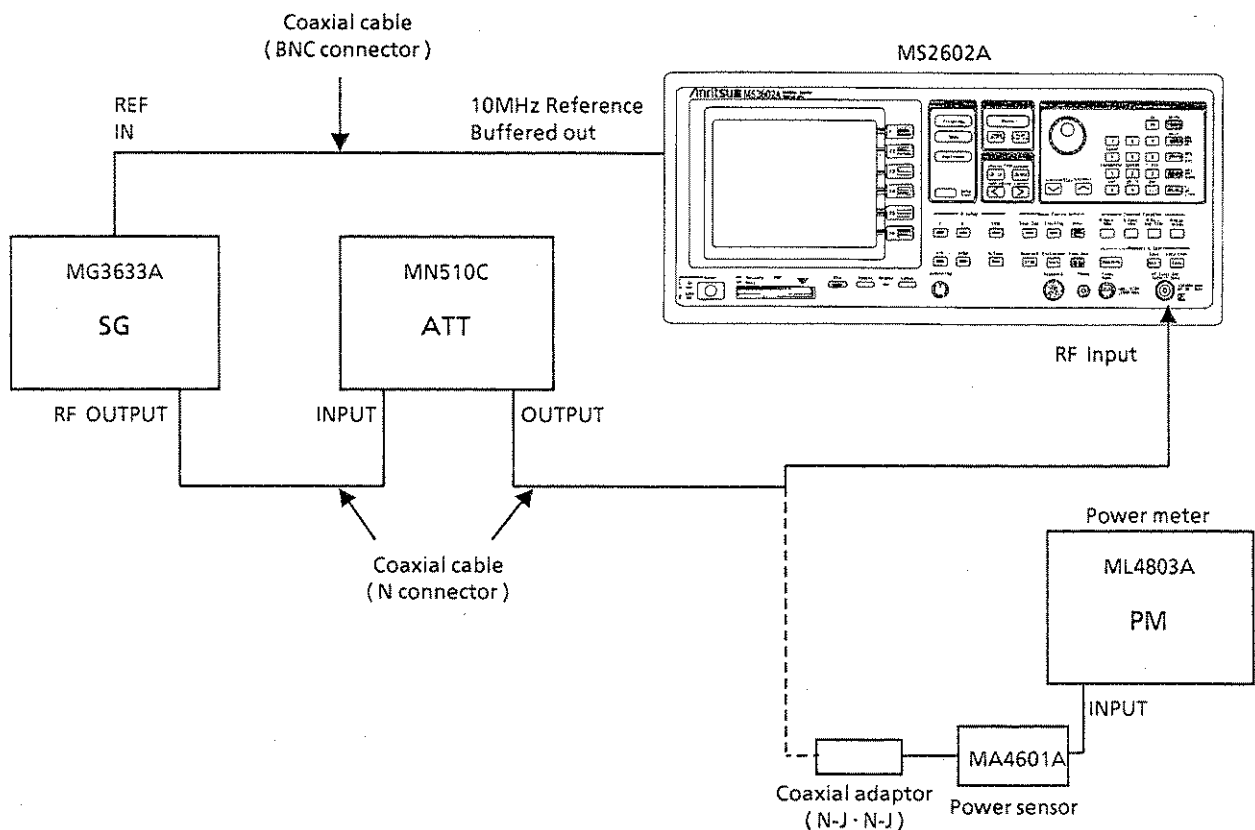

Reference Level Accuracy Test

#### (4) Precautions

1. Set the resolution bandwidth, video bandwidth and sweep time to Auto.
2. This test should be performed after warming up this instrument for 60 minutes or more.

#### (5) Procedure

- | Step | Procedure  |
|------|--|
| 1    | Press the MS2602A [Preset] key.  |
| 2    | Perform all calibration ( ALL CAL: Refer to SECTION 8 in the Detailed Operating Instruction Part of the separate operation manual ).           |
| 3    | Connect the attenuator OUTPUT to the power sensor input.   |
| 4    | Set the SG frequency to 100 MHz and adjust the SG level so that the power meter indication is 0 dBm. At this time, set the attenuator to 0 dB. |
| 5    | Connect the attenuator OUTPUT to the MS2602A RF Input connector.   |
| 6    | Set the MS2602A as shown below:<br>CENTER FREQ ..... 100 MHz<br>SPAN ..... 200 kHz<br>REF LEVEL ..... 0 dBm                                    |
| 7    | Press the Peak [ → CF ] to move the peak point of the spectrum waveform to the center of the screen.   |
| 8    | Read the marker level.   |
| 9    | Change the attenuator in 10 dB steps, set the reference level as shown in the table below and read the marker level each time.                 |

Reference level setting	Marker level value	Calibrated attenuation value	Error
0 dBm			
-10 dBm			
-20 dBm			
-30 dBm			
-40 dBm			
-50 dBm			
-60 dBm			
-70 dBm			
-80 dBm			
-90 dBm			

- 10 Find the error from the following equation.  

$$\text{Error} = \text{marker level value} - \text{reference level set value} - \text{calibrated attenuation value}$$



### 5.3.10 Average noise level

The internal noise distributed evenly in proportion to the resolution bandwidth over the whole measurement frequency band is called the average noise level.

#### (1) Specifications

- Average noise level: At 10 Hz resolution bandwidth, 1 Hz video bandwidth, and 0 dB input attenuator:
  - $\leq -135$  dBm (1 MHz to 1.7 GHz)
  - $\leq -135$  dBm (1.7 to 7.5 GHz)
  - $\leq -130$  dBm (7.5 to 8.5 GHz)

#### (2) Test instruments

- 50  $\Omega$  terminator: MP752A

#### (3) Setup

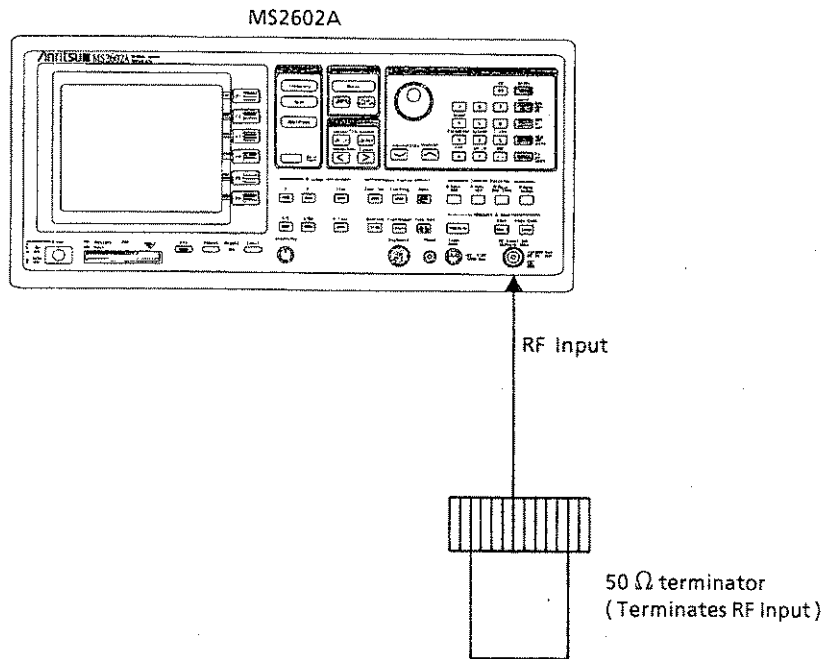

Average Noise Level Test

#### (4) Procedure

Step	Procedure
1	Press the MS2602A [ Preset ] key.
2	Perform all calibration ( ALL CAL: Refer to SECTION 8 in the Detailed Operating Instruction Part of the separate operation manual ).
3	Terminate the RF Input with a 50 $\Omega$ terminator.
4	Set the MS2602A as shown below: START FREQ ..... 1 MHz STOP FREQ ..... 1 GHz REF LEVEL ..... -40 dBm ATT ..... 0 dB RBW ..... 30 kHz VBW ..... 3 kHz DET MODE ..... SAMPLE
5	Press the [ Single ] key to execute a single sweep.
6	Press the Peak [ $\rightarrow$ CF ] key to set the frequency at the peak level of the spectrum to the center frequency.
7	Press the [ Shift ] key and then the [ Single ] key to execute a continuous sweep.
8	Set the MS2602A as shown below: SPAN ..... 0 Hz REF LEVEL ..... -100 dBm RBW ..... 10 Hz VBW ..... 1 Hz
9	Press the Display section [ Time ], [ F4 ], [ F2 ], [ F4 ], [ 1 ][ 6 ][ enter ] keys sequentially to preset the 16-time averaging sweep.
10	Press the [ F3 ] key to start the averaging, and wait until the 16-time averaging sweep is completed.
11	Press the [ Peak Search ] key to execute peak search. At this point, read the level value at the marker.
12	Verify that a reading of -135 dBm or less can be obtained at the marker.

- 13 Repeat steps 4 to 12 while setting START / STOP FREQ from the below table so that the average noise level can be obtained.

MS2602A setting		Average noise level	
START FREQ	STOP FREQ	Marker reading	Specification
1 MHz	1 GHz		-135 dBm
1 GHz	2 GHz		-135 dBm
1.7 GHz	7.5 GHz		-135 dBm
7.5 GHz	8.5 GHz		-130 dBm

### 5.3.11 Second harmonic distortion

Even if a signal without harmonic distortion is input to a spectrum analyzer, the higher harmonics are generated by the analyzer input-mixer non-linearity and are displayed on the CRT.

The second harmonic level is the highest harmonic displayed on the MS2602A. The main point of the test is to apply a signal (with a distortion that is lower than the MS2602A internal harmonic distortion [ at least 20 dB below ] ) to the MS2602A and measure the level difference between the fundamental wave and the second harmonic. If a low-distortion signal source cannot be obtained, apply a low-distortion signal to the MS2602A after passing the signal through a low-pass filter ( LPF ).

#### (1) Specifications

- Second harmonic distortion:  $\leq -70$  dBc  
( at 5 to 800 MHz input frequencies, band 0, mixer input level  $-30$  dBm )  
 $\leq -80$  dBc  
( at 800 to 850 MHz input frequencies, band 0, mixer input level  $-30$  dBm )  
 $\leq -100$  dBc  
( at 850 MHz to 4.25 GHz input frequencies, band 1<sup>-</sup>, band 1<sup>+</sup>, mixer input level  $-20$  dBm )

#### (2) Test instruments

- Signal generator: MG3633A
- LPF: With attenuation of 70 dB or more at twice the fundamental frequencies

#### (3) Setup

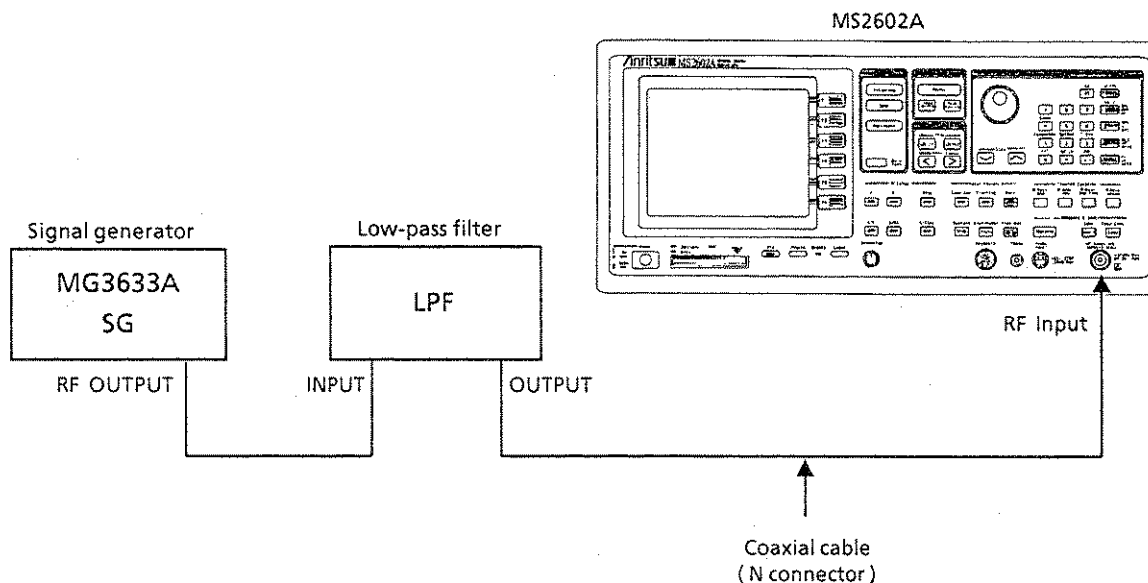

Second Harmonic Distortion Test

#### (4) Procedure

Step	Procedure
1	Press the [ Preset ] key.
2	Perform all calibration ( ALL CAL: Refer to SECTION 8 in the Detailed Operating Instruction Part of the separate operation manual ).
3	Set the LPF cut-off frequency to approx. 6.4 MHz.
4	Set the SG output frequency to 5.1 MHz and the output level to $-30$ dBm.
5	Set the MS2602A as shown below: CENTER FREQ ..... 5.1 MHz SPAN ..... 10 kHz REF LEVEL ..... $-30$ dBm ATT ..... 0 dB

- 6 Adjust the SG output level so that peak of the spectrum waveform is at the REF LEVEL ( the top horizontal line of the CRT ).
- 7 Move the marker to the peak of the spectrum waveform and make the marker the  $\Delta$  marker.

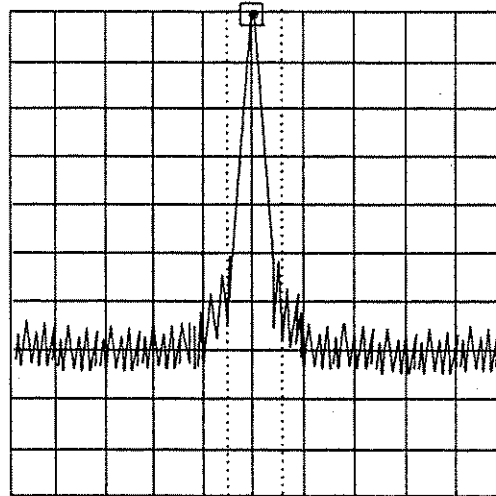

- 8 Set the center frequency to twice the fundamental wave frequency to display the second harmonic on the CRT.

The  $\Delta$  marker reading indicates the level difference between the fundamental wave and the second harmonic.

If the level difference is 80 dB or more, set the REF LEVEL to  $-50$  dBm. Confirm that the ATT set value is 0 dB.

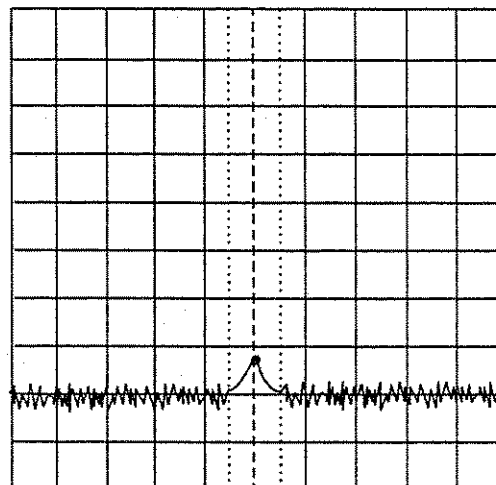

Step	Procedure
9	Set the LPF cut-off frequency to approx. 2 GHz.
10	Set the SG as follows:
	OUTPUT FREQ ..... 1.76 GHz
	OUTPUT LEVEL ..... -20 dBm
11	Set the MS2602A as follows:
	CENTER FREQ ..... 1.76 GHz
	SPAN ..... 10 kHz
	REF LEVEL ..... -20 dBm
	ATT ..... 0 dB
	BAND ..... 1
12	Repeats steps 6 to 8.

### 5.3.12 Resolution bandwidth ( RBW ) switching error

When the resolution bandwidth ( RBW ) is switched, its level error at the peak point is measured.

#### (1) Specifications

- Resolution bandwidth switching error:  $\pm 0.3$  dB ( 10 Hz to 3 MHz )

#### (2) Setup

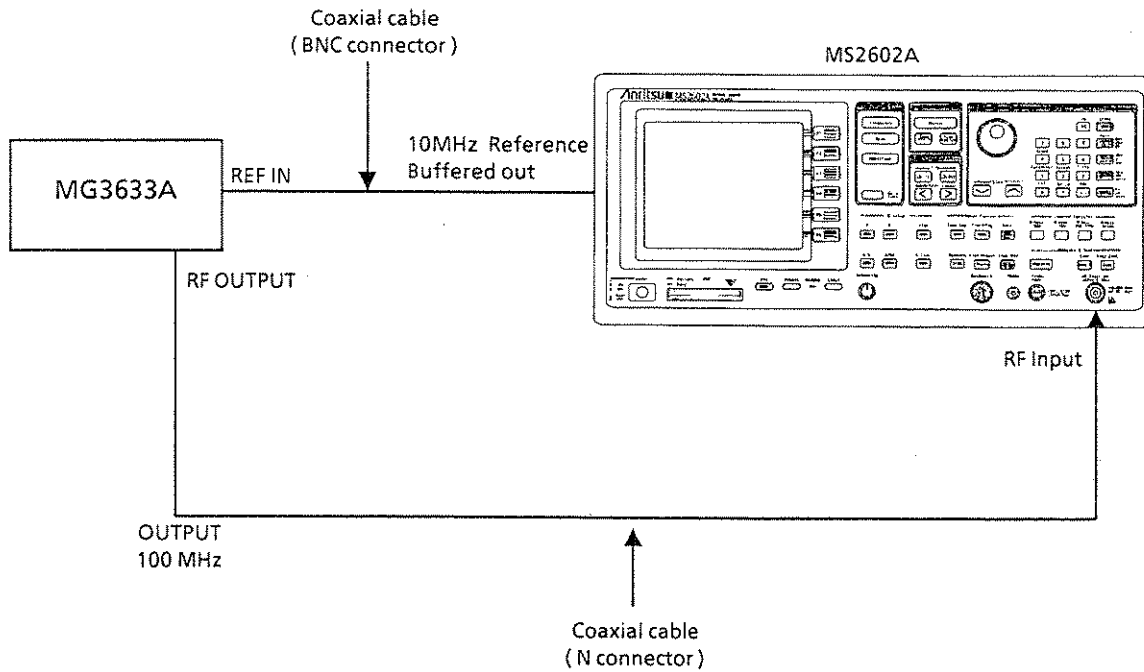

**Resolution Bandwidth Switching Error Test**

#### (4) procedure

---

Step	Procedure
1	Press the MS2602A [ Preset ] key.
2	Perform all calibration ( ALL CAL: Refer to SECTION 8 in the Detailed Operating is SECTION 8 of the separate operation manual ).
3	Set the signal generator MG3633A as shown below. OUTPUT FREQ ..... 100 MHz OUTPUT LEVEL ..... 0 dBm
4	Set the MS2602A as shown below. CENTER FREQ ..... 100 MHz SPAN ..... 200 kHz REF LEVEL ..... 0 dBm RBW ..... 3 kHz
5	Press the Peak [ → CF ] key to move the signal spectrum peak to the center.
6	Press [ Marker ] and [ F2 ] keys in that order to set the marker to $\Delta$ marker.
7	Set RBW and SPAN as shown in the table on the next page and measure the level deviation ( error ) of each RBW by following steps 8 and 9 below.
8	Press [ Peak Search ] key to conduct peak search and move the current marker to the peak point of the signal spectrum.
9	Read the $\Delta$ marker level value.

---



MS2602A setting		$\Delta$ marker reading	Specification
RBW	SPAN		
10 Hz	100 Hz		$\pm 0.3$ dB
30 Hz	200 Hz		$\pm 0.3$ dB
100 Hz	1 kHz		$\pm 0.3$ dB
300 Hz	1.5 kHz		$\pm 0.3$ dB
1 kHz	5 kHz		$\pm 0.3$ dB
3 kHz	15 kHz	0.0 dB	Reference
10 kHz	50 kHz		$\pm 0.3$ dB
30 kHz	150 kHz		$\pm 0.3$ dB
100 kHz	500 kHz		$\pm 0.3$ dB
300 kHz	1.5 MHz		$\pm 0.3$ dB
1 MHz	5 MHz		$\pm 0.3$ dB
3 MHz	10 MHz		$\pm 0.3$ dB

### 5.3.13 LOG / LIN scale switching error

Here, a level error is measured at the reference level when the vertical scale is switched between LOG and LIN.

#### (1) Specifications

- LOG / LIN scale switch error:  $\pm 0.3$  dB

#### (2) Test instrument

- Signal generator: MG3633A

#### (3) Setup

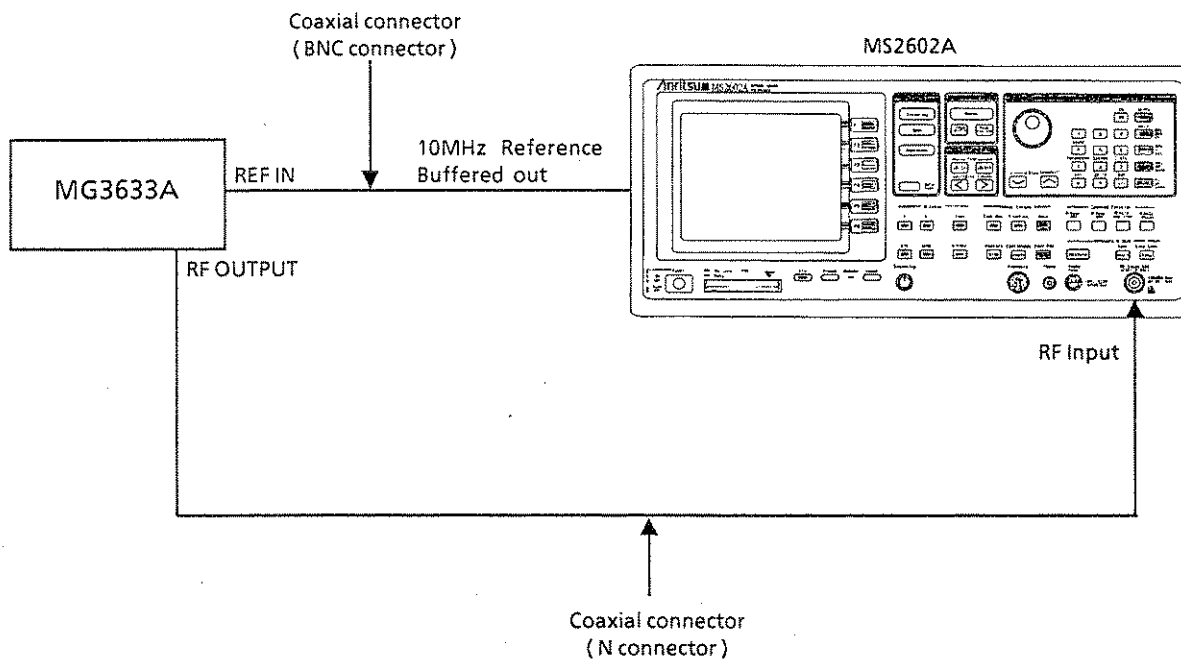

**LOG / LIN scale Switching Error Test**

#### (4) procedure

Step	Procedure
1	Press the MS2602A [ Preset ] key.
2	Perform all calibration ( ALL CAL: Refer to SECTION 8 in the Detailed Operating Instruction Part of the separate operation manual ).
3	Set the MS2602A as shown below. CENTER FREQ ..... 100 MHz SPAN ..... 200 kHz REF LEVEL ..... -10 dBm
4	Set the signal generator MG3633A as shown below. OUTPUT FREQ ..... 100 MHz OUTPUT LEVEL ..... -10 dBm
5	Press the Peak [ →CF ] key to move the signal spectrum peak to the center.
6	Read the marker level value and adjust the signal generator output level until this value is -10 dBm ±0.1 dB.
7	Press [ Amplitude ] and [ F4 ] keys in this order to switch the scale to linear ( LIN ).
8	Read the marker level value. When this value is between 68.3 mV and 73.2 mV, it meets specifications.

### 5.3.14 Input attenuator switching error

At this point, measure the switching error when the amount of attenuation in the RF input section is switched. When the input attenuator is switched, IF-section step-amplifier gain is switched. To keep this step-amplifier gain constant, the reference level is switched according to the amount of input attenuator attenuation.

#### (1) Specifications

- Input attenuator switching error:  $\pm 0.3$  dB ( with frequency of 100 MHz and input attenuator at 10 dB as reference )

#### (2) Test instruments

- Signal generator: MG3633A
- Attenuator: MN510C
- Power meter: ML4803A
- Power sensor: MA4601A

#### (3) Setup

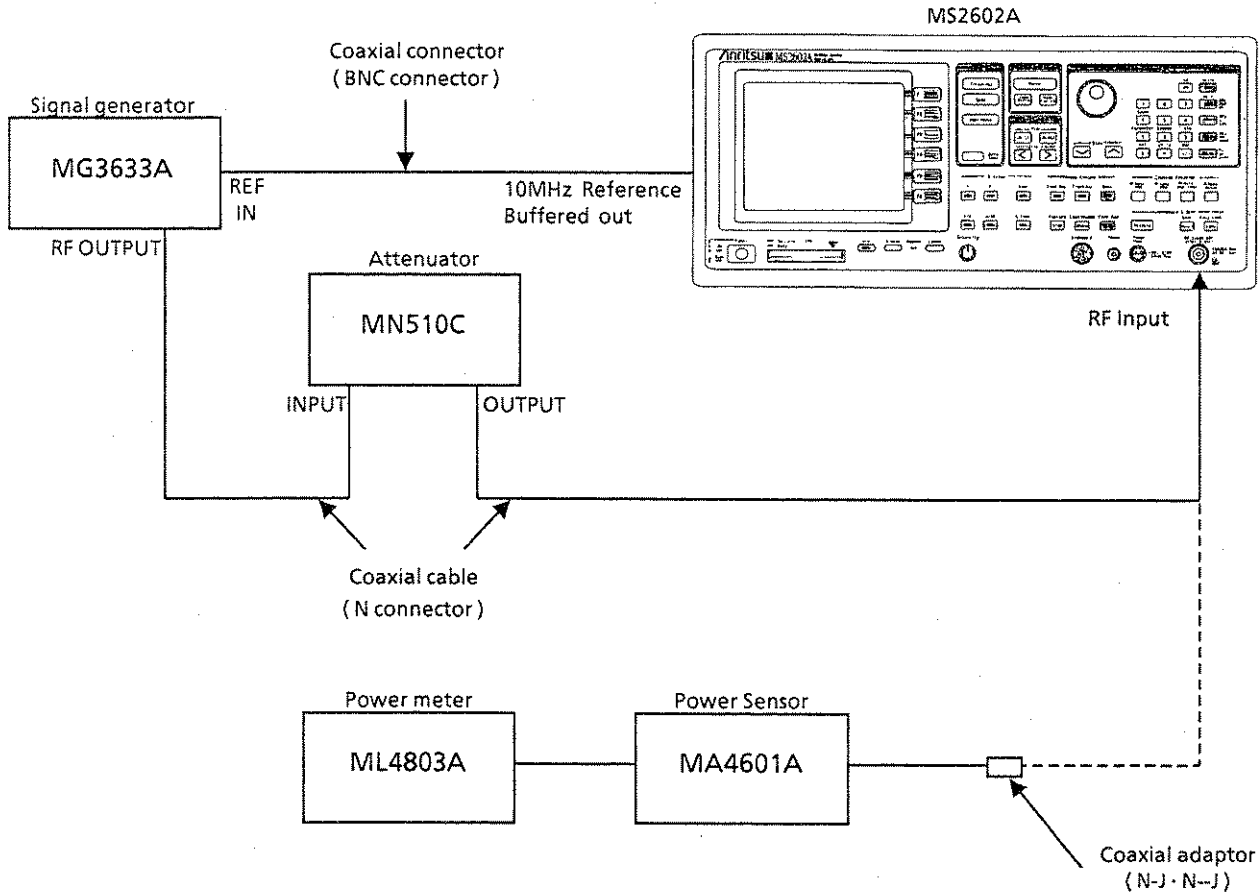

Input Attenuator Switching Error Test

#### (4) procedure

---

Step	Procedure
1	Press the MS2602A [ Preset ] key.
2	Perform all calibration ( ALL CAL: Refer to SECTION 8 in the Detailed Operating Instruction Part of the separate operation manual ).
3	Set the MS2602A as shown below: CENTER FREQ ..... 100 MHz SPAN ..... 200 kHz
4	Set the signal generator MG3633A as shown below: OUTPUT FREQ ..... 100 MHz OUTPUT LEVEL ..... -10 dBm
5	Set the amount of attenuation of the attenuator MN510C to 0 dB.
6	Connect the output of the attenuator MN510C to the power meter via coaxial cable.
7	Adjust the signal-generator output level so that the indicated value of the power meter is -10.0 dBm.
8	Connect the coaxial cable of the attenuator output to the MS2602A RF Input.
9	Press the MS2602A Peak [ → CF ] key.
10	Set the MS2602A reference level to -10.0 dBm and attenuation to 55 dB.
11	Read the marker level.
12	Set the reference level and amount of attenuation of the MS2602A, set the attenuator as shown in the table on the next page, and read the respective marker levels.
13	Find the error by the formula below: Error = marker level value - REF LEVEL - attenuator calibration value
14	Find the deviation by the formula below: Deviation = Error - error when ATT at 10 dB The test is O.K. if within $\pm 0.3$ dB.

---

MS2602A setting		Attenuator setting	Calibration value of attenuator	Marker level value	Error	Deviation
REF LEVEL	ATT					
-10 dBm	55 dB	0 dB	dB	dBm	dB	dB
-15 dBm	50 dB	5 dB	dB	dBm	dB	dB
-20 dBm	45 dB	10 dB	dB	dBm	dB	dB
-25 dBm	40 dB	15 dB	dB	dBm	dB	dB
-30 dBm	35 dB	20 dB	dB	dBm	dB	dB
-35 dBm	30 dB	25 dB	dB	dBm	dB	dB
-40 dBm	25 dB	30 dB	dB	dBm	dB	dB
-45 dBm	20 dB	35 dB	dB	dBm	dB	dB
-50 dBm	15 dB	40 dB	dB	dBm	dB	dB
-55 dBm	10 dB	45 dB	dB	dBm	dB	0 dB (reference)
-60 dBm	5 dB	50 dB	dB	dBm	dB	dB
-65 dBm	0 dB	55 dB	dB	dBm	dB	dB

### 5.3.15 Sweep time and time span accuracy

#### (1) Specifications

- Sweep time accuracy:  $\pm 10\%$  (20 msec to 200 sec)  
 $\pm 15\%$  (200 sec to 2000 sec)
- Time span accuracy:  $\pm 0.5\%$

#### (2) Test instruments

- Signal generator: MG3633A  
Wiltron 6769A

#### (3) Setup

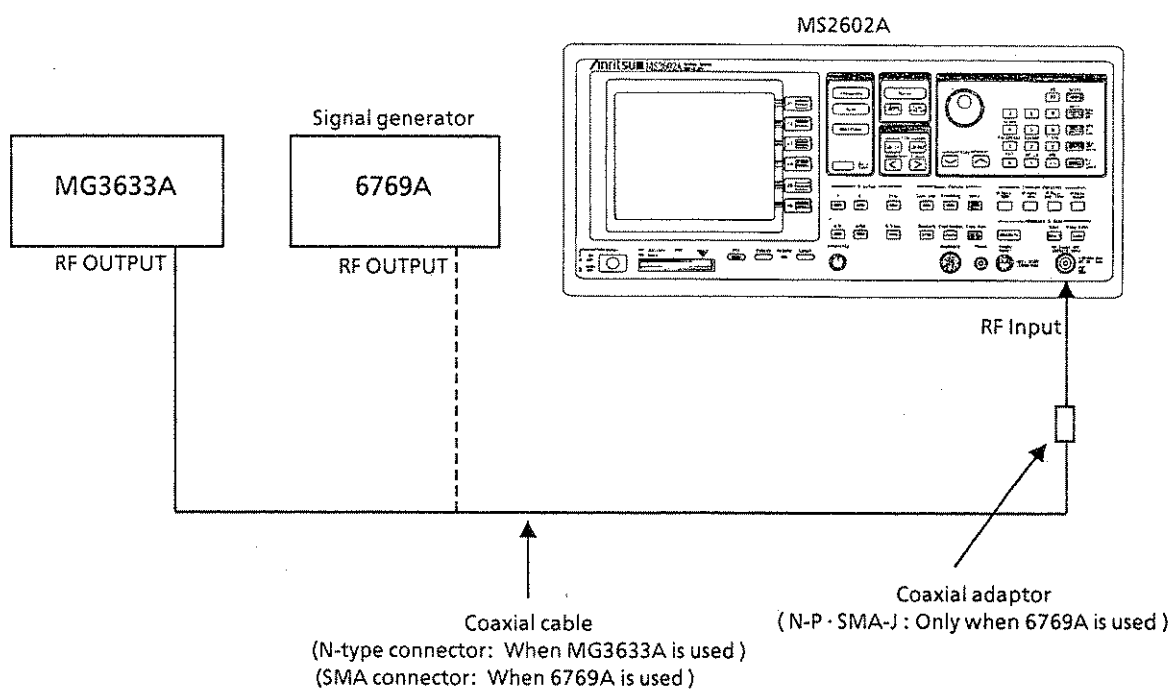

### Sweep Time and Time Span Accuracy

#### (4) procedure

##### (a) Sweep Time

- | Step | Procedure  |
|------|--|
| 1    | Press the MS2602A [Preset] key.  |
| 2    | Perform all calibration ( ALL CAL: Refer to SECTION 8 in the Detailed Operating Instruction Part of the separate operation manual ).   |
| 3    | Connect the MG3633A signal generator with the MS2602A as shown in the setup diagram.   |
| 4    | Set the MS2602A as shown below:<br>CENTER FREQ ..... 100 MHz<br>SPAN ..... 100 Hz<br>SWP TIME ..... 20 msec<br>RBW ..... 1 MHz<br>VBW ..... 1 MHz  |
| 5    | Set the MG3633A as shown below:<br>OUTPUT FREQ ..... 100 MHz<br>OUTPUT LEVEL ..... -16 dBm<br>MODULATION ..... AM (INT) 90%<br>MODULATION FREQ ..... 1 kHz                                     |
| 6    | Press the MS2602A Peak [ → Ref ] key.  |
| 7    | Set the MS2602A scale to LIN.  |
| 8    | Press the [ Single ] key, then wait until a single sweep execution is completed.   |
| 9    | Set the MS2602A marker zone width to 5 Hz ( ZONE WIDTH = 5 Hz ).   |
| 10   | Move the MS2602A marker to the left of the screen using the knob and set the zone marker on the leftmost peak of the sine wave.  |
| 11   | Setting the MS2602A marker mode to Δ ( delta ), move the current marker to the right using the knob. Then set the zone marker to the 18th peak from the leftmost sine wave peak on the screen. |
| 12   | Read the frequency display of the Δ marker.<br>Obtain the SWP TIME by the following expression.  |

$$\text{SWP TIME} = \text{Setting SWP TIME} \times \frac{\Delta \text{ marker reading}}{100 \text{ (Hz)}}$$

- 13 Measure at each setting shown in the table below according to steps 8 to 12.

MS2602A Setting SWP TIME	MG3633A AM modulation frequency	MS2602A SWP TIME	Specification min / max
20 msec	1 kHz		16.2 msec / 19.8 msec
200 msec	100 Hz		162 msec / 198 msec
2 sec	10 Hz		1.62 sec / 1.98 sec
20 sec	1 Hz		16.2 sec / 19.8 sec
200 sec	0.1 Hz		153 sec / 207 sec





(c) Time span: 50  $\mu$ sec to 100 msec

Step	Procedure
1	Press the MS2602A [ Preset ] key.
2	Perform all calibration ( ALL CAL: Refer to SECTION 8 in the Detailed Operating Instruction Part of the separate operation manual ).
3	Connect the signal-generator 6769A and the MS2602A as shown in the setup diagram.
4	Set the MS2602A as shown below: CENTER FREQ ..... 1 GHz SPAN ..... 0 Hz RBW ..... 1 MHz VBW ..... 1 MHz
5	Set the 6769A as shown below: CW OUTPUT FREQ ..... 1 GHz PULSE MODULATION ..... INT ( ON ) INT RATE ( repetitive period ) ..... 5 $\mu$ sec INT WIDTH ( pulse width ) ..... 0.5 $\mu$ sec RF LEVEL ..... -20 dBm
6	Press the MS2602A Peak [ $\rightarrow$ Ref ] key.
7	Set TIME SPAN to 50 $\mu$ sec.
8	Press the [ Single ] key, then wait until a single sweep execution is completed.
9	Move the MS2602A marker to the left of the display screen using the knob and set the marker to the leftmost pulse wave peak.
10	Set the MS2602A marker mode to $\Delta$ ( delta ). Then move the current marker to the right using the knob and set the zone marker to the 9th peak from the leftmost pulse wave peak on the display screen.
11	Read the time display of the $\Delta$ marker.
12	Measure at each setting shown in the table below according to steps 7 to 11.

Step

Procedure

MS2602A time span	6769A		MS2602A $\Delta$ marker reading	Specification min / max
	RATE	WIDTH		
50 $\mu$ sec	2.5 $\mu$ sec	25 nsec		44.775 $\mu$ sec / 45.225 $\mu$ sec
500 $\mu$ sec	25 $\mu$ sec	50 nsec		447.75 $\mu$ sec / 452.25 $\mu$ sec
5 msec	250 $\mu$ sec	500 nsec		4.4775 msec / 4.5225 msec
50 msec	2.5 msec	5 $\mu$ sec		44.775 msec / 45.225 msec

Leftmost peak

The 9th peak numbered from the leftmost peak

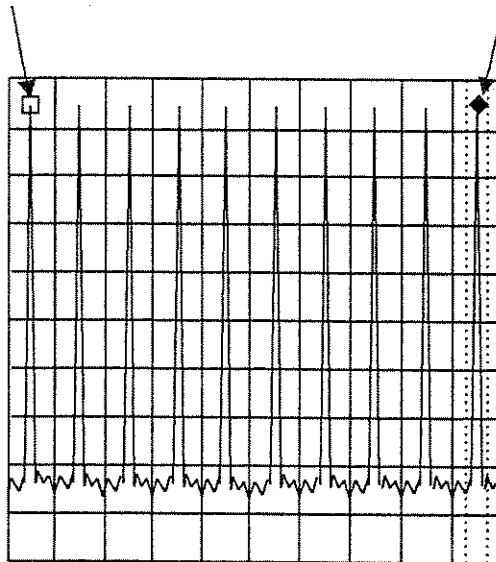

## 5.4 Service

If the MS2602A is damaged or does not operate as specified, contact your nearest Anritsu dealer or business office for repair. When you request repair, provide the following information.

- (1) Model name and serial number on rear panel
- (2) Fault description
- (3) Name of a personnel-in-charge and address for contact when fault confirmed or at a completion of repair

# SECTION 6 CALIBRATION

This section describes the measuring instruments required for calibration of the MS2602A, their setup and the calibration method.

## TABLE OF CONTENTS

6.1	Requirement for Calibration .....	6-3
6.2	Equipment Required for Calibration .....	6-3
6.3	Calibration .....	6-4
6.3.1	Calibrating reference-crystal-oscillator frequency .....	6-4

( Blank )

## SECTION 6 CALIBRATION

### 6.1 Requirement for Calibration

Calibration is carried out to help prevent degradation of performance of the MS2602A. Calibration should be performed periodically even if the MS2602A is operating normally.

Contact Anritsu if the MS2602A fails to meet the specifications during calibration.

### 6.2 Equipment Required for Calibration

The table below lists the equipment required for calibrating each item.

Table of Equipment Required for Calibration

Equipment	Major specification†	Calibration item
Oscilloscope	Capable of measuring 10 MHz ( external trigger possible )	Reference-crystal-oscillator frequency accuracy
Frequency standard	Standard radio-wave receiver or equipment having equivalent function ( accuracy better than $1 \times 10^{-9}$ )	Reference-crystal-oscillator frequency accuracy

† Extracts part of performance which can cover the measurement range of the test item.

## 6.3 Calibration

To calibrate the MS2602A, its internal reference oscillator frequency should be calibrated once or twice a year.

### 6.3.1 Calibrating reference-crystal-oscillator frequency

The stability of the MS2602A reference crystal oscillator is  $\pm 2 \times 10^{-8}$  / day. The following describes the method for calibrating the frequency of the reference crystal oscillator by using a reference signal generator generating a reference signal that is either locked to a standard wave, or to a received color-television sub-carrier ( signal locked to rubidium atomic standard ).

#### (1) Specifications

Reference crystal oscillator	Frequency	Aging rate	Temperature characteristics
Standard type	10 MHz	$\pm 2 \times 10^{-8}$ / day	$\pm 5 \times 10^{-8}$ ( 0 ~ 50 °C )
Option 01	10 MHz	$\pm 5 \times 10^{-9}$ / day	$\pm 3 \times 10^{-8}$ ( 0 ~ 50 °C )

#### (2) Instruments required for calibration

- Oscilloscope: 10 MHz, external trigger possible
- Frequency standard: Standard radio wave receiver or equipment having equivalent function ( accuracy better than  $1 \times 10^{-9}$  )



### (3) Setup

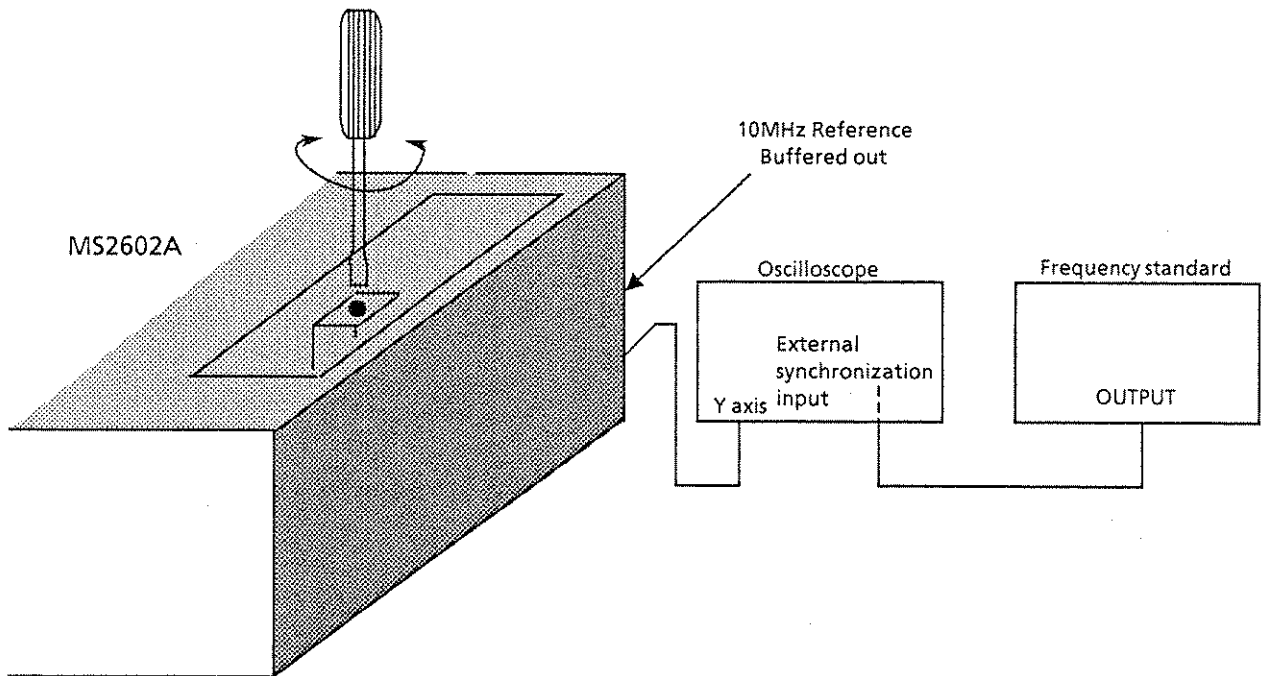

### Calibration of reference-crystal-oscillator frequency

#### (4) Precautions for Calibration

Applying a standard 10 MHz signal to the oscilloscope Y-axis produces a lissajous waveform. Adjust the reference oscillator frequency so that the waveform becomes a stationary circularity at Step 7.

#### (5) Calibration procedure

Step	Procedure
1	Set-up the equipment as shown in the figure above. The ambient temperature should be $25^{\circ}\text{C} \pm 5^{\circ}\text{C}$
2	Allow the reference crystal oscillator to warm-up for 24 hours by setting the Power switch on the front panel to the Stby position.
3	Then set the Power switch to On.
4	Apply the standard frequency signal to the external synchronization input of the oscilloscope, and the signal output from the 10 MHz Reference Buffered out connector on the MS2602A rear panel to the Y axis.
5	Adjust the oscilloscope so that the input waveform can be observed. If the input waveform moves right or left on the screen and synchronization is not possible, this means that the frequency of the reference crystal oscillator does not match the standard frequency.
6	Loosen the screw on the reference-crystal-oscillator case at the upper right under the top cover. Then open the calibration-hole cover, and adjust the potentiometer in the hole so that the input waveform stops moving left or right on the oscilloscope screen.

**( Blank )**

# SECTION 7

## STORAGE AND TRANSPORTATION

This section describes the long-term storage, repacking and transportation of the MS2602A as well as the regular care procedures and the timing.

### TABLE OF CONTENTS

7.1	Cleaning Cabinet .....	7-3
7.2	Storage Precautions .....	7-3
7.2.1	Precautions before storage .....	7-3
7.2.2	Recommended storage precautions .....	7-3
7.3	Repacking and Transportation .....	7-4
7.3.1	Repacking .....	7-4
7.3.2	Transportation .....	7-4

( Blank )

## 7.1 Cleaning Cabinet

Always turn the MS2602A POWER switch OFF and disconnect the power plug from the ac power inlet before cleaning the cabinet.

To clean the external cabinet:

- Use a soft, dry cloth for wiping off.
- Use a cloth moistened with diluted neutral cleaning liquid if the instrument is very dirty or before long-term storage.

After insuring that the cabinet has been thoroughly dried, use a soft, dry cloth for wiping off.

- If loose screws are found, tighten them with the appropriate tools.

---

<b>CAUTION</b>
----------------

---

*Never use benzene, thinner, or alcohol to clean the external cabinet; it may damage the coating, or cause deformation or discoloration.*

---

## 7.2 Storage Precautions

This paragraph describes the precautions to take for long-term storage of the MS2602A SPECTRUM ANALYZER.

### 7.2.1 Precautions before storage

- (1) Before storage, wipe dust, finger-marks, and other dirt off the MS2602A.
- (2) Avoid storing the MS2602A where:
  - 1) It may be exposed to direct sunlight or high dust levels.
  - 2) It may be exposed to high humidity.
  - 3) It may be exposed to active gases.
  - 4) It may be exposed to extreme temperatures ( $< -40^{\circ}\text{C}$  or  $> 70^{\circ}\text{C}$ ) or high humidity ( $\geq 90\%$ ).

### 7.2.2 Recommended storage precautions

The recommended storage conditions are as follows:

- Temperature: 0 to 30°C
- Humidity: 40% to 80%
- Stable temperature and humidity over 24-hour period

## 7.3 Repacking and Transportation

The following precautions should be taken if the MS2602A must be returned to Anritsu Corporation for servicing.

### 7.3.1 Repacking

Use the original packing materials. If the MS2602A is packed in other materials, observe the following packing procedure:

- (1) Wrap the MS2602A in a plastic sheet or similar material.
- (2) Use a cardboard, wooden box, or aluminum case which allows shock-absorbent material to be inserted on all sides of the equipment.
- (3) Use enough shock-absorbent material to protect the MS2602A from shock during transportation and to prevent it from moving in the container.
- (4) Secure the container with packing straps, adhesive tape or bands.

### 7.3.2 Transportation

Do not subject the MS2602A to severe vibration during transport. It should be transported under the storage conditions recommended in paragraph 7.2.

# APPENDIXES

## TABLE OF CONTENTS

APPENDIX A	MS2602A BLOCK DIAGRAM .....	A-1
APPENDIX B	LIST OF ABBREVIATIONS ON PANEL AND DISPLAY .....	B-1
APPENDIX C	FRONT AND REAR PANEL LAYOUT .....	C-1

(Blank)



## APPENDIX B

### LIST OF ABBREVIATIONS ON PANEL AND DISPLAY

Abbreviations on the MS2602A panels and display screens are spelled out below in alphabetical order.

Abbreviation	Spelling (Meaning)	Abbreviation	Spelling (Meaning)
A	Trace-A	MAX	Maximum Hold
ABS	Absolute	MEAS	Measure
AC	Alternating Current	MIN	Minimum Hold
ADJ	Adjacent	MKR	Marker
AM	Amplitude Modulation	MON	Monitor
AMPL	Amplitude	NEG	Negative Peak Detection
AT	Input Attenuator	NTSC	National Television System
ATTEN	Input Attenuator		Comittee
AVG	Average	OBW	Occupied Bandwidth
B	Trace-B	OVER	Over Write
BG	Trace-BG(Back Ground)	PMC	Plug-in Memory Card
BS	Back Space	PAL	Phase Alternation by Line
BW	Bandwidth		Television System
CAL	Calibration	POS	Positive Peak Detection
CALC	Calculation	POSN	Position
CE	Clear Entry	PRMTR	Parameter
CF	Center Frequency	PTA	Personal Test Automation
CH	Channel	PTR	Printer
C/N	Carrier to Noise Ratio	PLTR	Plotter
CONT	Control	RB	Resolution Bandwidth
CORR	Correction Data	RBt	Resolution Bandwidth
CTR	Center Frequency		(Time Domain)
CUM	Cumulative	RBW	Resolution Bandwidth
DC	Direct Current	REF	Reference Level
DET	Detection Mode	REL	Relative
DIR	Directory	RES	Resolution
DIV	Division	RLV	Reference Level
EXP	Expand	SC	Scale
EXT	External	SGL	Single (Sweep)
FD	Floppy Disk	SMP	Sample Detection
FM	Frequency Modulation	ST	Sweep Time
FREQ	Frequency	STBY	Standby
GPIB	General Purpose Interface	SWP	Sweep
	Bus	SWT	Sweep Time
GP-GL	Graphtec Plotter Graphics	T	Trace-Time
	Language	TEMP	Template
HP-GL	Hewlett Packard Graphics	TIME	Trace-Time
	Language	TR	Trace
H-SYNC	Horizontal Synchronizing	TRC	Trace
	Signal	TRIG	Trigger
INIT	Initiate	TRKG	Tracking
INT	Internal	TV	Television
LIN	Linear	VB	Video Bandwidth
LOG	Logarithmic	VBt	Video Bandwidth
LVL	Level		(Time Domain)
		VBW	Video Bandwidth
		V-SYNC	Vertical Synchronizing Signal

(Blank)

# APPENDIX C

## FRONT AND REAR PANEL LAYOUT

How to read the soft key menu, soft key list, and front and rear panel layout are presented in Table C-1 and C-2 and in Figs. C-2 and C-3 respectively. Numbers are assigned to keys, connectors, and indicators on the operation panel. For your reference, the various panel functions corresponding to the assigned numbers are described in SECTION 3.

Table C-1 .....	How to Read the Soft Key Menu
Table C-2 .....	Soft Key List
Fig. C-2 .....	Front Panel
Fig. C-3 .....	Rear Panel

( Blank )

APPENDIX A MS2602A BLOCK DIAGRAM

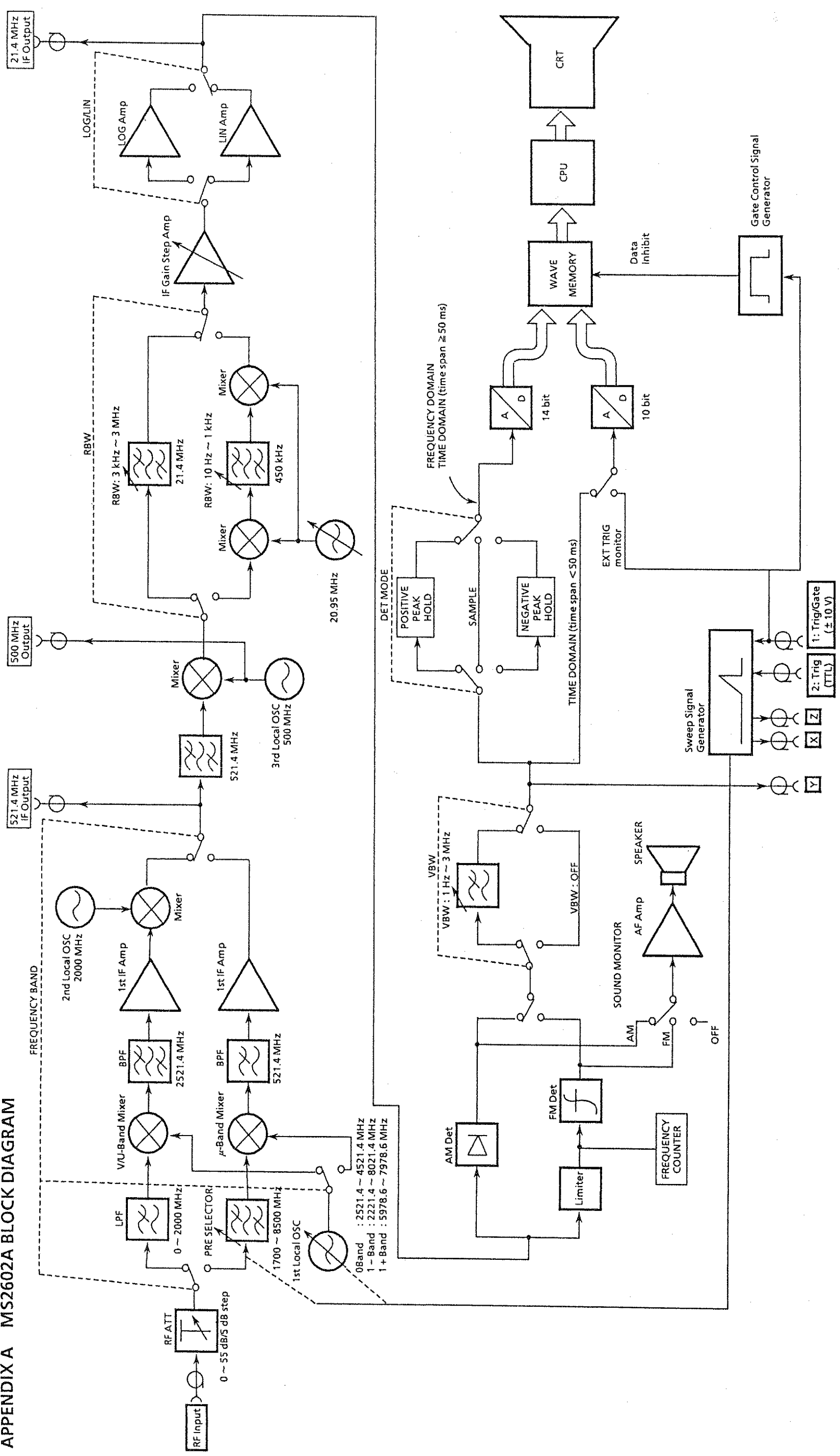

Fig. A-1 MS2602A Spectrum Analyzer Block Diagram

(Blank)



Table C-2 Soft Key List ( 2 / 9 )

Freq / Ampl		Amplitude							Function setting by soft key						Panel section name						
Amplitude		F2	F3	F4	F5	F5	F5	F6	F6	F1	F6	F2	F2	F6	F6	F3	F4	F5	F6		
Amplitude	AMPD(1/2)	REF LVL STEP	LOG SCALE	LIN SCALE	LOG SC UNIT1	LOG SC UNIT2	AMPD(2/2)	RLV OFFSET	CORRECTION	SELECT CORR	DISPLD LINE	RLV_OFFSET	CORRECTION	SELECT CORR	CORR-1	CORR-2	CORR-3	CORR-4	CORR-5	DISPLAY LINE	
Amplitude		1div	10dB/div	10%/div	dBm	dB $\mu$ V (emf)	REF LEVEL OFFSET	ENTRY OFFSET 0.0dB	CORRECTION ON OFF	CORR-1	LINE ON OFF	RLV_OFFSET ON OFF	CORRECTION ON OFF	SELECT CORR	CORR-1	CORR-2	CORR-3	CORR-4	CORR-5	LINE ON OFF	
		2div	5dB/div	5%/div	dB $\mu$ V	W	* CORRECTION	ENTRY OFFSET 0.0dB	* SELECT CORR	CORR-2	ENTRY LINE LEVEL -50.00dBm	ENTRY OFFSET 0.0dB	* CORRECTION	* SELECT CORR	CORR-2	CORR-2	CORR-3	CORR-4	CORR-5	ENTRY LINE LEVEL -50.00dBm	
		5div	2dB/div	2%/div	dBmV		* DISPLAY LINE			CORR-3	MKR_LEVEL ABS REL				CORR-3	CORR-3	CORR-4	CORR-5	CORR-5	MKR_LEVEL ABS REL	
		10div	1dB/div	1%/div	V	etc.				CORR-4					CORR-4	CORR-4	CORR-5	CORR-5	CORR-5		
		MANUAL			etc.	etc.	etc.			CORR-5					CORR-5	CORR-5	CORR-5	CORR-5	CORR-5		
		RETURN	RETURN	RETURN	RETURN	RETURN	etc.	RETURN	RETURN	RETURN	RETURN	RETURN	RETURN	RETURN	RETURN	RETURN	RETURN	RETURN	RETURN	RETURN	RETURN
		0.1 to 100dB						-90 to +60dB													

☆ The operation child menu is classified into three different styles as follows:  
 ☆ The menu is then displayed. Select the function corresponding to the [F1] to [F6] soft keys in the rightmost column.  
 ☆ The soft key with the double frame indicates the settings when initialized.  
 ☆ (The coupled function is set to MANUAL because of the panel key operation.)





Table C-2 Soft Key List (4 / 9)

Display		Panel section name					
		Panel key name					
		Key operation					
		Menu classification					
		Function setting by soft key					
A		F2	F3	F5	F6		
		MAX/MIN/AVG	CUM/OVER	DET MODE	DISPLAY LINE		
B		F2	F3	F5	F6		
		MAX/MIN/AVG	CUM/OVER	DET MODE	DISPLAY LINE		
A		F2	F3	F5	F6		
		MAX HOLD	CUMULATIVE	POS PEAK	LINE ON/OFF		
B		F2	F3	F5	F6		
		MIN HOLD	OVERWRITE	SAMPLE	ENTRY LINE LEVEL -50.00dBm		
A		F2	F3	F5	F6		
		AVVERAGE		NEG PEAK	MKR LEVEL ABS REL		
B		F2	F3	F5	F6		
		ENTRY AVERAGE 8					
A		F2	F3	F5	F6		
		VIEW					
B		F2	F3	F5	F6		
		DET MODE					
A		F2	F3	F5	F6		
		DISPLAY LINE					
B		F2	F3	F5	F6		
A		F2	F3	F5	F6		
B		F2	F3	F5	F6		
A		F2	F3	F5	F6		
B		F2	F3	F5	F6		
A		F2	F3	F5	F6		
B		F2	F3	F5	F6		
A		F2	F3	F5	F6		
B		F2	F3	F5	F6		
A		F2	F3	F5	F6		
B		F2	F3	F5	F6		
A		F2	F3	F5	F6		
B		F2	F3	F5	F6		
A		F2	F3	F5	F6		
B		F2	F3	F5	F6		
A		F2	F3	F5	F6		
B		F2	F3	F5	F6		
A		F2	F3	F5	F6		
B		F2	F3	F5	F6		
A		F2	F3	F5	F6		
B		F2	F3	F5	F6		
A		F2	F3	F5	F6		
B		F2	F3	F5	F6		
A		F2	F3	F5	F6		
B		F2	F3	F5	F6		
A		F2	F3	F5	F6		
B		F2	F3	F5	F6		
A		F2	F3	F5	F6		
B		F2	F3	F5	F6		
A		F2	F3	F5	F6		
B		F2	F3	F5	F6		
A		F2	F3	F5	F6		
B		F2	F3	F5	F6		
A		F2	F3	F5	F6		
B		F2	F3	F5	F6		
A		F2	F3	F5	F6		
B		F2	F3	F5	F6		
A		F2	F3	F5	F6		
B		F2	F3	F5	F6		
A		F2	F3	F5	F6		
B		F2	F3	F5	F6		
A		F2	F3	F5	F6		
B		F2	F3	F5	F6		
A		F2	F3	F5	F6		
B		F2	F3	F5	F6		
A		F2	F3	F5	F6		
B		F2	F3	F5	F6		
A		F2	F3	F5	F6		
B		F2	F3	F5	F6		
A		F2	F3	F5	F6		
B		F2	F3	F5	F6		
A		F2	F3	F5	F6		
B		F2	F3	F5	F6		
A		F2	F3	F5	F6		
B		F2	F3	F5	F6		
A		F2	F3	F5	F6		
B		F2	F3	F5	F6		
A		F2	F3	F5	F6		
B		F2	F3	F5	F6		
A		F2	F3	F5	F6		
B		F2	F3	F5	F6		
A		F2	F3	F5	F6		
B		F2	F3	F5	F6		
A		F2	F3	F5	F6		
B		F2	F3	F5	F6		
A		F2	F3	F5	F6		
B		F2	F3	F5	F6		
A		F2	F3	F5	F6		
B		F2	F3	F5	F6		
A		F2	F3	F5	F6		
B		F2	F3	F5	F6		
A		F2	F3	F5	F6		
B		F2	F3	F5	F6		
A		F2	F3	F5	F6		
B		F2	F3	F5	F6		
A		F2	F3	F5	F6		
B		F2	F3	F5	F6		
A		F2	F3	F5	F6		
B		F2	F3	F5	F6		
A		F2	F3	F5	F6		
B							



Table C-2 Soft Key List ( 6 / 9 )

Sweep Control				Coupled Function						Panel section name
Gate	Trig			RBW	VBW	Swp Time	Atten	Panel key name		
Gate	Free Run TRIG	F3	TRIG SOURCE	Auto RBW	Auto VBW	Auto Swp Time	Auto Atten	Key operation		
GATE	TRIG	TRIG SOURCE	TRIG	RBW	VBW	Swp Time	ATTEN	Menu classification		
GATE ON OFF	TRIG FREE RUN TRIGGERED	VIDEO	TV NTSC PAL	MANUAL	MANUAL	TIME SPAN	MANUAL	F1		
ENTRY GATE DELAY 0 $\mu$ s	LINE	INPUT 1 ( $\pm 10V$ )	V-SYNC	AUTO	AUTO		AUTO	F2		
ENTRY GATE LENGTH 1.000ms	EXT *	INPUT 2 (TTL)	H-SYNC EVEN	OFF	OFF			F3		
GATE END INT EXT	TV *		H-SYNC ODD	ENTRY FREQ VB/RB RATIO	ENTRY TIME VB/RB RATIO			F4		
	TRIG LEVEL 0%		ENTRY H-SYNC LINE 10	RB, VB, SWT AUTO	RB, VB, SWT AUTO			F5		
	TRIG SLOPE RISE FALL	RETURN	RETURN	ALL AUTO	ALL AUTO		ALL AUTO	F6		
0 to 65.5 msec				10 Hz to 3 MHz	1 Hz to 3 MHz	20 m to 1000 sec	0 to 55 dB	F1	● Data knob selection	
20 $\mu$ to 65.5 msec								F2	● Scroll selection	
								F3		
								F4		
-100 to +100% (Trig source: at VIDEO) -10 to +10 V (Trig source: at EXT)				0.0001 to 100	0.0001 to 100			F5		
								F6		

☆ The operation child menu is classified into three different styles as follows:  
 1st child (diagonal lines) 2nd child (dotted) 3rd child (horizontal lines)

☆ The details of the menu for the Measure function is shown by the operation flowchart regardless of the classification.  
 ☆ First press the panel keys in the ←key operation row. Press these keys including the [Shift] key etc. in the left to right direction.  
 ☆ The menu is then displayed. Select the function corresponding to the [F1] to [F6] soft keys in the rightmost column.  
 ☆ The soft key with the double frame indicates the settings when initialized.  
 (The coupled function is set to MANUAL because of the panel key operation.)



Table C-2 Soft Key List ( 7 / 9 )

Measure & Save		Copy Cont						Panel section name	
Recall			Save			Copy Cont			Panel key name
Key	Operation	Function	Key	Operation	Function	Key	Operation	Function	Function setting by soft key
[Shift][Recall]	RECALL	MEMORY No.	[Shift][Save]	SAVE	SAVE MEMORY No.	[F3]	SETUP PTR	HP2225	ITEM
[F5]	PMC	FILE No.	[F5]	PMC	SAVE FILE No.	[F2]	SETUP PLTR	HP-GL HP-GL	LOCATION
[F5]	DIR/NEXT	DIR/NEXT	[F5]	DIR/NEXT	DIR/NEXT	[F3]	PAPER SIZE	EPSON VP-800	PAPER SIZE
[F5]	MEM DIR	MEM DIR	[F5]	MEM DIR	MEM DIR	[F2]	SELECT MEDIA	UA455A	LOCATION
[F5]	EXT PMC2	EXT PMC2	[F5]	EXT PMC2	EXT PMC2	[F3]	SELECT MEDIA	MC8104A	ITEM
[F5]	EXT PMC1	EXT PMC1	[F5]	EXT PMC1	EXT PMC1	[F5]	SELECT MEDIA	ENTRY PRINTER ADDRESS: 17	RETURN
[F5]	INT PMC	INT PMC	[F5]	INT PMC	INT PMC	[F5]	SELECT MEDIA	ENTRY PLOTTER ADDRESS: 18	RETURN
[F5]	EXT FD	EXT FD	[F5]	EXT FD	EXT FD	[F5]	SELECT MEDIA	RETURN	RETURN
[F5]	EXT FD	EXT FD	[F5]	EXT FD	EXT FD	[F5]	SELECT MEDIA	RETURN	RETURN
[F5]	SELECT MEDIA	SELECT MEDIA	[F5]	SELECT MEDIA	SELECT MEDIA	[F5]	SELECT MEDIA	RETURN	RETURN
[F5]	RETURN	RETURN	[F5]	RETURN	RETURN	[F5]	SELECT MEDIA	RETURN	RETURN
[F5]	PMC	PMC	[F5]	PMC	PMC	[F5]	SELECT MEDIA	RETURN	RETURN
[F5]	RECALL_ITEM REC&PRMER PRNTR ONLY	RECALL_ITEM REC&PRMER PRNTR ONLY	[F5]	RECALL_ITEM REC&PRMER PRNTR ONLY	RECALL_ITEM REC&PRMER PRNTR ONLY	[F5]	RECALL_ITEM REC&PRMER PRNTR ONLY	RECALL_ITEM REC&PRMER PRNTR ONLY	RECALL_ITEM REC&PRMER PRNTR ONLY
1 to 16	1 to 99	1 to 16	1 to 99	1 to 16	1 to 99	1 to 99	1 to 16	1 to 99	1 to 99

☆ The operation child menu is classified into three different styles as follows:  
 1st child: [White style]  
 2nd child: [Diagonal lines style]  
 3rd child: [Hatched style]

☆ The details of the menu for the Measure function is shown by the operation flowchart regardless of the classification.  
 ☆ First press the panel keys in the ← key operation row. Press these keys including the [Shift] key etc. in the left to right direction.  
 ☆ The menu is then displayed. Select the function corresponding to the [F1] to [F6] soft keys in the rightmost column.  
 ☆ The soft key with the double frame indicates the settings when initialized.  
 ☆ (The coupled function is set to MANUAL because of the panel key operation.)

Table C-2 Soft Key List ( 8 / 9 )

Panel section name		GP-IB						Function setting by soft key																							
Panel key name		← Key operation		← Menu classification																											
		Key operation		Menu classification																											
Cal	Shift Cal 0	F6	PRESEL TUNE	AUTO TUNE	ENTRY MANUAL 0	PRESET	RETURN	1st child	2nd child	3rd child																					
														CAL																	
														ALL																	
														LEVEL																	
Entry	Shift GP-IB	F4	RS232C	BAUD RATE	PARITY	DATA_BIT	STOP BIT	RETURN																							
														9600	600	EVEN	7bit	1bit													
														4800	300	ODD	8bit	1.5bit													
														2400		OFF		2bit													
														1200																	
														etc.																	
														etc.																	
														RETURN	RETURN	RETURN	RETURN	RETURN													
														GP-IB	Shift GP-IB	F4	BAUD RATE1	BAUD RATE2	PARITY	STOP BIT	RETURN										
																												9600	600	EVEN	1bit
																												4800	300	ODD	1.5bit
																												2400		OFF	2bit
1200																															
etc.																															
etc.																															
RETURN	RETURN	RETURN	RETURN	RETURN																											
GP-IB	Shift GP-IB	F4	GP-IB	ENTRY PORT1 MY ADDRESS: 1	ENTRY PORT2 MY ADDRESS: 16	ENTRY MC8104A ADDRESS: 19	RS232C (OPTION02)	RETURN																							
																												0 to 30			
																												-128 to 127			
																												0 to 30			
														0 to 30																	

☆ The operation child menu is classified into three different styles as follows:  
 1st child (diagonal lines) 2nd child (horizontal lines) 3rd child (vertical lines)

☆ The details of the menu for the Measure function is shown by the operation flowchart regardless of the classification.  
 ☆ First press the panel keys in the ←key operation row. Press these keys including the [Shift] key etc. in the left to right direction.  
 ☆ The menu is then displayed. Select the function corresponding to the [F1] to [F6] soft keys in the rightmost column.  
 ☆ The soft key with the double frame indicates the settings when initialized.  
 ☆ (The coupled function is set to MANUAL because of the panel key operation.)

Table C-2 Soft Key List (9/9)

Entry				Function setting by soft key				Panel section name
PMC		Entry		Parameter	System	Title	Sound	Panel key name
								Key operation
PMC	DIRECTORY	DIRECTORY	TRACE FILES	PRMTR	SYSTEM	TITLE	SOUND	Menu classification
DIRECTORY	TRACE FILES	TRACE FILES	DIR/NEXT	LIST PAGE1	SYSTEM	---	AM	F1
FORMAT	DELETE FILE No.	DELETE FILE No.	DELETE	LIST PAGE2	AUTO_SWL	DISPLAY OFF	FM	F2
FORMAT	WRITE PROTECTION FILE No.	WRITE PROTECTION FILE No.	FORMAT	OFF	NORMAL FAST	CURSOR ←	OFF	F3
SELECT MEDIA	RETURN	RETURN	FORMAT		DATA_POINTS	CURSOR →		F4
SELECT MEDIA	RETURN	RETURN	APPLY		583 1002	ABC..Z		F5
	RETURN	RETURN	RETURN		COUPLE_MODE	abc..z		F6
	RETURN	RETURN	RETURN		COMMON INDEPENDENT	0123..		
	RETURN	RETURN	RETURN		DATE/TIME			
	1 to 99	1 to 99	RETURN		ENTRY VOLUME 10			

☆ The operation child menu is classified into three different styles as follows:

☆ 1st child

☆ 2nd child

☆ 3rd child

☆ The details of the menu for the Measure function is shown by the operation flowchart regardless of the classification.

☆ First press the panel keys in the ←-key operation row. Press these keys including the [Shift] key etc. in the left to right direction. The menu is then displayed. Select the function corresponding to the [F1] to [F6] soft keys in the rightmost column. The soft key with the double frame indicates the settings when initialized. (The coupled function is set to MANUAL because of the panel key operation.)

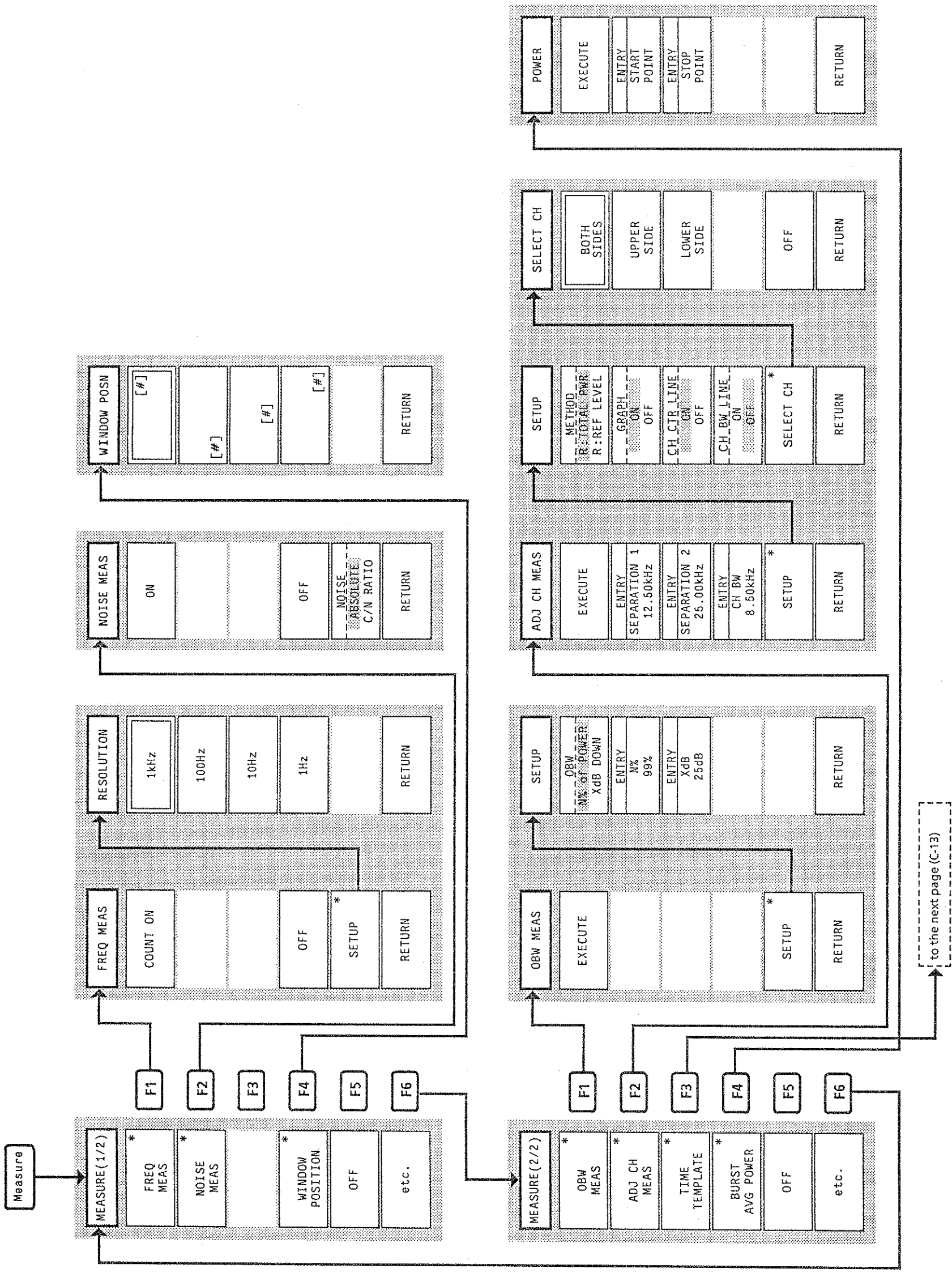



from the preceding page (C-12)

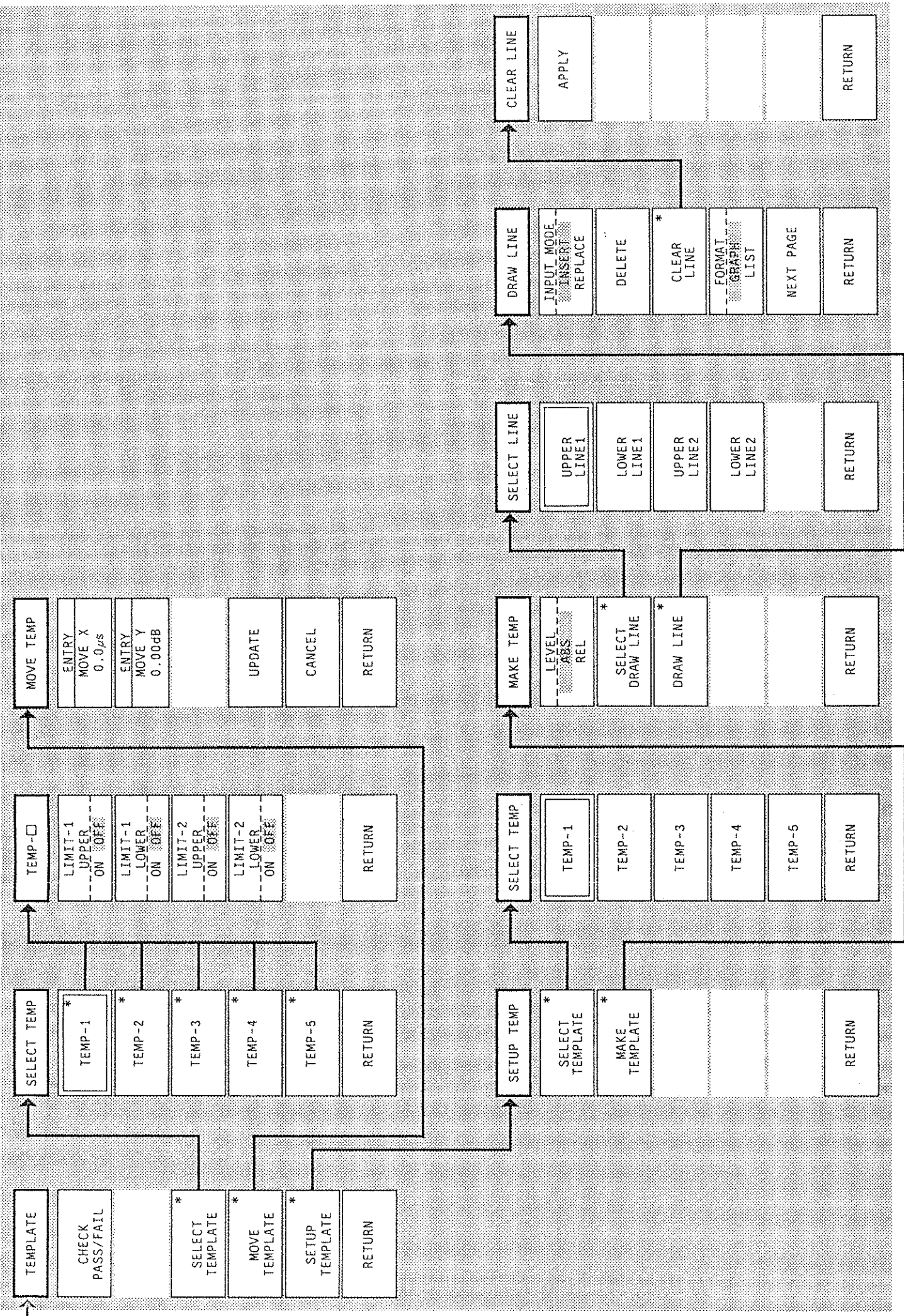

(Blank)

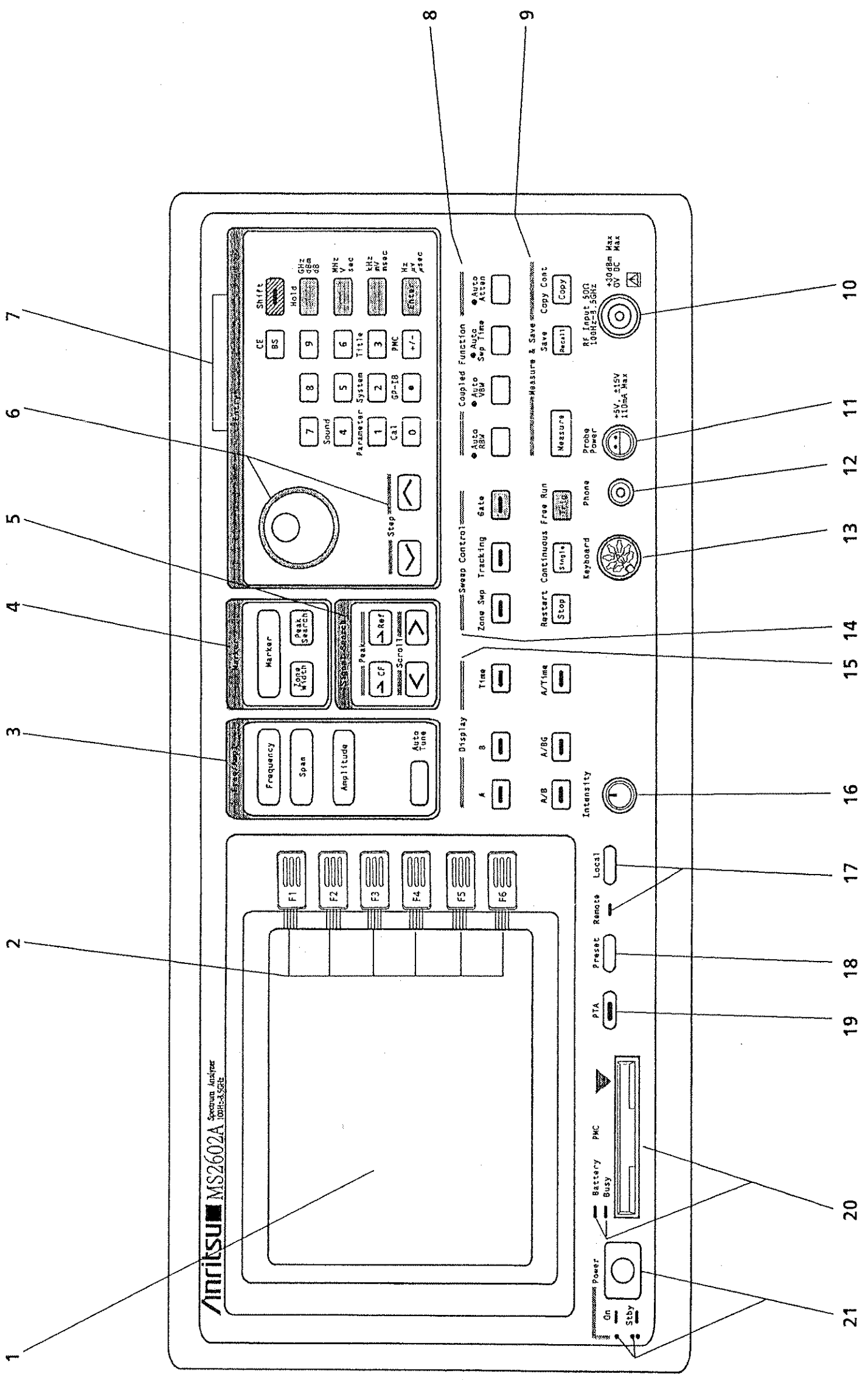

Fig. C-2 Front Panel

(Blank)

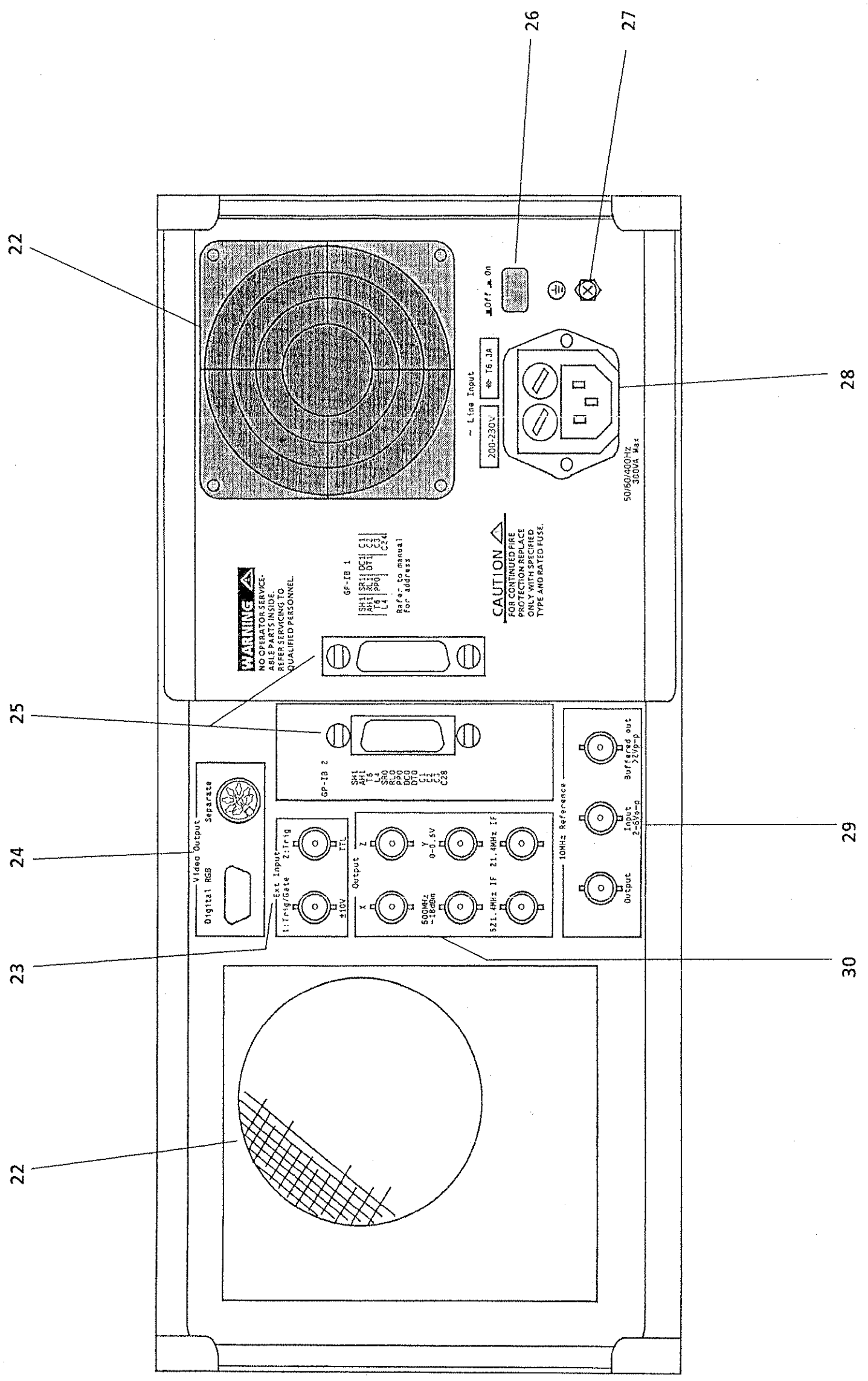

Fig. C-3 Rear Panel

(Blank)