

MS2650/MS2660 Series
Spectrum Analyzer
Operation Manual
Vol. 1
(Basic Operating Instructions)

Fifth Edition

**Read this manual before using the equipment.
Keep this manual with the equipment.**

ANRITSU CORPORATION

FEB.
2004

Document No.: M-W1154AE-5.0

Safety Symbols

To prevent the risk of personal injury or loss related to equipment malfunction, Anritsu Corporation uses the following safety symbols to indicate safety-related information. Insure that you clearly understand the meanings of the symbols BEFORE using the equipment.

Symbols used in manual

DANGER  This indicates a very dangerous procedure that could result in serious injury or death if not performed properly.

WARNING  This indicates a hazardous procedure that could result in serious injury or death if not performed properly.

CAUTION  This indicates a hazardous procedure or danger that could result in light-to-severe injury, or loss related to equipment malfunction, if proper precautions are not taken.

Safety Symbols Used on Equipment and in Manual

(Some or all of the following five symbols may not be used on all Anritsu equipment. In addition, there may be other labels attached to products which are not shown in the diagrams in this manual.)

The following safety symbols are used inside or on the equipment near operation locations to provide information about safety items and operation precautions. Insure that you clearly understand the meanings of the symbols and take the necessary precautions BEFORE using the equipment.



This indicates a prohibited operation. The prohibited operation is indicated symbolically in or near the barred circle.



This indicates an obligatory safety precaution. The obligatory operation is indicated symbolically in or near the circle.



This indicates warning or caution. The contents are indicated symbolically in or near the triangle.



This indicates a note. The contents are described in the box.



These indicate that the marked part should be recycled.

MS2650/MS2660 Series Spectrum Analyzer
Operation Manual Vol. 1 (Basic Operating Instructions)

July 1996 (First Edition)
June 1997 (Fifth Edition)

Copyright © 1996-1997, ANRITSU CORPORATION.

All rights reserved. No part of this manual may be reproduced without the prior written permission of the publisher.
The contents of this manual may be changed without prior notice.

Printed in Japan

For Safety

WARNING



1. ALWAYS refer to the operation manual when working near locations at which the alert mark shown on the left is attached. If the operation, etc., is performed without heeding the advice in the operation manual, there is a risk of personal injury. In addition, the equipment performance may be reduced.
Moreover, this alert mark is sometimes used with other marks and descriptions indicating other dangers.



2. When supplying power to this equipment, connect the accessory 3-pin power cord to a 3-pin grounded power outlet. If a grounded 3-pin outlet is not available, before supplying power to the equipment, use a conversion adapter and ground the green wire, or connect the frame ground on the rear panel of the equipment to ground. If power is supplied without grounding the equipment, there is a risk of receiving a severe or fatal electric shock.

Repair

WARNING 

3. This equipment cannot be repaired by the user. DO NOT attempt to open the cabinet or to disassemble internal parts. Only Anritsu-trained service personnel or staff from your sales representative with a knowledge of electrical fire and shock hazards should service this equipment. There are high-voltage parts in this equipment presenting a risk of severe injury or fatal electric shock to untrained personnel. In addition, there is a risk of damage to precision parts.

Falling Over

4. This equipment should be used in the correct position. If the cabinet is turned on its side, etc., it will be unstable and may be damaged if it falls over as a result of receiving a slight mechanical shock.

For Safety

WARNING

LCD

-
5. This instrument uses a Liquid Crystal Display (LCD);
DO NOT subject the instrument to excessive force or drop it. If the LCD is subjected to strong mechanical shock, it may break and liquid may leak.

This liquid is very caustic and poisonous.

DO NOT touch it, ingest it, or get in your eyes. If it is ingested accidentally, spit it out immediately, rinse your mouth with water and seek medical help. If it enters your eyes accidentally, do not rub your eyes, irrigate them with clean running water and seek medical help. If the liquid gets on your skin or clothes, wash it off carefully and thoroughly.

Battery fluid

6. DO NOT short the battery terminals and never attempt to disassemble it or dispose of it in a fire. If the battery is damaged by any of these actions, the battery fluid may leak.

This fluid is poisonous.

DO NOT touch it, ingest it, or get in your eyes. If it is accidentally ingested, spit it out immediately, rinse your mouth with water and seek medical help. If it enters your eyes accidentally, do not rub your eyes, irrigate them with clean running water and seek medical help. If the liquid gets on your skin or clothes, wash it off carefully and thoroughly.

For Safety

CAUTION

Changing Fuse

CAUTION

Cleaning

Check Terminal



1. Before changing the fuses, ALWAYS remove the power cord from the power outlet and replace the blown fuses. ALWAYS use new fuses of the type and rating specified on the fuse marking on the rear panel of the cabinet.

T5A indicates a time-lag fuse.

There is risk of receiving a fatal electric shock if the fuses are replaced with the power cord connected.

2. Keep the power supply and cooling fan free of dust.
 - Clean the power inlet regularly. If dust accumulates around the power pins, there is a risk of fire.
 - Keep the cooling fan clean so that the ventilation holes are not obstructed. If the ventilation is obstructed, the cabinet may over-heat and catch fire.

3. MS2651A/2661A

- Maximum DC voltage ratings:

RF Input ± 50 Vdc

TG Output 0 Vdc

- Maximum AC power ratings:

RF Input +30 dBm

-10 dBm — When Option 08 Pre-amplifier is mounted.

TG Output +20 dBm

- NEVER input a $>+30$ dBm(+10 dBm for Option 08) and $>\pm 50$ Vdc power to RF Input.
- NEVER input a >0 Vdc (when Option 19 DC coupling input is mounted) power to RF Input.
- NEVER input a $>+20$ dBm and >0 Vdc reverse power to TG Output.
- Excessive power may damage the internal circuits.

MS2653A/2663A

- Maximum DC voltage ratings:

RF Input 0 Vdc

- Maximum AC power ratings:

RF Input +30 dBm

- NEVER input a $>+30$ dBm and >0 Vdc power to RF Input.
- Excessive power may damage the internal circuits.

For Safety

CAUTION

Replacing Memory Back-up Battery

4. The power for memory backup is supplied by a Polycarbonmonofluoride Lithium Battery. This battery should only be replaced by a battery of the same type; since replacement can only be made by Anritsu, contact the nearest Anritsu representative when replacement is required.

Note: *The Battery life is about 7 years. Early battery replacement is recommended.*

Storage Medium

5. This equipment stores data and programs using Plug-in Memory card (MC).
Data and programs may be lost due to improper use or failure.
ANRITSU therefore recommends that you backup the memory.

ANRITSU CANNOT COMPENSATE FOR ANY MEMORY LOSS.

Please pay careful attention to the following points.

- Do not remove the IC card from equipment being accessed.
- Isolate the card from static electricity.
- The backup battery in the SRAM memory card has a limited life; replace the battery periodically.

For replacing the battery, see page 2-11 of this Operation Manual.

Disposing of The Product

6. This equipment uses chemical compound semiconductor including arsenide.
At the end of its life, the equipment should be recycled or disposed properly according to the local disposal regulations.
-

Equipment Certificate

Anritsu Corporation certifies that this equipment was tested before shipment using calibrated measuring instruments with direct traceability to public testing organizations recognized by national research laboratories including the Electrotechnical Laboratory, the National Research Laboratory and the Communication Research laboratory, and was found to meet the published specifications.

Anritsu Warranty

Anritsu Corporation will repair this equipment free-of-charge if a malfunction occurs within 1 year after shipment due to a manufacturing fault, provided that this warranty is rendered void under any or all of the following conditions.

- The fault is outside the scope of the warranty conditions described in the operation manual.
- The fault is due to misoperation, misuse, or unauthorized modification or repair of the equipment by the customer.
- The fault is due to severe usage clearly exceeding normal usage.
- The fault is due to improper or insufficient maintenance by the customer.
- The fault is due to natural disaster including fire, flooding and earthquake, etc.
- The fault is due to use of non-specified peripheral equipment, peripheral parts, consumables, etc.
- The fault is due to use of a non-specified power supply or in a non-specified installation location.

In addition, this warranty is valid only for the original equipment purchaser. It is not transferable if the equipment is resold.

Anritsu Corporation will not accept liability for equipment faults due to unforeseen and unusual circumstances, nor for faults due to mishandling by the customer.

Anritsu Corporation Contact

If this equipment develops a fault, contact the head office of Anritsu Corporation at the address in the operation manual, or your nearest sales or service office listed on the following pages.

Front Panel Power Switch

To prevent malfunction caused by accidental touching, the front power switch of this equipment turns on the power if it is pressed continuously for about one second in the standby state. If the switch is pressed continuously for one second in the power-on state, the equipment enters the standby state.

In the power-on state, if the power plug is removed from the outlet, then reinserted into it, the power will not be turned on. Also, if the lines is disconnected due to momentary power supply interruption or power failure, the power will not be turned on (enters the standby state) even if the line is recovered.

This is because this equipment enters the standby state and prevents incorrect data from being acquired when the line has to be disconnected and reconnected.

For example, if the sweep time is 1,000 seconds and data acquisition requires a long time, momentary power supply interruption (power failure) might occur during measurement and the line could be recovered automatically to power-on. In such a case, the equipment may mistake incorrect data for correct data without recognizing the momentary power supply interruption.

If this equipment enters the standby state due to momentary power supply interruption or power failure, check the state of the measuring system and press the front power switch to restore power to this equipment.

Further, if this equipment is built into a system and the system power has to be disconnected then reconnected, the power for this equipment must also be restored by pressing the front power switch.

Consequently, if this equipment is built into remote monitoring systems that use MODEMs, the standby function of this equipment must be modified.

ABOUT DETECTION MODE

This instrument is a spectrum analyzer which uses a digital storage system. The spectrum analyzer makes level measurements in frequency steps obtained by dividing the frequency span by the number of measurement data points (501). This method of measurement cannot detect the signal peak level if the spectrum of a received signal is narrower than these frequency steps.

To resolve this problem, this instrument usually operates in positive peak detection mode and normal detection mode. In the positive peak detection mode, the highest level within the frequency range between the sample points can be held and traced. In the normal detection mode, both the positive peak and the negative peak can be traced.

Positive peak detection mode should be used for almost all measurements including normal signal level measurement, pulsed noise analysis, and others. It is impossible to measure the signal level accurately in sample detection mode or in negative peak detection mode.

Use of sample detection mode is restricted to random noise measurement, occupied frequency bandwidth measurement for analog communication systems, and adjacent-channel leakage power measurement, etc.

Measurement	item
• Normal signal	POS PEAK
• Random noise	SAMPLE
• Pulsed noise	NORMAL (POSI-NEG)
• Occupied frequency bandwidth, adjacent-channel leakage power	SAMPLE
(for analog communication systems)	
• Occupied frequency bandwidth, adjacent-channel leakage power	POS PEAK or SAMPLE
(for digital communication systems)	

When a detection mode is specified as one of the measurement methods, make the measurement in the specified detection mode.

CE Marking

Anritsu affix the CE Conformity Marking on the following product (s) accordance with the Council Directive 93/68/EEC to indicate that they conform with the EMC directive of the European Union (EU).

CE Conformity Marking



1. Product Name/Model Name

Product Name: Spectrum Analyzer
Model Name: MS2651A and MS2661A Option 20
MS2653A and MS2663A

2. Applied Directive

EMC : Council Directive 89/336/EEC
Safety: Council Directive 73/23/EEC

3. Applied Standards

EMC:

Electromagnetic radiation:

EN55011(ISM, Group 1, Class A equipment)

Immunity:

EN50082-1

Performance Criteria*

IEC801-2 (ESD) 4 kVCD, 8 kVAD

B

IEC801-3 (Rad.) 3 V/m

A

IEC801-4 (EFT) 1 kV

B

*: Performance Criteria

A: No performance degradation or function loss

B: Self-recovered temporary degradation of performance or temporary loss of function

Safety: EN61010-1 (Installation Category II, Pollution Degree 2)

ABOUT THIS MANUAL

(1) Composition of MS2650/MS2660 Series Operation Manuals

The MS2650/MS2660 series Spectrum Analyzer operation manuals of the standard type are composed of the following three documents. Use them properly according to the usage purpose.

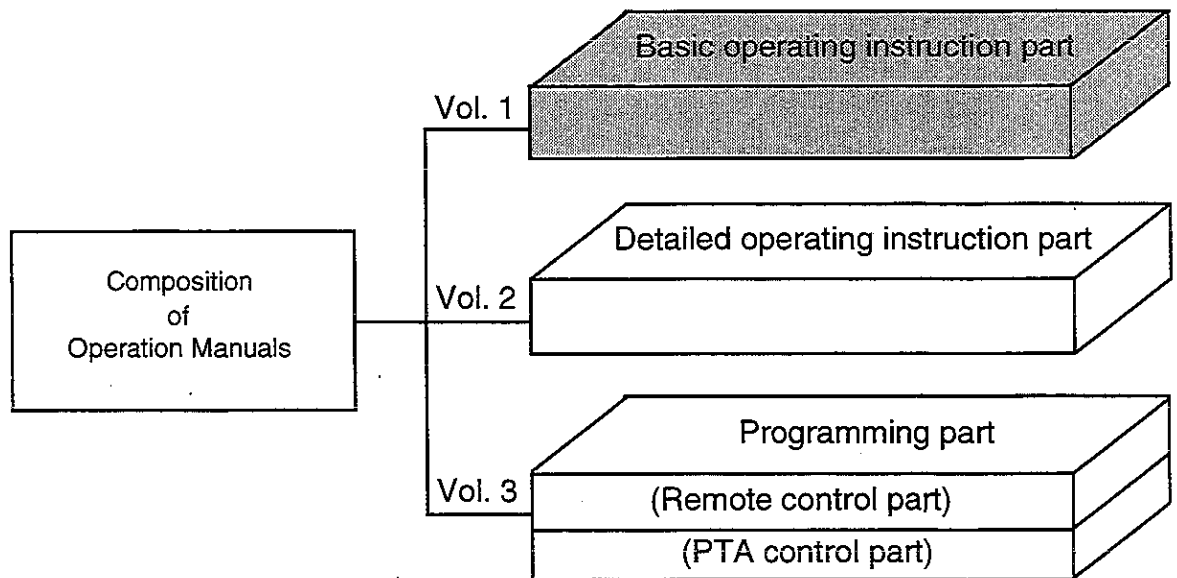

Basic operating instruction part:

Basic Operating Instructions: Provides information on the MS2650/MS2660 Series outline, preparation before use, panel description, basic operation, soft-key menu and performance tests.

Detailed operating instruction part:

Detailed Operating Instructions: Provides information on the detailed panel operating instructions on MS2650/MS2660 Series that expand on the basic operation and soft-key menu in the Basic Operating Instruction Part.

Programming part:

Composed of the Remote Control Part and PTA Control Part. The Remote Control Part provides information on RS-232C remote control, GPIB remote control and sample programs, while the PTA Control Part describes about PTA operation and PTL commands.

TABLE OF CONTENTS

For Safety	iii
ABOUT THIS MANUAL	I
SECTION 1 GENERAL	1-1
Product Outline	1-3
Composition of Operation Manual	1-4
Equipment Configuration	1-5
Standard configuration	1-5
Options	1-6
Optional Accessories and Peripherals	1-7
Specifications	1-8
SECTION 2 PREPARATIONS BEFORE USE	2-1
Installation Site and Environment Conditions	2-3
Locations to be avoided	2-3
Fan clearance	2-3
Safety Measures	2-4
Power-on	2-4
Input level to RF Input	2-5
Installation	2-6
Rack mounting	2-6
Preparations before Power-on	2-7
Protective grounding	2-8
Replacing fuse	2-9
Precaution for Handling Memory Card	2-11
SECTION 3 PANEL DESCRIPTION	3-1
Table of Front and Rear Panel Features	3-3

SECTION 4	SOFT-KEY MENU	4-1
	Soft-key Menu List	4-4
	Menu Tree	4-6
SECTION 5	BASIC OPERATION PROCEDURE	5-1
	Signal Display	5-3
	Turn the power on	5-3
	Execute automatic calibration	5-4
	Set the signal to the center of the screen	5-4
	Enlarge and display the signal	5-5
	Marker Operation	5-6
	Check of the zone marker function	
	The "marker → CF" function check	
	"Measure" Function Check	5-8
	Screen Hard Copy	5-9
SECTION 6	PERFORMANCE TESTS	6-1
	Requirement for Performance Tests	6-3
	Instruments Required for Performance Test	6-4
	Performance Test	6-6
	Reference oscillator frequency stability	6-6
	Center frequency readout accuracy	6-8
	Frequency span readout accuracy	6-11
	Resolution bandwidth (RBW) and selectivity	6-14
	Sideband noise	6-20
	Frequency measurement accuracy	6-22
	Amplitude display linearity	6-24
	Frequency response	6-28
	Reference level accuracy	6-31
	Average noise level	6-34
	Second harmonic distortion	6-37
	Resolution bandwidth (RBW) switching error	6-40
	Input attenuator switching error	6-43
	Sweep time and time span accuracy	6-46
	Tracking generation output level accuracy	6-50
	Service	6-53

SECTION 7	STORAGE AND TRANSPORTATION	7-1
	Cleaning Cabinet	7-3
	Storage Precautions	7-4
	Precautions before storage	7-4
	Recommended storage precautions	7-4
	Repacking and Transportation	7-5
	Repacking	7-5
	Transportation	7-5
APPENDIX A	FRONT AND REAR PANEL LAYOUT	A-1
APPENDIX B	BLOCK DIAGRAM	B-1

SECTION 1

GENERAL

This section outlines the MS2650/MS2660 Series Spectrum Analyzer and explains the composition of this manual, the configuration of the MS2650/MS2660 Series with the standard accessories, the options, the optional accessories, and peripherals for expanding the MS2650/MS2660 Series capabilities, and the MS2650/MS2660 Series specifications.

TABLE OF CONTENTS

Product Outline	1-3
Composition of Operation Manual	1-4
Equipment Configuration	1-5
Standard configuration	1-5
Options	1-6
Optional Accessories and Peripherals	1-7
Specifications	1-8

SECTION 1 GENERAL

Product Outline

The MS2650/MS2660 Series spectrum analyzer (henceforth called "this unit") is a portable type color LCD spectrum analyzer suited for signal analyses of radio equipment where the efficiency of frequency usage is increased and equipment are increasingly speeded and digitized.

Adopts the synthesizer local system and can cover a frequency range of 9 kHz to 3 GHz (when Option 19 DC coupling input is mounted: 500Hz to 3GHz) (MS2651A/2661A), 9 kHz to 8.1 GHz (MS2653A/2663A).

Excellent in basic performance such as C/N, distortion, frequency/level accuracy, and easily operable following the display of the soft-key menu screen.

Excellent cost performance with rich options to cope with various applications.

Equipped with high-accuracy calibration signals and an attenuator, it can accurately calibrate switching errors of LOG/LIN scales, resolution bandwidth, reference level, etc. Since frequency response is corrected by built-in calibration data, it allows high-accuracy level measurement for a wide range.

As the switching of waveforms between frequency domain and time domain can be done by a touch and two waveforms are simultaneously displayed, signal analyses of both domains can be done efficiently. Moreover, our original zone marker function and multi-marker function (up to 10 markers) are also special mention.

This unit provides the MEASURE function that can perform measurement of various applications without requiring the intervention of external controllers. Therefore, the performance evaluation of radio equipment can be easily done in terms of frequency, noise, occupied frequency bandwidth, leak power from neighboring channels, etc.

In addition, as the template measurement of burst mean power and burst waveform are also available, it is suited for evaluating the performance of digital radio equipment.

■ Application

This unit is useful for the production, building and maintenance of electronic equipment and devices in the following fields.

- AM / FM radio equipment
- Digital cellular telephone / cordless telephone
- Satellite broadcasting, CATV and TV equipment
- Small-capacity microwave equipment

Because of difference in basic performance such as sideband noise, mean noise level and strain dynamic range, the MS2660 series is suited for production and building, and the MS2650 series for maintenance.

Composition of Operation Manual

This Operation Manual is composed of 7 sections and appendixes A and B. The profile of each section is shown below.

Section composition	Explanation
SECTION 1 GENERAL	Product outline, standard configuration, options, applicable parts, peripheral devices, and specifications
SECTION 2 PREPARATIONS BEFORE USE	Operations to be done before applying power
SECTION 3 PANEL DESCRIPTION	Description about the front and rear panels
SECTION 4 SOFT-KEY MENU	Description using a soft-key menu
SECTION 5 BASIC OPERATION PROCEDURE	Basic operation procedures for operation guide
SECTION 6 PERFORMANCE TESTS	Tests used for checking performance
SECTION 7 STORAGE AND TRANSPORTATION	Cautions on storage and transportation
APPENDIX A	FRONT AND REAR PANEL LAYOUT
APPENDIX B	BLOCK DIAGRAM

Equipment Configuration

This paragraph describes the configuration of the MS2650/MS2660 series Spectrum Analyzer with standard accessories and the various options to expand the functions.

Standard configuration

The table below shows the configuration of the MS2650/MS2660 series spectrum analyzer with the standard accessories.

Standard Composition

Item	Model / Order NO.	Name	Qty.	Rmarks
Main instrument	MS2651A/MS2661A MS2653A/MS2663A	Spectrum Analyzer	1	
Accessories	J0017F	Power cord	1	Approx. 2.5 m
	J0266	Power cord adaptor	1	3-pole to 2-pole conversion
	F0013	Fuse	2	T5 A 250 V
	W1154AE	Operation manual	1	

Options

The table below shows the options for the MS2650/MS2660 series which are sold separately.

Model † - Order No. †	Name	Remarks
MS2651A/MS2661A/ MS2653A/MS2663A-01	Reference crystal oscillator	Stability: $\leq 2 \times 10^{-8}$ / day
MS2661A/MS2663A-02	Narrow resolution bandwidth	30 Hz, 100 Hz, 300 Hz
MS2651A/MS2661A/ MS2653A/MS2663A-03	Frequency counter	Resolution: 1 Hz
MS2651A/MS2661A/ MS2653A/MS2663A-04	High-speed time domain sweep	1.25 μ s / div
MS2651A/MS2661A/ MS2653A/MS2663A-05	FM demodulated waveform display function	2 kHz / div to 200 kHz / div
MS2651A/MS2661A/ MS2653A/MS2663A-06	Trigger / gate circuit	Pre-trigger and post trigger available (Option 16 required for TV trigger)
MS2651A/MS2661A/ MS2653A/MS2663A-07	AM / FM demodulator (voice monitor)	Output to loudspeaker or earphone connector
MS2651A/MS2661A-08	Pre-amplifier	100 kHz to 3 GHz, 20 dB
MS2651A/MS2661A/ MS2653A/MS2663A-09	GPIB interface	Not possible when Option 10 installed
MS2651A/MS2661A/ MS2653A/MS2663A-10	Parallel interface	Not possible when Option 09 installed
MS2651A/MS2661A/ MS2653A/MS2663A-11	Memory card interface	PCMCIA Ver. 2.0 Type I, 2 slots
MS2661A/MS2663A-12	QP Detector	QP RBW:200 Hz, 9kHz, 120kHz
MS2651A/MS2653A-13	QP Detector	QP RBW:9kHz, 120kHz
MS2651A/MS2661A/ MS2653A/MS2663A-14	PTA Parallel I/O	Controlling external equipment from PTA. Possible when Option 09 installed Not possible when Option 10 installed
MS2651A/MS2661A/ MS2653A/MS2663A-15	Sweep signal output	X, Z
MS2651A/MS2661A-16	Television monitor	NTSC / PAL (Option 08 required at same time. In addition, Option 07 required for audio.)
MS2661A-19	DC coupling input	Expanding Received frequency to 500 Hz when DC coupling input circuit. Option 02 required at same time.
MS2651A/MS2661A-20	Tracking generator	100 kHz to 3 GHz, 0 to -60 dBm

† Please specify the model / order number, name, and quantity when ordering.

Optional Accessories and Peripherals

The following table shows the optional accessories and peripherals for MS2650/MS2660 series which are all sold separately.

Optional Accessories

Model † - Order No. †	Name	Remarks
J0561	Coaxial cord, 1 m	N-P-5W · 5D-2W · N-P-5W
J0104A	Coaxial cord, 1 m	BNC-P · RG-55 / U · N-P-5W
JS256G3-C-13	256 kB memory card	Meets PCMCIA Ver. 2.0 Type I
JSS12G3-C-13	512 kB memory card	Meets PCMCIA Ver. 2.0 Type I
JS1024G3-C-13	1024 kB memory card	Meets PCMCIA Ver. 2.0 Type I
JS2048G3-C-13	2048 kB memory card	Meets PCMCIA Ver. 2.0 Type I
B0329G	Protective cover	3 / 4 MW4U
B0395A	Rack mount kit (IEC)	
B0395B	Rack mount kit (JIS)	
J0055	Coaxial adaptor (NC-P·BNC-J)	
J0076	Coaxial adaptor (NC-P·F-J)	
B0391A	Carring case (hard type)	With casters
B0391B	Carring case (hard type)	Without casters
MP612A	RF Fuse Holder	DC to 1000 MHz, 50 Ω (N)
MP613A	Fuse Element	For MP612A
MA8601A	DC Block Adaptor	50 Ω (10 kHz to 2.2 GHz)
MA2507A	DC Block Adaptor	50 Ω (9 kHz to 3.0 GHz)
MP1621A	50 Ω → 75 Ω Impedance Transformer	9 kHz to 3 GHz, with DC block capacitor (allowable voltage: 100 V)
MP614A	50 Ω ↔ 75 Ω Impedance Transformer	10 to 1200 MHz (transformer type)
J0121	Coaxial cord, 1 m	NC-P-3W · 3C-2WS · NC-P-3W
J0308	Coaxial cord, 1 m	BNC-P · 3C-2WS · NC-P-3W
J0063	Fixed attenuator for high power	30 dB (10 W, DC to 12.4 GHz)
J0395	Fixed attenuator for high power	30 dB (10 W, DC to 9 GHz)
MP640A	Branch	40 dB, DC to 1700 MHz
MP654A	Branch	30 dB, 0.8 to 3 GHz
MP520A	CM Directional Coupler	25 to 500 MHz, 75 Ω (NC)
MP520B	CM Directional Coupler	25 to 1000 MHz, 75 Ω (NC)
MP520C	CM Directional Coupler	25 to 500 MHz, 50 Ω (N)
MP520D	CM Directional Coupler	25 to 1000 MHz, 50 Ω (N)
MP526A	High Pass Filter	60-MHz band
MP526B	High Pass Filter	150-MHz band
MP526C	High Pass Filter	250-MHz band
MP526D	High Pass Filter	400-MHz band
MP526G	High Pass Filter	27-MHz band
J0007	GPIB cable, 1 m	408JE-101
J0008	GPIB cable, 2 m	408JE-102
J0743A	RS-232C cable, 1 m	For IBM PC / AT or compatible. D-sub 9 pins

† Please specify the model / order number, name, and quantity when ordering.

Specifications

Model		MS2651A	MS2661A			
Frequency	Frequency range	9 kHz to 3 GHz	9 kHz to 3 GHz. Option 19: 500 Hz to 3 GHz			
	Center frequency display accuracy	\pm (display frequency \times reference frequency accuracy + span \times span accuracy + 100 Hz) Span \geq 10 kHz, after calibration				
	Marker frequency display accuracy	Normal: Same as center frequency display accuracy. Delta: Same as frequency span accuracy				
	Frequency span	Setting range: 0 Hz, 1 kHz to 3.1 GHz Accuracy: \pm 2.5% (span: \geq 10 kHz), \pm 5% (span: < 10 kHz with option 02)				
	Resolution bandwidth (3 dB BW)	Setting range: 1 kHz, 3 kHz, 10 kHz, 30 kHz, 100 kHz, 300 kHz, 1 MHz, 5 MHz (manually or automatically settable according to frequency span) * Option 02 (MS2661A only): 30 Hz, 100 Hz and 300 Hz are added. Measurements of such as noise, C/N, adjacent channel leakage power by measure function are executed with the calculated equivalent noise bandwidth of the resolution bandwidth.				
	Selectivity (60 dB: 3 dB)	\leq 10: 1 (RBW: 1 to 300 kHz) \leq 15: 1 (RBW: 1 MHz, 5 MHz)				
	Video bandwidth	1 Hz to 3 MHz (1-3 sequence), automatically settable for through, manual or span)				
	Signal purity and stability	Noise sidebands: \leq - 90 dBc/Hz (1 GHz, 10 kHz offset)	Noise sidebands: \leq - 100 dBc/Hz (1 GHz, 10 kHz offset)			
		Residual FM: \leq 20 Hzp-p/0.1 s (1 GHz, span: 0 Hz) Frequency drift: \leq 200 Hz/min (span: \leq 10 kHz, sweep time: \leq 100 s) *After 1-hour warm-up at constant ambient temperature				
	Reference oscillator	Frequency: 10 MHz Aging rate: 2×10^{-6} /year (typical); Option 01: 1×10^{-7} /year, 2×10^{-6} /day Temperature characteristics: 1×10^{-5} (typical, 0° to 50°C); Option 01: $\pm 5 \times 10^{-6}$ (0° to 50°C)				
Amplitude	Level measurement	Measurement range	Average noise level to +30 dBm			
		Maximum input level	+30 dBm (CW average power, input attenuator \geq 10 dB), \pm 50 Vdc			
		Average noise level	MS2651A	\leq - 110 dBm (1 MHz to 1 GHz), \leq - 110 dBm + f [GHz] dB (> 1 GHz) * Resolution bandwidth 1 kHz, video bandwidth 1 Hz, input attenuator 0 dB	MS2661A	\leq - 115 dBm (1 MHz to 1 GHz), \leq - 115 dBm + f [GHz] dB (> 1 GHz) * Resolution bandwidth 1 kHz, video bandwidth 1 Hz, input attenuator 0 dB When Option-08 Pre-amplifier installed: \leq - 114 dBm (1 MHz to 1 GHz) \leq - 114 dBm + 1.5f [GHz] dB (> 1 GHz)
			Residual response	\leq - 100 dBm (input attenuator: 0 dB)		
	Total level accuracy	\pm 1.1 dB Total level accuracy: reference level accuracy (0 to - 50 dBm) + frequency response + log linearity (0 to - 20 dB) + calibration signal accuracy				
	Reference level	Setting range Log scale: - 100 to +30 dBm, or equivalent level Linear scale: 224 μ V to 7.07 V Unit Log scale: dBm, dB μ V, dBmV, V, dB μ Vemf, W, dB μ V/m Linear scale: V Reference level accuracy: \pm 0.3 dB (- 49.9 to 0 dBm), \pm 0.75 dB (- 69.9 to - 50 dBm, 0.1 to +30 dBm), \pm 1.5 dB (- 80 to - 70 dBm) .. *After calibration at 100 MHz frequency, span 2 MHz (when input attenuator, resolution bandwidth, video bandwidth, and sweep time set to AUTO) Resolution bandwidth switching deviation: \pm 0.3 dB Input attenuator Setting range: 0 to 70 dB (10 dB steps) *Manual settable, or automatically settable according to reference level Switching deviation: \pm 0.3 dB (0 to 50 dB), \pm 1 dB (0 to 70 dB) *After calibration, frequency 100 MHz, input attenuator 10 dB				

(Continued)

Model		MS2651A	MS2661A
Amplitude	Frequency response	± 0.5 dB (100 kHz to 3 GHz, referenced to 100 MHz, input attenuator 10 dB, temperature 18° to 28°C) ± 1.0 dB (100 kHz to 3 GHz, referenced to 100 MHz, input attenuator 0 to 50 dB) ± 1.5 dB (9 kHz to 100 kHz, referenced to 100 MHz, input attenuator 10 dB, temperature 18° to 28°C)	
	Screen display	Scale: 10 div (at single scale) Log scale: 10, 5, 2, 1 dB/div Linear scale: 10, 5, 2, 1% Linearity (after calibration): Log scale: ± 0.3 dB (0 to -20 dB, RBW \leq 1 MHz), ± 1 dB (0 to -70 dB, RBW \leq 100 kHz), ± 1.5 dB (0 to -80 dB, RBW \leq 10 kHz), ± 2.5 dB (0 to -90 dB, RBW \leq 10 kHz). Linear scale: $\pm 3\%$ (compared to reference level) Marker level resolution: Log scale: 0.01 dB Linear scale: 0.01% of reference level	
	Spurious response	2nd harmonic distortion: - 55 dBc (10 to 100 MHz, mixer level - 30 dBm) - 60 dBc (100 to 1500 MHz, mixer level - 30 dBm) Two signal 3rd intermodulation distortion: - 70 dBc (10 MHz to 3 GHz, frequency difference of two signals >50 kHz, mixer input level - 30 dBm)	2nd harmonic distortion: - 60 dBc (10 to 200 MHz, mixer level - 30 dBm) - 75 dBc (200 to 1500 MHz, mixer level - 30 dBm) - 80 dBc (800 to 1000 MHz, mixer level - 30 dBm) Two signal 3rd intermodulation distortion: - 70 dBc (10 to 100 MHz), - 80 dBc (100 to 3 GHz) *Frequency difference of two signals >50 kHz, mixer input level - 30 dBm
	1 dB gain compression	$\cong - 5$ dBm (\cong 100 MHz, at mixer input level)	
	Maximum dynamic range	1-dB gain compression level vs. average noise level: >105 dB, >105 dB - f [GHz] dB Distortion characteristics (1 kHz RBW): 2nd harmonic: >67.5 dB (10 to 100 MHz), >70 dB (100 to 500 MHz), >70 - f [GHz] dB (500 to 1000 MHz) 3rd intermodulation: >76.7 dB (10 to 1000 MHz), >76.7 - 2/3f [dB] (1 to 3 GHz)	1-dB gain compression level vs. average noise level: >110 dB (100 MHz to 1 GHz), >110 dB - f [GHz] dB (>1 GHz) When Option-08 Pre-amplifier installed: $\cong - 109$ dB (1 MHz to 1 GHz) $\cong - 109$ dB + 1.5f (GHz) dB (>1 GHz) Distortion characteristics (1 kHz RBW): 2nd harmonic: >72.5 dB (10 to 200 MHz), >80 dB (200 to 500 MHz), >80 - f [GHz] dB (500 to 1500 MHz) 3rd intermodulation: >80 dB (10 to 100 MHz), >83.3 dB (100 to 1000 MHz), >83.3 - 2/3f [GHz] dB (1 to 3 GHz)
	Sweep	Sweep time	Setting range: 20 ms to 1000 s (automatically for manual set, span, resolution bandwidth, and video bandwidth) Accuracy: $\pm 15\%$ (20 ms to 100 s), $\pm 45\%$ (110 to 1100 s), $\pm 1\%$ (time domain sweep)
	Sweep mode	Continuous, single	
	Zone sweep	Sweeps only in frequency range indicated by zone marker	
	Tracking sweep	Sweeps while tracing peak points within zone marker (zone sweep also possible)	
Functions	Number of data points	501	
	Detection mode	NORMAL: Simultaneously displays max. and min. points between sample points POS PEAK: Displays max. point between sample points NEG PEAK: Displays min. point between sample points SAMPLE: Displays momentary value at sample points Detection mode switching error: ± 0.5 dB (at reference level)	
	Display	Color TFT-LCD Size: 5.7" Number of colors: 17 (RGB, each 64-scale settable)	

(Continued)

Model		MS2651A	MS2661A
Functions	Display functions	Trace A: Displays frequency spectrum Trace B: Displays frequency spectrum Trace Time: Displays time domain waveform at center frequency Trace A/B: Displays Trace A and Trace B simultaneously, simultaneous sweep of same frequency, alternate sweep of independent frequencies Trace A/BG: Displays frequency region to be observed (background) and object band (foreground) selected from background with zone marker simultaneously Trace A/Time: Displays frequency spectrum, and time domain waveform at center frequency simultaneously Trace-move/calculation: A → B, B → A, A ↔ B, A+B → A, A-B → A, A-B+DL → A	
	Storage functions	NORMAL, VIEW, MAX HOLD, MIN HOLD, AVERAGE, CUMULATIVE, OVER WRITE	
	Input connector	N-J, 50 Ω	
	Auxiliary signal input and output	IF OUTPUT: 455 kHz (RBW ≤ 30 kHz), 10.695 MHz (RBW ≥ 100 kHz), - 10 dBm ± 2 dB (100 MHz, at upper edge of display, 50 Ω), BNC connector VIDEO OUTPUT (Y): 0 to 0.5 V ± 0.1 V (100 MHz input, 75 Ω termination, LOG: 10 dB/div, from lower edge to upper edge, BNC connector) COMPOSITE OUTPUT: For NTSC, 1 Vp-p (75 Ω terminated), BNC connector EXT REF INPUT: 10 MHz ± 10 Hz, 2 to 5 Vp-p, ≥ 200 Ω, BNC connector	
	Signal search	AUTO TUNE, PEAK → CF, PEAK → REF, SCROLL	
	Zone marker	NORMAL, DELTA	
	Marker	MARKER → CF, MARKER → REF, MARKER → CF STEP SIZE, Δ MARKER → SPAN, ZONE → SPAN	
	Peak search	PEAK, NEXT PEAK, NEXT RIGHT PEAK, NEXT LEFT PEAK, MIN DIP, NEXT DIP	
	Multi-marker	Number of markers: 10 max. (HIGHEST 10, HARMONICS, MANUAL SET)	
	Measure	Noise power (dBm/Hz, dBm/ch), C/N (dBc/Hz, dBc/ch) channel power (dBm/Hz, dBm), occupied bandwidth (power N% method, X-dB down method), adjacent channel leakage power (REF: total power method, reference level method, inband channel power method, channel designate display: 2 channels × 2, graphic display), average power of burst signal (average power in designated time range of time domain waveform), template comparison (upper/lower limits × each 2, time domain), MASK (upper/lower × each 2, frequency domain)	
	Save/recall	Save and recall setting conditions and waveform data to internal memory (max. 12) or memory card (Option 11)	
	Hard copy	Printer (HP dotmatrix, EPSON dotmatrix or compatible models): Display data can be hard-copied via the RS-232C, GPIB (Option 09), or parallel (Option 10) interface Plotter (HP-GL, GP-GL or compatible models): Display data can be output via the RS-232C, and GPIB (Option 09) interface	
	Others	PTA	Language: PTL (interpreter based on BASIC) Programming: Using editor of external computer Program memory: Memory card (Option 11), upload/download to/from external computer Programming capacity: 192 Kbyte Data processing: Directly accesses measurement data according to system variables, system subroutines, and system functions
RS-232C		Outputs data to printer and plotter. Control from external computer (excluding power switch)	
Power		85 to 132 Vac/170 to 250 Vac (automatic voltage switching), 47.5 to 63 Hz, ≤ 200 VA (100 Vac), ≤ 220 VA (200 Vac)	
	Dimensions and mass	177 (H) × 320 (W) × 351 (D) mm, <10.4 kg (without option, <9.8 kg when handle is removed)	
	Ambient temperature	0° to 50°C (operate), - 30° to +75°C (storage)	

Model		MS2653A	MS2663A		
Frequency	Frequency range	9 kHz to 8.1 GHz			
	Frequency band	Band 0 (0 to 3.2 GHz), band 1- (3.2 to 6.5 GHz), band 1+ (6.4 to 8.1 GHz)			
	Pre-selector range	3.1 to 8.1 GHz (band 1-, 1+)			
	Center frequency display accuracy	\pm (display frequency \times reference frequency accuracy + span \times span accuracy + 100 Hz) *Span: ≥ 10 kHz, after calibration			
	Marker frequency display accuracy	Normal: Same as center frequency display accuracy, Delta: Same as frequency span accuracy			
	Frequency span	Setting range: 0 Hz, 1 kHz to 8.2 GHz Accuracy: $\pm 2.5\%$ (span: ≥ 10 kHz)	Setting range: 0 Hz, 1 kHz to 8.2 GHz Accuracy: $\pm 2.5\%$ (span: ≥ 10 kHz), $\pm 5\%$ (span: < 10 kHz, Option 02 installed)		
	Resolution bandwidth (3 dB BW)	Setting range: 1 kHz, 3 kHz, 10 kHz, 30 kHz, 100 kHz, 300 kHz, 1 MHz, 5 MHz (manually or automatically settable according to frequency span) *Option 02 (MS2663A only): 30 Hz, 100 Hz, and 300 Hz are added. Measurements of such as noise, C/N, adjacent channel leakage power by measure function are executed with the calculated equivalent noise bandwidth of the resolution bandwidth. Selectivity (60 dB : 3 dB) : $\leq 10:1$ (RBW: 1 kHz to 300 kHz), $\leq 15:1$ (RBW: 1 MHz, 5 MHz)			
	Video bandwidth	1 Hz to 3 MHz (1-3 sequence), through *Manually or automatically settable according to resolution bandwidth			
	Signal purity and stability	Noise sidebands : ≤ -90 dBc/Hz (1 GHz, 10 kHz offset)		Noise sidebands : ≤ -100 dBc/Hz (1 GHz, 10 kHz offset)	
		Residual FM: ≤ 20 Hz-p/0.1 s (1 GHz, span: 0 Hz) Frequency drift: ≤ 200 Hz/min (span: ≤ 1 MHz, sweep time: ≤ 100 s) *After 1-hour warm-up at constant ambient temperature			
Reference oscillator	Frequency: 10 MHz Aging rate: 2×10^{-6} /year (typical); Option 01: 1×10^{-7} /year, 2×10^{-8} /day Temperature characteristics: 1×10^{-5} (typical, 0° to 50°C); Option 01: $\pm 5 \times 10^{-6}$ (0° to 50°C)				
Amplitude	Level measurement	Measurement range	Average noise level to +30 dBm		
		Maximum input level	+30 dBm (CW average power, input attenuator: ≥ 10 dB), ± 0 Vdc		
		Average noise level	≤ -110 dBm (1 MHz to 1 GHz, band 0), ≤ -110 dBm + f [GHz] dB (1 to 3.1 GHz, band 0) ≤ -110 dBm + 0.5f [GHz] dB (3.1 to 8.1 GHz, band 1) *Resolution bandwidth: 1 kHz, video bandwidth: 1 Hz, input attenuator: 0 dB	≤ -115 dBm (1 MHz to 1 GHz, band 0), ≤ -115 dBm + 1.5f [GHz] dB (1 to 3.1 GHz, band 0) ≤ -115 dBm + 0.5f [GHz] dB (3.1 to 8.1 GHz, band 1) *Resolution bandwidth: 1 kHz, video bandwidth: 1 Hz, input attenuator: 0 dB	
		Residual response	≤ -95 dBm (input attenuator: 0 dB, input: 50 Ω termination, 1 MHz to 8.1 GHz)	≤ -100 dBm (input attenuator: 0 dB, input: 50 Ω termination, 1 MHz to 8.1 GHz)	
	Total level accuracy	± 1.3 dB (100 kHz to 3.1 GHz), ± 1.8 dB (3.1 to 8.1 GHz) *Level measurement accuracy after calibration using internal calibration signal Total level accuracy: reference level accuracy (0 to -50 dBm) + frequency response + log linearity (0 to -20 dB)			
	Reference level	Setting range Log scale: -100 to +30 dBm, or equivalent level Linear scale: 224 μ V to 7.07 V Unit Log scale: dBm, dB μ V, dBmV, V, dB μ V (e.m.f), W, dB μ V/m Linear scale: V Reference level accuracy: ± 0.4 dB (-49.9 to 0 dBm), ± 0.75 dB (-69.9 to -50 dBm, 0.1 to +30 dBm), ± 1.5 dB (-80 to -70 dBm) * After calibration at 100 MHz frequency, span 1 MHz (when input attenuator, resolution bandwidth, video bandwidth, and sweep time set to AUTO) Resolution bandwidth switching uncertainty: ± 0.3 dB (1 kHz to 1 MHz), ± 0.4 dB (1 kHz to 5 MHz) *After calibration, referenced to resolution bandwidth 3 kHz Input attenuator Setting range: 0 to 70 dB (10 dB steps) *Manual settable, or automatically settable according to reference level Accuracy: ± 0.3 dB (0 to 50 dB), ± 1.0 dB (0 to 70 dB) *After calibration, referenced to frequency 100 MHz, input attenuator 10 dB			
Frequency response	± 0.5 dB (100 kHz to 3.2 GHz, band 0, referenced to 100 MHz, input attenuator 10 dB, temperature 18° to 28°C) ± 1.5 dB (9 to 100 kHz, band 0, referenced to 100 MHz, input attenuator 10 dB, temperature 18° to 28°C) ± 1.5 dB (3.1 to 8.1 GHz, band 1-/1+, referenced to 100 MHz, input attenuator 10 dB, temperature 18° to 28°C) ± 1.0 dB (100 kHz to 3.2 GHz, band 0, input attenuator 10 to 50 dB) ± 3.0 dB (3.1 to 8.1 GHz, band 1-/+, input attenuator 10 to 50 dB) *At band 1-/1+, after pre-selector tuning				

Model		MS2653A	MS2663A
Amplitude	CRT display	Scale: 10 div (at single scale) Log scale: 10, 5, 2, 1 dB/div Linear scale: 10, 5, 2, 1%/div Linearity (after calibration) Log scale: ± 0.4 dB (0 to -20 dB, RBW: ≤ 1 MHz), ± 1 dB (0 to -70 dB, RBW: ≤ 100 kHz), ± 1.5 dB (0 to -85 dB, RBW: ≤ 10 kHz), ± 2.5 dB (0 to -90 dB, RBW: ≤ 10 kHz) Linear scale: $\pm 4\%$ (compared to reference level) Marker level resolution Log scale: 0.01 dB Linear scale: 0.02% of reference level	
	Spurious response	2nd harmonic distortion: ≤ -55 dBc (10 to 100 MHz, band 0, mixer input level: -30 dBm) ≤ -60 dBc (0.1 to 1.55 GHz, band 0, mixer input level: -30 dBm) ≤ -100 dBc (1.55 to 4.05 GHz, band 1-1+, mixer input level: -20 dBm) Two signal 3rd order intermodulation distortion: ≤ -70 dBc (10 MHz to 8.1 GHz, frequency difference of two signals: ≥ 50 kHz, mixer input level: -30 dBm)	2nd harmonic distortion: ≤ -60 dBc (10 to 200 MHz, band 0, mixer input level: -30 dBm) ≤ -75 dBc (0.2 to 1.3 GHz, band 0, mixer input level: -30 dBm) ≤ -70 dBc (1.3 to 1.55 GHz, band 0, mixer input level: -30 dBm) ≤ -80 dBc (0.8 to 1 GHz, band 0, mixer input level: -30 dBm) ≤ -100 dBc (1.55 to 4.05 GHz, band 1-1+, mixer input level: -20 dBm) Two signal 3rd order intermodulation distortion: ≤ -70 dBc (10 to 100 MHz), ≤ -80 dBc (0.1 to 8.1 GHz) * Frequency difference of two signals: ≥ 50 kHz, mixer input level: -30 dBm
	1 dB gain compression	≥ -5 dBm (≥ 100 MHz, at mixer input level)	
	Maximum dynamic range	1 dB gain compression level to average noise level: > 105 dB (100 MHz to 1 GHz, band 0), > 105 dB -f[GHz] dB (1 to 3.1 GHz, band 0) > 105 dB -0.5f[GHz] dB (3.1 to 8.1 GHz, band 1-1+) Distortion characteristics (1 kHz RBW) 2nd harmonic: > 67.5 dB (10 to 100 MHz) > 70 dB (100 to 500 MHz) $> 70 - 0.5f[GHz]$ dB (0.5 to 1.55 GHz) $> 95 - 0.25f[GHz]$ dB (1.55 to 4.05 GHz) 3rd order intermodulation: > 73.3 dB (10 to 1000 MHz) $> 73.3 - 2/3f[GHz]$ dB (1 to 3.1 GHz) $> 73.3 - 1/3f[GHz]$ dB (3.1 to 8.1 GHz)	1 dB gain compression level to average noise level: > 110 dB (100 MHz to 1 GHz, band 0), > 110 dB -1.5f[GHz] dB (1 to 3.1 GHz, band 0) > 110 dB -0.5f[GHz] dB (3.1 to 8.1 GHz, band 1-1+) Distortion characteristics (1 kHz RBW) 2nd harmonic: > 72.5 dB (10 to 200 MHz) > 80 dB (200 to 500 MHz) $> 80 - 0.75f[GHz]$ dB (0.5 to 1.3 GHz) $> 82.5 - 0.75f[GHz]$ dB (0.8 to 1 GHz) $> 77.5 - 0.75f[GHz]$ dB (1.3 to 1.55 GHz) $> 97.5 - 0.25f[GHz]$ dB (1.55 to 4.05 GHz) 3rd order intermodulation: > 75 dB (10 to 100 MHz) > 81.6 dB (100 to 1000 MHz) $> 81.6 - f[GHz]$ dB (1 to 3.1 GHz) $> 81.6 - 1/3f[GHz]$ dB (3.1 to 8.1 GHz)
Sweep	Sweep time	Setting range : 20 ms to 1000 s (manual settable, or automatically settable according to span, resolution bandwidth, and video bandwidth) Accuracy: $\pm 15\%$ (20 ms to 100 s), $\pm 45\%$ (110 to 1000 s), $\pm 1\%$ (time domain sweep)	
	Sweep mode	Continuous, single	
	Zone sweep	Sweeps only in frequency range indicated by zone marker	
	Tracking sweep	Sweeps while tracing peak points within zone marker (zone sweep also possible)	
Functions	Number of data points	501	
	Detection mode	NORMAL: Simultaneously displays max. and min. points between sample points POS PEAK: Displays max. point between sample points NEG PEAK: Displays min. point between sample points SAMPLE: Displays momentary value at sample points Detection mode switching uncertainty: ± 0.5 dB (at reference level)	
	Display	Color TFT-LCD, Size: 5.7", Number of colors: 17 (RGB, each 64-scale settable)	
	Display functions	Trace A: Displays frequency spectrum Trace B: Displays frequency spectrum Trace Time: Displays time domain waveform at center frequency Trace A/B: Displays Trace A and Trace B simultaneously, simultaneous sweep of same frequency, alternate sweep of independent frequencies Trace A/BG: Displays frequency region to be observed (background) and object band (foreground) selected from background with zone marker simultaneously, alternate sweep Trace A/Time: Displays frequency spectrum, and time domain waveform at center frequency simultaneously Trace move/calculation: A \rightarrow B, B \rightarrow A, A \leftrightarrow B, A+B \rightarrow A, A-B \rightarrow A, A-B-DL \rightarrow A	

(Continued)

Model	MS2653A	MS2663A
Storage functions	NORMAL, VIEW, MAX HOLD, MIN HOLD, AVERAGE, CUMULATIVE, OVER WRITE	
Input connector	N-J, 50 Ω	
Auxiliary signal input and output	IF OUTPUT: BNC connector VIDEO OUTPUT (Y): 0 to 0.5 V \pm 0.1 V (100 MHz, from lower edge to upper edge at 10 dB/div or 10%/div, 75 Ω terminated), BNC connector COMPOSITE OUTPUT: For NTSC, 1 Vp-p (75 Ω terminated), BNC connector EXT REF INPUT: 10 MHz \pm 10 Hz, \geq 0 dBm (50 Ω terminated), BNC connector	
Signal search	AUTO TUNE, PEAK \rightarrow CF, PEAK \rightarrow REF, SCROLL	
Zone marker	NORMAL, DELTA	
Marker	MARKER \rightarrow CF, MARKER \rightarrow REF, MARKER \rightarrow CF STEP SIZE, Δ MARKER \rightarrow SPAN, ZONE \rightarrow SPAN	
Peak search	PEAK, NEXT PEAK, NEXT RIGHT PEAK, NEXT LEFT PEAK, MIN DIP, NEXT DIP	
Multi-marker	Number of markers: 10 max. (HIGHEST 10, HARMONICS, MANUAL SET)	
Measure	Noise power (dBm/Hz, dBm/ch), C/N (dBc/Hz, dBc/ch), Channel power (dBm/Hz, dBm), occupied bandwidth (power N% method, X-dB down method), adjacent channel leakage power (REF: total power method, reference level method, inband channel power method, channel designate display: 2 channels \times 2, graphic display), average power of burst signal (average power in designated time range of time domain waveform), template comparison (upper/lower limits \times each 2, time domain), MASK (upper/lower \times each 2, frequency domain)	
Save/recall	Save and recall setting conditions and waveform data to internal memory (max. 12) or memory card (Option 11)	
Hard copy	Printer (HP dotmatrix, EPSON dotmatrix or compatible models): Display data can be hard-copied via the RS-232C, GPIB (Option 09), and Centronics (Option 10) interface Plotter (HP-GL, GP-GL or compatible models): Display data can be output via the RS-232C, and GPIB (Option 09) interface	
PTA	Language: PTL (interpreter based on BASIC) Programming: Using editor of external computer Program memory: Memory card (Option 11), upload/download to/from external computer Programming capacity: 192 Kbyte Data processing: Directly accesses measurement data according to system variables, system subroutines, and system functions	
RS-232C	Outputs data to printer and plotter. Control from external computer (excluding power switch)	
Correction	Autocorrection of MA1621A Impedance Converter insertion loss Correction accuracy (input attenuator: \geq 10 dB): \pm 2.5 dB (9 to 100 kHz), \pm 1.5 dB (100 kHz to 2 GHz), \pm 2.0 dB*1 (2 to 3 GHz)	
Power	85 to 132 Vac/170 to 250 Vac (automatic voltage switching), 47.5 to 63 Hz, \leq 280 VA	
Dimensions and mass	177 (H) \times 320 (W) \times 351 (D) mm, \leq 13.5 kg (12 kg*1: standard configuration)	
Ambient temperature	0 $^{\circ}$ to 50 $^{\circ}$ C (operate), -30 $^{\circ}$ to +75 $^{\circ}$ C (storage)	

*1: Typical value for reference; not guaranteed specifications

● **Option 03: Frequency counter**

Resolution	1 Hz, 10 Hz, 100 Hz, 1 kHz
Accuracy	Display frequency X reference frequency accuracy ± 1 count (when S/N is ≥ 20 dB)

● **Option 04: High-speed time domain sweep**

Sweep time	12.5 μ s, 25 μ s, 50 μ s, 100 to 900 μ s (one most significant digit settable) 1.0 to 19 ms (two upper significant digits settable)
Accuracy	$\pm 1\%$
Marker level resolution	0.1 dB (log scale), 0.2% (linear scale, relative to reference level)

● **Option 05: FM demodulation waveform display function**

Demodulation range	2, 5, 10, 20, 50, 100, 200 kHz/div
Marker display	Accuracy: $\pm 5\%$ of full scale (referenced to center frequency after calibration, DC-coupled, RBW 5 MHz, VBW 1 Hz, CW) Demodulation frequency response: DC (50 Hz at AC-coupled) to 100 kHz (range: ≤ 20 kHz/div, VBW: off, at 3 dB bandwidth), DC (50 Hz at AC-coupled) to 500 kHz (range: ≤ 50 kHz/div, VBW: off, at 3 dB bandwidth)

● **Option 06: Trigger/gate circuit**

Trigger switch	FREE RUN, TRIGGERED	
Trigger source	EXT	Trigger level: ± 10 V (resolution: 0.1 V) Trigger slope: RISE/FALL
	VIDEO	Trigger level: -100 to 0 dB (log scale, resolution: 1 dB) Trigger slope: RISE/FALL
	WIDE IF VIDEO	Trigger level: High, Middle, or Low selectable Bandwidth: ≥ 20 MHz Trigger slope: RISE/FALL
	LINE	Frequency: 47 to 63 Hz (line lock)
Trigger delay	TV	System: NTSC, PAL Sync.: V-SYNC, H-SYNC (ODD/EVEN) *Option 16 required
	Pre-trigger	Displays waveform from previous max. 1 screen at trigger occurrence point Range: - time span to 0 s Resolution: time span/500
	Post trigger	Displays waveform from after max. 65.5 ms at trigger occurrence point Range: 0 to 65.5 ms Resolution: 1 μ s
Gate sweep	In frequency domain, displays spectrum of input signal in specified gate interval Gate delay: 0 to 65.5 ms (from trigger point, resolution: 1 μ s) Gate width: 2 μ s to 65.5 ms (from gate delay point, or external control, resolution: 1 μ s)	

● **Option 07: AM/FM demodulator (voice monitor)**

Voice output	With internal loudspeaker and earphone connector (ϕ 2.5 mini jack), adjustable volume
--------------	---

• Option 08: Pre-amplifier

Model	MS2651A	MS2661A
Frequency range	100 kHz to 3 GHz	
Gain	20 dB \pm 2 dB(after calibration)	
Noise figure	\leq 7 dB(<2 GHz), \leq 12 dB(\geq 2 GHz) (typical value)	
Amplitude Level measurement Measurement range Maximum input level Average noise level	<p>Average noise level to 10 dBm</p> <p>+20 dBm(CW average power, input attenuator \geq 10 dB), \pm50 Vdc</p> <p>\leq - 130 dBm(1 MHz to 1 GHz) \leq - 130 dBm +1.5f[GHz] dB(>1 GHz) *Resolution bandwidth 1 kHz, video bandwidth 1 kHz, input attenuator 0 dB</p> <p>\leq - 134 dBm(1 MHz to 1 GHz) \leq - 134 dBm +2f[GHz] dB(>1 GHz) *Resolution bandwidth 1 kHz, video bandwidth 1 kHz, input attenuator 0 dB</p>	
Reference level	<p>Setting range</p> <p>Log scale: - 120 to +10 dBm, or equivalent level Linear scale: 22.4 μ V to 707 mV</p> <p>Reference level accuracy: \pm0.5 dB(- 69.9 to - 20 dBm), \pm0.75 dB(- 89.9 to - 70 dBm, - 19.9 to +10 dBm)</p> <p>*After calibration, at frequency 100 MHz, span 2 MHz(when input attenuator, resolution bandwidth, video bandwidth, and sweep time set to AUTO.)</p> <p>Resolution bandwidth switching deviation: \pm0.5 dB Input attenuator switching deviation: \pm0.5 dB(0 to 50 dB), \pm1 dB(0 to 70 dB) *After calibration, frequency 100 MHz, referenced to attenuation 10 dB</p>	
Frequency response	\pm 2.0 dB(100 kHz to 3 GHz, referenced to 100 MHz, input attenuator 0 to 50 dB)	
Screen display	<p>Linearity(after calibration)</p> <p>Log scale: \pm0.5 dB(0 to - 20 dB, RBW \leq 1 MHz) \pm1 dB (0 to - 60 dB, RBW \leq 100 kHz) \pm1.5 dB(0 to - 75 dB, RBW \leq 10 kHz)</p> <p>Linear scale: \pm5%(compared to reference level)</p>	
Spurious response	<p>Two-signal 3rd-intermodulation distortion: - 70 dBc(10 MHz to 3 GHz)</p> <p>*Frequency difference of two signals >50 kHz, pre-amplifier input level - 55 dBm</p>	
1-dB gain compression	\leq - 35 dBm(\geq 100 MHz, pre-amplifier input level)	

● Option 09: GPIB interface

Functions	Meets IEEE488.2. Can be controlled as device from external computer (excluding power switch). Or can control external equipment as controller
Interface	SH1, AH1, T6, L4, SR1, RL1, PP0, DC1, DT1, C1, C2, C3, C4, C28

● Option 10: Parallel interface

Function	Output data to printer (Centronics standard)
Connector	D-sub 25-pin (jack)

● Option 11: Memory card interface

Functions	Save/recall measurement settings and data. Uploads/downloads PTA programs. Accesses SRAM, EPROM, and flash EEROM (writes to SRAM only). Supports cards up to 2 MB.
Connector	PCMCIA Ver. 2.0, 2 slots

● Option 15: Sweep signal output

Sweep output (X)	0 to 10 V \pm 1 V (\geq 100 k Ω termination, from left side to right side of display scale), BNC connector
Sweep status output (Z)	TTL level (low level with sweeping), BNC connector

● Option 16: Television monitor* (under development)

Video	NTSC/PAL
Audio	Simultaneous monitor of video and audio needs Option 07

* Option 08 required

● Option 20: Tracking generator

Frequency range	100 kHz to 3 GHz
Output level	
Setting range	0 to -60 dBm
Setting resolution	0.1 dB
Accuracy	$\leq \pm 1.0$ dB(at frequency 100 MHz, output level 0 dBm)
Flatness	$\leq \pm 1.5$ dB(100 kHz to 3 GHz, output level 0 dBm, referenced to 100 MHz)
Linearity	$\leq \pm 1.0$ dB(output level 0 to -30 dBm) $\leq \pm 2.0$ dB(output level -30 to -60 dBm) (100 kHz to 3 GHz, referenced to 0 dBm)
Spurious	
Harmonics	≤ -20 dBc(output level 0 dBm)
Non-harmonics	≤ -35 dBc(output level 0 dBm)
Tracking generator feed-through	≤ -95 dBm(50 Ω termination at RF input connector of spectrum analyzer and output connector of tracking generator)
Output connector	N-J, 50 Ω

● Whether or not to mount options on the series devices

Option No.	MS2651A	MS2661A	MS2653A	MS2663A
01: Reference crystal oscillator	○	○	○	○
02: Narrow resolution bandwidth	×	○	×	○
03: Frequency counter	○	○	○	○
04: High-speed time domain sweep	○	○	○	○
05: FM demodulated waveform display function	○	○	○	○
06: Trigger / gate circuit	○	○	○	○
07: AM / FM demodulator (voice monitor)	○	○	○	○
08: Pre-amplifier	○	○	×	×
09: GPIB interface	○	○	○	○
10: Parallel interface	○	○	○	○
11: Memory card interface	○	○	○	○
12: QP detector (QP RBW: 200 Hz is mounted)	×	○	×	○
13: QP detector (QP RBW: 200 Hz is not mounted)	○	×	○	×
14: PTA parallel I/O	○	○	○	○
15: Sweep signal output	○	○	○	○
16: Television monitor	○	○	×	×
19: DC coupling input	×	○	×	×
20: Tracking generator	○	○	×	×

○: Can be mounted

×: Cannot be mounted

● **Option 14: PTA parallel I/O***

Functions	Controlling external equipment from PTA
Interface	Output 8 bit TTL level x2 Input/Output 4 bit TTL level x2
Connector	Amphenore 36-pin

* Possible when Option 09 installed

● **Option 12: PQ detector***

Function	QP detection When this option is mounted, RBW=100 Hz 3 dB bandwidth of Option 02 is modified to 150 Hz (representative value).		
6 dB bandwidth	bandwidth: 200 Hz, 9 kHz, 120 kHz accuracy: $\pm 30\%$ (at 18 to 28°C)		
Indicator Section	LOG scale, 5 dB/DIV, 10 scale marks Linearity $\leq \pm 2.0$ dB/0 to -40 dB (CW signal, Reference level=60 dB μ V, Input Attenuator =0 dB, at 18 to 28°C)		
Pulse Responsiveness	Response Corresponding to CISPR pulse (at DET mode: QP, 18°C to 28°C)		
	120 kHz Bandwidth	Repetition Frequency	Response
		1 kHz	-8.0 \pm 1.0 dB or less
		100 Hz	Standard
		20 Hz	+9.0 \pm 1.0 dB or less
		10 Hz	+14.0 \pm 1.5 dB or less
		2 Hz	+26.0 \pm 2.0 dB or less
	9 kHz Bandwidth	1 kHz	-4.5 \pm 1.0 dB or less
		100 Hz	Standard
		20 Hz	+6.5 \pm 1.0 dB or less
10 Hz		+10.0 \pm 1.5 dB or less	
2 Hz		+20.5 \pm 2.0 dB or less	
1 Hz		+22.5 \pm 2.0 dB or less	
200 Hz Bandwidth	100 Hz	-4.0 \pm 1.0 dB or less	
	60 Hz	-3.0 \pm 1.0 dB or less	
	25 Hz	Standard	
	10 Hz	+4.0 \pm 1.0 dB or less	
	5 Hz	+7.5 \pm 1.5 dB or less	
	2 Hz	+13.0 \pm 2.0 dB or less	
	1 Hz	+17.0 \pm 2.0 dB or less	
	QP ON/OFF Switching Deviation	$\leq \pm 1.0$ dB (PEAK, QP) (CW signal, at reference level -40 dB, at 18°C to 28°C after automatic calibration)	
Detection Mode	QP, AVERAGE		
Field Strength Measurement	Indication of the correction of waveform data by antenna factor of a designated antenna and measurement of field strength (dB μ V/m). Built-in Antenna factor Dipole Antenna : MP534A/651A Log-Periodic Antenna : MP635A/MP666A Loop Antenna : MP414B User : Programmable through GPIB (OPT9) or RS232C (4 type) Saving/Loading to/from Memory Card (OPT11) possible.		

* Use of Option 02 at the same time is necessary.

SECTION 1 GENERAL

● Option 13: PQ detector

Function	QP detection																												
6 dB bandwidth	bandwidth: 9 kHz, 120 kHz accuracy: ±30% (at 18 to 28°C)																												
Indicator Section	LOG scale, 5 dB/DIV, 10 scale marks Linearity ≤ ±2.0 dB/0 to -40 dB (CW signal, Reference level=60 dB μV, Input Attenuator =0 dB, at 18 to 28°C)																												
Pulse Responsiveness	Response Corresponding to CISPR pulse (at DET mode: QP, 18°C to 28°C)																												
		<table border="1"> <thead> <tr> <th>Repetition Frequency</th> <th>Response</th> </tr> </thead> <tbody> <tr> <td rowspan="6">120 kHz Bandwidth</td> <td>1 kHz</td> <td>-8.0±1.0 dB or less</td> </tr> <tr> <td>100 Hz</td> <td>Standard</td> </tr> <tr> <td>20 Hz</td> <td>+9.0±1.0 dB or less</td> </tr> <tr> <td>10 Hz</td> <td>+14.0±1.5 dB or less</td> </tr> <tr> <td>2 Hz</td> <td>+26.0±2.0 dB or less</td> </tr> <tr> <td>1 Hz</td> <td>+28.5±2.0 dB or less</td> </tr> <tr> <td rowspan="6">9 kHz Bandwidth</td> <td>1 kHz</td> <td>-4.5±1.0 dB or less</td> </tr> <tr> <td>100 Hz</td> <td>Standard</td> </tr> <tr> <td>20 Hz</td> <td>+6.5±1.0 dB or less</td> </tr> <tr> <td>10 Hz</td> <td>+10.0±1.5 dB or less</td> </tr> <tr> <td>2 Hz</td> <td>+20.5±2.0 dB or less</td> </tr> <tr> <td>1 Hz</td> <td>+22.5±2.0 dB or less</td> </tr> </tbody> </table>	Repetition Frequency	Response	120 kHz Bandwidth	1 kHz	-8.0±1.0 dB or less	100 Hz	Standard	20 Hz	+9.0±1.0 dB or less	10 Hz	+14.0±1.5 dB or less	2 Hz	+26.0±2.0 dB or less	1 Hz	+28.5±2.0 dB or less	9 kHz Bandwidth	1 kHz	-4.5±1.0 dB or less	100 Hz	Standard	20 Hz	+6.5±1.0 dB or less	10 Hz	+10.0±1.5 dB or less	2 Hz	+20.5±2.0 dB or less	1 Hz
Repetition Frequency	Response																												
120 kHz Bandwidth	1 kHz	-8.0±1.0 dB or less																											
	100 Hz	Standard																											
	20 Hz	+9.0±1.0 dB or less																											
	10 Hz	+14.0±1.5 dB or less																											
	2 Hz	+26.0±2.0 dB or less																											
	1 Hz	+28.5±2.0 dB or less																											
9 kHz Bandwidth	1 kHz	-4.5±1.0 dB or less																											
	100 Hz	Standard																											
	20 Hz	+6.5±1.0 dB or less																											
	10 Hz	+10.0±1.5 dB or less																											
	2 Hz	+20.5±2.0 dB or less																											
	1 Hz	+22.5±2.0 dB or less																											
QP ON/OFF Switching Deviation	≤ ±1.0 dB (PEAK, QP) (CW signal, at reference level -40 dB, at 18°C to 28°C after automatic calibration)																												
Detection Mode	QP, AVERAGE																												
Field Strength Measurement	<p>Indication of the correction of waveform data by antenna factor of a designated antenna and measurement of field strength (dBμV/m).</p> <p>Built-in Antenna factor</p> <p>Dipole Antenna : MP534A/651A</p> <p>Log-Periodic Antenna : MP635A/MP666A</p> <p>Loop Antenna : MP414B</p> <p>User : Programmable through GPIB (OPT9) or RS232C (4 type)</p> <p>Saving/Loading to/from Memory Card (OPT11) possible.</p>																												

● Option 19: DC Coupling Input*

Function	DC coupling the input circuits of the main body and expanding the lower limit of reception frequency range to 500 Hz.	
Frequency Range	500 Hz to 3.0 GHz	
Amplitude	Max. Input Level	Continuous Wave Ave. Power: +30dBm (Input Attenuator ≥ 10 dB) DC Voltage: ±0 V
	Average Noise Level	Resolution Bandwidth at 30 Hz, Video Bandwidth at 1 Hz, and Input Attenuator at 0 dB: ≤ -80 dBm (500 Hz to 10 kHz) ≤ -90 dBm (100 kHz to 200 kHz) ≤ -110 dBm (200 kHz to 1 MHz)
	Frequency Characteristic	100 MHz, as a standard ±1.2 dB (500 Hz to 100 kHz) ±0.5 dB (100 kHz to 3.0 GHz)

* Use of Option 02 at the same time is necessary.

SECTION 2

PREPARATIONS BEFORE USE

This section explains the preparations and safety procedures that should be performed before using the MS2650/MS2660 series Spectrum Analyzer. The safety procedures are to prevent the risk of injury to the operator and damage to the equipment. Insure that you understand the contents of the pre-operation preparations before using the MS2650/MS2660 series. For connecting the GPIB cable and setting the GPIB address, see the Remote Control part of the separate Operation Manual Vol.3.

TABLE OF CONTENTS

Installation Site and Environmental Conditions	2-3
Locations to be avoided	2-3
Fan clearance	2-3
Safety Measures	2-4
Power-on	2-4
Input level to RF Input	2-5
Installation	2-6
Rack mounting	2-6
Preparations before Power-on	2-7
Protective grounding	2-8
Replacing fuse	2-9
Precaution for Handling Memory Card	2-11

SECTION 2 PREPARATIONS BEFORE USE

Installation Site and Environmental Conditions

Locations to be avoided

The MS2650/MS2660 series spectrum analyzer operates normally at temperatures from 0 to 50 °C. However, for the best performance, the following locations should be avoided.

- Where there is severe vibration
- Where the humidity is high
- Where the equipment will be exposed direct sunlight
- Where the equipment will be exposed active gases

In addition to meeting the above conditions, to insure long-term trouble-free operation, the equipment should be used at room temperature and in a location where the power supply voltage does not fluctuate greatly.

CAUTION

If the MS2650/MS2660 series spectrum analyzer is used at normal temperatures after it has been used or stored for a long time at low temperatures, there is a risk of short-circuiting caused by condensation. To prevent this risk, do not turn the MS2650/MS2660 series on until it has been allowed to dry out sufficiently.

Fan clearance

To suppress any internal temperature increase, the MS2650/MS2660 series has a fan on the rear panel as shown in the diagram below. Leave a gap of at least 10 cm between the rear panel and the wall, nearby equipment or obstructions so that fan ventilation is not blocked.

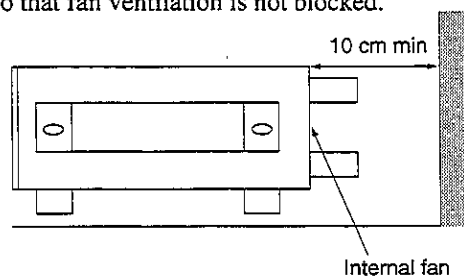

Safety Measures

This paragraph explains the safety procedures which should be followed under all circumstances not to counter the risk of an accidental electric shock, damage to the equipment or a major operation interruption.

Power-on

WARNING

-
- Before power-on: The MS2650/MS2660 series spectrum analyzer must be connected to protective ground.
If the power is switched on without taking this countermeasure, there is a risk of receiving a accidental electric shock. In addition, it is essential to check the power supply voltage. If an abnormal voltage that exceeds the specified value is input, there is accidental risk of damage to the MS2650/MS2660 series and fire.

 - During power-on: To maintain the MS2650/MS2660 series, sometimes it is necessary to make internal checks and adjustments with the covers removed while power is supplied. Very-high, dangerous voltages are used in the MS2650/MS2660 series, if insufficient care is taken, there is a risk of a accidental electric shock being received or of damage to the equipment. To maintain the MS2650/MS2660 series, request service by a service personnel who has received the required training.
-

In the following, special notes on safety procedures are extracted from sections other than Section 2. To prevent accidents, read this section together with the related sections before beginning operation.

Input level to RF Input

Frequency range: 9 kHz to 3 GHz (MS2651A/2661A)
9 kHz to 8.1 GHz (MS2653A/2663A)

Measurement level: Apply the measured signal with average noise level of up to + 30 dBm to the N-type connector RF Input of 50 Ω input impedance



CAUTION

The RF Input circuit is not protected against excessive power.

If a signal exceeding + 30 dBm is applied with input attenuator setting ≥ 10 dB, the input attenuator and input mixer may be burned.

When the Option-08 Preamplifier installed and the preamplifier ON; if a signal exceeding +10 dBm or +20 dBm is applied with input attenuator setting ≥ 0 dB or 10 dB, respectively, the input attenuator and input mixer may be burned.

 is a warning mark to prevent such damage.

Installation

Rack mounting

The B0395A/0395B Rack Mount Kit (sold separately) is required to mount this unit in a rack.
The installation method is included in the rack mount kit diagram.

Preparations before Power-on

This unit operates normally when it is connected to an 85 to 132 Vac, or 170 to 250 Vac (automatic voltage change) 47.5 to 63 Hz AC power supply. To prevent the following problems, take the necessary procedures described on the following pages before power is supplied.

- Accidental electric shock
- Damage caused by abnormal voltage
- Ground current problems

Note:

- *The voltage and current rating are indicated on the rear panel when the instrument is shipped from the factory.*
- *In this manual, the power supply voltage and current ratings are represented by ** Vac and *** A, respectively.*

To protect the operator, the following WARNING and CAUTION notices are attached to the rear panel of the MS2651A/MS2661A.

WARNING 
 NO OPERATOR SERVICE-
 ABLE PARTS INSIDE.
 REFER SERVICING TO
 QUALIFIED PERSONNEL.

CAUTION 
 FOR CONTINUED FIRE
 PROTECTION REPLACE
 ONLY WITH SPECIFIED
 TYPE AND RATED FUSE.

WARNING 

Disassembly, adjustment, maintenance, or other access inside this instrument by unqualified personal should be avoided. Maintenance of this instrument should be performed only by Anritsu trained service personnel who are familiar with the risk involved of fire and electric shock. Potentially lethal voltages existing inside this instrument, if contacted accidentally, may result in personal injury or death, or in the possibility of damage to precision components.

Always follow the instructions on the following pages.

Protective grounding

(1) Grounding with 3-pole power outlet

When connecting to a 3-pole (grounded, 2-pole type) AC power-supply outlet, the frame of the MS2650/MS2660 series is connected to ground potential. As a result, it is not necessary to connect the FG terminal to ground.

(2) Grounding with frame ground (FG) terminal

When there is no 3-pole AC power-supply outlet, the protective frame-ground (FG) terminal on the rear panel must be connected directly to ground potential.

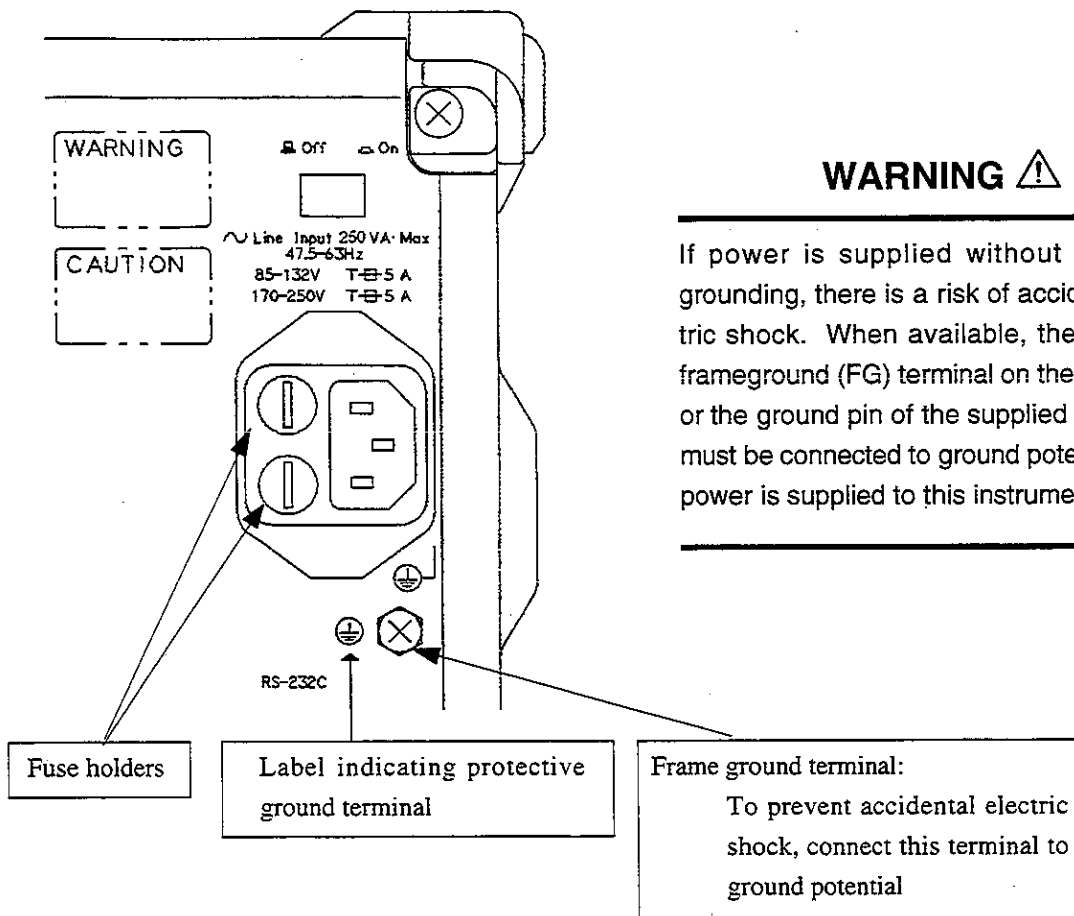

WARNING

If power is supplied without protective grounding, there is a risk of accidental electric shock. When available, the protective frameground (FG) terminal on the rear panel, or the ground pin of the supplied power cord must be connected to ground potential before power is supplied to this instrument.

Replacing fuse

WARNING

-
- If the fuses are replaced while power is supplied, there is a serious risk of electric shock. Before replacing the fuses, set the power switch to OFF and remove the power cord from the power outlet.
 - If power is supplied without protective grounding, there is a risk of accidental electric shock. In addition, if the AC power supply voltage is unsuitable, there is a risk of the internal circuits of the MS2650/MS2660 series being damaged by the abnormal voltage. Before supplying power again after changing the fuses, check that the protective grounding described previously is still connected, and check that the AC power supply voltage is suitable. Then, set the power switch to ON.
-

CAUTION

When there are no supplied spare fuses, the replacement fuses must have the same rated voltage and current as the fuses in the fuse holders.

- If the replacement fuses are not of the same type, they may not fit correctly, there may be a faulty connection, or the time taken to for the fuses to blow may be too long.
 - When an abnormality occurs again, if the voltage and current rating of the fuses is incorrect, the fuses may not blow with a consequent risk of damage to the equipment by fire.
-

SECTION 2 PREPARATIONS BEFORE USE

This instrument with standard accessories has two spare 5 A fuses. The fuses are mounted in the fuse holder and must be replaced if they blow. If the fuses must be replaced, locate and remedy the cause before replacing the blown fuses.

After performing the safety procedures described on the preceding page, replace the fuses according to the following procedure.

Step	Procedure
1	Set the front-panel [Power] switch to Stby and the rear-panel [Line] switch to OFF. Then, remove the power cord from the power-supply outlet.
2	Use a flat-bladed screwdriver to turn the fuse-holder cap counterclockwise. The cap and fuse are removed as a unit from the fuse holder.
3	Remove the fuse from the fuse cap and replace it with a spare fuse. (The direction does not matter.)
4	Return the fuse cap with fuse to the fuse holder and fasten it by turning it clockwise with the flat-bladed screwdriver.

Precaution for Handling Memory Card

See para. 1.3 for the memory card to be used.

When a new memory card used to save any file, format it beforehand to MS-DOS.

When saving data to a memory card; confirm that the write-protect switch of the card is set at the NOT-PROTECTED side, and then install it to this instrument. (For the setting method, see the operation manual of the card .)

- Installing Memory Card

Install the memory card to this instrument, with the cutout of the card at the position as shown below. Two card can be installed at the upper and lower sides.

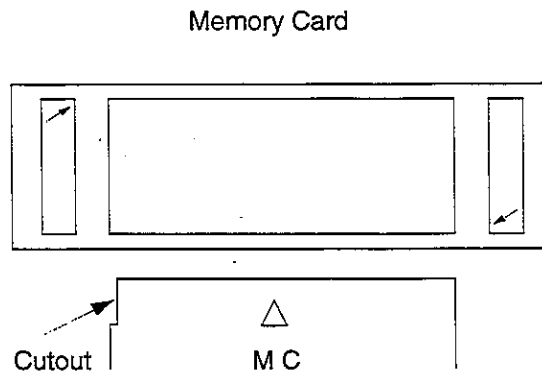

- Removing Memory Card

Push the left eject button to remove the memory card at the upper side.

Push the right eject button to remove the memory card at the lower side.

- Replacing Battery of Memory Card

Memory card has a battery. When the battery life ends, the saved data is erased. Replace the battery before the life end. (For the battery life and replacing method, see the operation manual of the card.)

SECTION 2 PREPARATIONS BEFORE USE

SECTION 3

PANEL DESCRIPTION

In this section, the front and rear panels are described about the case in which all the options are attached to.

TABLE OF CONTENTS

Table of Front and Rear Panel Features	3-3
--	-----

SECTION 3 PANEL DESCRIPTION

In this section, the front and rear panels (Figs. 3-1 and 3-2) are described about the case in which all the options are attached to.

Table of Front and Rear Panel Features

No.	Panel Making	Explanation of Function
1	(LCD)	This is a 5.7" color TFT liquid crystal display (LCD). It displays the trace waveforms, the parameter settings, the values of marker, and the soft menu keys, etc.
2	Menu On / Off	This toggles the soft-key menu display On / Off.
3	F 1 - F 6	These are the soft keys for selecting the soft-key menus linked to the panel key operation.
4	More	This displays the next page of soft-key menus.
5	Freq / Ampl	This is the frequency and level parameter data input section. [Frequency] Sets frequency. [Span] Sets frequency span. [Amplitude] Sets reference level. [-> CF] Sets peak level signal frequency on screen to center frequency. [-> RLV] Sets peak level on screen to reference level.
6	Marker	This section is related to operation of marker functions. [Marker] Sets marker. [Multi Mkr] Sets multimarkers. Press this key after pressing the [Shift] key. [Peak Search] Moves marker to currently-displayed peak level. [Marker ->] Sets parameter according to marker value. Press this key after pressing the [Shift] key.
7	User	This is a user-dedicated key which users can specify.

SECTION 3 PANEL DESCRIPTION

No.	Panel Making	Explanation of Function
8	Single	<p>This sets the sweep mode.</p> <p>[Single] Executes single sweep.</p> <p>[Continuous] Executes continuous sweeping.</p> <p>Press this key after pressing the [Shift] key.</p> <p>The initial default is continuous sweeping.</p>
9	Recall	<p>This executes recall / save.</p> <p>[Recall] Reads measurement parameters and waveform data from internal memory or memory card.</p> <p>[Save] Saves measurement parameters and waveform data to internal memory or memory card.</p>
10	Measure	<p>This menu is for performing the various application measurements including frequency measurement, noise measurement, adjacent-channel leakage power measurement, etc.</p>
11	TG	<p>This sets the tracking generator function.</p> <p>(If Option 20 is not attached to, this key is not provided.)</p>
12	Display	<p>This section is for selecting the trace waveform. Normally, in the frequency domain, up to two trace waveforms can be displayed. The zero-span (Time Domain) mode is selected simply by pressing the [Time] key.</p> <p>[A, B] Displays trace A or B waveform in frequency domain.</p> <p>[A/B, A/BG] Displays trace A and B waveforms simultaneously, or displays trace A and BG (background frequency spectrum including trace A) simultaneously.</p> <p>[Time] Switches to zero span (Time domain) mode to display time domain waveforms.</p> <p>[A/Time] Displays trace A and the time domain waveform simultaneously.</p>
13	Trig / Gate	<p>This sets the trigger/gate and TV-image monitoring functions.</p> <p>[Trig/Gate] Sets the sweep-start trigger and gate(to control waveform-data write timing) functions.</p> <p>[TV Monitor] Sets the TV-image monitoring function.</p>
14	Coupled Function	<p>This sets the RBW, VBW, sweep time and input attenuator.</p>

No.	Panel Making	Explanation of Function
15	Entry	<p>These keys set the numeric data, units and special functions.</p> <p>[Rotary knob] Used for moving marker and inputting data.</p> <p>[^ , √] Increments and decrements input data.</p> <p>[Shift] To execute panel functions indicated by blue letters, press this key and then press the blue-lettered key.</p> <p>[BS] Backspace key for correcting input mistakes.</p> <p>[0-9, . , +/-] Numeric-data setting keys.</p> <p>[GHz, MHz, kHz, Hz] Units keys for frequency, level, time, etc.</p>
16	Preset	This sets the measurement parameters to the default values.
17	Local	This changes the remote status to the local status.
18	Copy	This outputs a hard copy of the screen to a printer or plotter.
19	Stby / On	This is the power switch. It can be used when the back-panel power switch is on. The power-on condition is fetched from the Stby condition when the key is pressed for about 1 seconds. The equipment is returned to the Stby condition from the power-on condition when the key is pressed again for about 1 seconds.
20	Memory Card	<p>This is the slot to set memory cards which save/load the waveform data and measurement parameters etc. Up to two plug-in memory card can be used.</p> <p>If Option 11 is not attached to, this is not provided.</p>
21	RF Input	This is the RF input connector.
22	TG Output	<p>This is the tracking generator output connector.</p> <p>(If Option 20 is not attached to, this connector is not provided.)</p>
50	(Fan)	This is the cooling fan for ventilating internally-generated heat. Leave a clearance of at least 10 cm around the fan.
51	10 MHz STD	<p>This is the input connector for an external reference crystal oscillator.</p> <p>When an external reference signal is input, the equipment switches automatically from the internal signal to the external signal.</p> <p>If Option 01 is not attached to, this connector is not provided.</p>
52	IF OUT	This is the IF output connector. This signal is bandwidth controlled by the RBW setting and is logarithmically compressed at log scale.
53	Video (Y)	This connector output a Y-axis signal that is proportional to the video detection signal output.

SECTION 3 PANEL DESCRIPTION

No.	Panel Making	Explanation of Function
54	Composite Out	This is the video composite signal output connector.
55	Off / On	This is the AC line power switch.
56	(Inlet)	This is the fused AC power inlet to which the supplied power cord is connected. It contains two time-lag fuses.
57	(Ground Terminal)	Connect this frame ground terminal to ground to prevent risk of an accidental electric shock.
58	RS-232C	This is the RS-232C connector. Connect it to an external system controller or printer, etc.
59	GPIB or PARALLEL	This connector is for use with a GPIB (Option 09) or PARALLEL (Option 10) interface. It is connected to an external system controller, or a printer etc. (If no options are attached to, this connector is not provided.)
60	Trig/Gate In (± 10 V)	This is a input connector for external trigger/gate signal. (If Option 06 is not attached to, this connector is not provided.)
61	Phone	This is a output connector for earphone. (If Option 07 is not attached to, this connector is not provided.)
62	Sweep (X)	This is a output connector for sweep signal (X). (If Option 15 is not attached to, this connector is not provided.)
63	Sweep Status (Z)	This is a output connector for sweep status signal (Z). (If Option 15 is not attached to, this connector is not provided.)

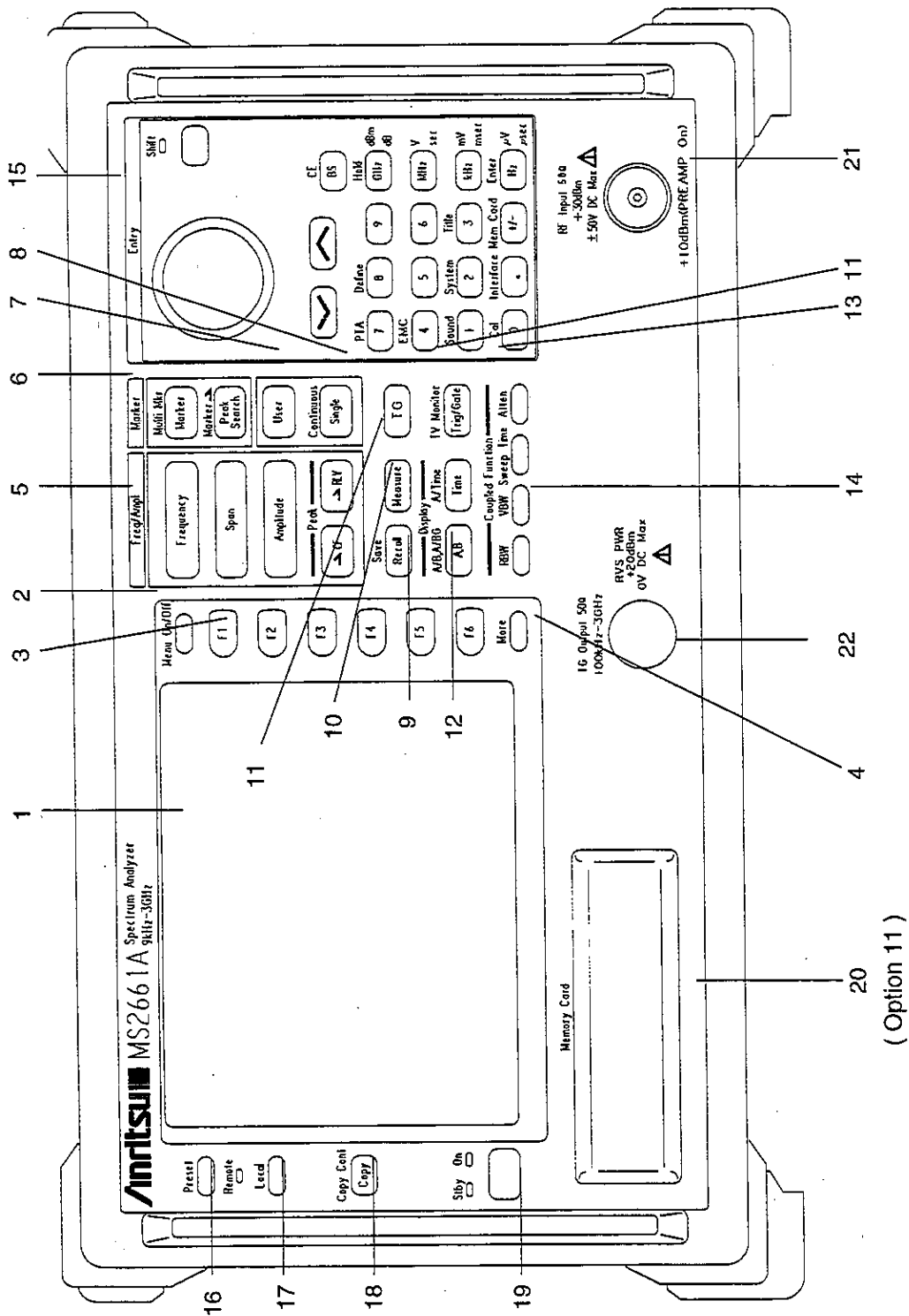

Fig. 3-1 Front Panel

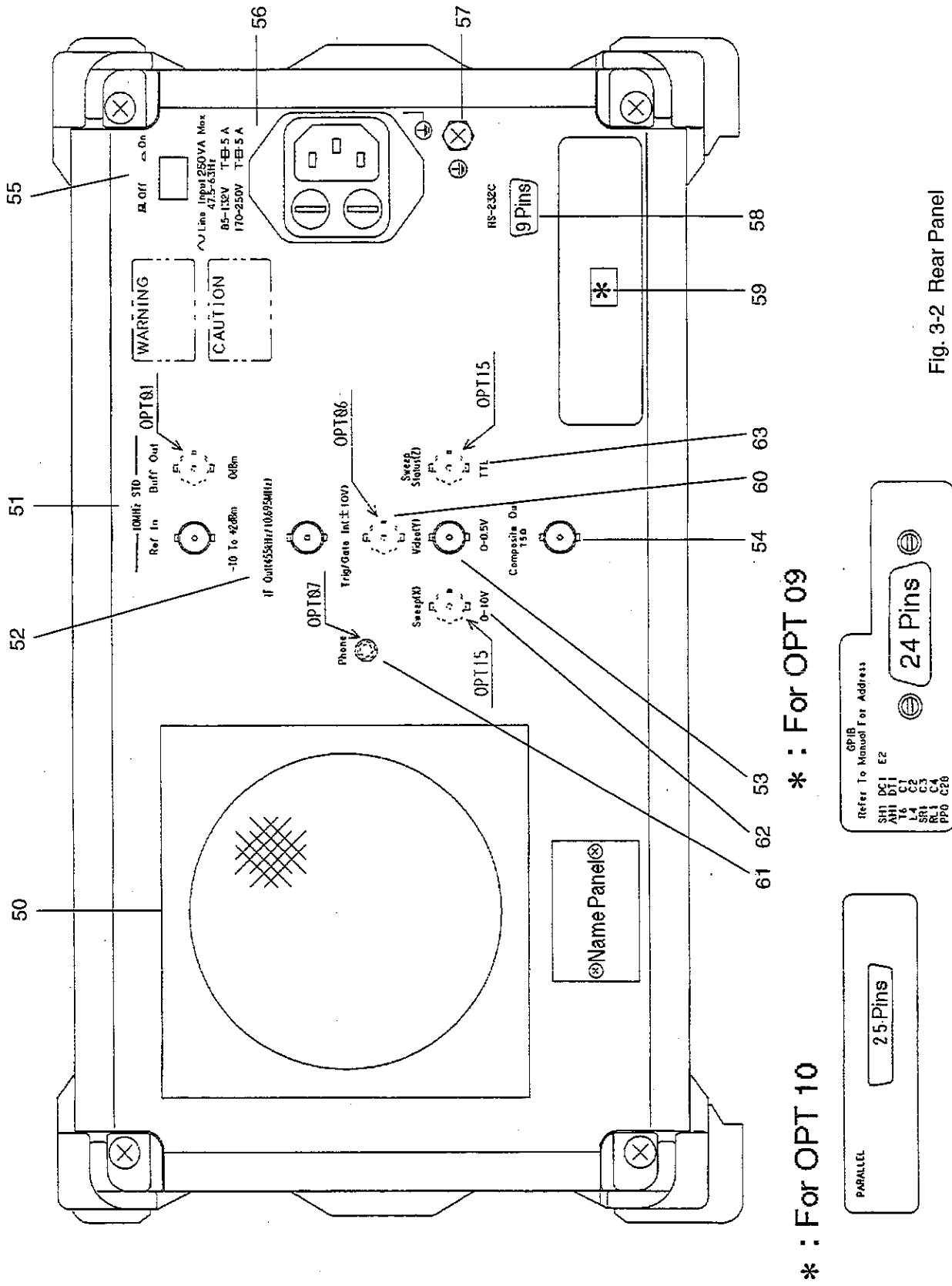

Fig. 3-2 Rear Panel

SECTION 4

SOFT-KEY MENU

In this section, soft-key menu functions and its hierarchical system are described using a tree.

TABLE OF CONTENTS

Soft-key Menu List	4-4
Menu Tree	4-6

SECTION 4 SOFT-KEY MENU

In this section, soft-key menu functions and its hierarchical system are described using a tree. Matters to be noted about the tree are shown below.

- (1) Panel Key indicates a hard key on the front panel.
- (2) Top menus are the menus at the top level which are displayed on the screen when the panel key is pressed. Lower menus indicates other menus below the top menus.
- (3) When a soft key with an appended asterisk (*) is pressed in these menus, the menu moves to the lower menu indicated by the arrow symbol (->). However, if any not-supported-function soft key in an Option is pressed, an error message is displayed.
- (4) When the Return key is pressed at a lower menu, the next-higher menu is returned.
- (5) Menus with more than six items are split into several pages.
- (6) The menu page construction and currently-displayed page are indicated in the lower part of the menu. To move to the next page, press the [More] key.
- (7) Panel keys and soft keys prefixed by a sharp symbol (#) at the left of the menu frame, give an outline explanation of the function.

Soft-key Menu List

Menu	Menu Tree (page/28)	Menu	Menu Tree (page/28)
A) A/B,A/BG	16	G) Gate	18
A/Time	17	Gate Setup	18
ACP Setup1	8	H) Hold Count	15
ACP Setup2	8	I) Impedance	2
ACP Setup3	8	Initialize	27
Ajd ch Pwr	8	Interface	23
Amplitude	2	Item	12 , 20
Attenuator	2 , 3	L) Lib Exec	26
Avq Count	15	Lib File	26
B) Burst Pwr	11	Lib Memory	26
C) C/N Meas	7	Lib Prgm	27
Cal	22	Lib Remove	26
Change Clr	21	Lin Scale	2
Ch Power	7	Line	9 , 10
Check File	26	Load/Save	9 , 10
Copy Cont	20	Location	20
Copy from	21	Log Scale	2
Correction	2	Lvl Offset	2
CountSetup	7	M) Manual Set	4
D) Def Files	27	Marker	4
Def Menues	27	Marker->	4 , 5
Define	27	Mask Meas	9
Define Clr	21	Measure	7
Detection	15 , 17	Media	25 , 27
Dip	5	Media	2 , 9 , 10
Directory	25	Mem Card	25
Disp Line	2 , 4	Mkr List	4
Display	21	Move Mask	9
E) Edit Menu	27	Move Temp	10
Expand	17	Multi Marker	4
F) File Ope	25	N) Noise Meas	7
FM Monitor	17	Normalize	14
Format	25	O) OBW Setup	8
Freq Count	7	Occ BW	8
Frequency	1		

Menu	Menu Tree (page/28)	Menu	Menu Tree (page/28)
P) Paper Size	20	System	21
Peak	5	T) Temp Meas	10
Plotter	20	TG	14
Pon State	21	Threshold	5
Pre Ampl	2	Title	24
Preset	28	Trace A,B	14 , 15
Preslctr	22	Trace Calc	15
Printer	20	Trace Move	15
PTA	25	Trace Time	17 , 18
PTA Lib	26	TrackingAd	14
Q) QP/EMC	24	Trnsformer	2
R) RBW	3	Trig Ext	18
Recal Media	12	Trig TV	18
Recall	12	Trig Video	18
Ref Line	15	Trigger	18
Ref Step	2	TV Monitor	19
RS232C	24	U) Units	2
S) Save	13	User1	6
Save Media	13 , 20	User2	6
ScrollStep	1	User3	6
Select	2 , 9 , 10	V) VBW	3
Set Date	21	W) Wide IF	18
Set Time	21	Z) Zone Width	4
Setup	2		
Setup Mask	9		
Setup Temp	10		
Souce	17 , 18		
Sound	21		
Span	1		
Storage	15 , 17		
Sweep Time	3		
Swp Contl	16 , 17		

Menu Tree

Menu Tree (1 /28)

Panel Key | Top menu | Lower menus

Frequency
Frequency
Center Freq
Start Freq
Stop Freq
Peak ->CF
#1 Auto Tune
#2 CF Step Size
1

- Set items related to frequency, including the center frequency, start/stop frequency, peak->CF, auto synchronization, frequency scroll step size and scroll step size, etc.

#1 Detects peak point in pre-specified (in BG range) span and automatically tunes the peak signal to the specified span.

#2 Sets frequency step size for changing center frequency.

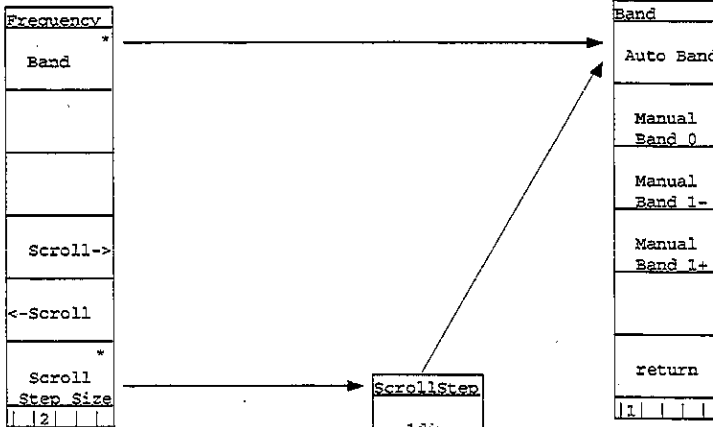

Span
Span
Full Span
Zero Span
Scroll->
<-Scroll
Band

- Set frequency span items, including frequency span, full span, zero span, frequency span scroll, etc.

Menu Tree (2/28)

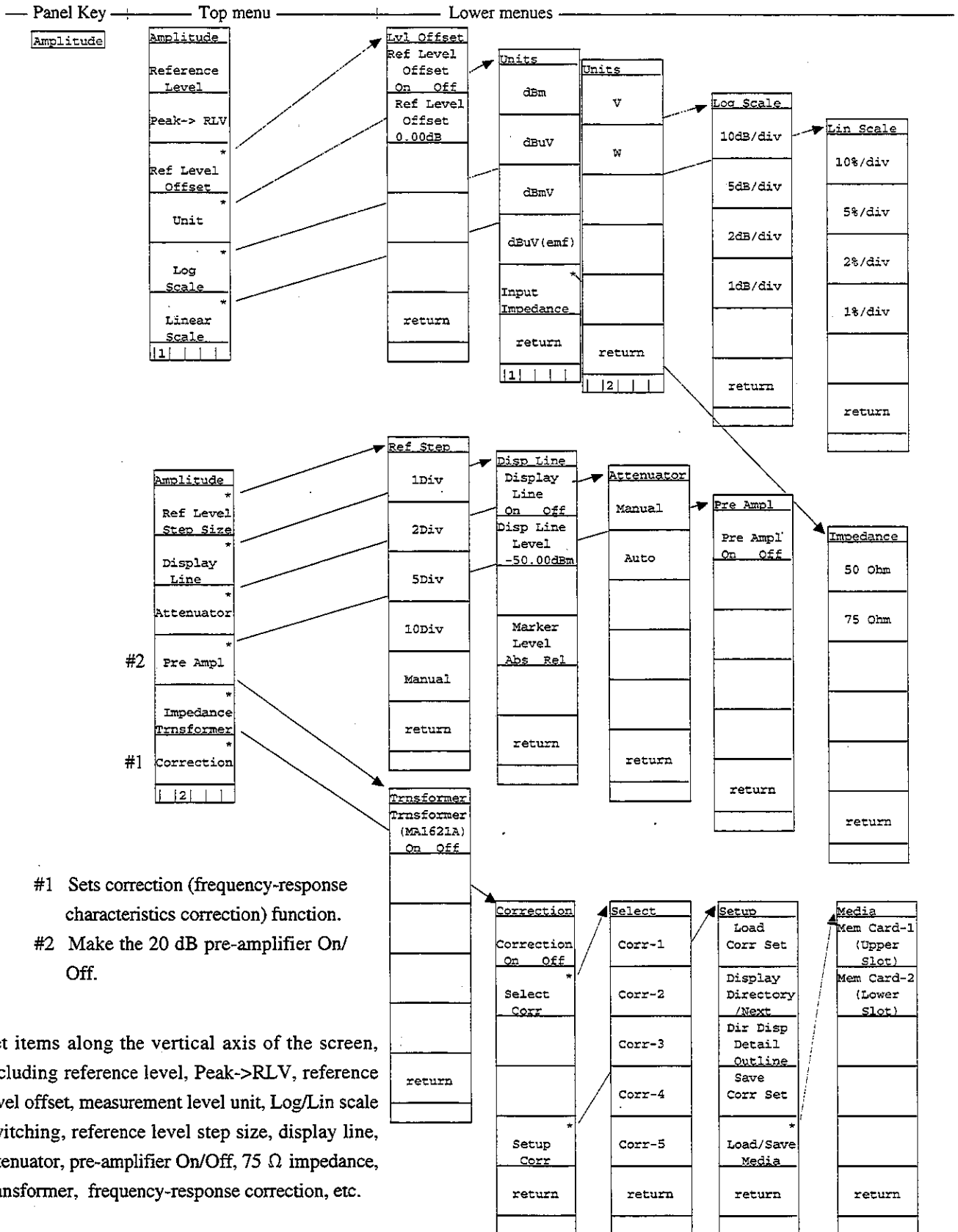

Menu Tree (3/28)

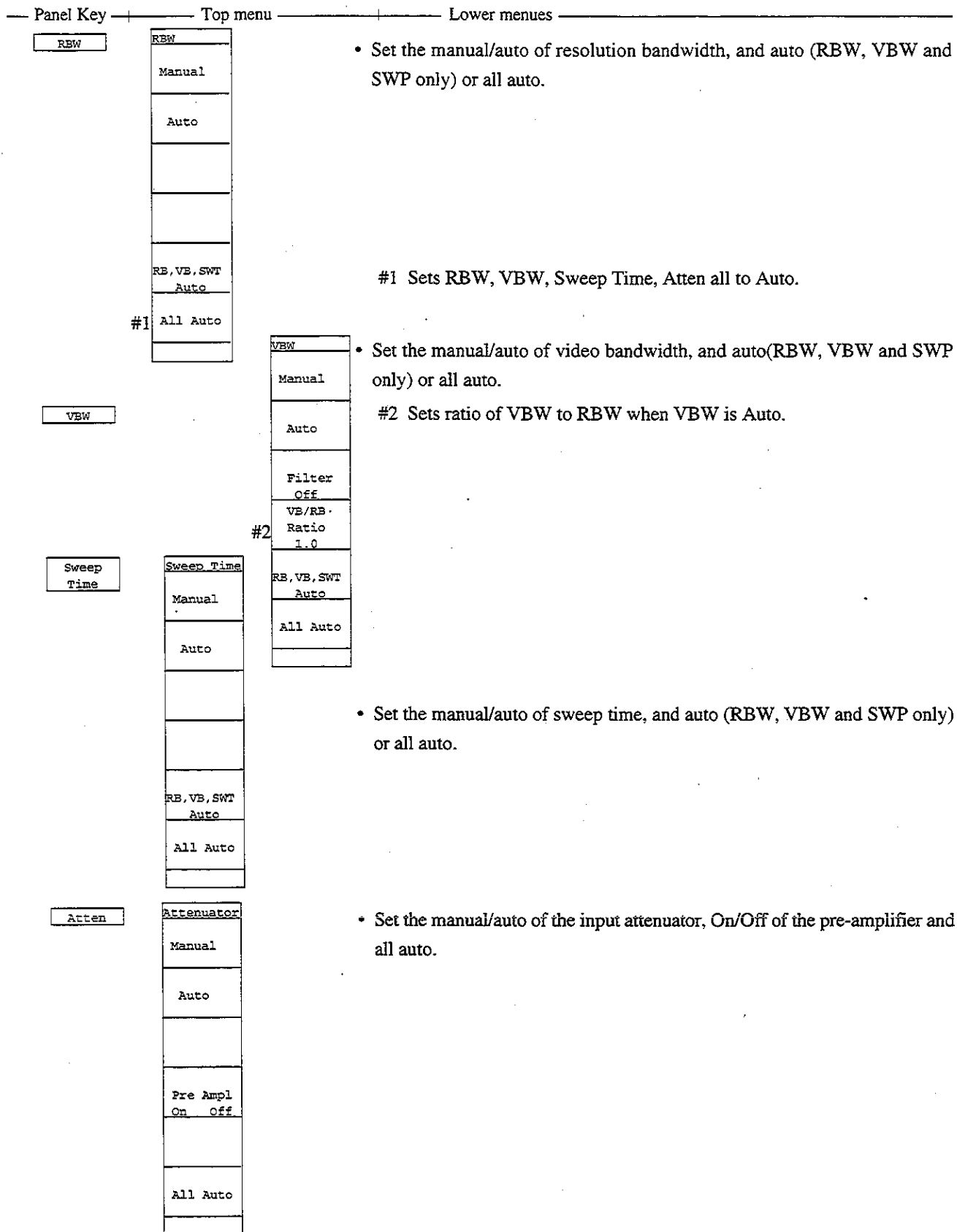

Menu Tree (5 /28)

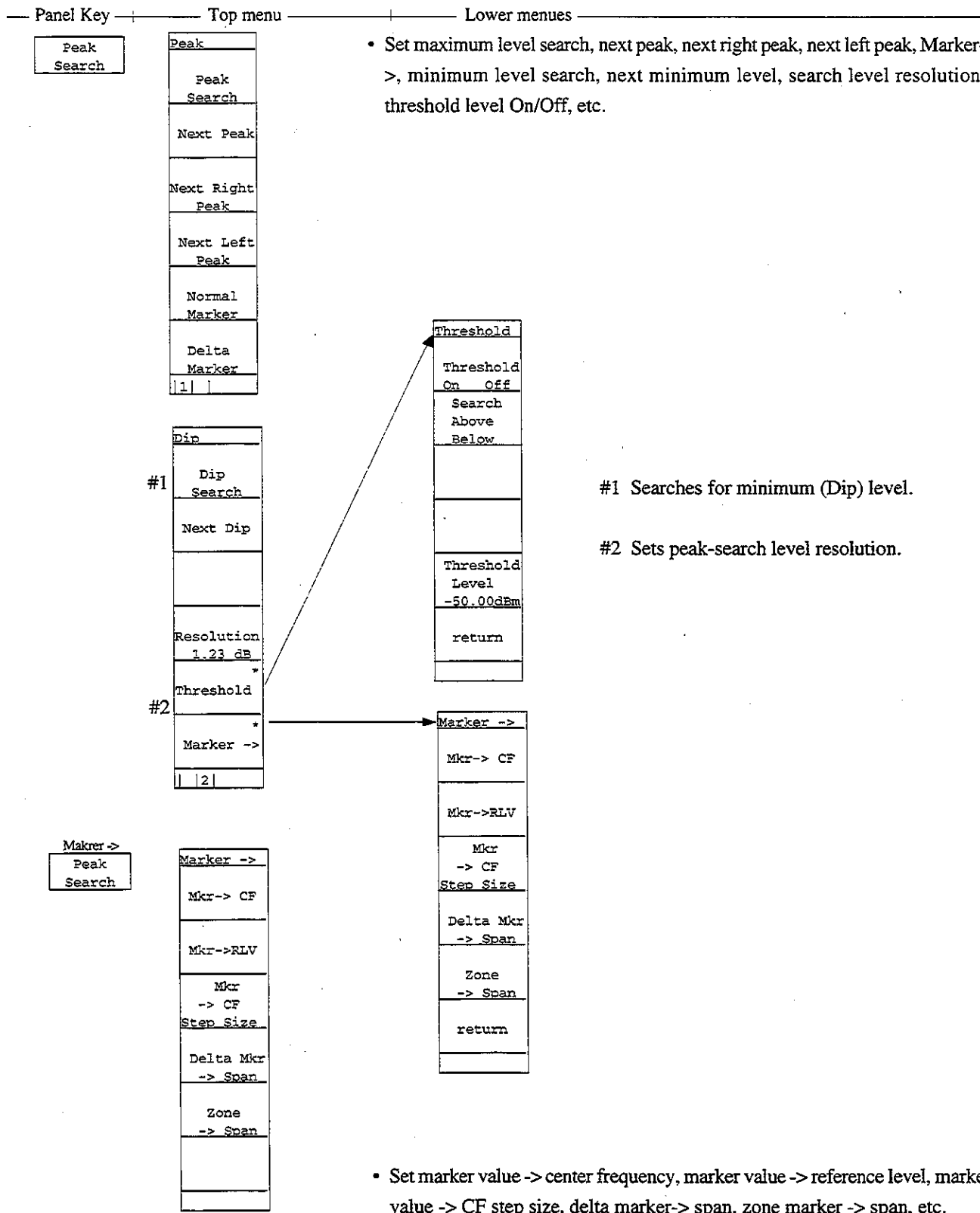

Menu Tree (6/28)

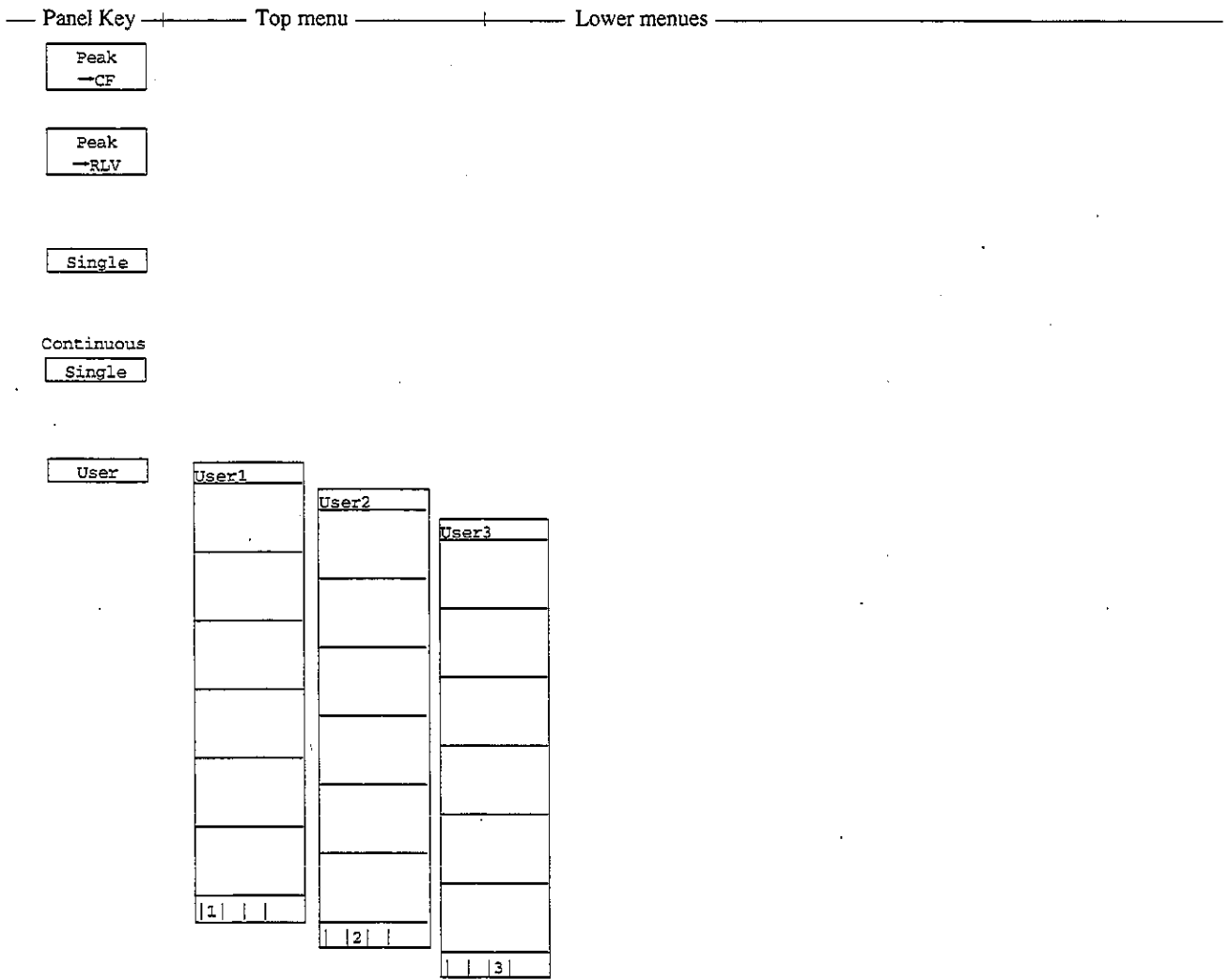

- The soft-key menu defined by the user is displayed. (See "User Define".)

SECTION 4 SOFT-KEY MENU

Menu Tree (7/28)

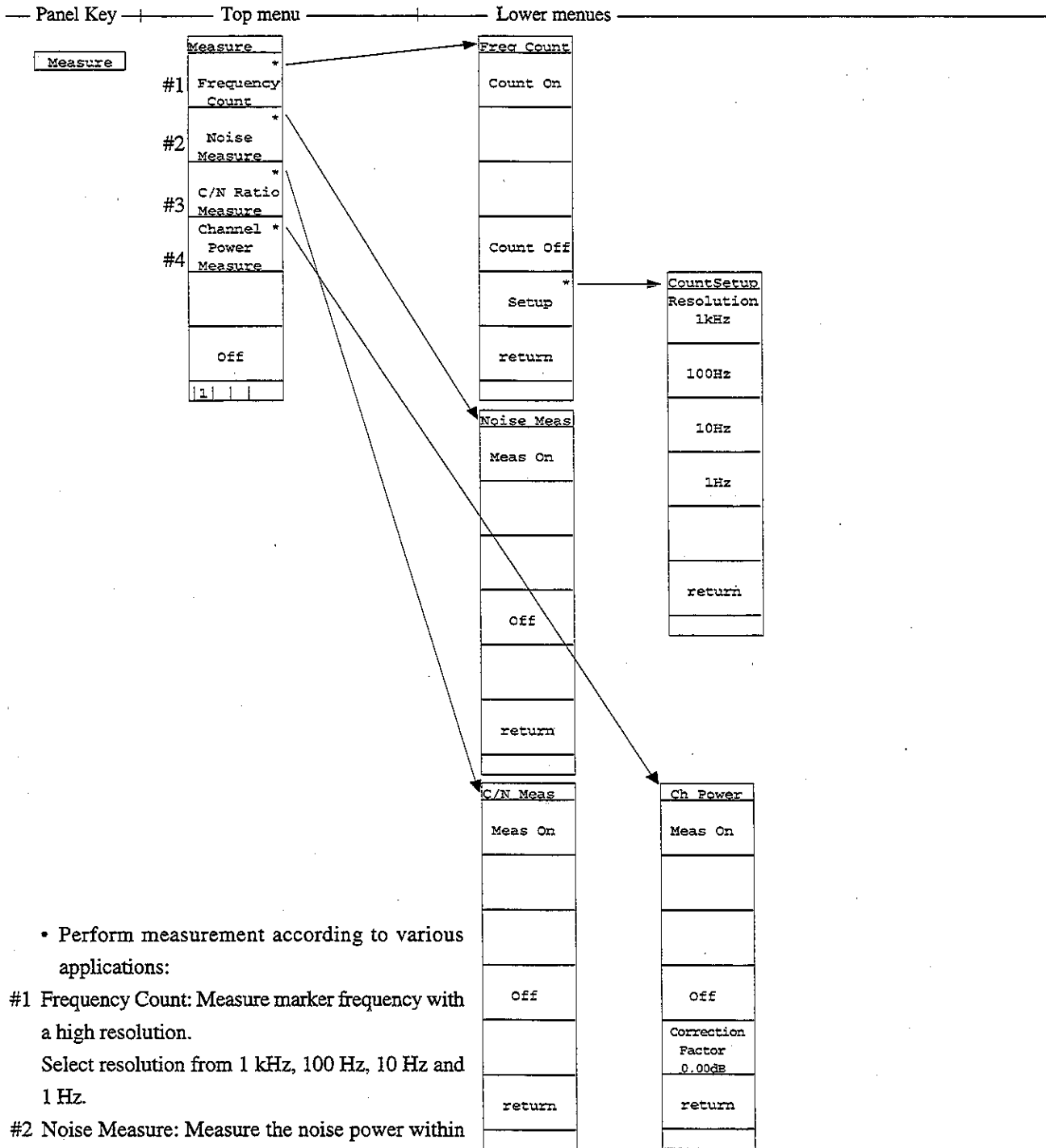

• Perform measurement according to various applications:

#1 Frequency Count: Measure marker frequency with a high resolution.

Select resolution from 1 kHz, 100 Hz, 10 Hz and 1 Hz.

#2 Noise Measure: Measure the noise power within zone marker.

#3 C/N Ratio Measure: Measure the ratio of carrier signal and noise power. Reference marker of the delta marker shall be set to the carrier, and marker's zone width specifies the power measured.

#4 Channel Power Measure: Power with in the band indicated by zone maker is measured. It is possible to set an arbitrary calibration value.

Menu Tree (8/28)

Panel Key | Top menu | Lower menus

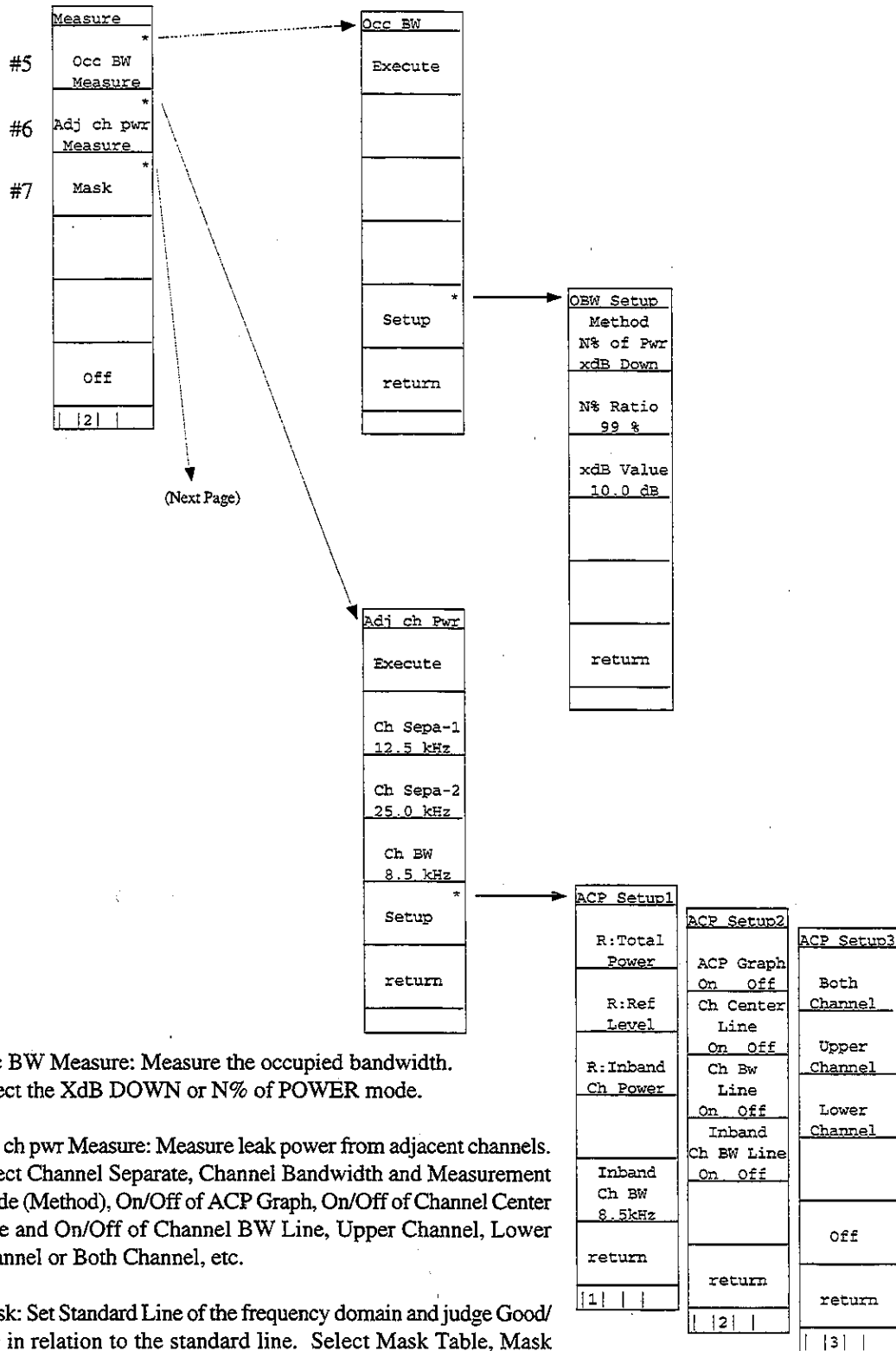

#5 Occ BW Measure: Measure the occupied bandwidth. Select the XdB DOWN or N% of POWER mode.

#6 Adj ch pwr Measure: Measure leak power from adjacent channels. Select Channel Separate, Channel Bandwidth and Measurement Mode (Method), On/Off of ACP Graph, On/Off of Channel Center Line and On/Off of Channel BW Line, Upper Channel, Lower Channel or Both Channel, etc.

#7 Mask: Set Standard Line of the frequency domain and judge Good/NG in relation to the standard line. Select Mask Table, Mask Movement, Measurement Mode, Mask Table Preparation, Load/Save of Mask Table, etc.

SECTION 4 SOFT-KEY MENU

Menu Tree (9/28)

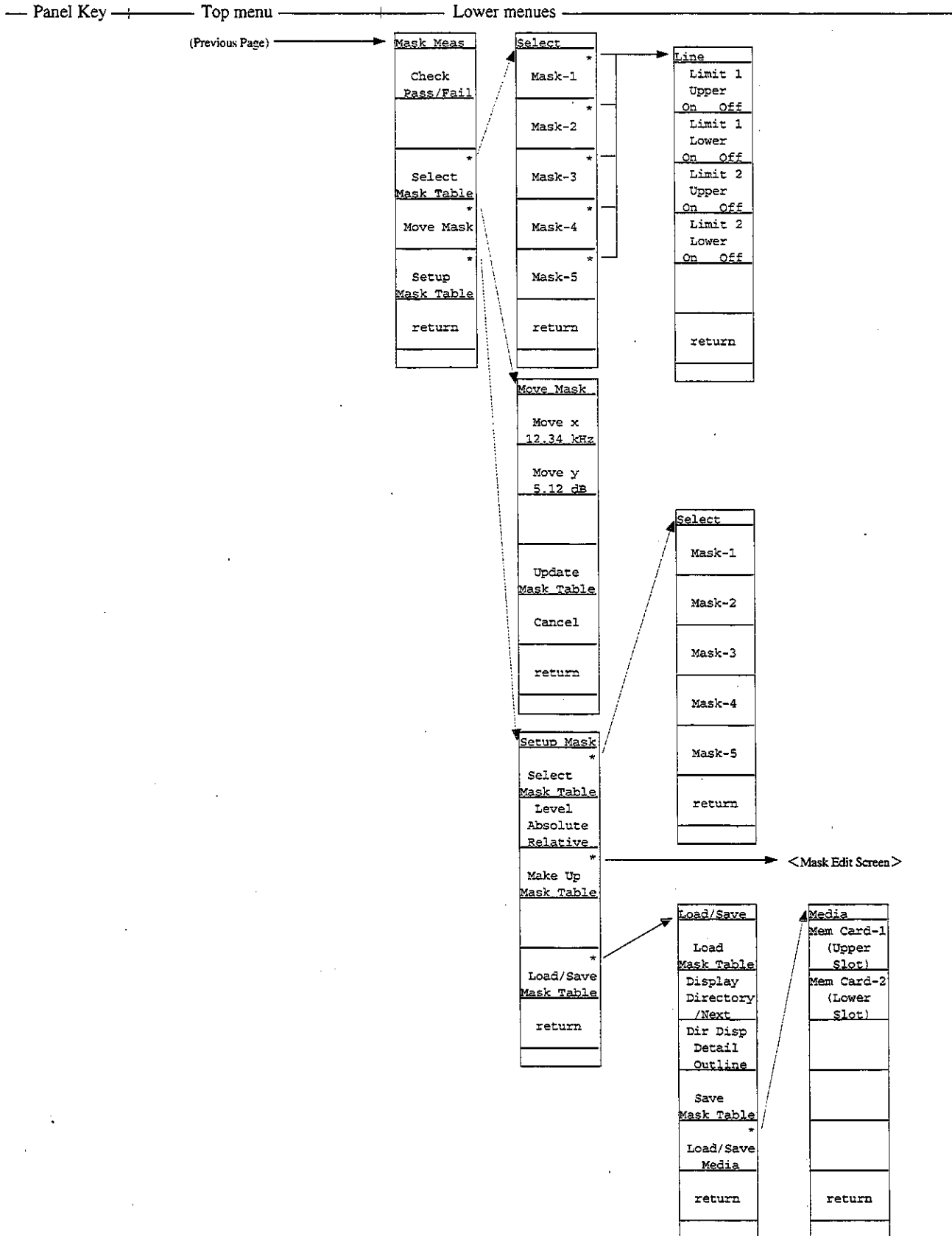

Menu Tree (10/28)

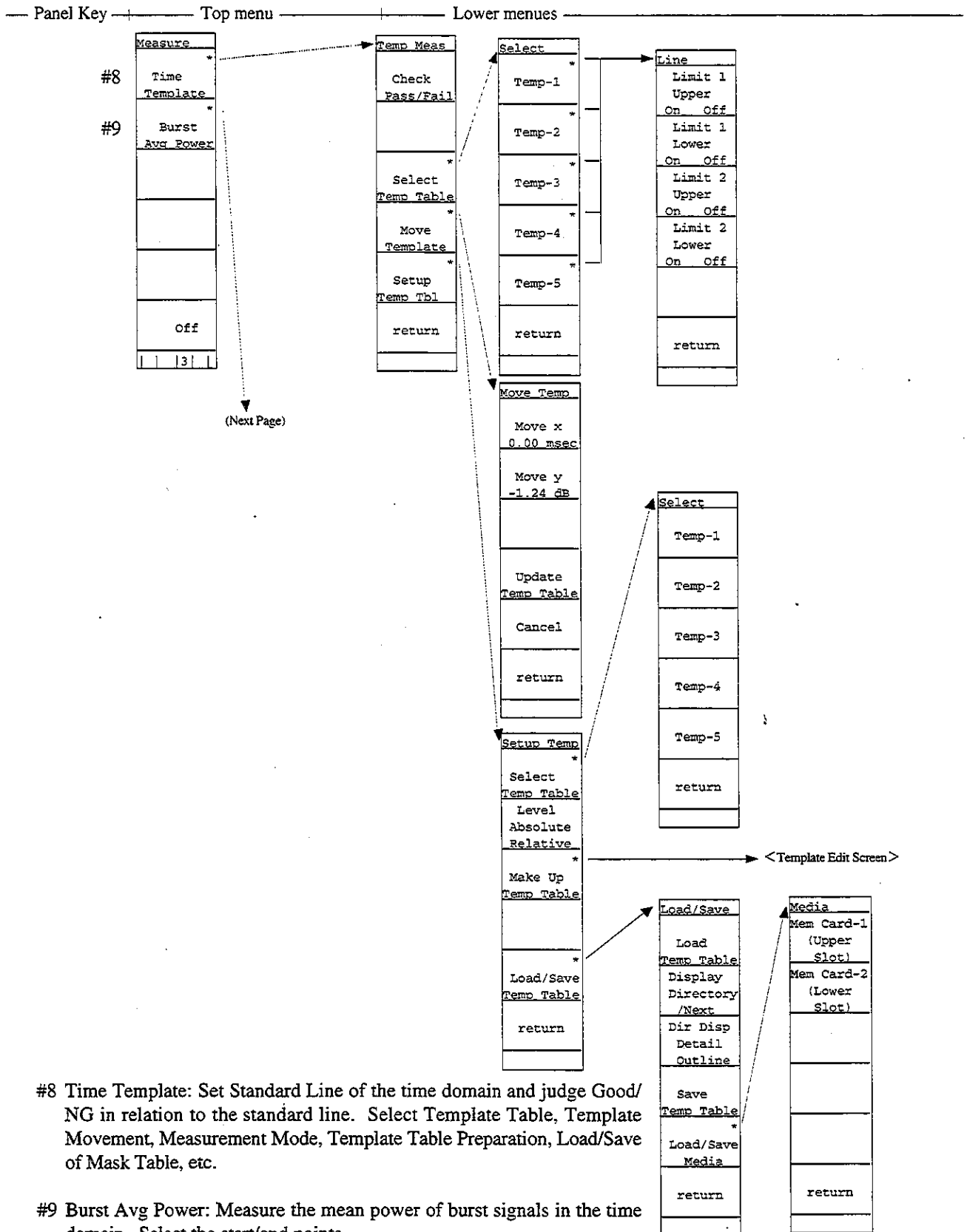

#8 Time Template: Set Standard Line of the time domain and judge Good/NG in relation to the standard line. Select Template Table, Template Movement, Measurement Mode, Template Table Preparation, Load/Save of Mask Table, etc.

#9 Burst Avg Power: Measure the mean power of burst signals in the time domain. Select the start/end points.

SECTION 4 SOFT-KEY MENU

Menu Tree (11/28)

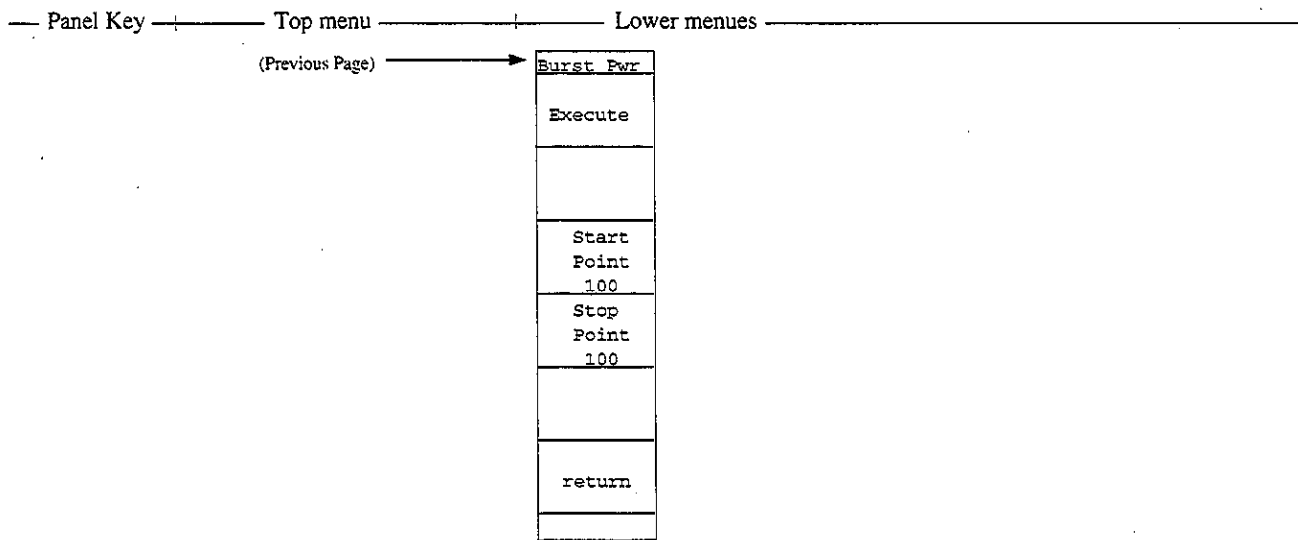

Menu Tree (12/28)

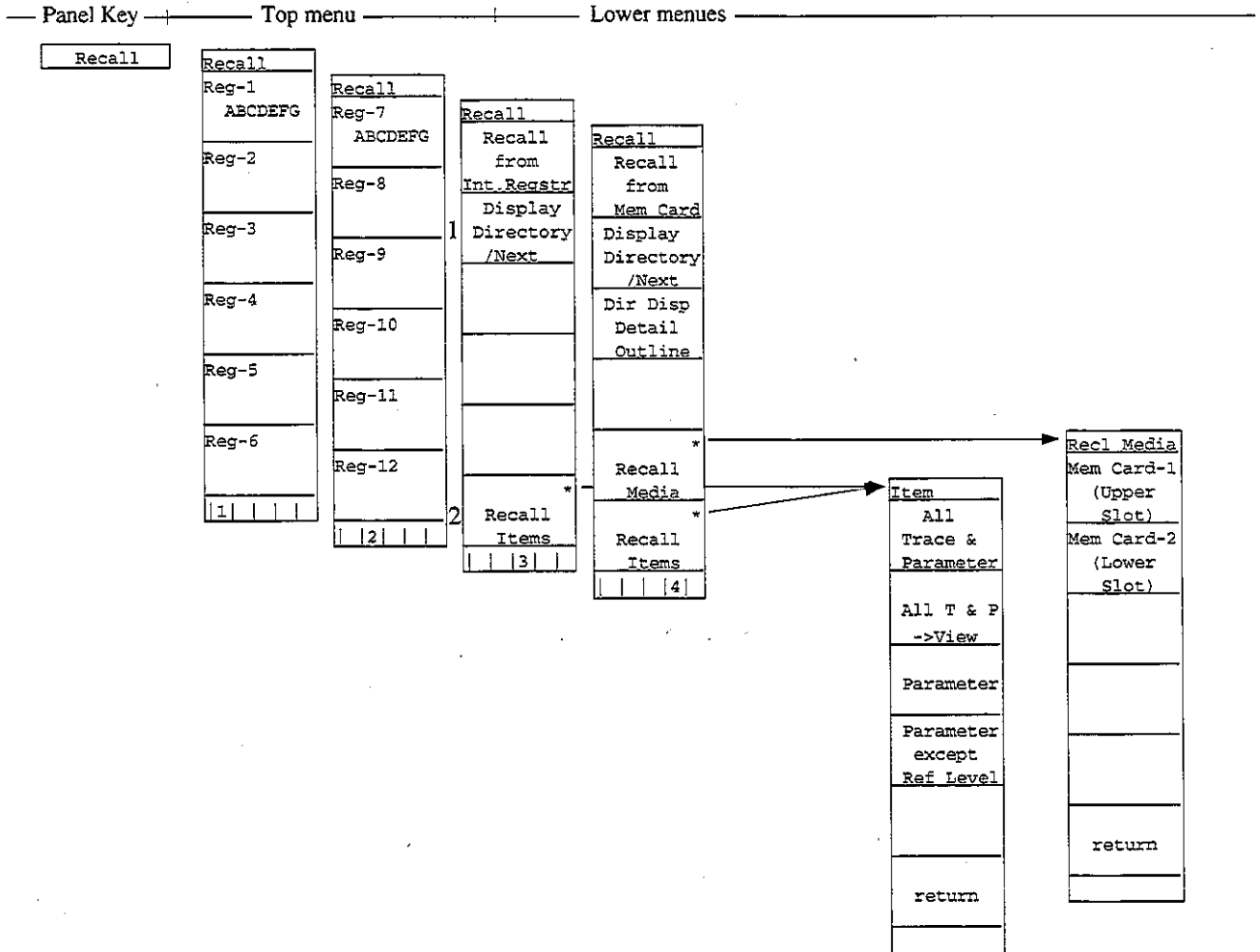

- Read out trace waveform/parameters from the internal memory or memory card. Select recall addresses and media/items, and display file directories.

#1 Displays list of internal-memory directories.

#2 Specifies items to be recalled
(trace waveform, parameter, etc.).

Menu Tree (14/28)

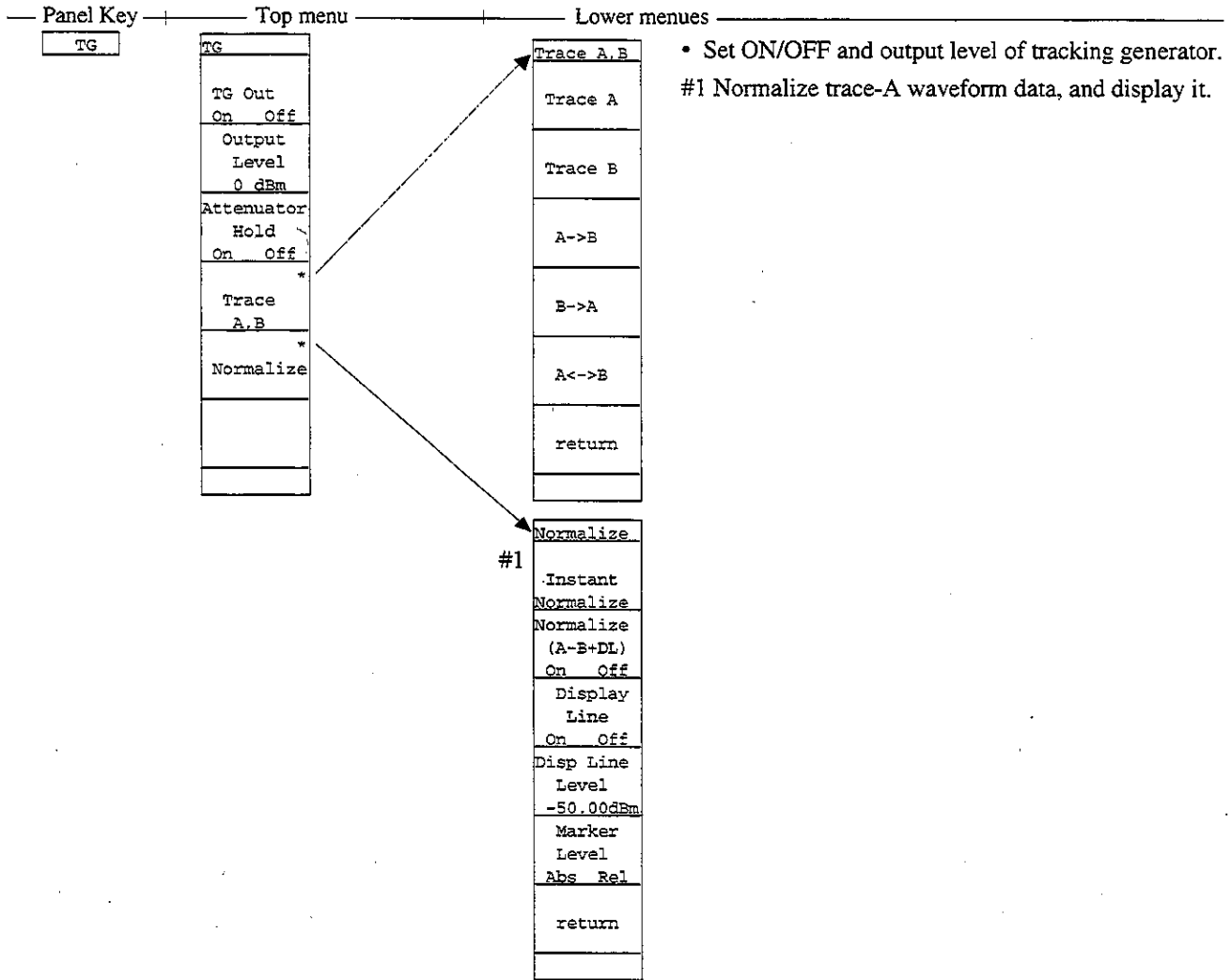

- Set ON/OFF and output level of tracking generator.
- #1 Normalize trace-A waveform data, and display it.

Menu Tree (15/28)

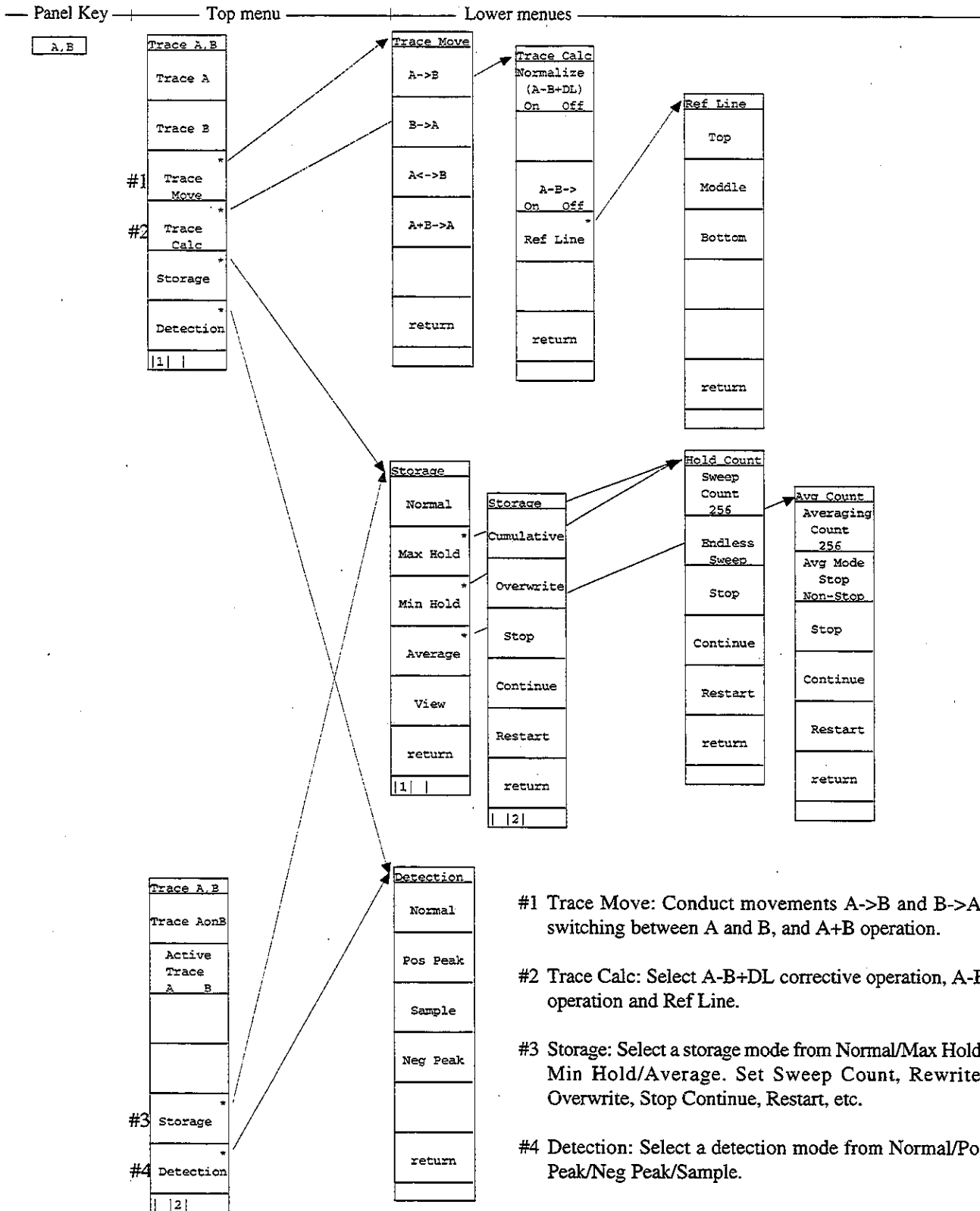

- Select Trace A/B, movement between Trace A/B, sum/difference operation between Trace A/B and Ref Line, and designate the storage and detection modes and Active Trace.

Menu Tree (16/28)

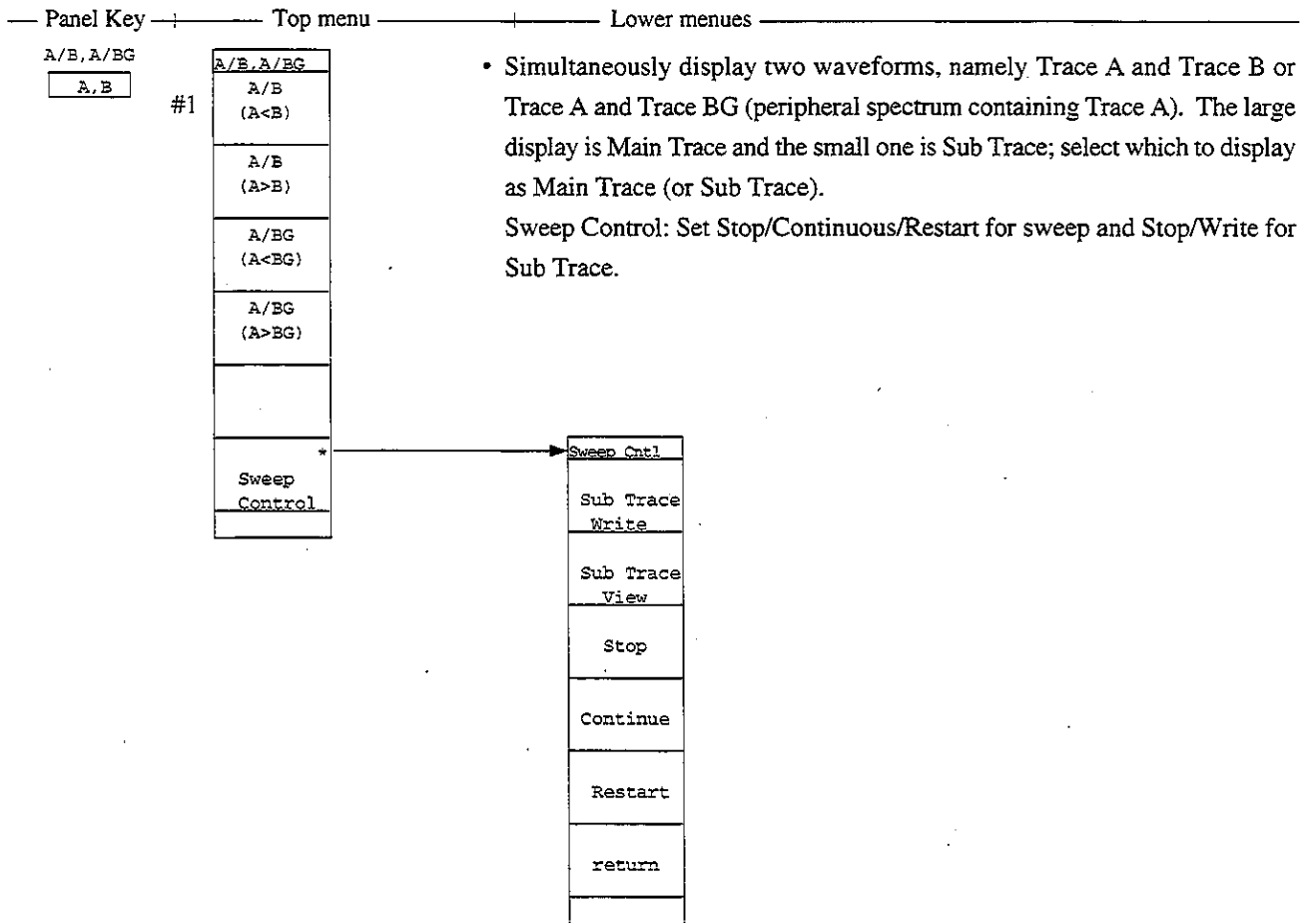

#1 Displays two traces A and B simultaneously at top and bottom of screen. The trace-B display is the larger at this time.

Menu Tree (17/28)

Panel Key | Top menu | Lower menus

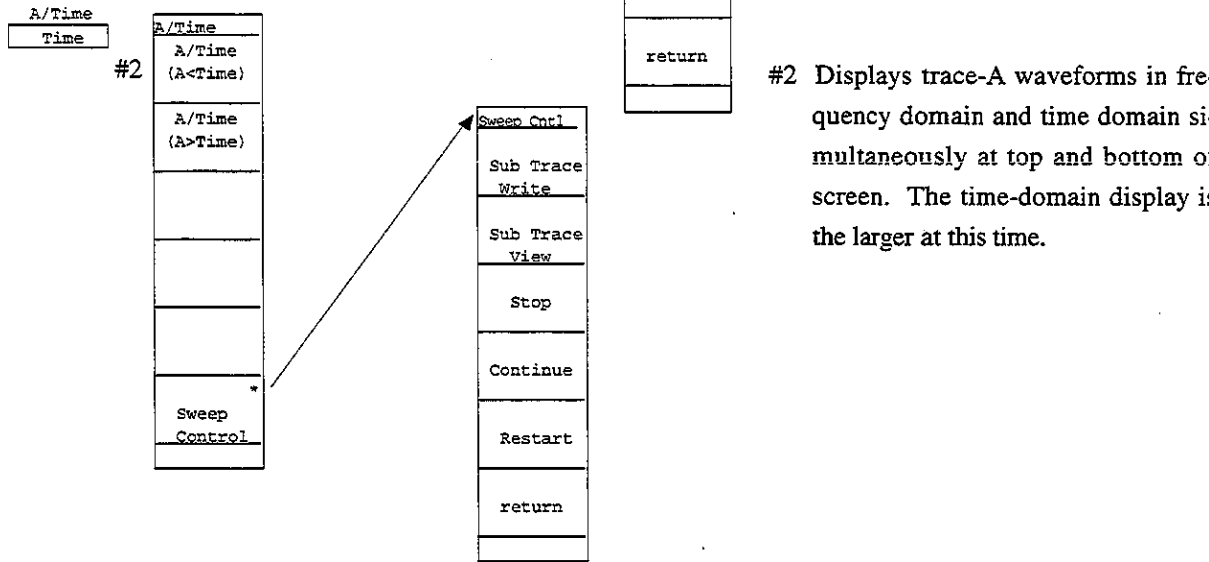
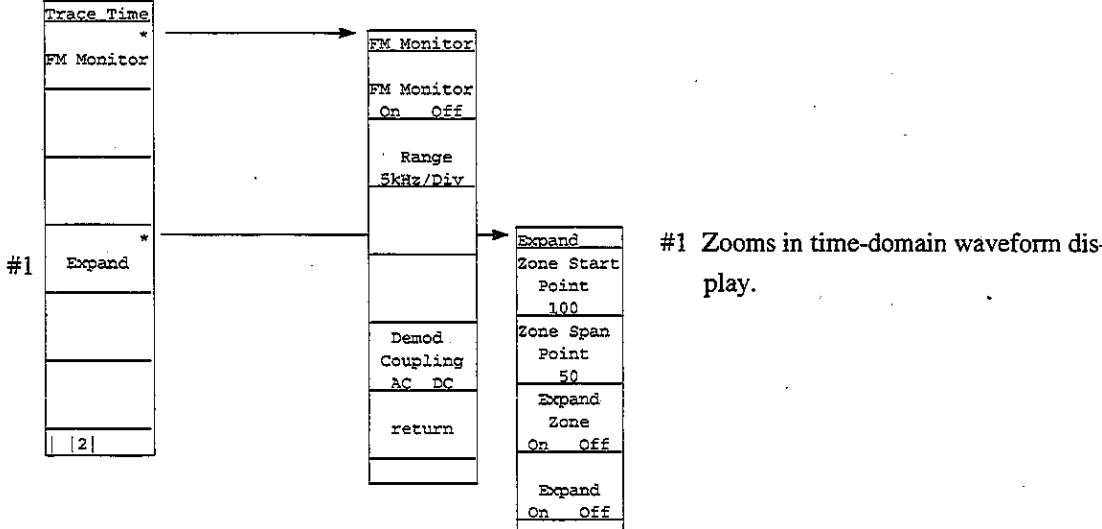
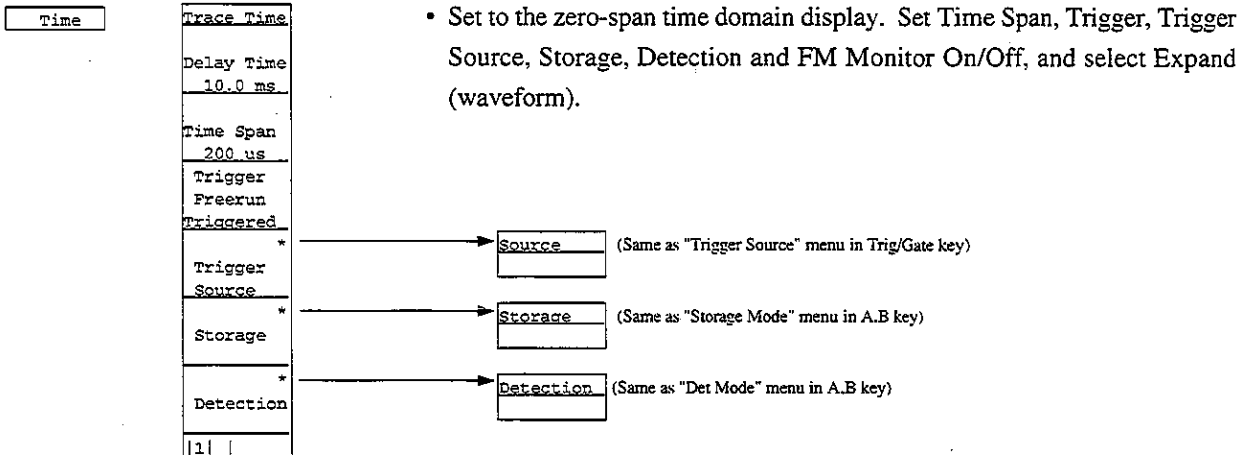

- Simultaneously display waveforms of Trace a and Time Domain. Which to display as Main Trace (or Sub Trace) can be selected.

Menu Tree (18/28)

Panel Key | Top menu | Lower menus

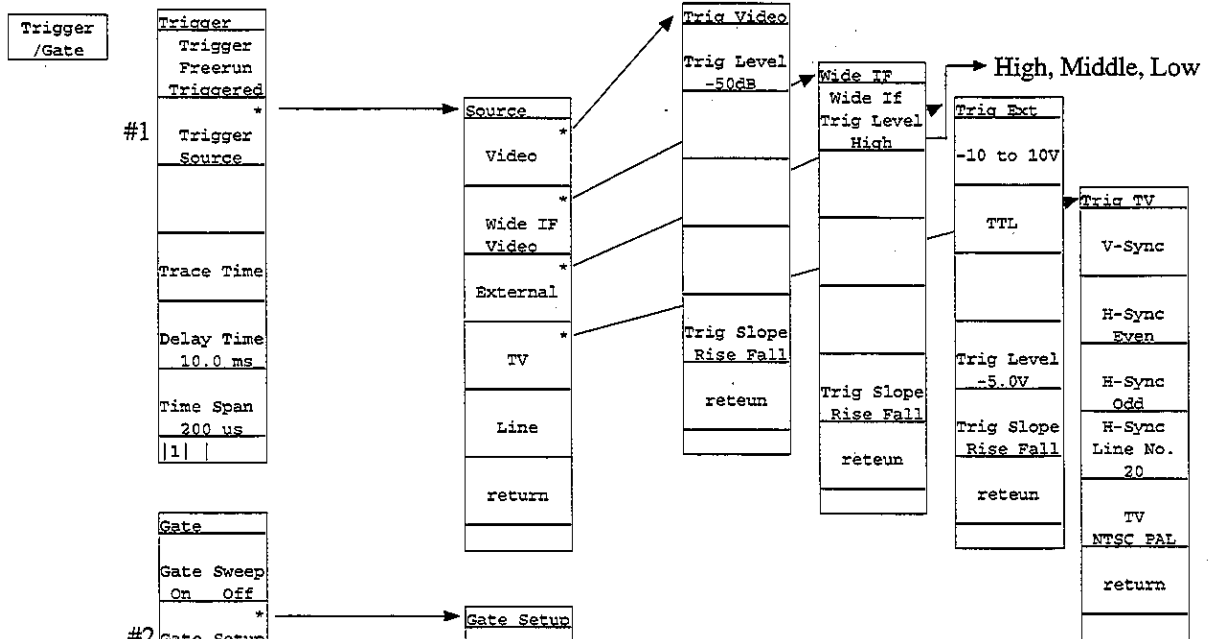

#1 Trigger Source: Select a trigger source from Video, Wide IF Video, External, TV and Line.

#2 Gate Setup : Set gate conditions including Gate Delay, Gate Length, Gate End and Gate Trig Source.

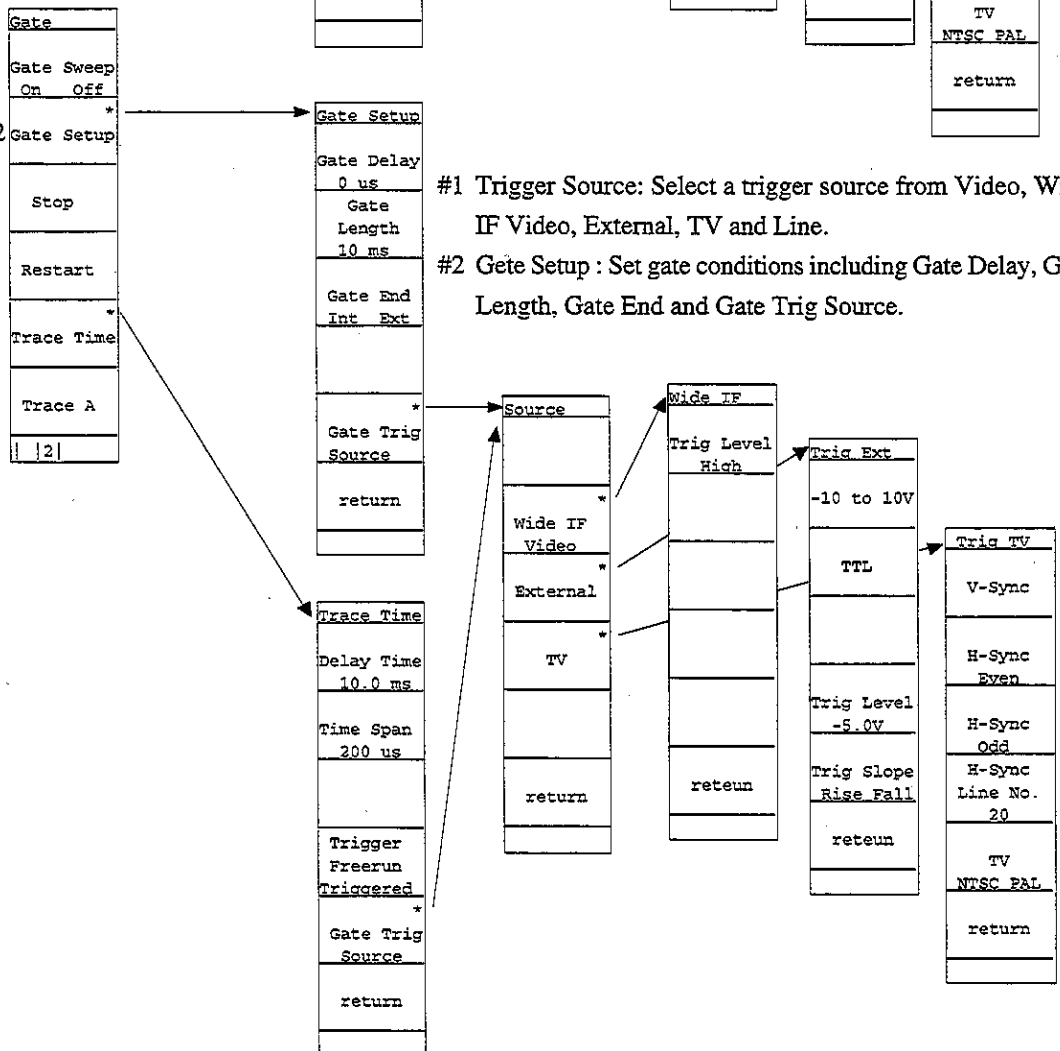

- Set gate functions for controlling the sweep start trigger and the writing of waveform data. Set the trigger mode, trigger source, trace time, delay time and time span. Select On/Off, Stop and Restart of Gate Sweep.

SECTION 4 SOFT-KEY MENU

Menu Tree (19/28)

Panel Key ——— Top menu ——— Lower menus

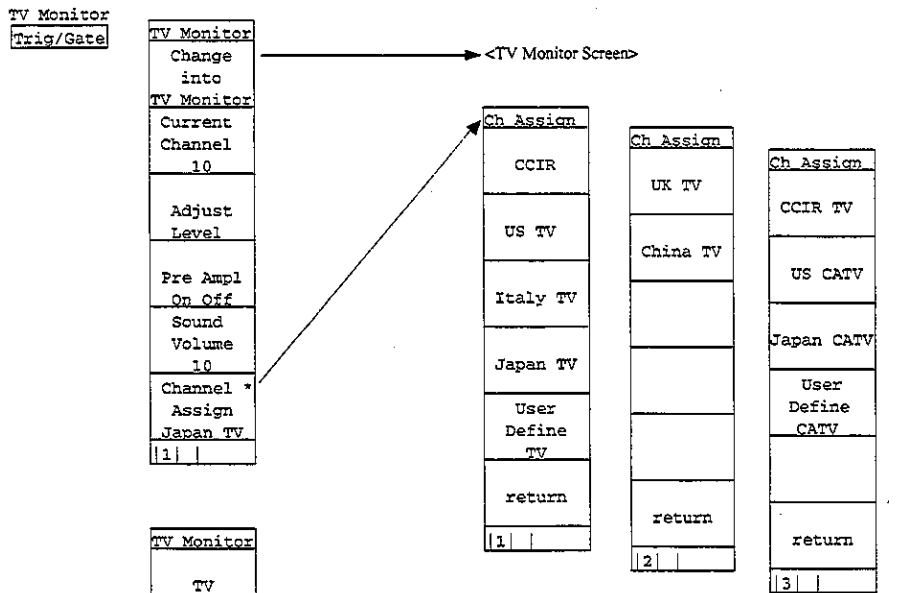

- Display the received TV image on the monitor screen. Select On/Off of Pre Ampl, TV system and Channel Assign.

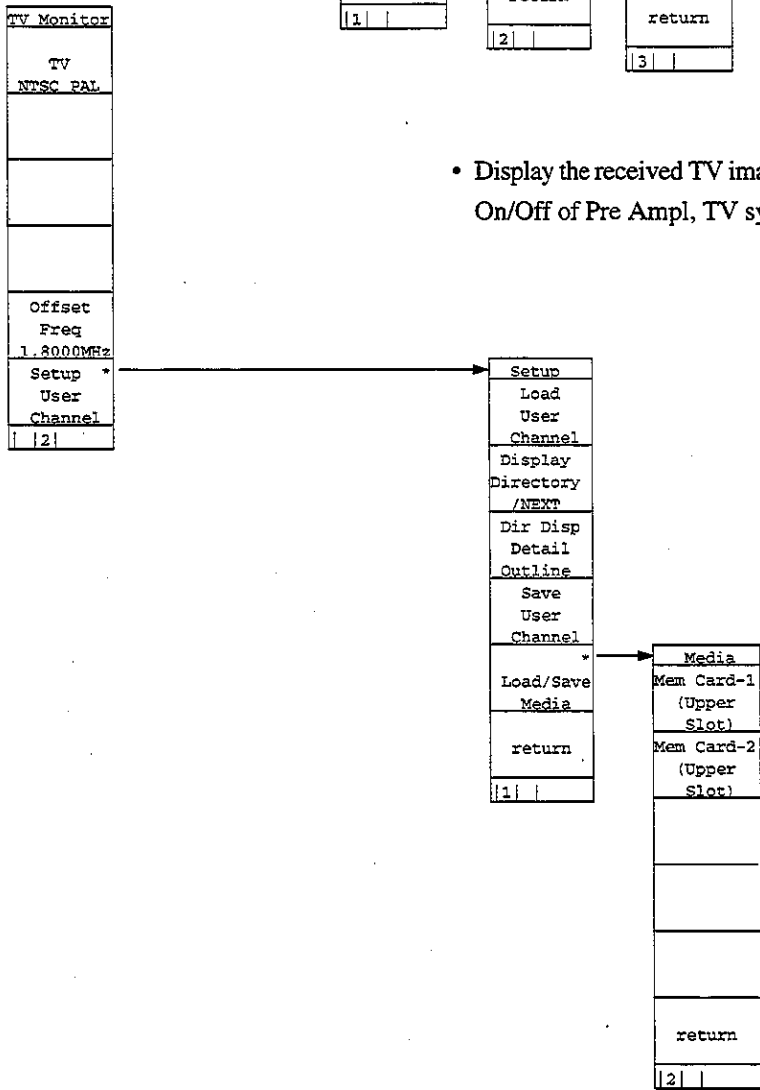

Menu Tree (20/28)

Panel Key ——— Top menu ——— Lower menus ———

Copy

Copy Cont
Copy

Copy Cont
Copy
Printer
Plotter
BMP file To Memcard
Paper Feed
Stop Print
Plot Rocation Reset
1

Printer
HP2225
VP-600 (ESC/P)
Magnify 1x2
Printer Address 18
return

Plotter
HP-GL GP-GL
Paper Size
Location
Item
Plotter Address 18
return

Paper Size
A4 A3
Full Size
Quarter Size
return

Location
Auto
[] []
[] []
[]
[]
[]
return

Item
All
Trace
Scale
return

Copy Cont
Printer Set up
Plotter Set up
BMP file Save Media
2

#1

- Set Printer/Plotter to hard-copy the screen. Set Printer/Plotter, Printer (model)/Plotter (model), Paper Feed, Stop Printer, Plot Location Reset, etc.

#1 Save the screen image data in memory card by BMP format(MS-DOS bit-map data format).

Save Media
Mem Card-1 (Upper slot)
Mem Card-2 (Lower slot)
return

Menu Tree (22/28)

Panel Key | Top menu | Lower menus

Cal

Cal
All Cal
Level Cal
Freq Cal
FM Cal
QP/EMC Cal
Pre-Selector Tuning
1

- Execute calibration. Select an item from All Cal, Level Cal, Freq Cal, and FM Demod Cal.

Cal
Freq Cal On Off
Cal status
Maintenance
2

Preslctr
Auto tune
Manual -5
Preset.
return

<Calibration status screen>

SECTION 4 SOFT-KEY MENU

Menu Tree (23/28)

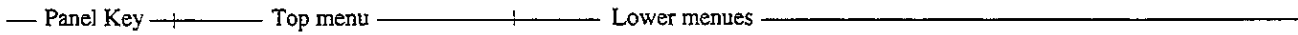

- Set interfaces for external devices to connect. Select RS232C, Centronics or GPIB, and set the RS232C interface, GPIB address, etc.

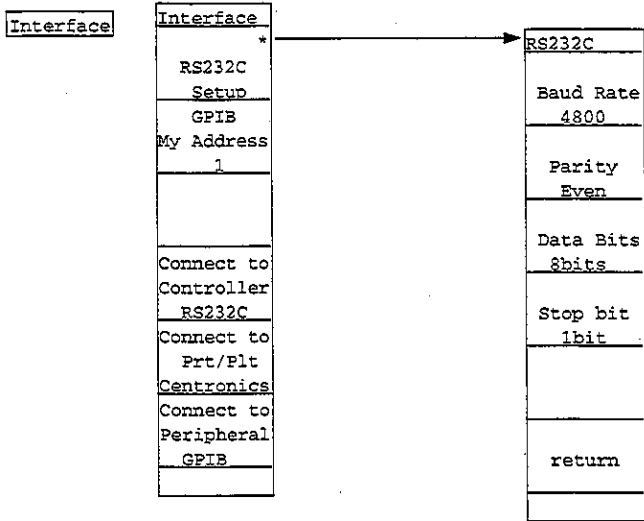

- Input a title to display on the screen.

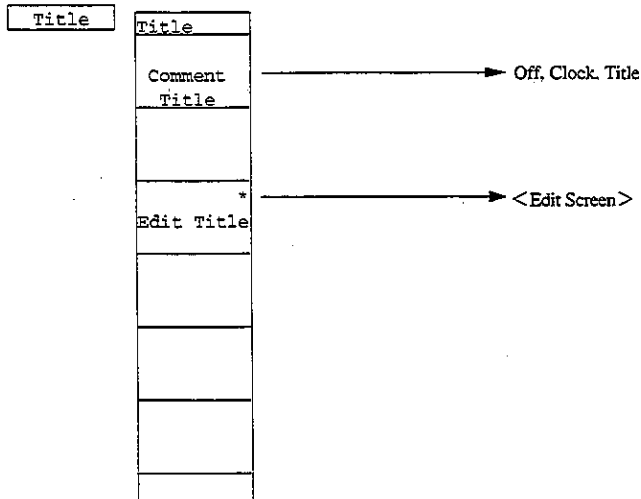

Menu Tree (25/28)

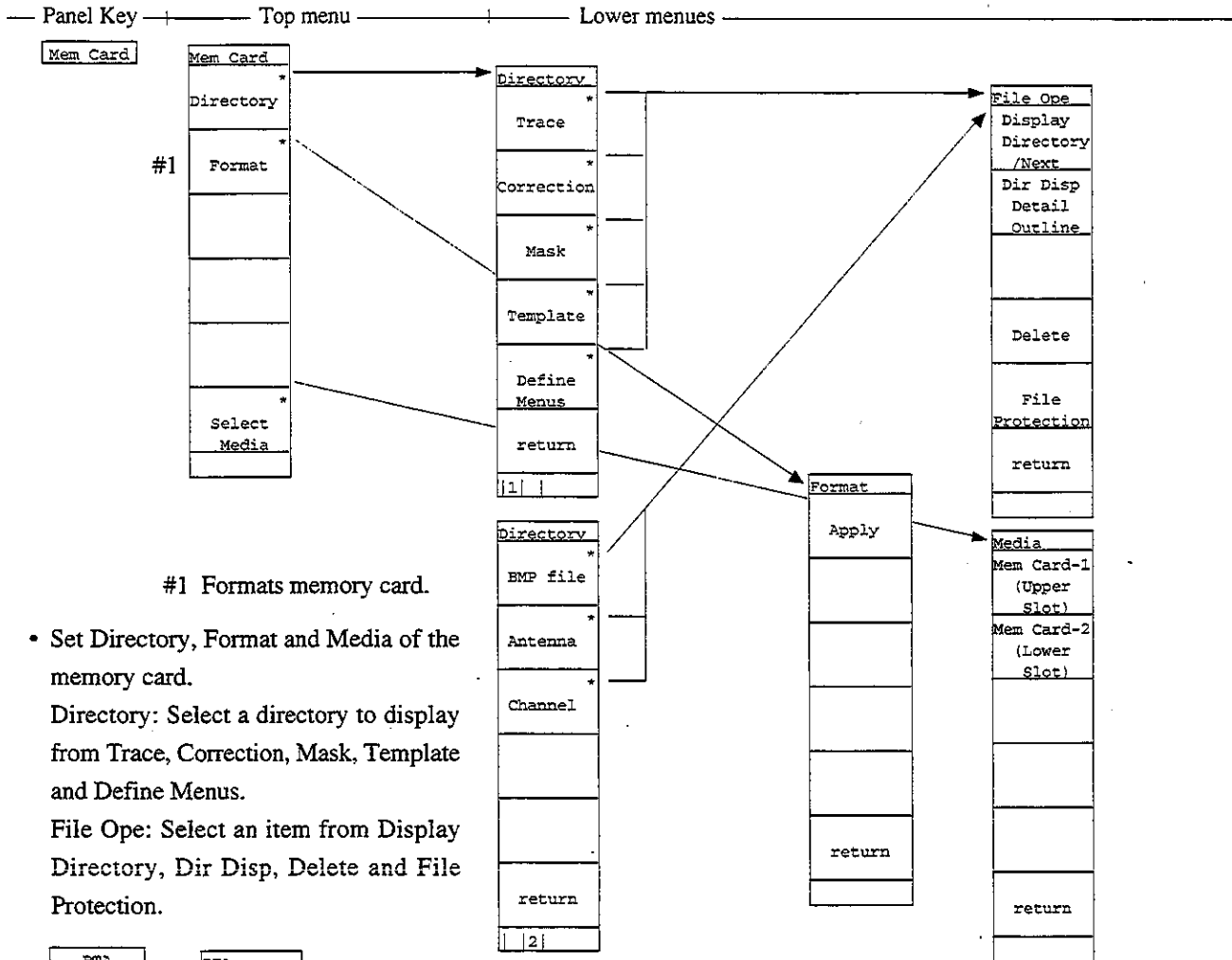

#1 Formats memory card.

- Set Directory, Format and Media of the memory card.

Directory: Select a directory to display from Trace, Correction, Mask, Template and Define Menus.

File Ope: Select an item from Display Directory, Dir Disp, Delete and File Protection.

(Next Page)

- Set PTA (personal test automation) that can build an auto measurement system without requiring external controllers.
 PTA Program: Select one from Run, Stop, Cont Reset, Prog List, Load, etc.
 PTA Library: Select one from Display/Run for the library program and Load/Check for the library file.

Menu Tree (26/28)

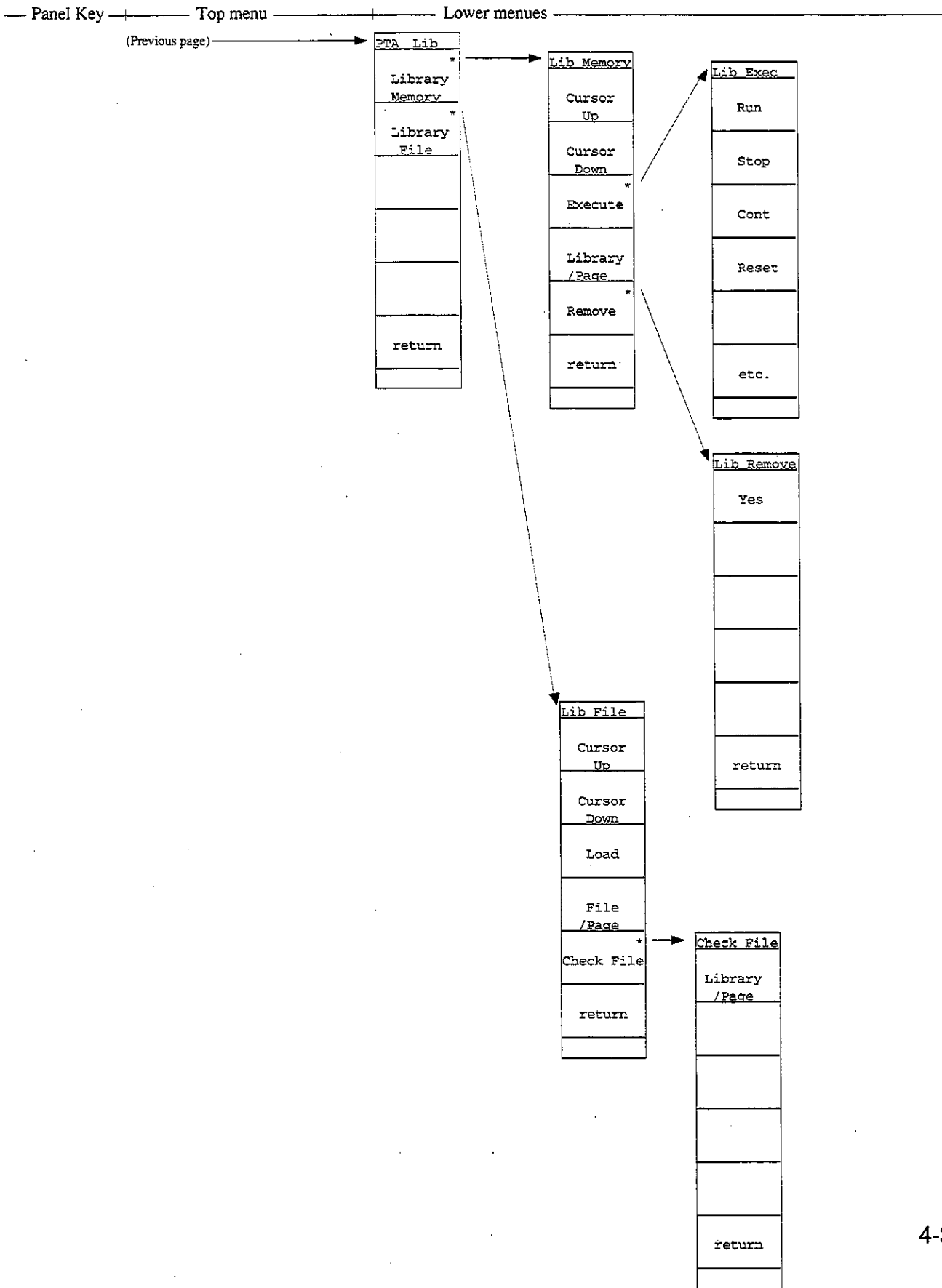

SECTION 4 SOFT-KEY MENU

Menu Tree (27/28)

Panel Key | Top menu | Lower menus

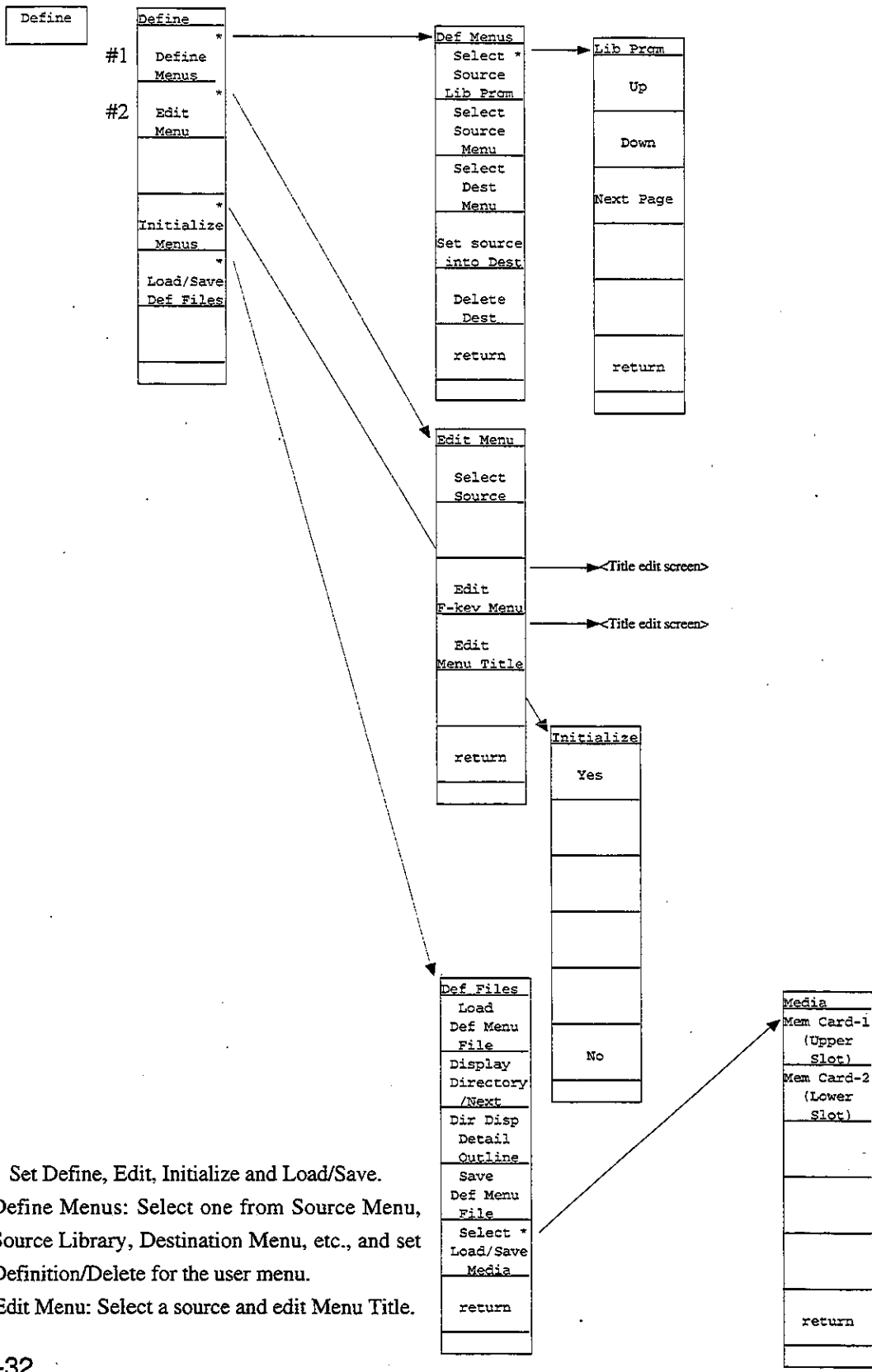

- Set Define, Edit, Initialize and Load/Save.
- #1 Define Menus: Select one from Source Menu, Source Library, Destination Menu, etc., and set Definition/Delete for the user menu.
- #2 Edit Menu: Select a source and edit Menu Title.

Menu Tree (28/28)

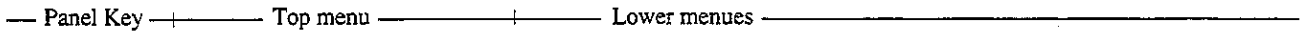

Preset

Preset
Preset All
Preset Sweep controll
Preset Trace Parameters
Preset Level Parameters
Preset Freq/Time Parameters

- Initialize measurement parameters. Select one from All, Sweep, Trace, Level and Freq/Time.

Hold

Local

SECTION 5
BASIC OPERATION PROCEDURE

TABLE OF CONTENTS

Signal Display	5-3
Turn the power on	5-3
Execute automatic calibration	5-4
Set the signal to the center of the screen	5-4
Enlarge and display the signal	5-5
Marker Operation	5-6
Check of the zone marker function	
The "marker → CF" function check	
"Measure" Function Check	5-8
Screen Hard Copy	5-9

SECTION 5 BASIC OPERATION PROCEDURE

The basic operation procedure of this equipment are explained here. The operations are listed on the right. Also, the explanation will advance assuming that a 500 MHz signal is applied to the input connector. Please read this manual while operating this equipment.

(: Panel key, : Soft key)

<Actual operations>

- (I) Signal display
 - 1) Turn the power on,
 - 2) execute automatic calibration,
 - 3) set the signal to the center of the screen, and
 - 4) enlarge and display the signal.
- (II) Marker operation
 - Check of the zone marker function.
 - The "marker → CF" function check.
- (III) "Measure" function check
- (IV) Screen hard copy

Signal Display

Turn the power on

Press the standby button on the rear panel, then press the power switch (0) on the front panel. In this case, continue pressing the power switch for one second or more.

Press Preset key.

Press Preset All key in the menu.

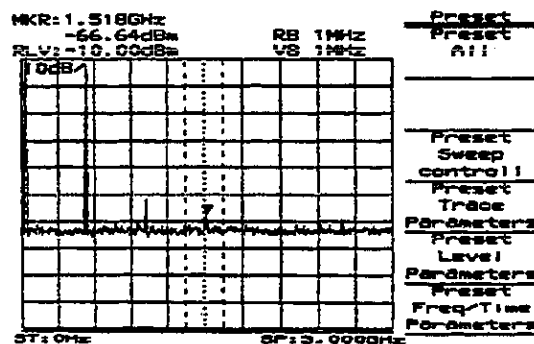

Fig. 5-1

The power is turned on/off only when the power switch is pressed for one second or more. This prevents the power from being turned on/off easily by mistake.

When panel key (hard key) is pressed, the related soft key menu is displayed.

Partial resettings are enabled. This resetting includes only the display-related resetting or the resetting of special modes such as zone sweep.

Execute automatic calibration

Wait after switching on the power supply of the machine (warm up period) till the internal temperature becomes stable. This period is approximately 10 minutes.

After warm up, execute automatic calibration.

Press **Shift** key then **CAL** key then **0** key.

Select All Cal from the menu displayed on the display.

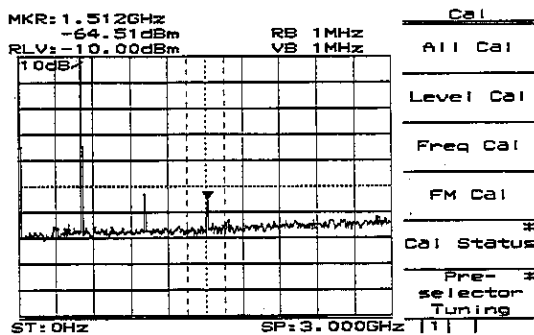

Automatic Calibration is carried out by using an internal source without need for any external cable connection. See "Detailed Operation Instructions" for detail information about contents of calibration.

Fig. 5-2

Set the signal to the center of the screen

Press **Frequency** key.

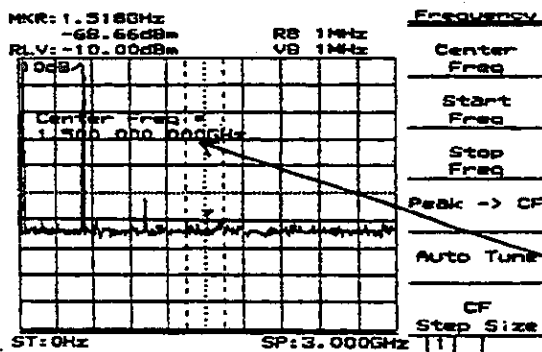

When pressing Frequency, Span, Amplitude or Coupled Function key(s) which is used frequently, Center Frequency, Span, Reference Level, RBW or VBW function is selected and numeric value for the function can be entered into Entry area. This reduce key operation times.

This display section is called Entry area. Selecting the menu displays the current set value of the parameter. The set value can be changed by entering data in Entry area.

Fig. 5-3

Press **Menu On/Off** key

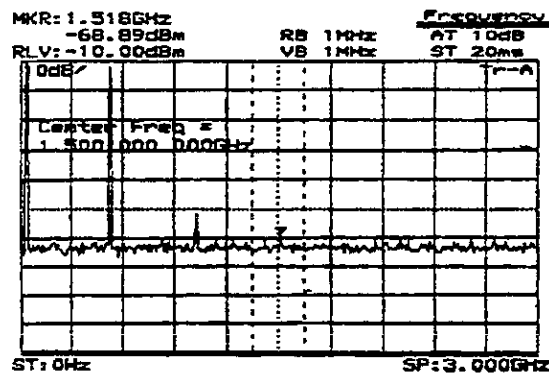

Fig. 5-4

The display of the soft key menu can be switched on/off using **Menu On/Off** key. When the menu disappears, the scale is enlarged. Also, when the menu is displayed, the scale is reduced.

Press **Menu On/Off** key to return to previous screen.

Use the ten-key pad (numeric keys) to enter 500 MHz.

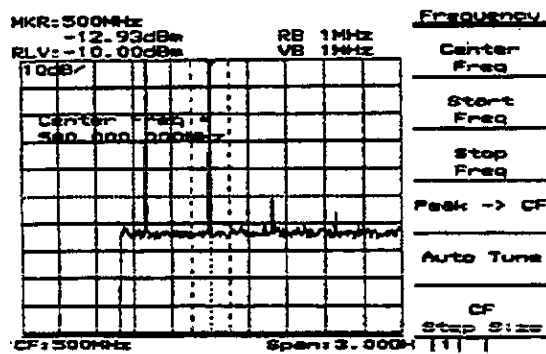

Fig. 5-5

The following three methods to input numeric values to parameters are provided: direct input by the ten-key pad (numeric keys), up/down keys, and rotary knob.

Enlarge and display the signal

Press **Span** key, then press the **V** down key several times to enlarge the signal display.

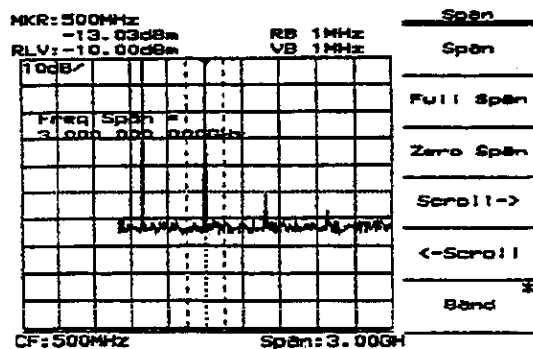

Fig. 5-6

Marker Operation

Here, checks that the signal frequency and level are displayed in a marker display area. The zone marker automatically fetches the highest level signal within the zone and displays the frequency and level.

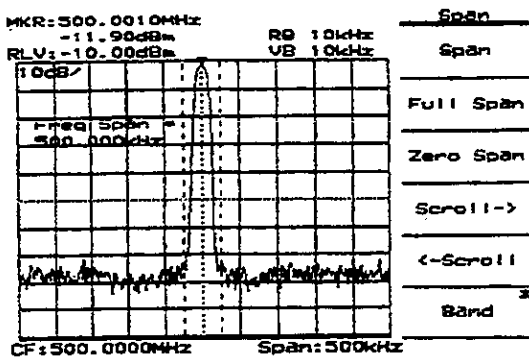

Fig. 5-7

To check Marker → CF function, shift the signal from the center intentionally.
 Press **Frequency** key and **More** key in order, and then **Scroll →** key two times.

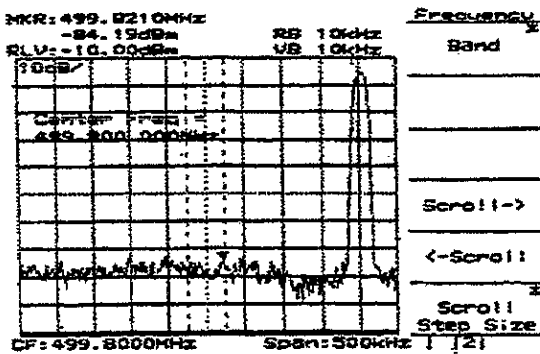

Fig. 5-8

The soft key menu marked by an asterisk on the upper right indicates that the menu can further be opened by pressing the key. Adversely, the soft key menu not marked indicates that the menu cannot be opened any more, so to speak, the end of menu opening.

The following items can easily be checked by the soft key menu tab: How many pages of the soft key menu being displayed currently are there?, and what page is displayed now?

To turn over the page, press **More** key.

Press **Marker** key.

Press **Peak Search** key.

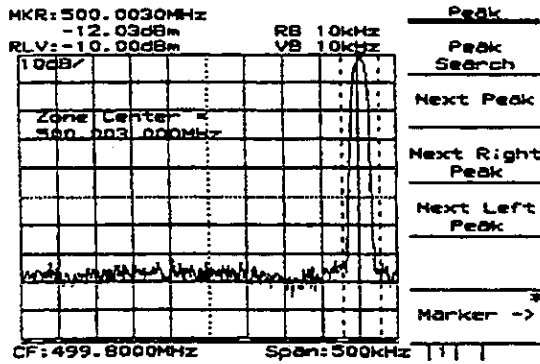

Fig. 5-9

*Advanced operation memo: It is convenient that the page can also be turned over by repeatedly pressing the panel key. This method is used when key(s), such as **Measure** key, has a number of pages. Besides, the Freq/Ampl and Marker-related keys do not turn over the page by repeatedly pressing the panel key. For these keys, because the first page is important specially, it should always be displayed when the panel key is pressed.

The marker fetches the signal.

Press **Marker ->** key.

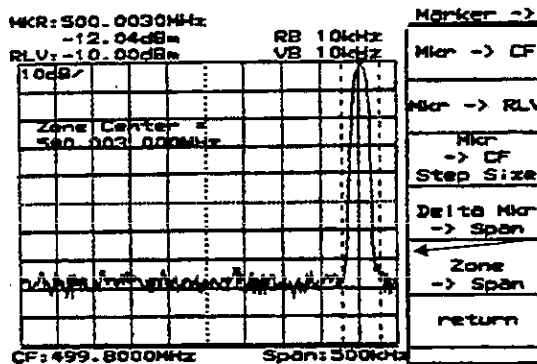

Fig. 5-10

When the soft key menu is pressed, a menu of function related to the menu is further displayed. In this case, as shown in the figure on the left, the thick line (the line on the preceding page) is displayed at the left of the soft key menu. This indicates that a new menu is overlapped with the preceding page.

Press **marker -> CF** key.

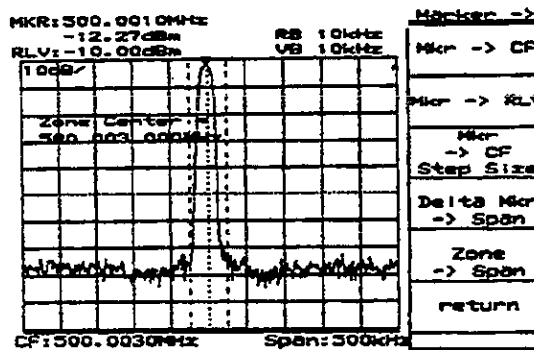

Fig. 5-11

The page opened by pressing the soft key can return to the preceding page by the **Return** key. Besides, it can be checked that which soft key menu was pressed previously to open the current menu, as the menu title is displayed on the upper row of the soft key.

Here, return to the screen of Fig. 5-8 and ensure that the screen changes to that of Fig. 5-11 only by pressing the **-> CF** key.

"Measure" Function Check

Press **Preset** key and Preset All Parameters key in order.

Press **Peak Search** key.

If the zero beat signal level (local feed though) is larger than the signal level and the marker fetches the zero beat level, press "Next peak" key and put the marker on the signal.

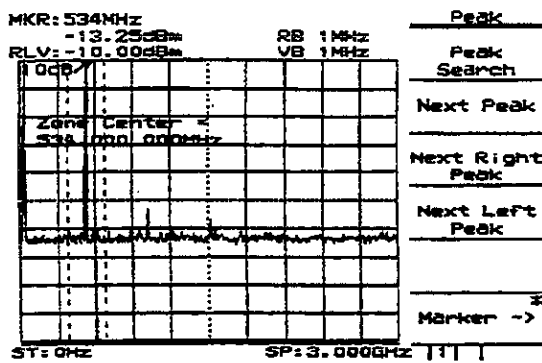

Fig. 5-12

Press the **Measure** key and Frequency Count key to set the function of high accuracy frequency measurement of the marker points.

Then, press the Count On key and start measurement.

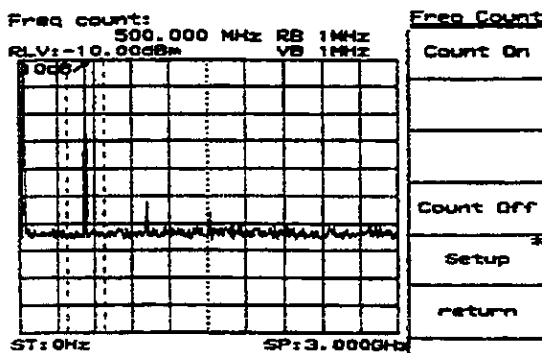

Fig. 5-13

The soft-key menu display can be switched On/Off by the **Menu On/Off** key. However, keys that condition setting is not possible unless a menu is On unconditionally make the soft-key menu display On when pressing a panel key.

From the screen after executing measurement, press another panel key and change parameters, and then, pressing again the **Measure** key will automatically return to the menu of this screen and not to page 1 of the menu (page learning function). It is a useful function when repeating measurement.

The frequency of marker points is displayed at the top left of the screen.

Incidentally, the internal counter correctly operates even at the full span condition, so an operation to reduce frequency span otherwise required is not necessary in this model.

Screen Hard Copy

The screen can be hard-copied with the VP-600 printer (Epson) via an RS232C interface, and the procedures are described below:

- 1) As illustrated below, connect the RS-232C connector and printer with an attached RS-232C cable.
- 2) Press the **Copy** key, and the currently displayed screen is hard-copied.
If the printed copy is improper, check if the RS-232C interface is correctly set in the following sequence.
- 3) Press the **Shift** key and then the **Interface** key.
- 4) Press the **Connect to Controller** key several times to get None on the display, and press the **Connect to Prt/Plt** key several times and get RS-232C on the display.
Now the printer can be operated with RS-232C.
- 5) Press the **RS232C Setup** key and set so that (or check if) the setting of RS-232C interface is the same between the main body and printer.
(For the setting/checking of the RS-232C interface on the printer side, refer to the instruction manual of the printer.)
- 6) Press the **Shift** key and then the **Copy Cont** key.
- 7) Press the **Printer/Plotter** key and select Printer.
- 8) Press the **Printer Setup** key, and then press the **VP-600** key.
- 9) Press the **Magnify** key several times and make the display 1×1 .
- 10) Press the **Copy** key, and the currently displayed screen is hard-copied.

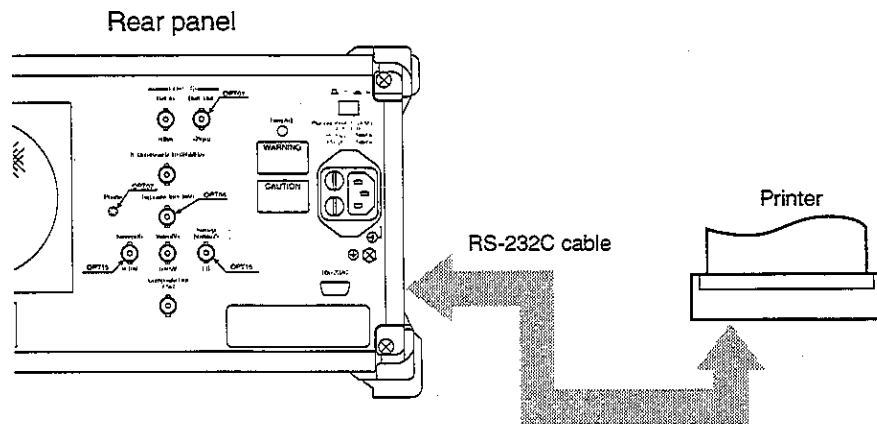

Fig. 5-14

SECTION 5 BASIC OPERATION PROCEDURE

SECTION 6

PERFORMANCE TESTS

In this chapter, measuring instruments, setup and operations necessary for conducting performance tests of MS2650/2660 series equipped with a reference oscillator (Option 01) are described. Note that with regard to performance tests of sideband noise level, mean noise level and second harmonic distortion, the standard of measured objects differ between MS2651A/MS2653A and MS2661A/2663A.

TABLE OF CONTENTS

Requirement for Performance Tests	6-3
Instruments Required for Performance Test	6-4
Performance Test	6-6
Reference oscillator frequency stability	6-6
Center frequency readout accuracy	6-8
Frequency span readout accuracy	6-11
Resolution bandwidth (RBW) and selectivity	6-14
Sideband noise	6-20
Frequency measurement accuracy	6-22
Amplitude display linearity	6-24
Frequency response	6-28
Reference level accuracy	6-31
Average noise level	6-34
Second harmonic distortion	6-37
Resolution bandwidth (RBW) switching error	6-40
Input attenuator switching error	6-43
Sweep time and time span accuracy	6-46
Tracking generator output level accuracy	6-50
Service	6-53

SECTION 6 PERFORMANCE TESTS

Requirement for Performance Tests

Performance tests are used as preventive maintenance to prevent degradation of the MS2650/MS2660 series performance before it occurs.

Use the performance tests whenever necessary such as at acceptance and periodic inspection of the MS2650/MS2660 series and to verify performance after repair. Execute the performance tests listed below to verify the MS2650/MS2660 series performance at acceptance inspection, periodic inspection and after repair.

- Reference oscillator frequency stability
- Center frequency display accuracy
- Frequency span display accuracy
- Resolution bandwidth and selectivity
- Sideband noise level
- Frequency measurement accuracy
- Amplitude display linearity
- Frequency response
- Reference level accuracy
- Average noise level
- Second harmonic distortion
- Resolution bandwidth (RBW) switching error
- Input attenuator switching error
- Sweep time and time span accuracy
- TG output level

Execute the performance tests at regular intervals as preventive maintenance for important evaluation items. We recommend that the performance be inspected regularly once or twice a year.

If the specifications are not met at the performance tests, please contact Anritsu Corporation.

Instruments Required for Performance Test

A list of instruments required for performance test is shown below.

Instruments Required for Performance Test (1/2)

Recommended instrument name (Model name)	Required Performance †	Test item
Synthesized signal generator (MG3633A)	<ul style="list-style-type: none"> • Frequency range 100 MHz to 1 GHz Resolution of 1 Hz possible • Output level range - 20 to 0 dBm Resolution of 0.1 dB possible • SSB phase noise ≤ 130 dBc / Hz (at 10 kHz offset) • Second harmonic ≤ 30 dBc • Amplitude modulation (0% to 100%, 0.1 to 400 Hz) possible • External reference input (10 MHz) possible 	Frequency-span display accuracy Resolution bandwidth, selectivity Sideband noise Amplitude display linearity Reference-level accuracy Second-harmonic distortion Resolution-bandwidth switching error Input-attenuator switching error Sweep-time and time-span accuracy
Swept Frequency Synthesizer (WILTRON 6769B with Option 2C)	<ul style="list-style-type: none"> • Frequency range 10 MHz to 8.1 GHz Resolution of 2 kHz possible • Output level range - 20 to 0 dBm Resolution of 0.1 dB possible • Pulse modulation possible Pulse width: 0.5 to 10 μ sec Repetitive cycle: 5 μ sec to 5 msec • External reference input (10 MHz) possible 	Center-frequency display accuracy Frequency-span display accuracy Frequency measurement accuracy Frequency response Time-span accuracy
Attenuator (MN510C)	<ul style="list-style-type: none"> • Frequency 100 MHz • Maximum attenuation 70 dB (resolution 0.1 dB) possible with calibrated data 	Amplitude display linearity Input-attenuator switching error

† Extracts part of performance which can cover the measurement range of the test item.

Instruments Required for Performance Test (2/2)

Recommended instrument name (Model name)	Required Performance †	Test item
Power meter (ML4803A)	<ul style="list-style-type: none"> • Main instrument accuracy ± 0.02 dB • Frequency range 100 kHz to 3 GHz (depending on the power sensor type) 	Frequency response Reference-level accuracy Input-attenuator switching error TG output level
Power sensor (MA4601A)	<ul style="list-style-type: none"> • Frequency range 100 kHz to 2 GHz • Measurement power range -30 to $+10$ dBm • Input connector N type 	Frequency response Reference-level accuracy Input-attenuator switching error TG output level
Power sensor (MA4701A)	<ul style="list-style-type: none"> • Frequency range 10 MHz to 8.1 GHz • Measurement power range -30 to $+10$ dBm • Input connector N type 	TG output level
Power Sensor (MA4602A)	<ul style="list-style-type: none"> • Frequency range 100 kHz to 3 GHz • Measurement power range -60 to -30 dBm • Input connector N type 	
50 Ω terminator (MP752A)	<ul style="list-style-type: none"> • Frequency range DC to 8.5 GHz • VSWR ≤ 1.2 	Average noise level
50 Ω terminator WILTRON (28KF50)	<ul style="list-style-type: none"> • Frequency range DC to 8.1 GHz • VSWR ≤ 1.15 	
Low-pass filter (M-238C) (SAGE L20CA072)	<ul style="list-style-type: none"> • Attenuation ≥ 70 dB (at frequency: $2 \times$ (10 MHz and 1 GHz)) 	Second-harmonic distortion
Frequency counter (MF1601A)	10 MHz measurement possible Number of display digits: 10 <ul style="list-style-type: none"> • External reference input (10 MHz) possible 	Reference-oscillator frequency stability
Frequency standard	<ul style="list-style-type: none"> • Frequency 10 MHz • Stability $\leq 1 \times 10^{-9}$/day 	Reference-oscillator frequency stability

† Extracts part of performance which can cover the measurement range of the test item.

Performance Test

The warm-up time depends on the test item. For test item other than oscillator frequency, warm-up the equipment for at least for thirty minutes and test the performance after the MS2650/MS2660 series stabilizes completely. Also, begin measurement after taking the warm-up time of the calibration instrument into full consideration. In addition, the test must be conducted at room temperature; there must be little AC power supply voltage fluctuation, and no noise, vibration, dust, humidity, etc.

Reference oscillator frequency stability

The optional 10 MHz reference oscillator (Option 01) is tested for frequency stability. Stability is determined by measuring frequency variation after 24 hours and after 48 hours of power on at ambient temperatures of 0°C and 50°C.

If a device is not to mount Option 01, this test is not available since there is no 10 MHz reference buffer output.

(1) Specifications (Option 01)

■ Reference oscillator

- Frequency: 10 MHz
- Aging rate: $\leq \pm 2 \times 10^{-8}$ /day
After 24 hour warm-up at $25^{\circ}\text{C} \pm 5^{\circ}\text{C}$
- Temperature stability: $\leq \pm 5 \times 10^{-8}$ at 0 and 50°C referred to frequency at 25°C

(2) Test instruments

- Frequency counter: MF1601A
- Frequency standard: with stability of $\leq \pm 1 \times 10^{-9}$ /day

(3) Setup

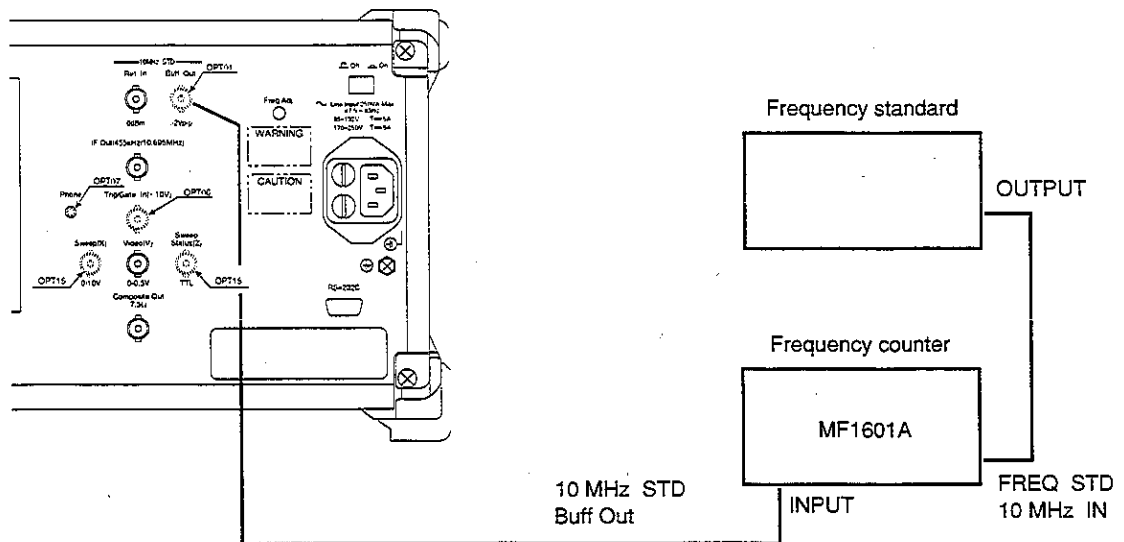
**Reference Oscillator Frequency Stability Test**

(4) Procedure

Aging rate / day: Test this at the ambient temperature $\pm 2^{\circ}\text{C}$ in a vibration-free place.

Step	Procedure
1	Set the change over switch (FREQ STD: INT / EXT) on the MF1601A counter rear panel to EXT.
2	Set the power supply switch on the spectrum analyzer rear panel to On and then the Power switch on the spectrum analyzer front panel to On.
3	Measure the frequency using the counter with 0.1 Hz resolution after 24 hours have passed after turning the power ON.
4	Measure the frequency using the counter after 24 more hours have passed from the step 3 measurement.
5	Calculate the stability by using the following equation.
	$\text{Frequency stability} = \frac{(\text{2nd reading of the counter}) - (\text{1st reading of the counter})}{(\text{1st reading of the counter})}$

Temperature stability: Test this performance in a vibration-free constant-temperature chamber.

Step	Procedure
1	Set up the spectrum analyzer in a constant-temperature chamber at 25°C in the same setup.
2	Set the LINE and Power switches on the spectrum analyzer to On and wait until the spectrum analyzer internal temperature stabilizes (approx. 1.5 hours after the chamber temperature stabilizes).
3	When the internal temperature stabilizes, measure the frequency by using the counter with 0.1 Hz resolution.
4	Change the chamber temperature to 50°C.
5	When the chamber temperature and the spectrum analyzer internal temperature re-stabilize, measure the frequency by using the counter.
6	Calculate the stability by using the following equation. $\text{Frequency stability} = \frac{(\text{counter reading at } 50^{\circ}\text{C}) - (\text{counter reading at } 25^{\circ}\text{C})}{(\text{counter reading at } 25^{\circ}\text{C})}$
7	Change the chamber temperature to 0°C and repeat steps 5 and 6.

Center frequency readout accuracy

Add the known frequency which serves as the center frequency reference to the spectrum analyzer as shown in the figure below and set CF (same value as the known reference frequency) and SPAN. At this time, check that the difference between the reading of the marker readout frequency (thick arrow in the figure) of the center frequency peak point, and the CF set value is $\leq \pm (\text{span} \times \text{span accuracy} + 100 \text{ Hz})$.

As shown in the figure, the Synthesized Signal Generator uses the signal source phase-locked with the same accuracy as the 10 MHz reference oscillator of the spectrum analyzer.

(1) Specifications

- Center frequency accuracy: $\pm (\text{Indicated frequency} \times \text{reference frequency accuracy} + \text{span} \times \text{span accuracy} + 100 \text{ Hz})$; * Span $\geq 10 \text{ kHz}$ (after calibration)

(2) Test instruments

- Synthesized signal generator: Wiltron 6769A

(3) Setup

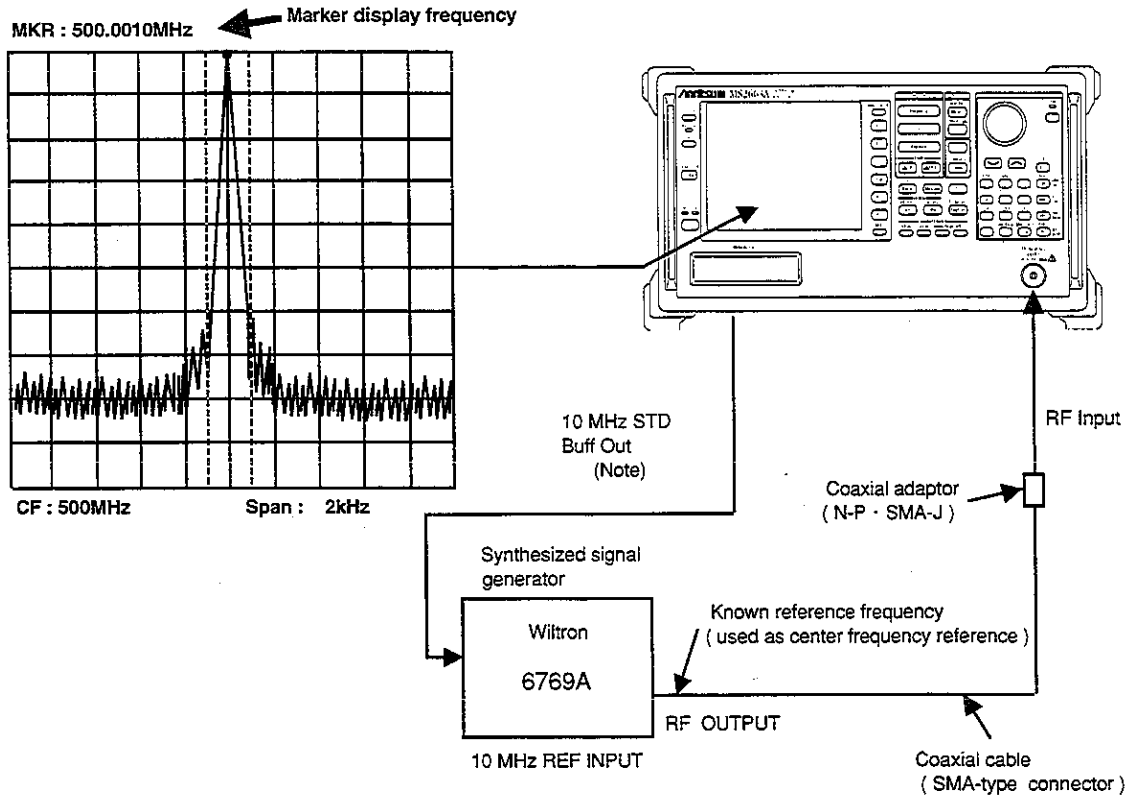

Center-Frequency Readout-Accuracy Test

(Note) If there is no buffer output for the reference oscillator (Option 01) on the rear panel, input a reference signal from an external 10 MHz frequency standard to the main body and signal generator, as shown below.

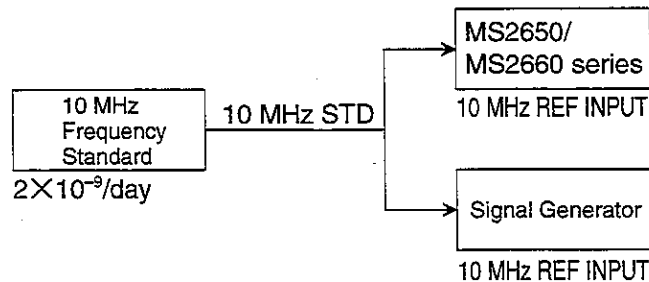

(4) Precautions

Set the signal generator output level to approx - 10 to - 20 dBm.

(5) Procedure

Step	Procedure
1	Press the spectrum analyzer [Preset] key.
2	Operate Freq Cal.
3	Set the signal generator output frequency equal to the center frequency (500 MHz) in the following table.
4	Set the spectrum analyzer to the center frequency in the following table.
5	Set the span (10 kHz) that corresponds to the center frequency (500 MHz) in the table by using the numeric/unit keys.
6	Read the marker frequency (indicated by thick arrow in the figure on the previous page) and check that the value is within the range between the maximum and minimum values shown in the following table.
7	Repeat steps 3 to 6 for other combination of the center frequency and span according to the combinations shown in the following table.

Center frequency display accuracy test

• MS2651A/2661A

Signal generator	Center frequency	Span frequency	Center frequency		
			Minimum value	Maker value	Maximam value
500 MHz	500 MHz	10 kHz	499.999 65		500.000 35
		200 kHz	499.994 90		500.005 10
		100 MHz	497.499 90		502.500 10

• MS2653A/2663A

Signal generator	Center frequency	Span frequency	Band	Center frequency		
				Minimum value	Maker value	Maximam value
500 MHz	500 MHz	10 kHz	0 (1)	499.999 65 MHz		500.000 35 MHz
		200 kHz		499.994 90 MHz		500.005 10 MHz
		100 MHz		497.499 90 MHz		502.500 10 MHz
5 GHz	5 GHz	10 kHz	1 ⁻ (1)	4.999 999 65 GHz		5.000 000 35 GHz
		200 kHz		4.999 994 90 GHz		5.000 005 10 GHz
		100 MHz		4.997 499 90 GHz		5.002 500 10 GHz
500MHz	500MHz	10 kHz	1 ⁺ (1)	7.499 999 65 GHz		7.500 000 35 GHz
		200 kHz		7.499 994 90 GHz		7.500005 10 GHz
		100 MHz		7.497 499 90 GHz		7.502 500 10 GHz

Frequency span readout accuracy

Using the setup shown in the figure below, set the frequencies corresponding the 1st and 9th division from the left side of the screen scale with the SG. The frequency difference between the peak levels at the 1st and 9th divisions is equal to the frequency span $\times 0.8$.

(1) Specifications

- Frequency span accuracy: $\pm 2.5\%$ (span ≥ 10 kHz)

(2) Test instrument

- Synthesized signal generator: MG3633A
Wiltron 6769A

(3) Setup

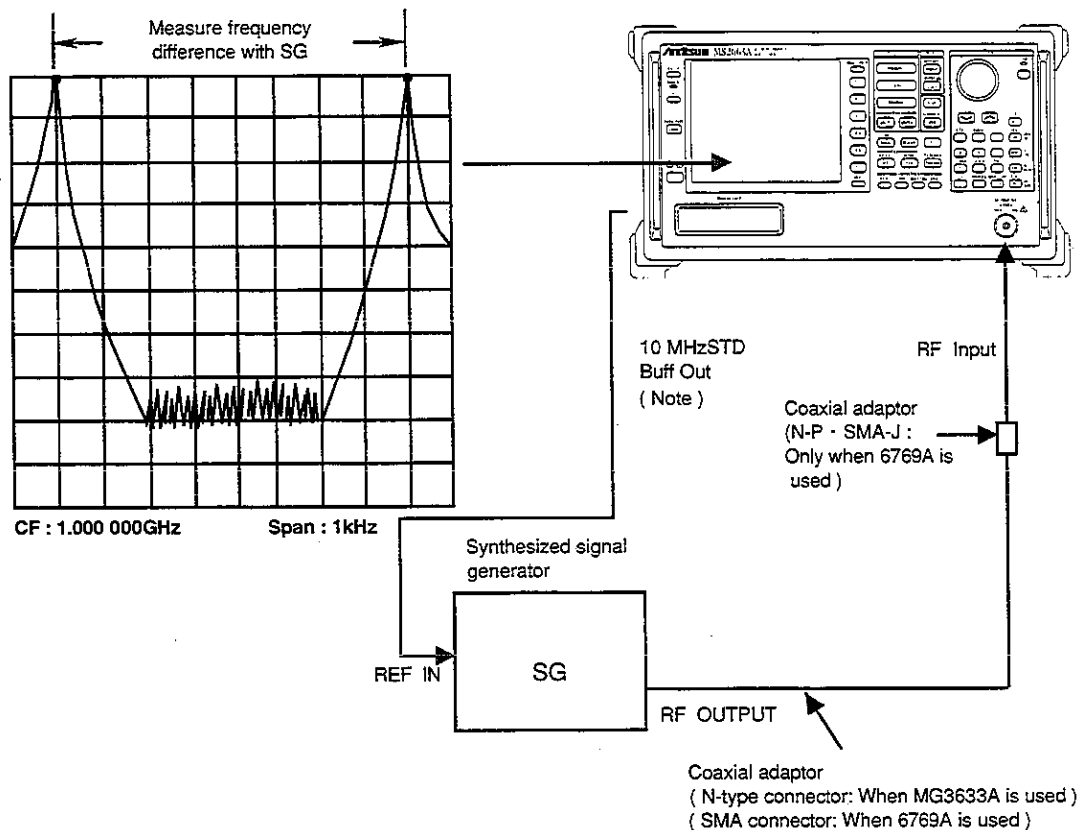

Frequency Readout Accuracy Test

(Note) If there is no buffer output for the reference oscillator (Option 01) on the rear panel, input a reference signal from an external 10 MHz frequency standard to the main body and signal generator.

(4) Precautions

Set the signal generator output level to approx. 0 to - 10 dBm.

(5) Procedure

Step	Procedure
1	Press the [Preset] key.
2	Operate Freq Cal.
3	Connect the MG3633A output to the spectrum analyzer RF Input.
4	Set the spectrum analyzer as shown below: Span 20 kHz Center Freq 1000 MHz
5	Set the MG3633A output frequency to the f_1 frequency (999.992 MHz) shown in the table on the next page.
6	Adjust the MG3633A output frequency to set the spectrum peak at the 1st division from the left end of the screen scale. Remember the frequency as f_1' .
7	After setting the MG3633A output frequency to the f_2 frequency (1000.008 MHz), adjust it to set the spectrum peak at the 9th division. Remember the frequency as f_2' .
8	Calculate $(f_2' - f_1') / 0.8$ and check that the value is within the specified range (minimum to maximum values) shown in the table on the next page.
9	Repeat steps 4 through 8 for each frequency span with 1 GHz center frequency shown in the table on the next page.

Frequency-Span Readout-Accuracy Test

MS2651A/MS2661A		Signal generator				
Center frequency	Span	f_1	f_2	Minimum value	$\frac{f_2' - f_1'}{0.8}$	Maximum value
1 GHz	20 kHz	0.999 99 2 GHz	1.000 008 GHz	19.5 kHz		20.5 kHz
	200 kHz	0.999 92 GHz	1.000 08 GHz	195 kHz		205 kHz
	2 MHz	0.999 2 GHz	1.000 8 GHz	1.95 MHz		2.05 MHz
	10 MHz	0.996 GHz	1.004 GHz	9.75 MHz		10.25 MHz
	100 MHz	0.96 GHz	1.04 GHz	97.5 MHz		102.5 MHz
	2 GHz	0.2 GHz	1.8 GHz	1.95 GHz		2.05 GHz

MS2653A/MS2663A		Signal generator				
Center frequency	Span	f_1	f_2	Minimum value	$\frac{f_2' - f_1'}{0.8}$	Maximum value
1 GHz	20 kHz	0.999 99 2 GHz	1.000 008 GHz	19.5 kHz		20.5 kHz
	200 kHz	0.999 92 GHz	1.000 08 GHz	195 kHz		205 kHz
	2 MHz	0.999 2 GHz	1.000 8 GHz	1.95 MHz		2.05 MHz
	10 MHz	0.996 GHz	1.004 GHz	9.75 MHz		10.25 MHz
	100 MHz	0.96 GHz	1.04 GHz	97.5 MHz		102.5 MHz
	2 GHz	0.2 GHz	1.8 GHz	1.95 GHz		2.05 GHz
4.25 GHz	100 kHz	4.21 GHz	4.29 GHz	97.5 MHz		102.5 MHz
	1 MHz	3.85 GHz	4.65 GHz	0.975 GHz		1.025 GHz
	8.5 MHz	0.85 GHz	7.65 GHz	8.2875 GHz		8.7125 GHz

Resolution bandwidth (RBW) and selectivity

If there are two input signals with the frequency difference corresponding to 3 dB bandwidth (of IF final stage), these signals can be resolved as two spectrum waveforms.

This is called the resolution bandwidth.

Selectivity can be improved by narrowing the 60 dB bandwidth. The selectivity is defined by the ratio of the filter width, in Hz, at the -60 dB point, to the filter width, in Hz, at the -3 dB point, as shown in the formula below.

$$\text{Selectivity} = \frac{\text{60 dB bandwidth (Hz)}}{\text{3 dB bandwidth (Hz)}}$$

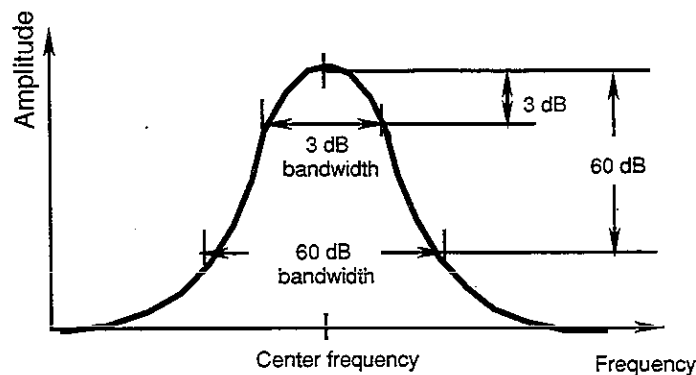

To test the resolution bandwidth and selectivity, first measure the resolution bandwidth (3dB bandwidth), then the 60 dB bandwidth and calculate the 60 dB / 3 dB bandwidth ratio.

(1) Specifications

- Selectivity (60 dB / 3 dB bandwidth): $\leq 15:1$ (1 MHz, 5 MHz)
 $\leq 10:1$ (1, 3, 10, 30, 100, 300 kHz)

(2) Test instrument

- Synthesized signal generator: MG3633A

(3) Setup

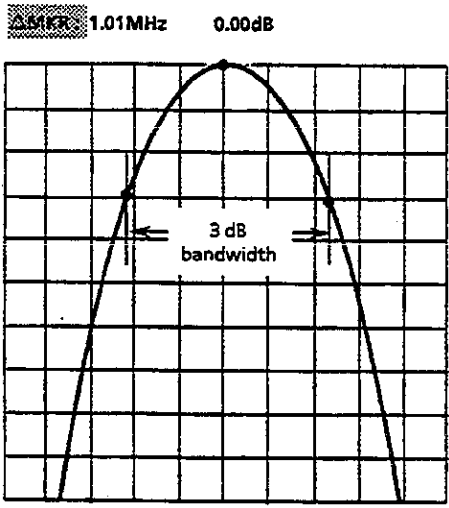
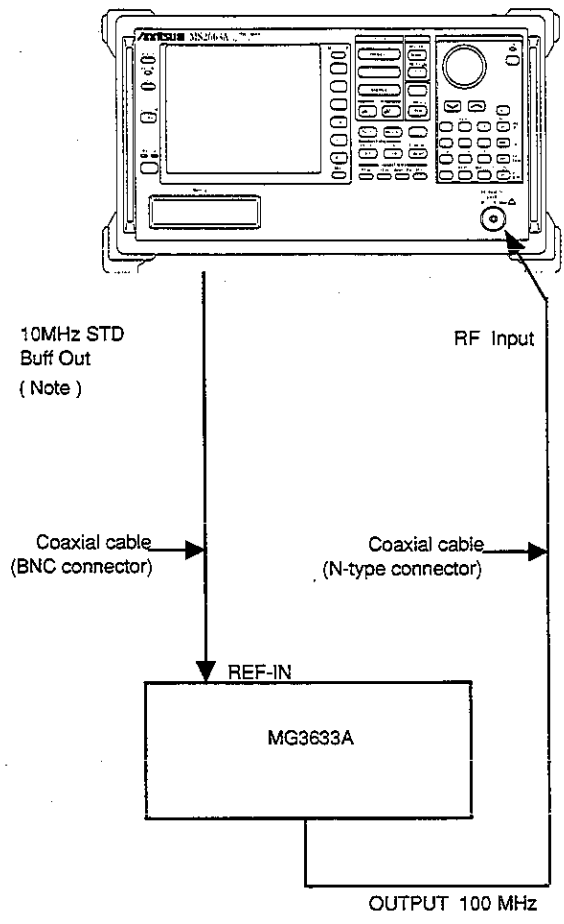

(a) Resolution bandwidth

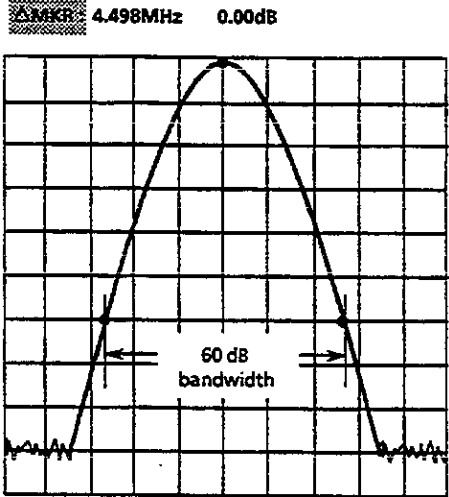

(b) 60 dB dropped bandwidth

Resolution Bandwidth / Selectivity Test

(4) Procedure

(a) Resolution bandwidth accuracy

Step	Procedure
1	Press the [Preset] key.
2	Perform all calibration.
3	Set the spectrum analyzer as shown below: Center Freq 100 MHz Span 10 MHz RBW (MANUAL) 5 MHz Scale LOG 1 dB / div
4	Press the [→ RLV] key and match the peak of the signal trace to the top line (REF LEVEL) on the screen.
5	Press the [Signal] key to execute a single sweep, then check that the single sweep has been completed.
6	After pressing the Measure key, operate Occ BW Measure and Setup and display the setup menu of occupied frequency bandwidth measurement.
7	Select XdB Down and set it to 3 dB.
8	Press Return to return to the Occ BW Measure menu, and then press Execute.
9	The 3 dB resolution bandwidth value is displayed in the upper left-hand corner of the screen. Fill in this value in the table on the next page.
10	Repeat steps 3 to 9 for the frequencies other than the resolution bandwidth 5 MHz and the frequency span 10 MHz according to the combinations of resolution bandwidth and frequency span shown in the table on the next page.

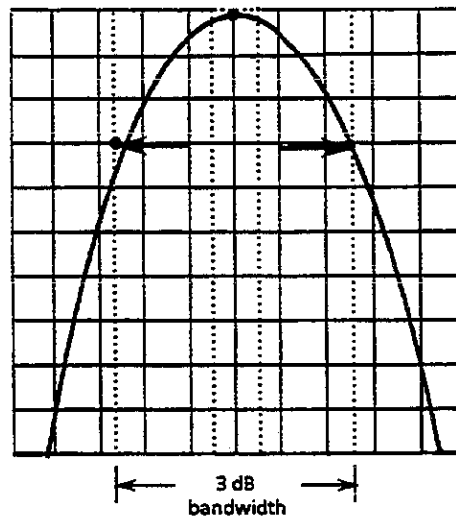

Bandwidth Measurement

Resolution Bandwidth (3 dB)

Resolution bandwidth	Frequency span	3 dB bandwidth
5 MHz	10 MHz	_____
1 MHz	5 MHz	_____
300 kHz	500 kHz	_____
100 kHz	200 kHz	_____
30 kHz	50 kHz	_____
10 kHz	20 kHz	_____
3 kHz	5 kHz	_____
1 kHz	2 kHz	_____

(b) Resolution bandwidth selectivity

Step	Procedure
1	Set the spectrum analyzer as shown below: Center Freq 100 MHz Span 200 MHz RBW (MANUAL) 5 MHz Scale LOG 10 dB / div VBW 100 Hz Marker NORMAL Zone Width 10 MHz
2	Press the [→RLV] key to match the peak of the signal trace to the top line (REF LEVEL) on the screen.
3	Press the [Single] key to execute a single sweep, then check that the single sweep has been completed.
4	After pressing the Measure key, operate Occ BW Measure and Setup and display the setup menu of occupied frequency bandwidth measurement.
5	Select XdB Down and set it to 60 dB.
6	Press Return to return to the Occ BW Measure menu, and then press Execute.
7	The 60 dB resolution bandwidth value is displayed in the upper left-hand corner of the screen. Fill in this value in the table on the next page.
8	Repeat steps 1 to 7 for the frequencies other than the resolution bandwidth 5 MHz and the frequency span 100 MHz according to the combinations of resolution bandwidth and frequency span shown in the table on the next page.
9	For the 3 dB bandwidth, too, write the value of the Resolution Bandwidth (3 dB) table on the preceding page in the table on the next page.
10	For each resolution bandwidth in the table on the next page, confirm that the value calculated from (60 dB BW / 3 dB BW) is ≤ 15 or ≤ 12 .

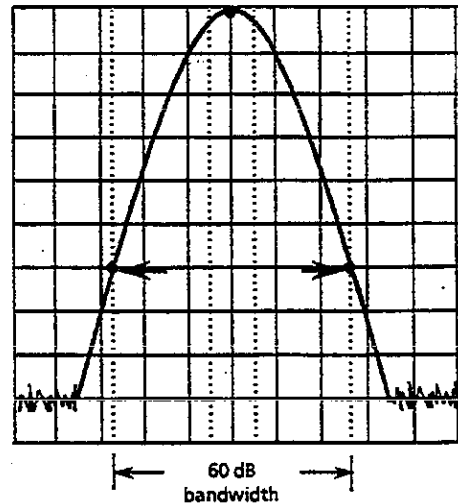

60 dB Bandwidth Measurement

Selectivity Test (60 dB / 3 dB Bandwidth Ratio)

Resolution bandwidth	Frequency span	Video span	Frequency span	Frequency span	Frequency span
5 MHz	200 MHz	100 Hz	_____	_____	_____
1 MHz	50 MHz	100 Hz	_____	_____	_____
300 kHz	20 MHz	100 Hz	_____	_____	_____
100 kHz	10 MHz	100 Hz	_____	_____	_____
30 kHz	200 kHz	100 Hz	_____	_____	_____
10 kHz	100 kHz	100 Hz	_____	_____	_____
3 kHz	20 kHz	100 Hz	_____	_____	_____
1 kHz	10 kHz	10 Hz	_____	_____	_____

Sideband noise

When the resolution bandwidth is set to a fixed value and a signal that has far less sideband-noise level than the equipment to be tested is input, check the level of the noise as compared to the peak signal (dBc) at the specified frequency away from the peak.

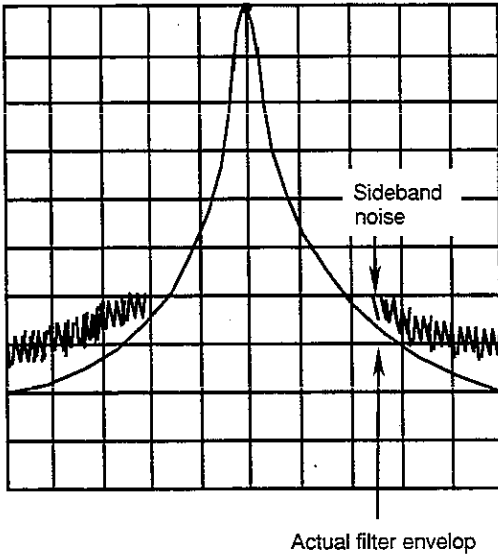

Since the average value is measured for noise level, use a video filter for measurement.

This sideband noise is a spectrum response which is modulated by the internal noise of the spectrum analyzer. If this response is large, the actual filter envelope is masked by the noise as shown, which makes measurement impossible.

(1) Specifications

- Sideband noise: ≤ -100 dBc / Hz (Frequency: 1 GHz, 10 kHz offset; MS2661A/2663A)
 ≤ -90 dBc / Hz (Frequency: 1 GHz, 10 kHz offset; MS2651A/2653A)

(2) Test instruments

- Signal generator: MG3633A Synthesized Signal Generator

(3) Setup

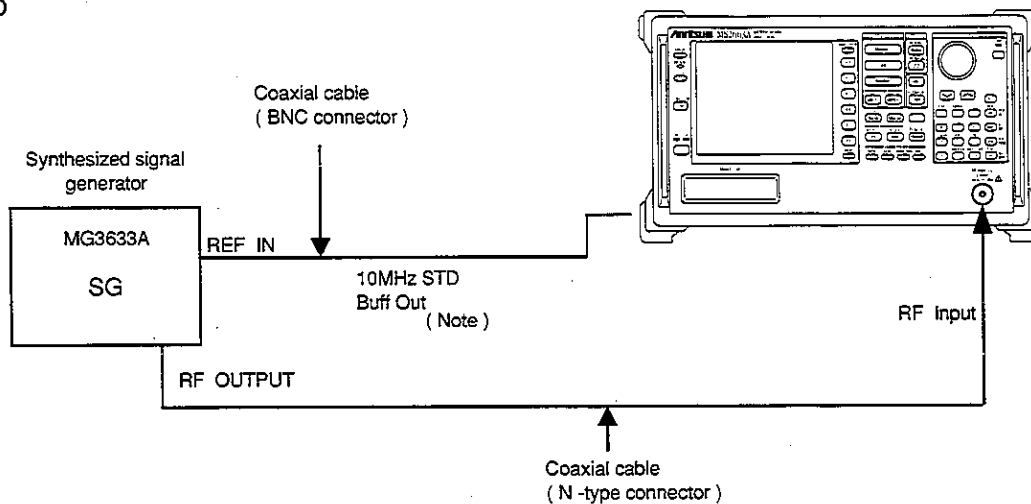

Sideband Noise Test

(4) Procedure

Step	Procedure
1	Press the [Preset] key.
2	Operate All Cal.
3	Set the MG3633A output to 1000 MHz and 0 dBm.
4	Set the spectrum analyzer as shown below: Center Freq 1.000 010 GHz Span 25 kHz Reference Level 0 dBm Attenuator 10 dB RBW 1 kHz VBW 10 Hz DET MODE SAMPLE
5	Press the [Peak Search] key to search for a peak point so that the peak point on the signal trace is included in the zone marker.
6	Press the [→ RLV] key to match the peak of the signal trace to the top line (REF LEVEL) on the screen.
7	After pressing the Measure key, select C/N Ratio Measure.
8	Press the Meas On key to start C/N measurement.
9	Set Zone Width of Marker to Spot.
10	Press the [Marker] key, then turn the rotary knob to move the zone marker to the right so that the zone center frequency is 10.0 kHz.
11	Make sure that the C/N value is -100 dBc/Hz or less (MS2661A/2663A) or -90 dBc/Hz or less (MS2651A/2653A).

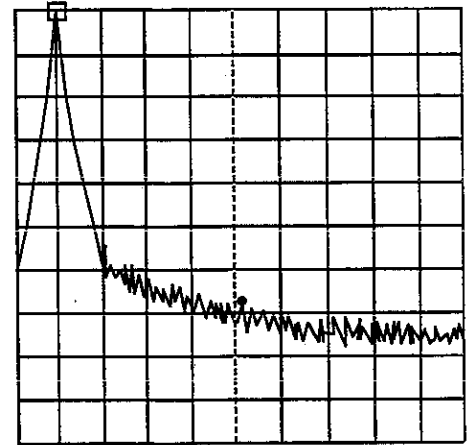

CF : 1.000 010GHz

Span : 25kHz

Sideband Noise Measurement

Frequency measurement accuracy

Set the marker point to the position at least 20 dB higher than the noise (or adjacent interference signal) to operate the built-in counter (Option 03) with the higher-S/N signal, and test the frequency measurement accuracy using Count On mode. (This test cannot be performed without Option 03.)

(1) Specifications

- Accuracy: $\leq (\text{Readout frequency} \times \text{reference oscillator accuracy} \pm (1 \text{ count}))$
- Resolution: 1 Hz, 10 Hz, 100 Hz, 1 kHz

(2) Test instrument

- Signal generator: Wiltron 6769A

(3) Setup

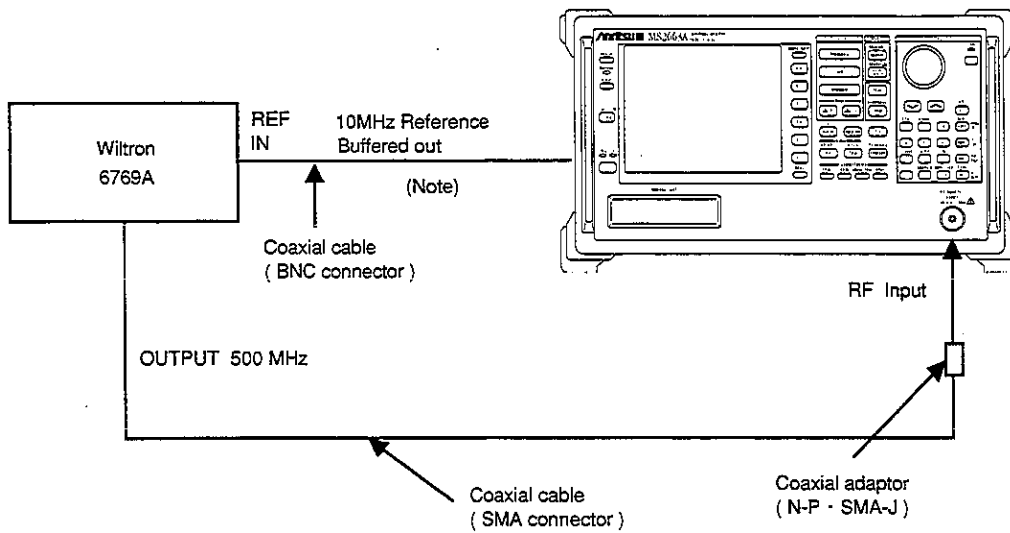

Frequency Measurement Accuracy Test

(Note) If there is no buffer output for the reference oscillator (Option 01) on the rear panel, input a reference signal from an external 10 MHz frequency standard to the main body and signal generator.

(4) Procedure

Step	Procedure
1	Press the [Preset] key.
2	Set the 6769A to 500 MHz and -10 dBm.
3	Set the spectrum analyzer as shown below: Center Freq 500 MHz Span 5 kHz
4	Press the [Measure] key and set to Frequency Count. Press Setup and set Resolution to 1 Hz. Then, press the Return key and set to Count On.
5	Confirm that the FREQ reading at the upper-left of the screen is the RF INPUT frequency 500 MHz \pm 1 Hz or less.
6	Change the counter resolution to 10 Hz and confirm that the Freq reading is 500 MHz \pm 10 Hz or less.
7	<ul style="list-style-type: none"> • Change the counter resolution to 100 Hz and confirm that the Freq reading is 500 MHz \pm 100 Hz or less. • Change the counter resolution to 1 kHz and confirm that the Freq reading is 500 MHz \pm 1 kHz or less.

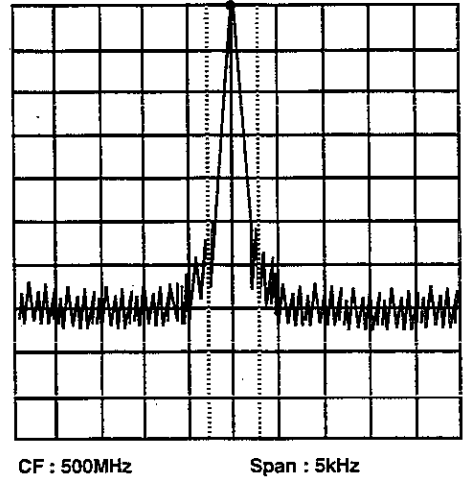

Frequency Measurement

Amplitude display linearity

Test the error per vertical graduation for the LOG display. For the LOG display linearity, test that the graduation is equal to the logarithm (dB) of the input signal level.

Input the correct level signal to the RF Input via an external attenuator and calculate the error from the attenuation of the attenuator and the Δ marker reading at the trace waveform peak.

(1) Specifications

- Amplitude display linearity:
 - After automatic calibration
 - MS2651A/2661A
 - LOG: ± 2.5 dB for 0 to - 90 dB (RBW ≤ 10 kHz)
 - ± 1.5 dB for 0 to - 85 dB (RBW ≤ 10 kHz)
 - ± 1 dB for 0 to - 70 dB (RBW ≤ 100 kHz)
 - ± 0.3 dB for 0 to - 20 (RBW ≤ 1 MHz)
 - MS2653A/2663A
 - LOG: ± 2.5 dB for 0 to - 90 dB (RBW ≤ 10 kHz)
 - ± 1.5 dB for 0 to - 85 dB (RBW ≤ 10 kHz)
 - ± 1 dB for 0 to - 70 dB (RBW ≤ 100 kHz)
 - ± 0.4 dB for 0 to - 20 (RBW ≤ 1 MHz)

(2) Test instruments

- Signal generator: MG3633A
- Attenuator: MN510C

(3) Setup

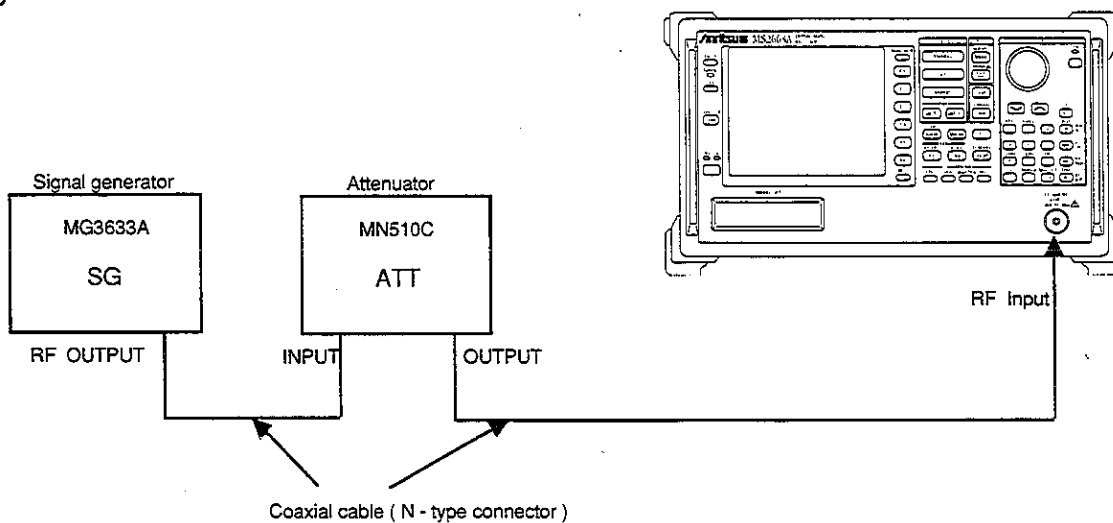

Amplitude Display Linearity Test

(4) Procedure

LOG display linearity

Step	Procedure
1	Press the [Preset] key.
2	Operate All Cal.
3	Set the MG3633A to 100 MHz and 0 dBm.
4	Set the MN510C to 0 dB.
5	Set the spectrum analyzer as shown below: Center Freq 100 MHz Span 10 kHz Reference Level 0 dBm Attenuator 10 dB RBW 3 kHz VBW 300 Hz
6	Press the [→ CF] key to set the spectrum waveform peak to the center of the screen.
7	Adjust the MG3633A output level so that the marker level reading is 0.0 dBm.
8	Press the [Marker] key sequentially to set the marker to Δ marker after the sweep is completed.

Step	Procedure
9	As shown on Fig. (b), read the level of the current marker when ATT is set at 5dB. An error is determined as calibrated ATT 5 dB value + Δ marker level.
10	Add a marker level corresponding to the calibrated ATT value when ATT is set as 10 to 90 DB (with 5 dB steps) and determine the error.

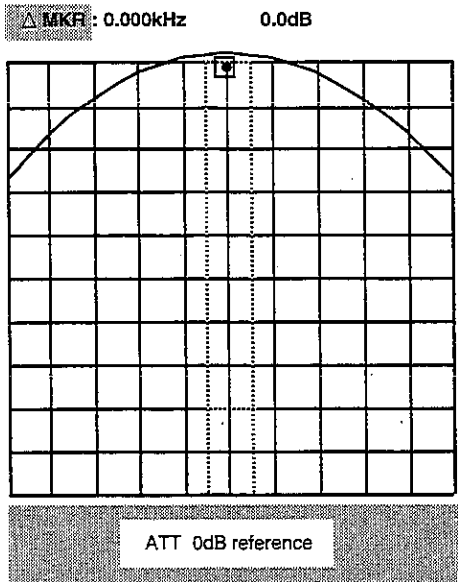

(a) Reference Point Setting

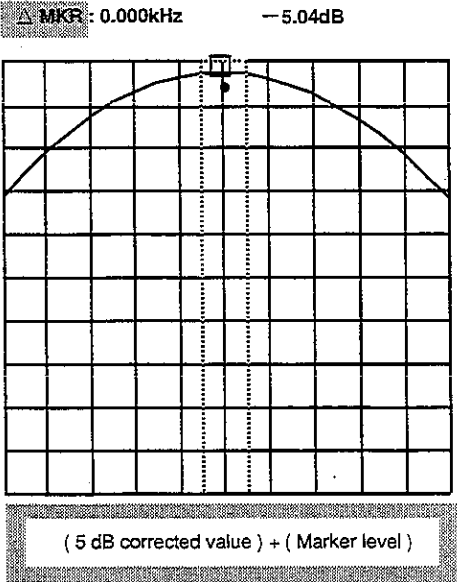

(b) Δ Marker Level when ATT is 5

Log Display Linearity (10 dB / div)

ATT setting (dB)	A	B	Error (dB)=A+B
	ATT calibration value (dB)	Δ marker level (dB)	
0	0 (reference)	0 (reference)	0 (reference)
5	_____	_____	_____
10	_____	_____	_____
15	_____	_____	_____
20	_____	_____	_____
25	_____	_____	_____
30	_____	_____	_____
35	_____	_____	_____
40	_____	_____	_____
45	_____	_____	_____
50	_____	_____	_____
55	_____	_____	_____
60	_____	_____	_____
65	_____	_____	_____
70	_____	_____	_____
75	_____	_____	_____
80	_____	_____	_____
85	_____	_____	_____
90	_____	_____	_____

Frequency response

Generally, when one or more signals with a different frequency but the same amplitude are input, the spectrum analyzer displays the same amplitude for each spectrum on the screen.

(1) Specifications

- Frequency response:
 - MS2651A/2661A At 100 MHz, input ATT 10 dB and temperature range 18 to 28 °C
 ± 0.5 dB (100 kHz to 3 GHz)
 - MS2653A/2663A ± 0.5 dB (100 kHz to 3.2 GHz, band 0, based on 100 MHz, input attenuator: 10 dB, temperature range: 18 to 28 °C)
 ± 1.5 dB (9 to 100 kHz, band 0, based on 100 MHz, input attenuator: 10 dB, temperature range: 18 to 28 °C)
 ± 1.5 dB (3.1 to 8.1 GHz, band 1-/1+, based on 100 MHz, input attenuator: 10 dB, temperature range: 18 to 28 °C)
 ± 1.0 dB (100 kHz to 3.2 GHz, band 0, input attenuator: 10 to 50 dB)
 ± 3.0 dB (3.1 to 8.1 GHz, band 1-/1+, input attenuator: 10 to 50 dB)
- * For band 1- and 1+, after the preselector is tuned.....

(2) Test instruments

- Signal generator: Wiltron 6769A
- Power meter: ML4803A
- Power sensor: MA4601A (For the MS2651A/2661A)
 MA4701A (For the MS2653A/2663A)

(3) Setup

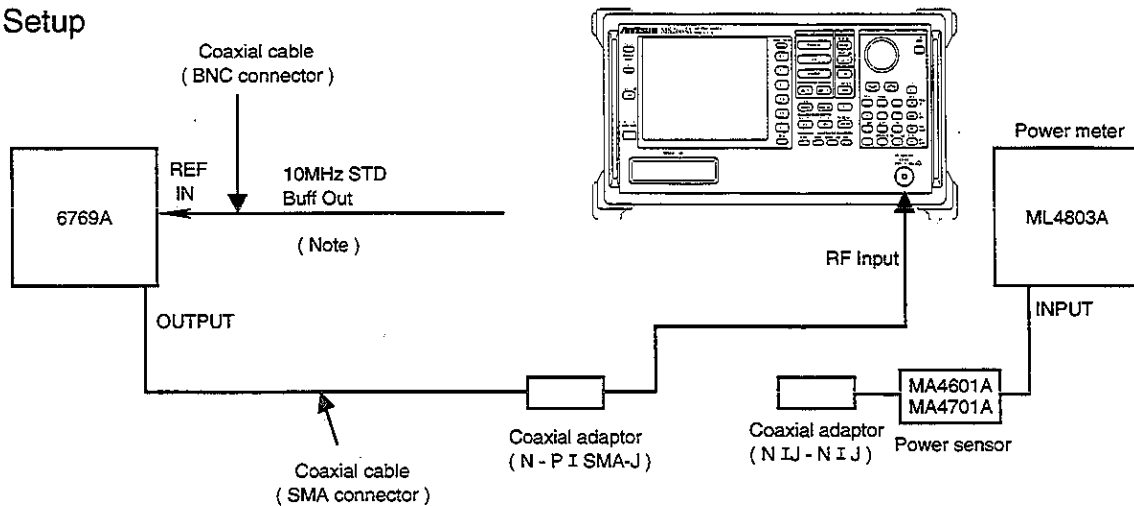

(Note) If there is no buffer output for the reference oscillator (Option 01) on the rear panel, input a reference signal from an external 10 MHz frequency standard to the main body and signal generator.

Frequency Response Test

(4) Precautions

This test should be performed at an ambient temperature of 10° to 28°C after allowing the instrument to warm up for 60 minutes or more.

(5) Procedure

(a) Calibration of signal-generator 6769A

Step	Procedure
1	Set the 6769A as shown below: OUTPUT FREQ 100 MHz OUTPUT LEVEL - 10 dBm
2	Connect the 6769A output to the power sensor input with a coaxial cable.
3	Read the power meter display.
4	Change the 6769A output frequency as shown in the tables on the next page and read the power meter display with level at 100 MHz as reference. This data is the calibration data.

(b) Readout of measured amplitude deviation (frequency response)

Step	Procedure
1	Connect the 6769A OUTPUT to the spectrum analyzer RF Input with a coaxial cable.
2	Press the spectrum analyzer [Preset] key.
3	Perform all calibration.
4	Set the spectrum analyzer as shown below: Center Freq 100 MHz Span 200 kHz Reference Level - 10 dBm
5	Press the [→ CF] key.
6	Set the marker mode to delta marker.
7	Set the spectrum analyzer center frequency as shown in the tables on the next page, then obtain the deviation from the formula below by reading the delta marker level at each frequency. Deviation = Delta marker level reading – Measurement frequency calibration value For Band 1- and 1+, the preselector is peaked. (See Chapter 8 of Vol.2, "Detailed Panel Operation.")

Frequency Response

Frequency	Calibration value (dBm)	Marker level (dB)	Deviation (dB)
100 MHz	0 dB (reference)	0 dB (reference)	0 dB (reference)
200 MHz	_____	_____	_____
500 MHz	_____	_____	_____
1 GHz	_____	_____	_____
1.5 GHz	_____	_____	_____
2 GHz	_____	_____	_____

Frequency Response (Band 0)

Frequency	Calibration value (dBm)	Marker level (dB)	Deviation (dB)
100 MHz	0 dB (reference)	0 dB (reference)	0 dB (reference)
200 MHz	_____	_____	_____
500 MHz	_____	_____	_____
1 GHz	_____	_____	_____
1.5 GHz	_____	_____	_____
2 GHz	_____	_____	_____
3 GHz	_____	_____	_____

Frequency Response (Band 1-)

Frequency	Calibration value (dBm)	Marker level (dB)	Deviation (dB)
3.1 GHz	_____	_____	_____
4 GHz	_____	_____	_____
5 GHz	_____	_____	_____
6 GHz	_____	_____	_____
6.5 GHz	_____	_____	_____

Frequency Response (Band 1+)

Frequency	Calibration value (dBm)	Marker level (dB)	Deviation (dB)
6.5 GHz	_____	_____	_____
7 GHz	_____	_____	_____
7.5 GHz	_____	_____	_____
8 GHz	_____	_____	_____

Reference level accuracy

Here the absolute amplitude level at only 100 MHz is tested. Confirm the level accuracy after inputting an SG output (calibrated by a standard power meter) to the MS2650/MS2660 series.

(1) Specifications

- Reference level accuracy: At 100 MHz frequency and 2 MHz span after automatic calibration
(Resolution bandwidth, video bandwidth and sweep time set to AUTO)
- MS2651A/2661A
 - $\leq \pm 0.3 \text{ dB}$ (0 to $- 49.9 \text{ dBm}$)
 - $\leq \pm 0.75 \text{ dB}$ ($- 69.9$ to $- 50 \text{ dBm}$, 0.1 to $+ 30 \text{ dBm}$)
 - $\leq \pm 1.5 \text{ dB}$ ($- 80$ to $- 70 \text{ dBm}$)
- MS2653A/2663A
 - $\leq \pm 0.4 \text{ dB}$ (0 to $- 49.9 \text{ dBm}$)
 - $\leq \pm 0.75 \text{ dB}$ ($- 69.9$ to $- 50 \text{ dBm}$, 0.1 to $+ 30 \text{ dBm}$)
 - $\leq \pm 1.5 \text{ dB}$ ($- 80$ to $- 70 \text{ dBm}$)

(2) Test instruments

- Signal generator: MG3633A
- Attenuator: MN510C
- Power sensor: MA4601A
- Power meter: ML4803A

(3) Setup

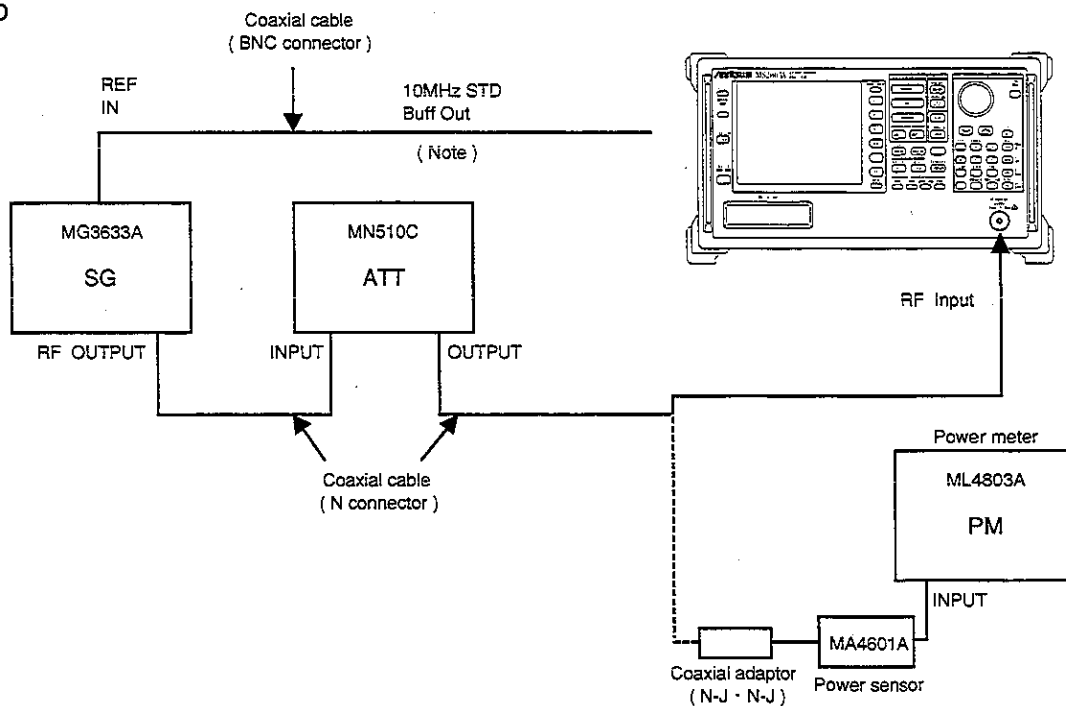

Reference Level Accuracy Test

(Note) If there is no buffer output for the reference oscillator (Option 01) on the rear panel, input a reference signal from an external 10 MHz frequency standard to the main body and signal generator.

(4) Precautions

- 1) Set the resolution bandwidth, video bandwidth and sweep time to Auto.
- 2) This test should be performed after warming up this instrument for 60 minutes or more.

(5) Procedure

Step	Procedure
1	Press the spectrum analyzer [Preset] key.
2	Operate All Cal.
3	Connect the attenuator OUTPUT to the power sensor input.
4	Set the SG frequency to 100 MHz and adjust the SG level so that the power meter indication is 0 dBm. At this time, set the attenuator to 0 dB.
5	Connect the attenuator OUTPUT to the spectrum analyzer RF Input connector.
6	Set the spectrum analyzer as shown below: Center Freq 100 MHz Span 2 MHz Reference Level 0 dBm
7	Press the [→ CF] to move the peak point of the spectrum waveform to the center of the screen.
8	Read the marker level.

Step	Procedure
9	Change the attenuator in 10 dB steps, set the reference level as shown in the table below and read the marker level each time.

Reference level setting	Marker level value	Calibrated attenuation value	Error
0 dBm			
- 10 dBm			
- 20 dBm			
- 30 dBm			
- 40 dBm			
- 50 dBm			
- 60 dBm			
- 70 dBm			
- 80 dBm.			

10 Find the error from the following equation.

$$\text{Error} = \text{marker level value} - \text{reference level set value} - \text{calibrated attenuation value}$$

Average noise level

The internal noise distributed evenly in proportion to the resolution bandwidth over the whole measurement frequency band is called the average noise level.

(1) Specifications

- Average noise level: At 1 kHz resolution bandwidth, 1 Hz video bandwidth, and 0 dB input attenuator:
 - MS2661A
 - ≤ -115 dBm (1 MHz to 1 GHz)
 - ≤ -115 dBm + f [GHz] dB (1 GHz \leq)
 - MS2651A
 - ≤ -110 dBm (1 MHz to 1 GHz)
 - ≤ -110 dBm + f [GHz] dB (1 GHz \leq)
 - MS2663A
 - ≤ -115 dBm (1 MHz to 1 GHz)
 - ≤ -115 dBm + 1.5 f [GHz] dB (1 to 3.1 GHz, Band 0)
 - ≤ -115 dBm + 0.5 f [GHz] dB (3.1 to 8.1 GHz, Band 1)
 - MS2653A
 - ≤ -110 dBm (1 MHz to 1 GHz)
 - ≤ -110 dBm + f [GHz] dB (1 to 3.1 GHz, Band 0)
 - ≤ -110 dBm + 0.5 f [GHz] dB (3.1 to 8.1 GHz, Band 1)

(2) Test instruments

- 50 Ω terminator: MP752A (For the MS2651A/2661A)
WILTRON 28KF50(For the MS2653A/2663A)

(3) Setup

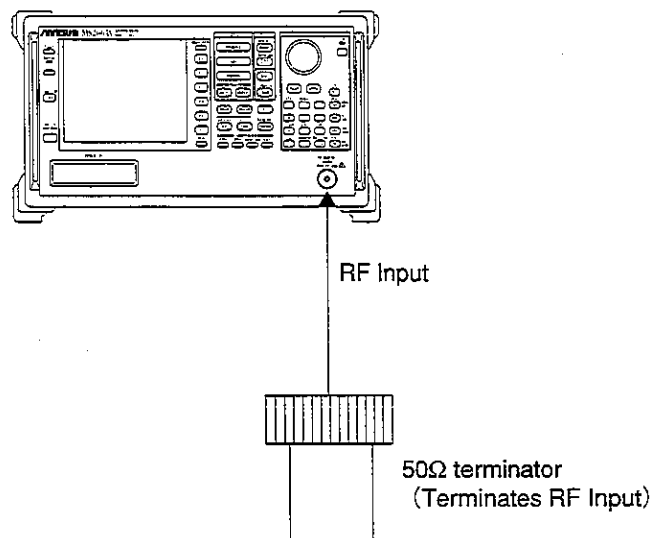

Average Noise Level Test

(4) Procedure

Step	Procedure
1	Press the spectrum analyzer [Preset] key.
2	Operate All Cal.
3	Terminate the RF Input with a 50 Ω terminator.
4	Set the spectrum analyzer as shown below: Start Freq 1 MHz Stop Freq 1 GHz Reference Level -40 dBm Attenuator 0 dB RBW 30 kHz VBW 3 kHz Detection Sample
5	Press the [Single] key to execute a single sweep.
6	Press the [\rightarrow CF] key to set the frequency at the peak level of the spectrum to the center frequency.
7	Press the [Shift] key and then the [Single] key to execute a continuous sweep.
8	Set the spectrum analyzer as shown below : (Time Domain) Span 0 Hz Reference Level -100 dBm RBW 1 kHz VBW 1 Hz
9	Press [Time], Storage, Average and Average Count keys in order and set the average count to 16.
10	Press the Continue key to start the averaging, and wait until the 16-time averaging sweep is completed.
11	Press the [Peak Search] key to execute peak search. At this point, read the level value at the marker.
12	Confirm that the marker reading is less than the specification, shown in the table on the next page.

Step	Procedure
------	-----------

MS2651A/MS2661A setting		Average noise level	
START FREQ	STOP FREQ	Marker reading	MS2651A/MS2661A specification
1 MHz	1 GHz		-110 dBm/-115 dBm
1 GHz	2 GHz		-109 to -108 dBm/ -114 to -113 dBm

MS2653A/MS2663A setting		Average noise level	
START FREQ	STOP FREQ	Marker reading	MS2653A/MS2663A specification
1 MHz	1 GHz		-115 dBm/-110 dBm
1 GHz	2 GHz		-113.5 dBm to -112 dBm -118.5 dBm to -107 dBm
4 MHz	6 GHz		-113 dBm to -112 dBm -118 dBm to -107 dBm
7 GHz	8 GHz		-111.5 dBm to -111 dBm -106.5 dBm to -106 dBm

- 13** Repeat steps 4 to 12 while setting Start / Stop Freq from the below table so that the average noise level can be obtained.

Second harmonic distortion

Even if a signal without harmonic distortion is input to a spectrum analyzer, the higher harmonics are generated by the analyzer input-mixer non-linearity and are displayed on the screen.

The second harmonic level is the highest harmonic displayed on the MS2650/MS2660 series spectrum analyzer. The main point of the test is to apply a signal (with a distortion that is lower than the spectrum analyzer internal harmonic distortion [at least 20 dB below]) to the spectrum analyzer and measure the level difference between the fundamental wave and the second harmonic. If a low-distortion signal source cannot be obtained, apply a low-distortion signal to the spectrum analyzer after passing the signal through a low-pass filter (LPF).

(1) Specifications

- Second harmonic distortion:
 - MS2661A
 - At mixer input level – 30 dBm:
 - ≤ -60 dBc (input frequency 10 to 200 MHz)
 - ≤ -75 dBc (input frequency 200 to 1500 MHz)
 - ≤ -80 dBc (input frequency 800 to 1000 MHz)
 - MS2651A
 - At mixer input level – 30 dBm:
 - ≤ -55 dBc (input frequency 10 to 100 MHz)
 - ≤ -60 dBc (input frequency 100 to 1500 MHz)
 - MS2663A
 - At mixer input level – 30 dBm:
 - ≤ -60 dBc (10 to 200 MHz, Band 0)
 - ≤ -75 dBc (0.2 to 1.3 GHz, Band 0)
 - ≤ -70 dBc (1.3 to 1.55 GHz, Band 0)
 - ≤ -80 dBc (0.8 to 1 GHz, Band 0)
 - At mixer input level – 20 dBm:
 - ≤ -100 dBc (1.55 to 4.05 GHz, Band 1-/1+)
 - MS2653A
 - At mixer input level – 30 dBm:
 - ≤ -55 dBc (10 to 100 MHz)
 - ≤ -60 dBc (0.1 to 1.55 GHz)
 - At mixer input level – 20 dBm:
 - ≤ -100 dBc (1.55 to 4.05 GHz, Band 1-/1+)

(2) Test instruments

- Signal generator: MG3633A
- LPF: With attenuation of 70 dB or more at twice the fundamental frequencies

(3) Setup

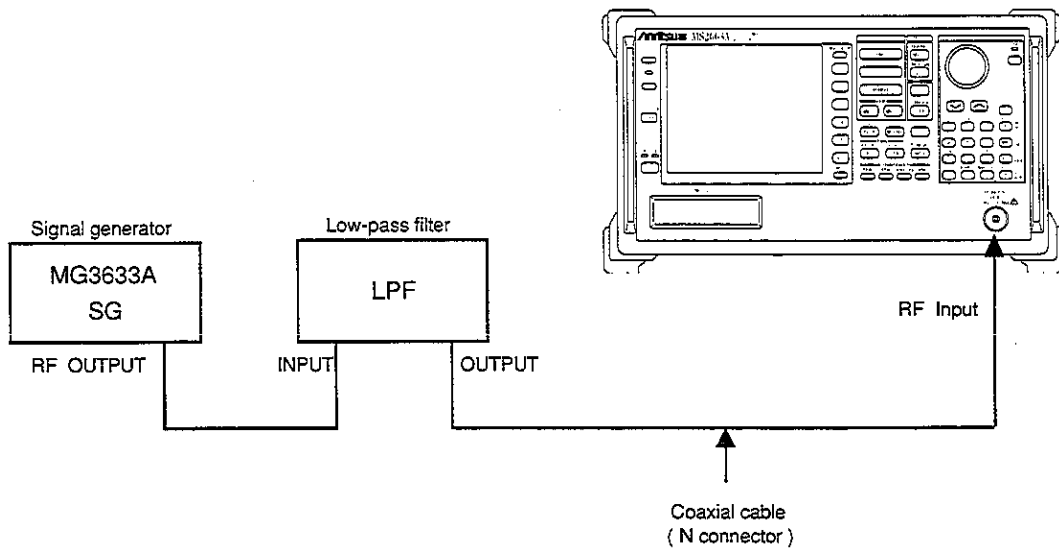

Second Harmonic Distortion Test

(4) Procedure

Step	Procedure
1	Press the [Preset] key.
2	Operate All Cal.
3	Set the LPF cut-off frequency to approx. 12.8 MHz.
4	Set the SG output frequency to 10 MHz and the output level to -30 dBm.
5	Set the spectrum analyzer as shown below: Center Freq 10 MHz Span 10 kHz Reference Level -30 dBm Attenuator 0 dB
6	Adjust the SG output level so that peak of the spectrum waveform is at the REF LEVEL (the top horizontal line of the screen).

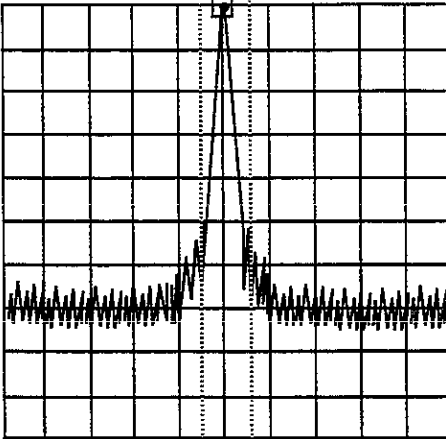
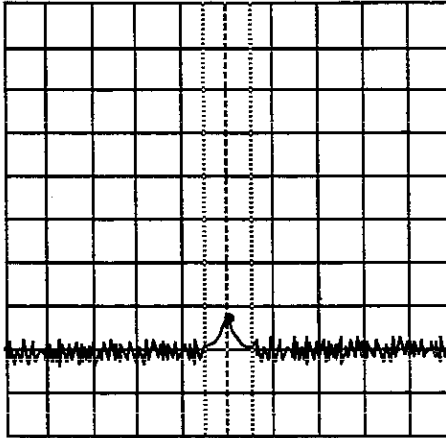
Step	Procedure	
7	Move the marker to the peak of the spectrum waveform and make the marker the \triangle marker.	
8	<p>Set the center frequency to twice the fundamental wave frequency to display the second harmonic on the screen.</p> <p>The \triangle marker reading indicates the level difference between the fundamental wave and the second harmonic.</p> <p>If the level difference is 80 dB or more, set the REF LEVEL to -50 dBm. Confirm that the ATT set value is 0 dB.</p>	
9	Set the LPF cut-off frequency to approx. 1.2 GHz.	
10	<p>Set the SG as follows:</p> <p>OUTPUT FREQ 1 GHz</p> <p>OUTPUT LEVEL -30 dBm</p>	
11	<p>Set the spectrum analyzer as follows:</p> <p>Center Freq 1 GHz</p> <p>Span 10 kHz</p> <p>Reference Level -30 dBm</p> <p>Attenuator 0 dB</p>	
12	Repeats steps 6 to 8.	

Resolution bandwidth (RBW) switching error

When the resolution bandwidth (RBW) is switched, its level error at the peak point is measured.

(1) Specifications

- Resolution bandwidth switching error: ± 0.3 dB
 ± 0.4 dB (For MS2653A/2663A, RBW=5 MHz)

(2) Setup

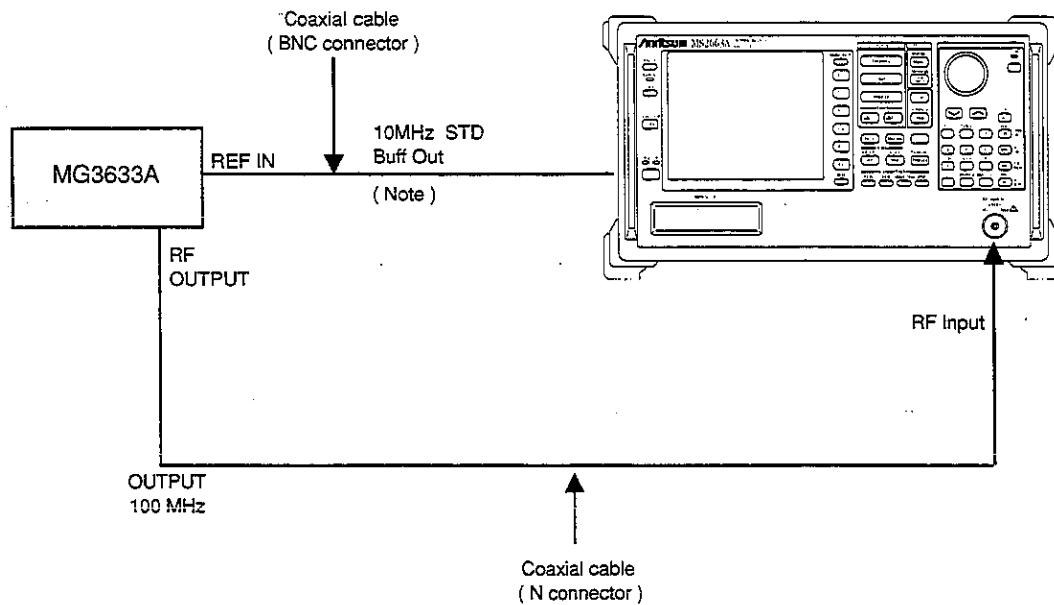

Resolution Bandwidth Switching Error Test

- (Note) If there is no buffer output for the reference oscillator (Option 01) on the rear panel, input a reference signal from an external 10 MHz frequency standard to the main body and signal generator.

(4) Procedure

Step	Procedure
1	Press the spectrum analyzer [Preset] key.
2	Operate All Cal.
3	Set the signal generator MG3633A as shown below. OUTPUT FREQ 100 MHz OUTPUT LEVEL 0 dBm
4	Set the spectrum analyzer as shown below. Center Freq 100 MHz Span 15 kHz Reference Level 0 dBm RBW 3 kHz
5	Press the [→ CF] key to move the signal spectrum peak to the center.
6	Press [Marker] key in that order to set the marker to Δ marker.
7	Set RBW and SPAN as shown in the table on the next page and measure the level deviation (error) of each RBW by following steps 8 and 9 below.
8	Press [Peak Search] key to conduct peak search and move the current marker to the peak point of the signal spectrum.
9	Read the Δ marker level value.

SECTION 6 PERFORMANCE TESTS

MS2660/MA2650 series setting		Δ marker reading	Specification
RBW	SPAN		
1 kHz	5 kHz		± 0.3 dB
3 kHz	15 kHz	0.0 dB	Reference
10 kHz	50 kHz		± 0.3 dB
30 kHz	150 kHz		± 0.3 dB
100 kHz	500 kHz		± 0.3 dB
300 kHz	1.5 MHz		± 0.3 dB
1 MHz	5 MHz		± 0.3 dB
5 MHz	10 MHz		± 0.3 dB (MS2651A/2661A) ± 0.4 dB (MS2653A/2663A)

Input attenuator switching error

At this point, measure the switching error when the amount of attenuation in the RF input section is switched. When the input attenuator is switched, IF-section step-amplifier gain is switched. To keep this step-amplifier gain constant, the reference level is switched according to the amount of input attenuator attenuation.

(1) Specifications

- Input attenuator switching error: ± 0.3 dB (at 0 to 50 dB, frequency 100 MHz and input ATT 10 dB)

(2) Test instruments

- Signal generator: MG3633A
- Attenuator: MN510C
- Power meter: ML4803A
- Power sensor: MA4601A

(3) Setup

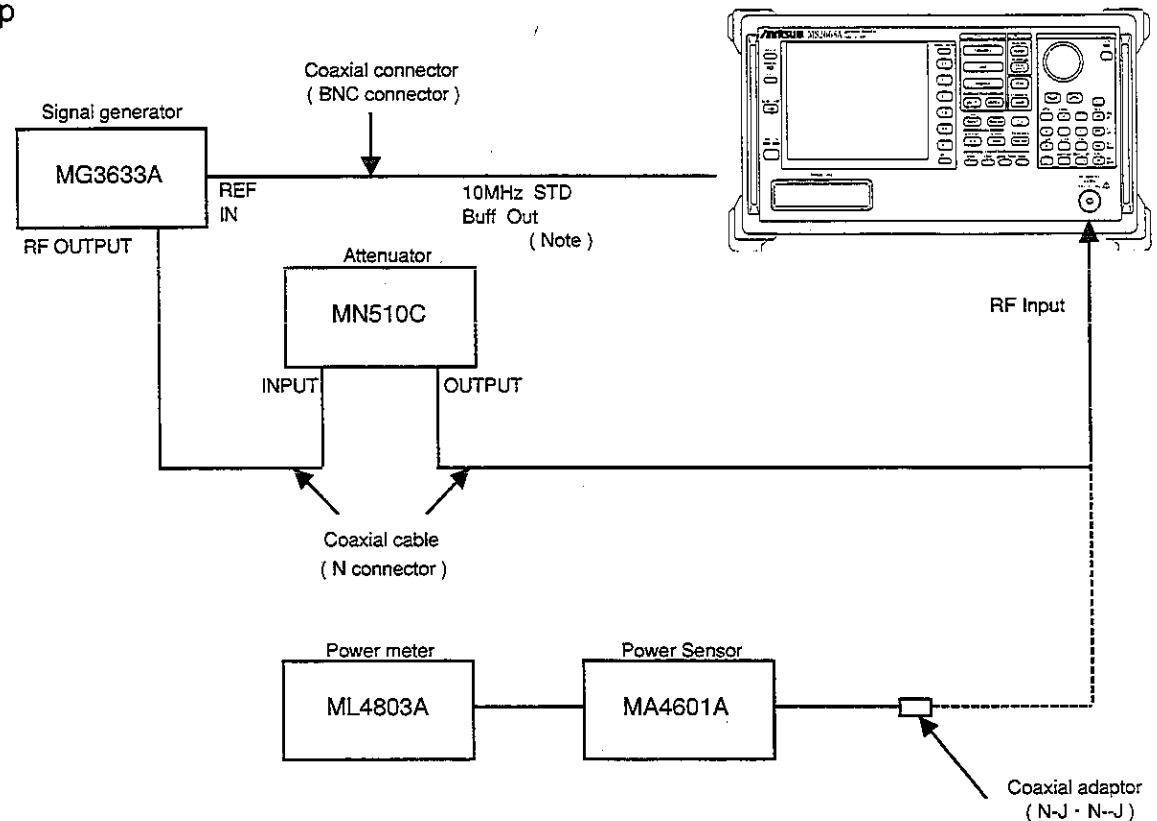

Input Attenuator Switching Error Test

- (Note) If there is no buffer output for the reference oscillator (Option 01) on the rear panel, input a reference signal from an external 10 MHz frequency standard to the main body and signal generator.

(4) Procedure

Step	Procedure
1	Press the spectrum analyzer [Preset] key.
2	Operate All Cal.
3	Set the spectrum analyzer as shown below: Center Freq 100 MHz Span 200 kHz
4	Set the signal generator MG3633A as shown below: OUTPUT FREQ 100 MHz OUTPUT LEVEL -10 dBm
5	Set the amount of attenuation of the attenuator MN510C to 0 dB.
6	Connect the output of the attenuator MN510C to the power meter via coaxial cable.
7	Adjust the signal-generator output level so that the indicated value of the power meter is -10.0 dBm.
8	Connect the coaxial cable of the attenuator output to the spectrum analyzer RF Input.
9	Press the [→ CF] key.
10	Set the reference level to -10 dBm and attenuation to 50 dB.
11	Read the marker level.
12	Set Reference Level, ATT of this device and the external ATT as shown in the table on the next page, and read the level of each marker.
13	Find the error by the formula below: $\text{Error} = \text{marker level value} - \text{Reference Level} - \text{attenuator calibration value}$
14	Find the deviation by the formula below: $\text{Deviation} = \text{Error} - \text{error when ATT at 10 dB}$ Confirm that the deviation is within ± 0.3 dB.

Spectrum analyzer setting		Attenuator setting	Calibration value of attenuator	Marker level value	Error	Deviation
REF LEVEL	ATT					
- 10 dBm	50 dB	0 dB	dB	dBm	dB	dB
- 20 dBm	40 dB	10 dB	dB	dBm	dB	dB
- 30 dBm	30 dB	20 dB	dB	dBm	dB	dB
- 40 dBm	20 dB	30 dB	dB	dBm	dB	dB
- 50 dBm	10 dB	40 dB	dB	dBm	dB	0 dB (reference)
- 60 dBm	0 dB	50 dB	dB	dBm	dB	dB

Sweep time and time span accuracy

(1) Specifications

- Sweep time accuracy: $\pm 15\%$ (20 msec to 100 sec)
 $\pm 45\%$ (110 sec to 1000 sec)
- Time span accuracy: $\pm 1\%$

(2) Test instruments

- Signal generator: MG3633A
Wiltron 6769A

(3) Setup

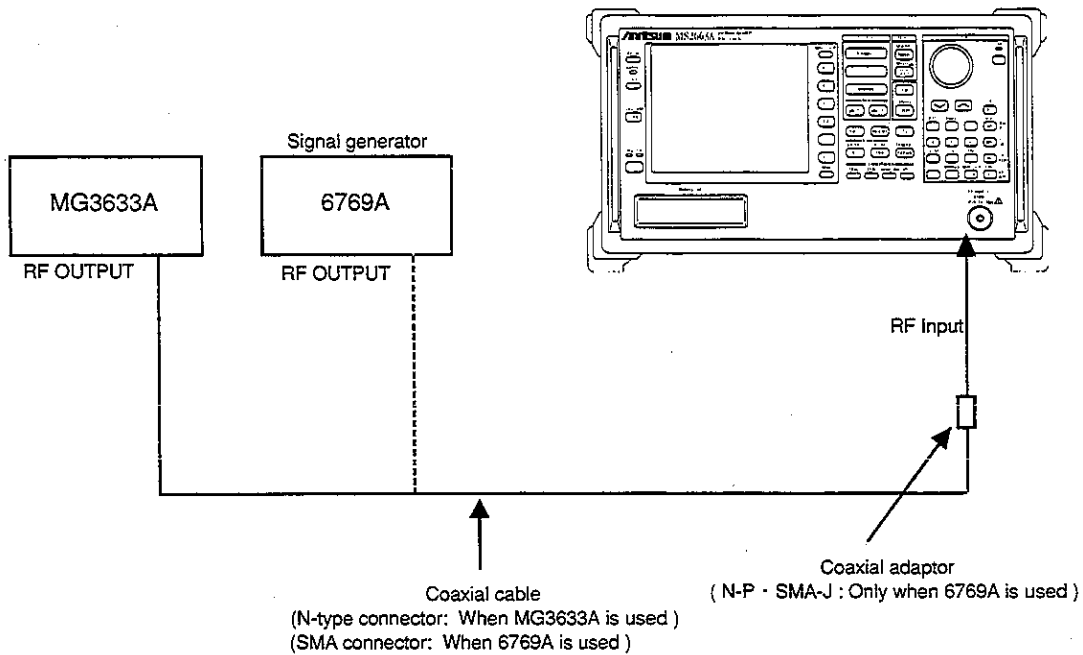

Sweep Time and Time Span Accuracy

(4) Procedure

(a) Sweep Time

Step	Procedure
1	Press the spectrum analyzer [Preset] key.
2	Operate All Cal.
3	Connect the MG3633A signal generator with the spectrum analyzer as shown in the setup diagram.
4	Set the spectrum analyzer as shown below: CENTER FREQ 100 MHz SPAN 1 KHz SWP TIME 20 msec RBW 1 MHz VBW 1 MHz
5	Set the MG3633A as shown below: OUTPUT FREQ 100 MHz OUTPUT LEVEL -16 dBm MODULATION AM (INT) 90% MODULATION FREQ 1 kHz
6	Press the [→ RLV] key.
7	Set the scale to Linear.
8	Press the [Single] key, then wait until a single sweep execution is completed.
9	Set the marker zone width to 5 Hz (Zone Width = 5 Hz).
10	Move the marker to the left of the screen using the knob and set the zone marker on the left most peak of the sine wave.
11	Setting the marker mode to Δ (delta), move the current marker to the right using the knob. Then set the zone marker to the 18th peak from the left most sine wave peak on the screen.
12	Read the time display of the Δ marker, which corresponds to 90% of the Sweep Time. Obtain the SWP TIME by the following equation.

$$\text{SWP TIME} = \text{Setting SWP TIME} \times \frac{\text{marker reading}}{\Delta \text{ 1000 (Hz)}}$$

SECTION 6 PERFORMANCE TESTS

Step	Procedure
13	Measure at each setting shown in the table below according to steps 8 to 12.

Spectrum analyzer Setting SWP TIME	MG3633A AM modulation frequency	Spectrum analyzer SWP TIME	90% of specification min / max
20 msec	1 kHz		15.3 msec / 20.7 msec
200 msec	100 Hz		153 msec / 207 msec
2 sec	10 Hz		1.53 sec / 2.07 sec
20 sec	1 Hz		15.3 sec / 20.7 sec
200 sec	0.1 Hz		99 sec / 261 sec

Leftmost peak The 18th peak numbered from the leftmost peak

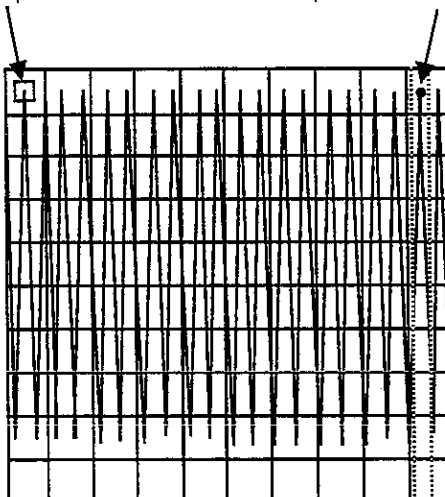

(b) Time span

Step	Procedure
1	Perform test procedure steps 1 to 8 on the preceding paragraph (a). However, set MODULATION FREQ of the MG3633A to 100 Hz.
2	Set the display mode to Time.
3	Set Time Span to 20 msec.
4	Perform steps 8 to 13 of the test procedure on the preceding paragraph (a).

Spectrum analyzer time span	MG3633A AM modulation frequency	Spectrum analyzer Δ marker reading	90% of specification min / max
20 msec	1 kHz		17.82 msec / 18.12 msec
200 msec	100 Hz		178.2 msec / 181.8 msec
2 sec	10 Hz		1.782 sec / 1.818 sec
20 sec	1 Hz		17.82 sec / 18.18 sec
200 sec	0.1 Hz		178.2 sec / 181.8 sec

Tracking generator(TG) output level accuracy

The output level of the Tracking Generator(TG, Option 20) can be easily tested by inputting the TG output signal to the RF Input connector of the Spectrum analyzer.

Here, an accurate method to test the TG output level by using a power meter, is described below.

(1) Specifications

- Output level range: 0 to - 60dBm
- Output level accuracy: $\leq \pm 1.0$ dB(at frequency 100 MHz, output level 0 dBm)
- Output level flatness: $\leq \pm 1.5$ dB(at output level 0 dBm, referenced to 100 MHz)
- Output level linearity: $\leq \pm 1.0$ dB(output level 0 to - 30 dBm)
 $\leq \pm 2.0$ dB(output level - 30 to - 60 dBm)
 (referenced to 0 dBm)

(2) Test instrument

- Power meter: ML4803A
- Power sensor: MA4601A, MA4602A

(3) Setup

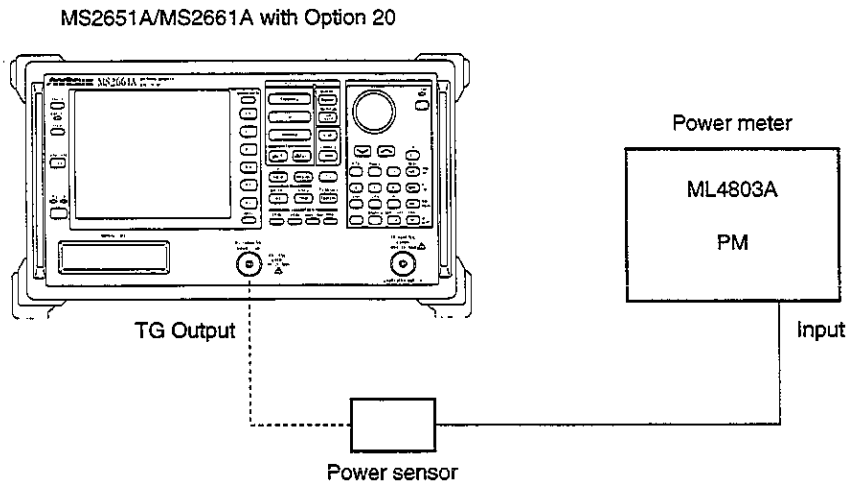

TG Output Level Accuracy Test

(4) Procedure

(a) Calibrating ML4803A Power Meter

Step	Procedure
1	Warm-up the ML4803A, then zero-adjust the ML4803A. (Note: Don't connect anything to the power sensor.)
2	Connect the power sensor to the CAL OUTPUT of the ML4803A. Press the [ON] key. After conforming the measured value to be stabilized, press the [ADJ] key for calibration.

(b) Measuring TG output level accuracy

Step	Procedure
1	Press the [Preset] key.
2	Connect the power sensor to the TG Output.
3	Set the spectrum analyzer as shown below: Center Freq ----- 100 MHz Span ----- 10 MHz
4	Set the TG output level to 0 dBm, and ON.
5	Measure the TG output level with the power meter.
6	Changing the Center Freq of the spectrum analyzer as shown in the table on the next page, repeat the steps 3 to 5 above.
7	Changing the output level of the spectrum analyzer as shown in the table on the next page, repeat the steps 3 to 6 above.

TG Output Level Accuracy Test

Output level (dBm)	Frequency(Hz)							
	100k	1M	10M	50M	100M	1G	2G	3G
0								
-1~-9								
-10								
-20								
-30								
-40								
-50								

Service

If the instrument is damaged or does not operate as specified, contact your nearest Anritsu dealer or business office for repair. When you request repair, provide the following information.

- (a) Model name and serial number on rear panel
- (b) Fault description
- (c) Name of a personnel-in-charge and address for contact when fault confirmed or at a completion of repair

SECTION 7
STORAGE AND TRANSPORTATION

This section describes the long-term storage, repacking and transportation of the MS2650/MS2660 series as well as the regular care procedures and the timing.

TABLE OF CONTENTS

Cleaning Cabinet	7-3
Storage Precautions	7-4
Precautions before storage	7-4
Recommended storage precautions	7-4
Repacking and Transportation	7-5
Repacking	7-5
Transportation	7-5

SECTION 7 STORAGE AND TRANSPORTATION

Cleaning Cabinet

Always turn the spectrum analyzer POWER switch OFF and disconnect the power plug from the AC power inlet before cleaning the cabinet. To clean the external cabinet:

- Use a soft, dry cloth for wiping off.
 - Use a cloth moistened with diluted neutral cleaning liquid if the instrument is very dirty or before long-term storage.
- After insuring that the cabinet has been thoroughly dried, use a soft, dry cloth for wiping off.
- If loose screws are found, tighten them with the appropriate tools.

CAUTION

Never use benzene, thinner, or alcohol to clean the external cabinet; it may damage the coating, or cause deformation or discoloration.

Storage Precautions

This paragraph describes the precautions to take for long-term storage of the MS2650/MS2660 series SPECTRUM ANALYZER.

Precautions before storage

- (1) Before storage, wipe dust, finger-marks, and other dirt off the spectrum analyzer.
- (2) Avoid storing the spectrum analyzer where:
 - 1) It may be exposed to direct sunlight or high dust levels.
 - 2) It may be exposed to high humidity.
 - 3) It may be exposed to active gases.
 - 4) It may be exposed to extreme temperatures ($> 40^{\circ}\text{C}$ or $> 70^{\circ}\text{C}$) or high humidity ($\geq 90\%$).

Recommended storage precautions

The recommended storage conditions are as follows:

- Temperature 0 to 30°C
- Humidity 40% to 80%
- Stable temperature and humidity over 24-hour period

Repacking and Transportation

The following precautions should be taken if the MS2650/MS2660 series SPECTRUM ANALYZER must be returned to Anritsu Corporation for servicing.

Repacking

Use the original packing materials. If the spectrum analyzer is packed in other materials, observe the following packing procedure:

- (1) Wrap the spectrum analyzer in a plastic sheet or similar material.
- (2) Use a cardboard, wooden box, or aluminum case which allows shock-absorbent material to be inserted on all sides of the equipment.
- (3) Use enough shock-absorbent material to protect the spectrum analyzer from shock during transportation and to prevent it from moving in the container.
- (4) Secure the container with packing straps, adhesive tape or bands.

Transportation

Do not subject the spectrum analyzer to severe vibration during transport. It should be transported under the storage conditions recommended in paragraph 7.2.

SECTION 7 STORAGE AND TRANSPORTATION

APPENDIXES

TABLE OF CONTENTS

APPENDIX A FRONT AND REAR PANEL LAYOUT	A-1
APPENDIX B BLOCK DIAGRAM	B-1

APPENDIX A FRONT AND REAR PANEL LAYOUT

This appendix shows the front and rear panel layout.

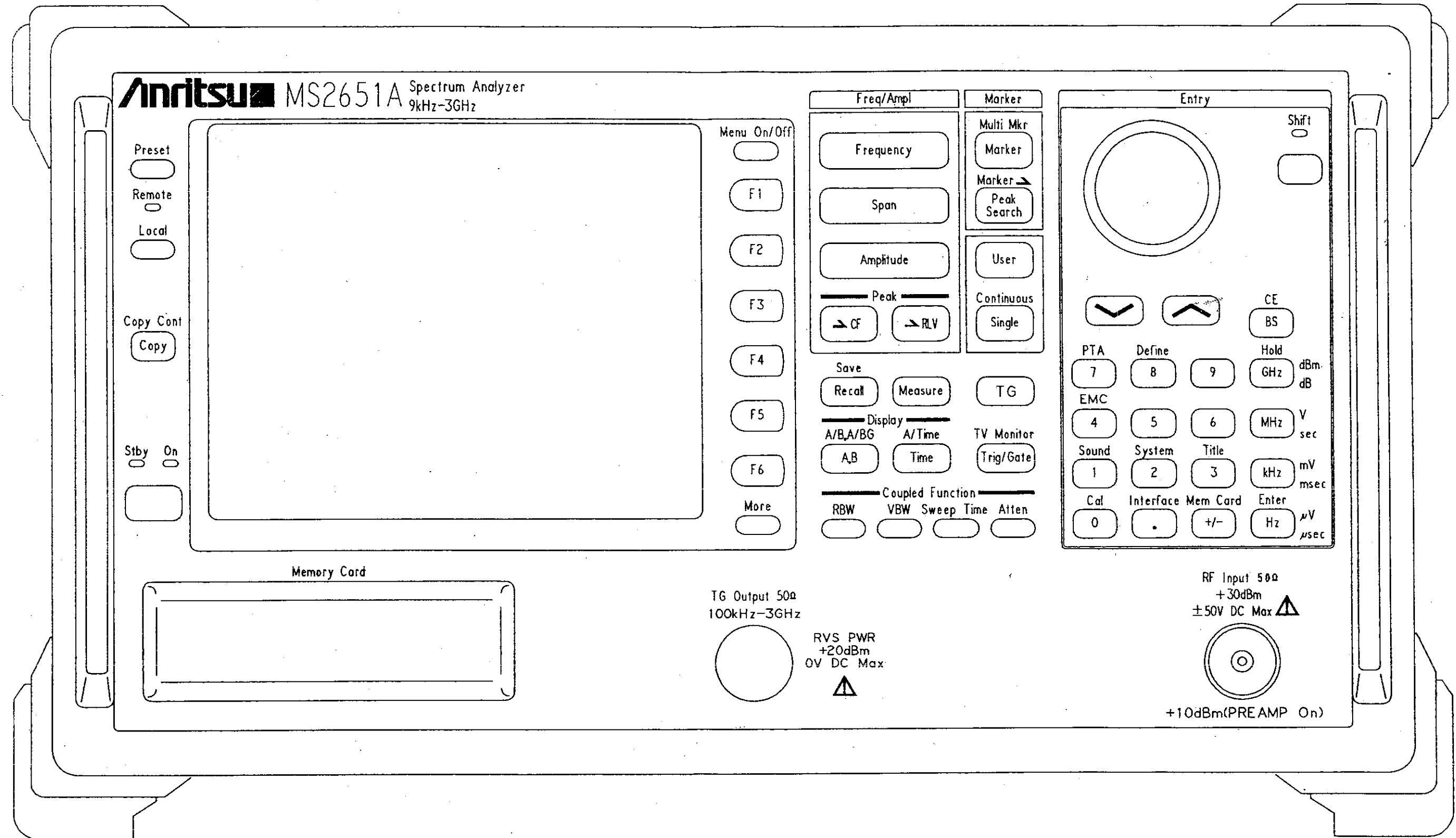

Fig. A-1 MS2651A Front Panel

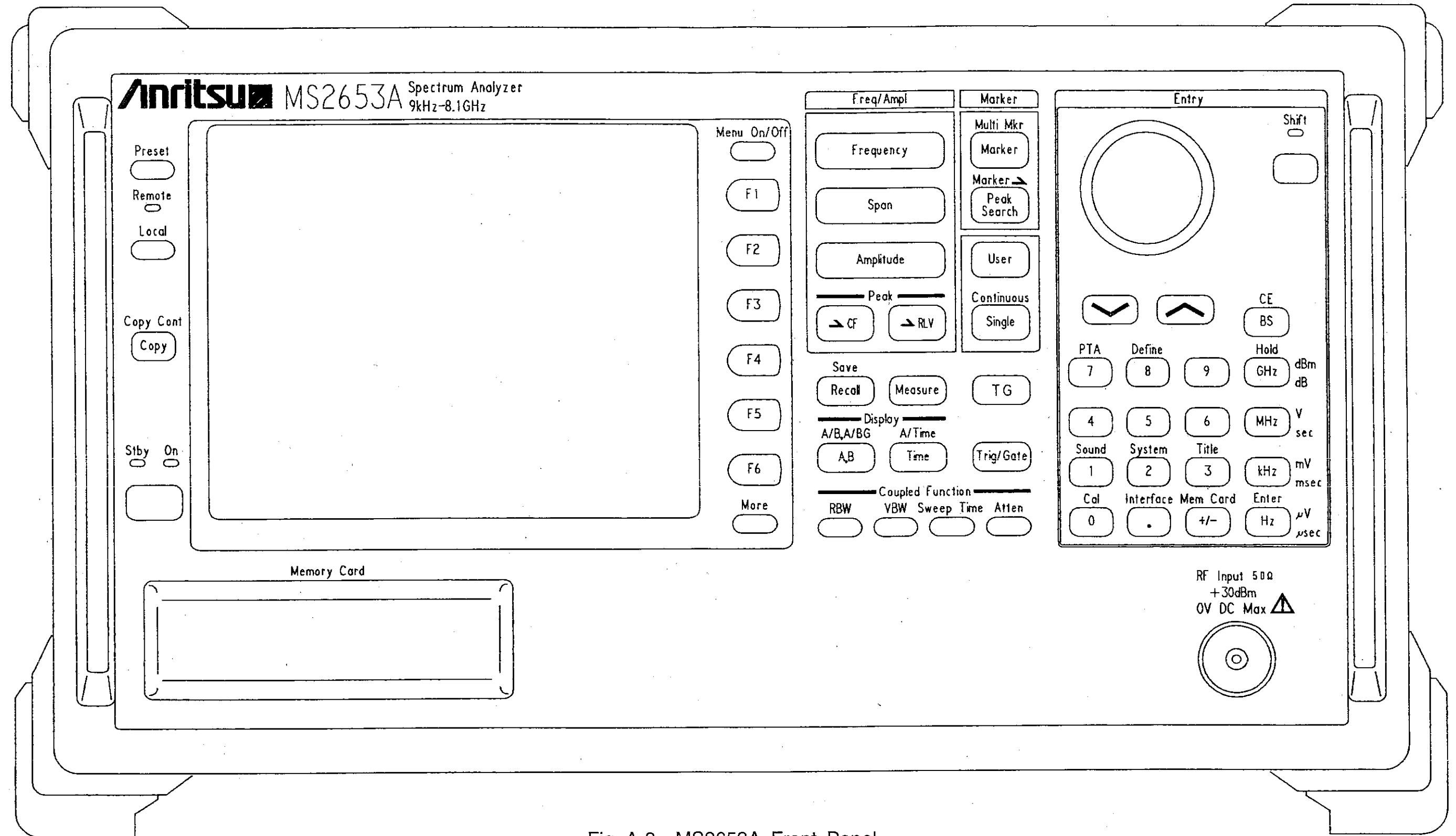

Fig. A-2 MS2653A Front Panel

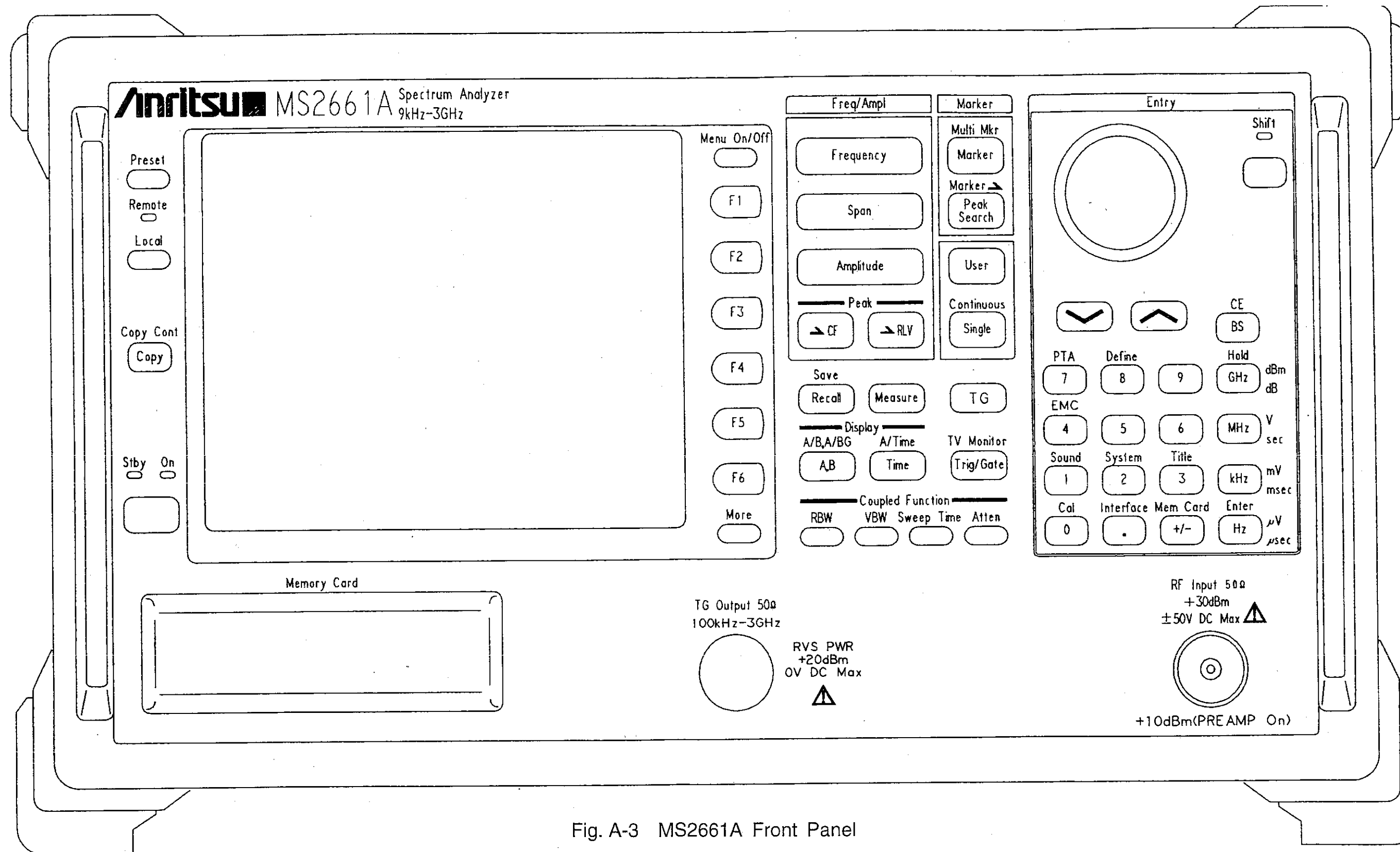

Fig. A-3 MS2661A Front Panel

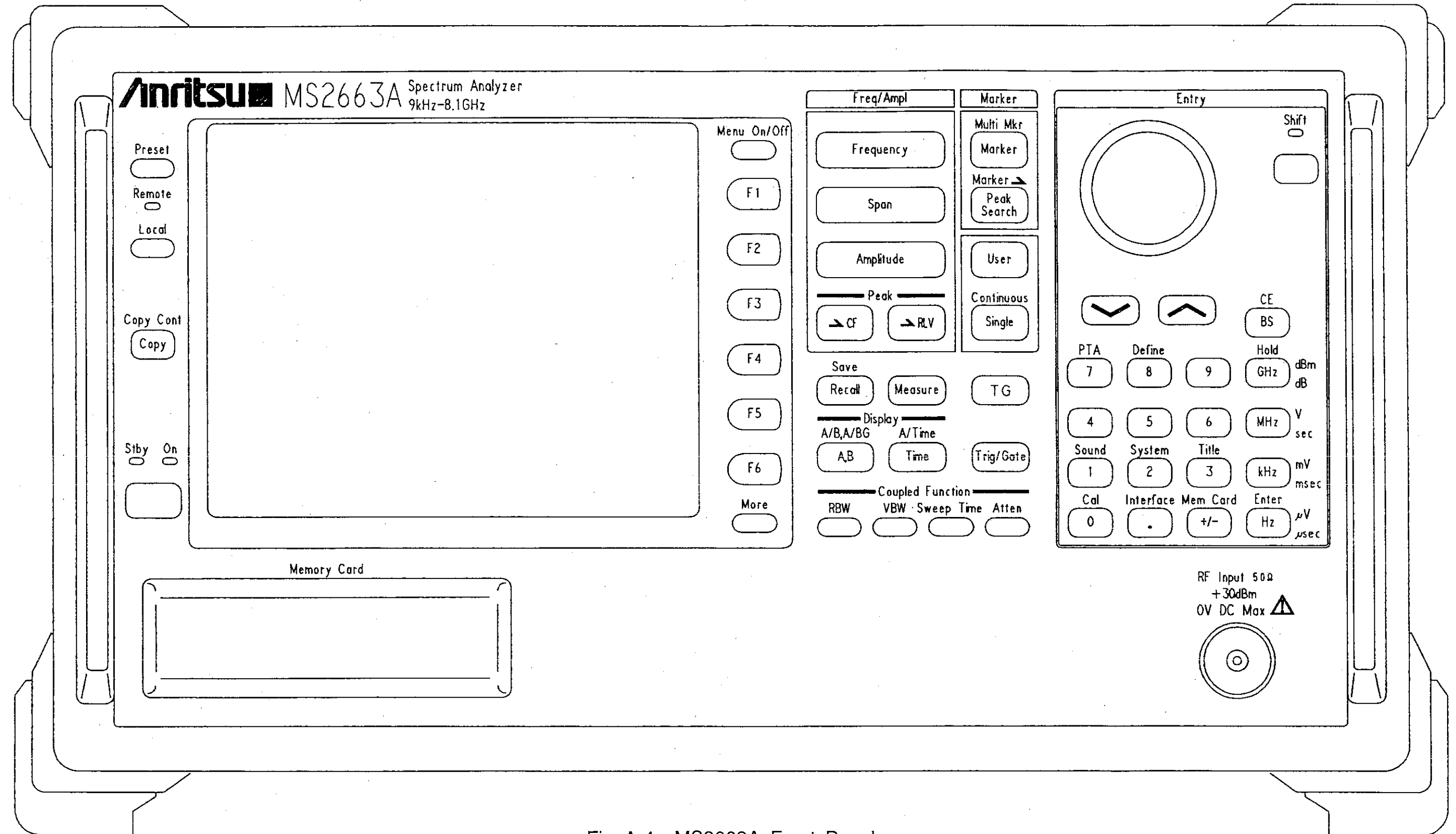
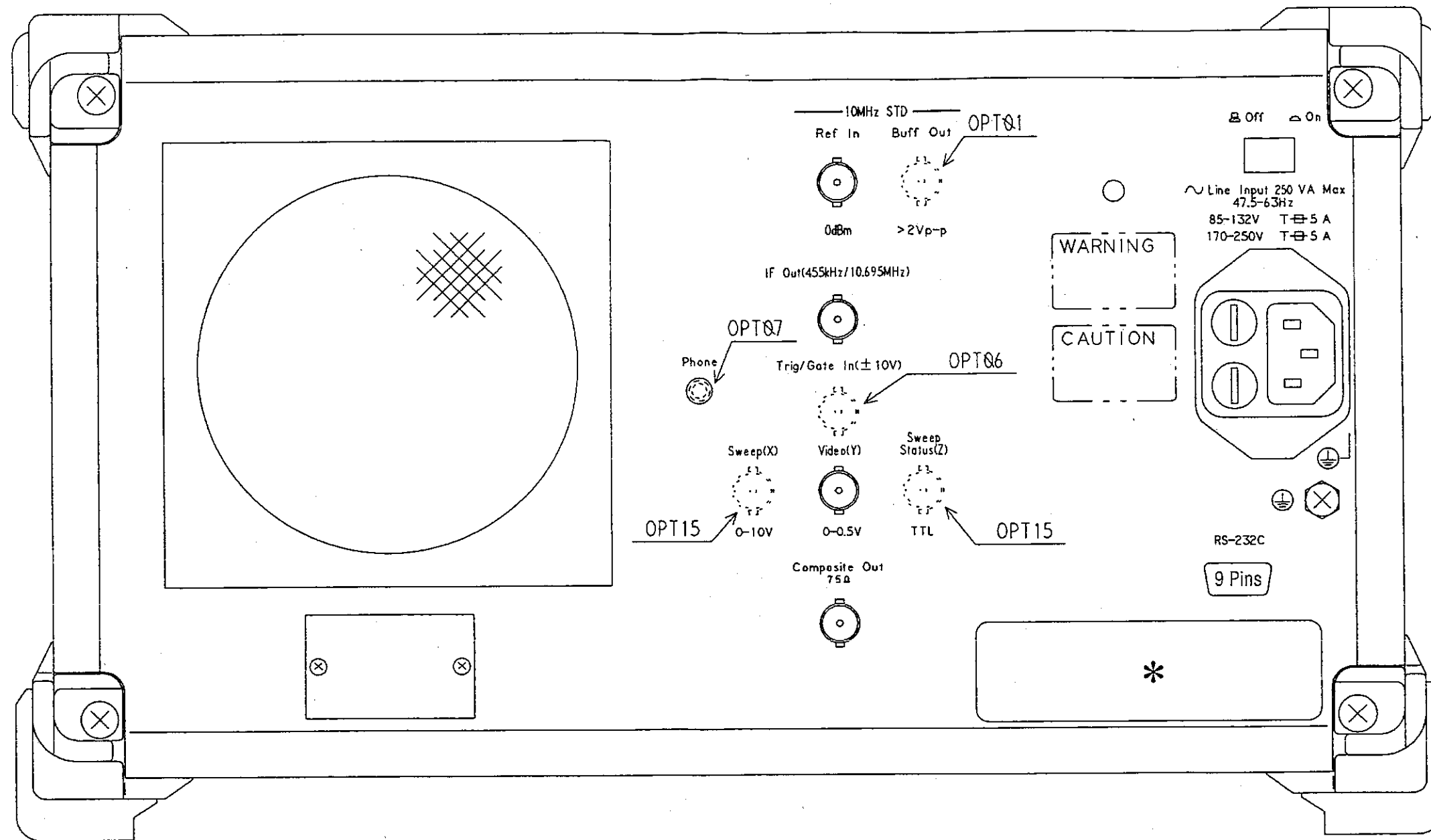

Fig. A-4 MS2663A Front Panel



* : For OPT10

* : For OPT9

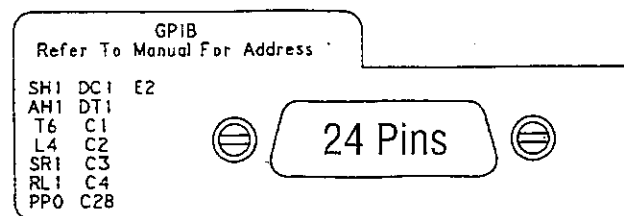
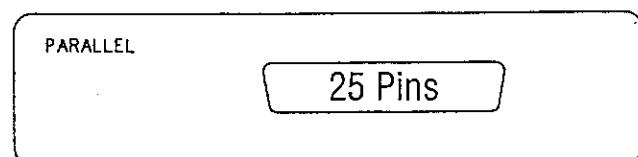

Fig. A-5 Rear Panel (1/2)
(Common to All types)

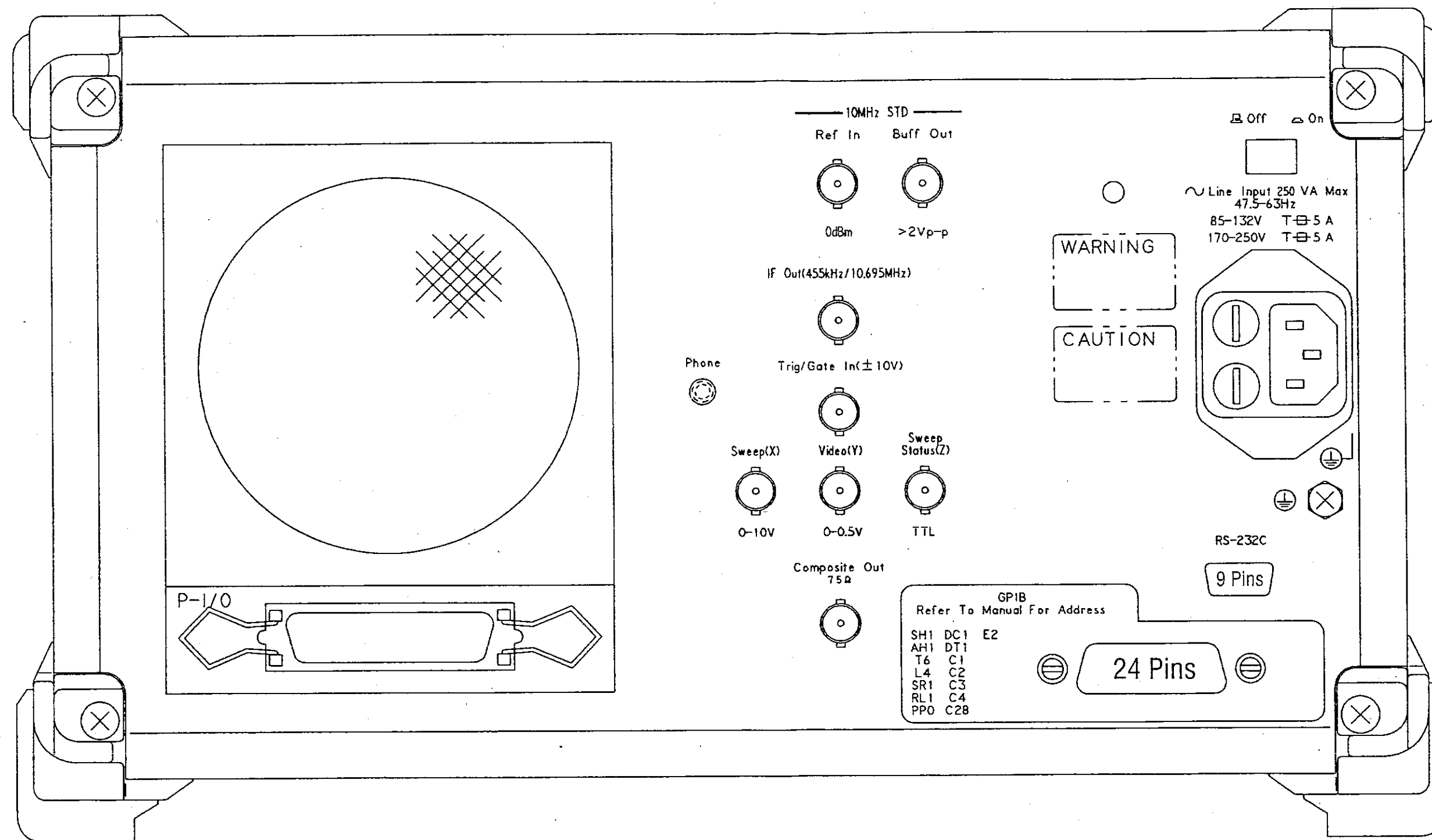
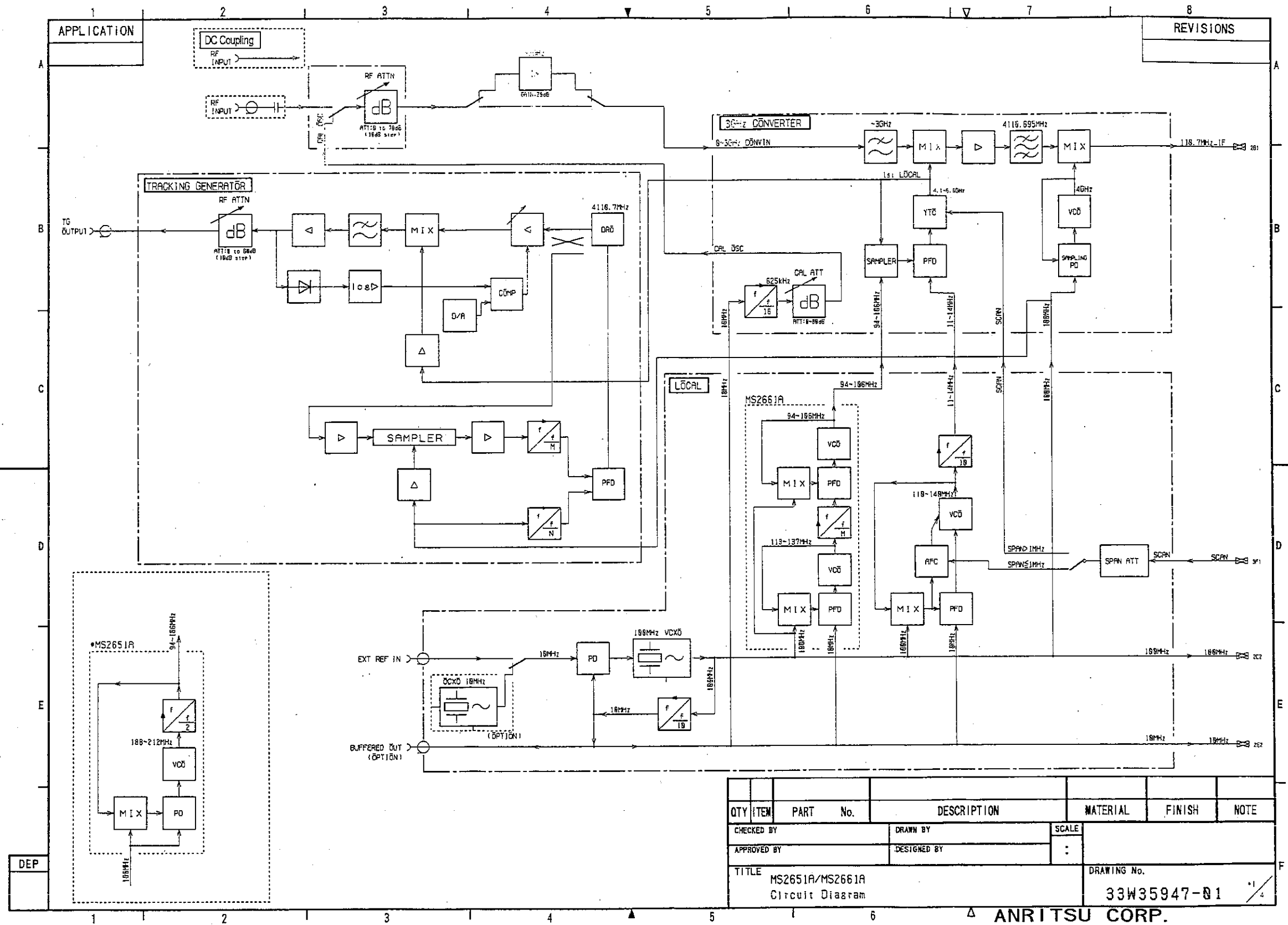

Fig. A-5 Rear Panel (2/2)
(Common to All types)

APPENDIX B BLOCK DIAGRAM

This appendix shows the Block Diagram of the MS2651A/MS2661A and MS2653A/MS2663A.



ANRITSU CORP.

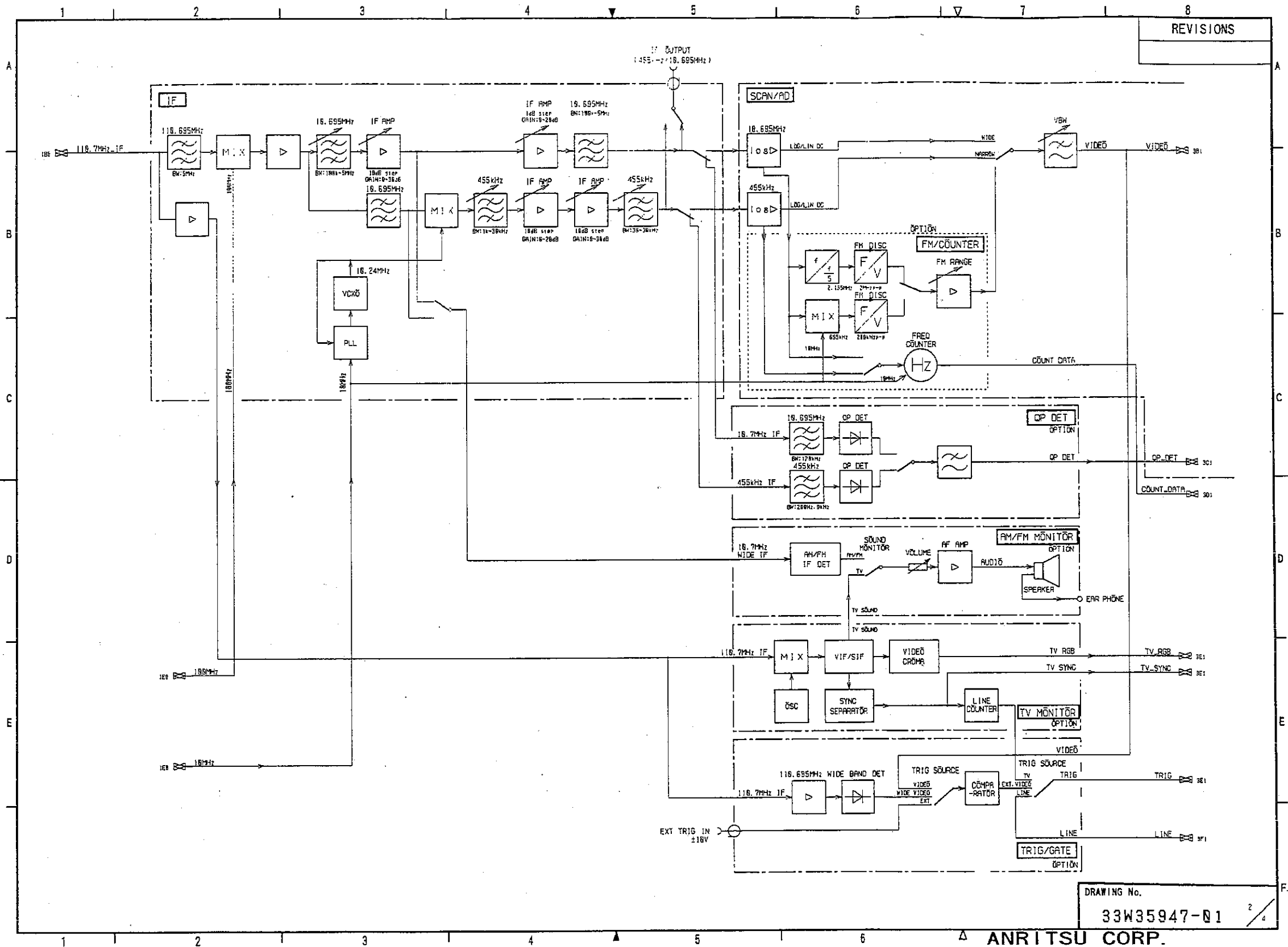

REVISIONS

DRAWING No. 33W35947-01

ANRITSU CORP.

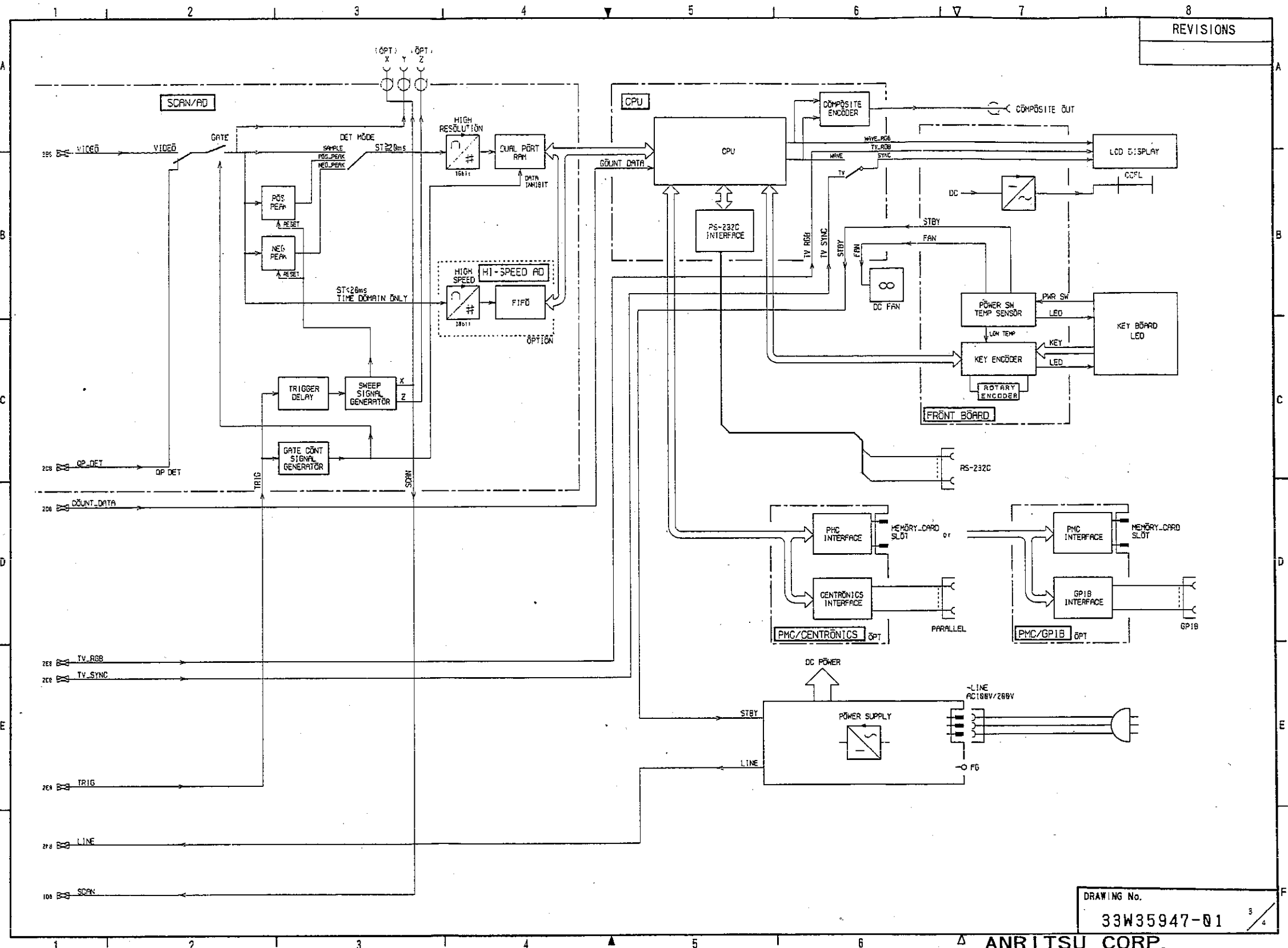

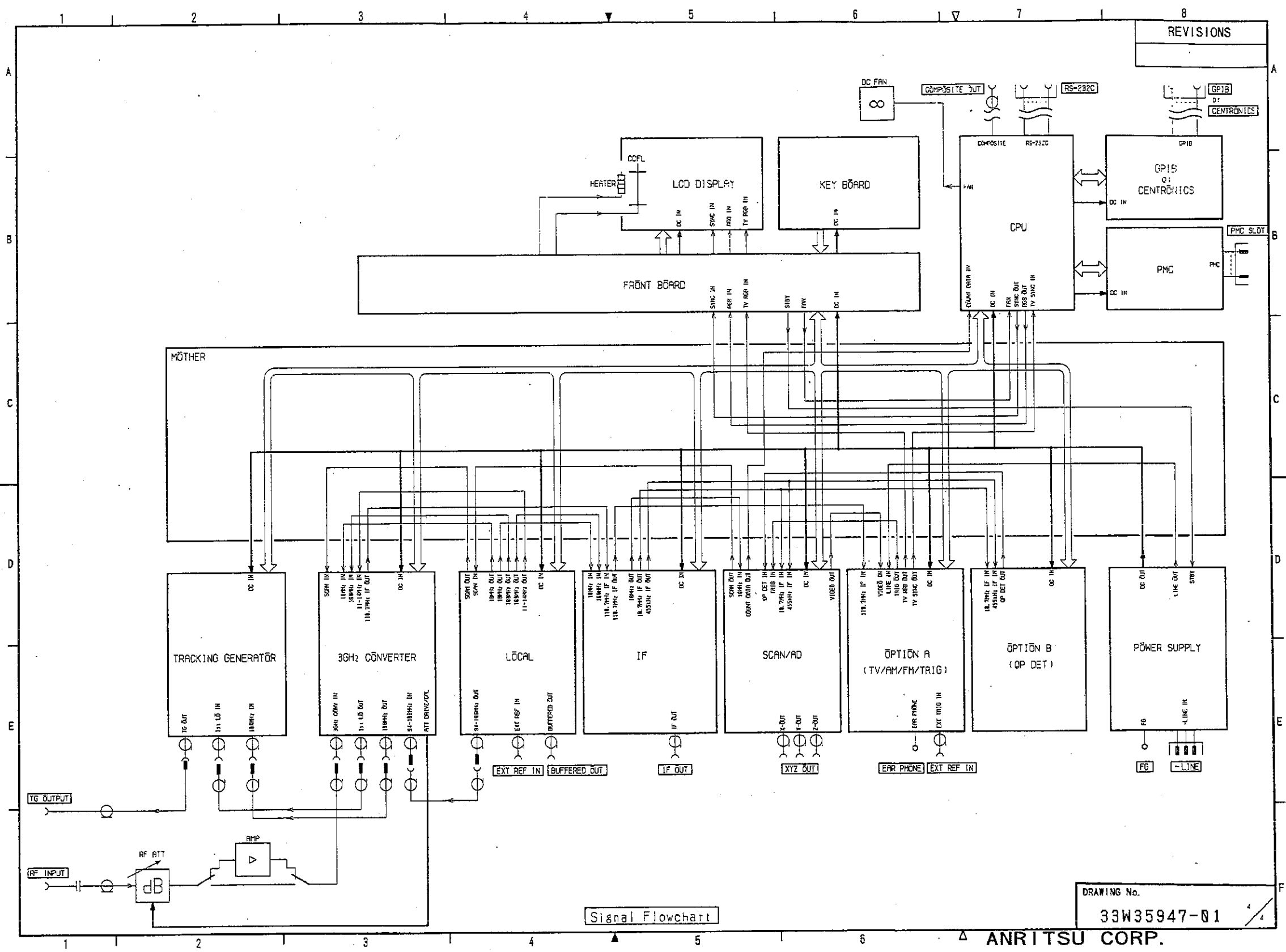

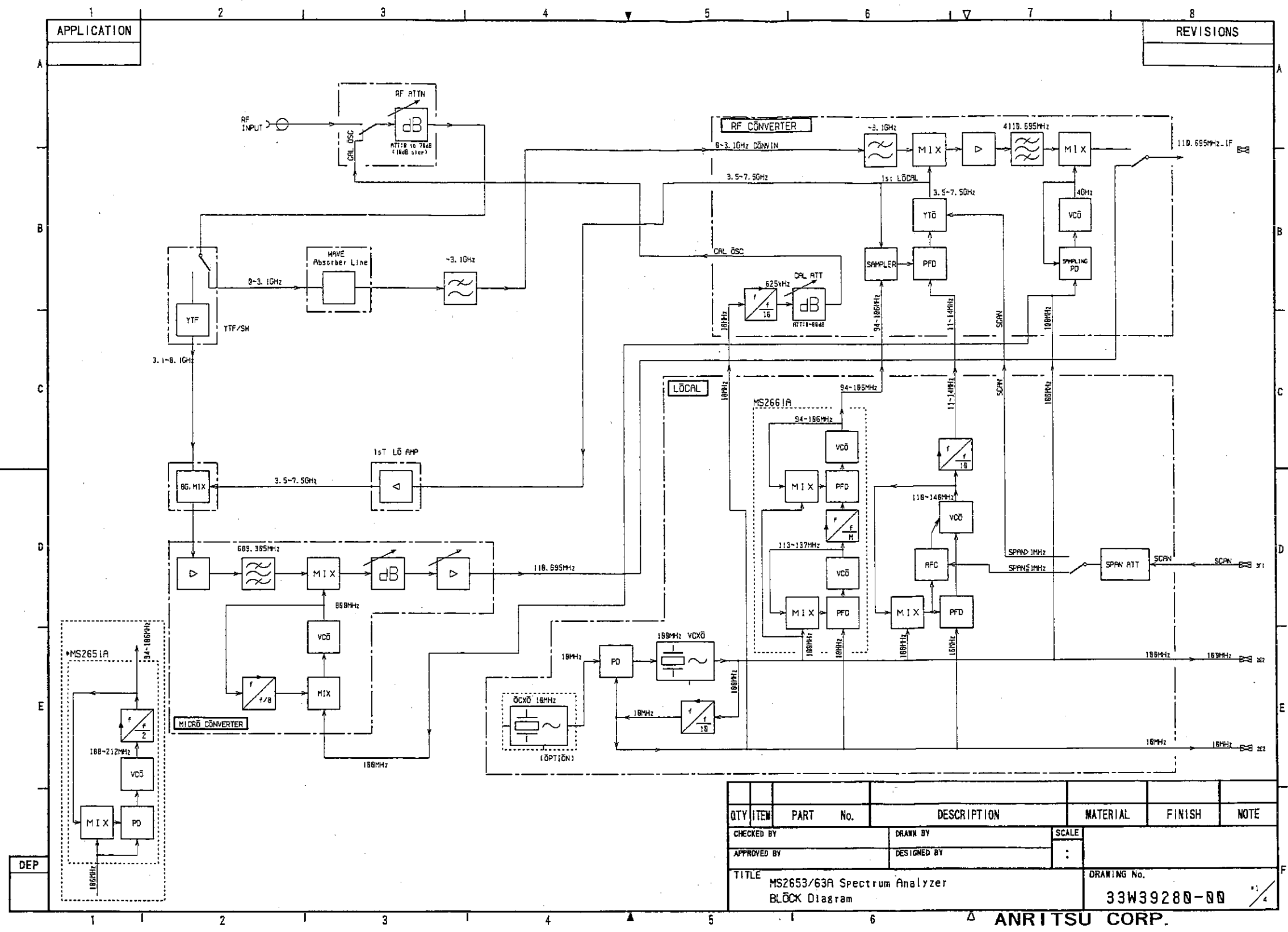

QTY	ITEM	PART No.	DESCRIPTION	MATERIAL	FINISH	NOTE
CHECKED BY		DRAWN BY		SCALE		
APPROVED BY		DESIGNED BY				
TITLE				DRAWING No.		
MS2653/63A Spectrum Analyzer				33W39280-00		1/4
BLOCK Diagram						

ANRITSU CORP.

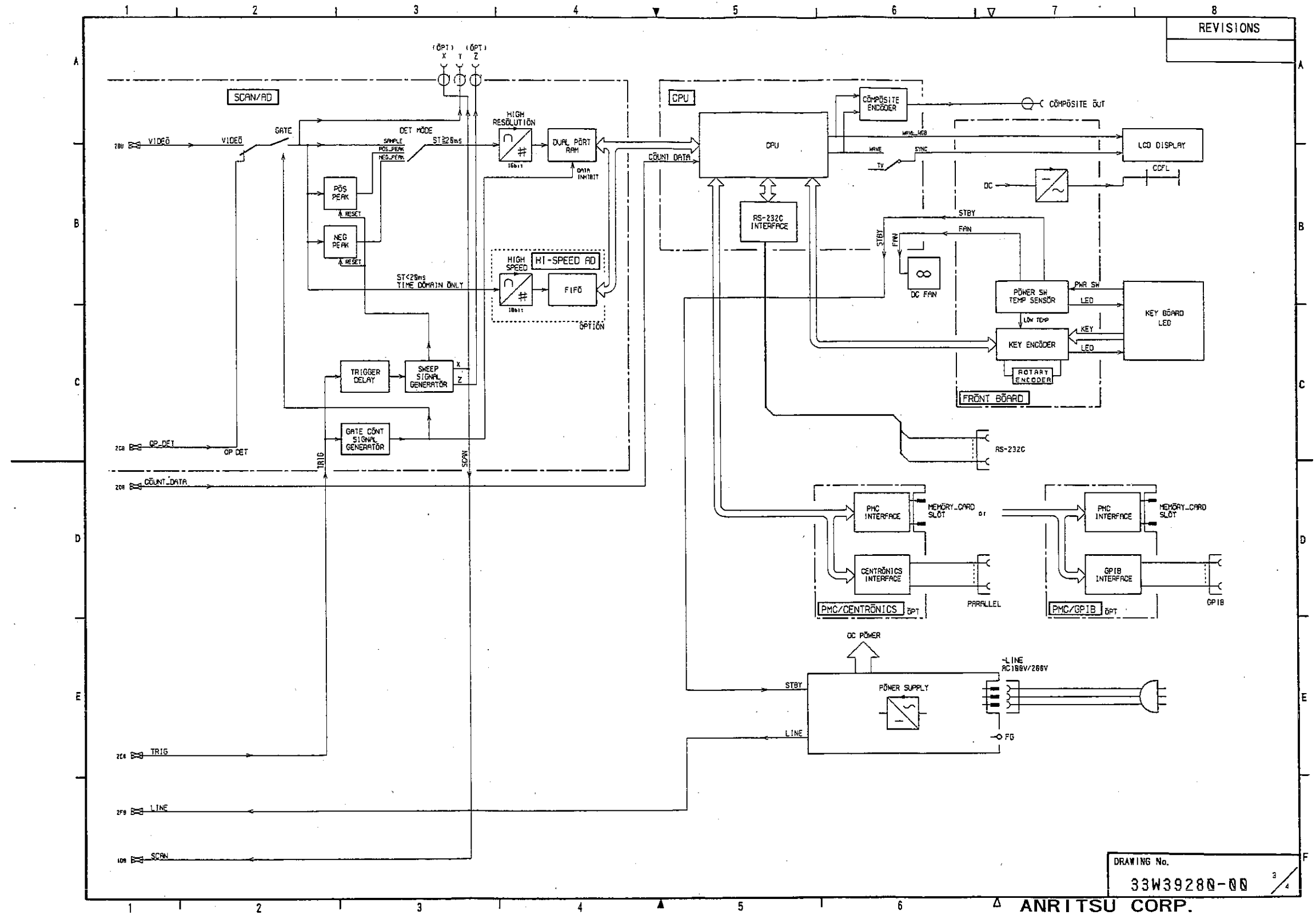

DRAWING No.
33W39280-00

ANRITSU CORP.

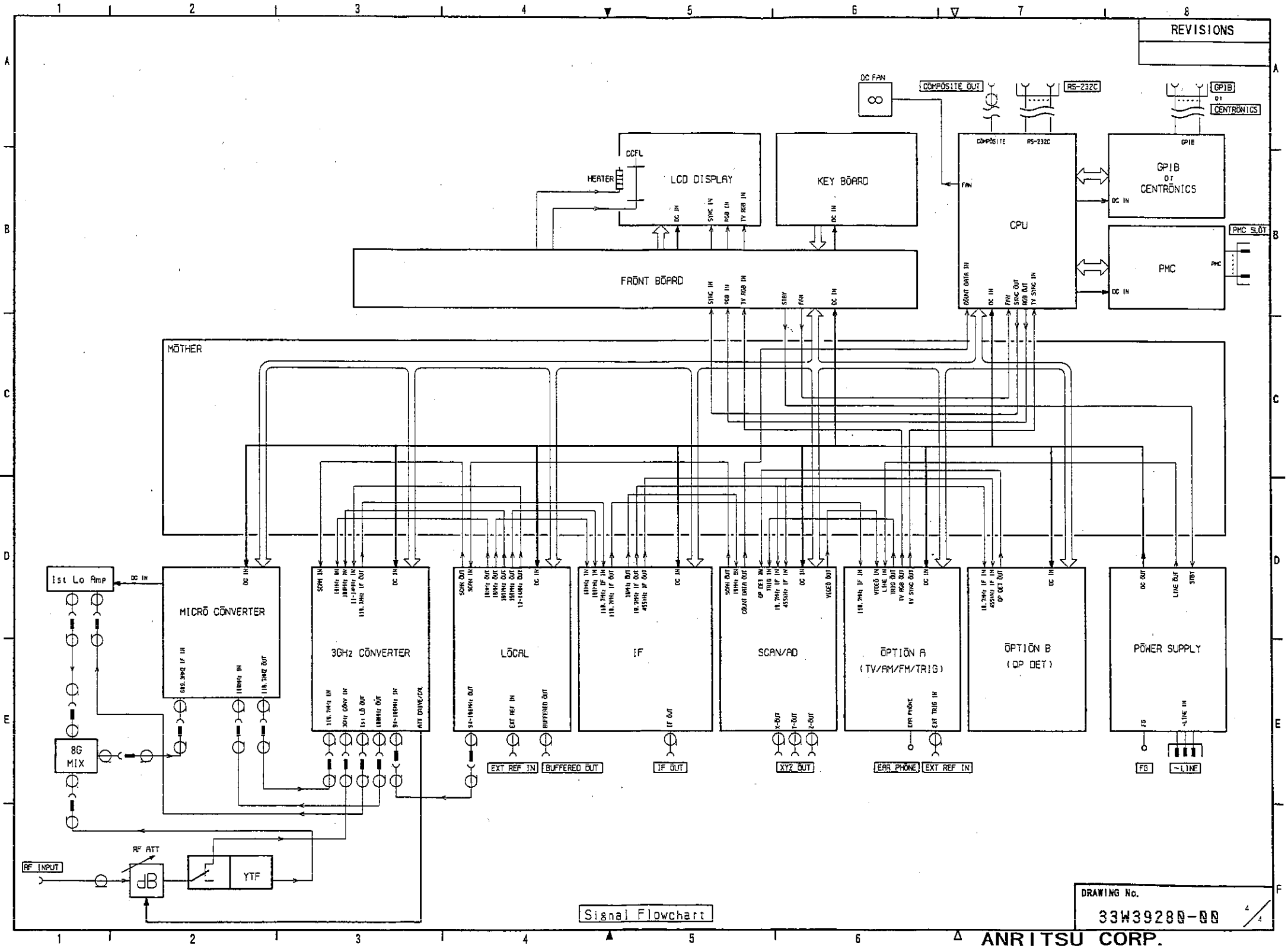

DRAWING No. 33W39280-00

ANRITSU CORP.

Head office address was changed

Head office address on the back cover was changed. Please substitute it as the following address.

Anritsu Corporation

1800 Onna, Atsugi-shi, Kanagawa, 243-8555, Japan

TEL: +81-46-223-1111

Anritsu Service and Sales offices



• Argentina

MULTIRADIO S.A.

Av. Cordoba, 4860 Buenos Aires,
C1414BAT, Argentina
TEL: +55-4779-5522
FAX: +55-4779-5510

• Brazil

ANRITSU ELETRÔNICA LTDA.

Praca Amadeu Amaral, 27-1 andar
01327-010-Paraiso, Sao Paulo, Brazil
TEL: +55-11-3283-2511
FAX: +55-11-2886940

ANRITSU ELETRÔNICA LTDA.

Praia de Botafogo, 440-24 andar-Botafogo
22250-040, Rio de Janeiro, RJ, Brazil
TEL: +55-21-2527-6922
FAX: +55-11-2537-1456

• Canada

ANRITSU ELECTRONICS LTD.

(HEADQUARTERS IN OTTAWA OFFICE)

700 Silver Seven Road, Suite 120, Kanata,
Ontario K2V 1C3, Canada
Toll free: 1-800-ANRITSU (267-4878)
TEL: +1-613-591-2003
FAX: +1-613-591-1006

ANRITSU ELECTRONICS LTD.

(VANCOUVER OFFICE)

300-1055 W Hastings St., Vancouver, BC
V6E 2E9, Canada
Toll free: +1-877-267-4878
TEL: +1-604-682-5933
FAX: +1-604-682-5934

ANRITSU ELECTRONICS LTD.

(TORONTO OFFICE)

2810 Matheson Blvd. E, 2nd Fl.,
Mississauga, ON L4W 4X7, Canada
Toll free: +1-877-267-4878
TEL: +1-905-890-7799
FAX: +1-905-625-5864

• Chile

SISTEMAS DE INSTRUMENTACION LTDA.

Concha y Toro 65, Stgo Centro
Santiago, Chile 51880
TEL: +56-2-6960031
FAX: +56-2-6969665

• Colombia

RENTAMETRIC LTDA.

Calle 24 No. 32-67, Apartado: 23030
Santafe de Bogota, D.C. Colombia
TEL: +57-1-269-6555
FAX: +57-1-269-0191

• Costa Rica

SONIVISION, S.A.

P.O. Box 620-1000, San Jose, Costa Rica
TEL: +506-231-5685
FAX: +506-231-6531

• Ecuador

EQUITRONICS S.A.

Belgica N-32 Hy Av. De Los Shyris,
Edificio IVSEMON PARK, Suite 4B, Quito,
Ecuador
TEL: +593-2-255-396
FAX: +593-2-255-396

• El Salvador

EMPRESA DE COMERCIO EXTERIOR S.A. DE C.V.

Centro Comercial Feria Rosa, Alameda
Dr. Manuel Enrique Araujo, Edificio H,
Local 315 San Salvador, El Salvador
TEL: +503-243-3924
FAX: +503-243-3925

• Guatemala

IMPELSA.

4a Calle 1-15 Zong 10 Guatemala, C.A.
01010, Guatemala
TEL: +502-360-5135
FAX: +502-360-5217

• Mexico

SIHIKATRONICS mmWAVE S.A. DE C.V.

Luz Saviñon 9-701, Col. Del Valle, C.P.
03100, Mexico, D.F., Mexico
TEL: +52-5-5437313
FAX: +52-5-5437317

• Paraguay

DATALAB S.R.L.

Avda. Artigas No 1645 Edificio "DataLab"
Asuncion, Paraguay
TEL: +595-21-20-9126
FAX: +595-21-20-9127

• Peru

ELETELSE S.A.

AV Canaval Moreyra 748, San Isidro,
Lima 27, Peru
TEL: +51-1-224-2514
FAX: +51-1-224-8148

• U.S.A.

ANRITSU COMPANY

1155 East Collins Blvd., Richardson, TX
75081, U.S.A.
Toll Free: +1-800-ANRITSU (267-4878)
TEL: +1-972-644-1777
FAX: +1-972-644-3416

ANRITSU COMPANY

490 Jarvis Drive, Morgan Hill, CA 95037,
U.S.A.
Toll Free: +1-800-ANRITSU (267-4878)
TEL: +1-408-778-2000
FAX: +1-408-778-3180

ANRITSU COMPANY

10 New Maple Ave., Unit 305,

P.O. Box 836, Pine Brook, NJ 07058-0836
U.S.A.

Toll Free: +1-800-ANRITSU (267-4878)
TEL: +1-973-227-8999
FAX: +1-973-575-0092

ANRITSU COMPANY

SALES AND SERVICE, FL OFFICE

312 W. First Street, Suite 300, Sanford,
FL 32771, U.S.A.
Toll Free: 1-800-ANRITSU (267-4878)
TEL: +1-407-321-5130
FAX: +1-407-330-2018

ANRITSU COMPANY

SALES AND SERVICE, GA OFFICE

4625 Alexander Drive, Alpharetta,
GA 30022, U.S.A.
Toll Free: 1-800-ANRITSU (267-4878)
TEL: +1-678-566-0454
FAX: +1-678-566-1776

• Uruguay

CABONORTE S.A.

Colonia 1900, Esc. 603, Montevideo;
Uruguay
TEL: +598-2-430522
FAX: +598-2-418594

• Venezuela

RADIOCOMUNICACIONES CRUZ, C.A.

Calle La Colina Quinta. Elison, Frente al
teatro Alberto Mateo Caracas 1050,
Venezuela
TEL: +58-2-793-2322
FAX: +58-2-793-3429



• Austria

WIEN-SCHALL GmbH

Krichbaumgasse 25, A-1120 Vienna,
Austria
TEL: +43-1-81155140
FAX: +43-1-81155180

• Belgium

ANRITSU GmbH

Grafenberger Allee 54-56, 40237
Düsseldorf, Germany
Local phone: 0800-90001 (toll free)
TEL: +49-211-96855-0
FAX: +49-211-96855-55

• Bulgaria

ELSINCO Representation OFFICE Sofia

h.e. Strelbishte, str. Kotlenski Prohod,
bl. 96/6/14, BG-1408 Sofia, Bulgaria
TEL: +359-2-958-1245
FAX: +359-2-958-1698

• **Croatia**

**ELSINCO REPRESENTATION OFFICE
ZAGREB**

Savska 66 HR-10000 Zagreb, Croatia
TEL: +385-1-6312-477
FAX: +385-1-6312-488

• **Czech Republic**

ELSINCO PRAHA SPOL S.R.O.

Novodvorská 994, CZ-142 21 Praha,
4-Branik, Czech Republic
TEL: +420-2-4149-0147
FAX: +420-2-4447-2169

ELSINCO PRAHA SPOL S.R.O.

(BRNO BRANCH OFFICE)

Strmá 19, CZ-616 00 Brno, Czech
Republic
TEL: +420-5-4142-7211
FAX: +420-5-4142-7219

• **Denmark**

INSTRUMENTS A/S

Lokesalle 30, DK-8700 Horsens, Denmark
TEL: + 45 75646500
FAX: + 45 75643700

• **Finland**

ANRITSU AB

(FINLAND BRANCH OFFICE)

Piispanportti 9, FIN-02240 Espoo, Finland
TEL: +358-9-435-522-0
FAX: +358-9-435-522-50

• **France**

ANRITSU S.A.

9 Avenue du Québec, ZA Courtabœuf 1
91951 LES ULIS CEDEX, France
TEL: +33 1 60 92 15 50
FAX: +33 1 64 46 10 65

ANRITSU S.A.

(TOULOUSE OFFICE)

Bureau de Toulouse Région Centre Sud
Ouest, France
TEL: +33-5-62070484
FAX: +33-5-62070668

ANRITSU S.A.

(TOULON OFFICE)

Bureau de Toulon Région Centre Sud Est,
France
TEL: +33-4-94040264
FAX: +33-4-94040265

ANRITSU S.A.

(RENNES OFFICE)

Bureau de Rennes Région Ouest, France
TEL: +33-2-99521214
FAX: +33-2-99521224

• **Germany**

ANRITSU GmbH

Grafenberger Allee 54-56, 40237
Düsseldorf, Germany
TEL: +49-211-96855-0
FAX: +49-211-96855-55

• **Greece**

KOSTAS KARAYANNIS SA

58 Kapodistriou str, GR-142 35 Nea Ionia,
Athens, Greece
TEL: +30-1-680-0460-4
FAX: +30-1-685-3522

• **Hungary**

ELSINCO BUDAPEST KFT

Pannónia utca 8. IV/l., H-1136 Budapest,
Hungary
TEL: +36-1-339-0000
FAX: +36-1-339-4444

• **Ireland**

PEMA LTD.

Dromiskin, Dundalk, Co. Louth, Ireland
TEL: +353-42-72899
FAX: +353-42-72376

• **Italy**

ANRITSU S.P.A.

Via Elio Vittorini 129, 00144 Roma, Italy
TEL: +39-06-509-9711
FAX: +39-06-502-2425

ANRITSU S.P.A.

Via Paracelso 4, CD Colleoni, Agrate
Brianza, 20041 Milano, Italy
TEL: +39-039-657021
FAX: +39-039-6056396

• **Norway**

BLOMKVIST AS

Pb 188, 1371 ASKER, Norway
TEL: + 47 66901190
FAX: + 47 66901212

• **Poland**

ELSINCO POLSKA SP. Z.O.O

ul Gdanska 50, 01-691 Warszawa, Poland
TEL: +48-22-39-832-4042 (Sat Link)
FAX: +48-22-832-2238

• **Portugal**

OMNITECNICA S.A.

Estrada de Alfragide 23, 2720-015
Amadora, Portugal
TEL: +351-21-472-12-00
FAX: +351-21-472-12-70 (Sales)

• **Slovakia**

ELSINCO SLOVENSKO S.R.O

Kudlákova 4, SK-844 15 Bratislava,
Slovakia
TEL: +421 7 6428 41 65
FAX: +421 7 6428 44 54

ELSINCO SLOVENSKO S.R.O

(KOŠICE BRANCH OFFICE)

Floriánska 16, SK-043 13 Kosice, Slovakia
TEL: +421 95 62 26 729
FAX: +421 95 62 26 729
CONTACT: Mr. Igor Domorak,
Branch Office Manager

• **Slovenia**

ELSINCO D.O.O.

Dalmatinova 2, SI-1000 Ljubljana,
Slovenia
TEL: +386-61-133-62-77
FAX: +386-61-317-397

• **Sweden**

ANRITSU AB

Botvid Center, Fittja Backe 1-3 S-145
84, Stockholm, Sweden
TEL: +46-8-534-70700
FAX: +46-8-534-70730

• **United Kingdom**

ANRITSU LTD.

200 Capability Green, Luton, Bedfordshire,
LU1 3LU, U.K.
TEL: (Sales) + 44-1582-433280
(Service) +44 1582-433285
FAX: +44 1582-731303



• **Australia**

ANRITSU PTY LTD.

Unit 3/170 Forster Road, Mount. Waverley,
Vic., 3149, Australia
TEL: +61-3-9558-8177
FAX: +61-3-9558-8255

• **Bahrain**

BASMATECH

P. O. Box 5701, Manama, Bahrain
TEL: +973-273729
FAX: +973-725404

• **China**

ANRITSU COMPANY LTD.

Suite 923, 9/F., Chinachem Golden Plaza
77 Mody Road, Tsimshatsui East,
Kowloon, Hong Kong
TEL: +852-2301-4980
FAX: +852-2301-3545

ANRITSU COMPANY LTD.

(BEIJING REPRESENTATIVE OFFICE)

Room 1515, Beijing Fortune Building
No. 5 North Road, the East 3rd Ring Road,
Chao-Yang District, Beijing 100004
P.R. China
TEL: +86-10-6590-9230
FAX: +86-10-6590-9235

ANRITSU COMPANY LTD.

(SHANGHAI OFFICE)

Room 1807-1810, Tower A CITY CENTER
of Shanghai
No. 100 ZunYi Road 200051 P.R.China
TEL: +86-021-6237-0898
FAX: +86-021-6237-0899

ANRITSU COMPANY LTD.
(GUANGZHOU REPRESENTATIVE OFFICE)
Room 3008-9, Dongshan Plaza, 69 Xian Lie Zong Road Central, Guangzhou 510095, P.R. China
TEL: +86-20-8732 2231/2
FAX: +86-20-8732 2230

ANRITSU COMPANY LTD.
(CHENGDU REPRESENTATIVE OFFICE)
26E New Times Square, No. 42, Wenwu Road, Xinhua Street, Chengdu 610017 P.R. China
TEL: +86-28-8651 0011/22/33
FAX: +86-28-8651 0055

ANRITSU COMPANY LTD.
(XI'AN REPRESENTATIVE OFFICE)
No.1102, ZhiCheng Building, No.2 Gao Xin I Road, High-Tech, Development Zone, Xi'an 710075, P.R. China
TEL: +86-29-8377 406/9
FAX: +86-29-8377 410

ANRITSU COMPANY LTD.
(SHENZHEN REPRESENTATIVE OFFICE)
Room 1505, Building A
World Trade Plaza, Fuhong Road
Shenzhen 518033, P.R. China
TEL: +86-755-8366 2847/2851/2852
FAX: +86-755-8366 2849

ANRITSU COMPANY LTD.
(CHONG QING REPRESENTATIVE OFFICE)
Rm.6-2, D Building, Kejjfazhan Plaza No.210, Keyuan 1st Road, Gaoxin District Shiqiaopu, Chongqing 400010 P.R. China
TEL: +86-23-8909-9918
FAX: +86-23-8909-9928

ANRITSU ELECTRONICS (SHANGHAI) CO., LTD. (SERVICE CENTER)
2F, Room B, 52 Section Factory Building No. 516 Fu Te North Road Waigaoqiao Free Trade Zone Pudong, Shanghai 200131, P.R. China
TEL: +86-21-5868-0226/7/8
FAX: +86-21-5868-0588

ANRITSU COMPANY LTD.
(SHENYANG REPRESENTATIVE OFFICE)
2-185, City Plaza, No. 206, Nanjing North Street, He Ping District, Shenyang 110001 P.R. China
TEL: +86-24-2334 1178/89
FAX: +86-24-2334 2838

ANRITSU COMPANY LTD.
(WUHAN REPRESENTATIVE OFFICE)
A1803, ZhongShang Plaza No. 7, Zhongnan Road Wuchang, Wuhan 430071, P.R. China
TEL: +86-27-8771 3355
FAX: +86-27-8732 2773

• **Cyprus**
CHRIS RADIOVISION LTD.
23 Crete Street, T.T. 1061
P. O. Box 21989, 1515Nicosia, Cyprus
TEL: +357-2-766121
FAX: +357-2-765177

• **Egypt**
GIZA SYSTEMS ENGINEERING S.A.E
17 Teeba Street Mohandeseen P.O. Box 317 Dokki-Cairo 12311, Egypt
TEL: +20-2-3368095
FAX: +20-2-3385799

• **Indonesia**
PT. SUBUR SAKTI PUTERA
Graha Astri Aniela Angun, Jl. Tanah Abang III/15, Jakarta 10160, Indonesia
TEL: +62-21-352-4828
FAX: +62-21-352-4831

• **Israel**
TECH-CENT LTD.
P. O. Box 43259 (Mailing Address),
Tel-Aviv 61430 Israel, Street Address:
Raul Valenberg 4 Ramat Haahayal, Tel-Aviv 69710, Israel
TEL: +972-36-478563
FAX: +972-36-478334

• **Korea**
ANRITSU CORPORATION, LTD.
8F HyunJuk Building, 832-41
Yeoksam-Dong, Kangnam-Ku, Seoul 135-080
Korea
TEL: +82-2-553-6603
FAX: +82-2-553-6604
ANRITSU CORPORATION, LTD.
Room 1503, Dong-A Venture Tower 538-8
BongMyung-Dong, Yusong-Gu
Daejeon, 305-301
Korea
TEL: +82-42- 828-7783
FAX: +82-2-42-828-7785

• **Kuwait**
TAREQ COMPANY
P.O. Box 20506 Safat, 13066 Safat,
Kuwait
TEL: +965-431-0615
FAX: +965-431-4085

• **Malaysia**
O'CONNOR'S ENGINEERING SDN BHD
3rd Floor Bangnan O'Connor, 13 Jalan 223, 46100 Petaling Jaya,
Selangor Darul Ehsan, Malaysia
TEL: +60-3-753-8400
FAX: +60-30-757-7871

• **Morocco**
SEDEL
24, 26, Bd, Resistance, Casablanca,
Morocco

TEL: +212-2-302444
FAX: +212-2-449311

• **Nepal**
BR INTERNATIONAL PVT. LTD.
P. O. Box 60, Tamrakar Comm. Bldg.,
Bhotebahal Kathmandu, Nepal
TEL: +977-1-224-706
FAX: +977-1-227-956

• **New Zealand**
NILSEN TECHNOLOGIES (AUCKLAND OFFICE)
P. O. Box 9613, New market Unit 4,
Ambury Court, 1 Porters Ave, Eden
Terrace Auckland, New Zealand
TEL: +64-9-309-2464
FAX: +64-9-309-2968

NILSEN TECHNOLOGIES (WELLINGTON OFFICE)
35 Ulric Street, Plimmerton Wellington,
New Zealand
TEL: +64-4-233-9116
FAX: +64-4-233-8366

• **Oman**
NATIONAL PROJECTS AND TECHNOLOGY COMPANY L.L.C
P. O. Box 97, Wadi Al Kabir, Postal Code 117, Sultanate of Oman
TEL: +968-793741
FAX: +968-796158

• **Pakistan**
AETCO
Zia Chambers, 25-Mcleod road, Lahore 54000, Pakistan
TEL: +92-42-7221716, 7311035
FAX: +92-42-7221456

SUPERIOR ELECTRONICS ASSOCIATED
B-98 Block H, North Nasimabad,
Karachi-33, Pakistan
TEL: +92-21-613655

• **Philippines**
SALRITSU INTERNATIONAL TRADING CORPORATION
5QB ODC International Plaza
Condominium, 219 Salcedo St., Legaspi
Village, Makati City 1229, Philippines
TEL: +632-816-2646, 893-8998
FAX: +632-815-0986

• **Puerto Rico**
CARIBBEAN DATA SYSTEM
636, San Patricio Ave. San Juan,
PR00920-4507, Puerto Rico
TEL: +1-787-774-6969
FAX: +1-787-774-6973

• Qatar

QATAR COMMUNICATIONS LTD.
P. O. Box 2481, Doha Qatar
TEL: +974-4-424347
FAX: +974-4-324777

• Saudi Arabia

A. RAJAB & A. SILSILAH & CO.
P. O. Box 203, Jeddah 21411, Saudi Arabia
TEL: +966-2-6610006
FAX: +966-2-6610558
ELECTRONIC EQUIPMENT MARKETING CO.
P. O. Box 3750, Riyadh, 11481, Saudi Arabia
TEL: +966-3-887-0218
FAX: +966-3-887-0268

• Singapore

ANRITSU PTE. LTD.
10, Hoe Chiang Road #07-01/02, Keppel Towers, Singapore 089315
TEL: +65-6282-2400
FAX: +65-6282-2533

• South Africa

ETECESA (PTY) LTD.
12 Surrey Square Office Park, 330 Surrey Avenue, Ferndale, 2194 Randburg, South Africa (P. O. Box 4231 Randburg, 2125 South Africa)
TEL: +27-11-787-7200
FAX: +27-11-787-0446

• Sri Lanka

INFOTECHS LIMITED
441, Alwitigala Mawatha, Colombo, Sri Lanka
TEL: +94-1-598237
FAX: +94-1-598112

• Taiwan

ANRITSU COMPANY, INC. (TAIPEI OFFICE)
7F, No. 316, Sec. 1, NeiHu Rd., Taipei, Taiwan
Phone: +886-2-8751-1816
Fax: +886-2-8751-1817
ANRITSU COMPANY, INC. (HSINCHU OFFICE)
11F-3, 270, Sec. 1, Kuang-Fu Rd., Hsinchu, Taiwan
TEL: +886-3-563-6601, 6602, 6603
FAX: +886-3-564-5819

• Thailand

JASMINE TELECOM SYSTEMS CO., LTD.
200 Moo 4, 9th Floor, Chaengwatana Road, Tambon Pakkret, Amphoe Pakkret, Nonthaburi 11120, Thailand
TEL: +66-2-502-3240, 3000
FAX: +66-2-962-2521

• Turkey

INTER INTRADE BILGISAYAR ELEKTRONIK SAN. TIC. A.S.
Egitim Mah. Poyraz Sok., Sadikoglu Is Merkezi 1, No: 11, Kadikoy Istanbul, Turkey
TEL: +90-216-4144758
FAX: +90-216-4144762
TEST
Sehit Adem Yavuz Sokak No. 14/15 06640, Kizilay-Ankara, Turkey
TEL: +90-312-419-3688
FAX: +90-312-419-4099

• United Arab Emirates

UTMOST ELECTRONICS TRADING L.L.C.
(ABU DHABI BRANCH)
P. O. Box: 41175, Abu Dhabi, United Arab Emirates
TEL: +971-2-6458909
FAX: +971-2-6458907

• Vietnam

SYSTEM & TECHNOLOGIES VETNAM LTD.
Unit # B236, Binh Minh Hotel 27 Ly Thai To Str Hanoi, Vietnam
TEL: +84-48.264.728
FAX: +84-49.344.111

• Zimbabwe

MARTWELL ELECTRONICS (PVT) LTD.
P.O. Box CH 857 Chisipite Harare, Zimbabwe
TEL: +263-4-494928
FAX: +263-4-494927



• Japan

ANRITSU CORPORATION
1800 Onna, Atsugi-shi, Kanagawa, 243-8555, Japan
TEL: +81-46-223-1111
FAX: +81-46-296-1264