

INSTRUCTION MANUAL
FOR
MODEL 3010
FUNCTION GENERATOR

BK PRECISION **DYNASCAN**
CORPORATION

6460 W. Cortland Street
Chicago, Illinois 60635

INTRODUCTION

The **B & K-PRECISION** Model 3010 Function Generator is a versatile signal source that can be used in a variety of engineering, industrial, educational and hobbyist applications. The wide frequency range (.1 Hz to 1 MHz) for all functions (sine, square, triangle and TTL output) encompasses subaudible, audio, ultrasonic and RF applications. The continuously variable DC offset control and provision for external VCO control further enhance the versatility of this instrument. The human-engineered case lends itself to bench use as well as easy portability.

SPECIFICATIONS

GENERAL

Basic Outputs	Square, sine, triangle, DC and TTL Square Wave (separate output jack).
Frequency Range	0.1 Hz to 1 MHz in six ranges.
External Frequency Control	VCO; greater than 100:1 on any frequency range (linear). With FREQUENCY dial set at .1, a 0-to-5.5 V ramp input will produce a 100:1 frequency change. Frequency increases with positive voltage.
Maximum Input	± 20 V peak.
Input Impedance	1000 ohms, nominal.

SPECIFICATIONS (All specifications apply with dial scale between 1 and 10)

Dial Accuracy	5% of full scale to 500 kHz, 8% of full scale from 500 kHz to 1 MHz (includes dial scale accuracy and range-to-range accuracy). Unit calibrated at full scale.
Dial Range	Greater than 100:1.
Output Impedance	600Ω , $\pm 5\%$.
Output Amplitude	20 V p-p open circuit; 10 V p-p into 600Ω .
Amplitude Control	Continuously variable, greater than 30 dB range.





TABLE OF CONTENTS

	PAGE
INTRODUCTION	3
SPECIFICATIONS	3
PANEL CONTROLS AND FEATURES	5
OPERATING INSTRUCTIONS	
A. Frequency and Waveform Selection, Manual Operation	8
B. DC Output	9
C. Voltage-Controlled Operation	10
D. TTL Output	12
APPLICATIONS	
A. Amplifier Frequency Response	13
B. Tone Control Test	13
C. Amplifier Overload Characteristic	13
D. Amplifier Performance Evaluation Using Square Waves	16
E. Speaker System Testing	18
F. AM Receiver Alignment	18
G. Using the 3010 As A Bias and Signal Source	20
H. Preset Frequency Selection	21
I. Digital Frequency Selection	22
J. Communications Receiver Alignment	23
K. Additional Applications	23
THEORY OF OPERATION	
General Circuit Description	25
Detailed Circuit Description	27
240-Volt Export Models	30
MAINTENANCE AND CALIBRATION	
Removal of Rear Case	31
Calibration Procedure	32
WARRANTY SERVICE INSTRUCTIONS	37
ONE-YEAR LIMITED WARRANTY	38

DC Offset	Continuously variable, ± 10 V, open circuit; ± 5 V, into 600Ω .
	Max. $V_{AC} + V_{DC}$ offset without clipping, ± 10 V open circuit; ± 5 V into 600Ω .
Sine Wave Distortion	Less than 1%, 1 Hz to 100 kHz; harmonics more than 30 dB down from fundamental, 100 KHz to 1 MHz.
Square Wave Non-Symmetry	Less than 1%, to 100 KHz.
Triangle Wave Non-Linearity	Less than 1%, to 100 KHz.
Square Wave Rise/Fall Time	Less than 100 nSEC at maximum output amplitude.
Sine Wave Amplitude Flatness	± 3 dB to 1 MHz at maximum output amplitude.
TTL Square Wave Response	Less than 25 nSEC rise/fall time. Fixed TTL level: LO less than .4 V; HI greater than 2.4 V. Will drive 20 TTL loads.
Short-Term Stability	.05%
Power Requirements	105 to 130 VAC, 60 Hz. 8 watts max.
Dimensions (HWD)	3.2 x 11.3 x 7.7" (8.13 x 28.70 x 19.56 cm.)
Weight	2 lbs., 9 oz. (1.16 Kg.) without line cord. 2 lbs., 14 oz. (1.31 Kg.) with line cord.
Handle	Four positions: integral part of case.

PANEL CONTROLS AND FEATURES

(See Fig. 1)

1. **POWER on-off switch.** Depressing this button turns the 3010 on. To turn off, push again and release.
2. **RANGE selectors.** Decade frequency type. Multiplying the range selected times the FREQUENCY dial (6) indication gives the *output frequency*, which applies for all functions. For example, if the 100 K RANGE button is depressed and the FREQUENCY dial is at 10, the output frequency is 1 MHz.
3. **FUNCTION selectors.** Select square () , sine () , or triangle () output waveform which appears at 600Ω OUTPUT jack (9).
4. **AMPLITUDE control.** Controls the amplitude of the output signal, which appears at 600Ω jack (9). This control does not apply to the DC OFFSET voltage or to the TTL output.
5. **DC OFFSET control.** Adds positive or negative DC component to the signal appearing at 600Ω OUTPUT jack (9). Continuously variable for ±5 V (600 ohms) or ±10 V (open circuit). The DC component added by this control is dependent of the adjustment of AMPLITUDE control (4).
6. **FREQUENCY dial.** Multiplying the setting of this dial times the frequency of the RANGE switch (2) selected gives the output frequency of the waveforms at the 600Ω OUTPUT jack (9) and TTL jack (7).
7. **TTL jack.** A TTL square wave is available at this jack. The frequency is determined by the RANGE selected and the setting of the FREQUENCY dial. This output is independent of the AMPLITUDE and DC OFFSET controls.
8.  (Ground) jack. Common reference for the TTL and 600Ω OUTPUT signals.
9. **600Ω OUTPUT jack.** Waveforms selected by FUNCTION switches as well as the superimposed DC OFFSET voltage are available at this jack.
10. **HANDLE.** Multiple-position design permits use as a tilt stand or carrying handle.

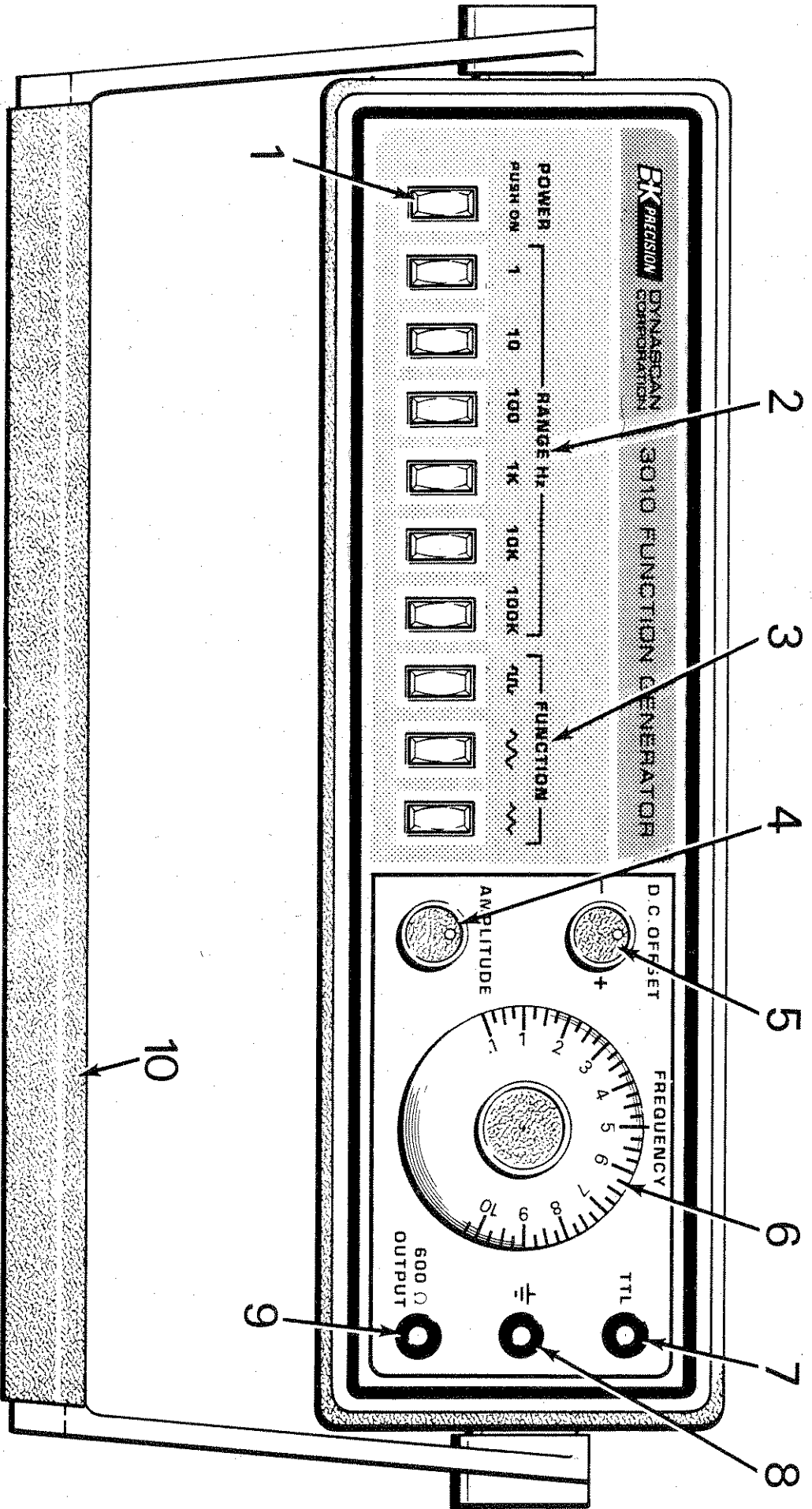

Fig. 1. Front panel controls and features.

11. **VCO INPUT jack (rear panel).** An external voltage input will vary the output frequency. The change in frequency is directly proportional to input voltage; therefore, the rate of change of frequency is proportional to that of the input voltage.
12. **LINE CORD RECEPTACLE (rear panel).**

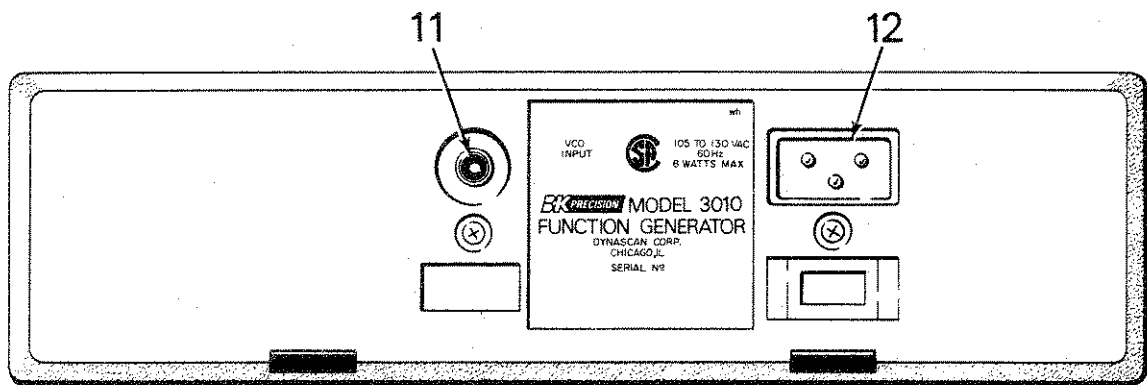

Fig. 2. Rear panel.

OPERATING INSTRUCTIONS

A. FREQUENCY AND WAVEFORM SELECTION, MANUAL OPERATION

1. With the unit plugged into a power source, depress the POWER button (1).
2. Select the frequency range desired by depressing the appropriate RANGE switch. The frequency range obtained as the FREQUENCY dial (6) is varied will be from one-tenth the indicated RANGE value to 10 times this value. For example, select the 10 K range. When the FREQUENCY dial is at .1, the output frequency is 1 KHz; when at 1, it is 10 KHz and when at 10 the frequency is 100 KHz. The frequency obtained applies to the signal at the TTL jack as well as the 600 Ω OUTPUT jack.
3. Select the waveform desired by depressing the appropriate FUNCTION button. The phase relationships of the waveforms available are shown in Fig. 3.
4. The amplitude of the selected output signal at the 600 Ω OUTPUT jack is adjusted by AMPLITUDE control (4). The TTL output is not affected by the AMPLITUDE control.
5. A DC component can be added to the signal at the 600 Ω OUTPUT jack by use of the DC OFFSET control. The DC component introduced is independent of the AMPLITUDE control and does not apply to the TTL output. The level of DC can be varied ± 10 volts open circuited or ± 5 volts across 600 ohms.

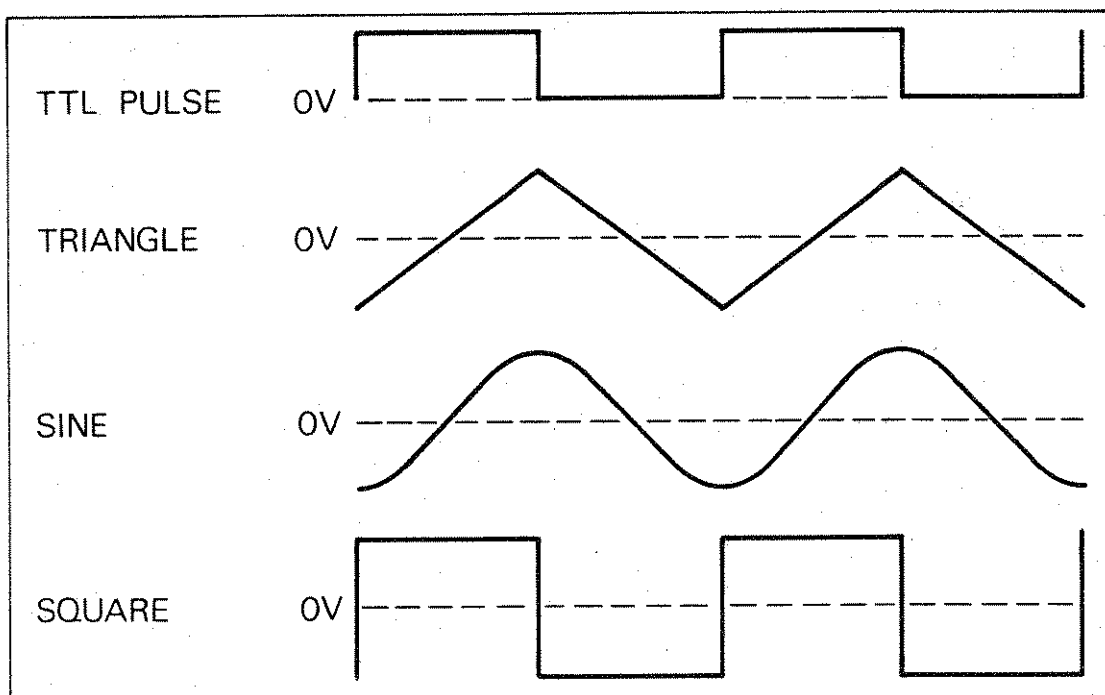

Fig. 3. Output waveform and phase relationships.

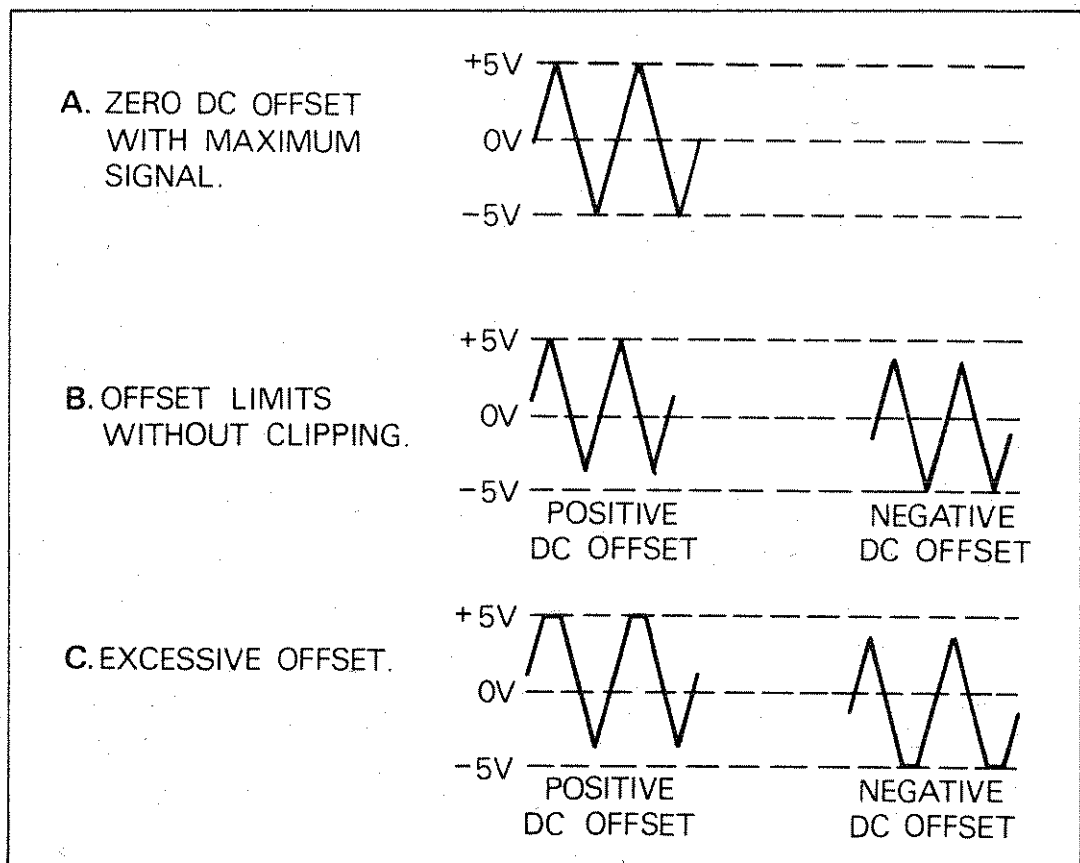

Fig. 4. Use of DC OFFSET control.

6. Remember that the output signal swing of the generator is limited to ± 10 volts (open circuit) or ± 5 volts into 600 ohms. This applies to the combined signal and DC offset. Clipping occurs slightly above these levels. Fig. 4 illustrates the various operating conditions encountered, when using the DC offset. If the desired output signal is large or if a large DC offset is used, an oscilloscope should be used to make sure that the desired combination is obtained without undesirable clipping.
7. When using the higher output frequencies and when using the square wave and TTL outputs, terminate the cable in 600 ohms to minimize ringing. Keep the cables as short as possible.

B. DC OUTPUT

The DC OFFSET feature can be used to convert the Model 3010 to a bipolar DC power supply with an internal impedance of about 600 ohms.

1. Depress the FUNCTION switches slightly so that all switches are released (all buttons out). This removes all signal components from the output.
2. The output now consists of a DC voltage which can be varied continuously from -10 volts to +10 volts (open circuit) by use of the DC OFFSET control.

3. A decoupling capacitor (20 mfd or more) can be connected across the 600 Ω OUTPUT and ground ($\frac{1}{\text{---}}$) terminals to reduce the AC impedance of the output. Always observe polarity when using polarized capacitors.

C. VOLTAGE-CONTROLLED OPERATION

The 3010 can be operated as a voltage-controlled oscillator (VCO) by using an external control voltage applied to the VCO IN jack at the rear of the unit. A male phono plug is provided for this purpose. The externally applied voltage will vary the frequency which is preselected by the RANGE switches and the FREQUENCY dial. A positive-going voltage will increase the frequency and a negative-going voltage will decrease the frequency. Please note that the frequency does not change without limit as the input control voltage is increased. The upper dial frequency can be exceeded by about 10 per cent. If the control voltage reduces the lowest frequency available below the frequency corresponding to the low end of the frequency dial (.1), erratic operation results.

The desired frequency, output waveforms, DC offset, and the output amplitude adjustment are selected as for manual operation. The maximum voltage-controlled sweep is over a 100:1 range.

1. SWEEP FREQUENCY OPERATION

- a. Select frequency range and function.
- b. Set DC offset, if required.
- c. Set amplitude to desired level.
- d. To obtain maximum sweep, set the FREQUENCY dial to either extreme. For this example, set at low end (.1 on FREQUENCY dial).
- e. Connect a positive-going voltage to the VCO IN jack. A 0 to +5.5 volt ramp will provide a frequency increase corresponding to a FREQUENCY dial setting of 10. This is a 100:1 ratio. The frequency varies in direct proportion to the applied input voltage.

2. FREQUENCY MODULATION

If an alternating voltage with no DC component is applied to the VCO IN jack, the preset frequency will vary above and below the frequency that was preset by the RANGE switch and FREQUENCY dial. The DC component of such an input signal can be removed by transformer or capacitive coupling.

- a. Select frequency and function.
- b. Set DC offset, if required.
- c. Set amplitude to desired level.
- d. Adjust the VCO IN voltage to provide the desired frequency modulation.
- e. The approximate frequency deviation obtained for a given VCO signal can be determined as follows:
 - (1) .055 volt will produce a change in frequency equal to one per cent of the highest frequency obtainable on a given range. For example, if the 1 K RANGE is selected and the FREQUENCY dial is at 10, the output frequency is 10 KHz. One per cent of 10 KHz is 100 Hz. Therefore, for each .055 volt change in the VCO voltage, a 100 Hz change in frequency is produced with the 1 K RANGE selected, regardless of FREQUENCY dial setting.
 - (2) As an example, assume the RANGE switch and FREQUENCY dial are set for 5 KHz output. If an alternating signal having an amplitude of $\pm .55$ volt is applied to the VCO IN jack, a frequency swing of $\pm \left(\frac{.55}{.055}\right) 100 = \pm 1$ KHz is obtained. The table below indicates the frequency change per .055 volt input to the VCO IN jack for each range.

Range, Hz	Min. Frequency, Hz (Dial at .1)	Max. Frequency, Hz (Dial at 10)	1% Frequency Change, Hz (For .055 V input)
1	.1	10	.1
10	1	100	1
100	10	1 K	10
1K	100	10 K	100
10 K	1 K	100 K	1 K
100 K	10 K	1 M	10 K

D. TTL OUTPUT

This is a fast rise time square wave output, available at the front panel. Because of the fast transition times of this output, cable termination should be provided to minimize ringing. The output is always positive with respect to ground. This signal can be used as an external sync pulse for oscilloscopes when using the other generator outputs. It also can be used as a variable frequency signal source for exercising logic circuits.

1. Select desired frequency (repetition rate).
2. Connect to TTL output.
3. The AMPLITUDE and DC OFFSET controls have no effect on the TTL output signal.

APPLICATIONS

A. AMPLIFIER FREQUENCY RESPONSE (See Fig. 5)

1. Interconnect equipment as indicated Fig. 5A. This use of either the oscilloscope or the AC voltmeter to measure output voltage is adequate. The advantage of the oscilloscope is that waveform distortion can be simultaneously monitored, particularly if a power response curve is being run. The AC voltmeter, provided with decibel scales, is convenient for converting the observed output variations into standard units of measurement (dB). The amplifier under test may be anything from a single stage transistor amplifier to a high fidelity component type. The dual trace oscilloscope is convenient for this application because the input to the amplifier as well as the output can be monitored simultaneously.
2. Vary the frequency of the 3010 as required, maintaining a constant amplitude as observed on the oscilloscope. The amplifier input and output waveforms can be monitored simultaneously as indicated in Fig. 5b. Using two centimeters for amplitude references provides a convenient method of determining percent of change in amplitude.
3. The results of response tests can be plotted on semi-log paper as indicated in Fig. 6.

B. TONE CONTROL TEST

If the amplifier under test is provided with base and treble controls, the effects of these controls on overall response can be determined by running consecutive response curves with the controls at both extremes of adjustment. The results can be plotted on semi-log graph paper, as indicated in Fig. 7.

C. AMPLIFIER OVERLOAD CHARACTERISTIC

1. The overload point for some amplifiers is difficult to determine exactly because of the gradual overload characteristic. The exact point of which signal compression begins is difficult to determine using sine-wave input. The triangle wave form is ideal for this type of test because any departure from absolute linearity is readily detectable.
2. Using the test set-up of Fig. 5A and using the triangle output, the peak overload condition for an amplifier can be readily determined. This overload condition is shown in Fig. 8.

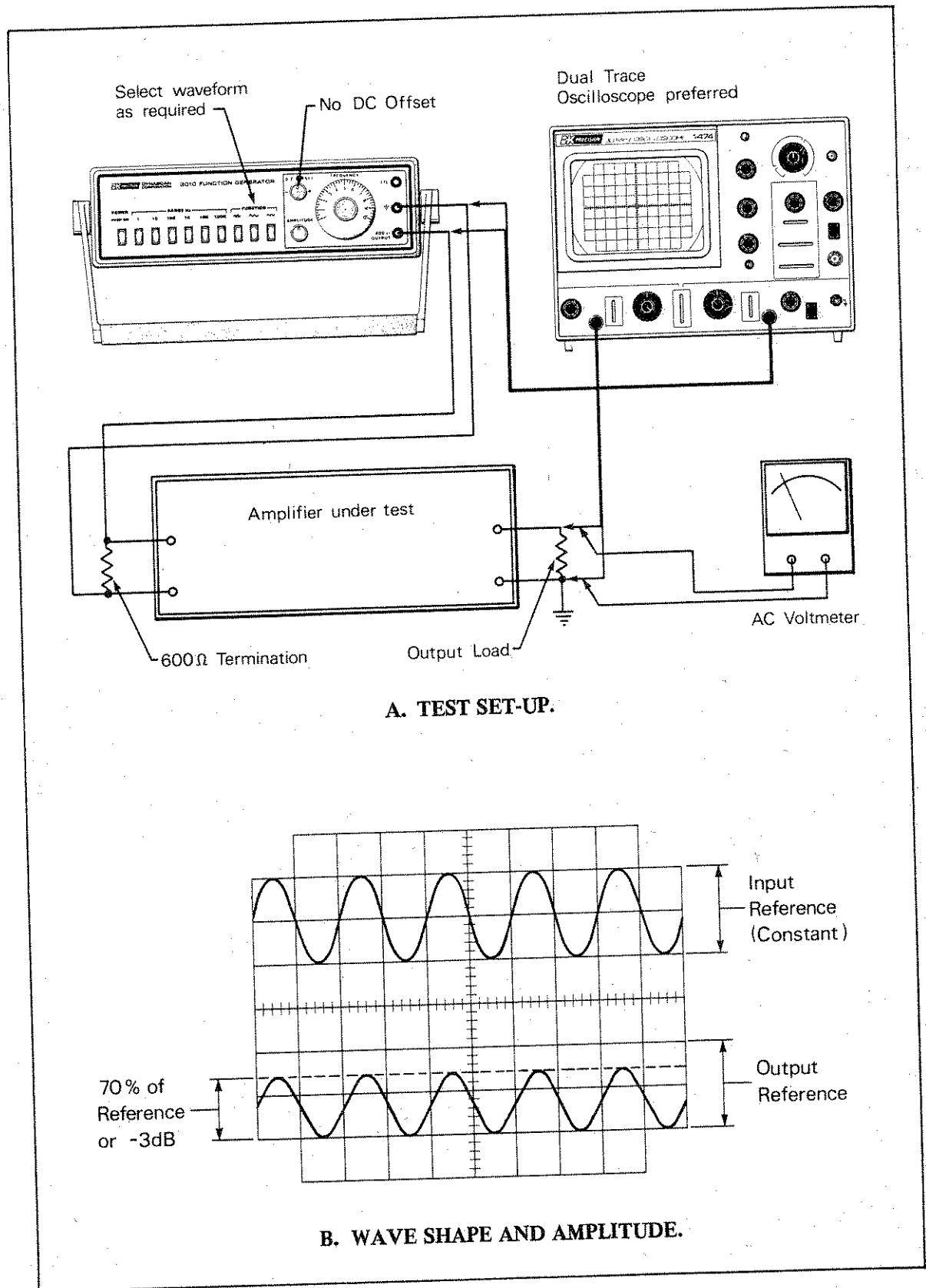

Fig. 5. Amplifier frequency response, manual frequency change.

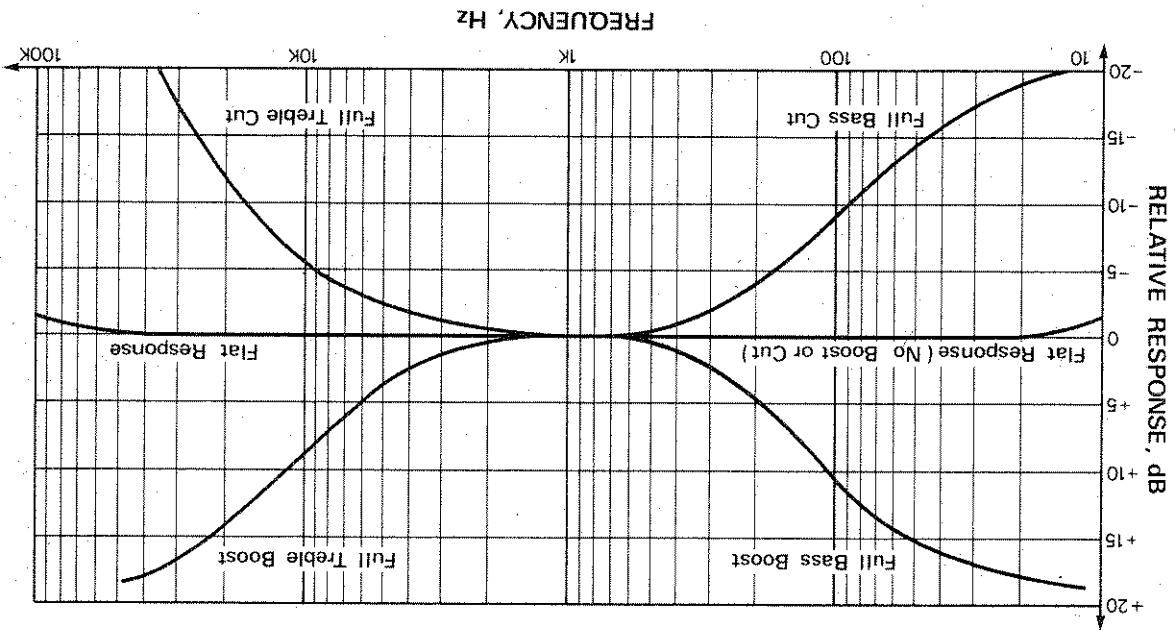

Fig. 7. Tone control effectiveness.

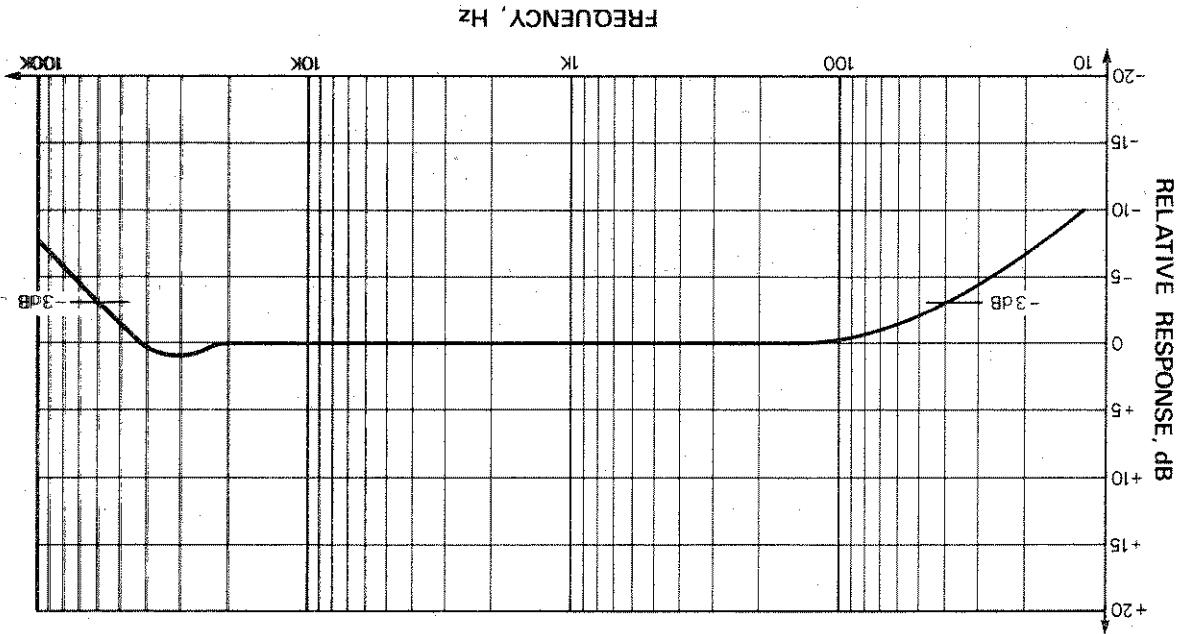

Fig. 6. Plot of amplifier frequency response.

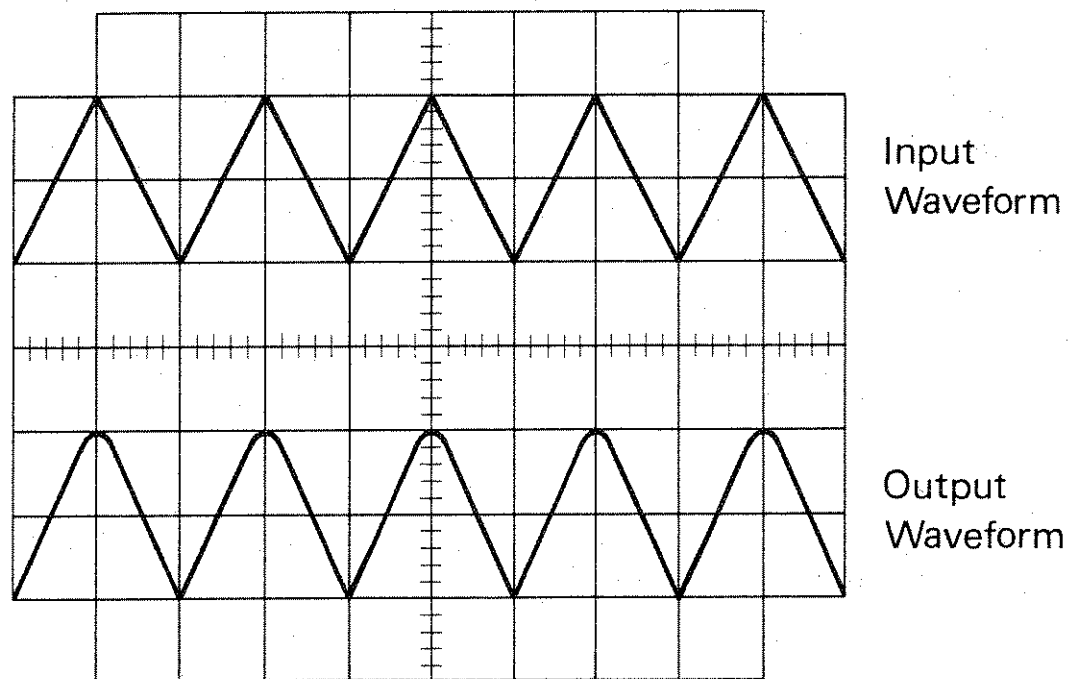

Fig. 8. Amplifier overload characteristics.

D. AMPLIFIER PERFORMANCE EVALUATION USING SQUARE WAVES

The standard sine-wave frequency response curves, such as those obtained in Par. A, do not give a full evaluation of the amplifier transient response. The square wave, because of the high harmonic content, yields much information regarding amplifier performance, when used in conjunction with an oscilloscope.

1. Use the test set-up of Fig. 9A. This is similar to that used in Fig. 5A except that a termination is specified at the amplifier input. This is essential when using square waves to eliminate the ringing effects generated by the fast rise times.
2. Using the triangle output of the 3010, set the AMPLITUDE control so that there is no signal clipping over the range of frequencies to be used.
3. Select the square wave output and adjust the frequency to several check points within the passband of the amplifier, such as 20 Hz, 1000 Hz and 10 KHz.
4. At each frequency check point the wave form obtained at the amplifier output provides information regarding amplifier performance with respect to the frequency of the square wave input. Fig. 9B indicates the possible wave forms obtained at the amplifier output and the causes.

Square wave evaluation is not practical for narrow band amplifiers. The restricted band width of the amplifier cannot reproduce all frequency

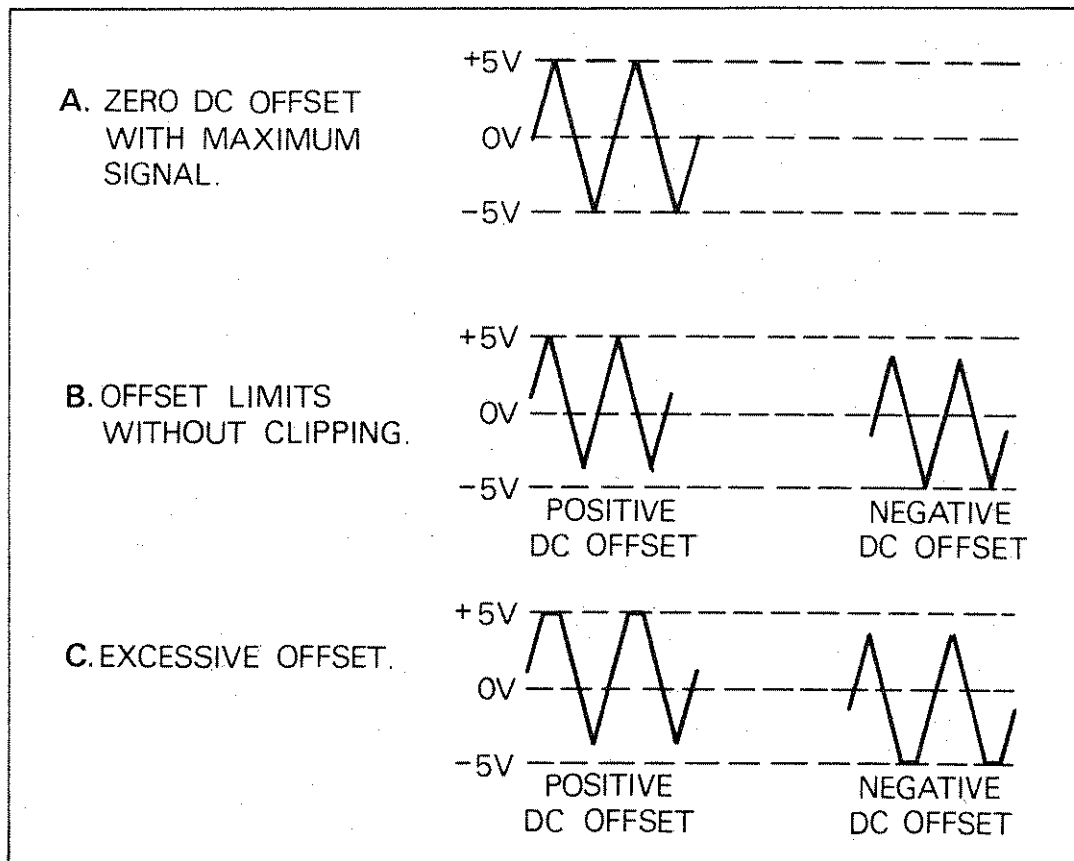

Fig. 4. Use of DC OFFSET control.

6. Remember that the output signal swing of the generator is limited to ± 10 volts (open circuit) or ± 5 volts into 600 ohms. This applies to the combined signal and DC offset. Clipping occurs slightly above these levels. Fig. 4 illustrates the various operating conditions encountered, when using the DC offset. If the desired output signal is large or if a large DC offset is used, an oscilloscope should be used to make sure that the desired combination is obtained without undesirable clipping.
7. When using the higher output frequencies and when using the square wave and TTL outputs, terminate the cable in 600 ohms to minimize ringing. Keep the cables as short as possible.

B. DC OUTPUT

The DC OFFSET feature can be used to convert the Model 3010 to a bipolar DC power supply with an internal impedance of about 600 ohms.

1. Depress the FUNCTION switches slightly so that all switches are released (all buttons out). This removes all signal components from the output.
2. The output now consists of a DC voltage which can be varied continuously from -10 volts to +10 volts (open circuit) by use of the DC OFFSET control.

3. A decoupling capacitor (20 mfd or more) can be connected across the 600 Ω OUTPUT and ground ($\frac{1}{\text{---}}$) terminals to reduce the AC impedance of the output. Always observe polarity when using polarized capacitors.

C. VOLTAGE-CONTROLLED OPERATION

The 3010 can be operated as a voltage-controlled oscillator (VCO) by using an external control voltage applied to the VCO IN jack at the rear of the unit. A male phono plug is provided for this purpose. The externally applied voltage will vary the frequency which is preselected by the RANGE switches and the FREQUENCY dial. A positive-going voltage will increase the frequency and a negative-going voltage will decrease the frequency. Please note that the frequency does not change without limit as the input control voltage is increased. The upper dial frequency can be exceeded by about 10 per cent. If the control voltage reduces the lowest frequency available below the frequency corresponding to the low end of the frequency dial (.1), erratic operation results.

The desired frequency, output waveforms, DC offset, and the output amplitude adjustment are selected as for manual operation. The maximum voltage-controlled sweep is over a 100:1 range.

1. SWEEP FREQUENCY OPERATION

- a. Select frequency range and function.
- b. Set DC offset, if required.
- c. Set amplitude to desired level.
- d. To obtain maximum sweep, set the FREQUENCY dial to either extreme. For this example, set at low end (.1 on FREQUENCY dial).
- e. Connect a positive-going voltage to the VCO IN jack. A 0 to +5.5 volt ramp will provide a frequency increase corresponding to a FREQUENCY dial setting of 10. This is a 100:1 ratio. The frequency varies in direct proportion to the applied input voltage.

2. FREQUENCY MODULATION

If an alternating voltage with no DC component is applied to the VCO IN jack, the preset frequency will vary above and below the frequency that was preset by the RANGE switch and FREQUENCY dial. The DC component of such an input signal can be removed by transformer or capacitive coupling.

- a. Select frequency and function.
- b. Set DC offset, if required.
- c. Set amplitude to desired level.
- d. Adjust the VCO IN voltage to provide the desired frequency modulation.
- e. The approximate frequency deviation obtained for a given VCO signal can be determined as follows:
 - (1) .055 volt will produce a change in frequency equal to one per cent of the highest frequency obtainable on a given range. For example, if the 1 K RANGE is selected and the FREQUENCY dial is at 10, the output frequency is 10 KHz. One per cent of 10 KHz is 100 Hz. Therefore, for each .055 volt change in the VCO voltage, a 100 Hz change in frequency is produced with the 1 K RANGE selected, regardless of FREQUENCY dial setting.
 - (2) As an example, assume the RANGE switch and FREQUENCY dial are set for 5 KHz output. If an alternating signal having an amplitude of $\pm .55$ volt is applied to the VCO IN jack, a frequency swing of $\pm \left(\frac{.55}{.055}\right) 100 = \pm 1$ KHz is obtained. The table below indicates the frequency change per .055 volt input to the VCO IN jack for each range.

Range, Hz	Min. Frequency, Hz (Dial at .1)	Max. Frequency, Hz (Dial at 10)	1% Frequency Change, Hz (For .055 V input)
1	.1	10	.1
10	1	100	1
100	10	1 K	10
1K	100	10 K	100
10 K	1 K	100 K	1 K
100 K	10 K	1 M	10 K

D. TTL OUTPUT

This is a fast rise time square wave output, available at the front panel. Because of the fast transition times of this output, cable termination should be provided to minimize ringing. The output is always positive with respect to ground. This signal can be used as an external sync pulse for oscilloscopes when using the other generator outputs. It also can be used as a variable frequency signal source for exercising logic circuits.

1. Select desired frequency (repetition rate).
2. Connect to TTL output.
3. The AMPLITUDE and DC OFFSET controls have no effect on the TTL output signal.

APPLICATIONS

A. AMPLIFIER FREQUENCY RESPONSE (See Fig. 5)

1. Interconnect equipment as indicated Fig. 5A. This use of either the oscilloscope or the AC voltmeter to measure output voltage is adequate. The advantage of the oscilloscope is that waveform distortion can be simultaneously monitored, particularly if a power response curve is being run. The AC voltmeter, provided with decibel scales, is convenient for converting the observed output variations into standard units of measurement (dB). The amplifier under test may be anything from a single stage transistor amplifier to a high fidelity component type. The dual trace oscilloscope is convenient for this application because the input to the amplifier as well as the output can be monitored simultaneously.
2. Vary the frequency of the 3010 as required, maintaining a constant amplitude as observed on the oscilloscope. The amplifier input and output waveforms can be monitored simultaneously as indicated in Fig. 5b. Using two centimeters for amplitude references provides a convenient method of determining percent of change in amplitude.
3. The results of response tests can be plotted on semi-log paper as indicated in Fig. 6.

TONE CONTROL TEST

If the amplifier under test is provided with base and treble controls, the effects of these controls on overall response can be determined by running consecutive response curves with the controls at both extremes of adjustment. The results can be plotted on semi-log graph paper, as indicated in Fig. 7.

AMPLIFIER OVERLOAD CHARACTERISTIC

1. The overload point for some amplifiers is difficult to determine exactly because of the gradual overload characteristic. The exact point of which signal compression begins is difficult to determine using sine-wave input. The triangle wave form is ideal for this type of test because any departure from absolute linearity is readily detectable.
2. Using the test set-up of Fig. 5A and using the triangle output, the peak overload condition for an amplifier can be readily determined. This overload condition is shown in Fig. 8.

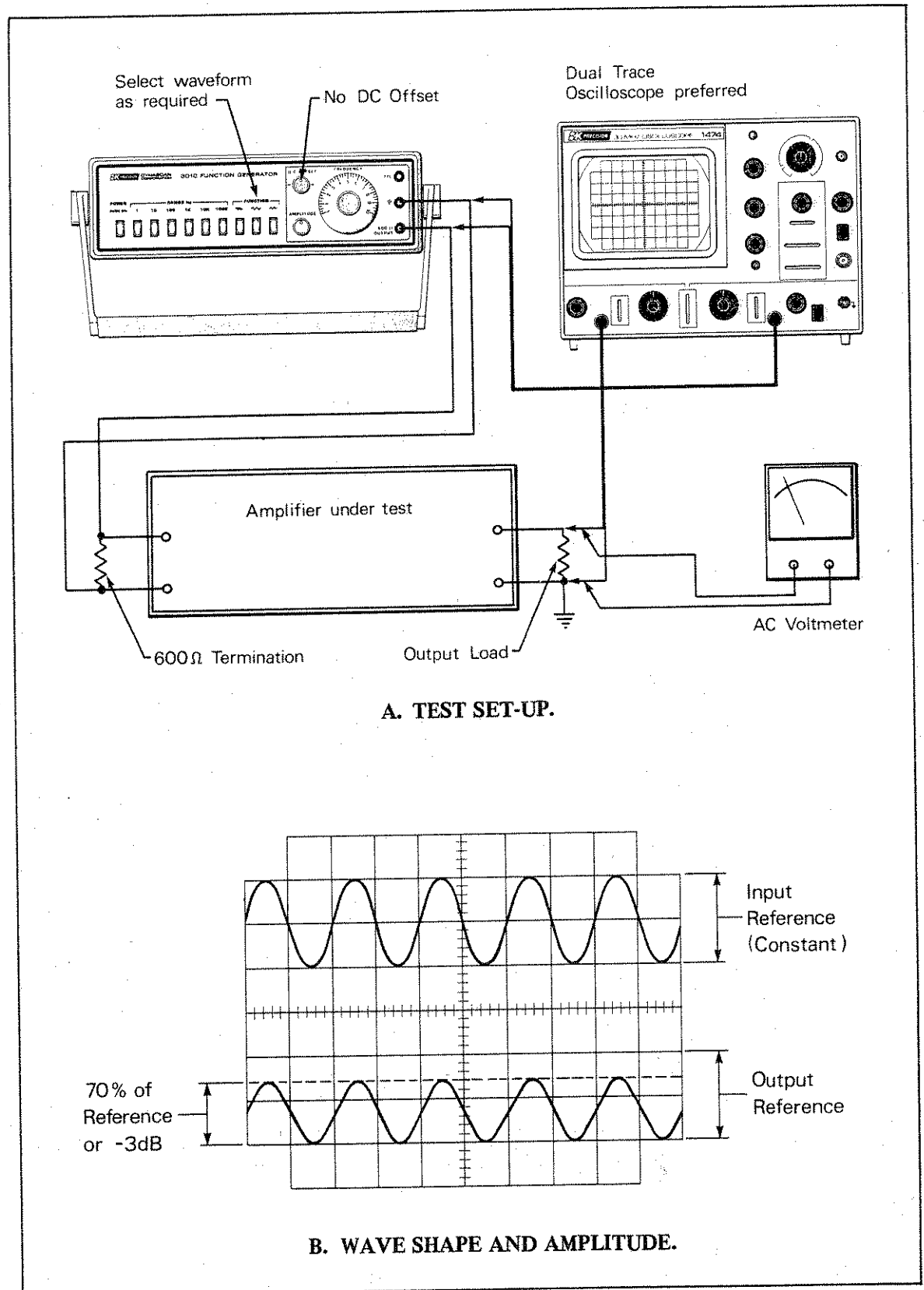

Fig. 5. Amplifier frequency response, manual frequency change.

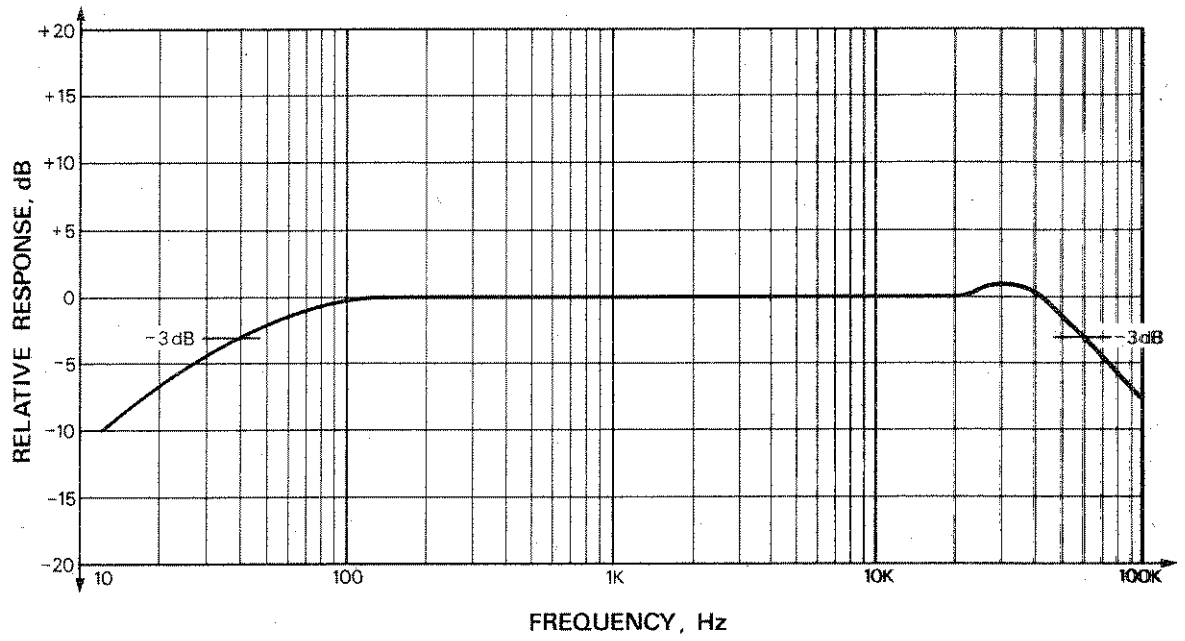

Fig. 6. Plot of amplifier frequency response.

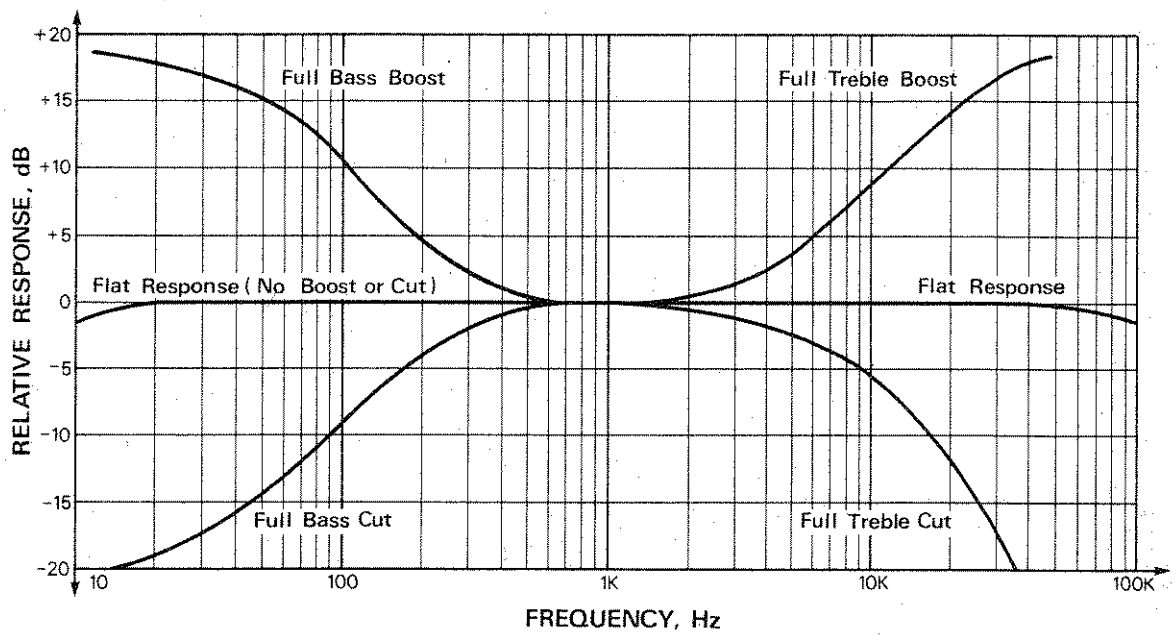

Fig. 7. Tone control effectiveness.

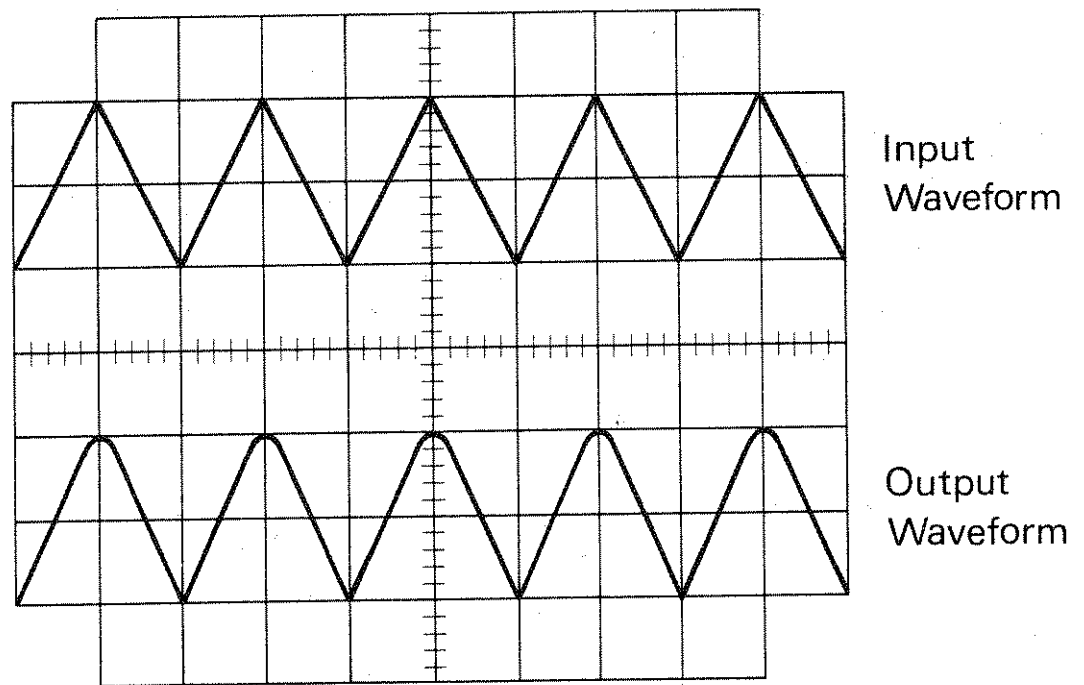

Fig. 8. Amplifier overload characteristics.

D. AMPLIFIER PERFORMANCE EVALUATION USING SQUARE WAVES

The standard sine-wave frequency response curves, such as those obtained in Par. A, do not give a full evaluation of the amplifier transient response. The square wave, because of the high harmonic content, yields much information regarding amplifier performance, when used in conjunction with an oscilloscope.

1. Use the test set-up of Fig. 9A. This is similar to that used in Fig. 5A except that a termination is specified at the amplifier input. This is essential when using square waves to eliminate the ringing effects generated by the fast rise times.
2. Using the triangle output of the 3010, set the AMPLITUDE control so that there is no signal clipping over the range of frequencies to be used.
3. Select the square wave output and adjust the frequency to several check points within the passband of the amplifier, such as 20 Hz, 1000 Hz and 10 KHz.
4. At each frequency check point the wave form obtained at the amplifier output provides information regarding amplifier performance with respect to the frequency of the square wave input. Fig. 9B indicates the possible wave forms obtained at the amplifier output and the causes.

Square wave evaluation is not practical for narrow band amplifiers. The restricted band width of the amplifier cannot reproduce all frequency

E. SPEAKER SYSTEM TESTING

The 3010 can be used to provide information regarding the input impedance of speaker systems vs. frequency. In addition, the low-frequency resonance of the system can be determined. Because the Model 3010 output impedance is 600 ohms, which is much higher than the impedance of conventional speaker systems, the 3010 can be used as a variable frequency current source to evaluate the input impedance of the speaker system. This is shown in Fig. 10B.

1. Use the test set-up Fig. 10A. An oscilloscope could be used in this set-up to verify that the 3010 is not being operated in a clipping condition.
2. Vary the frequency of the 3010 over the full range of interest and log the voltage measured at the speaker terminals vs. frequency. The dB scales of the AC voltmeter are convenient for converting this information to standard response units.
3. It will be observed that at some low frequency, a pronounced increase in voltage will occur. This is the resonance frequency of the low-frequency driver in the speaker system. This test set-up is convenient when designing speaker enclosures. It can help the designer to determine the effect on system resonance of varying port sizes, damping materials and other basic enclosure factors.
4. The measurements obtained in the above tests can be plotted on semi-log graph paper as indicated in Fig. 10C.

F. AM RECEIVER ALIGNMENT

1. Use the test set-up of Fig. 11. Because of the linear relationship between sweep voltage and frequency of the Model 3010, a linear frequency presentation is obtained on the oscilloscope, regardless of whether the sweep voltage is a triangle, sine wave or a ramp.
2. To minimize the number of set-up adjustments required, the sweep voltage to the VCO IN jack of the 3010 should *not* have a DC component. This can be removed by capacitor coupling.
3. If a precise center frequency is required, a frequency counter should be used when setting the output frequency of the 3010. This is done without sweep voltage input.
4. The sweep voltage to the oscilloscope can be supplied either to an external horizontal input jack or, if the oscilloscope has front panel X-Y capability it can be applied to one of the two vertical input jacks.

components of the square wave in the proper phase and amplitude relationships.

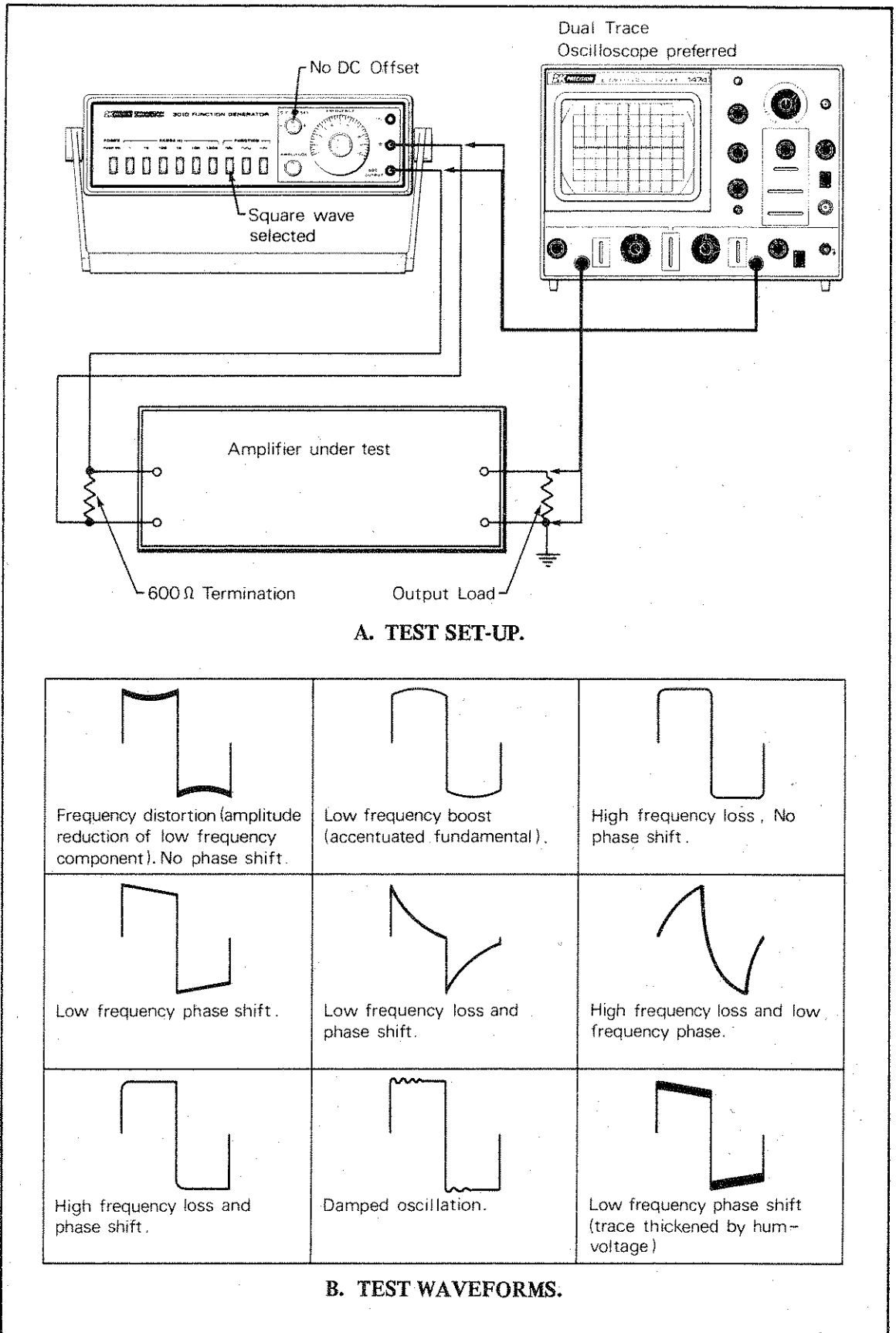

Fig. 9. Amplifier performance evaluation, using square waves.

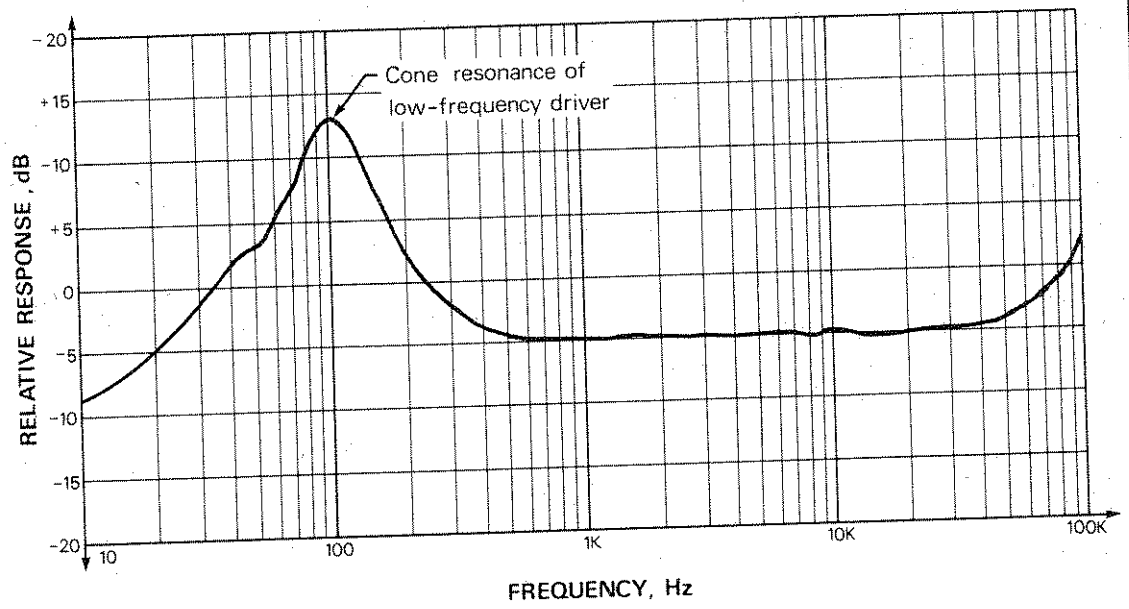
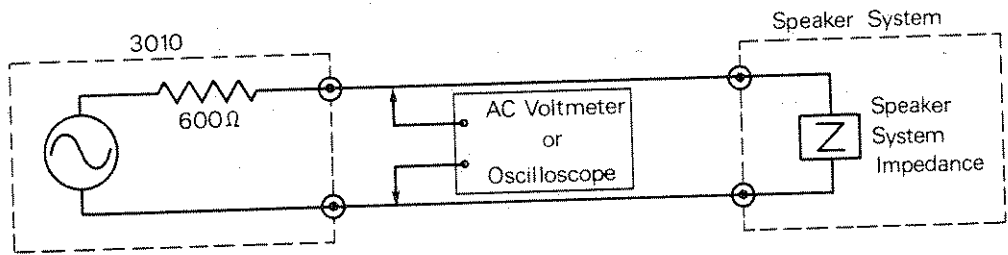
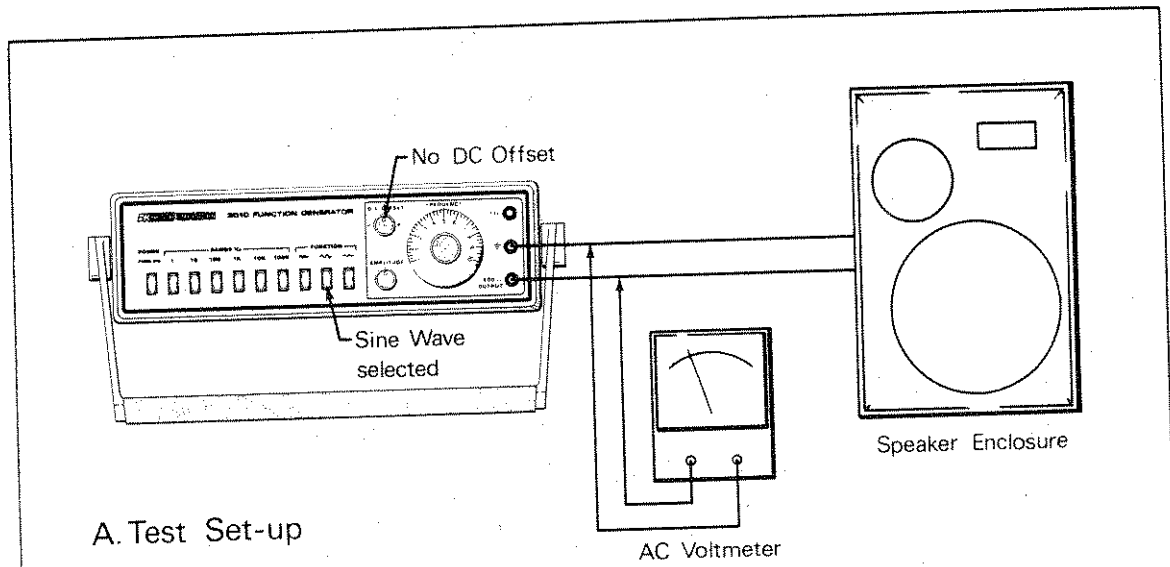

Fig. 10. Speaker system tests.

5. Because of the wide frequency range of the 3010, the signal can be injected either at the mixer (455 KHz) or at the antenna (1 MHz). When injecting the 455 KHz signal at the mixer input, the local oscillator must be disabled.
6. When the IF response is observed at the input to the AM detector, an RF detector probe is required unless a demodulated point is specified by the manufacturer.
7. The IF amplifier tuning adjustments can be performed as required to obtain the desired IF response curve. Normally each tuned circuit is adjusted for maximum amplitude at the IF center frequency.

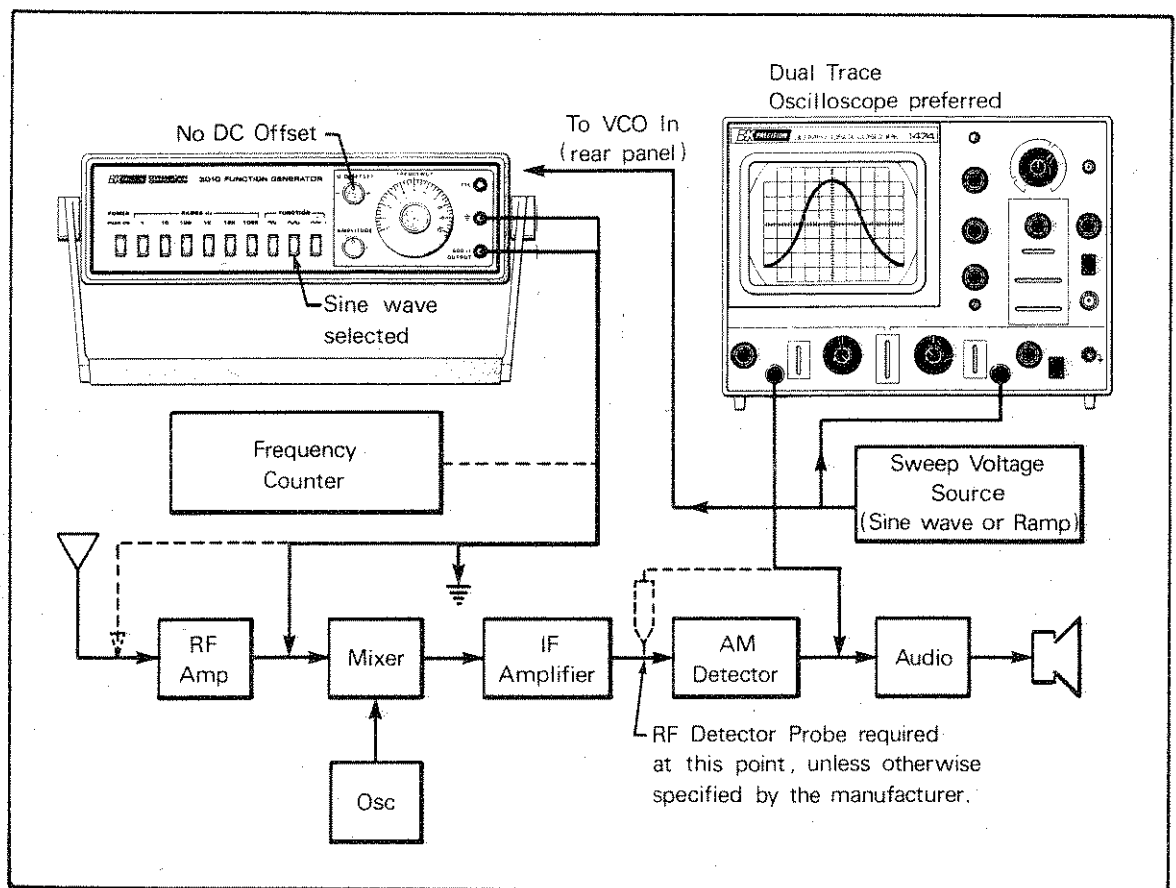

Fig. 11. AM receiver alignment, RF and IF.

G. USING THE 3010 AS A BIAS AND SIGNAL SOURCE

In the test set-up of Fig. 12 the 3010 can be used to bias the transistor under test as well as to furnish an AC signal. By observing the amplifier output on the oscilloscope, the amplitude and bias of the transistor can be optimized for maximum undistorted output. By use of the DC OFFSET control, the effects of various types of bias (class A, B, and C) can be determined.

H. PRESET FREQUENCY SELECTION

In test and design work where several frequencies are used repeatedly, it is convenient to be able to preset these frequencies with a minimum of effort. As shown in Fig. 13, the VCO feature of the 3010 can be used together with preset voltages and frequency selector switch.

1. Set the FREQUENCY DIAL to .1.
2. Connect the output of the 3010 to a frequency counter.
3. With the frequency selector switch in the F1 position, adjust the R1 for the desired frequency as observed on the frequency counter. Repeat this for the frequencies desired.
4. With the FREQUENCY dial set at .1, and a maximum available $A+$ voltage of about 6 volts, frequencies encompassing a 100:1 range can be obtained by this method on each frequency range.

Fig. 12. Use of Model 3010 as a combined bias supply and signal source.

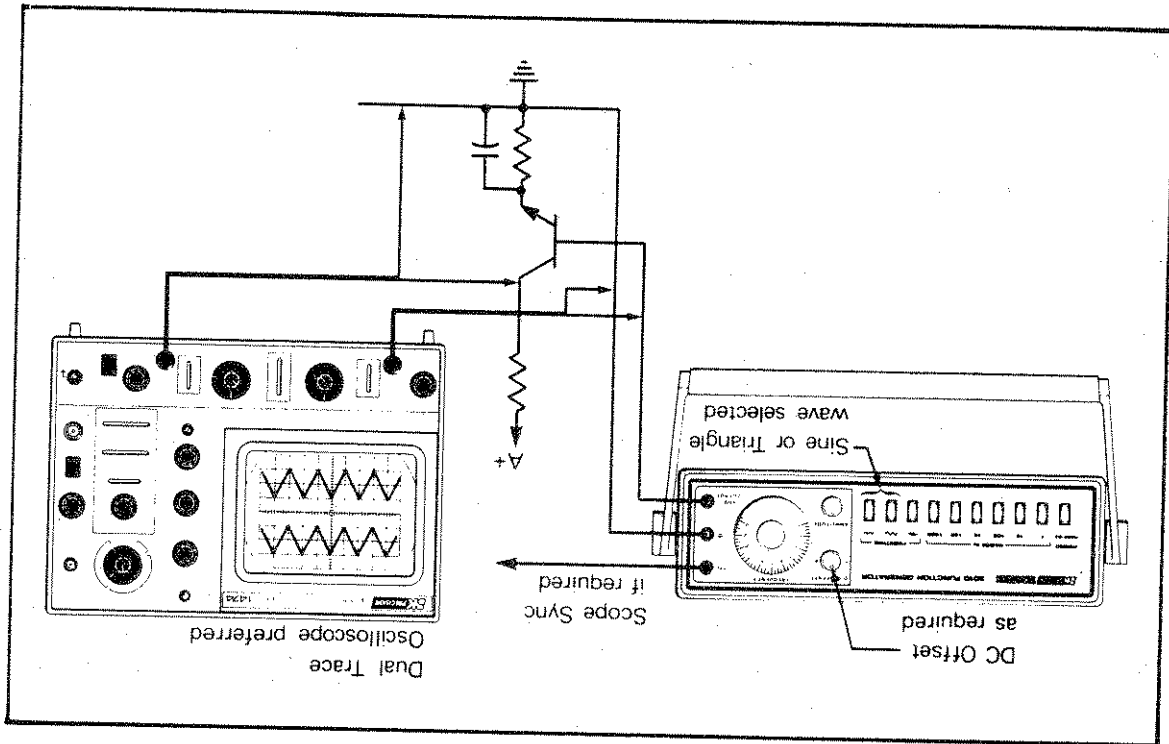

J. COMMUNICATIONS RECEIVER ALIGNMENT

The test set-up of Fig. 15 can be used for alignment of communication receiver IF's and discriminators using the 455 KHz IF frequency. For accurate frequency adjustments, a 455 KHz crystal control marker source should be used.

1. The sweep voltage source is applied to the 3010 VCO IN jack and to the oscilloscope X-axis input.
2. the IF response curve is indicated. In some receivers the IF selectivity is "packaged" which means all adjustments are preset. In this case the receiver alignment can only be evaluated and verified without adjustment. Where the tuned circuits are adjustable, the manufacturer's procedure must be followed to insure that the proper overall response is obtained.

K. ADDITIONAL APPLICATIONS

The triangle output of the 3010 can be used at its lowest frequencies to simulate a slowly varying DC source. This can be used to check threshold levels of TTL and CMOS logic as well as voltage comparators. Chart recorders can be checked by this method. Analog meter movements can be exercised from zero to full scale to observe defects, such as sticky meter movements.

B & K-PRECISION MODEL 3010 PARTS LIST

488-214-9-002C

SCHEMATIC SYMBOL	DESCRIPTION	B & K-PRECISION PART NO.
---------------------	-------------	-----------------------------

RESISTORS & POTENTIOMETERS

R1, 2, 7, 8, 32, 34	11.0K Ω , 1%, 1/4W, P.F. Metal Film	015-141-1-102
R5	120 Ω , 10%, 1W, P.F. Carbon	001-001-9-121
R6	390 Ω , 10%, 1W, P.F. Carbon	001-001-9-391
R11, 12	10K Ω , 20%, 1/4W, Vertical Trimptot	010-007-9-007
R13	5K Ω , 20%, 1/4W, Vertical Trimptot	010-007-9-006
R17, 45	2.00K Ω , 1%, 1/4W, P.F. Metal Film	015-141-2-001
R19, 20, 21, 33, 35	1.00K Ω , 1%, 1/4W, P.F. Metal Film	015-141-1-001
R23	33.2K Ω , 1/4%, 1/4W, P.F. Metal Film	011-144-9-001
R24	3.7K Ω , 1/4%, 1/4W, P.F. Metal Film	011-143-9-001
R25	15.4K Ω , 1%, 1/4W, P.F. Metal Film	015-141-1-542
R26	2.5K Ω , 20%, 1/4W, Vertical Trimptot	010-007-9-005
R27	1.74K Ω , 1%, 1/4W, P.F. Metal Film	015-141-1-741
R28	250 Ω , 20%, 1/4W, Vertical Trimptot	010-007-9-002
R39, 40	221 Ω , 1%, 1/4W, P.F. Metal Film	015-141-2-210
R41	1.91K Ω , 1%, 1/4W, P.F. Metal Film	015-141-1-911
R42, 52, 59	1K Ω , 20%, 1/4W, Vertical Trimptot	010-107-9-004
R46	332 Ω , 1%, 1/4W, P.F. Metal Film	105-141-3-320
R50	100 Ω , 20%, 1/4W, Vertical Trimptot	010-007-9-001
R55	100K Ω , 20%, 1/4W, Vertical Trimptot	010-007-9-010
R101	10K Ω , 10%, 2W, POT	008-368-9-001
R102	2K Ω , 10%, 1/4W, POT	008-328-9-001
R103	10K Ω , 10%, 1/4W, POT	008-327-9-001

CAPACITORS

C1	1000 μ F, 25V, P.C. Aluminum Electrolytic	022-101-9-001
C2, 4, 5, 7, 10, 12, 14, 19, 20, 21, 24, 26, 28, 30	.01 μ F, 100V, 10%, P.F. Ceramic Disc.	020-101-9-001
C3	470 μ F, 25V, P.C. Aluminum Electrolytic	022-095-9-001
C6, 8, 9, 29, 31	10 μ F, 25V, P.F. Tantalum	027-014-9-001
C11, 13, 23, 25, 27	47 μ F, 6.3V, P.F. Tantalum	027-013-9-001
C15	3.3 μ F, 10%, Metalized Polycarbonate	033-036-9-001
C16	.033 μ F, 10%, Polypropylene	033-034-9-001
C17	25pF, 10%, 500V, P.F. Ceramic Disc.	031-029-9-001
C18	300pF, 10%, Polypropylene	033-035-9-001
C22	20pF, 10%, 500V, P.F. Ceramic Disc	031-010-9-001

COMPOSITE
499-129-9-001D

ATIC
DL

DESCRIPTION

B & K-PRECISION
PART NO.

DIODES & TRANSISTORS

	1AMP, 600 PIV, Silicon Diode	151-050-9-001
	1N4148 Silicon Diode	151-038-9-001
	PNP Transistor	177-017-9-001
	2N5087 PNP Silicon Transistor	177-034-9-001
	2N5210 NPN Silicon Transistor	176-083-9-001
	Dual N-Channel FET	182-024-9-001
.0, 12	2N3904 NPN Silicon Transistor	176-084-9-001
3	2N3906 PNP Silicon Transistor	177-035-9-001

INTEGRATED CIRCUITS

	78L15AC, +15 Regulator	307-130-9-001
	78L05AC, +5 Regulator	307-129-9-001
4	324, Quad OP AMP	307-060-9-001
	75107, Dual Line Receiver	307-127-9-001
	7400, Quad Nand Gate	307-015-9-001
	3086, Transistor Array	307-087-9-001

MISCELLANEOUS

	Power Transformer, 120V, 60 Hz	065-137-9-001
	Power Transformer, 120/240V, 50/60 Hz	065-137-9-002
	Switch, 10-Position, Push-Button	088-036-9-001
	Fuse, 1/8A, 3AG, Slo-Blo	190-251-3-108
	Fuse, 1/16A, 3AG, Slo-Blo (240V MODEL ONLY)	190-002-9-001
	Bracket, Control Mounting	251-327-9-902
	Bracket, Transformer Mounting	251-328-9-902
	Inlay, Front Panel	255-159-9-001
	Case, Rear	271-057-9-001
	Case, Front	271-061-9-001
	Handle	380-279-9-001
	Pad, Anti-Skid	381-080-9-001
	Switch Button, White	384-019-9-009
	Switch Button, Tan	384-019-9-017
	Switch Button, Bright Ochre	384-019-9-020
	AC Power Cord	420-022-9-001
	Screw, Decorative Handle	634-085-9-001
	Knob	751-158-9-001
	Frequency Dial Knob	751-159-9-001
	Handle Spring	767-049-9-001
	Recessed Recepticle (AC Power cord)	770-018-9-001
	Phono Jack	773-085-9-001
	Instruction Manual	480-225-9-001

Standard value resistors and capacitors are not listed. Values may be obtained from
tic diagram. Minimum charge \$5.00 per invoice. Orders will be shipped C.O.D. unless
s open account arrangements have been made or remittance accompanies order.
e remittance must cover postage or express charges. Specify serial number when
g replacement parts.

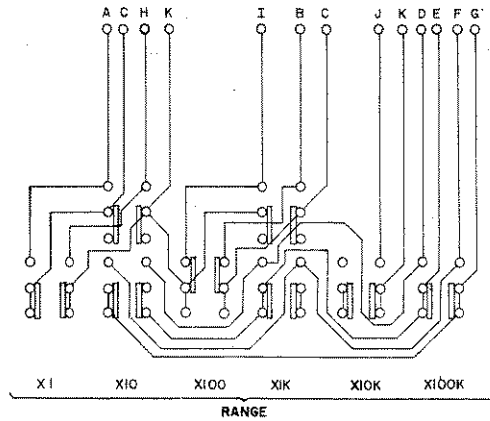
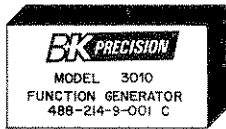
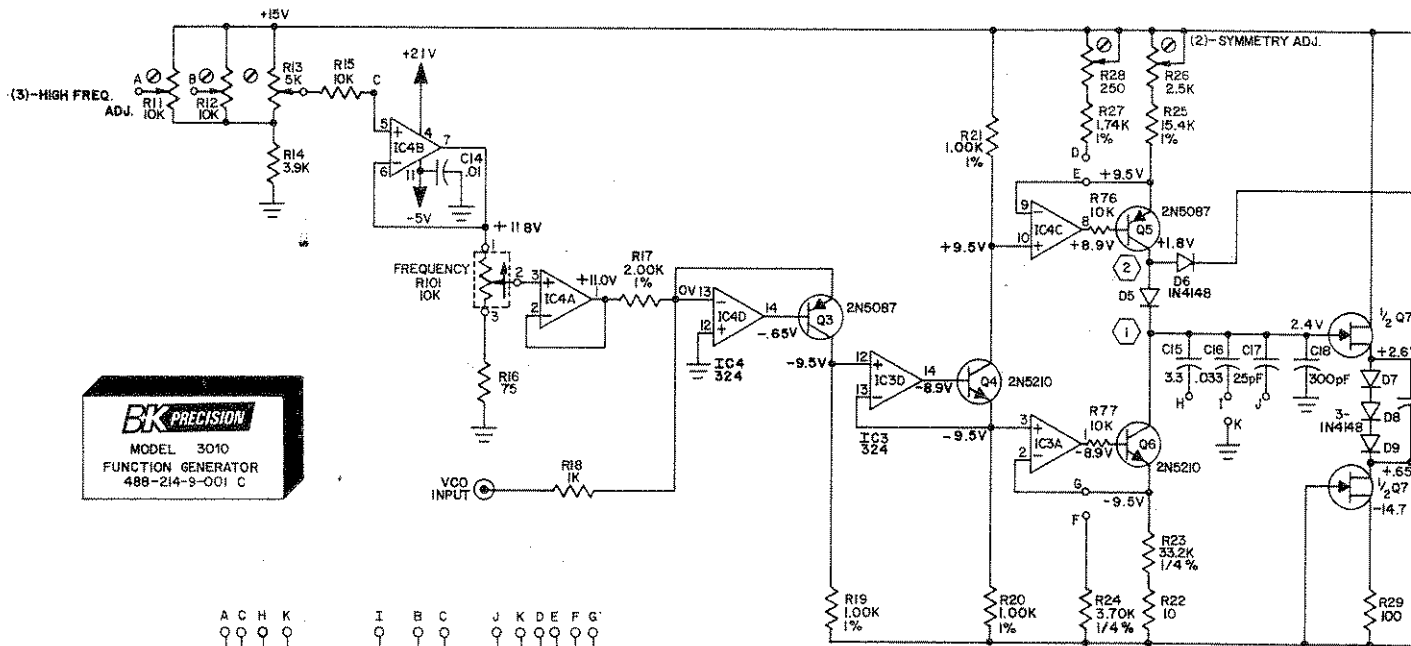
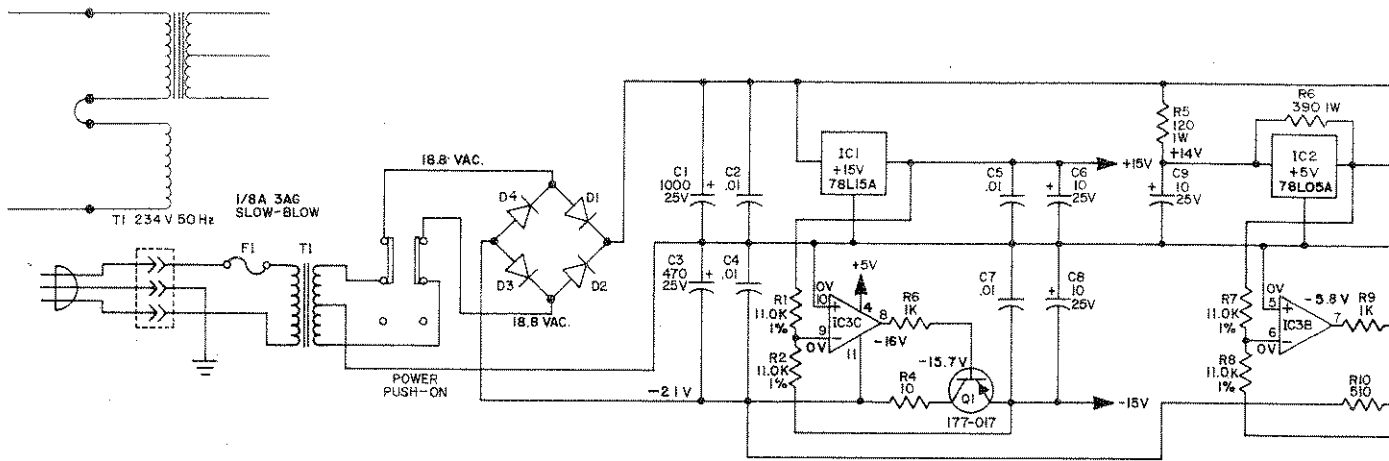

NOTES:

- DC VOLTAGES AND WAVEFORMS WERE OBSERVED WITH THE MODEL 3010 CONTROLS SET AS FOLLOWS:
 FREQUENCY DIAL 10
 RANGE (Hz) X 100
 FUNCTION SINE
 AMPLITUDE ± 40V P-P
 D.C. OFFSET 0
 600 Ω OUTPUT UNTERMINATED
- A B & K MODEL 283 DIGITAL MULTIMETER WAS USED FOR ALL AC & DC MEASUREMENTS.
- A B & K MODEL 1474 OSCILLOSCOPE WITH A 10:1 PROBE WAS USED FOR WAVEFORM MEASUREMENTS. THE VOLTAGE SENSITIVITIES ADJACENT TO EACH WAVEFORM INDICATE THE ACTUAL VOLTAGES. UNLESS OTHERWISE SPECIFIED.
- ALL AC AND DC VOLTAGES ON SCHEMATIC ARE ±10%.
- ALL RESISTORS ARE 1/4W, 5%.
- ARROWS ON POTENTIOMETERS INDICATE CLOCKWISE ROTATION.
- POTENTIOMETERS IN DOTTED RECTANGLES WITH TITLES INDICATE FRONT PANEL NOMENCLATURE.
- ALL CAPACITORS ARE SHOWN IN MICROFARADS.
- THIS SCHEMATIC SUBJECT TO CHANGE WITHOUT NOTICE.

LAST NUMBER USED	NOT USED
R77 (101,102,103)	
C31	C20, 21
IC7	
Q13	
D12	

