

031
SIMULATION

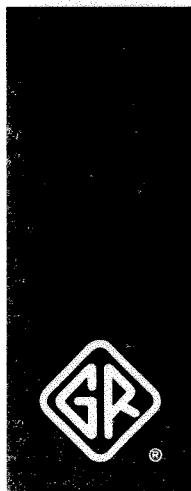

INSTRUCTION MANUAL

GEB

Type 1538-A
STROBOTAC[®]
electronic stroboscope

B

GENERAL RADIO

4260-2

Contents

Specifications

Section 1	Introduction	1
Section 2	Operating Procedure	8
Section 3	Principles of Operation	28
Section 4	Service and Maintenance	33

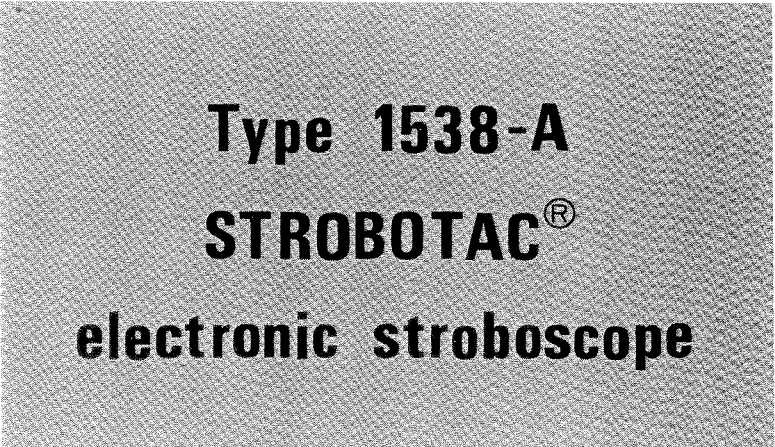

Type 1538-A
STROBOTAC[®]
electronic stroboscope

Copyright 1967 by
GENERAL RADIO COMPANY
West Concord, Massachusetts USA 01781
Form 1538-0100-B
ID-1541
October, 1968

TABLE OF CONTENTS

Section 1 INTRODUCTION	1
1.1 General Description of a Stroboscope	1
1.2 The Type 1538 Strobotac® Electronic Stroboscope	3
Section 2 OPERATING PROCEDURE	8
2.1 Opening the Case	8
2.2 Closing the Case	8
2.3 Power Requirements	9
2.4 Turning the Instrument On	14
2.5 Positioning the Stroboscope	14
2.6 Adjusting the Flashing Rate	14
2.7 Calibration	15
2.8 Speed Measurements	16
2.9 Type 1538 -P2 Extension Lamp	19
2.10 External Synchronization	20
2.11 High-Speed Photography	23
Section 3 PRINCIPLES OF OPERATION	28
3.1 General	28
3.2 The Strobotron Tube	28
3.3 The Charging Circuit	29
3.4 The Calibration Circuit	32
Section 4 SERVICE AND MAINTENANCE	33
4.1 Warranty	33
4.2 Service	33
4.3 Minimum Performance Standards	34
4.4 Maintenance	35
4.5 Trouble Analysis	38
4.6 Replacement of Mechanical Parts	43
FEDERAL MANUFACTURERS CODE	52
PARTS LIST	49,53
SCHEMATIC	51,53
APPENDIX	54

CONDENSED OPERATING INSTRUCTIONS

CALIBRATION.

a. Connect power cable from line or battery to panel plug and turn POWER switch ON. Set RPM range switch to CAL, and FLASH CONTROL switch to INTERNAL.

b. Set RPM dial to 3600 (3000 for 50-Hz operation; refer to paragraph 2.7).

c. After 10-minute warmup, adjust HIGH CAL panel control to stop flashing of CALIBRATE lamp.

d. Set RPM dial to 900 (750 for 50-Hz operation) and adjust LOW CAL control to stop flashing of CALIBRATE lamp.

e. Return to 3600 on dial and readjust HIGH CAL control. Dial now reads within 1 percent.

SPEED MEASUREMENTS.

a. Aim light beam at object.

b. Set RPM knob and dial to higher reading than estimated speed of object.

c. Turn RPM dial slowly clockwise, to reduce flashing rate. Stop at first single image.

RPM dial reading = speed of object.

SUBMULTIPLE SPEED MEASUREMENTS (over 50,000 RPM).

(Refer to paragraph 2.8.2).

a. Start at 150,000 on RPM dial, and decrease flashing rate until single image is obtained.

Dial reading = X

b. Turn dial clockwise (decrease flashing rate) until next single image is obtained.

Dial reading = Y

c. Fundamental speed = $\frac{X \times Y}{X - Y}$.

EXTERNAL TRIGGER.

Set RPM range switch to range that includes frequency of driving signal.

Set FLASH CONTROL switch to EXTERNAL.

Connect external signal to INPUT jack.

Adjust RPM dial for synchronization.

SPECIFICATIONS

Flashing-Rate Range: 110 to 150,000 flashes per minute in four direct-reading ranges: 110 to 690, 670 to 4170, 4000 to 25,000, and 24,000 to 150,000 rpm. Speeds to over 1 million rpm can be measured.

Accuracy: $\pm 1\%$ of reading on all ranges after calibration against line frequency.

Flash Duration: Approximately 0.5, 0.8, 1.2, and $3\mu\text{s}$ for high to low speed ranges, respectively, measured at $1/3$ peak intensity; for single flashes with Type 1538-P4 High-Intensity-Flash Capacitor, $8\mu\text{s}$.

Peak Light Intensity: Typically 0.16, 1, 5, and 15 million beam candles (0.16, 1, 5, and 15×10^6 lux measured at a distance of 1 meter at the beam center) for high to low speed ranges, respectively; 44 million beam candelas for single flash, with Type 1538-P4 High-Intensity-Flash Capacitor.

Reflector Beam Angle: 10° at half-intensity points.

Output Trigger: Greater than 6-V positive pulse behind 400Ω .

External Triggering: Either a switch closure across the input jack terminals, a 1-V, peak, positive pulse, or a 0.35-V, rms, sine wave down to 100 Hz increasing to 3.5 V, rms, at 5 Hz. Maximum should be less than 10 volts, rms.

Power Required: 100 to 125 or 195 to 250 V, 50 to 400 Hz, 15 W or 20 to 30 Vdc, 12 W.

Accessories Supplied: Adjustable neck strap, phone plug for input and output jacks, ac power cable, spare fuse.

Accessories Available: Type 1538-P2 Extension Lamp, Type 1538-P3 Battery and Charger, Type 1538-P4 High-Intensity-Flash Capacitor, Type 1531-P2 Flash Delay, Type 1536-A Photoelectric Pickoff (for use with Flash Delay), Type 1537-A Photoelectric Pickoff, and Type 1539-A Stroboslave.

Mounting: Flip-Tilt Case.

Dimensions: Width $10 \frac{5}{8}$ ", height $6 \frac{5}{8}$ " depth $6 \frac{1}{8}$ " inches (270 by 170 by 160mm), over-all.

Net Weight: $7 \frac{1}{4}$ lb (3.3 kg).

Shipping Weight: 10 lb (4.6 kg).

*Includes handle.

U.S. Patent Nos. 2,977,508, 2,966,257, 3,339,108, 3,350,602

See also *General Radio Experimenter*, April, 1966.

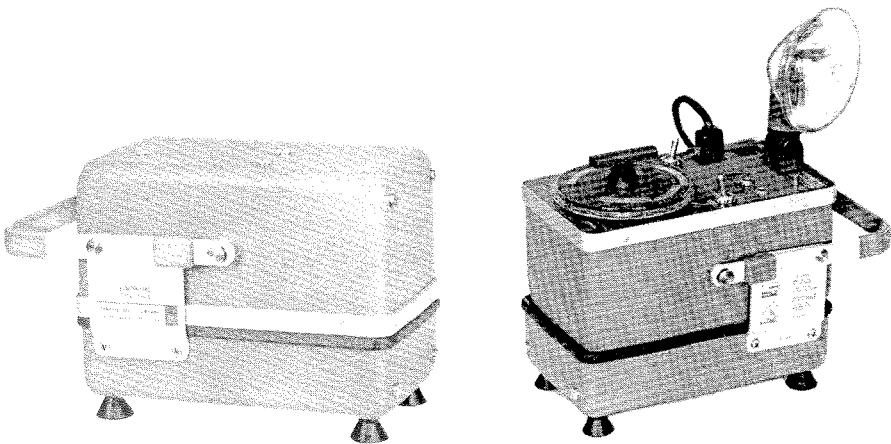

Figure 1-1. Type 1538 Strobotac[®] electronic strobotac in its adjustable Flip-Tilt case.

SECTION 1

INTRODUCTION

NOTE

The GR Handbook of Stroboscopy describes in detail many stroboscopic techniques and applications. Write to General Radio for your copy.

1.1 GENERAL DESCRIPTION OF A STROBOSCOPE.

1.1.1 WHAT IT IS.

A stroboscope is a source of flashing light that can be synchronized with any fast, repeating motion so that a rapidly moving device seems to stand still, or to move slowly.

1.1.2 HOW IT WORKS.

To understand how the stroboscope stops or slows down motion, consider a fan rotating at 1800 revolutions per minute, and a light that is switched on and off 1800 times a minute (i. e., a stroboscope). Since the time between light flashes is the time it takes the fan to make one revolution, every time the light comes on, the fan blades are exactly where they were the previous time the light was on. The blades are never seen in any other position; thus it appears that the fan isn't moving at all. (The retina of the eye holds one image until the next comes along, so there is little, if any, flicker.)

If the light is switched on and off 1801 times a minute (with the fan still turning at 1800 rpm), it is flashing faster than the fan is turning. Therefore, each time the light comes on, the fan blades have not quite reached the position they were in the previous time the light was on. The fan is seen at progressively earlier parts of its cycle and therefore it appears to be turning very slowly backward. In like manner, if the light flashes 1799 times a minute, it reveals the fan at successively later parts of its cycle, so that the fan appears to be moving very slowly forward.

1.2 THE TYPE 1538 STROBOTAC® ELECTRONIC STROBOSCOPE.

1.2.1 GENERAL DESCRIPTION.

Supplementing the basic Type 1531 Strobotac® electronic stroboscope is the Type 1538 (Figure 1-1). In addition to providing a much higher flashing rate than its predecessor, the Type 1538 can be operated from an accessory battery pack or from a power line. It can be used with the Type 1538-P2 Extension Lamp to illuminate hard-to-reach areas. With the plug-in Type 1538-P4 High-Intensity-Flash Capacitor, very short flashes of light of 44 million beam candles can be produced for single-flash-photography applications. Many other accessories are available for use with the stroboscope (refer to paragraph 1.2.4).

The Type 1538 is a small, portable stroboscope, housed in a General Radio Flip-Tilt case. This case serves as a tilting base when the stroboscope is in use and protects the instrument during storage and in transit. The cover of the case is permanently attached to the instrument, and the base contains a tripod mounting socket. The stroboscope can be held in the hand, placed on a convenient flat surface, supported by means of the neck strap provided, or mounted on a tripod as in Figure 1-2.

In the stroboscope, the flashing rate of the tube is governed by the frequency of an internal generator, which is adjusted by means of the RPM controls, a bar knob, and a large-diameter dial. The knob selects any of four direct-reading RPM ranges; the dial is concentric with the bar knob and provides precise setting of the flashing rate. The screwdriver-adjust potentiometers on the panel are used to set the calibration at the low and high ends of the dial. The flashes of a neon light on the panel serve as an indicator for calibration.

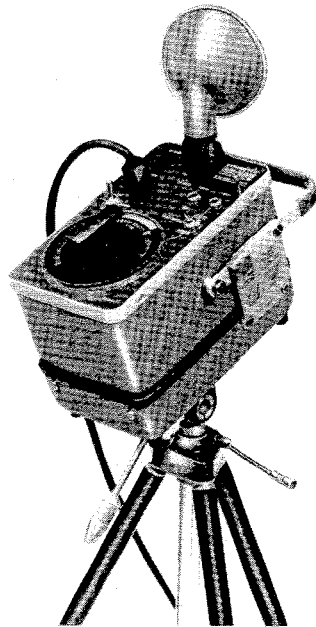
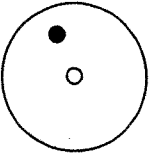

Figure 1-2. The stroboscope can be mounted on a standard camera tripod.



The following example illustrates this principle:



A white disc, with a single black dot, is mounted on the shaft of a 1200-rpm motor.

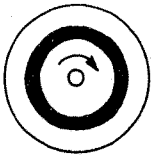

When the disc is rotating at 1200 rpm, it is impossible for the human eye to distinguish a single image and the dot appears to be a blurred continuous circle.

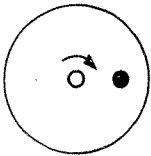

When the disc is illuminated by the flashing stroboscopes light, which is synchronized to flash once every revolution of the disc (when the dot is at 3 o'clock, for example), the dot will be seen at this position – and only at this position – at a rate of 1200 times each minute. Thus, the dot will appear to “freeze” or stand still.



Now, if the flashing rate of the stroboscopes is slowed to 1199 flashes per minute, the dot will be illuminated at a slightly different position each time the disc revolves, and the dot will appear to move slowly in the direction of rotation, through 360°, and arrive back at its original position (3 o'clock) one minute later.

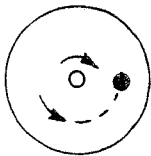

A similar movement, but in a direction opposite to the rotation of the dot, will be observed if the flashing rate of the stroboscopes is increased to 1201 rpm. If desired, the rate of apparent movement of the dot can be speeded up by further increasing or decreasing the stroboscopes flashing rate.

1538-12

If the flashing rate of the stroboscopes is known, this is also the speed of a moving device made to “stop” under the stroboscopes’ light. Thus, the stroboscopes has the dual purpose of measuring speed and of apparently slowing down or stopping rapid motion, for observation. The practical significance of the slow-motion effect is that, since it is a true copy of the high-speed motion, all irregularities (vibration, torsion, chatter, whip) present in the high-speed motion can be viewed and studied (refer to paragraph 2.8.5).



TYPE 1538 STROBOTAC ELECTRONIC STROBOSCOPE

The strobotron lamp is mounted on a swivel arm and the reflector can be rotated about the lamp, which makes it possible to aim the light beam in almost any direction. The high-intensity lamp provides adequate illumination for most objects, even in normal ambient light.

When not in use, the detachable ac power cable is wound around the reflector and the range-switch knob (refer to paragraph 2.2).

1.2.2 CONTROLS AND CONNECTORS.

All controls and connectors are located on the front panel of the instrument (see Figure 1-3). The type and function of each are given in Table 1-1.

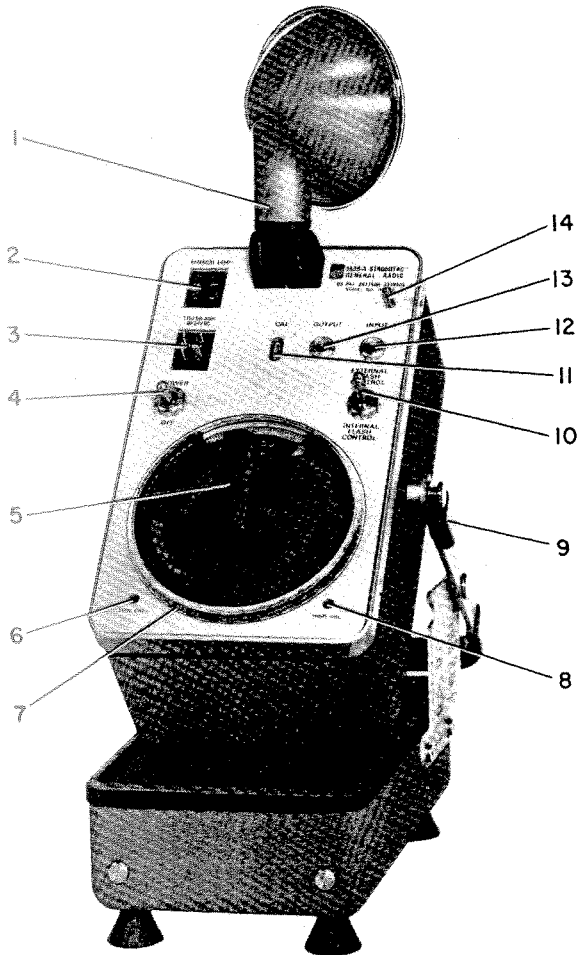

Figure 1-3. The front panel of the stroboscope, showing the controls and connectors.

Table 1-1
Controls, Connectors, and Indicators

<i>Figure 1-3 Reference</i>	<i>Name</i>	<i>Type</i>	<i>Function</i>
1	None	Reflector and swivel arm of strobotron lamp assembly.	Can be rotated to aim the light beam.
2	EXT LAMP	4-prong multipoint socket	Provides a panel connection for the Type 1538-P2 Extention Lamp or the Type 1538-P4 High-Intensity-Flash Capacitor.
3	115 V 50-60 C 24 VDC	4-prong multipoint plug	Accepts the power cable from the power line or from the Type 1538-P3 Battery and Charger.
4	POWER (ON-OFF)	2-position toggle switch	Turns instrument ON or OFF.
5	RPM range switch	5-position rotary switch	Selects any of the four RPM ranges or the CAL range.
6	LOW CAL	Screwdriver control through panel	Calibrates the low end of the RPM dial.
7	RPM dial	4-inch dial with fluted-rim control	Sets the frequency of the internal oscillator. It is calibrated directly in revolutions per minute.
8	HIGH CAL	Screwdriver control through panel	Calibrates the high end of the RPM dial.
10	FLASH CONTROL (EXTERNAL-INTERNAL)	2-position toggle switch	Selects either a signal from the internal generator or one applied externally at the INPUT jack.
11	CALIBRATE	Neon lamp	Its flashing indicates the correct setting of the CAL potentiometers for calibration of the RPM dial.
12	INPUT	Phone jack	Connects the stroboscope to an external synchronizing signal from either an electrical device or a mechanical contactor (refer to paragraph 2.10.1).
13	OUTPUT	Phone jack	Trigger pulse is available at this jack for triggering accessory instruments (refer to paragraph 2.10.8).
14	None	1/2-inch pin (3/16-inch diameter)	Serves as a holding device for the ac power-cable plug when the instrument is not in use (refer to paragraph 2.2).



1.2.3 ACCESSORIES SUPPLIED.

Supplied with the stroboscope are:

- 1 - 1531-7070 - Adjustable neck strap
- 1 - 4270-1100 - Phone plug for INPUT or OUTPUT jack
- 1 - 4200-0420 - Ac power cable
- 1 - 5330-0700 - Spare fuse, 0.25-amp.

1.2.4 ACCESSORIES AVAILABLE.

The accessories listed in Table 1-2 are available for use with the stroboscope. They are described elsewhere in this book, as noted in the table.

Figure 1-4 shows a typical setup, using the stroboscope with the pickoff, the flash delay, and the stroboslave.

Table 1-2
Available accessories for the Type 1538 Stroboscope

<i>Type No.</i>	<i>Name</i>	<i>Function</i>
1538-P3	Battery and Charger	Offers rechargeable 24-volt dc battery-power option (paragraph 2.3.3).
1538-P2	Extension Lamp	Operates up to 6 feet from stroboscope (paragraph 2.9).
1531-P2	Flash Delay	Provides continuously adjustable time delay between external trigger pulse and stroboscope flash (paragraph 2.10.2).
1536	Photoelectric Pickoff	With the Type 1532-P2 Flash Delay and the stroboscope, permits analysis of motion of objects rotating at relatively steady speeds (paragraph 2.10.2).
1537	Photoelectric Pickoff	Similar to Type 1536-A Pickoff, but with no light source (paragraph 2.10.3).
1531-P3	Surface-Speed Wheel	When held against a linearly moving device observed with a stroboscope, permits accurate speed measurement (paragraph 2.10.4).
1535	Contactorr	With the stroboscope, makes possible observation of an object rotating at irregular speeds (paragraph 2.10.5).
1539	Stroboslave	A small stroboscope without internal oscillator (paragraph 2.10.6).
1538-P4	High-Intensity-Flash Capacitor	Increases light output 10 times, for single-flash photographic applications (paragraph 2.11.7).

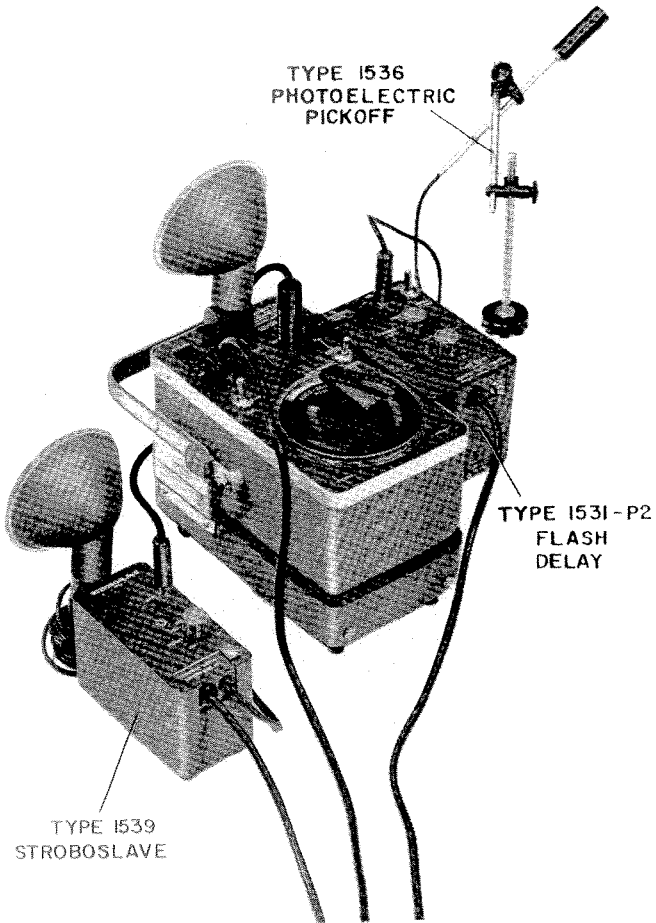

Figure 1-4. Many accessories are available for use with the stroboscope. Here the setup includes the Type 1536 Photoelectric Pickoff, the Type 1531-P2 Flash Delay and the Type 1539 Stroboslave.



SECTION 2

OPERATING PROCEDURE

2.1 OPENING THE CASE.

To open the Flip-Tilt case, proceed as follows:

- a. Set the instrument on a flat surface so that it rests on its rubber feet.
- b. Unlock the case by sliding the two gray latch blocks, 9, Figure 1-3, (one on each side of the case) away from the handle. (It may be necessary to push down on the top of the instrument to release the latch blocks).
- c. Using the palm of the hand, push the handle down as far as possible. With the other hand, swing the instrument to the desired angle. Lower the instrument onto the rubber gasket by slowly releasing the handle. The instrument will be held in position at any angle from vertical to about 30° by its friction against the gasket. However, the case is not locked in place and it may not stay in a tilted position under severe vibration. If the instrument is to be hand-held, nestle the case into the cover and lock it in by sliding the latch blocks toward the handle.
- d. Disengage the 3-terminal ac-power-cable plug and unwind the cable from around the range-switch bar knob and the reflector.

2.2 CLOSING THE CASE.

To close the case for storage or transit of the instrument, proceed as follows:

- a. Set the range-switch knob to the 4000-25000 RPM position.
- b. Turn the reflector down against the panel, facing up.
- c. Push the 4-prong socket (1, Figure 2-1) at one end of the ac power cable onto the panel power plug (3, Figure 1-3) and wind the cable in a counterclockwise direction around the range-switch bar knob and the reflector.

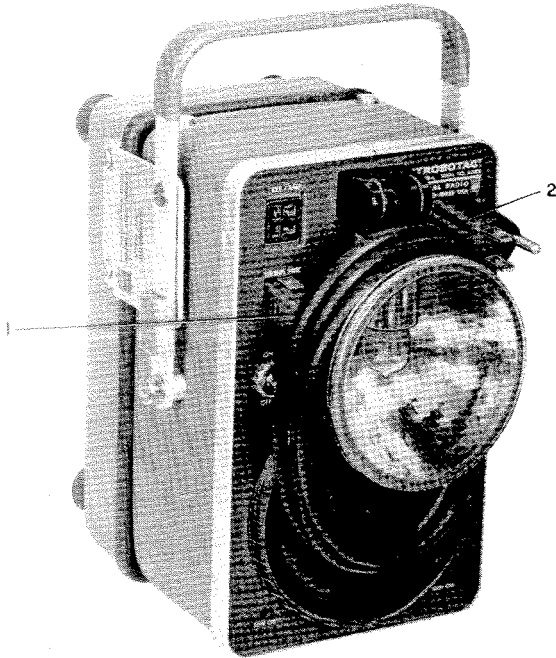

Figure 2-1. Method of storing the ac power cable when the instrument is not in use.

d. To secure the cable end, slide the 3-wire plug (2, Figure 2-1) onto the 1/2-inch pin (14, Figure 1-3) on the panel.

e. To complete the closing of the case, push down slightly on the handle of the case with one hand, and with the other swing the instrument so that the panel is facing down. Lower the instrument onto the rubber gasket by slowly releasing the handle. Apply light pressure on the top of the case and slide the two gray latch blocks (9, Figure 1-3) toward the handle to lock the case.

2.3 POWER REQUIREMENTS.

2.3.1 POWER-LINE OPERATION.

The Type 1538 Strobotac electronic stroboscope can be operated from a 115- or 230-volt, 50- to 60-Hz or 400-Hz line, as well as from a 24-volt dc supply. For line operation, one end of the ac power cable (P/N 4200-0420) mates with the 4-prong plug (labelled 115V 50-60 C 24 VDC) on the panel and is locked in place by the two attached clips. (To unlock the clips, squeeze them toward each other with thumb and forefinger.)

The input line voltage for which the instrument is wired is noted on the panel, directly above the power plug. To change from 115-volt to 230-volt operation, remove the two jumpers on transformer T501 between terminals 1 and 3 and terminals 2 and 4, and add a jumper between terminals



2 and 3 (see Figure 2-2 and the schematic diagram, Figure 4-14). A 0.25-ampere fuse is used for either line voltage. To indicate a change to 230-volt operation, order an input power plate, P/N 1538-8110, from General Radio. This plate, marked 230 V, 50-60 C, 24 VDC, can be cemented onto the panel, over the 115-V marking.

To change the instrument from 230- to 115-volt operation, remove the jumper on transformer T501 between terminals 2 and 3 and add jumpers between terminals 1 and 3 and terminals 2 and 4 (see Figure 2-2 and the schematic diagram, Figure 4-14).

Always be sure the power to be applied corresponds with the panel marking above the panel power plug.

The male end of the power cable has three terminals. The third pin (ground) on the power plug has been added for the safety of the operator; it should not be disconnected. If a 2-way adaptor must be used, be sure the instrument is properly grounded.

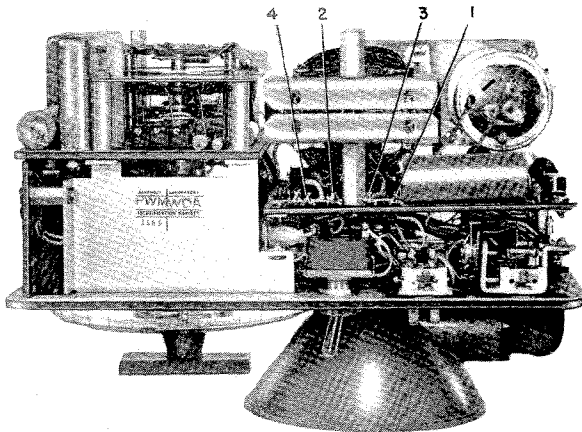

Figure 2-2 The transformer terminals on the stroboscope are numbered as shown.

2.3.2 BATTERY OPERATION.

The stroboscope will also operate on 24 volts dc. The Type 1538-P3 Battery and Charger (Figure 2-3) is recommended for this type of operation (see paragraph 2.3.3). The dc power also is applied at the 4-prong plug (3, Figure 1-3) on the panel, and is controlled by the ON-OFF, POWER switch (4, Figure 1-3).

The 0.25-ampere fuse in the stroboscope is not in the circuit for dc operation, but protection is maintained by the 1-ampere fuse mounted on the battery case.

The Type 1538 cannot be calibrated when operating on dc power. Calibration on ac (refer to paragraph 2.7) is valid for both ac and dc operation and will hold for a long period of time.

Figure 2-3. Type 1538-P3 Battery and Charger.

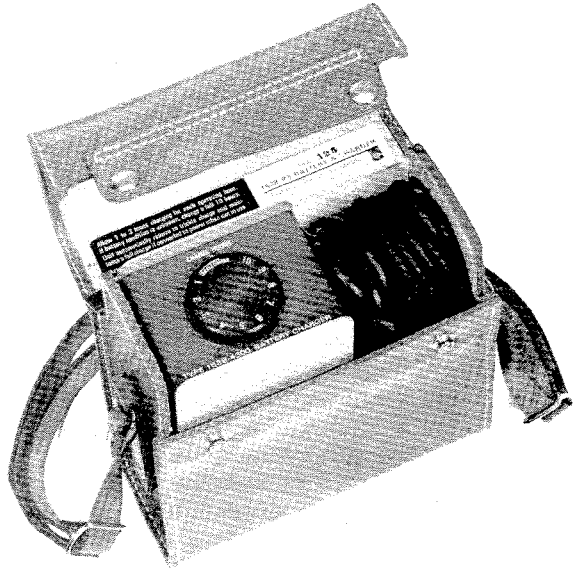

2.3.3 TYPE 1538-P3 BATTERY AND CHARGER.

The Type 1538-P3 Battery and Charger (Figure 2-3) is available as an optional accessory for the Type 1538 stroboscope. It includes a rechargeable nickel-cadmium battery and an automatic battery charger, mounted together in a leather carrying case with an adjustable shoulder strap.

The battery power cable is permanently attached to the battery. For battery operation, simply mate the socket on the end of the cable with the 4-prong plug (labelled 115 V 50-60 C 24 VDC) on the panel of the stroboscope. The cable is locked to the panel by the two clips on the socket; to remove the cable, press the clips toward each other with thumb and forefinger.

Table 2-1
Part numbers for the items included in the
Type 1538-P3 Battery and Charger.

<i>Item</i>	<i>Part Number</i>
Battery and Case Assembly	1538-4310
Battery Unit Assembly (part of 1538-4310)	1538-3310
Case Assembly (part of 1538-4310)	1538-0460
Battery-Charger Assembly	1538-4300

For a detailed parts list and schematic, refer to Section 4.

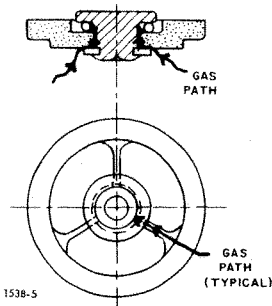

Figure 2-4. The resealable vent in the General Electric battery cells.

THE BATTERY

The battery consists of 20 sealed cylindrical G.E. cells, which supply 24 volts at 2 ampere-hours. The cells incorporate a resealing, safety vent mechanism (Figure 2-4) that will not open during normal battery usage; but, should excessive gas pressure build up within the cell, the vent opens at a predetermined internal pressure. This pressure build-up causes distortion of the "O" ring and creates a gas path to the atmosphere. When pressure within the cell returns to atmospheric pressure, the "O" ring returns to its original shape and position, and reseals the opening.

THE CHARGER

The charger included in the Type 1538-P3 Battery and Charger is a constant current type and plugs directly into the battery. A two-prong plug on the bottom of the charger case mates with a socket on the top of the battery. One end of the power-line cable (P/N 4200-1924), is permanently attached to the charger. A switch on the side of the charger case must be set for either 115 V, 60 Hz or 230 V, 50 Hz, depending upon the source of power to be used for charging. Be sure the power-line cable is connected to a power source that corresponds with the position of the switch.

To charge the battery:

- a. Plug the charger into the battery and connect the charger power-line cable to the source of power.
- b. Turn the automatic-timer dial on the charger to the desired number of hours of charging.

NOTE

If the charger is used on a 50-Hz line, the charging time will be somewhat longer than is indicated by the numbers on the dial.

At the end of this time, the charger will switch automatically to trickle charge, which will continue until the dial is reset or the line power is removed from the charger.

When first received, the battery should be charged for about 10 hours. With the automatic timer, a completely discharged battery can be charged to 70% of full capacity in 10 hours. A fully charged battery will power the Type 1538 for about 8 hours of normal, intermittent operation, after which a 10-hour, overnight charge should be adequate to return the battery to

100% capacity (see Figure 2-5). If the maximum operating time has been approached, a full 14-16 hours will be required to recharge the battery to full capacity (as shown by the curves). With no warm-up time required by the Type 1538, the POWER switch should always be turned OFF when the instrument is not in use, to conserve the charge.

Although the life of the battery cells may be somewhat shortened by continual overcharging in the constant-current mode, they can be left on trickle charge for an indefinite period.

The cell life of the battery is reduced by:

- Repeated complete or nearly complete discharging of the battery;
- Severe overcharging.

Under average operating conditions, the number of charge/discharge cycles may exceed 5000 before replacement of the battery becomes necessary. However, if the battery is deeply discharged, a cycle life as low as 300 may result. If the state of charge of the battery is unknown, recharge it for ten hours.

Continuous trickle charging will maintain 100% capacity of the battery during prolonged storage periods. The battery will discharge with time if

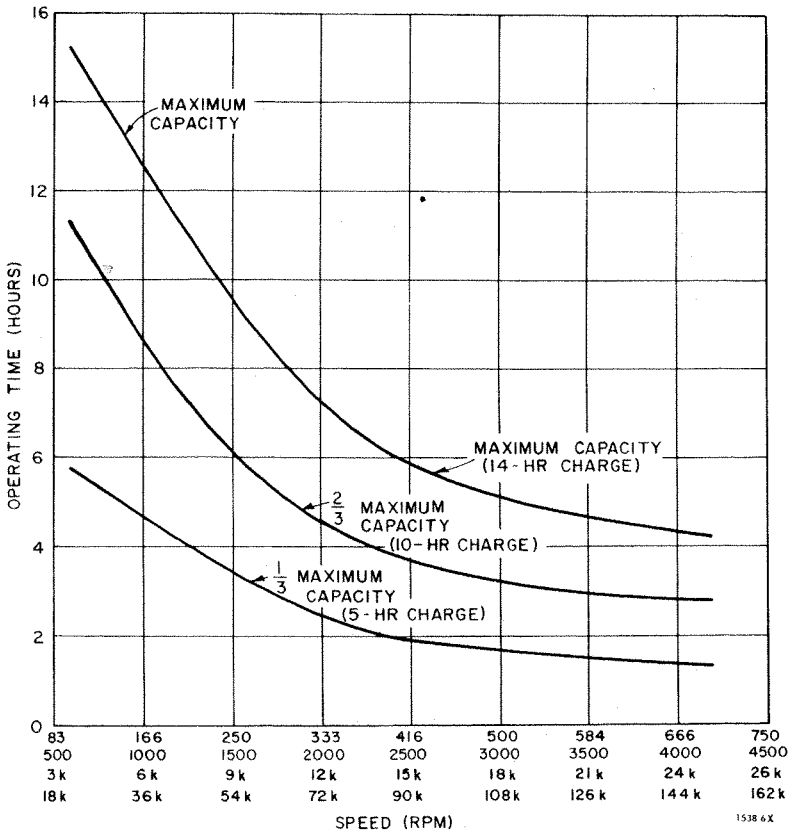

Figure 2-5. Operating time vs speed (RPM readings).

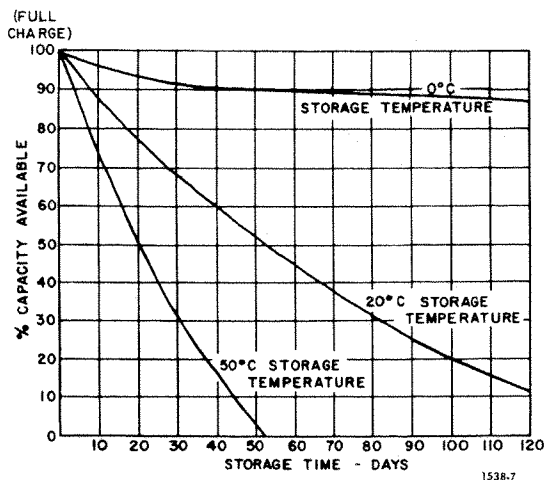

Figure 2-6. Typical charge-retention characteristics of the battery.

trickle charging is not used; the rate of discharge depends on the storage temperature, as shown in Figure 2-6.

2.4 TURNING THE INSTRUMENT ON.

After connecting the power cable to the power line or battery and to the instrument, pivot the reflector assembly to an upright position and snap the POWER switch ON. The stroboscope is ready for use immediately.

2.5 POSITIONING THE STROBOSCOPE.

The light beam can be aimed in almost any direction by means of the swivel arm and the rotating reflector (1, Figure 1-3). The intensity of the light pulse is so high and the beam angle is so small that it is usually not necessary to place the unit close to the object being viewed. If the instrument is to be held in the hands for a long period of time, the adjustable neck strap (supplied) can be used to provide added support. The strap can be adjusted to any one of five different lengths by the use of various combinations of the six slots, three in each end of the strap. Slip the appropriate slots in the strap over the buttons projecting from the sides of the case.

2.6 ADJUSTING THE FLASHING RATE.

The flashing rate of the strobotron lamp is adjusted by means of the RPM range-switch knob and the RPM dial (5 and 7, Figure 1-3). The overall speed range of the stroboscope is divided into four overlapping ranges selected by the range-switch knob. The speed limits for each range are marked near the appropriate window in the range mask. The windows on the mask reveal only the range in use.

To operate the RPM dial, turn it by means of the fluted, transparent rim that surrounds the range-switch mask. The red indicator line over the dial scale gives the speed setting in flashes per minute (corresponding to rpm) for speed measurements.

2.7 CALIBRATION.

To use the stroboscope for the most accurate measurements of speed, the RPM dial can be calibrated to the frequency of the ac power line. The calibration is then valid for either ac or battery operation. There is no provision for calibrating the instrument on battery power.

To calibrate the Type 1538, proceed as follows:

- a. Allow the instrument to warm up for at least ten minutes.
- b. Turn the RPM range switch to the CAL position.
- c. Set the RPM dial to 3600* RPM

(60 cycles/second x 60 seconds/minute)

by rotating it until the mark at 3600* is exactly under the red indicator line.

d. Adjust the panel screwdriver control marked HIGH CAL until the flashing of the neon CALIBRATE lamp stops (or nearly stops). The lamp may remain on, off, or barely on, but it should not be changing. The longer the time required for the lamp to complete one cycle – from on to off, then on again – the closer the setting of the potentiometer is to an exact calibration. For example, if the CALIBRATE lamp takes two seconds to complete one full cycle, with the RPM dial set at 3600, the error in the dial calibration is:

$$\frac{3600 \text{ rpm}}{60 \text{ cycles/sec} \times 2 \text{ sec/cycle}} = 30 \text{ cycles/min (rpm)}$$

NOTE

Do not confuse the characteristic flicker on low ranges with the on-off action referred to here. When the CAL setting is very close to the power-line frequency, the CAL lamp will vary in intensity very slowly.

e. Set the RPM dial to 900** and repeat step d, using the LOW CAL screwdriver adjustment on the front panel. On this range, for example, a two-second flashing period of the CALIBRATE lamp represents an error of:

$$\frac{900 \text{ rpm}}{60 \text{ cycles/sec} \times 2 \text{ sec/cycle}} = 7.5 \text{ cycles/min (rpm)}$$

f. Return the RPM dial to 3600* and repeat the procedure of step d until the CALIBRATE lamp is flashing very slowly or not at all. (This step is not necessary unless the LOW CAL adjustment was changed significantly.)

g. In general, it is not necessary to return to the 900** RPM point to repeat the procedure unless a very precise calibration is required. The RPM dial is now calibrated to within ± 1 percent on all ranges.

*3000, if 50-Hz line is used.

**750, if 50-Hz line is used.



2.8 SPEED MEASUREMENTS.

2.8.1 FUNDAMENTAL-SPEED MEASUREMENT.

If the speed of the object being viewed is not known at least approximately, start at a high flashing rate where multiple images result and reduce the flashing rate until a single image is obtained. The first single image occurs when the flashing rate is equal to the rotational speed of the object and the speed can then be read directly from the RPM dial.

IMPORTANT: To determine that a single image has been obtained, the object being viewed must have some identifying mark to provide non-symmetry. For instance, a four-bladed fan must have a mark on one blade only, or a piece of tape can be applied to one tooth of a gear to produce the images shown in Figure 2-7.

On the three lower-speed ranges, a quick check on whether or not the stroboscope is flashing at the fundamental speed of the device being measured can be made by simply switching to the next range without moving the RPM dial. Since the ratio between ranges is approximately 6:1, six images will appear at the next higher range when the stroboscope has been

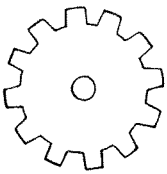

Gear not marked for speed measurement. Simple observation is possible but observer cannot be certain if image is single or multiple.

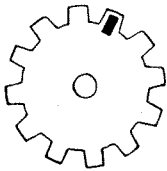

Single image observed with tape applied to one tooth of gear.

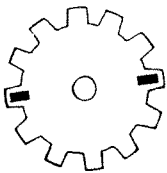

Multiple (double) image observed with tape applied to one tooth of gear. Images are 180° apart. (Stroboscope is flashing twice in one revolution of the gear.)

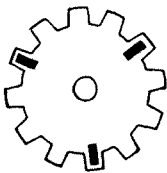

Multiple (triple) image observed with tape applied to one tooth of gear. Images are 120° apart. (Stroboscope is flashing three times in one revolution of the gear.)

1531-2

Figure 2-7. Stroboscopic images produced by a rotating gear.

set to the fundamental speed. If only three images appear, for example, the stroboscope has been set to one-half the correct frequency.

On the high-speed range, double the speed setting of the RPM dial to check for fundamental-speed operation. A double image will occur when the frequency setting is doubled. If the fundamental speed of the device being measured is above 75,000 rpm, it is not possible to check for the correct speed setting by this method. In this case, refer to paragraph 2.8.3.

NOTE

Multiple images will always be observed when the flashing rate of the stroboscope is set to a multiple of the fundamental speed of the object. As the flashing rate is reduced from a rate higher than the fundamental speed of the object, the first single image will appear when the flashing rate is equal to the fundamental speed. Make the quick check described above to be sure that the first single image has not been missed.

2.8.2 SUBMULTIPLE SPEED MEASUREMENTS.

When the flashing rate is below the fundamental speed of the object, single and multiple images will be observed. If the stroboscope flashes at an integral submultiple of the speed of the rotating object under observation (such as 1/2, 1/3, 1/4, ----- 1/n), the motion of the object will be "stopped," showing a single image, just as it will at the fundamental speed. If speed measurements are being made, it is necessary to determine whether the stroboscope is flashing at a submultiple rate or at the fundamental rate, as described in paragraph 2.8.1.

Where convenient, switching to a lower range with its submultiple flashing rate (approximately 1/6 of the fundamental frequency) will often prove helpful because of the brighter image obtainable.

Submultiple flashing is necessary to observe or measure the speed of objects moving at rates above 150,000 rpm. Refer to paragraph 2.8.3 for the method of determining the fundamental speed when submultiple operation is necessary.

At flashing rates between integral submultiples, multiple images will be observed. Table 2-2 gives some examples of submultiple speeds and the corresponding number of images produced for a fundamental speed of 180,000 rpm. Note the numerical relationship between the numerator of the submultiple fraction and the number of images. This relationship is true for all submultiple speeds.

Table 2-2

Relationship between submultiple speed settings and number of images produced for a fundamental speed of 180,000 rpm.					
Submultiples of Fundamental Speed (180,000 rpm Assumed)	Number of Images Produced	Reading of Range Switch RPM Dial	Submultiples of Fundamental Speed (180,000 rpm Assumed)	Number of Images Produced	Reading of Range Switch RPM Dial
1	1	180,000	1/2	1	90,000
5/6	5	150,000	2/5	2	72,000
4/5	4	144,000	1/3	1	60,000
3/4	3	135,000	1/4	1	45,000
2/3	2	120,000	1/5	1	36,000
3/5	3	108,000	1/6	1	30,000



2.8.3 MEASUREMENT OF SPEEDS ABOVE 150,000 RPM.

By means of submultiple synchronization, speeds up to about 1 million rpm can be measured accurately with the stroboscope. The procedure is as follows:

a. Starting at 150,000 rpm, decrease the flashing rate of the stroboscope by turning the RPM dial clockwise until a single image is obtained. Record the reading of the RPM dial and call it X.

b. Observe the stroboscopic images as the reading of the RPM dial is slowly decreased. Stop when the next single image appears. Record the new reading of the RPM dial and call it Y.

c. Calculate the harmonic number, n, by $n = \frac{Y}{X-Y}$. Round off the value of n to the nearest whole number.

d. Calculate the fundamental speed, S_f , by $S_f = nX$.

For example, if the first single image occurs at $X = 77,200$ rpm and the second single image occurs at $Y = 58,000$ rpm, then

$$n = \frac{58,000}{77,200 - 58,000} = 3.02.$$

Rounded off to the nearest whole number, $n = 3$. The fundamental speed is then

$$S_f = 3 \times 77,200 = 231,600 \text{ rpm.}$$

2.8.4 LOW-SPEED OPERATION.

The measurement of speeds on the low range of the instrument (below about 600 rpm) is complicated by the flicker resulting from the inability of the eye to carry over the image from one flash to the next. Such measurements should be made in a darkened environment to reduce the disconcerting effect of high ambient room lighting on the observed pattern. Dark glasses, worn by the operator, may prove helpful.

Speeds below 110 rpm can be measured by means of multiple images. For example, if the flashing rate of the stroboscope is twice the fundamental speed of the device, two images, 180 degrees apart, will appear. At three times the fundamental speed, three images, 120 degrees apart, will appear, etc.

This multiple-image technique can also be used for higher speeds, within the range of the stroboscope, where flicker makes it difficult to tell when the correct flashing rate is obtained (for example, between 110 and 600 rpm).

2.8.5 SLOW-MOTION STUDIES.

High-speed motion can be reproduced by the stroboscope at an apparently much lower speed if the cyclic or reciprocating motion occurs at a constant rate. If the flashing rate of the stroboscope is set at a speed slightly lower than the fundamental speed of the observed object, the object will appear to move slowly in the same direction as the actual motion, as noted in paragraph 1.1.2, at a speed equal to the difference between the

actual speed of the object and the flashing rate of the stroboscope. If the flashing rate is set slightly higher than the speed of the object being observed, the same slow motion will result, but in the opposite direction. This stroboscopic technique of slowing down motion can be extremely useful in investigating the operation of a device under normal operating conditions. Excessive vibration, misalignment of parts, mode of vibration of equipment on a shake table, operation of vibrating reeds, actual relation between traveler and thread during a complete revolution of the traveler on a textile spinning frame — these are a few examples of the many slow-motion studies that are possible with the Type 1538.

2.9 TYPE 1538-P2 EXTENSION LAMP.

For use in spaces too small for the complete stroboscope, the Type 1538-P2 Extension Lamp (Figure 2-8) is a convenient accessory. The lamp and reflector in this assembly are identical to those on the Strobotac. The assembly is supplied with a six-foot cord and a plug that mates with the panel socket marked EXT LAMP. When plugged in, the Extension Lamp flashes instead of the lamp on the stroboscope. This accessory makes it possible to mount the lamp in small out-of-the-way places such as test chambers and to control it from a safe distance.

Additional cable up to 50 feet long can be used with the Extension Lamp. The cable (ESMW-85) and connectors are available from General Radio. However, when additional cable is used, the peak intensity of the flash decreases. For instance, with a 25-foot cable, the peak light output is reduced to one fourth of its original value, the flash duration is doubled, and the total light output is reduced to one half.

NOTE

The Type 1538-P2 Extension Lamp and the Type 1538-P4 High-Intensity-Flash Capacitor cannot be used simultaneously.



Figure 2-8. Type 1538-P2 Extension Lamp.



2.10 EXTERNAL SYNCHRONIZATION.

2.10.1 USE OF THE INPUT JACK.

The instrument can be triggered by any electrical signal of at least 1 volt, peak-to-peak, (to a maximum of 10 volts, rms) applied at the INPUT jack. For sine-wave inputs, the unit will operate with a 0.35-volt (rms) signal down to 100 Hz. Below this frequency the required amplitude increases to 3.5 volts at 5 Hz. For pulse inputs (i.e., step-wavefront signals), the repetition rate can have any minimum value. The instrument can be synchronized with external signals at frequencies up to at least 150,000 rpm (2.5 kHz). Because a positive-going signal is required at the input to flash the stroboscope, positive pulses are required to synchronize on the leading edge. Negative pulses will result in a delay depending on the trailing-edge characteristics of the input pulse.

To operate the stroboscope from an external electrical signal, set the RPM range switch so that the frequency of the driving signal ($f = \frac{\text{RPM}}{60}$) does not exceed the maximum frequency indicated on the range mask. Set the FLASH CONTROL switch to EXTERNAL. Connect the external signal to the INPUT jack on the panel; use the standard phone plug supplied. Starting at the fully clockwise position, adjust the RPM dial until satisfactory synchronization is obtained. For large-amplitude inputs there will be a wide range of settings for the RPM dial at which the instrument will operate satisfactorily. For small-amplitude inputs, the range will be correspondingly smaller.

2.10.2 TYPE 1531-P2 FLASH DELAY AND TYPE 1536 PHOTOELECTRIC PICKOFF.

Two very useful accessories for the stroboscope are the Type 1531-P2 Flash Delay and the Type 1536 Photoelectric Pickoff. The combination of these three instruments (Figure 2-9) makes it possible to synchronize the flash of the Type 1538 with the moving object at any desired point in the cycle of operation of the object. These synchronizing devices can operate at very high speeds and do not load the machine under observation.

The Type 1531-P2 Flash Delay is a small, portable, time-delay unit, used to insert a controlled delay period between an externally generated trigger pulse and the resulting light flash from the stroboscope. The flash delay also provides a convenient method of obtaining single-flash photographs at any desired point in the cycle of the moving object.

The Type 1536 Photoelectric Pickoff is used to convert the motion of an object to electrical impulses that can be applied to the stroboscope. It consists of a light source, a simple cylindrical optical system, and a photocell. Variations in reflectivity, produced by the motion of the object being observed, produce electrical signals that are amplified, delayed, and shaped by the Flash Delay, and are then fed to the stroboscope. Power for both the photocell and the lamp are supplied by the Type 1531-P2 Flash Delay.

The reader should refer to the Appendix of this book and to the Operating Instructions for the Type 1531-P2 Flash Delay and the Type 1536 Photoelectric Pickoff for further information concerning these instruments and their use with the Type 1538 Stroboscope.

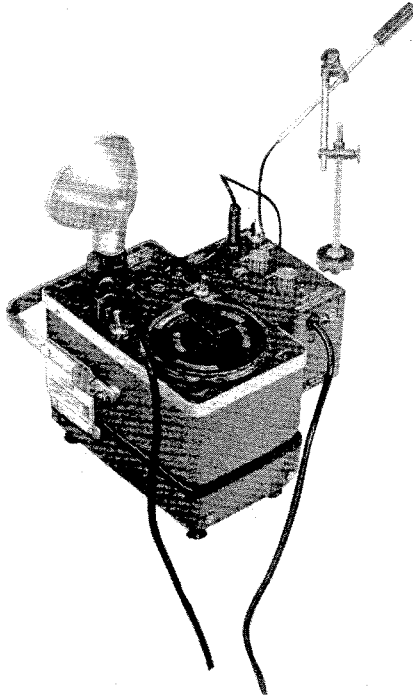

Figure 2-9. A widely used combination consists of the stroboscope with the Type 1531-P2 Flash Delay and the Type 1536 Photoelectric Pickoff.

2.10.3 TYPE 1537 PHOTOELECTRIC PICKOFF.

The Type 1537 Photoelectric Pickoff differs from the Type 1536 in that no light source is included. The photosensitive element is a silicon light-activated switch. This pickoff will trigger directly the Type 1538 Stroboscope. Refer to the Instruction Manual for the Type 1537 for further details on the operation of this accessory; its specifications are given in the Appendix of this book.

2.10.4 TYPE 1531-P3 SURFACE-SPEED WHEEL.

Also available as an accessory for the Type 1538 Strobotac is the Type 1531-P3 Surface-Speed Wheel. It consists of two nylon disks of different sizes, each marked with a white radial stripe, and a sectioned steel rod on which the disks can rotate freely. Either disk, when held against a moving belt, will rotate at the belt's speed. The rotating disk is illuminated by the flashing light of the stroboscope. When the dial of the Type 1538 is adjusted to give the proper stationary image, the linear speed of the belt (or similar linearly moving object) can be determined from the dial reading. The larger disk (circumference \approx 0.5 foot) is designed for



the measurement of linear speeds up to 12,500 feet per minute, the smaller disk (circumference = 0.2 foot) for linear speeds to 2500 feet per minute.

Specifications for the Type 1531-P3 Surface-Speed Wheel are given in the Appendix. A complete description of its use will be found in the Operating Instructions for the wheel.

2.10.5 TYPE 1535 CONTACTOR.

For speeds below 1000 rpm, when significant speed variations may be expected, a mechanical contactor can be used. The Type 1535 Contactor includes a set of breaker contacts and a cam to open and close them. The contact action is used to synchronize the movement of a device to a stroboscope. The contactor can be attached to a shaft of a machine by using one of a number of magnetic or mechanical couplers supplied. The angular position (phasing) of the contacts with respect to the shaft is adjustable over 360 degrees. The angle of rotation of the contacts from any arbitrary zero point is read directly in degrees on a calibrated scale.

To control the Type 1538 Strobotac by the contactor, insert the plug at the end of the contactor cable into the INPUT jack on the panel of the stroboscope. The operating procedure is described more fully in the Operating Instructions for the Type 1535 Contactor.

2.10.6 TYPE 1539 STROBOSLAVE.

The Type 1539 Stroboslave is an inexpensive, miniature, electronic stroboscope. It has no internal oscillator for setting the flashing rate, but must be triggered by an external device. It cannot be used for direct measurement of rotational speed. This small stroboscope is suitable for high-speed-photography applications and motion studies other than tachometry.

The Stroboslave will flash upon closure of external contacts or upon reception of a 2-volt positive pulse at its panel INPUT jack. It will operate directly from the OUTPUT jack of the Type 1538 Strobotac.

The lamp and reflector of the Stroboslave are connected to the unit by a five-foot flexible cable, to permit positioning the lamp close to the moving object.

Operating over a range of 0 to 25,000 flashes per minute, the Type 1539 produces a peak light intensity of up to 11 million beam candles on the HIGH-intensity range and up to 18 million beam candles when used for single-flash applications.

The reader should refer to the Instruction Manual for the Type 1539 Stroboslave. Complete specifications are included in the Appendix of this book.

2.10.7 USE OF MULTIPLE STROBOSCOPES.

When a multiple source of flashing light is needed, several Type 1538 stroboscopes can be connected together. A cable from the OUTPUT jack of the first instrument connects to the INPUT jack of another, and so on. Connected in this manner, the stroboscopes will flash at the same time.

A Type 1531 Strobotac electronic stroboscope can be substituted for any of the Type 1538 instruments for this multiple use. However, a Type

1531-P4 Trigger Cable (with built-in transformer) must be used at the OUTPUT of each Type 1531.

2.10.8 CONNECTING THE ACCESSORY INSTRUMENTS.

Figure 2-10 shows the Type 1538 Strobotac electronic stroboscope and the connections for some of the many possible combinations of accessory instruments.

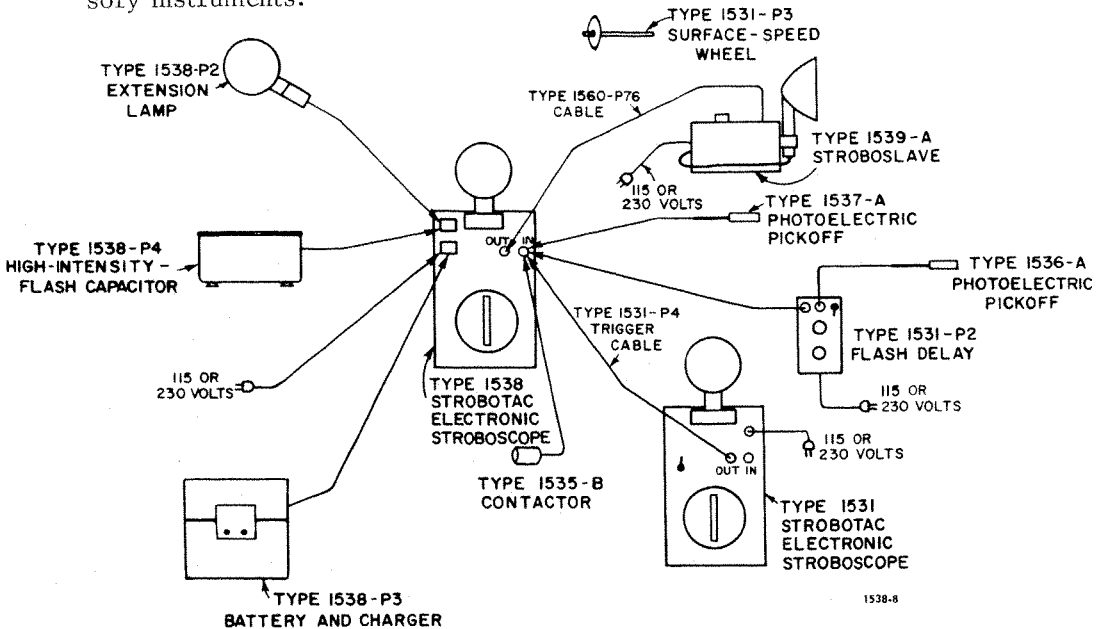

Figure 2-10. Some of the many possible combinations of the Type 1538 Strobotac electronic stroboscope and its accessory instruments.

2.11 HIGH-SPEED PHOTOGRAPHY.

Use of the stroboscope in photography is described in detail in the General Radio Handbook of High-Speed Photography.

2.11.1 GENERAL.

The short duration of the flash of light from a stroboscope makes it ideal for high-speed-photography applications. To control the exposure time, the camera shutter can be left open and the light turned on and off very quickly. With the use of convenient controls for triggering, such as a photocell or microphone, the Type 1538 can be used for single flash or can be set to flash at a given rate for multiple exposures.

The peak flash intensity of the Strobotac varies with the flashing rate, from about 200,000 beam candles at the highest flash rate to several million beam candles at low speeds. When it is desirable, even greater single-flash



light intensity (to 44 million beam candles) can be obtained by the addition of the Type 1538-P4 High-Intensity-Flash Capacitor, an optional accessory that plugs directly into the Type 1538 Strobotac (refer to paragraph 2.11.7).

2.11.2 FLASH DURATION.

The duration of the stroboscope flash can vary from 0.5 to 8 microseconds, depending on the flash-rate-range setting (refer to Table 2-3).

Table 2-3

Flash duration at 1/3 peak intensity for each range of the Type 1538 Strobotac.	
<i>RPM Range Switch Setting</i>	<i>Flash Duration (Microseconds)</i>
110-690	3
670-4,170	1.2
4,000-25,000	0.8
24,000-150,000	0.5

Figure 2-11 shows a plot of light intensity versus duration time. When the Type 1538-P4 High-Intensity-Flash Capacitor is used to produce extra-bright single flashes, duration is increased to 8 microseconds.

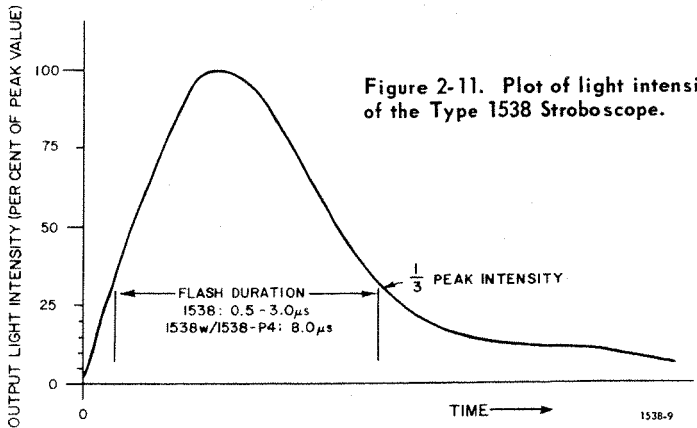

Figure 2-11. Plot of light intensity vs time of the Type 1538 Stroboscope.

2.11.3 BEAM WIDTH.

With the standard reflector in position on the Strobotac, the light output is concentrated in a 10-degree beam (measured at 1/2-peak-intensity points), whose apparent source is 18 inches behind the front of the reflector. Outside this 10-degree cone the light intensity falls off sharply, so that the area of reasonably constant illumination is not large. If this beam width is not adequate to light the subject, the reflector can be easily removed and the bare lamp used to illuminate the area.

2.11.4 SPECTRAL CHARACTERISTICS.

The spectral distribution of the flash of the Strobotac (shown in Figure 2-12) is excellent for photography with both orthochromatic and panchromatic films. Equivalent color temperature of the flash is about 6500 to 7000 degrees Kelvin.

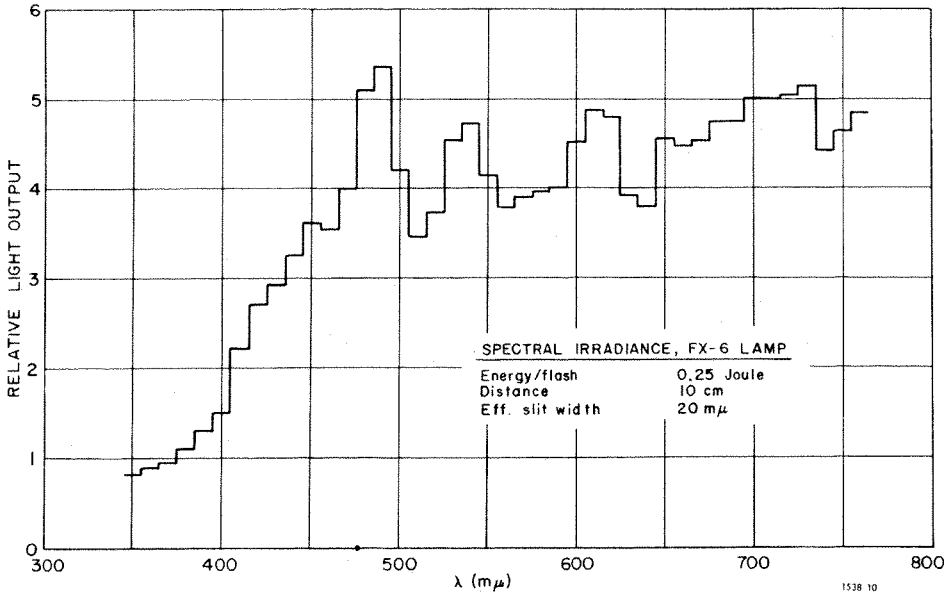

Figure 2-12. Spectral distribution of the stroboscope flash.

2.11.5 EXPOSURE DATA.

Figure 2-13 can be used to determine the guide number for a given film speed when the Type 1538 Strobotac or Type 1539 Stroboslave is used. To determine the effective lens aperture (*f* setting), divide the guide number by the stroboscope-to-subject distance (in feet) plus 1.5 (refer to paragraph 2.11.3).

The guide numbers are given rather than the watt-second ratings, because the latter cannot be used to determine the subject illumination without a full knowledge of the reflector characteristics and the tube efficiency.

2.11.6 SINGLE-FLASH PHOTOGRAPHY.

With single-flash photography, the camera shutter is opened, the stroboscope is flashed once, to expose the film, and the shutter is closed again. Single-flash pictures, taken in this manner, have solved many puzzling industrial problems. The subject is photographed in the position it occupies at the instant the stroboscope lamp flashes. Several different methods of triggering the stroboscope at the proper time are described in Section 6 of the GR Handbook of High-Speed Photography.

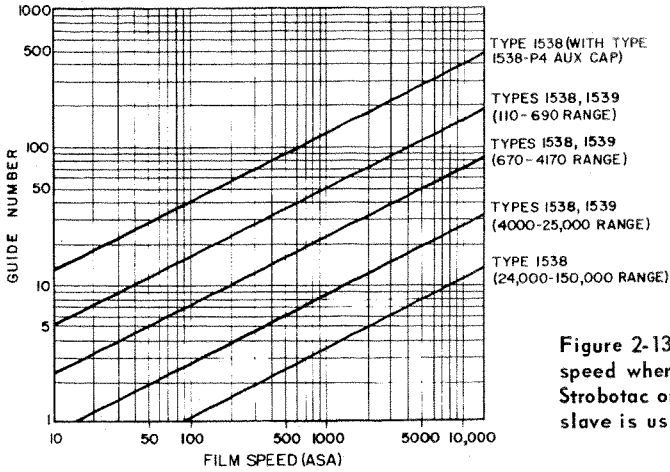

Figure 2-13. Guide number vs film speed when either the Type 1538 Strobotac or the Type 1539 Stroboslave is used.

1538-11

NOTE

Because the first trigger pulse from the oscillator is used to charge the flash capacitor, always trigger the stroboscope once or twice before actually taking a single-flash photograph. The capacitor will then be charged, ready to flash the lamp on all subsequent trigger pulses.

2.11.7 TYPE 1538-P4 HIGH-INTENSITY-FLASH CAPACITOR.

An optional accessory for the Type 1538 Strobotac is the Type 1538-P4 High-Intensity-Flash Capacitor (Figure 2-14). With this accessory connected, a single 8-microsecond flash of 44 million beam candles can be obtained.

Figure 2-14. The Type 1538-P4 High-Intensity-Flash Capacitor can be used with the Strobotac for short, single flashes.

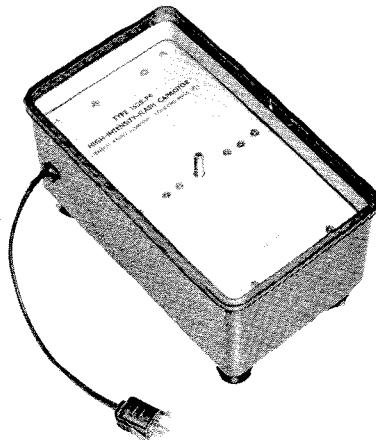

This is used when a brighter flash is needed to photograph an object moving at an extremely high speed or one in high ambient light.

The circuit for the Type 1538-P4 Capacitor is given in Figure 2-15.

To attach the Capacitor to the stroboscope, open the Flip-Tilt cabinet fully, as shown in the lower right-hand view of Figure 1-1. Place the Type 1538 on its side. Attach the Capacitor to the base section of the Flip-Tilt cabinet. To do this, line up the screw in the center of the capacitor with

Figure 2-15. Schematic diagram for the Type 1538-P4 High-Intensity-Flash Capacitor.

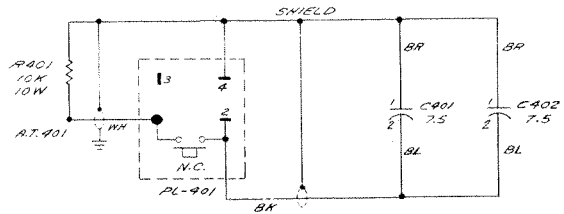

the tripod-mounting hole in the bottom of the Flip-Tilt cabinet. Tighten the screw, locking the capacitor in place. Set the stroboscope upright and plug the cable into the 4-prong socket marked EXT LAMP, on the panel of the stroboscope, as in Figure 2-16.

The assembly is now ready for single-flash operation. The maximum flashing rate with the combination is 60 flashes per minute.

The Capacitor is automatically discharged when the 4-prong plug in the EXT LAMP socket is removed. The Capacitor can also be discharged by changing the setting of the RPM range switch.

Guide numbers for various film speeds when the Capacitor is used with the stroboscope are given in Figure 2-13.

The reader should note the instructions in paragraph 2.11.6 for single-flash photography.

The Type 1538-P4 High-Intensity-Flash Capacitor and the Type 1538-P2 Extension Lamp cannot be used simultaneously on the stroboscope.

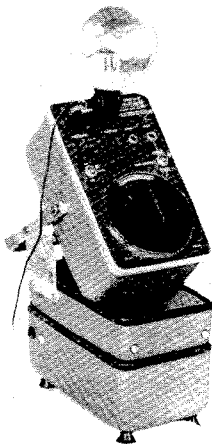

Figure 2-16. Type 1538-P4 Capacitor attached to the Strobotac.



SECTION 3

PRINCIPLES OF OPERATION

3.1 GENERAL.

If a cyclically moving object is viewed by a light that is flashing at or near the cyclic rate of the object, the latter will appear stationary or in slow motion. The optical illusion thus produced depends on the periodic observation of the object. If the flashing rate of the light is adjusted to produce a stationary image, the flashing rate equals the cyclic speed of the moving object.

The stroboscope is essentially a source of flashing light with an adjustable calibrated control of flash frequency. In most modern stroboscopes the actual flash occurs inside a xenon-filled tube. The gas is ionized by the rapid discharge of a capacitor. The gas must then deionize before the next flash can occur. This deionizing time sets a limit on the maximum flashing rate. If voltage is applied across the tube before the gas is deionized, continuous conduction known as "holdover" occurs.

3.2 THE STROBOTRON TUBE.

As used in a stroboscope, the strobotron tube contains two main electrodes, a cathode and an anode, separated by 3/8 inch, in an envelope filled with xenon gas at a pressure of one-half atmosphere. A specially designed capacitor acts as a low-impedance source to supply 800 to 1000 volts across these electrodes. The gas, however, remains non-conducting until a 5000-volt pulse is applied to trigger wires interspersed between these main electrodes. This trigger pulse ionizes the gas, and causes up to 1000 amperes to flow through it. This peak flow of almost one million watts generates an intense flash of white light of 15 million beam candles.

After this tremendous pulse of light, the tube requires about 150 microseconds to deionize. The voltage across the tube must remain less than 80 volts during this deionization time or holdover will result.

3.3 THE CHARGING CIRCUIT.

The necessary deionization time limits the maximum flashing rate of the stroboscope. Figure 3-1 illustrates the problem. The curves labeled R-C and L-C show the effects of charging the capacitor through a resistor and an inductor, respectively. The slopes required to keep the voltage below the 80-volt deionization level would impose delays in reaching the firing level, which in turn would restrict the maximum flashing rates to 24,000 and 54,000 flashes per minute, respectively, for the particular tube and voltages used in the Type 1538.

The answer to this problem is to hold the voltage at zero for the deionization period and then to raise it quickly to the firing level.

The new circuit shown in Figure 3-2 provides an almost ideal charging curve (labeled "Type 1538" in Figure 3-1). During the 150-microsecond deionization time after the strobotron has flashed, the transistor, acting as a switch, is saturated and the transformer primary current increases, storing energy in the transformer core. The voltage induced in the secondary winding during this build-up is blocked by the diode rectifier, and no voltage appears across the capacitor and strobotron tube. At the end of this 150-microsecond interval, the transistor is switched off, and the primary current goes to zero. The collapsing magnetic field generates a reverse-polarity voltage in the secondary, causing the diode to conduct and the stored energy to be transferred to the capacitor. When the energy in the transformer is zero, the current again reverses and the diode opens, leaving all the stored energy in the capacitor. This transfer can be made as fast as one wishes, and the flashing rate can therefore be made to approach the theoretical maximum.

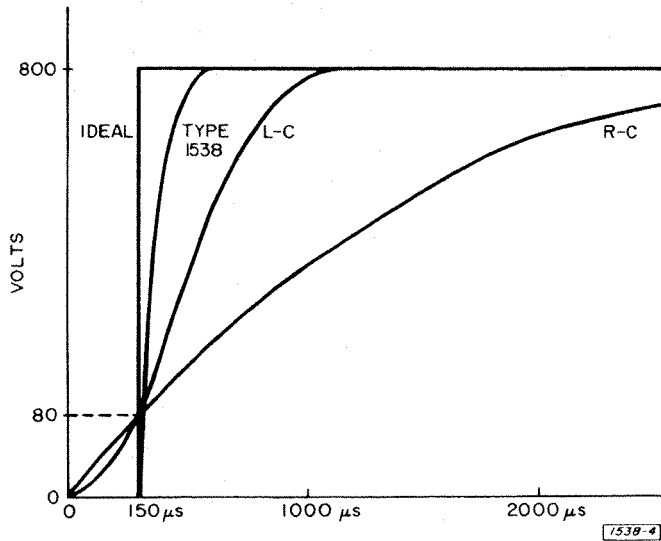
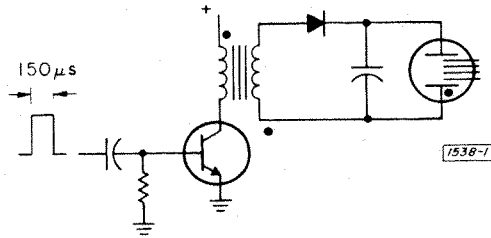

Figure 3-1. Voltage-vs-time characteristics of various charging circuits.



Figure 3-2. Charging circuit of the Type 1538 Strobotac electronic stroboscope.



The transfer of energy from the power supply to the intermediate storage inductor and then resonantly to the discharge capacitor can be made with an efficiency approaching 100%. In the conventional RC charging circuit, however, half of the available energy is dissipated in the charging resistor regardless of the value of the resistor (including zero ohms). The use of inductive charging saves the power ordinarily dissipated in the charging resistor and reduces the weight of the battery, making portable operation practical. Moreover, the use of a transformer as the inductive element permits the use of a low-voltage transistor circuit to generate the high voltage required by the strobotron tube.

A block diagram of the complete circuit is shown in Figure 3-3. A transistorized RC oscillator sets the flashing rate of the stroboscope. Once each cycle, a transistor trigger circuit generates a 5-kilovolt, 5- μ s pulse to trigger the strobotron tube. In the time between these pulses, the main discharge capacitor (which varies from 0.007 μ F on the high range to 1.5 μ F on the low range) must be recharged to 800 volts. The monostable circuit, triggered by the oscillator, generates a 200- μ s pulse that saturates the transistor switch, stores energy in the transformer, and allows the strobotron to deionize. At the end of the 200- μ s pulse, sufficient energy has been stored to resonantly charge the capacitor to 800 volts in an additional 200 μ s. Thus, a maximum flashing rate of $\frac{1}{400}$ μ s or 2500 flashes per second is possible.

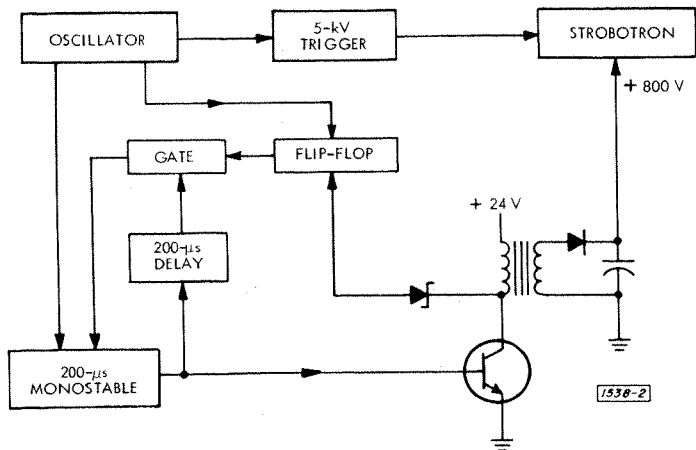

Figure 3-3. Block diagram of the Type 1538 Strobotac electronic stroboscope.

The average light output of a stroboscope varies directly with flashing rate and discharge capacitance. The exceptionally wide flashing-rate range of the Type 1538 (1500 to 1) would mean a drastic variation in light output if only one discharge capacitor were used. On the other hand, a continuously adjustable discharge capacitor with a 1500-to-1 range was obviously impractical. The compromise solution was to switch in a different capacitor for each of the four 6:1 speed ranges. The resulting capacitance variation is 216 to 1, and this raises another design problem.

If the discharge capacitor varies in value over a 216-to-1 range, then, in the resonant charging circuit discussed earlier, either the inductance must also vary by a factor of 216 or the current must vary by a factor of 216 to supply sufficient energy per cycle. Large coils and 30-ampere current were both unappealing, so another approach was found.

On lower-speed ranges, however, where the discharge capacitance is higher, the energy stored in the transformer is insufficient to produce the desired 800-volt firing potential. On these ranges, the 200- μ s delay following the monostable circuit generates a trigger pulse occurring 200 μ s after the end of the monostable pulse, to retrigger the monostable circuit. Thus a single pulse from the oscillator starts a train of 200- μ s pulses in the monostable circuit and its delay loop. Each of these pulses stores energy in the inductor that is repeatedly transferred to the capacitor during the time between pulses. Each pulse raises the capacitor voltage in a small step, as shown in Figure 3-4. This process continues until the capacitor is charged to 800 volts. At each step, a voltage pulse equal to the capacitor voltage divided by the transformer turns ratio appears across the Zener diode on the transformer primary. When the capacitor reaches 800 volts, the diode voltage is exceeded and the flip-flop closes the gate. This breaks the feedback loop and ends the pulse train started by the oscillator. While this multiple-cycle resonant-charging technique used on the lower ranges requires more time than the single-cycle charge, a correspondingly longer time is available in which to recharge the capacitor.

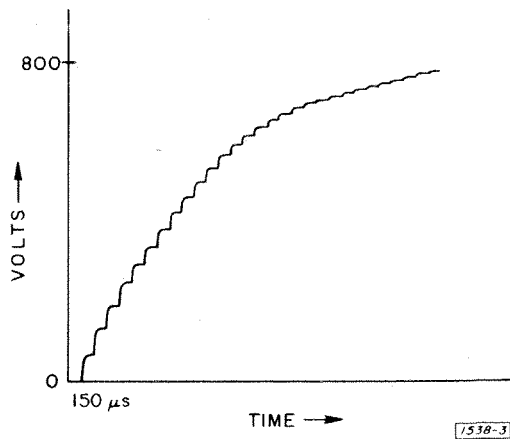

Figure 3-4. The voltage buildup on the charging capacitor is in small steps.



3.4 THE CALIBRATION CIRCUIT.

To calibrate the RPM dial against the power-line frequency, voltages at both the power-line and the flashing-rate frequencies are superimposed across a neon lamp (V901). When the flashing rate equals the power-line frequency or a submultiple of it, the voltage across the lamp remains constant and the lamp is in a condition of steady intensity. Depending upon the phase relation between the strobotron flashing rate and the power-line frequency, the steady-intensity condition of the neon lamp may be maximum intensity, partial intensity or completely out. If the flashing rate of the strobotron differs from the power-line frequency, the average voltage across the neon lamp will vary, and the intensity will change, at the difference frequency.

SECTION 4

SERVICE AND MAINTENANCE

4.1 WARRANTY.

We warrant that each new instrument manufactured and sold by us is free from defects in material and workmanship, and that, properly used, it will perform in full accordance with applicable specifications for a period of two years after original shipment. Any instrument or component that is found within the two-year period not to meet these standards after examination by our factory, District Office, or authorized repair agency personnel will be repaired or, at our option, replaced without charge, except for tubes or batteries that have given normal service.

4.2 SERVICE.

The two-year warranty stated above attests the quality of materials and workmanship in our products. When difficulties do occur, our service engineers will assist in any way possible. If the difficulty cannot be eliminated, please write or phone our Service Department, giving full information of the trouble and of steps taken to remedy it. Be sure to mention the type and serial numbers of the instrument.

Before returning an instrument to General Radio for service, please write to our Service Department or nearest District Office, requesting a "Returned Material Tag". Use of this tag will ensure proper handling and identification. For instruments not covered by the warranty, a purchase order should be forwarded to avoid unnecessary delay.



4.3 MINIMUM PERFORMANCE STANDARDS.

4.3.1 GENERAL.

The following procedures are recommended for incoming inspection or periodic checks on the instrument. Complete instructions for the calibration of the stroboscope are given in paragraph 2.7.

4.3.2 EQUIPMENT REQUIRED.

- 1 Type 1309 Oscillator*
Range: 10 Hz to 100 kHz
Output: Continuously adjustable to 5 V.
- 1 Type 1151 Digital Time and Frequency Meter*
Range: 60-2500 Hz
- 1 Type 1806 Electronic Voltmeter*
Range: 0-10 V, rms
Accuracy: $\pm 3\%$

4.3.3 PRELIMINARY CHECK.

With the power connected, turn on the POWER switch. There must be no erratic action of the flash tube on any of the four speed ranges.

4.3.4 FLASHING-RATE ACCURACY CHECK.

Connect the OUTPUT jack of the Type 1538 to the INPUT of the Type 1151 Digital Time and Frequency Meter. After calibration according to the instructions of paragraph 2.7, all speeds on all ranges of the stroboscope must check within $\pm 1\%$ of the dial reading.

$$\text{NOTE: Hz} = \frac{\text{RPM}}{60}$$

4.3.5 INPUT CHECK.

Set the FLASH CONTROL to EXTERNAL, the range switch to 110-690 RPM, and the knurled dial fully clockwise. The tube must flash each time the INPUT terminals are shorted. (It will not fire with the first short if the capacitors are not charged, but will fire with the second and all succeeding shorts.)

Apply 1 volt, rms, at 20 Hz from the Type 1309 Oscillator to the INPUT jack of the stroboscope. It must be possible to flash the tube at some position of the speed control (knurled dial).

4.3.6 OUTPUT CHECK.

Set the FLASH CONTROL to INTERNAL and the range switch to 24000-150000 RPM. With the Type 1806 Voltmeter, measure the voltage at the OUTPUT jack; it must be at least 4.5 volts, rms.

*Or equivalent.

4.4 MAINTENANCE.

4.4.1 CASE WILL NOT LOCK PROPERLY.

If the screws that fasten the side plates of the handle assembly to the cover become loose, proper operation of the slide pins may become difficult or impossible. Close the instrument and set the slide pins in the locked position by moving the side plates up or down. Tighten the screws on the plates. Check the operation in the open position. If necessary, loosen the side-plate screws and reposition the plate slightly, so the case will lock in both opened and closed positions.

4.4.2 CLEANING THE REFLECTOR.

If it becomes necessary to clean the inside of the reflector, pull it free of the swivel assembly. Wipe the reflecting surface carefully with a soft, lint-free cloth. If necessary, moisten the cloth with water. Do not use solvents of any kind, as they may damage the surface.

4.4.3 REMOVING THE INSTRUMENT FROM ITS CASE.

WARNING

Before removing the instrument from its case, turn OFF the POWER switch and rotate the RPM range switch at least one position in either direction, to discharge the capacitor to prevent contact with 800 volts.

To remove the instrument, open the case and place the instrument with the panel in a vertical position. Remove the four screws from the bottom of the case, (side opposite the panel) and pull the instrument forward, out of the case.

4.4.4 REPLACING THE FUSE.

To replace the fuse, remove the instrument from the case as described in paragraph 4.4.3. Remove screws A and B only (Figure 4-1), in the large, power-supply, etched board (P/N 1538-2751, Figure 4-11) and swing the board away from the panel, as shown in Figure 4-2. Do not allow the board to swing free, or it may be damaged.

The 0.25-ampere fuse (F901, Figure 4-2) is now readily accessible, in its mounting on the back of the panel.

4.4.5 REPLACING THE STROBOTRON LAMP.

WARNING

Avoid touching the strobotron pins when removing the lamp. With the power to the instrument turned on, 800 volts are present at the pins. Also, the temperature of the lamp may be quite high if the instrument has been operating for some time.

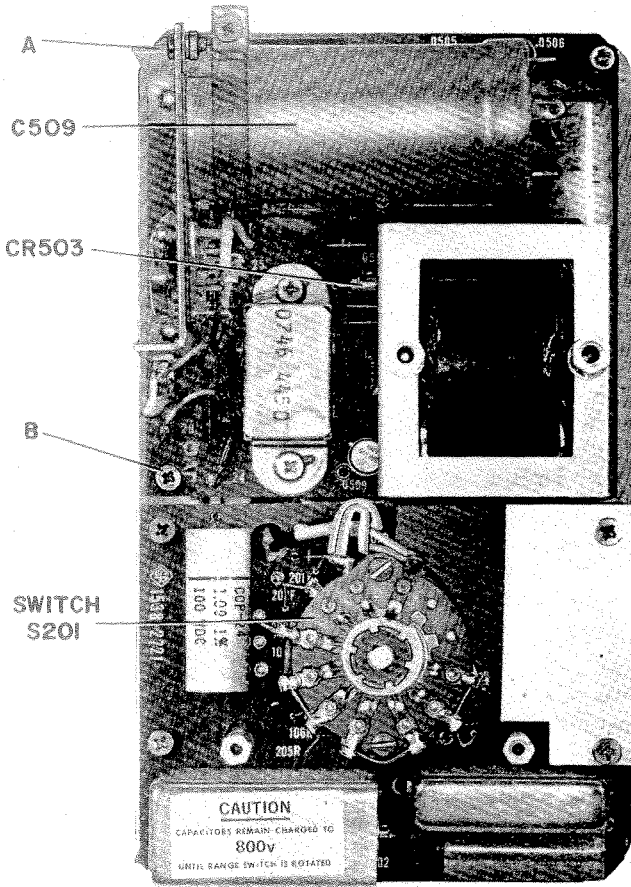

Figure 4-1. The power-supply etched-circuit board is pivoted to swing out when screws A and B are removed.

To replace the strobotron lamp, first pull the reflector from the swivel assembly. Move the lamp slightly from side to side until it is free of the socket. Be sure the leads on the replacement lamp are not bent, and that, after it is inserted, the lamp is fully seated in the socket.

4.4.6 REPLACING THE DIAL LAMP.

To replace the dial lamp, remove the instrument from the case (refer to paragraph 4.4.3). Remove screws A and B only (Figure 4-1), in the large, power-supply, etched board (P/N 1538-2751) and swing the board away from the panel, (see Figure 4-2). The dial lamp is now readily accessible, as shown in the figure.

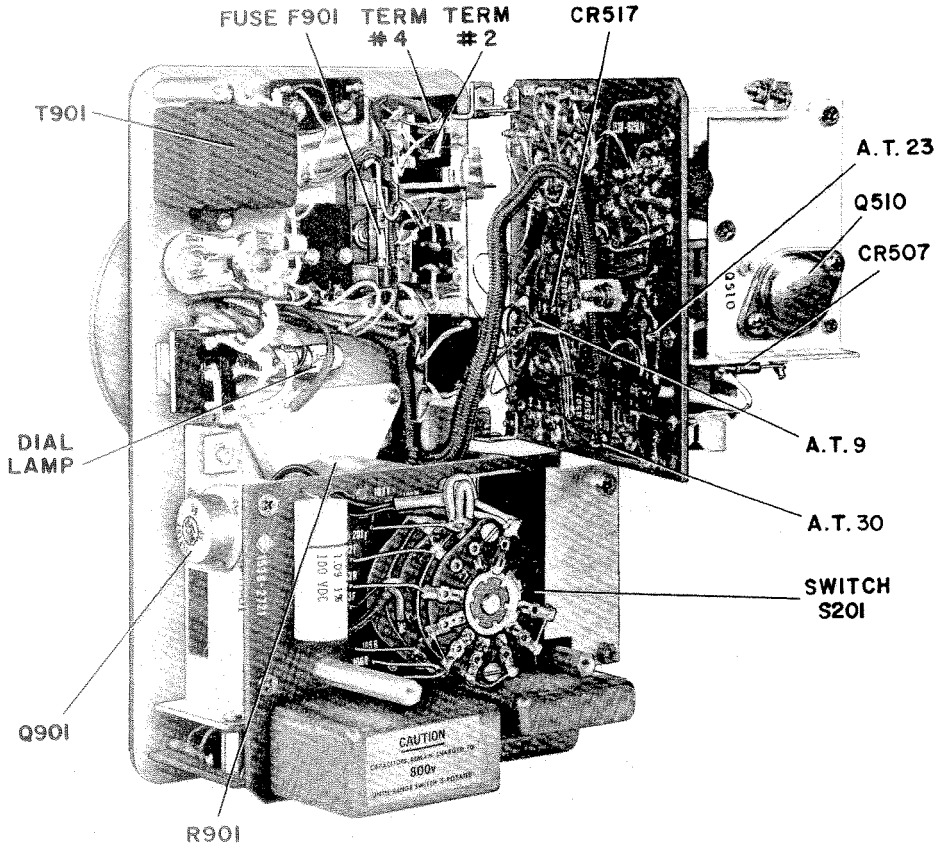

Figure 4-2. The power-supply board swung out to expose the under side, the fuse, and the dial lamp.

4.4.7 REPOSITIONING THE RPM DIAL AND KNOB.

The RPM dial should not move when the RPM range switch knob is turned. If it does, the mask is rubbing on the dial. To correct this, loosen the two setscrews in the knob, slide knob and mask forward slightly (away from the panel) and again tighten both setscrews.

4.4.8 CONVERTING FOR OTHER POWER-LINE VOLTAGES.

A change in line voltage from 115 volts, to 230 volts, or vice versa, requires a change in position of the jumpers on the terminals of transformer T501. Also, the markings above the front-panel power socket should be altered to indicate the new power ratings. These changes are described in detail in paragraph 2.3.1. The 0.25-ampere fuse (F901) is used for either voltage.



4.5 TROUBLE ANALYSIS.

A handy trouble-analysis chart is included on page 43.

NOTE

Except where otherwise noted, the trouble-shooting procedures described below are based on the following initial conditions: Power-line voltage is 115 or 230 volts; FLASH CONTROL switch is set to INTERNAL; No accessories are attached to the stroboscope.

4.5.1 STROBOTRON LAMP DOES NOT FLASH.

a. If the strobotron lamp (V-902) does not flash with the FLASH CONTROL switch at INTERNAL:

1. Be sure the RPM range switch is not at CAL; the strobotron will not flash with the switch in this position.

2. Be sure the strobotron is seated firmly in its socket.

b. If the strobotron lamp does not flash and the RPM dial lamp does not light:

1. Make certain that the input power is correct.

2. Check fuse F901.

3. If a replacement fuse blows, remove transistor Q510.

Should the fuse no longer blow, the trouble may be in either Q510 or diode CR503. Replace the faulty component.

4. If the fuse continues to blow with transistor Q510 removed, the trouble is in the power supply. Check for -24 volts at A.T.9. Also check the power-supply components.

5. Be sure the dial lamp is not faulty.

c. If the strobotron lamp does not flash but dial lamp lights:

1. Try all positions of the RPM range switch. If strobotron flashes on the 24000 - 150000 RPM range only, change the range switch to the 4000 - 25000 range, and momentarily place a jumper from the collector to the emitter of transistor Q107. If the strobotron flashes, the trouble is in the flip-flop circuit (Q107 or Q108). Should the strobotron not flash properly, the feedback gate (Q104, Q105, Q106) is malfunctioning.

2. If the strobotron does not flash on any position of the RPM range switch, repeat the procedure of paragraph 4.5.1, b. If the voltage at A.T.9 is correct, set the switch to the 24000 - 150000 range and, in a darkened room, look closely for very low-intensity arcing between the electrode tips of the strobotron lamp. Should the arcing be absent, check for 800 volts, dc, at pin #4 of the strobotron socket with the lamp removed (heed warning of paragraph 4.4.5). If the arcing is not visible (or the voltage is not correct), plug a Type 1538-P2 External Lamp into the EXT LAMP socket on the front

panel. If the external lamp now flashes, the trouble may be in switch S903 or in the original strobotron lamp.

(a) To check the switch, apply external pressure to the upper contact arm to close the contacts, or connect a jumper between them.

(b) Replace the lamp in the stroboscope with the one from the external lamp. Should the external lamp not flash, be sure the following voltages are correct (see the schematic diagram, Figure 4-14):

- 24 volts at A.T.9
- 15 volts at A.T.30

CAUTION

Use extreme care when measuring the -15 volts. Even a momentary short may destroy transistors Q507, Q508, or Q509, or diode CR517.

(c) If both voltages are low, remove transistor Q510 from its socket (see Figure 4-3) and recheck the voltages. If they are now correct, transistor Q510 or Q501 or diode CR503 is faulty. If they remain incorrect, check the low-voltage power supply. If only the voltage at A.T.30 is incorrect, the trouble is in the -15 V regulator circuit.

(d) If the voltages are correct at A.T.9 and A.T.30, continue with the following procedure:

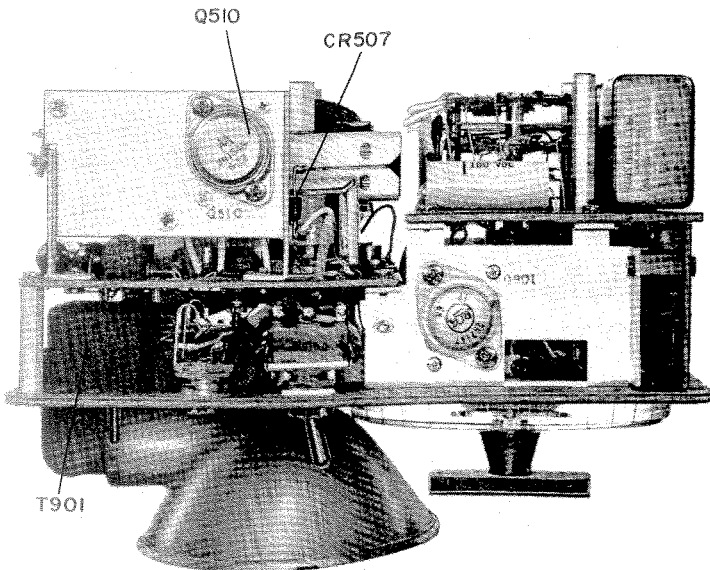

Figure 4-3. Right-side interior view of the stroboscope.

(1) Set the RPM range switch to CAL and the dial to 3800 RPM. The CALIBRATE lamp should now operate with a pulsating glow. If it does, the trouble must be in the trigger generator (transistors Q505, Q506, Q901).

(2) If the CALIBRATE lamp is not operating, check the waveform at the panel OUTPUT jack (see Figure 4-4) or set the RPM controls to 150000 RPM and determine that some voltage is present at the jack; use the 3-volt ac range of a 5000 Ω/V multimeter. Correct waveform or voltage indicates trouble in the trigger generator (Q505, Q506, or Q901); an incorrect result indicates trouble in the oscillator section, Q101, Q102, Q103.

3. (a) If the low-intensity arcing is visible between the electrodes of the strobotron, as described in step c,2, above, check the strobotron lamp by replacing it with one known to be good.

(b) If the trouble persists, set the RPM range switch to CAL, the dial to 3800, and check that the CALIBRATE lamp is operating with a pulsating glow.

(c) If the CALIBRATE lamp is not operating (with a pulsating glow, step (b), above), check for proper waveform at the OUTPUT jack (see Figure 4-4); or set the RPM controls to 150,000 RPM and determine that some voltage at the jack is indicated on the 3-volt ac range of a 5000 Ω/V multimeter. Incorrect waveform or voltage indicates that the oscillator circuit (Q101, 102, 103) is not functioning properly.

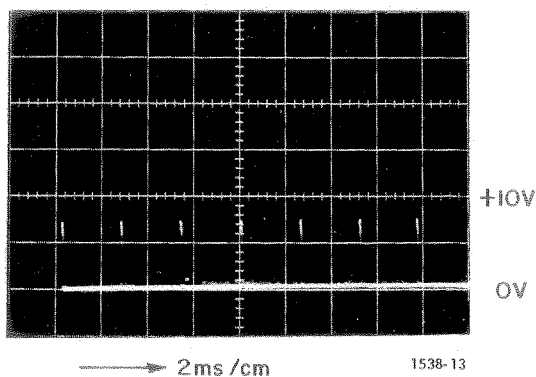

Figure 4-4. Voltage waveform at the panel OUTPUT jack (24,000 RPM).

(d) If the CAL lamp is operating properly, turn off the POWER switch and carefully remove the strobotron from its socket (heed the warning of paragraph 4.3.5). Set the RPM range switch to the 110-690 range. Measure the voltage between pins #4 and #9 of the socket; it should be at least 700 volts, dc. Improper voltage indicates a defective diode CR507 or faulty wiring. Also check diode CR503 and transistor Q510 (as in step c,2, (b) and (c), above).

(e) With the correct waveform or voltage in step (c), above, measure the voltages at A.T.9 and A.T.30. Follow the instructions in steps c,2, (c) and (d).

(f) With the correct voltages at A.T.9 and A.T.30, observe the waveform at A.T.65 (see Figure 4-5). If it is incorrect, the trouble is in the 200 μ sec monostable circuit.

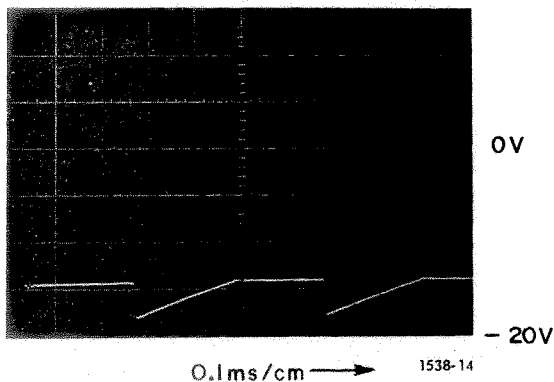

Figure 4-5. Voltage waveform at A.T.65 (24,000 RPM).

4.5.2 STROBOTRON LAMP FLASHES ERRATICALLY.

a. Set the FLASH CONTROL switch at EXTERNAL. Rotate the RPM dial counterclockwise through its entire range. Only a single flash should be observed. More than one indicates a noisy potentiometer R901.

b. Check the strobotron lamp by substituting one known to be good.

c. Observe the waveform at the OUTPUT jack (see Figure 4-4). Unevenly spaced pulses indicate erratic operation of the oscillator section.

d. Observe the waveform at pin #3 of the panel EXT LAMP socket (S0901) and compare it with that of Figure 4-6. Improper waveform is caused by trouble in the trigger generator.

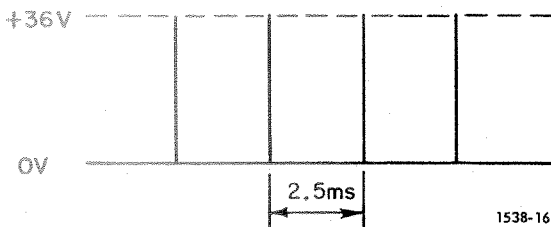

Figure 4-6. Voltage waveform at pin #3 of the panel EXT LAMP socket, S0901 (24,000 RPM).

e. Compare the waveform at A.T.23 with that given in Figure 4-7. An incorrect waveform indicates a faulty 800-volt supply. Check CR504, Q510, CR503, and CR507. (NOTE: Transistor Q510 may break down, due to high-voltage pulses.)

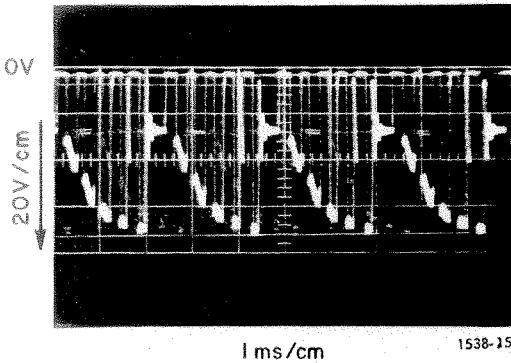

Figure 4-7. Voltage waveform at A.T.23 (24,000 RPM).

f. Compare the waveforms at A.T.65 and A.T.63 with those given in Figures 4-5 and 4-8, respectively. Improper waveforms indicate trouble in the flip-flop circuit (Q107 and Q108).

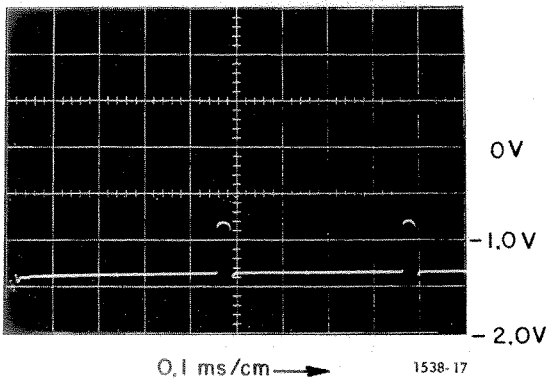

Figure 4-8. Voltage waveform at A.T.63 (24,000 RPM).

4.5.3 IMPROPER OPERATION WITH EXTERNAL INPUT.

a. Change the FLASH CONTROL switch to INTERNAL and check for normal operation. If trouble exists on the INTERNAL position also, refer to paragraph 4.5.1 and follow the procedure that applies.

b. If normal operation is noted on INTERNAL, return the switch to EXTERNAL and turn the RPM dial to the last 90 degrees of its clockwise rotation.

c. If trouble continues, be sure the external trigger is adequate (refer to the Specifications). Also, start with the RPM dial fully clockwise, and turn it counterclockwise about 90°, to increase the input sensitivity to the trigger point; a single flash should occur.

4.5.4 IMPROPER OPERATION WITH BATTERY POWER.

- a. If the RPM dial lamp lights, the trouble is in the stroboscope, not in the battery. Try operation on the ac line; refer to the appropriate symptom in paragraph 4.5.1.
- b. If the RPM dial lamp does not light, check the battery fuse, F302. If the fuse has blown, replace it. If a replacement fuse blows, refer to paragraph 4.5.1, step b.
- c. Turn the stroboscope ON and check the battery voltage at socket SO303. Recharge the battery (with the stroboscope OFF) if the voltage is below 20 volts.
- d. If the battery does not recharge, plug the charger onto the battery pack, set the dial to 5000 RPM, turn the POWER switch to ON, and remove the battery fuse, F302. If normal flashing does not occur, and the dial lamp does not light, the charger unit is not functioning properly.
- e. Check fuse F301; also check that the setting of the line-changeover switch, S301, corresponds to the input line voltage.
- f. Check the CHARGER UNIT circuit (Q301 and Q302).

4.5.5 TYPE 1538-P2 EXTERNAL LAMP DOES NOT FLASH; FRONT-PANEL STROBOTRON LAMP FLASHES.

- a. Test the external lamp by substituting one known to be good.
- b. Set the RPM range switch to 24000 - 150000. Inspect the external strobtron lamp for low-voltage trigger flashes between the electrodes (refer to paragraph 4.5.1 step c,2). If the flashes are not visible (in a darkened room), or if the voltage between pins #4 and #9 of the external lamp socket is not approximately 800 volts, dc, then the external lamp assembly is defective. Check for 800 volts, dc, between terminals #2 and #4 of the panel EXT LAMP socket.
- c. Compare the waveform at terminal #3 of the panel EXT LAMP socket with the correct waveform, shown in Figure 4-6. A discrepancy in the waveform indicates a broken wire associated with the EXT LAMP socket or malfunctioning of switch S903.
- d. If the cause of the trouble cannot be determined by the above procedures, return the complete Type 1538-P2 External Lamp to General Radio.

4.6 REPLACEMENT OF MECHANICAL PARTS.

4.6.1 GENERAL.

Although the stroboscope is designed especially for use in manufacturing, testing, and other areas where the working environment is often unsuitable for precision electronic instruments, certain mechanical parts mounted on the outside of the instrument case may eventually become contaminated or damaged. To replace these parts (see Figure 4-9), refer to the following instructions.

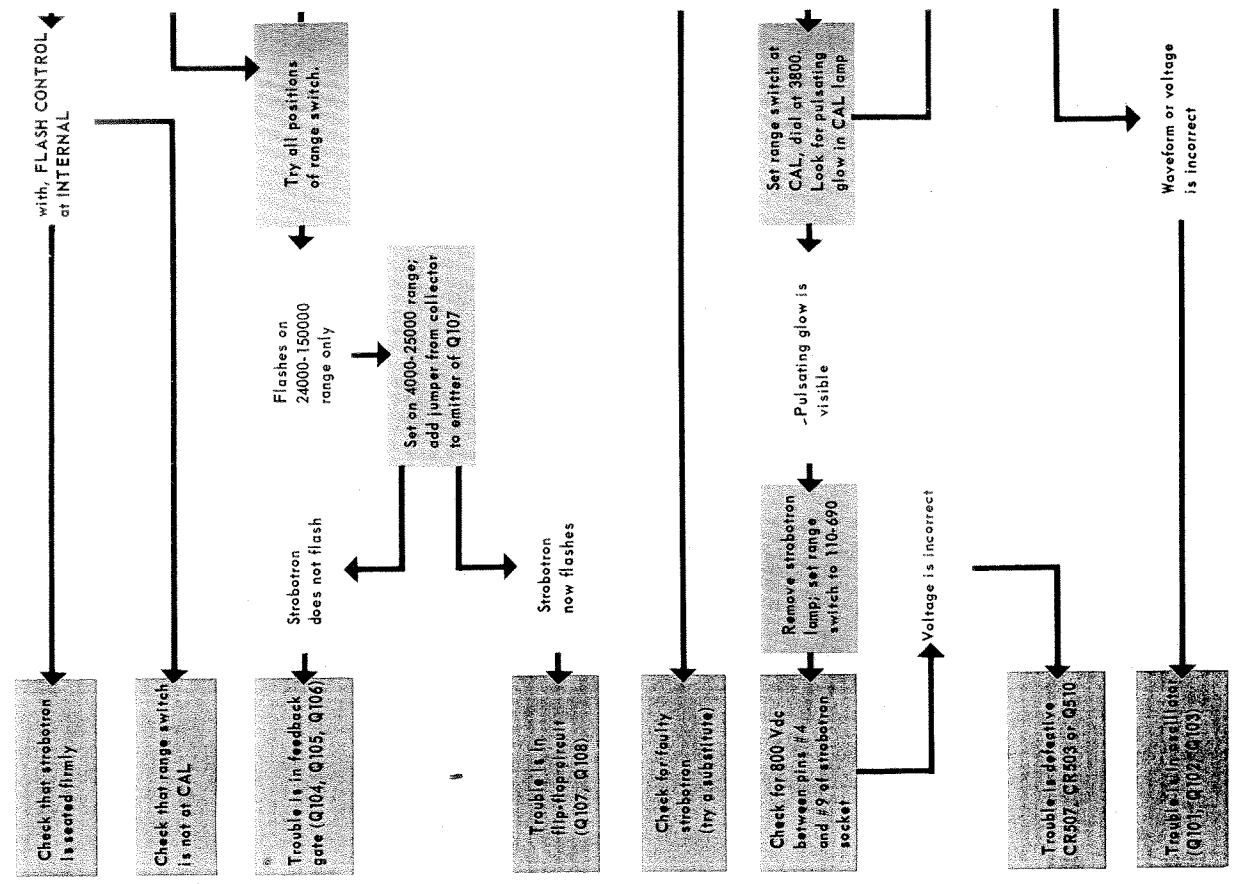

TROUBLE ANALYSIS CHART

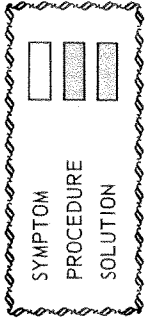

ROBOTRON DOES NOT FLASH

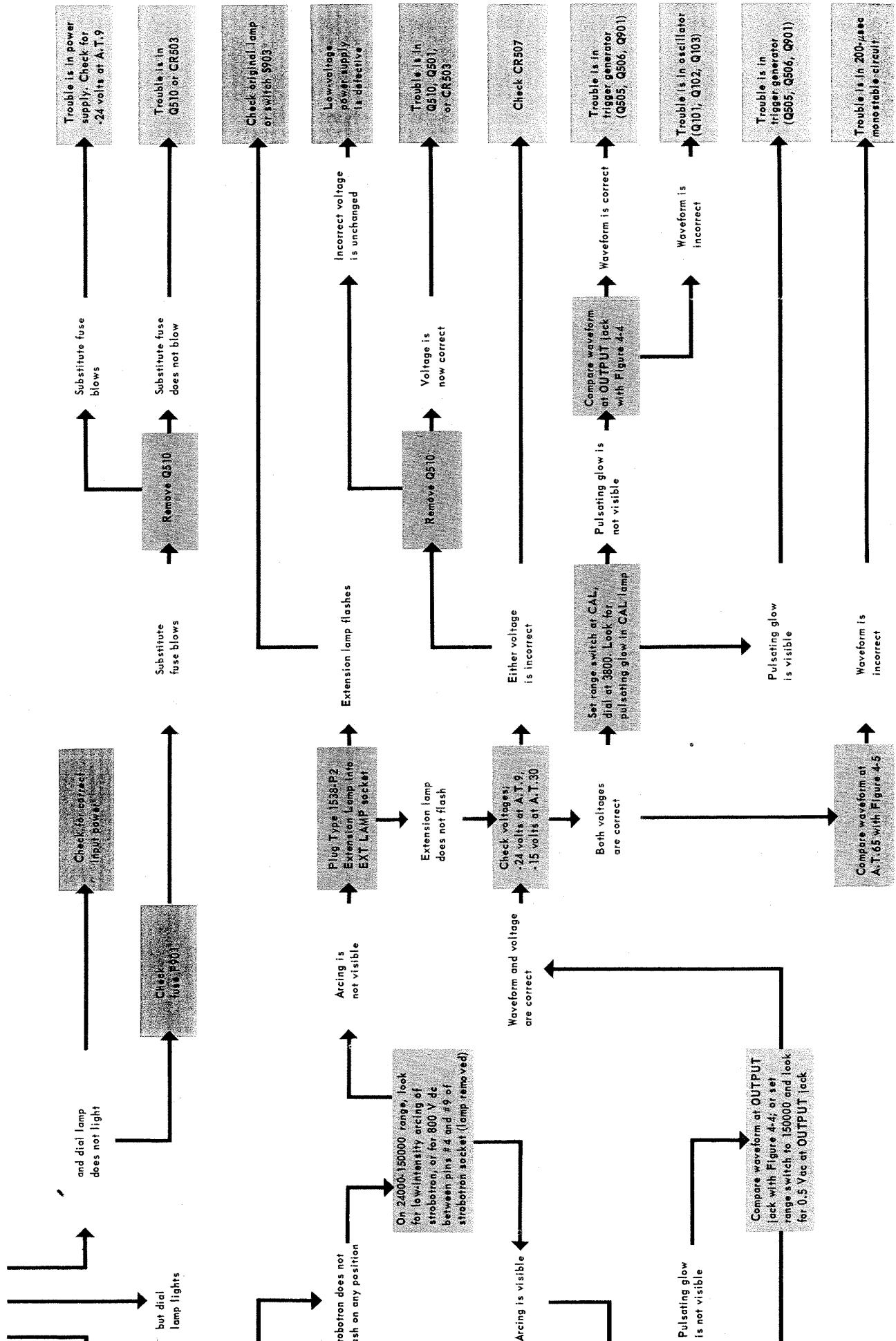

4.6.2 REFLECTOR AND COVER.

Remove the old reflector by pulling it away from the swivel-support assembly. Mount the new reflector by sliding it onto the assembly until the spring-loaded detent button snaps into the groove inside the reflector base.

To replace the reflector cover, remove the old cover by pushing on the edge at each of the molded clips that clamp over the rim of the reflector housing; the cover will snap off. Then mount the new cover by pulling its edge toward the rim of the reflector housing until the three clips snap securely into place.

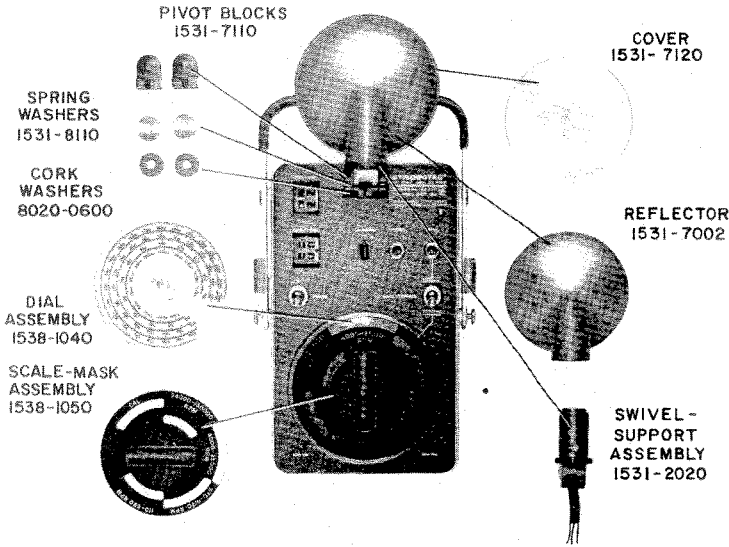

Figure 4-9. Miscellaneous part numbers.

4.6.3 SWIVEL-SUPPORT ASSEMBLY, PIVOT BLOCKS, AND WASHERS.

To replace the swivel-support assembly (see Figure 4-10):

- a. Remove the reflector, the strobotron lamp, then the instrument from its case.
- b. Loosen (do not remove) two nuts (A, Figure 4-10) and slide the two pivot blocks apart. (The heads of the two screws (B) clamp the pivot blocks in position when nuts (A) are tightened.)
- c. Unsolder the three swivel-support assembly leads (X, Y, Z) and remove the assembly.
- d. The pivot blocks and washers can now be replaced.
- e. Position the new swivel-support assembly so that the strobotron tube socket and leads (X, Y, Z) can be mounted as shown in the figure.
- f. Insert leads (X, Y, Z) through the slot between screws (B), and hold the swivel-support assembly in position between the two pivot blocks.

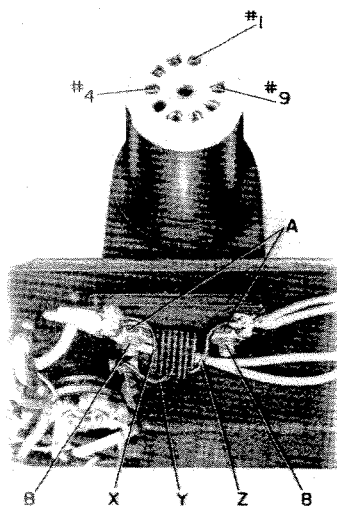

Figure 4-10. Interior view showing mounting of the swivel-support assembly, pivot blocks, and connections.

Slide the pivot blocks together and tighten nuts (A). The pivot action of the swivel-support assembly may need readjustment; if so, loosen either nut (A), adjust the corresponding pivot block, and retighten the nut.

g. Solder leads (X, Y, Z) to the terminals, as shown.

4.6.4 SCALE-MASK ASSEMBLY.

To replace the scale-mask assembly:

- a. Set the range switch to the 4000-25000 RPM position.
- b. Loosen the two setscrews in the scale-mask assembly hub and remove the assembly from the range-switch shaft.
- c. Mount the new scale-mask assembly on the shaft and center the 4000-25000 RPM window in the dial over the white panel segment beneath the dial.
- d. Tighten both setscrews securely.

4.6.5 DIAL.

To replace the dial:

- a. Remove the instrument from the case. Heed the warning of paragraph 4.4.3 (to prevent contact with 800 volts).
- b. Set the range switch to the 4000-25000 RPM position and remove the scale-mask assembly (refer to paragraph 4.6.4, steps a and b).
- c. Note the approximate dial setting and remove the dial from the potentiometer shaft without turning the shaft. To remove the dial, loosen the two setscrews in the dial hub, under the instrument panel.
- d. Mount the new dial at the approximate setting noted in step c. Tighten one setscrew in the dial hub.



CAUTION

The dial should not rub against the panel when rotated; allow a minimum clearance of 1/16 inch.

- e. Rotate the dial from the limit stop in one direction to the limit stop in the other direction. Note the distance between the red marker and each end of the 4000-25000 RPM scale. (The ends of the scale should travel approximately 1/4 inch beyond the red marker.) Adjust the dial until the red marker is equidistant from each end of the scale.
- f. Tighten both setscrews in the dial hub.
- g. Mount the scale-mask assembly (paragraph 4.6.4, steps c and d) and remount the instrument in the case.
- h. Calibrate the stroboscope before making speed measurements.

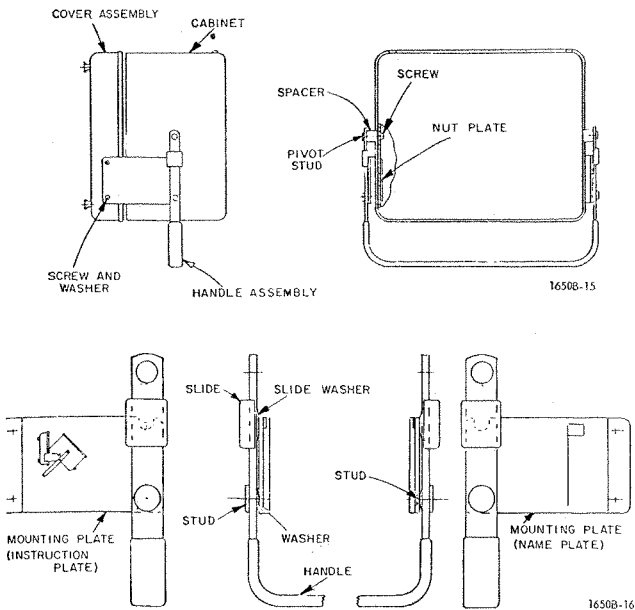

Figure 4-11. Name and location of parts included in the GR Flip-Tilt Case (refer to table 4-1).

Table 4-1
Part numbers for the flip-tilt case

Name	GR Part No.	Name	GR Part No.
Cabinet	1538-1080	Mounting Plate (Instr. Plate)	7860-1880
Spacer	4170-0900	Stud	4170-1200
Pivot Stud	4170-1267	Slide	4170-1271
Screw	7080-0800	Handle	5360-5881
Handle Assembly	1538-2040	Mounting Plate (Nameplate)	7864-8010
Cover Assembly	1538-2049	Washer	8140-0102
Screw	7080-0800	Slide Washer	4170-7030
Washer	8050-1500		

NOTE: Tighten 10-32 screws to 20-25 in. lbs torque. Bend mounting plate to give 1/32 to 1/16 spacing, both sides.

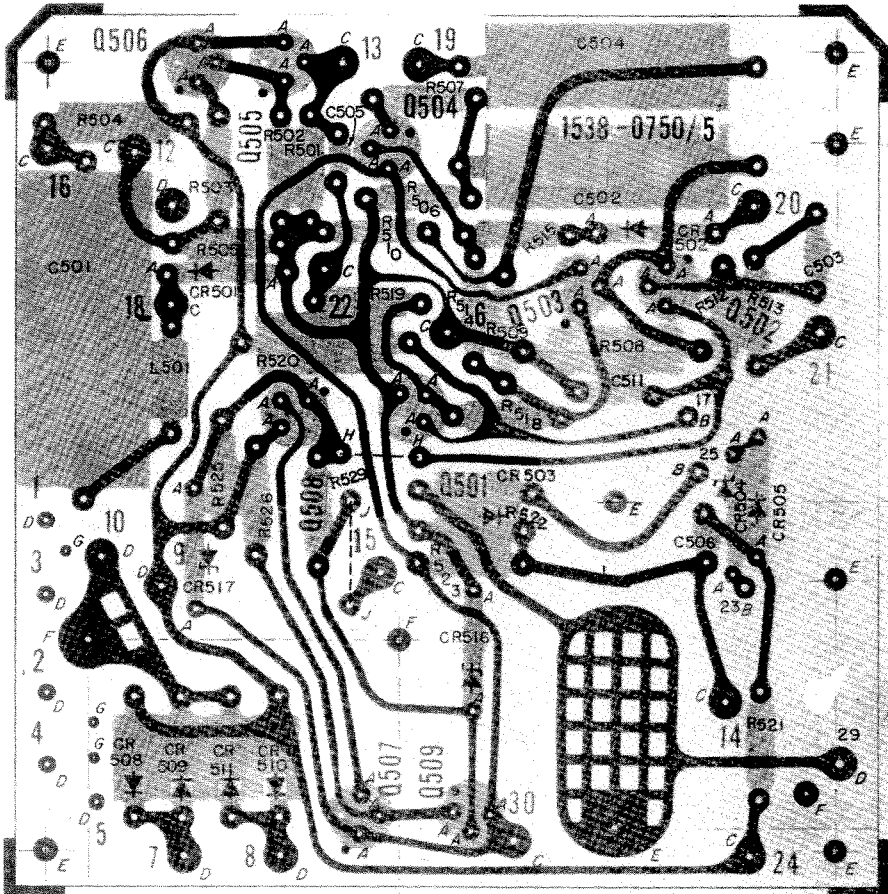

Figure 4-12. Power supply etched-board assembly. (Complete assembly is P/N 1538-2751).

NOTE: The number appearing on the foil side is not the part number. The dot on the foil at the transistor socket indicates the collector lead.

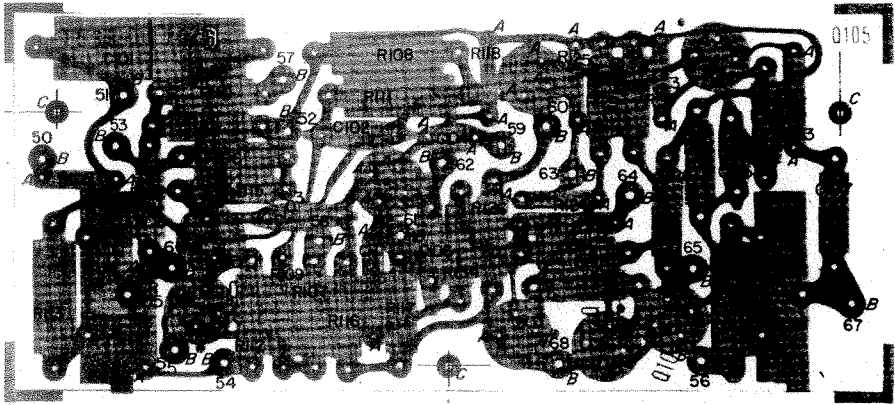

Figure 4-13. Oscillator etched-board assembly.
(Complete assembly in P/N 1538-2710.)

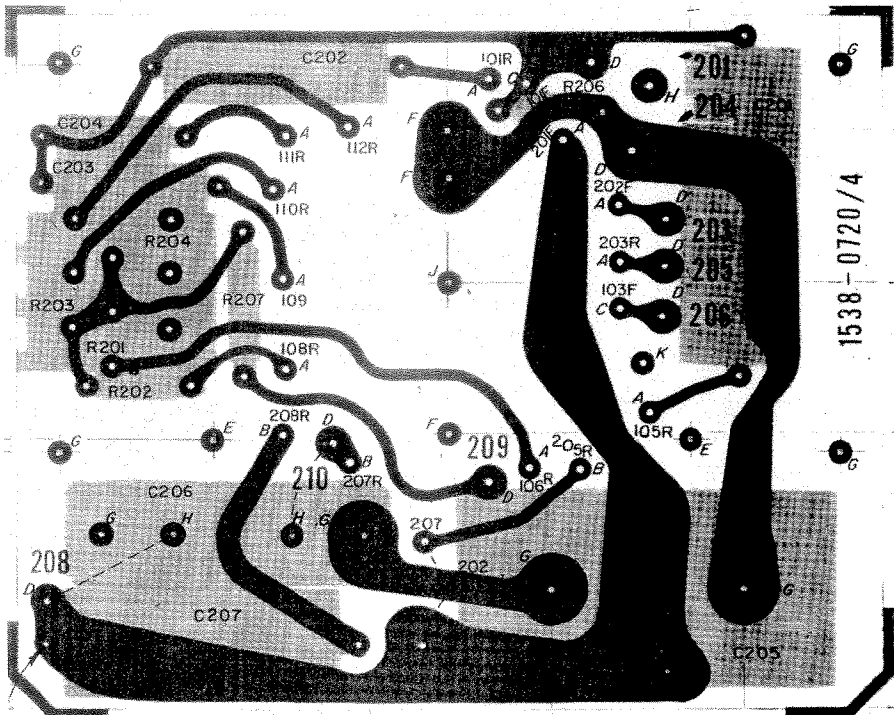

Figure 4-14. Switch-circuit etched-board assembly.
(Complete assembly is P/N 1538-2721.)

NOTE: The number appearing on the foil side is not the part number.
The dot on the foil at the transistor socket indicates the collector lead.

PARTS LIST

(Type 1538-A)

Ref. No.	Description	Part No.	FMC	Mfg. Part No.	Fed. Stock No.
Capacitors					
C101	Paper, 0.10 μ F $\pm 10\%$ 100 V	4860-8250	59875	663UW, 0.10 μ F $\pm 10\%$	
C102	Ceramic, 0.0022 μ F $\pm 10\%$ 500 V	4406-2228	72982	811, 0.0022 μ F $\pm 10\%$	
C103	Ceramic, 0.01 μ F $\pm 80-20\%$ 500 V	4406-3109	72982	811, 0.00X5U103X	5910-977-7579
C104	Ceramic, 390 pF $\pm 10\%$ 500 V	4404-1398	72982	831, 390 pF $\pm 10\%$	5910-978-4403
C105	Ceramic, 0.0022 μ F $\pm 10\%$ 500 V	4406-2228	72982	811, 0.0022 μ F $\pm 10\%$	
C106	Ceramic, 0.022 μ F $\pm 80-20\%$ 500 V	4407-3229	72982	CC63, 0.022 μ F $\pm 80-20\%$	5910-842-2961
C107	Tantalum, 1.0 μ F $\pm 20\%$ 35 V	4450-4300	56289	1500105X003582	5910-726-5003
C201	Plastic, 1.09 μ F $\pm 1\%$ 100 V	4860-8010	84411	663UW, 1.09 μ F $\pm 1\%$	
C202	Plastic, 0.182 μ F $\pm 1\%$ 100 V	4860-7905	84411	663UW, 0.182 μ F $\pm 1\%$	
C203	Plastic, 0.0301 μ F $\pm 1\%$ 100 V	4860-7842	84411	663UW, 0.0301 μ F $\pm 1\%$	
C204	Plastic, 0.00432 μ F $\pm 1\%$ 200 V	4860-7382	84411	663UW, 0.00432 μ F $\pm 1\%$	
C205	Special Oil and Paper, 1.15 μ F $\pm 10\%$ 1000 V	1531-4020	74861	#2368, Visco Film	5910-893-0873
C206	Special Oil and Paper, 0.22 μ F $\pm 10\%$ 1000 V	1531-0470	24655	1531-0470	5910-893-0877
C207	Special Oil and Paper, 0.035 μ F $\pm 10\%$ 1000 V	1538-0441	74861	2767-TVV	
C501	Plastic, 1.3 μ F $\pm 1\%$ 100 V	4860-8285	59875	663UW, 1.3 μ F $\pm 1\%$	
C502	Oil, 0.022 μ F $\pm 5\%$ 600 V	4510-4001	56289	73P22356	
C503	Ceramic, 0.0022 μ F $\pm 10\%$ 500 V	4406-2228	72982	811, 0.0022 μ F $\pm 10\%$	
C504	Oil, 0.022 μ F $\pm 10\%$ 600 V	4510-4000	56289	73P22396	5910-794-3648
C505	Ceramic, 220 pF $\pm 10\%$ 500 V	4404-1228	72982	831, 220 pF $\pm 10\%$	
C506	Ceramic, 0.001 μ F $\pm 10\%$ 500 V	4405-2108	72982	801, 0.001 μ F $\pm 10\%$	
C509A	600 μ F				
C509B	Electrolytic, 300 μ F $\pm 100-10\%$ 75 V	4450-5606	37942	FP20000022414005	
C509C	300 μ F				
C511	Ceramic, 0.1 μ F $\pm 80-20\%$ 50 V	4403-4100	80131	CC63, 0.1 μ F $\pm 80-20\%$	5910-811-4788
C901	Special Oil and Paper, 0.007 μ F $\pm 10\%$ 1000 V	1538-0440	74861	2730-TVV	
Cable, Power					
		4200-1800	24655	4200-1800	5995-738-6446
Diodes					
CR101	Type 1N625	6082-1012	24446	1N4009	
CR102	Type 1N625	6082-1012	24446	1N4009	
CR103	Type 1N645	6082-1016	24446	1N645	5961-944-8222
CR105	Type 1N455	6082-1010	07910	1N455	5960-877-8255
CR501	Type 1N645	6082-1016	24446	1N645	5961-944-8222
CR502	Type 1N625	6082-1012	24446	1N4009	
CR503	Type 1N3253	6081-1001	79089	1N3253	5961-814-4251
CR504	Type LMZ39.0A	6083-1059	79089	LMZ-39.0A	
CR505	Type 1N645	6082-1016	24446	1N645	5961-944-8222
CR507	Type MV16A	6081-1015	13327	MV16A	
CR508	Type 1N3253	6081-1001	79089	1N3253	5961-814-4152
CR509	Type 1N3253	6081-1001	79089	1N3253	5961-814-4152
CR510	Type 1N3253	6081-1001	79089	1N3253	5961-814-4152
CR511	Type 1N3253	6081-1001	79089	1N3253	5961-814-4152
CR516	Type 1N965B	6083-1015	07910	1N965B	5960-877-6192
CR517	Type 1N748A	6083-1002	07910	1N748A	5960-800-3973
Fuse					
F901	0.25A	5330-0700	71400	MDL, 0.25A	5920-933-5435
Inductor					
L501	1.8 μ H $\pm 10\%$	4300-1100	99800	1537, 1.8 μ H $\pm 10\%$	
Jacks					
J901		4260-1030	82389	#111	
J902		4260-1030	82389	#111	
Pilot Lamp					
P901	GE #1819 28 V 0.04 A	5600-1000	24454	#1819, 0.04A clear	

PARTS LIST (Cont)

(Type 1538-A)

Ref. No.	Description	Part No.	FMC	Mfg. Part No.	Fed. Stock No.
Mask, Scale		1538-1050	24655	1538-1050	
Plug					
PL901		4220-4400	71785	P-304-AB	
Reflector Assembly		1531-7002	24655	1531-7002	
Resistors					
R101	Composition, 100 kΩ ±5% 1/2 W	6100-4105	01121	RC20GF104J	5905-195-6761
R102	Composition, 470 kΩ ±5% 1/2 W	6100-4475	01121	RC20GF474J	5905-279-2515
R103	Film, 6.98 kΩ ±1% 1/2 W	6450-1698	75042	CEC, 6.98 kΩ ±1%	
R104	Potentiometer, 2 kΩ ±10%	6059-2209	80294	3067P-1-202	
R105	Composition, 24 kΩ ±5% 1/4 W	6099-3245	75042	BTS, 24 kΩ ±5%	
R106	Composition, 20 kΩ ±5% 1/2 W	6100-3205	01121	RC20GF203J	5905-192-0649
R107	Composition, 2.4 kΩ ±5% 1/2 W	6100-2245	01121	RC20GF242J	5905-279-1877
R108	Film, 14 kΩ ±1% 1/2 W	6450-2140	75042	CEC, 14 kΩ ±1%	
R109	Composition, 2.2 kΩ ±5% 1/2 W	6100-2225	01121	RC20GF222J	5905-279-1876
R110	Composition, 4.7 kΩ ±5% 1/2 W	6100-2475	01121	RC20GF472J	5905-279-3504
R111	Film, 5.9 kΩ ±1% 1/2 W	6450-1590	75042	CEC, 5.9 kΩ ±1%	
R112	Composition, 620 Ω ±5% 1/2 W	6100-1625	01121	RC20GF621J	5905-279-1761
R113	Film, 5.49 kΩ ±1% 1/2 W	6450-1549	75042	CEC, 5.49 kΩ ±1%	
R114	Potentiometer, 1 kΩ ±10%	6059-2109	80294	3067P-1-102	
R115	Composition, 2 kΩ ±5% 1/2 W	6100-2205	01121	RC20GF202J	5905-190-8887
R116	Composition, 10 kΩ ±5% 1/2 W	6100-3105	01121	RC20GF103J	5905-185-8510
R117	Composition, 1 kΩ ±5% 1/2 W	6100-2105	01121	RC20GF102J	5905-195-6806
R118	Composition, 1 kΩ ±5% 1/4 W	6099-2105	75042	BTS, 1 kΩ ±5%	
R120	Composition, 43 kΩ ±5% 1/2 W	6100-3435	01121	RC20GF433J	5905-279-3498
R121	Composition, 10 kΩ ±5% 1/2 W	6100-3105	01121	RC20GF103J	5905-185-8510
R122	Composition, 4.7 kΩ ±5% 1/2 W	6100-2475	01121	RC20GF472J	5905-279-3504
R123	Composition, 4.7 kΩ ±5% 1/4 W	6099-2475	75042	BTS, 4.7 kΩ ±5%	
R124	Composition, 22 kΩ ±5% 1/4 W	6099-3225	75042	BTS, 22 kΩ ±5%	
R125	Composition, 2.2 kΩ ±5% 1/4 W	6099-2225	75042	BTS, 2.2 kΩ ±5%	
R126	Composition, 10 kΩ ±5% 1/2 W	6100-3105	01121	RC20GF103J	5905-185-8510
R129	Composition, 4.7 kΩ ±5% 1/2 W	6100-2475	01121	RC20GF472J	5905-279-3504
R130	Composition, 100 kΩ ±5% 1/2 W	6100-4105	01121	RC20GF104J	5905-195-6761
R131	Composition, 100 kΩ ±5% 1/2 W	6100-4105	01121	RC20GF104J	5905-195-6761
R133	Composition, 4.7 kΩ ±5% 1/2 W	6100-2475	01121	RC20GF472J	5905-279-3504
R134	Composition, 22 kΩ ±5% 1/2 W	6100-3225	01121	RC20GF223J	5905-171-2004
R201	Potentiometer, 50 kΩ ±20%	6001-3509	80294	3068P, 50 kΩ ±20%	
R202	Composition, 24 kΩ ±5% 1/2 W	6100-3245	01121	RC20GF243J	5905-279-1878
R203	Potentiometer, 50 kΩ ±20%	6001-3509	80294	3068P, 50 kΩ ±20%	
R204	Potentiometer, 50 kΩ ±20%	6001-3509	80294	3068P, 50 kΩ ±20%	
R205	Composition, 10 kΩ ±5% 1/2 W	6100-3105	01121	RC20GF103J	5905-185-8510
R206	Composition, 4.7 kΩ ±5% 1/2	6100-2475	01121	RC20GF472J	5905-279-3504
R207	Film, 464 kΩ ±1% 1/2 W	6450-3464	75042	CEC, 464 kΩ ±1%	
R501	Composition, 47 kΩ ±5% 1/2 W	6100-3475	01121	RC20GF473J	5905-254-9201
R502	Composition, 3.3 kΩ ±5% 1/2 W	6100-2335	01121	RC20GF332J	
R503	Composition, 180 Ω ±5% 1/2 W	6100-1185	01121	RC20GF181J	5905-279-3514
R504	Potentiometer, 82 Ω ±5% 3 W	6680-0825	80183	242E, 82 Ω ±5%	
R505	Composition, 47 Ω ±5% 1/2 W	6100-0475	01121	RC20GF470J	5905-252-4018
R506	Composition, 1 kΩ ±5% 1/2 W	6100-2105	01121	RC20GF102J	5905-195-6806
R507	Composition, 2.2 kΩ ±5% 1/2 W	6100-2225	01121	RC20GF222J	5905-279-1876
R508	Film, 34 kΩ ±1% 1/2 W	6450-2340	75042	CEC, 34 kΩ ±1%	
R509	Composition, 2.2 kΩ ±5% 1/2 W	6100-2225	01121	RC20GF222J	5905-279-1876
R510	Composition, 1 kΩ ±5% 1/2 W	6100-2105	01121	RC20GF102J	5905-195-6806
R512	Composition, 47 kΩ ±5% 1/2 W	6100-3475	01121	RC20GF473J	5905-254-9201
R513	Composition, 10 kΩ ±5% 1/2 W	6100-3105	01121	RC20GF103J	5905-185-8510
R514	Composition, 47 kΩ ±5% 1/2 W	6100-3475	01121	RC20GF473J	5905-254-9201
R515	Composition, 22 kΩ ±5% 1/2 W	6100-3225	01121	RC20GF223J	5905-171-2004
R518	Composition, 18 kΩ ±5% 1/2 W	6100-3185	01121	RC20GF183J	5905-279-3500
R519	Composition, 18 kΩ ±5% 1/2 W	6100-3185	01121	RC20GF183J	5905-279-3500

PARTS LIST (Type 1538-A)

Ref. No.	Description	Part No.	PMC	Mfg. Part No.	Fed. Stock No.
Resistors (cont)					
R520	Composition, 1 kΩ ±5% 2 W	6120-2105	01121	RC42GF102J	5905-256-3361
R521	Composition, 27 Ω ±5% 1/2 W	6100-0275	01121	RC20GF270J	5905-279-1879
R522	Composition, 620 kΩ ±5% 1/2 W	6100-4625	01121	RC20GF624J	5905-221-5841
R523	Composition, 10 kΩ ±5% 1/2 W	6100-3105	01121	RC20GF103J	5905-185-8510
R524	Composition, 27 kΩ ±5% 1/2 W	6100-3275	01121	RC20GF273J	5905-279-3499
R525	Composition, 3.3 kΩ ±5% 1/2 W	6100-2385	01121	RC20GF332J	
R526	Composition, 270 Ω ±5% 1/2 W	6100-1275	01121	RC20GF271J	5905-171-2006
R901	Potentiometer, 20 kΩ	0975-4060	24655	0975-4060	
R902	Composition, 4.3 kΩ ±5% 1/2 W	6100-2435	01121	RC20GF432J	5905-257-0935
Socket					
SO901		1538-8090	24655	1538-8090	
Switches					
S201		7890-3940	76854		
S901		7910-1500	04009	83054-SA	5930-615-1394
S902		7910-1300	04009	83053-SA	5930-909-3510
S903		1538-3070	24655	1538-3070	
Swivel Support					
1531-2020		24655	1531-2020		
Transformers					
T501		0345-4130	24655	0345-4130	
T502		0746-4450	24655	0746-4450	
T901		1538-2000	24655	1538-2000	
Transistors					
Q101	Type 2N2714	8210-1047	24446	2N3414	5961-989-2749
Q102	Type 2N2714	8210-1047	24446	2N3414	5961-989-2749
Q103	Type 2N2714	8210-1047	24446	2N3414	5961-989-2749
Q104	Type 2N2714	8210-1047	24446	2N3414	5961-989-2749
Q105	Type 2N1303	8210-1019	96214	2N1303	
Q106	Type 2N1303	8210-1019	96214	2N1303	
Q107	Type 2N2714	8210-1047	24446	2N3414	5961-989-2749
Q108	Type 2N2714	8210-1047	24446	2N3414	5961-989-2749
Q501	Type 2N1305	8210-1305	96214	2N1305	5961-853-1079
Q502	Type 2N2714	8210-1047	24446	2N3414	5961-989-2749
Q503	Type 2N2714	8210-1047	24446	2N3414	5961-989-2749
Q504	Type 2N2714	8210-1047	24446	2N3414	5961-989-2749
Q505	Type 2N697	8210-1040	82219	2N697	5961-752-0150
Q506	Type 2N697	8210-1040	82219	2N697	5961-989-2749
Q507	Type 2N2714	8210-1047	24446	2N3414	5961-989-2749
Q508	Type 2N697	8210-1040	82219	2N697	5961-752-0150
Q509	Type 2N1305	8210-1305	96214	2N1305	5961-853-1079
Q510	Type 2N1546	8210-1073	75491	2N1546	
Q901	Type 2N2147	8210-1072	75491	2N2147	
Tubes					
V901	Neon	8390-0310	24446	NB-2L	
V902	Stroboform	1538-9601	24655	1538-9601	
Etched Circuit Boards					
Power Supply		1538-2751	24655	1538-2751	
Oscillator		1538-2711	24655	1538-2711	
Switch Circuit		1538-2721	24655	1538-2721	
Miscellaneous					
Pivot Blocks		1531-7110	24655	1531-7110	
Cover		1531-7120	24655	1531-7120	
Spring Washers		1531-8110	24655	1531-8110	
Dial Assembly		1531-1040	24655	1538-1040	

(Refer to Figure 4-9 for other miscellaneous part numbers)

- 1. FROM ONE IN MICROF.
- 2. SUPPLIED IN INSTRUCTION BOOK.
- 3. REFER TO SERVICE NOTES IN INSTRUCTION BOOK FOR MOUNTING TECHNIQUES.
- 4. RESISTORS 1/2 WATT.
- 5. 10 TP TEST POINT
- 6. 10 TP TEST POINT
- 7. KNOB CONTROL
- 8. SCREWDRIVER COP
- 9. ANCHOR TERMINAL

NUMBERING
 "100" SERIES ON OSCILLATOR BOARD (538-2711)
 "200" SERIES ON SWITCH BOARD (538-2721)
 "500" SERIES ON BOARD (538-2751)
 "900" SERIES ON PANEL & BRACKET

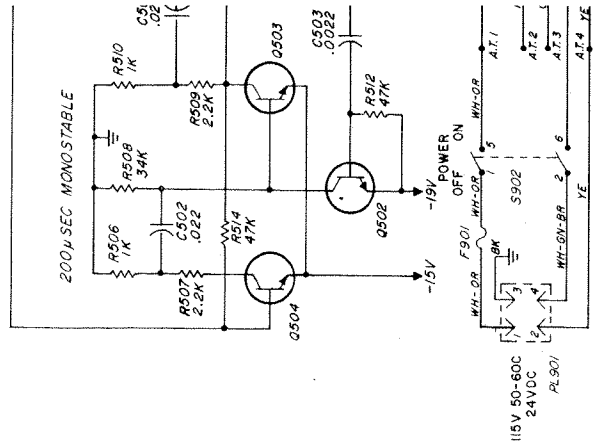
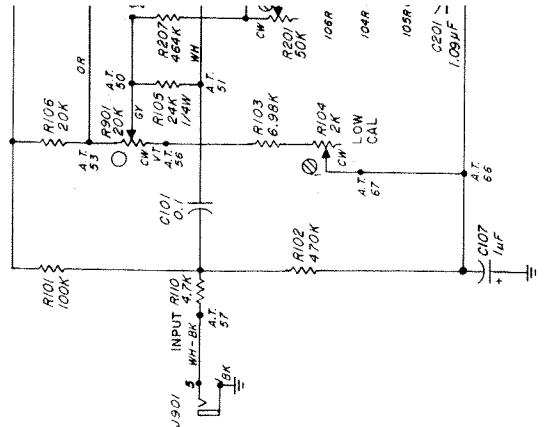

FOR 115V OPERATION
 CONNECT A.T.1 TO A.T.3 & A.T.2 TO A.T.4
 FOR 230V OPERATION
 CONNECT A.T.2 TO A.T.3
 F901 = 0.25 AMP
 F902 = 0.25 AMP

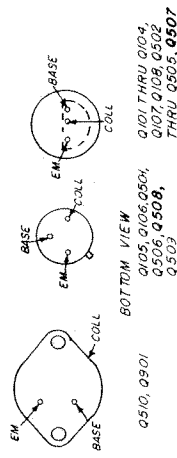

Q510, Q901
 Q505, Q506, Q508, Q509, Q520
 Q503, Q504, Q505, Q506, Q507, Q508, Q509, Q510, Q511, Q512, Q513, Q514, Q515, Q516, Q517, Q518, Q519, Q520, Q521, Q522, Q523, Q524, Q525, Q526, Q527, Q528, Q529, Q530, Q531, Q532, Q533, Q534, Q535, Q536, Q537, Q538, Q539, Q540

the panel is 1, the next section back is 2, etc. The next two digits refer to the contact. Contact 01 is the first position clockwise from a strut screw (usually the screw above the locating key), and the other contacts are numbered sequentially (02, 03, 04, etc), proceeding clockwise around the section. A suffix F or R indicates that the contact is on the front or rear of the section, respectively.

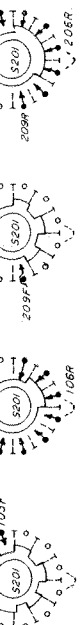

- 670 - 4170 RPM
- 4000 - 25000RPM
- 24000 - 150000 RPM
- CAL

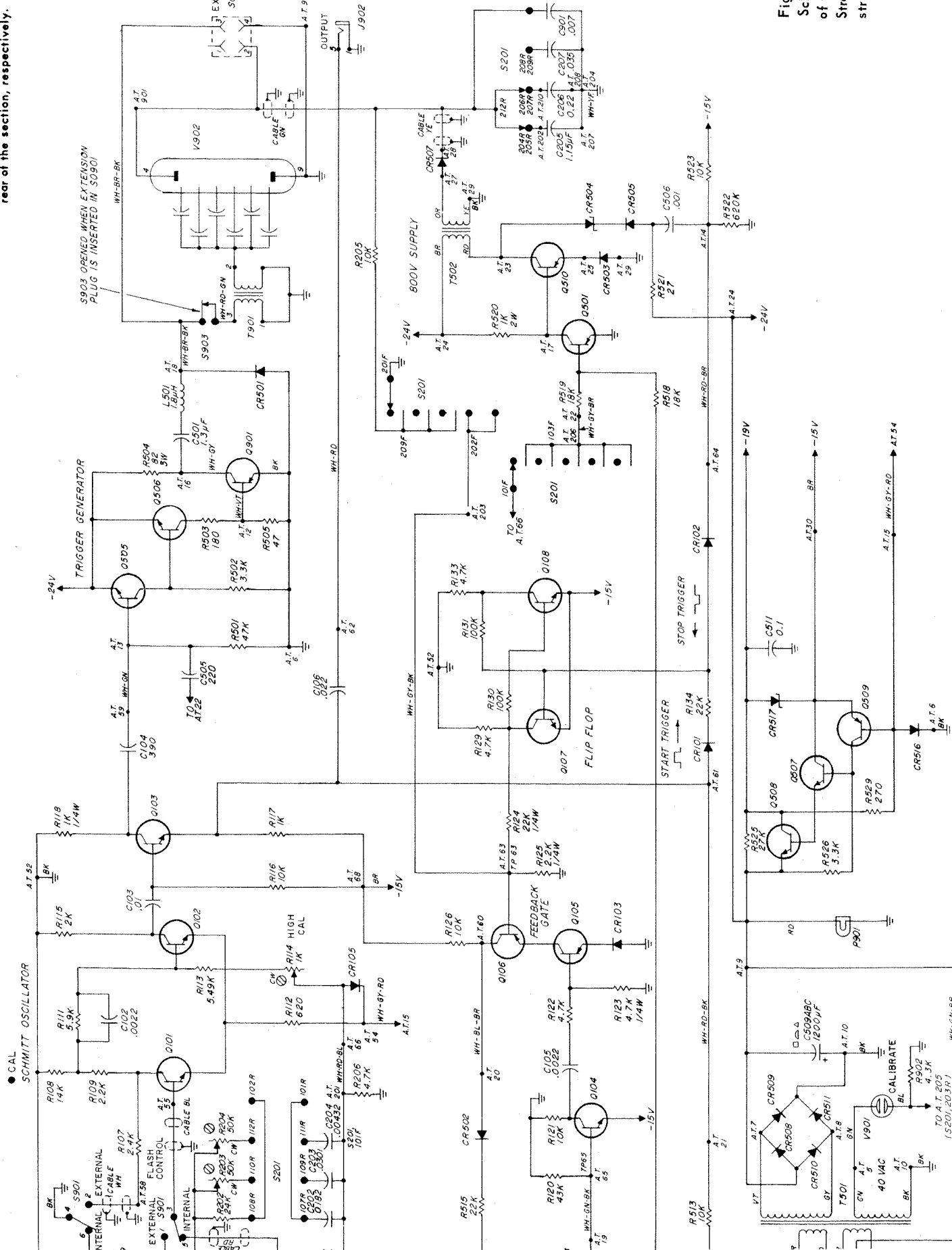

Figure 4-15. Schematic diagram of the Type 1538 Stroboscopic electronic stroboscope.

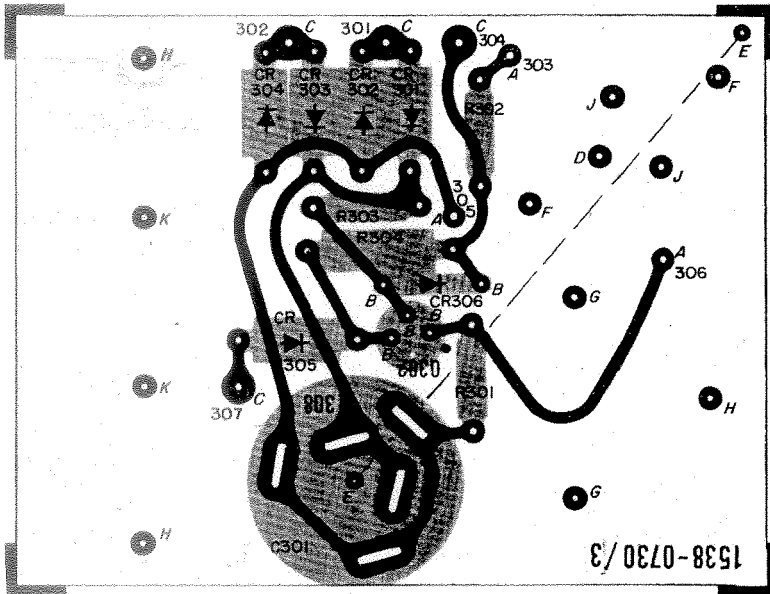

Figure 4-16. Battery-Charger etched-board assembly in the 1538-P3.
(Complete assembly is P/N 1538-2731.)

NOTE: The number appearing on the foil side is not the part number.
The dot on the foil at the transistor socket indicates the collector lead.

FEDERAL MANUFACTURERS CODE
(FMC)

From Federal Supply Code for Manufacturers Cataloging Handbooks H4-1
(Name to Code) and H4-2 (Code to Name) as supplemented through March 1963.

Code	Manufacturers Name and Address
01121	Allen-Bradley Co., Milwaukee, Wis.
04009	Arrow, Hart and Hegeman Elec. Co., Hartford, Conn.
07910	Continental Device Corp., Hawthorne, Calif.
13327	Solitron Devices, Norwood, N. J.
24446	G.E. (Tube Division) Schenectady, N. Y.
24454	G.E. (Lamp Div) Nela Park, Cleveland, Ohio
24655	General Radio Co., West Concord, Mass.
37942	P.R. Mallory and Co. Inc., Detroit, Mich.
56289	Sprague Electric Co., North Adams, Mass.
59875	Thompson Ramo Woolridge, Inc., Cleveland, Ohio
71400	Bussman Fuse Co., St. Louis, Mo.
71785	Cinch Mfg. Co., Chicago, Illinois
72982	Erie Resistor Corp., Erie, Penn.
74861	Industrial Condenser Corp., Chicago, Ill.
75042	International Resistance Co., Philadelphia, Penn.
75491	Lafayette Radio Corp., New York, N. Y.
76854	Oak Mfg. Co., Chicago, Illinois
79089	R.C.A. Victor Television, Camden, N. J.
80131	Electronic Industries Assoc., Washington, D.C.
80183	Sprague Products Co., North Adams, Mass.
80294	Bourns Laboratories, Inc., Riverside, Calif.
82219	Sylvania Electric Products, Emporium, Penn.
82389	Switchcraft, Inc., Chicago, Illinois
84411	Good-All Electric Mfg. Co., Ogallala, Nebr.
96214	Texas Instruments Inc. (Apparatus Div), Dallas, Texas
99800	Develan Electronics Corp., E. Aurora, N. Y.

200
250
50-60HZ

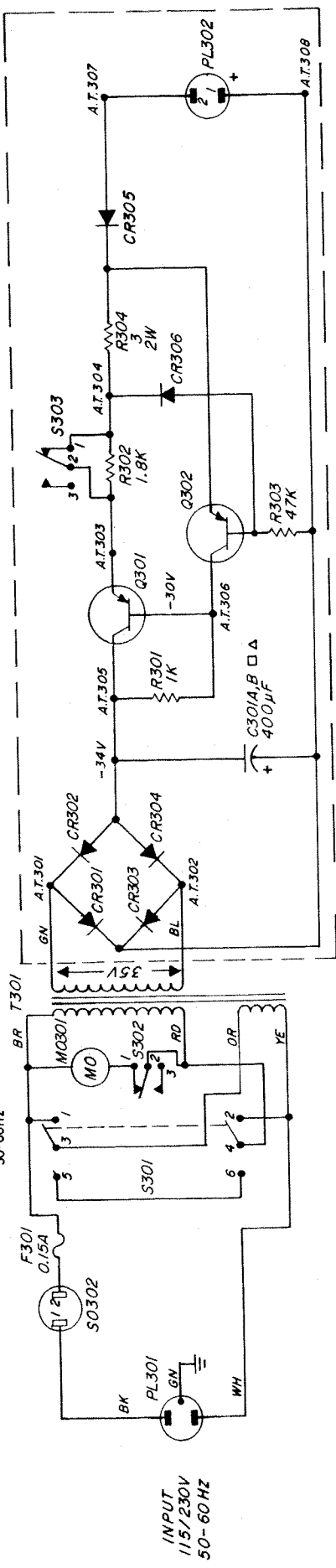

CHARGER UNIT

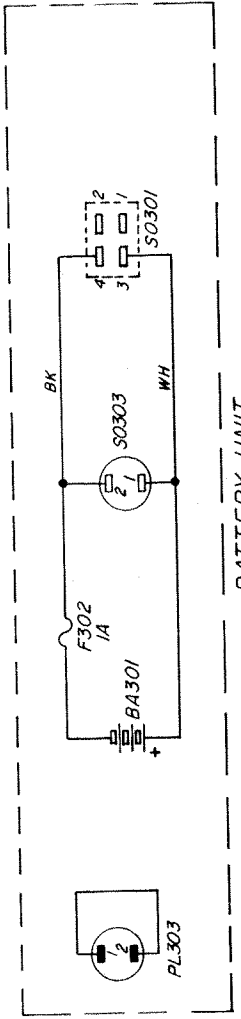

BATTERY UNIT

SCHEMATIC DIAGRAM FOR 1538-P3 BATTERY CHARGER

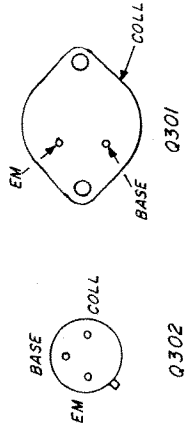

BOTTOM VIEW OF TRANSISTORS

NOTE:
1. VOLTAGES SHOWN ARE FOR CONSTANT CURRENT CHARGE 200 ma DC
2. S303 MUST OPEN BEFORE S302 HITS STOP AT CCW END OF ROTATION

NOTE UNLESS SPECIFIED

1. POSITION OF ROTARY SWITCHES SHOWN COUNTERCLOCKWISE.
2. CONTACT NUMBERING OF SWITCHES EXPLAINED ON SEPARATE SHEET SUPPLIED IN INSTRUCTION BOOK.
3. REFER TO SERVICE NOTES IN INSTRUCTION BOOK FOR VOLTAGES APPEARING ON DIAGRAM.
4. RESISTORS 1/2 WATT.
5. RESISTANCE IN OHMS K - 1000 OHMS M - 1 MEGOHM
6. CAPACITANCE VALUES ONE AND OVER IN PICO-FARADS, LESS THAN ONE IN MICROFARADS.
7. ○ KNOB CONTROL
8. ⊗ SCREWDRIVER CONTROL
9. AT ANCHOR TERMINAL
10. TP - TEST POINT

Figure 4-17. Schematic diagram of the Type 1538-P3 Charger Unit and Battery Unit.

APPENDIX

Type 1539-A STROBOSLAVE

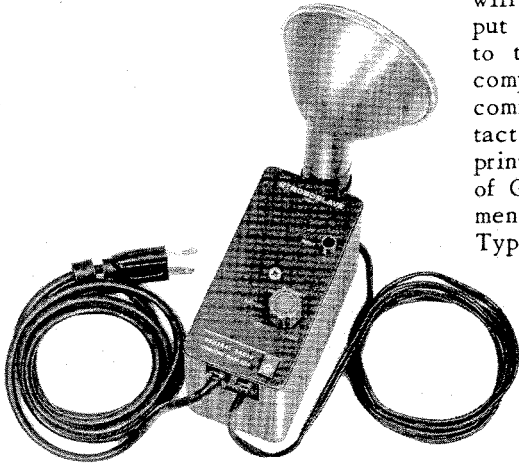

The Type 1539 Stroboslave is an inexpensive, auxiliary light-source that will produce a flashing light with output characteristics that are similar to the Type 1531 Strobotac. This compact stroboscope will flash on command when triggered from a contact closure in a textile machine, printing press, etc., or from a variety of General Radio stroboscopic equipment including the Type 1531 or the Type 1538 Strobotacs.

SPECIFICATIONS

Flashing-Rate Ranges: 0 to 700, 0 to 4200, 0 to 25,000 flashes per min on high-, medium-, and low-intensity ranges, respectively.

Flash Duration: Approx 0.8, 1.2, and 3 μ s, measured at $\frac{1}{2}$ peak intensity, for the low-, medium-, and high-intensity ranges, respectively.

Peak Light Intensity: Typically 0.6, 3.5, and 11 million beam candles (0.6, 3.5, and 11×10^6 lux measured at 1-m distance at the beam center), for low-, medium-, and high-intensity ranges, respectively. For single flash, 18 million beam candles at 1 meter.

Reflector Beam Angle: 10° at half-intensity points.

External Triggering: Either a switch closure across the input jack terminals or a 2-V (peak) positive pulse.

Power Required: 100 to 125 or 195 to 250 V, 50 to 400 c/s, 16 W

Accessories Supplied: Phone plug for input, mounting bracket.

Accessories Available: TYPE 1537-A Photoelectric Pickoff, TYPE 1531-P2 Flash Delay (with a TYPE 1536-A Photoelectric Pickoff), TYPE 1535-B Contactor.

Mechanical Data:

Width		Height		Depth		Net Weight		Shipping Weight	
in	mm	in	mm	in	mm	lb	kg	lb	kg
2 $\frac{1}{2}$	64	8 $\frac{3}{8}$	215	4 $\frac{1}{8}$	105	2 $\frac{3}{4}$	1.3	8	3.7

Type 1531-P2 FLASH DELAY

The Type 1531-P2 Flash Delay provides a continuously adjustable time-delay between an external triggering device and a stroboscope. The triggering device can be an oscillator, photocell or other type of transducer.

A typical combination of flash delay, photoelectric pickoff and stroboscope (shown below) can be used for visual observation and analysis of repetitive motion whose period is not constant. The flash delay also provides means for precise synchronization of camera shutter, stroboscopic flash, and objects moving at irregular speeds for high-speed photography.

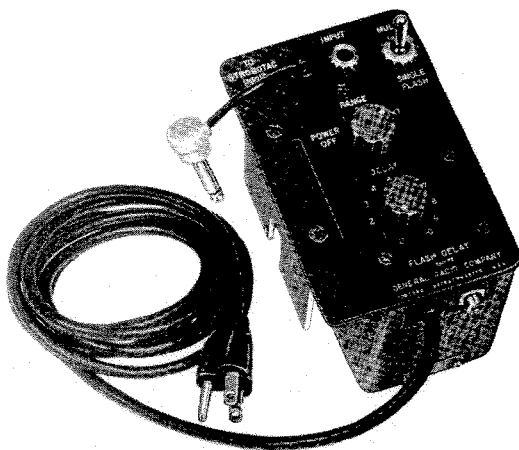

SPECIFICATIONS

Time-Delay Range: Approximately 100 μ s to 0.8 s in three ranges.

Output Pulse: Better than 13 V available for triggering the TYPE 1531-A and 1538-A STROBOTAC® electronic stroboscopes and the TYPE 1539-A Stroboslave.

Sensitivity: As little as 0.3-V input will produce sufficient output to trigger the stroboscope.

Inputs: Phone jack for triggering; jack for camera synchronization.

Accessories Available: TYPE 1536-A Photoelectric Pickoff.

Power Required: 105 to 125 or 210 to 250 V, 50 to 400 c/s, 5 W with TYPE 1536-A connected.

Mounting: Aluminum case with bracket, which clips directly onto the STROBOTAC electronic stroboscope.

Mechanical Data:

Width		Height		Depth		Net Weight		Shipping Weight	
in	mm	in	mm	in	mm	lb	kg	lb	kg
5 1/8	135	3 1/8	80	3 3/4	96	2	1	5	2.3

PARTS LIST
(Type 1538-P3)

Ref. No.	Description	GR Part No.	FMC	Mfg. Part No.	Fed. Stock No.
Capacitors					
C301A C301B	Electrolytic, 200 μ F +100-10% 50 V	4450-5591	80183	D38858	5910-959-4572
Resistors					
R301	Composition, 1 k Ω \pm 5% 1/2 W	6100-2105	01121	RC20GF102J	5905-195-6806
R302	Composition, 1.8 k Ω \pm 5% 1/2 W	6100-2185	01121	RC20GF182J	5905-190-8881
R303	Composition, 47 k Ω \pm 5% 1/2 W	6100-3475	01121	RC20GF473J	5905-254-9201
R304	Wire-wound, 3 Ω \pm 10% 2 W	6760-0039	75042	BWH, 3 Ω \pm 10%	
Transistors					
Q301	Type 2N1540	8210-1540	80211	2N1540	
Q302	Type 2N1303	8210-1019	96214	2N1303	
Diodes					
CR301 thru CR305 CR306	Type 1N3253	6081-1001	79089	1N3253	5961-814-4251
	Type 1N645	6082-1016	24446	1N645	5961-944-8222
Fuses					
F301	Fuse 0.15 A	5330-0500	71400	MDL, 0.15 Amp	
F302	Fuse 1 A	5330-1400	71400	MDL, 1 Amp	
Switches					
S301	Line Input	7910-0831	42190	4603	
S302		1538-8350	24655	1538-8350	
S303		1538-8350	24655	1538-8350	
Transformer					
T301		0745-4410	24655	0745-4410	
Plugs					
PL301	Power Cable	4200-1924	24655	4200-1924	6150-765-5426
PL302		4220-4301	24655	4220-4301	
PL303		4220-4301	24655	4220-4301	
Sockets					
SO301	Power Cable	1538-0480	24655	1538-0480	
SO302		4230-3301	24655	4230-3301	
SO303		4230-3301	24655	4230-3301	
Motor					
MO301		5760-3080	93916	117P	
Battery					
BA301		8410-1080	24454	41B002X007	
Miscellaneous					
Fig. 4-16	Etched Circuit Assembly	1538-2731	24655	1538-2731	
	Knob Assembly (Marked)	1538-1311	24655	1538-1311	
	Hub	1538-6010	24655	1538-6010	
	Fastener, Ring, Internal, 7/8 ID	5220-0400	24655	5220-0400	5340-857-2160
	Washer	8080-0700	24655	8080-0700	
	Washer	8150-0200	24655	8150-0200	5310-849-7195

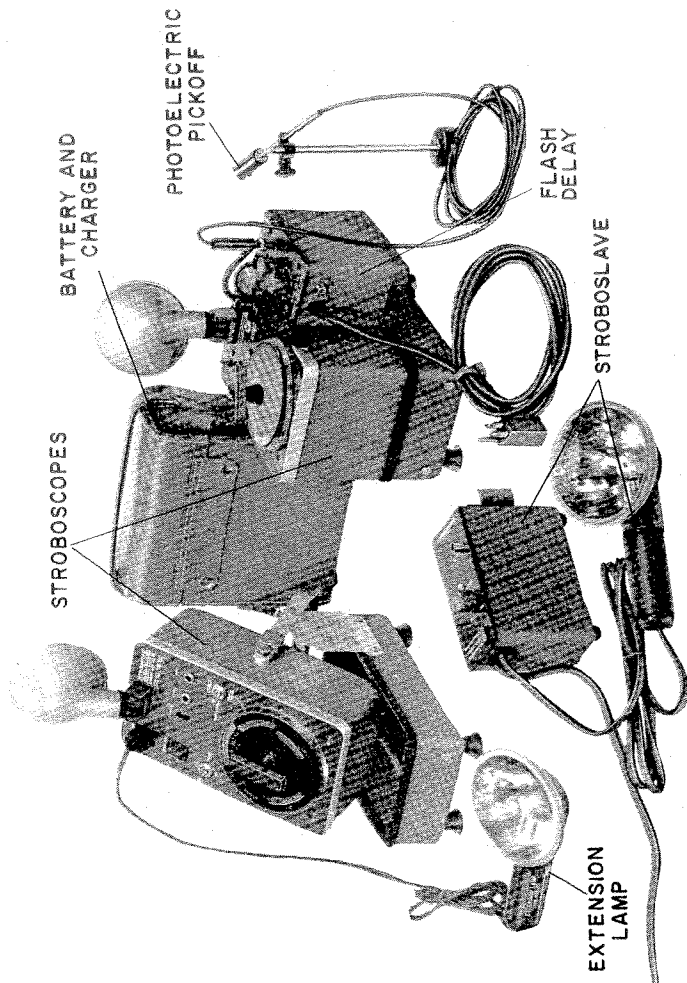

Some of the many accessory instruments available for use with the stroboscopes.

Type 1538-P3 BATTERY AND CHARGER

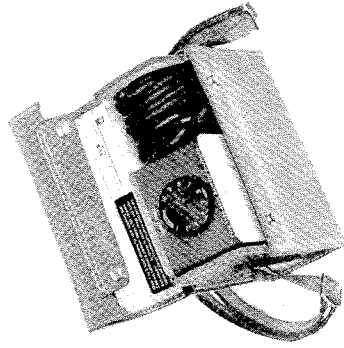

The Type 1538-P3 Battery and Charger is recommended for battery operation of the Type 1538 Strobotac electronic stroboscope (refer to paragraph 2.3.3). This optional accessory consists of a rechargeable nickel-cadmium battery and an automatic battery charger, mounted in a leather carrying case. Plugged directly into the panel of the stroboscope, this accessory supplies 24 volts, dc.

A fully charged battery will power the Strobotac for about eight hours of normal operation. The charger will recharge the battery overnight, from a power line.

The Type 1538-P3 weighs 9 pounds (4.1 kg). The case is 9 by 8 1/4 by 4 inches (230 x 210 x 105 mm) and comes complete with an adjustable shoulder strap.

Type 1538-P2 EXTENSION LAMP

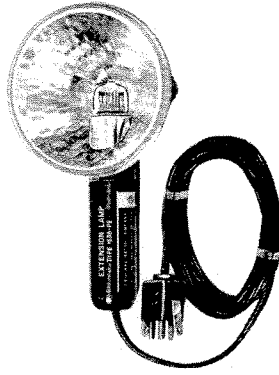

The Type 1538-P2 Extension Lamp consists of a lamp-and-reflector assembly, identical to that on the Strobotac, with a six-foot cord and plug. This light-weight lamp assembly makes a convenient accessory for observing the motion of objects in those hard-to-reach places.

The reflector is 4 inches (105 mm) in diameter and 2 inches (51 mm) deep. The entire assembly (excluding the cord) is 7 inches (180 mm) long; its weight, (including the cord) is 8 ounces (0.3 kg).

Type 1538-P4 HIGH-INTENSITY-FLASH CAPACITOR (See Figure 2-14)

With the Type 1538-P4 High-Intensity-Flash Capacitor connected to the Type 1538 (refer to paragraph 2.11.7), it is possible to produce a single brilliant flash 44 million beam candles with an 8- μ s duration. This accessory should be used when the object being photographed is operating at extremely high speed or unavoidably high ambient light.

The capacitor is 8 5/8 inches (220mm) long, 5 3/8 inches (140 mm) wide, and 1/2 inches (115 mm) high. Its net weight is 5 pounds (2.3 kg), and its shipping weight is 7 pounds (3.2 kg).

Type 1536-A PHOTOELECTRIC PICKOFF

The Type 1536 Photoelectric Pickoff contains a light source, an optical system, and a photocell that produces a pulse when light from a moving object is reflected back to the photocell. This output pulse is fed through a Type 1531-P2 Flash Delay, and then used to trigger a stroboscope. With this combination of instruments, the motion of objects rotating at irregular speeds can be analyzed visually or by photographic means.

SPECIFICATIONS

Maximum Pulse Rate: Approximately 2500 pulses/s as limited by the 200- μ s time constant of the photocell and cable combination.

Power Required: 20 to 28 V dc, 40 mA. Power is supplied by the TYPE 1531-P2 Flash Delay or the TYPE 1150-B (or TYPE 1151-A) Digital Frequency Meter.

Accessories Supplied: 10-ft roll of $\frac{3}{8}$ -in black tape; 10-ft roll of $\frac{3}{8}$ -in silver tape; carrying case.

Mounting: C-clamp (capacity $1\frac{5}{16}$ in, flat or round) or $1\frac{1}{2}$ -in magnet, both supplied.

Net Weight: $1\frac{1}{4}$ lb (0.6 kg). **Shipping Weight:** 4 lb (1.9 kg).

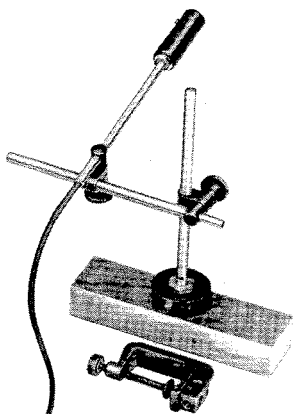

Type 1537-A PHOTOELECTRIC PICKOFF

In appearance, the Type 1537 Photoelectric Pickoff is similar to the Type 1536. The Type 1537, however, has no light source; the photosensitive element is a siliconlight-activated switch. The output from this transducer will trigger directly the Type 1538 Strobotac or the Type 1539 Stroboslave.

SPECIFICATIONS

Operating Rate: Greater than 2500 pulses/s.

Power Required: 3 to 25 V dc; 0 to 100 μ A depending on operating rate. Power is supplied by instrument with which it is used.

Accessories Supplied: 10-ft roll of $\frac{3}{8}$ -in black tape, 10-ft roll of $\frac{3}{8}$ -in silver tape, carrying case.

Mounting: C-clamp (capacity $1\frac{5}{16}$ in, flat or round) or $1\frac{1}{2}$ -in magnet, both supplied.

Net Weight: $1\frac{1}{2}$ lb (0.7 kg). **Shipping Weight:** $4\frac{1}{2}$ lb (2.1 kg).

Type 1531-P3 SURFACE-SPEED WHEEL

The Type 1531-P3 consists of two black nylon wheels mounted on the ends of a sectioned steel rod. When one of the wheels is held against a moving belt, pulley, roller, etc., the rotating wheel can be observed with a stroboscope and the linear surface speed of the object can be accurately determined.



SPECIFICATIONS

Speed Range: 10 to 2500 ft/min with small wheel and 50 to 12,500 ft/min with large wheel.

Dimensions: Wheels are 0.764 and 1.910 inches in diameter, respectively. Three-section shaft totals 20 inches in length.

Net Weight: 8 oz (0.3 kg). **Shipping Weight:** 2 lb (1 kg).

NOMOGRAPH FOR USE IN MEASURING SPEEDS BEYOND THE FLASHING RATE OF THE TYPE 1538 STROBOTAC

The nomograph on the following page can be used to determine quickly the fundamental speed of an object from two successive sub-multiple images.

To use the nomograph, find the point on the X scale corresponding to the highest flashing rate at which a true stopped-motion image occurs. Then find the point on the Y scale where the next lower true stopped image occurs. Hold a straightedge so that it intersects the X and Y scales at the points plotted. The straightedge should intersect the n scale at an integer. Multiply the X scale value by this integer to determine the fundamental speed.

Example:

Suppose that the first time stopped-motion image is obtained at 150,000 rpm, the next lower one at 120,000 rpm. A line drawn through 150 on the X scale and 120 on the Y scale intersects the n scale at 4. Therefore the fundamental speed is 4 x 150,000, or 600,000 rpm.

X

Y

n

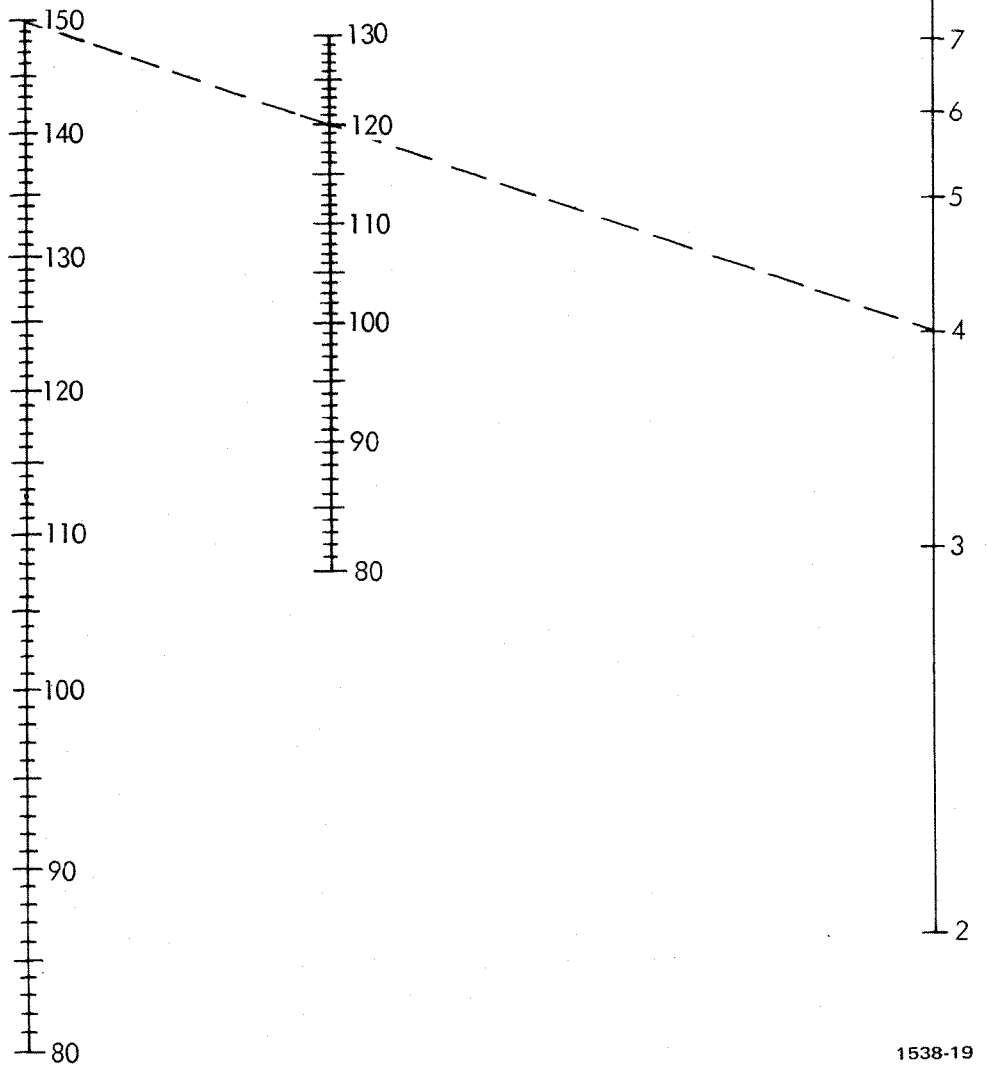

1538-19

Nomograph for use with Type 1538-A Strobotac.