

INSTRUCTION MANUAL

PRECISION OF CALIBRATION

TYPE 1644-A

MEGOHM BRIDGE

Form 1644-0100-C
November, 1967

Copyright 1964 by General Radio Company
West Concord, Massachusetts, USA

G E N E R A L R A D I O C O M P A N Y
WEST CONCORD, MASSACHUSETTS, USA

SPECIFICATIONS

Resistance Range: 1 k Ω to 1000 T Ω (10^3 to 10^{15} Ω) in ten ranges.

Accuracy: 10^3 Ω to 10^{10} Ω , $\pm 1\%$. After self-calibration: 10^{10} to 10^{12} Ω , $\pm 1\%$ *; 10^{13} Ω , $\pm 2\%$; 10^{14} Ω , $\pm 10\%$; 10^{15} Ω , \pm one scale division.

Test Voltage: Voltage accuracy is $\pm 3\% \pm 0.5$ V.

Fixed Voltages	10	20	50	100	200	500	1000	V
Minimum Unknown R	1	3	7	20	50	150	500	k Ω

Short-Circuit Current: <15 mA, 10–50 V; <10 mA, 100–1000 V.

$\Delta R\%$ Dial: $\pm 5\%$ range; accurate to $\pm 0.2\%$ or, for small changes, to $\pm 0.1\%$.

* At high voltages; 1% accuracy is obtainable at 10 V up to 10^{11} Ω ; see above.

Minimum Test Voltage for 1% Resolution: for approx 1-mm meter deflection	Multiplier Setting	Max R_x	Volts
	100 G or less	10^{11}	10
100 G	10^{12}	100	
1 T	10^{13}	200	

Power Required: 105 to 125 or 210 to 250 V, 50 to 60 c/s, 13 W.

Mechanical Data: Flip-Tilt Case

Model	Width		Height		Depth		Net Wt		Ship Wt	
	in	mm	in	mm	in	mm	lb	kg	lb	kg
Portable*	12 3/4	325	12 1/2	320	7 3/4	200	18	8.5	29	13.5
Rack	19	485	12 1/4	315	5†	130	19	9.0	31	14.5

* Dimensions with case closed and including handle. † Behind panel.

See also *General Radio Experimenter*, July 1964.

US Patent Numbers D 187,740 and 2,966,257.

SECTION 1

INTRODUCTION

WARNING

High voltage may be present at any of the red binding posts, depending on the switch settings. Although the current available from the instrument itself is not dangerous under most conditions, lethal energy may be stored in a capacitance connected to the instrument. **ALWAYS SET THE FUNCTION SWITCH TO DISCHARGE BEFORE CONNECTING OR DISCONNECTING THE UNKNOWN COMPONENTS.**

1.1 PURPOSE.

The Type 1644-A Megohm Bridge (Figure 1-1) measures resistance from 10^3 to 10^{15} ohms. It is useful for measurements of resistors, of insulation resistance on components and machinery, for resistivity tests on samples of insulating material, and for leakage-resistance measurements on capacitors. The vernier ($\Delta R\%$) dial permits accurate measurements of voltage and temperature coefficient of resistance. The voltage applied to the unknown may be set from 10 volts to 1000 volts.

1.2 CONTROLS AND CONNECTORS.

Table 1-1 (on page 2) lists the controls and connectors on the panel and sides of the Type 1644-A Megohm Bridge.

Low-thermal-emf binding posts are used for the GUARD, ground, and UNKNOWN terminals. The critical parts of these binding posts are made of gold-plated copper, designed to minimize spurious dc signals caused by thermal disturbances. They are particularly useful in the presence of low-level signals such as those encountered when a bridge is at or near balance.

1.3 SYMBOLS.

The following abbreviations are on the RESISTANCE MULTIPLIER dial of the Type 1644-A Megohm Bridge:

$$\begin{aligned}
 1 \text{ k}\Omega &= 10^3 \Omega \\
 1 \text{ M}\Omega &= 10^6 \Omega = 10^3 \text{ k}\Omega \\
 1 \text{ G}\Omega &= 10^9 \Omega = 10^6 \text{ k}\Omega = 10^3 \text{ M}\Omega \\
 1 \text{ T}\Omega &= 10^{12} \Omega = 10^9 \text{ k}\Omega = 10^6 \text{ M}\Omega = 10^3 \text{ G}\Omega
 \end{aligned}$$



TABLE 1-1
CONTROLS AND CONNECTORS

<i>Name</i>	<i>Type</i>	<i>Function</i>
Function	5-position rotary control	Turns instrument on, selects DISCHARGE, CHARGE-ZERO, or MEASURE function. (See paragraph 2.2.)
COARSE ZERO	Continuous rotary control	For coarse zero adjustment of detector.
FINE ZERO	Continuous rotary control	For sensitive zero adjustment of detector.
VOLTAGE ON UNKNOWN	8-position rotary control	Selects magnitude of internal voltage applied to the unknown or connects an external voltage source. (See paragraph 2.2.)
RESISTANCE MULTIPLIER	10-position rotary control	Selects the measurement range.
R	Continuous rotary control with dial	Balances bridge.
SENSITIVITY	Continuous rotary control	Adjusts the sensitivity of the detector circuit. (See paragraph 2.4.)
$\Delta R\%$	Spring return switch	Inserts $\Delta R\%$ adjustment in the measurement circuit. (See paragraph 2.4.) Balances bridge over $\pm 5\%$ range. (See paragraphs 3.6, 3.7, and 3.8.)
	Continuous rotary control with dial	
- UNKNOWN +	Pair of insulated binding posts	For connection of component to be measured.
Ground	Uninsulated binding post	Ground connection to instrument chassis. (See paragraph 2.1.4.)
GUARD	Insulated binding post	For connection to points to be guarded, such as shields of leads. (See paragraph 3.4.)
EXT GEN	Pair of insulated binding posts	For connection of an external voltage supply. (See paragraph 3.10.)
EXT ADJ	Pair of insulated binding posts	For connection of a resistor to adjust the voltage applied to the unknown to values between those supplied. (See paragraph 3.9.)

SECTION 2

OPERATING PROCEDURE

2.1 INSTALLATION.

2.1.1 OPENING AND TILTING THE CABINET.

The directions for opening the Type 1644-A are given on the handle support of the instrument. Once open, the instrument can be tilted to any convenient angle, as shown in Figure 1-1. The angle should be chosen to give the most comfortable access to the knobs and the best view of the meter and dials.

The instrument may be locked fully open by the same slide pins that are used to lock the instrument closed. Thus, the instrument can be carried in the open position with the cover firmly in place.

The cover forms a convenient storage place for the instruction manual and for any test data that should be kept with the instrument.

2.1.2 RACK MOUNTING.

The Type 1644-A can be mounted in a relay rack by means of a Type 0480-9756 Adaptor Set. The procedure is as follows (see Figure 2-1):

- a. Open the instrument to its horizontal position (fully open).
- b. Remove the No. 10-32 screws with resilient washers that hold the instrument in the cabinet. These screws are on the sides of the instrument near the panel edge.
- c. Lift the instrument out of the cabinet.
- d. From the inside of the cabinet, remove the two pivot screws.
- e. Lift the cabinet off the handle and cover assembly.
- f. In place of the pivot screws, insert the two 3/4-inch screws (A) supplied in the hardware set with the adaptor panel. Place a nut (B) and lockwasher (C) on each screw and secure.
- g. Replace the instrument in the cabinet. Put a 3/16-inch metal spacer (D) on each of the 5/8-inch screws (E) supplied with the hardware set and secure these through the cabinet into the instrument in place of the screws removed in step b.
- h. Place the adaptor panel (F) over the instrument and let it rest on the spacers.
- i. Put a large flat washer (G) over the projecting screws on each side of the instrument.
- j. Put the slot in the bracket (H) over the projecting screws so that the holes in the ell of the bracket line up with the holes in the adaptor panel.
- k. Secure each bracket to the panel with 1/2-inch screws (J).
- l. Put another flat washer (K) and nut (L) on the projecting side screw and tighten. This secures the bracket to the cabinet.
- m. The instrument can now be mounted in a standard 19-inch relay rack. For mounting instruments with 3/16-inch panels, a washer is provided to place between the adaptor panel and the rack at each panel screw, so that the panel will be flush with the panels of heavier units.

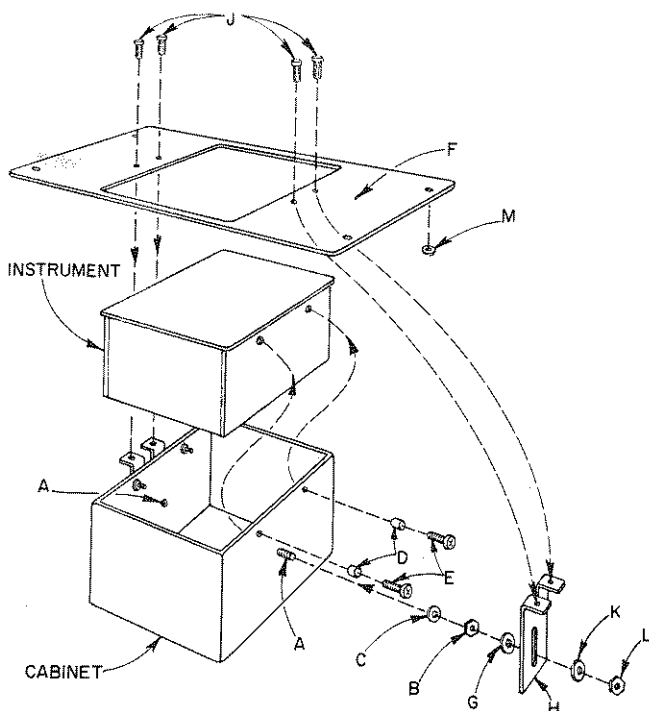

Figure 2-1. Rack mounting of the Type 1644-A.



2.1.3 CONNECTION TO POWER SUPPLY.

Connect the Type 1644-A to a source of power as indicated by the legend at the input socket at the rear of the instrument, using the power cord provided. While instruments are normally supplied for 115-volt operation, the power transformer can be reconnected for 230-volt service (see schematic diagram, Figure 5-7). When changing connections, be sure to replace line fuses with those of current rating for the new input voltage (refer to Parts List). Appropriate measures should be taken so that the legend indicates the new input voltage. On instruments changed from 250 to 115 volts, order a 115-volt nameplate (5540-0500). For instrument changes to 230 volts, order a 230-volt nameplate (5540-1164).

2.1.4 GROUNDING THE INSTRUMENT.

If the power cord does not have a ground wire (third wire), it is wise to connect the chassis ground terminal (J4) to a good ground. This is particularly important for very high resistance measurements where lack of a ground can cause difficulty. It is also advisable to ground the panels of nearby instruments to avoid electrostatic coupling to the detector.

2.1.5 CONNECTION OF GROUNDING LINK.

The grounding link, captive to the uninsulated (chassis) binding post, may be connected either to the GUARD terminal or to the - UNKNOWN terminal as shown in Figure 2-2. The ground-to-GUARD connection is preferable if the unknown is a small, separate component, or if it is mounted in an enclosure that should be guarded. (Refer to paragraph 3.4). However, if one terminal of the unknown must be grounded or is a large exposed surface, this terminal should be connected to the - UNKNOWN binding post and the grounding link connected between the - UNKNOWN post and the chassis ground post.

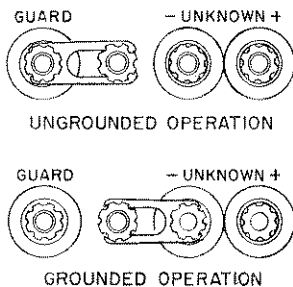

Figure 2-2. Grounding link connected to the GUARD terminal (top) and the - UNKNOWN terminal (bottom).

2.2 BASIC MEASUREMENT PROCEDURE.

Many types of measurements under various conditions can be made with this instrument. The following is the basic measurement procedure. References are given to paragraphs that discuss each step more fully or consider alternate procedures or special measurements.

WARNING

This instrument provides a high test voltage. The current is limited to a value that is safe for most persons, but it can be dangerous to those with poor hearts and is painful to all. Particular care should be used in the measurement of capacitor leakage, because **LETHAL ENERGY** may be stored in the unknown capacitor. **ALWAYS SET THE FUNCTION SWITCH TO DISCHARGE BEFORE CONNECTING OR DISCONNECTING THE UNKNOWN COMPONENT.**

Proceed as follows:

- Turn the function switch from OFF to DISCHARGE. Allow a minute or two for warmup.
- Select the desired test voltage with the VOLTAGE ON UNKNOWN switch. (Refer to paragraph 3.9 for external adjustment of the voltage supply and to paragraph 3.10 for use of an external supply.) The minimum resistance that can be measured at each test voltage is given in Table 2-1. Avoid changing the test voltage when the function switch is in the MEASURE position as this will severely overload the detector amplifier which will then require several minutes to recover.
- Connect the component to the UNKNOWN terminals. Note polarity. (For grounding-link connection, refer to paragraph 2.1.5; for remote measurements, refer to paragraph 3.5.)
- Set the RESISTANCE MULTIPLIER switch to the desired range (if it is known).
- Set the SENSITIVITY control fully clockwise for measurements either on the highest ranges or at low voltages. Set it halfway (arrow up) for other measurements. (Refer to paragraph 2.4.)
- Set the function switch to CHARGE-ZERO and adjust the COARSE ZERO and then the FINE ZERO controls for a meter zero (null).

TABLE 2-1
MINIMUM MEASUREMENT RANGES

Test Voltage	Minimum R_x
10 v	1 k Ω
20 v	3 k Ω
50 v	7 k Ω
100 v	20 k Ω
200 v	50 k Ω
500 v	150 k Ω
1000 v	500 k Ω

- g. Set the function switch to MEASURE and adjust the main R dial (and the RESISTANCE MULTIPLIER switch, if necessary) to give a null (meter zero). A deflection to the right indicates that the dial setting should be increased. For maximum accuracy on the highest ranges, rezero the meter (step f) when the RESISTANCE MULTIPLIER switch is reset.
- h. The value of the unknown resistance is the dial reading at null indication multiplied by the quantity indicated on the RESISTANCE MULTIPLIER dial. (For accuracy of measurement, refer to paragraph 2.3.)
- i. Return the function switch to DISCHARGE and then remove the component measured.

2.3 ACCURACY.

The bridge accuracy is $\pm 1\%$ between readings of 0.9 and 10 on the main R dial. Above a reading of 10, the accuracy tolerance increases proportionally so that it is $\pm 2\%$ at 20 and $\pm 10\%$ at 100. An indication of 1000 can be distinguished from 500 or ∞ . There are three exceptions to this:

- a. the three highest ranges will not necessarily be 1% accurate if they have not been recently calibrated or if the ambient temperature has changed appreciably (refer to paragraph 5.4.1);
- b. reduced sensitivity reduces the accuracy on the two highest ranges if less than 100 volts is applied to the unknown;
- c. on the 1-T Ω multiplier range, the accuracy is 2%.

For greatest accuracy, particularly at high resistance values, be sure that the component to be measured is not shunted by insulating materials with resistance low enough to introduce error. (See also paragraphs 3.11 and 3.12.)

2.4 SENSITIVITY.

The high sensitivity of the internal dc null detector (approximately 300 μ volts/division near zero) permits accurate measurements with low applied voltages, for measurement on the high ranges, and for measurements of small differences with the $\Delta R\%$ dial. For other measurements less sensitivity keeps the pointer on scale over a greater adjustment range and does not show the amplifier drift and the discontinuous meter jumps due to finite resolution of the main R dial. Balances to a precision well beyond the bridge accuracy offer no advantage, and take more time.

For maximum sensitivity, the measurement should be made on the highest range possible. The expression for the bridge output voltage is:

$$E_O = \frac{E_{IN} (\delta\%) M}{(\text{Dial Reading}) (10^4)}$$

where δ is the unbalance in percent
 M is unity except on the 100-G Ω and 1-T Ω ranges where it is 0.1 and 0.05, respectively.

Thus, a low dial reading increases sensitivity. With careful zeroing, voltages as low as 50 μ volts can be detected. Therefore, with 10 volts applied and a dial indication of 1, resolution is 0.05% on all but the two highest ranges.

Note that the meter scale is nonlinear. This allows a wide dynamic range without adjustment of the SENSITIVITY control and still gives high sensitivity near null (zero). Full meter deflection is not possible when the SENSITIVITY control is fully counterclockwise. This low sensitivity is useful for limit measurements on the linear portion of the scale (refer to paragraph 3.13).



SECTION 3

APPLICATIONS

3.1 RESISTOR MEASUREMENT.

The EIA standard test voltage for fixed composition resistors, film resistors, and wire-wound resistors is 100 volts for values above 100 k Ω , 10 volts between 1 k Ω and 9.9 k Ω , and 30 volts between 10 k Ω and 99 k Ω . (To obtain a 30-volt test voltage with the internal supply of the Type 1644-A, connect a 20-k Ω resistor between the EXTERNAL ADJ terminals and set the VOLTAGE ON UNKNOWN switch to 50, as described in paragraph 3.9.)

For many types of resistors, the value measured at some other voltage may be considerably different from that at the standard test voltage, due to a large voltage coefficient (refer to paragraph 3.7). In many cases, measurements at the voltage at which the resistor will be used are helpful.

Resistors as low as 1 k Ω may be measured easily to 1% on the Type 1644-A Megohm Bridge. More accurate substitution measurements are possible using the $\Delta R\%$ dial if an external standard is available (refer to paragraph 3.6).

If the resistors to be measured are small, separate units, they should be measured ungrounded with the grounding link connected between the GUARD and ground terminals. Resistors may be measured rapidly in a production-line setup using the procedure described in paragraph 3.13.

3.2 INSULATION TESTING.

3.2.1 COMPONENT, MACHINERY, AND SWITCH-GEAR INSULATION.

Insulation testing on a wide variety of apparatus is possible with the Megohm Bridge, but different types of devices require different precautions. When one terminal is the case of the apparatus, or is a large, exposed surface, this terminal should be grounded, for both accuracy and safety, by connection to the - UNKNOWN terminal with the link connected between

this terminal and the chassis ground terminal (refer to paragraph 2.1.5). When the device to be measured includes polarized rectifiers or capacitors, the sign of the applied voltage must be correct. Note that the +UNKNOWN terminal may be grounded with an external lead if necessary (disconnect the link from both adjacent terminals), but errors may occur when this connection is used to measure resistances above approximately 100 M Ω .

The connection of leads to large equipment also requires some care, and the problems of a large capacitive time constant and dielectric absorption may also be present (refer to paragraphs 3.3.3 and 3.2.3, respectively).

3.2.2 TEST SAMPLES.

This bridge is well suited for resistance measurements on samples of insulating material as described by ASTM Standard D257. This standard describes in detail the techniques of both surface- and volume-resistivity measurements. Diagrams of several electrode configurations, applicable formulas, and suggested precautions are given.

The most commonly used electrode arrangement for solid materials is that shown in Figure 3-1. This configuration may be used for either surface- or volume-resistivity measurements, but for surface

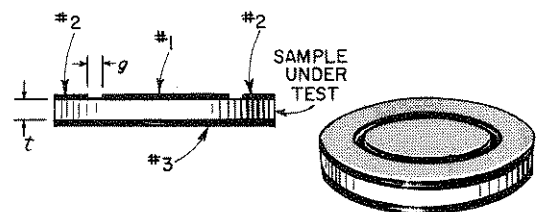

Figure 3-1. Electrode arrangement for insulation testing of solid materials.

measurements the gap, *g*, should be approximately twice the sample thickness, *t*. The connection of the electrodes to the bridge depend on the quantity to be measured as shown in Table 3-1. The ASTM Standard also describes other sample holders for both liquid and solid materials.

Standard voltages for this test are 100, 250, 500, 1000, 2500, 5000, 10,000, and 15,000 volts, of which the most common are 100 and 500 volts. The Type 1644-A Megohm Bridge will supply 100, 500, and 1000 volts directly, and 250 volts when an external resistor is used (235 kilohms when the VOLTAGE ON UNKNOWN switch set to 500; refer to paragraph 3.9).

3.2.3 DIELECTRIC ABSORPTION.

The apparent resistance of an insulator is the ratio of voltage applied to the current flowing through it. Unfortunately, the current is time-dependent and the true insulation resistance is the limiting, steady-state value.

The time-dependent currents are the simple charging current that depends on the capacitance of the sample and on the resistance of the voltage source, and the current due to dielectric absorption. The simple charging current is negligible after the function switch has been in the CHARGE-ZERO position for a very short time (except when large capacitors are tested; refer to paragraph 3.3.2). However, the absorption current may be appreciable for minutes, hours, or in rare cases, even days. This dielectric absorption is the result of dipole and interfacial polarization and ion mobility and is particularly large for laminated materials.

A measure of the dielectric absorption is the polarization index, which is defined as the ratio of the resistance measured after 10 minutes to that measured after one minute of electrification. Often, a single measurement after one minute is called the insulation resistance. Although this value may be far from the true resistance for some insulators, it is useful for comparison of measurements on materials with relatively low absorption.

3.2.4 MEASUREMENT PROCEDURE.

The procedure for measurement of insulation resistance is the same as the basic measurement procedure described in paragraph 2.2 except for charging and dielectric-absorption considerations.

The function switch should be left in the CHARGE position long enough to charge the sample. The time required for simple charging is usually well under one second except for capacitors or extremely large samples (refer to paragraph 3.3.2).

When dielectric absorption is present, the main R dial must be continually adjusted to maintain a balance. To measure resistance at any given moment, simply stop adjusting the dial at the desired time. Thus, it is not necessary to make a reading on a moving dial (see paragraph 3.3.4).

3.3 LEAKAGE RESISTANCE OF CAPACITORS.

3.3.1 GENERAL.

WARNING

The energy stored in a capacitor may be LETHAL. The function switch should be set to discharge before you connect or disconnect the capacitor to be measured. DO NOT TOUCH THE CAPACITOR TERMINALS WHILE THE "VOLTAGE APPLIED" LIGHT IS ON.

The procedure for measurements of the leakage resistance on capacitors is basically the same as that for resistors except that the several effects described in the following paragraphs become more important as the capacitance and leakage resistance become greater.

3.3.2 CHARGING TIME.

The function switch should be left in the CHARGE position long enough to ensure that the capacitor is completely charged. If it is not fully charged, the charging current will reduce the measured value of leakage resistance, and the charging time constant in the MEASURE position can become quite large (refer to paragraph 3.3.3).

The charging time is limited mainly by the maximum current of about 8 ma that can be drawn from the power supply. Charging time is, therefore:

$$t = \frac{CV}{I} = \frac{CV}{8 \text{ ma}}$$

$$t = \frac{(C \text{ in } \mu\text{f})(V \text{ in volts})}{8} \times 10^{-3} \text{ sec}$$

This time is usually less than 1 second except for large electrolytic capacitance units. The current is somewhat greater than 8 ma at 50 volts or less.

TABLE 3-1

Electrode	For Volume Resistivity		For Surface Resistivity	
	Function	Connect to	Function	Connect to
#1	Guarded Electrode	+ UNKNOWN	Guarded Electrode	+ UNKNOWN
#2	Guard Electrode	GUARD	Unguarded Electrode	- UNKNOWN
#3	Unguarded Electrode	- UNKNOWN	Guard Electrode	GUARD



3.3.3 TIME-CONSTANT EFFECTS.

The time constant of the bridge-capacitor system for the MEASURE function is the product of the capacitance measured and the effective bridge output resistance, R_O , given in Table 3-2. If this product is greater than about 0.1 second, the bridge will appear to be sluggish and the user may adjust the bridge beyond balance before the null-detector deflection reverses sign. Adjustment will be easier, although the total balance time will not be less, if you wait for a period of several time constants between balances.

When the function switch is set to CHARGE, the capacitor being tested is charged to a voltage that is dependent upon the position of the R dial. This voltage may differ from the final capacitor voltage by as much as 1% of the applied voltage. The final charging or discharging must be done with the function switch set to MEASURE so the time required is independent of further adjustment of the R dial.

In extreme cases, this time constant may be so long that it is impractical to wait. An alternate procedure described below makes use of the fact that the bridge is initially at balance when the function switch is rotated from CHARGE-ZERO to MEASURE, and then drifts slowly off null. The direction of the null-detector drift indicates the direction that the main R dial should be rotated to obtain the final balance.

The alternate balance procedure for measurement of capacitors with long time constants is given below:

- Set the function switch to CHARGE and allow time for full charging (refer to paragraph 3.3.2).
- Rotate the function switch to MEASURE and note the direction of the drift from zero (discount the small, fast deflection caused switching phenomena).
- Make a large adjustment in the main R dial in the direction indicated by the null detector (i.e., a right-hand meter deflection indicates that the dial reading should be increased).
- Return the function switch to CHARGE and repeat the above steps until a balance is reached.

Note that the time constant is reduced if the measurement is made on a lower range (i.e. with a dial reading above 10) so that a lower-valued standard is used. This, of course, gives reduced accuracy, but high accuracy is rarely required for this type of measurement. Also, use reduced detector sensitivity, at least to get a rough balance.

3.3.4 DIELECTRIC ABSORPTION.

Dielectric absorption is present to some degree in all capacitors, but is particularly pronounced in some impregnated paper types and is lowest in unimpregnated polystyrene, polyethylene, and Teflon® units. The effect of dielectric absorption is discussed in paragraph 3.2.3. For measurements on most types of capacitors, electrification for two minutes is common practice.

TABLE 3-2
BRIDGE OUTPUT RESISTANCE

Range	R_S		R_O
	Value	Type	
1 k Ω	10 Ω	Wire-wound	5 k Ω †
10 k Ω	100 Ω	Wire-wound	5 k Ω †
100 k Ω	1 k Ω	Wire-wound	5 k Ω †
1 M Ω	10 k Ω	Wire-wound	15 k Ω †
10 M Ω	100 k Ω	Wire-wound	100 k Ω
100 M Ω	1 M Ω	Metal-film	1 M Ω
1 G Ω	10 M Ω	Metal-film	10 M Ω
10 G Ω	100 M Ω	Carbon-film**	100 M Ω
100 G Ω	1000 M Ω *	Carbon-film**	100 M Ω
1 T Ω	10,000 M Ω *	Carbon-film**	500 M Ω

* T network, effective value given, refer to paragraph 3.6.3.

** Adjustable, refer to paragraph 5.4.1.

† Depends on setting of R dial.

When both appreciable dielectric absorption and a long time constant are present, measurements become quite difficult because it is hard to tell which effect causes the meter drift. In such cases, it is often useful to make limit measurements. Set the main R dial and the RESISTANCE MULTIPLIER switch to the acceptance limit and wait to see if the meter deflects to the left, which indicates that the resistance is below the limit. A time limit should be included in the specifications for such a limit measurement.

3.3.5 ERRATIC DEFLECTIONS CAUSED BY LINE TRANSIENTS.

When leakage resistance of capacitors is measured on the higher resistance ranges, the test-voltage supply must be extremely well regulated to avoid erratic meter deflections due to power-line transients. The capacitor being measured couples the high voltage supply to the detector so that rapid variations of less than 1 millivolt on the high voltage supply are easily seen. The regulation of the internal supply of the Type 1644-A is very good, but in extreme cases, when the power-line voltage is very noisy, an external battery should be used as the test-voltage supply (refer to paragraph 3.10).

3.3.6 SMALL VOLTAGE CHANGES DURING CAPACITANCE MEASUREMENTS.

In the measurement of high-capacitance, very-low-leakage capacitors (particularly polystyrene units), a small drift in the bridge voltage supply will cause an error in leakage measurements. This is particularly noticeable when the bridge indication is greater than infinity. This condition occurs when the voltage rate-of-change multiplied by the time constant ($C_{\text{unknown}} \times R_O$; see Table 3-2 for values of R_O) is in the order of a few millivolts. It is, therefore, most noticeable for measurements at high voltage and on the high RESISTANCE MULTIPLIER ranges.

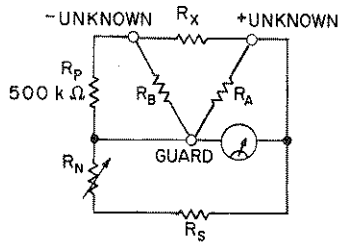

Figure 3-2. Three-terminal resistance measurement.

One source of this difficulty is the drift in the internal supply during warm-up. A warm-up period of one hour is recommended. In extreme cases, an external supply of high stability must be used (refer to paragraph 3.10). Another cause of this difficulty is ambient temperature change which changes both the internal supply voltage and the temperature of the capacitor being measured. If the capacitor has an appreciable temperature coefficient, a capacitor voltage change will result.

3.4 GUARDED (DIRECT) THREE-TERMINAL MEASUREMENTS.

In many cases it is necessary to measure the resistance between two points in the presence of resistance from one or both of these points to a third point (usually ground). This third point can often be guarded to avoid error due to shunting the unknown with the extraneous resistances.

This is shown diagrammatically as a three-terminal resistor in Figure 3-2. Here, R_X is the quantity to be measured (the direct resistance) despite the presence of R_A and R_B . If the junction of R_A and R_B is tied to guard, R_A is across the detector and causes no error, but reduces the sensitivity by the factor $\frac{R_A}{R_O + R_A}$ (see Table 3-2 for values of R_O). The other extraneous resistance, R_B , is across the 500-kΩ resistor, R_P , where it causes an error of more than 1% if R_B is below 50 MΩ. The error due to R_B

is approximately $-\frac{R_P}{R_B} \times 100\%$.

The guard may be used whether the GUARD or the - UNKNOWN terminal is grounded. Note however, that if the - UNKNOWN terminal is grounded, the GUARD terminal will be at high potential. Often the terminal to be guarded is a large chassis or case and it is safer to ground the GUARD terminal.

3.5 REMOTE MEASUREMENTS.

Measurements can be made on components that are some distance from the instrument if care is used to prevent leakage between the connecting leads and to avoid shock. A convenient way to do this is to use a shielded cable as shown in Figure 3-3.

The +UNKNOWN terminal should be connected to the center conductor and the shield tied to the GUARD terminal. The lead to the - UNKNOWN terminal need not be shielded, but if it is, its shield should also be tied to GUARD.

The - UNKNOWN lead should be insulated unless this terminal is grounded. All shields tied to GUARD should be insulated if the GUARD terminal is not grounded.

3.6 SUBSTITUTION MEASUREMENTS.

3.6.1 GENERAL.

Substitution (or comparison) measurements can be made with accuracy up to 0.1% by means of the $\Delta R\%$ dial. Substitution measurements require an external standard that is known to an accuracy substantially better than the desired measurement accuracy. Resistors of high accuracy are not available in the high megohm range but the three-terminal standard described below can be used. If only the differences between resistors are to be determined, and not absolute values, the value of the standard need not be accurately known.

3.6.2 PROCEDURE.

The procedure for a substitution measurement is simply to measure the unknown and then the standard and determine the difference between them. The value for R_X is then:

$$R_X = R_S + R_{xm} - R_{sm}$$

where R_X and R_S are the true values of the unknown and the standard

R_{xm} and R_{sm} are the measured values of the unknown and the standard.

The difference between R_{xm} and R_{sm} can be most accurately determined if this difference is small enough to be within the range of the $\Delta R\%$ dial. The first balance should be made with the main R dial and then the $\Delta R\%$ dial. The second balance should be made using only the $\Delta R\%$ dial (leave the R dial as set). The value of the unknown is then:

$$R_X = R_S \left(1 + \frac{\Delta R\%}{100} \right)$$

Here, $\Delta R\%$ is the $\Delta R\%$ dial reading for the unknown minus that for the standard.

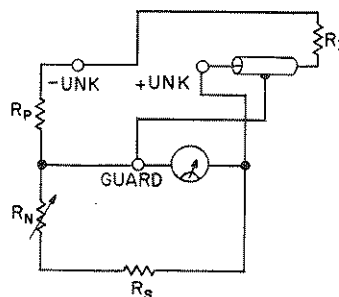

Figure 3-3. Connection for remote measurements.



An alternate scheme may be used if a T network with an adjustable resistor (refer to paragraph 3.6.3) is used as a standard. In this case, the T is used to make the second balance and is adjusted for a null without moving either dial of the bridge. The value of the unknown is calculated from:

$$R_x = R_1 + R_3 + \frac{(R_1)(R_3)}{R_2} + (0.5 \text{ M}\Omega) \frac{R_3}{R_2}$$

3.6.3 THREE-TERMINAL RESISTANCE STANDARDS.

The T or Y connection of resistors shown in Figure 3-4a is electrically identical to the Δ configuration of Figure 3-4b. This is the familiar Y- Δ transformation. If R2 is small and R1 and R3 are large, the resistance R_Y can be very large. R_Y can be used as a standard and will be very stable and accurate if wire-wound resistors are used for the resistors of the T.

Such a T network should be connected to the bridge as shown in Figure 3-2. Unfortunately, the resistances R_A and R_B shunt the bridge resistor R_P , which causes an error (refer to paragraph 3.4), and shunt the detector, which decreases sensitivity. The loss of sensitivity limits the attainable accuracy at low test voltages (refer to paragraph 3.6.4).

The error caused by the shunt on R_P can be compensated for in the calculation of the resistors of the T. For any desired value of R_Y , the value of R2 should be:

$$R_2 = \left(\frac{500 \text{ k}\Omega + R_1}{R_Y - R_1 - R_3} \right) R_3$$

The lowest value R_Y can have is $R_1 + R_3$.

For the most precise measurements, R1 and R3 should be the largest wire-wound units available, and R2 should be a multi-dial decade box. If R1 and R3 are 1-M Ω units, such as General Radio Type 500-X (accuracy of $\pm 0.05\%$), then the equation for R2 becomes:

$$R_2 = \frac{1.5}{R_Y - 2} \text{ M}\Omega$$

where R_Y is in megohms.

If $R_1 = R_3 = 10 \text{ M}\Omega$, then:

$$R_2 = \frac{105}{R_Y - 20} \text{ M}\Omega$$

Table 3-3 lists the values of R2 for decade values of R1 and R3 from 10 M Ω to 1 T Ω .

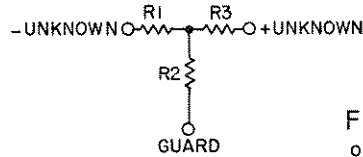

Figure 3-4a. Y configuration of a three-terminal standard.

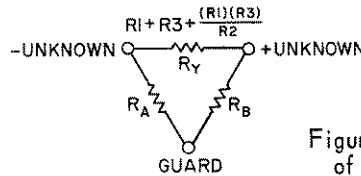

Figure 3-4b. Delta configuration of a three-terminal standard.

3.6.4 ACCURACY AND SENSITIVITY.

The bridge accuracy for substitution measurements using the $\Delta R\%$ dial is $\pm 0.1\%$ as long as the sensitivity is adequate (refer to paragraph 2.4). However, if the two balances are well within 1 percent of each other, the bridge accuracy can be as good as $\pm 0.02\%$. Measurements on the main R dial can be made to $\pm 1/4\%$ if the difference is small and the scale is carefully interpolated.

The accuracy of the standard must also be considered in the over-all accuracy determination. To determine the accuracy for the worst case, the tolerance of the standard must be added to the bridge tolerance. When a T network is used, the worst possible tolerance of the T is the sum of the tolerances of the separate resistors if

$$\frac{(R_1)(R_3)}{R_2} \gg R_1 + R_3$$

When a T standard is used to measure very high values, the sensitivity is generally the limiting factor. The approximate output voltage is:

$$E_O = \frac{(E_{IN}) (\delta\%) (M)}{(\text{Dial Reading}) (10^4)} \times \frac{R_1}{R_O + R_1}$$

where $\delta\%$ is the unbalance in percent
 M is unity except on the 100-G Ω and 1-T Ω ranges where it is 0.1 and 0.05, respectively
 R_O is given in Table 3-2.

Example:

A 10-G Ω component is measured on the 10-G Ω range.

A T network with 1-M Ω resistors is used.

$E_{IN} = 1000$ volts.

$\delta\% = 0.1\%$.

TABLE 3-3

RESISTANCE VALUES FOR T NETWORKS

R_Y , Equivalent Resistance	10 M Ω	100 M Ω	1 G Ω	10 G Ω	100 G Ω	1 T Ω
R2, when $R_1 = R_3 = 1 \text{ M}\Omega$	187.5 k Ω	15.306 k Ω	1.5022 k Ω	150.02 Ω	15.000 Ω^*	1.5000 Ω^*
R2, when $R_1 = R_3 = 10 \text{ M}\Omega$		1.3125 M Ω	107.14 k Ω	10.521 k Ω	1.0502 k Ω	105.0 Ω^*

* Poor sensitivity

$R_O = 100 \text{ M}\Omega$ (see Table 3-2).

$$E_O = \frac{(1000)(0.1)}{(1)(10^4)} \times \frac{1 \text{ M}\Omega}{101 \text{ M}\Omega} = 100 \text{ }\mu\text{volts.}$$

This would give meter deflections of about 1 mm.

If the arms of the T network were increased to 10 M Ω , the sensitivity would be increased by a factor of 10.

3.7 MEASUREMENT OF VOLTAGE COEFFICIENT.

3.7.1 GENERAL.

The Type 1644-A Megohm Bridge is well suited for the measurement of voltage coefficient because of the high resolution of its $\Delta R\%$ dial and the wide range of applied voltage.

The voltage coefficient of a resistor is generally defined as:

$$VC = \frac{R_1 - R_2}{R_2 (V_1 - V_2)} \times 100\%$$

where $V_1 > V_2$

R_1 is the resistance at V_1

R_2 is the resistance at V_2

VC is in % per volt.

Any two voltages may be used, but, because the voltage coefficient is not necessarily a constant (i.e., the resistance is not always a linear function of voltage), the voltages used should be specified.

A common practice is to use two voltages differing by a factor of ten to one, in which case the formula reduces to:

$$VC = \frac{\Delta R}{R} \times \frac{1}{0.9 V} \times 100\%$$

where ΔR is the resistance difference

R is the resistance at the lower voltage

V is the higher voltage.

The EIA Standard RS172 (Fixed Composition Resistors) specifies the use of the rated voltage for V in the above formula.

If the applied voltage is high enough to cause appreciable power dissipation, the measurement should be made quickly to determine the true voltage coefficient and to avoid temperature effects. The EIA specification suggests that the time for measurement (at the higher voltage) be less than 5 seconds.

Most resistors have a negative voltage coefficient (a lower resistance value at higher voltage), except for semiconductor back resistance which has a positive voltage coefficient as long as the voltage is well below the break-down value.

3.7.2 PROCEDURE.

The procedure for voltage-coefficient measurement is as follows:

- Measure the resistance of the unknown at the lower voltage. For best accuracy use the $\Delta R\%$ dial as the final balance adjustment, and note the $\Delta R\%$ dial indication.

- Change the position of the VOLTAGE ON UNKNOWN switch to the higher voltage and re-zero the bridge with the function switch set to CHARGE-ZERO, if necessary.
- Balance the bridge with the $\Delta R\%$ dial only (do not change the setting of the main R dial).
- The voltage coefficient is:

- 1) Initial balance made only with R dial:

$$VC = \frac{\Delta R\% \text{ Dial Reading}}{\text{Voltage Change}}$$

- 2) Initial balance made using $\Delta R\%$ dial:

$$VC = \frac{\text{Change in } \Delta R\% \text{ Dial Reading}}{\text{Voltage Change}}$$

3.8 MEASUREMENT OF TEMPERATURE COEFFICIENT.

3.8.1 GENERAL.

The $\Delta R\%$ dial allows the precise measurement of temperature coefficient, which is defined as:

$$TC\% / ^\circ\text{C} = \frac{\Delta R}{R} \times \frac{100\%}{\Delta t}$$

where ΔR is the resistance change between the test temperature and the reference temperature

R is the resistance at the reference temperature

Δt is the temperature change in $^\circ\text{C}$ from the reference temperature.

The EIA Standards RS196 (Fixed Film Resistors) and RS172 (Fixed Compensation Resistors) specify that measurements be made at -15°C . The EIA Standard RS229 (Wire-Wound Resistors) specifies measurements at -55°C , $+105^\circ\text{C}$, and $+145^\circ\text{C}$, and a reference temperature of $+25^\circ\text{C}$.

Shielded leads should be used to connect the sample in the temperature chamber to the bridge to avoid pickup and leakage (refer to paragraph 3.5).

3.8.2 PROCEDURE.

The procedure for the measurement of temperature coefficient is as follows:

- With the resistor in an environment held at 25°C , measure the resistance. For best accuracy use the $\Delta R\%$ dial as a final balance adjustment. (Standard voltages should be used, refer to paragraph 3.1.) Note the $\Delta R\%$ dial reading.
- Change the temperature of the resistor environment to the test temperature and, after stabilization, measure the resistance again, using only the $\Delta R\%$ dial. (Leave the main R dial set as is.)
- The temperature coefficient is:

$$TC = \frac{\text{Change in } \Delta R\% \text{ Dial Reading}}{\text{Temperature Difference in } ^\circ\text{C}}$$



3.9 EXTERNAL ADJUSTMENT OF THE INTERNAL TEST VOLTAGE.

Any test voltage between 10 volts and 1000 volts may be obtained by connection of the proper resistor between the EXTERNAL ADJ terminals.

WARNING

Voltage is present on the EXTERNAL ADJ terminals unless the VOLTAGE ON UNKNOWN switch is set to EXT or the instrument is turned off.

To adjust the internal test voltage proceed as follows:

- Set the VOLTAGE ON UNKNOWN switch to EXT and connect a resistor of value R between the EXTERNAL ADJ terminals:

$$R = \frac{500 (V_S - 10) (V_D - 10)}{V_S - V_D} \text{ ohms}$$

where V_S is the VOLTAGE ON UNKNOWN switch setting
 V_D is the desired voltage.

It is generally preferable to set V_S to the closest value above the desired voltage, V_D . Table 3-4 gives the values of resistance to obtain many common voltages. The external resistor should be rated for $(V_D - 10)$ volts.

- Set the VOLTAGE ON UNKNOWN switch to V_S and proceed with the measurement.

If a resistor of the required value is not available, a rheostat larger than this value may be used. With the VOLTAGE ON UNKNOWN switch set to EXT, attach the rheostat between the EXTERNAL ADJ terminals, then set the VOLTAGE ON UNKNOWN switch to V_S . Set the function switch to CHARGE-ZERO and adjust to the desired voltage using a voltmeter connected between the UNKNOWN terminals. Note that the - UNKNOWN terminal will be negative by an amount equal to V_D if the GUARD terminal is grounded, or the + UNKNOWN terminal will be positive by an amount equal to V_D if the - UNKNOWN terminal is grounded.

3.10 EXTERNAL TEST-VOLTAGE SUPPLY.

An external supply for the test voltage is useful for voltages below 10 volts, for continuous voltage adjustment, or for extreme stability for measurements on capacitors (refer to paragraph 3.3.5). For best stability, a battery is recommended. The maximum voltage that may be applied to the bridge is 1000 volts.

TABLE 3-4
RESISTANCE VALUES FOR EXTERNAL VOLTAGE ADJUSTMENT

V_D	V_S	R
12 v	20 v	1.25 kΩ
15 v	20 v	5 kΩ
25 v	50 v	12 kΩ
30 v	50 v	20 kΩ
40 v	50 v	60 kΩ
60 v	100 v	56.25 kΩ
70 v	100 v	90 kΩ
80 v	100 v	157.5 kΩ
90 v	100 v	360 kΩ
125 v	200 v	145.7 kΩ
150 v	200 v	266 kΩ
175 v	200 v	627 kΩ
250 v	500 v	235.2 kΩ
300 v	500 v	355.3 kΩ
350 v	500 v	555.3 kΩ
400 v	500 v	955.5 kΩ
475 v	500 v	4.557 MΩ
600 v	1000 v	730.1 kΩ
700 v	1000 v	1.139 MΩ
750 v	1000 v	1.465 MΩ
800 v	1000 v	1.955 MΩ
900 v	1000 v	4.406 MΩ

Set the VOLTAGE ON UNKNOWN switch to EXT, and connect the external supply to the EXTERNAL GEN terminals. To keep the same polarity as the internal supply, the negative terminal should be connected to the right-hand GEN terminal (that is, the middle of the three EXTERNAL terminals). The external supply should be current-limited to protect it from short circuits. It is also advisable to limit the current to a safe value to avoid shock.

WARNING

With the external supply connected as described above and the GUARD terminal of the bridge grounded, the negative side of this supply is at a negative potential when the function switch is set to CHARGE-ZERO or MEASURE, and the positive terminal is at high potential when the function switch is set to discharge. With the - UNKNOWN terminal grounded, the negative supply of the external supply is also grounded, and the positive side will be at a positive voltage for all positions of the function switch.

With the external generator connected as described above, the function switch will perform its operations. Note that the external supply is disconnected but not shorted in the DISCHARGE position. The circuit diagram for each position of the function switch is shown in Figure 3-5.

3.11 MEASUREMENTS ON VERY HIGH-VALUED RESISTORS.

3.11.1 GENERAL.

Extra precautions and careful technique are required for precise measurements on very high-valued resistors for several reasons.

The ratio-arm resistors used for the three highest ranges are carbon-film types and are not as stable as those used on the lower ranges. For accurate measurements on the highest ranges, the ratio arms may be adjusted by the procedure given in paragraph 5.4.1.

On the two highest ranges the sensitivity is reduced by a factor of 1/10 and 1/20, respectively, because T networks are used as standards (refer to paragraph 4.1). Measurements made at test voltages below 100 volts are difficult.

Other difficulties in measuring high valued resistors are discussed in the following paragraphs.

3.11.2 ELECTROSTATIC COUPLING.

On the three highest ranges the + UNKNOWN terminal is at a very high impedance and, as a result, a very small capacitive coupling to this terminal can cause a large voltage on the detector input. Two separate phenomena are present:

- a. Variable capacitance to a point at a fixed voltage will induce a transient voltage on the detector. To observe this, set the main R dial to ∞ , the function switch to MEASURE, and move your hands above the +UNKNOWN terminal.
- b. Fixed capacitance to a variable voltage will also induce a voltage on the + UNKNOWN terminal, but it should have no dc component and will not cause a detector deflection unless it overdrives the detector, or is low enough in frequency (refer to paragraph 3.12.4).

3.11.3 SWITCH TRANSIENTS.

The movement of the function switch and the RESISTANCE MULTIPLIER switch will also cause transient detector voltages because of the changing capacitance of these switches (refer to paragraph 3.11.2) and more subtle contact phenomena. These fluctuations should be ignored.

3.11.4 SHUNT LEAKAGE BETWEEN LEADS.

At high resistance levels one must be sure that the component being measured forms the only path between the + UNKNOWN and - UNKNOWN terminals. Leads should not touch each other, even if they are insulated with high-quality material. Shielding is the best way to avoid leakage between leads (refer to paragraph 3.5). If the - UNKNOWN terminal is grounded, leakage between the + UNKNOWN terminal and ground shunts the unknown. Therefore, ungrounded measurements should be used wherever possible.

3.11.5 MOISTURE ON THE UNKNOWN.

The device measured should be clean and dry. High-valued resistors should be handled only by their leads to avoid surface dirt. Surface moisture will reduce the resistance value considerably. For example, breathing on a glass-enclosed resistor of only 1 G Ω will cause a momentary change of several percent.

3.12 MEASUREMENTS UNDER ADVERSE CONDITIONS.

3.12.1 HIGH HUMIDITY.

The Type 1644 - A Megohm Bridge has been designed to operate under conditions of rather high humidity but, nevertheless, errors will occur on the highest ranges when the relative humidity is over approximately 90%. However, the most serious errors generally result from the effects of humidity in the external unknown connections. A few simple precautions should be taken:

- a. Clean the binding posts with a dry, clean cloth. Make sure that there is no dust or moisture between the UNKNOWN binding posts or between them and the panel.
- b. Use ungrounded measurements if possible. That is, connect the GUARD terminal to the adjacent chassis ground terminal with the connecting link.
- c. Be particularly careful to keep the leads that connect the bridge to the unknown separate from each other.

To determine possible errors due to humidity, balance the bridge with no connections to the UNKNOWN terminals; it should balance at ∞ .

The most important precaution necessary under humid conditions is to avoid leakage on the surface of

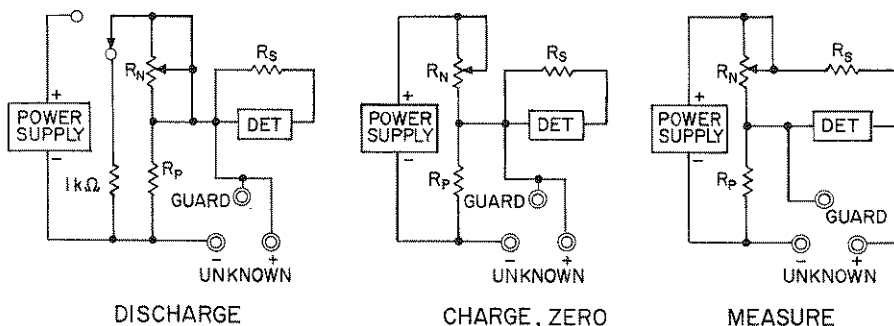

Figure 3-5. Circuit diagrams for the Type 1644-A Megohm Bridge for each position of function switch.



the component being measured. In almost all cases, the error due to this leakage will be many times larger than errors due to improper operation of the bridge itself. Many high resistances simply cannot be measured in a humid environment. Often, a simple solution is to place the component in a box with a light bulb or other source of heat. Shielded leads should be used to connect to the bridge (refer to paragraph 3.5).

3.12.2 TEMPERATURE EXTREMES.

The Type 1644-A Megohm Bridge should operate satisfactorily over a range from -30 to $+50^{\circ}\text{C}$. The instrument may be exposed to temperatures from -40 to $+85^{\circ}\text{C}$ without damage.

For accurate measurements on the three highest resistance ranges, the ratio arms used should be adjusted at the temperature of use to take into account their temperature coefficients (refer to paragraph 5.4.1).

The temperature coefficient of the component being measured is often high enough so that it cannot be neglected and the bridge should not be expected to give the room-temperature value of the unknown when the component is not at room temperature.

3.12.3 VIBRATION AND SHOCK.

The vacuum-tube electrometer used in the detector is somewhat subject to mechanical shock and will give a transient deflection under these conditions. The detector mounting reduces this effect. However, if the bridge is set on a vibrating platform it should be mechanically isolated from the platform by a thick layer of some spongy material, such as foam rubber.

Vibration or other movement of the leads connecting the unknown can also cause transient detector deflection (refer to paragraph 3.11.2).

3.12.4 HIGH AC FIELDS.

Unshielded components and any unshielded leads that connect the component to the + UNKNOWN terminal may have a voltage induced on them because of capacitance coupling to objects which carry an ac voltage. The bridge is more sensitive to this capacitance pickup on the higher resistance ranges. The detector input circuit contains a low-pass filter that gives 50-db rejection at 60 cps, but large pickup can cause enough signal to overdrive the amplifier, shift its effective dc voltage, and yield an erroneous indication.

Such pickup can be easily detected by a change in meter deflection when the function switch is rotated counterclockwise from DISCHARGE to the adjacent, detented, unlabeled position. In this switch position, the bridge is connected just as in the MEASURE position except that the test voltage is not applied. (When the switch is in the DISCHARGE and CHARGE-ZERO positions, the + UNKNOWN terminal is not connected to the detector, see Figure 3-5.)

If ac pickup is a problem, the best solution is to shield the + UNKNOWN connecting lead and corresponding terminal of the unknown component, to ground the bridge and all nearby equipment, and to keep power cables as far from the bridge, the component measured, and the leads, as possible. If the effect of pickup cannot be completely removed, improved accuracy

will result if this unlabeled switch position is used when the meter is zeroed.

3.12.5 SAMPLES WITH SOURCES OF EMF.

Some samples may contain either known or unsuspected sources of voltage due to chemical action, thermal emf, contact potential, or the presence of electrets. If such voltages are additive to the applied voltage, they will cause a bridge error.

If these voltages appear between the + UNKNOWN terminal and the GUARD terminal in a guarded system, they are particularly troublesome because they are applied directly across the detector. If the polarity is the same, this may result in a balance beyond ∞ . Such a difficulty is apt to occur during guarded measurements on heterogeneous mechanical assemblies under high humidity.

3.13 PRODUCTION LIMIT TESTING.

Resistors, or the leakage resistance of all types of components, can be rapidly checked without repeated adjustment of the main R dial by using the meter as a limit indicator. Two types of operation are possible:

- a. Simple, single-limit testing. To check rapidly that components are above or below some resistance level, set the RESISTANCE MULTIPLIER switch and the main R dial to the limit value, and connect the components to be measured, one at a time, to the UNKNOWN terminals. A deflection to the right indicates the resistance is higher than the limit and a deflection to the left indicates that it is lower. The function switch should be set to DISCHARGE between measurements to avoid shock, to avoid repeated meter banging, to check the zero between measurements, and to start each measurement at zero.
- b. Lo-go-hi measurements. The meter deflection may be used to separate the components tested into three groups: those below the tolerance range, those in the tolerance range, and those above the tolerance range. The main R dial and the SENSITIVITY control (or VOLTAGE ON UNKNOWN switch) can be adjusted so that a meter deflection to the left of a certain value represents the lower limit, and a meter deflection to the right of a certain value represents the upper limit. A deflection of 5 divisions is recommended, since beyond that the meter is quite nonlinear. Once the controls are set, the components may be tested without adjustment of the dials. It is, however, preferable to zero the bridge between measurements.

The Type 1650-P1 Test Jig (see Figure 3-6) is a convenient fixture for testing small axial-lead components. The fixture is at ground potential and uses grounded, shielded leads; therefore, the GUARD terminal of the bridge should be grounded. The unpainted panel screw beneath the UNKNOWN terminals should be used to hold the shield on the leads of the Test Jig to the panel and to form the guard connection.

In permanent test setups using the Type 1650-P1 or another fixture, a warning light should be located near the jig to indicate when voltage is applied to the terminals.

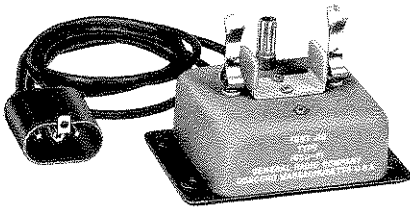

Figure 3-6. The Type 1650-P1 Test Jig for production test setups.

3.14 BATTERY OPERATION.

The bridge may be battery-operated if a power line is not available. Two batteries are required: one battery to supply the test voltage should be connected to the EXTERNAL GEN terminals and may supply any voltage up to 1000 volts (refer to paragraph 3.10). The second battery to power the detector should supply 45 volts at about 20 ma. It should be connected with its positive terminal to AT13 and its negative terminal to AT12 on the detector board (see Figure 5-3). The cable connections to these terminals should be removed.



SECTION 4

THEORY OF OPERATION

4.1 BRIDGE.

The bridge circuit in the Type 1644-A Megohm Bridge is a conventional Wheatstone bridge (see Figure 4-1). The equation of balance for this bridge is:

$$R_X = \frac{R_P R_S}{R_N}$$

When the balance condition is met, there will be no voltage across the detector.

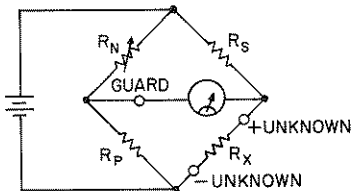

Figure 4-1. Elementary schematic diagram of the bridge circuit.

In the Type 1644-A Megohm Bridge, the resistor R_N is the main R adjustment which is a precision wire-wound rheostat of 5.5 k Ω . The value of R_N is inversely proportional to R_X , so that, when R_N is set to zero, the corresponding dial reading is infinity. The winding mandrel of this rheostat is exponentially shaped in the region between dial readings of 0.9 and 10 so that the scale in this region is logarithmic. This results in a constant angular displacement for a given percent unbalance. From 10 to ∞ , the rheostat is lin-

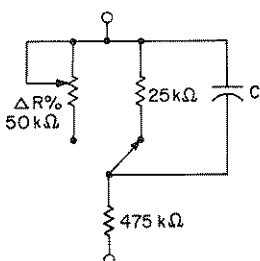

Figure 4-2. Bridge circuit with $\Delta R\%$ control added.

ear which yields a simple inverse scale. The rheostat has a mechanical compensating mechanism which can be set to give a tracking accuracy far better than 1%.

The resistor R_P represents a fixed 500-k Ω resistor unless the $\Delta R\%$ switch is depressed to put the $\Delta R\%$ adjustment in the circuit (see Figure 4-2). When R_2 is in the circuit, R_P may be adjusted $\pm 5\%$ which gives a $\pm 5\%$ change in the balance adjustment. This small adjustment is used for precise substitution measurements of small changes of resistance. The $\Delta R\%$ switch, S104, has a spring return so that this adjustment will not be left in the circuit accidentally and thereby cause an error in the main R dial indication. The capacitor C is added to avoid a switching transient when R_2 is added to, or removed from, the circuit.

The ratio-arm resistors, R_S , are selected by the RESISTANCE MULTIPLIER switch. The lowest range uses a wire-wound ratio-arm resistor, the next six ranges use metal film-type resistors, and the three highest ranges use high-valued carbon-film types. Because the carbon-film resistors are less stable, the three highest ranges are adjustable and may be set precisely using the calibration procedure described in paragraph 5.4.1.

Both ends of the ratio-arm resistors are switched and the unused resistors are guarded to avoid leakage resistance between terminals of switch wafers (see Figure 5-7). The two highest ratio-arm resistors actually consist of two T networks, as shown in Figure 4-3. This is done so that more stable, lower-valued resistors may be used, trimming adjustments can be made with rheostats of reasonable values, and the bridge output impedance is small enough to minimize time-constant problems (refer to paragraph 3.3.3). These T networks are equivalent to Δ networks as explained in paragraph 3.6.3. The loading on the adjustment R_N is always greater than 10 M Ω , which causes negligible error. The use of the T's does reduce the bridge sensitivity, however. The ratio between

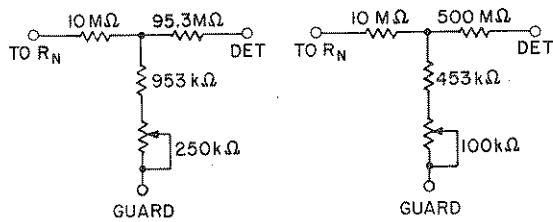

Figure 4-3. The ratio-arm T networks for the two highest ranges.

the voltage on R_N and R_S is always 1/100th or less of the voltage on R_P and R_X . This large "bridge ratio" results in less sensitivity than would be available if it were smaller, but has the following advantages:

- The standard is 1/100th or less of the unknown resistor and, therefore, on many ranges it is a much more stable resistor than any unknown resistor would be. For example, resistors up to 100 M Ω are measured using wire-wound standards, and resistors to 10 G Ω are measured using 1/4% metal-film types.
- The voltage applied to the unknown varies by only 1% over the entire range of R_N . (This would be 10% on a bridge with a 10-to-1 ratio.)
- Because R_S is smaller, several effects resulting from high bridge output impedance, such as time-constant problems in capacitance measurement, and capacitance pickup and zero shift resulting from grid current on the highest ranges, are reduced.
- Because a much lower voltage is applied to R_S than to R_X , changes in R_S due to its voltage coefficient are negligible. This is particularly important when voltage coefficients are measured with the $\Delta R\%$ dial.

The use of the T networks on the highest ranges can be considered as a further increase of this bridge ratio.

The bridge is mounted on a subpanel which is tied to the GUARD point which is the low side of the detector. Both UNKNOWN terminals are mounted on a plate connected to this GUARD point to avoid any leakage resistance across the UNKNOWN terminals. Leakage resistance from any point on the bridge to GUARD causes negligible effect if it is over 200 M Ω or so. This value is easily obtained with good insulating materials.

In use, either the GUARD point or the UNKNOWN terminal can be tied to the panel ground. In the latter case, there may be a high voltage between the subpanel and the outside panel.

When the switch on the side of the instrument is set in the CAL position, the ratio-arm resistor normally used for the range selected is connected instead across the UNKNOWN terminals, and the ratio-arm resistor normally used two ranges lower is used as

the standard. Thus, each resistor is checked against one that is 1/100th of its value. (Refer to paragraph 5.4.1.)

4.2 DETECTOR.

The detector circuit consists of a multistage, dc-feedback amplifier, with an electrometer-tube input stage, that drives the panel meter. The over-all sensitivity of the circuit is about 100 $\mu\text{v}/\text{mm}$.

The electrometer tube provides the high input resistance necessary to prevent loading the bridge and, thus, decreasing sensitivity. It also has a very low grid current to avoid appreciable zero shifts when the bridge output resistance is changed as the range is changed. Preceding the input tube is a two-stage RC filter to reduce the effects of pickup. This grid circuit also includes a neon tube, which, with a series resistor, limits the grid current drawn to less than 1 microampere, whatever voltage is applied.

The second stage in the amplifier is also a vacuum tube because of the high plate resistance of the first stage. Following the second stage are a common-collector and then a common-emitter transistor stage. The output voltage is fed back through a divider to the second grid of the input stage. This grid is also used for the ZERO adjustments.

The amplifier output drives the zero-center panel meter. This meter has shaped pole pieces to give high sensitivity near a bridge null and decreased sensitivity up scale. This nonlinearity facilitates balance by eliminating the need for readjustment of the SENSITIVITY control during balance.

The supply voltage for this detector is very well regulated. The heater current in the vacuum tubes is taken from the plate supply and is, thus, also well regulated. The critical voltages on the first stage are further regulated by a low-temperature-coefficient Zener diode.

4.3 TEST-VOLTAGE SUPPLY.

The internal test voltage is regulated by a series regulator using a high-voltage vacuum tube as the series element. The reference for this regulator is a Zener diode and the amplifier consists of cascaded transistor stages. The control circuit is connected to the output and has a maximum of only 10 volts across it while the remaining output voltage is dropped across a resistor.

The current through this dropping resistor is adjusted to be precisely 2 ma by the internal ADJ 100 V adjustment and the voltage across the amplifier is adjusted to 10 volts with the ADJ 10 V adjustment. The output voltage is the sum of 10 volts plus 2 ma times the dropping resistor. This resistor is used to change the test voltage. The EXTERNAL ADJ terminals shunt this resistor so that its value may be modified to get intermediate values (refer to paragraph 3.9).

This supply is current-limited to about 8 ma for ranges over 50 volts and to about 15 ma at 50 volts and lower. Shorting the supply will not damage it.

TABLE 5-1 - RATIO-ARM RESISTORS

RESISTANCE MULTIPLIER Setting	100 kΩ	1 MΩ	10 MΩ	100 MΩ	1 GΩ
Resistor Used as Standard	R105 (10 Ω)	R106 (100 Ω)	R107 (1 KΩ)	R108 (10 kΩ)	R109 (100 kΩ)
Resistor Used as Unknown	R107 (1 kΩ)	R108 (10 kΩ)	R109 (100 kΩ)	R110 (1 MΩ)	R111 (10 MΩ)

- g. Set the function switch to MEASURE and balance the bridge. It should balance near a reading of 1. Make note if the balance point differs from 1 by more than 1/2% (1/4 dial division).
- h. Set the RESISTANCE MULTIPLIER switch to each range up to 1 GΩ, in turn. For each range, rezero the meter and then balance the bridge. Note any ranges that do not balance within 1/2%.
- i. If any measurements are off, the resistor in error can be identified by the chart of Table 5-1. Note that the 10-Ω, 100-Ω, 1-MΩ, and 10-MΩ resistors appear only once in this table. An error in any one of these would cause only one inaccurate balance. Values in between would cause two inaccurate balances that would be off in opposite directions. If all the values are off in the same direction, R_p is in error.
- j. Set the RESISTANCE MULTIPLIER switch to 10 GΩ and set the main R dial to 1. Balance the bridge by means of the adjustment on the side of the instrument in the left-hand hole (see Figure 5-1).
- k. Repeat step i. for the 100-GΩ and 1-TΩ ranges, making the balance with the middle and right-hand adjustments, respectively (see Figure 5-1).

To readjust the main rheostat, use a dc bridge with an accuracy of ±0.1%. Remove the Type 1644-A from its cabinet and swing the detector board out on its cable. (Unsolder leads to terminals 1 and 2 on the board and remove the screws at the corners of the board.) Disconnect one of the internal leads that is connected to the rheostat and connect the dc bridge across the rheostat.

The main rheostat has a mechanism that permits accurate adjustment at eight points with adjustment screws. Table 5-2 lists the dial readings and resistance values for these eight points and for intermediate points that should also be within ±1/2% or 2-1/2 ohms, whichever is larger. These adjustments are numbered clockwise starting at the slot in the cam plate. After any adjustments are made, rotate the dial over its entire range and recheck all points.

TABLE 5-2
MAIN DIAL CALIBRATION

Dial Reading	Resistance	Screw Adjustment
0.9	5556 Ω	-
1.0	5000 Ω	1
1.3	3846 Ω	-
1.5	3333 Ω	2
1.9	2632 Ω	-
2.5	2000 Ω	3
3.2	1563 Ω	-
4.0	1250 Ω	4
5.0	1000 Ω	-
6.3	793.7 Ω	5
8.0	625.0 Ω	-
10.0	500.0 Ω	6
13.0	384.6 Ω	-
20.0	250.0 Ω	7
32.0	156.3 Ω	-
100.0	50.0 Ω	8
200.0	25.0 Ω	-
∞	0.0 Ω	-

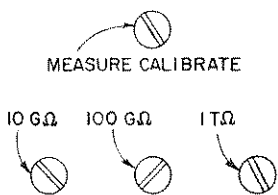

Figure 5-1. Calibration controls for the three highest ratio arms. The measure-calibrate switch is shown in the measure position. Rotate the switch clockwise to calibrate.

5.4.2 MAIN DIAL.

To check the accuracy of the main dial, connect a decade resistance box to the UNKNOWN terminals and measure at various points over the dial range. A Type 1432-Q Decade Resistor (1 MΩ in 10-Ω steps) that permits readings up to 1000 (1 k) on the 1-kΩ range is recommended.

The main dial should give readings to approximately 1/2% over the range from 0.9 to 10 and to an equivalent scale distance (approximately 1/2 mm) over the rest of the range. If the readings differ by substantially more than this, the main rheostat should be readjusted.

5.5 TEST-VOLTAGE ADJUSTMENTS.

To check the test voltages connect an accurate, high-impedance voltmeter between the UNKNOWN terminals and set the function switch to CHARGE-ZERO. Connect the link between the - UNKNOWN terminal and the chassis ground terminal to keep the negative terminal of the voltmeter near ground potential. The test voltages should be within ±3%. They will vary 1% over the range of the R dial so that, if they are readjusted, the R dial should be set to 2 to obtain center values.

TABLE 5-3

DETECTOR VOLTAGES

Connect the captive link between the ground and GUARD terminals.
Adjust R231 for 35.0 volts dc between TP1 and ground.

Tube or Transistor (Type)	Pin	DC Volts to Ground	Tube or Transistor (Type)	Pin	DC Volts to Ground
V201 (CK5886)	1	10.8	Q202 (2N910)	C	32.5
	2	6.65		B	26.0
	3	3.20		E	25.5
	4	2.0	Q203 (2N910)	C	27.5
	7	0.0		B	18.0
V202 (CK6418)	1	26.0	E	17.5	
	2	25.7	Q204 (2N1304)	C	45.7
	3	13.1		B	27.5
	4	10.8		E	27.4
	5	11.8	Q205 (2N1131)	C	35.0
Q201 (2N1377)	C	17.9		B	45.7
	B	25.5		E	46.5
	E	25.7			

V201
V202

The test voltages may be readjusted by means of the internal adjustments R509 and R513 (see Figure 5-2). R509 should be set to give 10 volts and R513 to give 100 volts (with the corresponding settings of the VOLTAGE ON UNKNOWN switch). If these voltages are correct, but others are in error, the fault is with one of the dropping resistors, R517 through R527. If the voltages are way off, check the circuit voltages against those of Tables 5-3 and 5-4 to help determine the faulty component.

The voltages in Tables 5-3 and 5-4 are measured with a vacuum-tube voltmeter under the following conditions:

- Function switch set to CHARGE-ZERO
- RESISTANCE MULTIPLIER switch set to 1 k
- Measure-calibrate switch set to measure VOLTAGE ON UNKNOWN switch set to 10 v
- Power-line voltage of 115 volts.

5.6 DETECTOR ADJUSTMENTS.

5.6.1 METER-ZERO ADJUSTMENT.

If the COARSE ZERO adjustment on the panel is near the end of its range, or off range, it can be reset to mid range, and the detector zeroed using R211 which is located on the detector board (see Figure 5-2). THIS ADJUSTMENT SHOULD BE MADE WITH THE CONNECTING LINK BETWEEN THE GUARD TERMINAL AND THE GROUND TERMINAL TO AVOID SHOCK.

5.6.2 DETECTOR SUPPLY VOLTAGE.

The detector supply voltage from TP1 to AT12 should be 35 volts. This is set using R231 (see Figure 5-2).

TABLE 5-4

POWER-SUPPLY VOLTAGES

Connect the captive link between the ground and - UNKNOWN terminals.
Adjust R509 for 10.0 volts dc across the UNKNOWN terminals.

Tube or Transistor (Type)	Pin	DC Volts to Ground
V501 (7239)	1	6.7
	2	10.0
	4	10.0
	6	60.0
	7	10.0
	9	10.0
	Cap	200.0
Between 4 and 5		5.6 ac
Q501 (2N910)	C	6.6
	B	2.7
	E	2.1
Q502 (2N1131)	C	2.7
	B	4.7
	E	5.5

5.7 TROUBLE-SHOOTING.

5.7.1 NOISY OR ERRATIC BALANCE.

If the bridge has not been used in some time, surface contamination in the wire-wound R or $\Delta R\%$ adjustment may cause erratic behavior of the null indicator. To remedy this situation, rotate these controls over their ranges several times.

5.7.2 LOW BRIDGE SENSITIVITY.

To check the bridge sensitivity proceed as follows:

- a. Set the VOLTAGE ON UNKNOWN switch to 10 v, the measure-calibrate switch (on the side panel) to calibrate (fully clockwise), the SENSITIVITY control fully clockwise, and the RESISTANCE MULTIPLIER to 100 k Ω .
- b. Balance the bridge. It should balance near 1.

A 1% change in the $\Delta R\%$ dial is 1 millivolt and should give a 2-1/2-division deflection. If the gain is

insufficient, check the voltage in the detector board and compare them with those of Table 5-3. This should help locate a faulty component.

5.7.3 INABILITY TO BALANCE OR LARGE ERROR.

If the bridge does not balance, several things should be considered before the bridge is returned for service:

- a. Make sure that the measure-calibrate switch (side panel) is in the measure position (counterclockwise), see Figure 5-1. The bridge will always balance near 1 when this switch is in the calibrate position.
- b. Make sure that the component is correctly connected.
- c. Check all panel switch settings.
- d. Try measuring a known resistor.
- e. Refer to paragraph 3.11 for measurement of high-valued resistors and to paragraph 3.12 for measurements under adverse conditions.

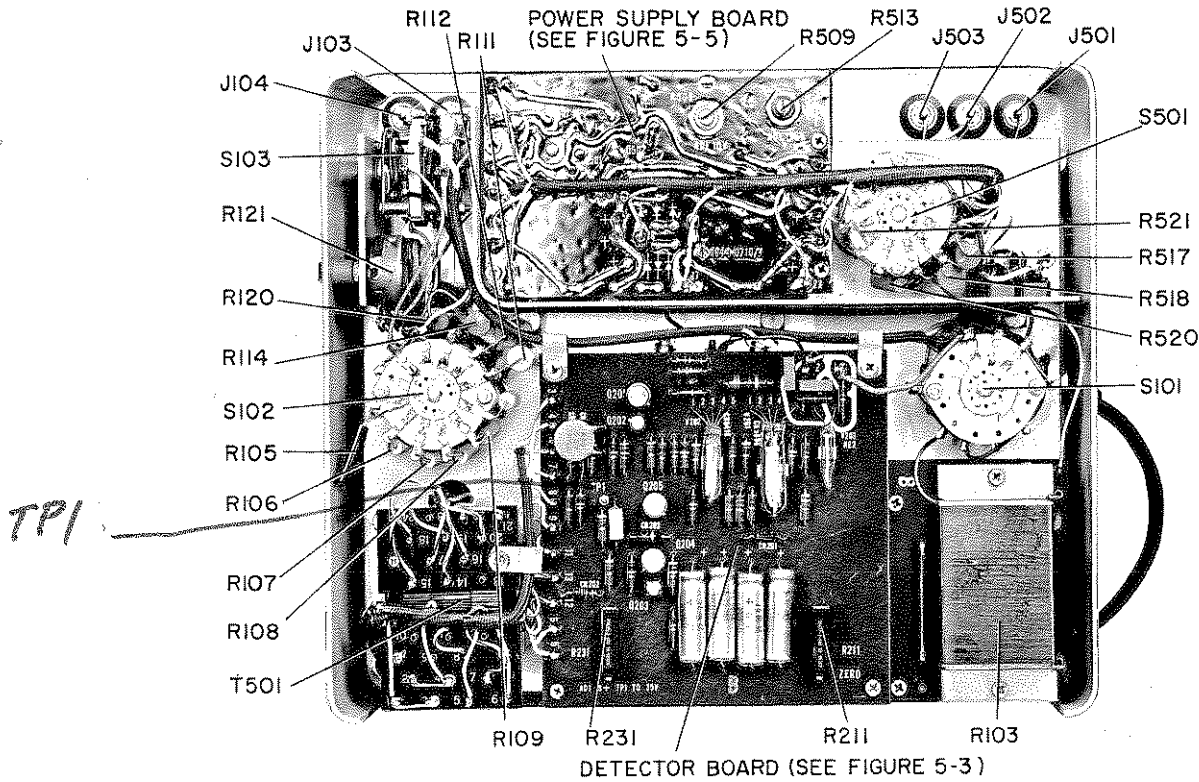

Figure 5-2. Interior view of the Type 1644-A.

FEDERAL MANUFACTURERS CODE

From Federal Supply Code for Manufacturers Cataloging Handbooks H4-1
(Name to Code) and H4-2 (Code to Name) as supplemented through June, 1967.

Code	Manufacturers Name and Address	Code	Manufacturers Name and Address	Code	Manufacturers Name and Address
00192	Jones Mfg. Co., Chicago, Illinois	53021	Sangamo Electric Co., Springfield, Ill. 62705	80583	Hammarlund Co. Inc., New York, N. Y.
00194	Walsco Electronics Corp., Los Angeles, Calif.	54294	Shallcross Mfg. Co., Selma, N. C.	80740	Beckman Instruments, Inc., Fullerton, Calif.
00656	Aerovox Corp., New Bedford, Mass.	54715	Shure Brothers, Inc., Evanston, Ill.	81073	Grayhill Inc., LaGrange, Ill. 60525
01009	Alden Products Co., Brockton, Mass.	56289	Sprague Electric Co., N. Adams, Mass.	81143	Isolantite Mfg. Corp., Stirling, N. J. 07980
01121	Allen-Bradley, Co., Milwaukee, Wisc.	59730	Thomas and Betts Co., Elizabeth, N. J. 07207	81349	Military Specifications
01295	Texas Instruments, Inc., Dallas, Texas	59875	TRW Inc. (Accessories Div), Cleveland, Ohio	81350	Joint Army-Navy Specifications
02114	Ferroxcube Corp. of America, Saugerties, N. Y. 12477	60399	Torrington Mfg. Co., Torrington, Conn.	81751	Columbus Electronics Corp., Yonkers, N. Y.
02606	Fenwal Lab. Inc., Morton Grove, Ill.	61637	Union Carbide Corp., New York, N. Y. 10017	81831	Filton Co., Flushing, L. I., N. Y.
02660	Amphenol Electronics Corp., Broadview, Ill.	61864	United-Carr Fastener Corp., Boston, Mass.	81860	Barry Controls Div. of Barry Wright Corp., Watertown, Mass.
02768	Fastex Division of Ill. Tool Works, Des Plaines, Ill. 60016	63060	Victoreen Instrument Co., Inc., Cleveland, Ohio	82219	Sylvania Electric Products, Inc., (Electronic Tube Div.), Emporium, Penn.
03508	G. E. Semiconductor Products Dept., Syracuse, N. Y. 13201	63743	Ward Leonard Electric Co., Mt. Vernon, N. Y.	82273	Indiana Pattern and Model Works, LaPort, Ind.
03636	Grayburne, Yonkers, N. Y. 10701	65083	Westinghouse (Lamp Div), Bloomfield, N. J.	82389	Switchcraft Inc., Chicago, Ill. 60630
03888	Pyrofilm Resistor Co., Cedar Knolls, N. J.	65092	Weston Instruments, Weston-Newark, Newark, N. J.	82647	Metals and Controls Inc., Attleboro, Mass.
03911	Clairex Corp., New York, N. Y. 10001	70485	Atlantic-India Rubber Works, Inc., Chicago, Ill. 60607	82807	Milwaukee Resistor Co., Milwaukee, Wisc.
04009	Arrow, Hart and Hegeman Electric Co., Hartford, Conn. 06106	70563	Amperite Co., Union City, N. J. 07087	83058	Carr Fastener Co., Cambridge, Mass.
04713	Motorola Semi-Conductor Product, Phoenix, Ariz. 85008	70903	Belden Mfg. Co., Chicago, Ill. 60644	83186	Victory Engineering Corp (VECO), Springfield, N. J. 07081
05170	Engineered Electronics Co., Inc., Santa Ana, Calif. 92702	71126	Bronson, Homer D., Co., Beacon Falls, Conn.	83361	Bearing Specialty Co., San Francisco, Calif.
05624	Barber-Colman Co., Rockford, Ill. 61101	71294	Carnfield, H. O. Co., Clifton Forge, Va. 24422	83587	Solar Electric Corp., Warren, Penn.
05820	Wakefield Eng., Inc., Wakefield, Mass. 01880	71400	Bussman Mfg. Div. of McGraw Edison Co., St. Louis, Mo.	83740	Union Carbide Corp., New York, N. Y. 10017
07127	Eagle Signal Div. of E. W. Bliss Co., Baraboo, Wisc.	71590	Centralab, Inc., Milwaukee, Wisc. 53212	84411	TRW Capacitor Div., Ogallala, Nebr.
07261	Avnet Corp., Culver City, Calif. 90230	71666	Continental Carbon Co., Inc., New York, N. Y.	84835	Lehigh Metal Products Corp., Cambridge, Mass. 02140
07263	Fairchild Camera and Instrument Corp., Mountain View, Calif.	71707	Coto Coil Co. Inc., Providence, R. I.	84971	TA Mfg. Corp., Los Angeles, Calif.
07387	Birtcher Corp., No. Los Angeles, Calif.	71744	Chicago Miniature Lamp Works, Chicago, Ill.	86577	Precision Metal Products of Malden Inc., Stoneham, Mass. 02180
07595	American Semiconductor Corp., Arlington Heights, Ill. 60004	71785	Cinch Mfg. Co. and Howard B. Jones Div., Chicago, Ill. 60624	86684	RCA (Electrical Component and Devices) Harrison, N. J.
07828	Bodine Corp., Bridgeport, Conn. 06605	71823	Darnell Corp., Ltd., Downey, Calif. 90241	88140	Cutler-Hammer Inc., Lincoln, Ill.
07829	Bodine Electric Co., Chicago, Ill. 60618	72136	Electro Motive Mfg. Co., Willmington, Conn.	88219	Gould Nat. Batteries Inc., Trenton, N. J.
07910	Continental Device Corp., Hawthorne, Calif.	72259	Nytronics Inc., Berkeley Heights, N. J. 07922	88419	Cornell Dubilier Electric Corp., Fuquay-Varina, N. C.
07983	State Labs Inc., N. Y., N. Y. 10003	72619	Dialight Co., Brooklyn, N. Y. 11237	88627	K and G Mfg. Co., New York, N. Y.
07999	Amphenol Corp., Borg Inst. Div., Delavan, Wisc. 53115	72699	General Instrument Corp., Capacitor Div., Newark, N. J. 07104	89482	Holtzer Cabot Corp., Boston, Mass.
08730	Vemaline Prod. Co., Franklin Lakes, N. J.	72765	Drake Mfg. Co., Chicago, Ill. 60656	89665	United Transformer Co., Chicago, Ill.
09213	General Electric Semiconductor, Buffalo, N. Y.	72825	Hugh H. Eby, Inc., Philadelphia, Penn. 19144	90201	Mallory Capacitor Co., Indianapolis, Ind.
09823	Burgess Battery Co., Freeport, Ill.	72962	Elastic Stop Nut Corp., Union, N. J. 07083	90750	Westinghouse Electric Corp., Boston, Mass.
09922	Burndy Corp., Norwalk, Conn. 06852	72982	Eric Technological Products Inc., Erie, Penn.	90952	Hardware Products Co., Reading, Penn. 19602
11599	Chandler Evans Corp., W. Hartford, Conn.	73445	Amperex Electronics Co., Hicksville, N. Y.	91032	Continental Wire Corp., York, Penn. 17405
12498	Teledyn Inc., Crystalonics Div., Cambridge, Mass. 02140	73559	Carling Electric Co., W. Hartford, Conn.	91146	ITT Cannon Electric Inc., Salem, Mass.
12672	RCA Commercial Receiving Tube and Semi- conductor Div., Woodridge, N.J.	73690	Elco Resistor Co., New York, N. Y.	91293	Johanson Mfg. Co., Bonton, N. J. 07005
12697	Clarostat Mfg. Co. Inc., Dover, N. H. 03820	73899	J. F. D. Electronics Corp., Brooklyn, N. Y.	91598	Chandler Co., Wethersfield, Conn. 06109
12954	Dickson Electronics Corp., Scottsdale, Ariz.	74861	Heinemann Electric Co., Trenton, N. J.	91637	Dale Electronics Inc., Columbus, Nebr.
13327	Solitrone Devices, Tappan, N. Y. 10983	74970	Industrial Condenser Corp., Chicago, Ill.	91662	Elco Corp., Willow Grove, Penn.
14433	ITT Semiconductors, W. Palm Beach, Florida	75042	E. F. Johnson Co., Waseca, Minn. 56093	91719	General Instruments, Inc., Dallas, Texas
14655	Cornell Dubilier Electric Co., Newark N. J.	75382	IRC Inc., Philadelphia, Penn. 19108	91929	Honeywell Inc., Freeport, Ill.
14674	Corning Glass Works, Corning, N. Y.	75608	Kulka Electric Corp., Mt. Vernon, N. Y.	92519	Electra Insulation Corp., Woodside, Long Island, N. Y.
14936	General Instrument Corp., Hicksville, N. Y.	75915	Linden and Co., Providence, R. I.	92678	Edgerton, Germeshausen and Grier, Boston, Mass.
15238	ITT, Semiconductor Div. of Int. T. and T., Lawrence, Mass.	76005	Littefuse, Inc., Des Plaines, Ill. 60016	93332	Sylvania Electric Products, Inc., Woburn, Mass.
15605	Cutler-Hammer Inc., Milwaukee, Wisc. 53233	76487	Lord Mfg. Co., Erie, Penn. 16512	93916	Cramer Products Co., New York, N. Y. 10013
16037	Spruce Pine Mica Co., Spruce Pine, N. C.	76545	James Millen Mfg. Co., Malden, Mass. 02148	94144	Raytheon Co. Components Div., Quincy, Mass.
19701	Electra Mfg. Co., Independence, Kansas 67301	76684	Mueller Electric Co., Cleveland, Ohio 44114	94154	Tung Sol Electric Inc., Newark, N. J.
21335	Fafnir Bearing Co., New Briton, Conn.	76854	National Tube Co., Pittsburg, Penn.	95076	Garde Mfg. Co., Cumberland, R. I.
24446	G. E. Schenectady, N. Y. 12305	77147	Oak Mfg. Co., Crystal Lake, Ill.	95146	Alco Electronics Mfg. Co., Lawrence, Mass.
24454	G. E., Electronic Comp., Syracuse, N. Y.	77166	Pass-Seymour, Syracuse, N. Y.	95238	Continental Connector Corp., Woodside, N. Y.
24455	G. E. (Lamp Div), Nela Park, Cleveland, Ohio	77263	Pierce Roberts Rubber Co., Trenton, N. J.	95275	Vitramon, Inc., Bridgeport, Conn.
24655	General Radio Co., W. Concord, Mass 01781	77339	Positive Lockwasher Co., Newark, N. J.	95354	Methode Mfg. Co., Chicago, Ill.
26806	American Zettler Inc., Costa Mesa, Calif.	77542	Ray-O-Vac Co., Madison, Wisc.	95412	General Electric Co., Schenectady, N. Y.
28520	Hayman Mfg. Co., Kenilworth, N. J.	77630	TRW, Electronic Component Div., Camden, N. J. 08103	95794	Ansonda American Brass Co., Torrington, Conn.
28959	Hoffman Electronics Corp., El Monte, Calif.	77638	General Instruments Corp., Brooklyn, N. Y.	96095	Hi-Q Div. of Aerovox Corp., Orlean, N. Y.
30874	International Business Machines, Armonk, N.Y.	78189	Shakeproof Div. of Ill. Tool Works, Elgin, Ill. 60120	96214	Texas Instruments Inc., Dallas, Texas 75209
32001	Jensen Mfg. Co., Chicago, Ill. 60638	78277	Sigma Instruments Inc., S. Braintree, Mass.	96256	Thordarson-Meissner Div. of McGuire, Mt. Carmel, Ill.
35929	Constanta Co. of Canada Limited, Montreal 19, Quebec	78488	Stackpole Carbon Co., St. Marys, Penn.	96341	Microwave Associates Inc., Burlington, Mass.
37942	P. R. Mallory and Co. Inc., Indianapolis, Ind.	78553	Tinnerman Products, Inc., Cleveland, Ohio	96906	Military Standards
38443	Marlin-Rockwell Corp., Jamestown, N. Y.	79089	RCA, Commercial Receiving Tube and Semi- conductor Div., Harrison, N. J.	97966	CBS Electronics Div. of Columbia Broadcast- ing Systems, Danvers, Mass.
40931	Honeywell Inc., Minneapolis, Minn. 55408	79725	Wiremold Co., Hartford, Conn. 06110	98291	Sealectro Corp., Mamaroneck, N. Y. 10544
42190	Muter Co., Chicago, Ill. 60638	79963	Zierick Mfg. Co., New Rochelle, N. Y.	98821	North Hills Electronics Inc., Glen Cove, N. Y.
42498	National Co. Inc., Melrose, Mass. 02176	80030	Prestole Fastener Div. Bishop and Babcock Corp., Toledo, Ohio	99180	Transitron Electronics Corp., Melrose, Mass.
43991	Norma-Hoffman Bearings Corp., Stanford, Conn. 06904	80048	Vickers Inc. Electric Prod. Div., St. Louis, Mo.	99378	Atlee Corp., Winchester, Mass. 01890
49671	RCA, New York, N. Y.	80131	Electronic Industries Assoc., Washington, D.C.	99800	Delevan Electronics Corp., E. Aurora, N. Y.
49956	Raytheon Mfg. Co., Waltham, Mass. 02154	80183	Sprague Products Co., North Adams, Mass.		
		80211	Motorola Inc., Franklin Park, Ill. 60131		
		80258	Standard Oil Co., Lafayette, Ind.		
		80294	Bourns Inc., Riverside, Calif. 92506		
		80431	Air Filter Corp., Milwaukee, Wisc. 53218		

PARTS LIST – MECHANICAL

Fig. Ref.	Description	Part No.	Fed. Mfg. Code	Mfg. Part No.	Fed. Stock No.
1	Dial Assembly, $\Delta R\%$	1644-3100	24655	1644-3100	
2	Screw, No. 10-32, 3/8 in. Washer, Split, No. 10	7080-1000 8040-2400	24655 96906	7080-1000 MS35337-81	5305-974-0373 5310-058-2951
3	Indicator	5460-1301	24655	5460-1301	
4	Knob, POWER OFF - MEASURE	5500-1100	24655	5500-1100	5355-912-0009
5	Knob, COARSE ZERO	5530-0400	24655	5530-0400	5355-985-6850
6	Panel Screw and Washer, No. 10-32, 1/2 in.	7098-0160	24655	7098-0160	5305-993-0650
7	Socket Assembly, POWER ON	7510-1380	72765	121-7-204 (red)	
8	Knob, VOLTAGE ON UNKNOWN	5500-0400	24655	5500-0400	5355-051-6594
9	Indicator, R dial	5460-1301	24655	5500-1100	5355-912-0009
10	Socket Assembly, VOLTAGE APPLIED	7510-1380	72765	121-7-204 (red)	
11	Knob, FINE ZERO	5530-0400	24655	5530-0400	5355-985-6850
12	Dial and Knob Assembly, RESISTANCE MULTIPLIER	1644-1040	24655	1644-1040	
13	Stop, rubber bumper to check instrument rotation.	5260-0700	24655	5260-0700	5340-738-6329
14	Dial Assembly, R dial	1644-3090	24655	1644-3090	
15	Knob, SENS	5530-0400	24655	5530-0400	5355-985-6850
16	Knob, vernier drive for R dial	5520-2100	24655	5520-2100	5355-954-7040
17	Gasket, rubber gasket for cabinet edge.	5167-5429	24655	5167-5429	
18	Foot, rubber	5250-1902	24655	5250-1902	

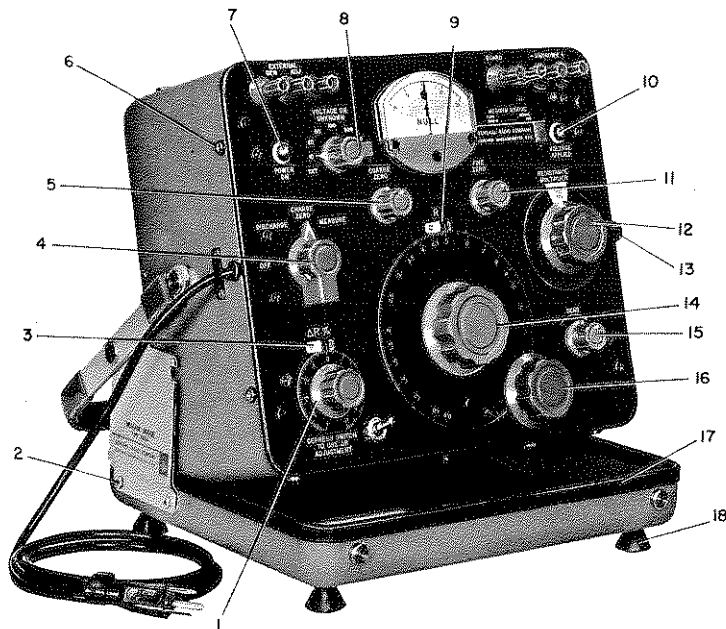

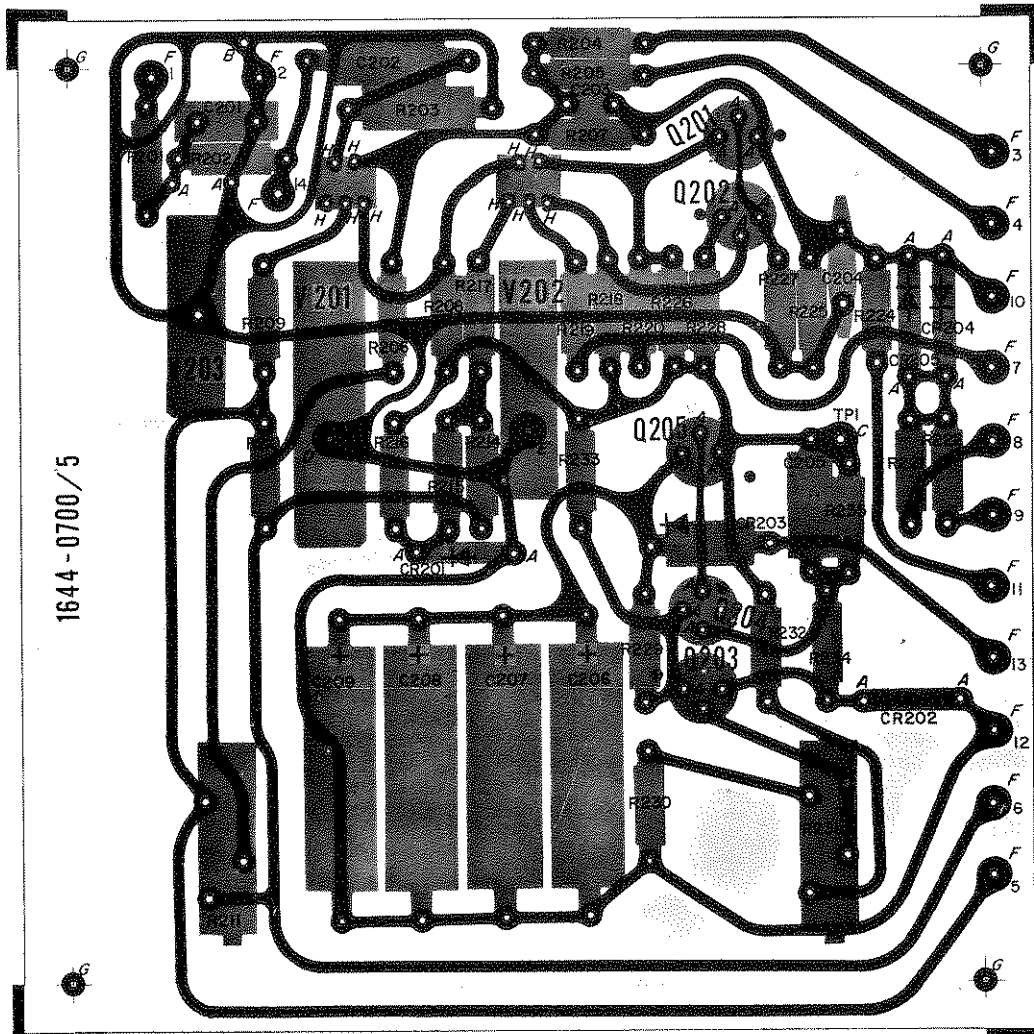

Figure 5-3. Etched-board layout for detector circuit (P/N 1644-2710).

NOTE: The number appearing on the foil side is not the part number.
The dot on the foil at the transistor socket indicates the collector lead.