

Giga-tronics

www.gigatronics.com



Series 8650A Universal Power Meters Operation Manual

Publication 31470, Rev. G, November 2002

Giga-tronics Incorporated ♦ 4650 Norris Canyon Road, San Ramon, CA 94583
925.328.4650/800.726.4442/925.328.4700 (Fax) ♦ Customer Service: 800.444.2878/925.328.4702 (Fax)



Series 8650A Universal Power Meters

All technical data and specifications in this publication are subject to change without prior notice and do not represent a change without prior notice and do not represent a commitment on the part of Giga-tronics Incorporated.

© 2002 Giga-tronics Incorporated. All rights reserved. Printed in the USA.

WARRANTY

Giga-tronics Series 8650A instruments are warranted against defective materials and workmanship for two years from date of shipment. Giga-tronics will at its option repair or replace products that are proven defective during the warranty period. This warranty DOES NOT cover damage resulting from improper use, nor workmanship other than Giga-tronics service. There is no implied warranty of fitness for a particular purpose, nor is Giga-tronics liable for any consequential damages. Specification and price change privileges are reserved by Giga-tronics.

MODEL NUMBERS

The series 8650A includes two models: The single-channel Model 8561A and the dual-channel Model 8652A. Apart from the number of sensors they support, the two models are identical. Both models are referred to in this manual by the general term 8650A, except where it is necessary to make a distinction between the models.

DECLARATION OF CONFORMITY

Giga-tronics

Giga-tronics Incorporated
4650 Norris Canyon Road
San Ramon, CA 94583
Tel: 925/328-4650
Fax: 925/328-4700

DECLARATION OF CONFORMITY

Application of Council Directive(s)

Standard(s) to which Conformity is Declared:

89/336/EEC and 73/23/EEC	EMC Directive and Low Voltage Directive
EN61010-1/1A (1993)	Electrical Safety
EN61326-1 (1997)	EMC – Emissions & Immunity

Manufacturer's Name:

Giga-tronics Incorporated

Manufacturer's Address:

4650 Norris Canyon Road
San Ramon, California 94583
U.S.A.

Type of Equipment:

Universal Power Meter

Model Series Number:

8650A

Model Number(s) in Series:

8651A
8652A

With Sensor Series 803XXA, 804XXA, 806XXA, 807XXA

I, the undersigned, hereby declare that the equipment specified above conforms to the above Directive(s) and Standard(s).

Steve Gredell
(Full Name)

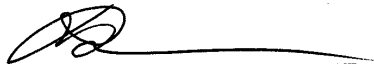
(Signature)

Acting Director of Quality Assurance
(Position)

San Ramon, California
(Place)

August 2, 2002
(Date)

Series 8650A Universal Power Meters

Contents

About this Publication	xi
Conventions	xiii
Record of Publication Changes	xv
Special Configurations	xvii

1

Introduction

1.1	General Information	1-1
1.1.1	Features	1-1
1.1.2	Environmental Standards	1-2
1.1.3	Power Requirements	1-2
1.1.4	Items Furnished	1-2
1.1.5	Items Required	1-2
1.1.6	Cooling	1-2
1.1.7	Cleaning	1-2
1.1.8	Receiving Inspection	1-3
1.1.9	Reshipment Preparation	1-3
1.2	Installation.....	1-4
1.2.1	Safety Precautions	1-4
1.2.2	Power	1-5
1.2.3	Power Sensor Precautions	1-5
1.2.4	Interface (Rear Panel)	1-6
1.2.4.1	Line Voltage Selection & Fuse.....	1-6
1.2.4.2	Inputs/Outputs	1-6
1.2.4.3	Remote Interface	1-6
1.3	Specifications	1-7
1.3.1	Power Meter	1-7
1.3.2	Accuracy	1-8
1.3.3	Measurement Rates	1-11
1.3.4	Remote Operation	1-12
1.3.5	Fast Buffered Mode Controls	1-12
1.3.6	Inputs/Outputs	1-12
1.3.7	General Specifications	1-13
1.3.8	Options	1-13
1.3.9	Power Sensors	1-13

2

Front Panel Operation

2.1	Introduction	2-1
2.2	Front Panel Description	2-1
2.2.1	Front Panel Layout Descriptions	2-2
2.3	Front Panel Applications	2-4
2.3.1	Meter Setup	2-5
2.3.1.1	Calibrator	2-5
2.3.1.2	Config	2-6
2.3.2	Display Setup	2-16
2.3.2.1	Line Configuration	2-17
2.3.3	Relative Mode (Rel)	2-19
2.3.4	Sensor Setup	2-20
2.4	Measurement Guide	2-23
2.4.1	Using the Power Sweep Calibrator	2-23
2.4.2	80701A Sensor Operation	2-23
2.4.3	Sensor Calibration & Zeroing	2-24
2.4.3.1	Calibration & Zeroing	2-24
2.4.3.2	Zeroing Only	2-25
2.4.3.3	Calibration & Zeroing (High Power Sensors with Removable Attenuators)	2-25
2.4.3.4	Low Level Performance Check	2-26
2.4.4	Measuring Source Output Power	2-27
2.4.5	Using the Peaking Meter	2-27
2.4.6	High Power Level Measurements	2-28
2.4.7	Modulated Measurement Modes	2-28
2.4.7.1	MAP Mode	2-28
2.4.7.2	PAP Mode	2-29
2.4.7.3	BAP Mode	2-29
2.4.8	Measurement Collection Modes	2-31
2.4.8.1	CW Mode	2-31
2.4.8.2	PEAK Mode (80350A Peak Power Sensor)	2-31
2.4.9	Mode Restrictions	2-33
2.4.10	When to use CW, MAP & BAP	2-33
2.4.11	Multi-Tone Tests	2-33
2.4.12	Peak Hold	2-35
2.4.13	Crest Factor	2-36
2.4.14	Burst Signal Measurements	2-38
2.4.15	Burst Start Exclude, Burst End Exclude	2-39
2.4.16	Burst Dropout	2-40
2.4.17	Optimizing Measurement Speed	2-41
2.4.18	Peak Power Measurements	2-42
2.4.19	Measuring an Attenuator (Single Channel Method)	2-42
2.4.20	Improving Accuracy	2-43
2.4.21	Performance Verification	2-44
2.4.22	Sources of Error	2-45

Remote Operation

3.1	Introduction	3-1
3.1.1	Sending Commands to the 8650A	3-1
3.1.1.1	Clear Device	3-2
3.1.1.2	Clear Interface	3-2
3.1.1.3	Local & Remote Control.....	3-2
3.1.1.4	Sensor Selection & Calibration	3-2
3.1.2	Polling	3-3
3.1.2.1	Parallel Polling	3-3
3.1.2.2	Serial Polling.....	3-3
3.1.3	Data Output Formats	3-4
3.1.4	Power-On Default Conditions	3-4
3.2	SCPI Command Interface	3-5
3.2.1	Sensor Calibration & Zeroing	3-5
3.2.2	Sensor & Channel Configuration	3-5
3.2.3	Measurement Triggering	3-6
3.2.4	Memory Functions	3-6
3.2.5	IEEE 488.2 Required Commands	3-6
3.2.6	Calculate Subsystem Commands	3-7
3.2.7	Sense Subsystem Commands	3-9
3.2.8	Trigger Subsystem Commands	3-11
3.2.9	GPIB Command Syntax	3-13
3.2.9.1	Commands in Brackets.....	3-13
3.2.9.2	Programmer Selective Parameters.....	3-13
3.2.9.3	Italics in Syntax Descriptions	3-13
3.2.9.4	Query Format.....	3-13
3.2.9.5	Linking Command Strings.....	3-13
3.2.9.6	Measurement Data Output Format	3-13
3.2.10	Sensor Calibration & Zeroing	3-18
3.2.10.1	Sensor Calibration	3-18
3.2.10.2	Sensor Zero	3-19
3.2.11	Sensor Configuration Commands	3-20
3.2.12	Sensor Gate Commands	3-23
3.2.13	Reading Power Measurements	3-26
3.2.13.1	Special Errors	3-27
3.2.14	Instrument Triggering	3-28
3.2.15	Arming the Triggering Cycle	3-31
3.2.16	Channel Configuration	3-32
3.2.17	Cal Factor Correction	3-35
3.2.17.1	Cal Factor Error Control.....	3-36
3.2.18	High Speed Measurements	3-37
3.2.18.1	Operating Mode Control	3-37
3.2.18.2	Triggering Notes	3-39
3.2.18.3	Measurement Level Notes.....	3-39
3.2.19	Peak Power Sensor Triggering	3-40
3.2.20	Averaging	3-42
3.2.21	Relative or Referenced Measurements	3-43
3.2.21.1	Error Control	3-43
3.2.22	Offsets	3-44
3.2.23	Communication Configurations	3-45
3.2.24	SRQ & Status Monitoring	3-46
3.2.24.1	Event Status Register.....	3-48
3.2.24.2	Status Byte Register	3-49
3.2.25	Min/Max Configuration & Monitoring	3-50
3.2.26	Limit Line Configuration & Monitoring	3-51
3.2.27	Analog Output	3-53
3.2.28	Saving & Recalling Configurations	3-55
3.2.29	Halting Operation	3-55
3.2.30	Language Configuration	3-56

Series 8650A Universal Power Meters

3.2.31	Preset Configuration	3-57
3.2.32	Identification Commands	3-59
3.2.33	Calibrator Controls	3-60
3.2.34	Sensor EEPROM Commands	3-60
3.2.35	Self-Test	3-61
3.2.36	Error Messages	3-61
3.3	IEEE 488.2 Interface Command Codes	3-64
3.3.1	Command Syntax	3-64
3.3.1.1	Function Codes.....	3-64
3.3.1.2	Prefixes.....	3-64
3.3.1.3	Variables.....	3-64
3.3.1.4	Suffixes.....	3-65
3.3.1.5	Separators.....	3-65
3.3.1.6	Command Format Illustrations.....	3-65
3.3.2	8650A Command Code Set	3-66
3.3.3	8540C Emulation Command Code Set	3-69
3.3.4	HP436 Emulation Command Code Set	3-72
3.3.5	HP437 Emulation Command Code Set	3-73
3.3.6	HP438 Emulation Command Code Set	3-75
3.4	Analog Output.....	3-77
3.4.1	Enabling & Disabling the Output	3-77
3.4.2	Setting Options for the Output	3-77
3.5	Averaging	3-78
3.5.1	Auto Averaging	3-78
3.5.1.1	Activating the Auto Filter Mode.....	3-78
3.5.1.2	Setting the Measurement Settling Target	3-78
3.5.1.3	Freezing the Present Averaging Number	3-79
3.5.2	Manual Averaging	3-80
3.6	Cal Factors	3-81
3.7	Calibration	3-82
3.7.1	Calibration Routine	3-82
3.7.2	Calibrator Source	3-83
3.7.3	Calibrator Test	3-83
3.7.4	Channel Designation	3-84
3.8	Crest Factor.....	3-85
3.8.1	Enabling the Crest Factor Feature	3-85
3.8.2	Reading the Crest Factor Value	3-85
3.9	Display Control	3-87
3.9.1	Display Testing	3-87
3.9.2	Displaying Messages	3-87
3.10	Duty Cycle Commands	3-88
3.10.1	Activating or Deactivating a Duty Cycle	3-88
3.10.2	Specifying a Duty Cycle	3-88
3.10.3	Reading Duty Cycle Status	3-88
3.11	Time Gating Measurement	3-89
3.11.1	Description	3-89
3.11.1.1	External Gating Mode	3-89
3.11.1.2	External Trigger Mode	3-89

3.11.2	Time Gating Mode	3-90
3.11.2.1	Gate A or B	3-90
3.11.2.2	OFF or GATE or TRIGGER or EDGE	3-90
3.11.2.3	INVERT or NONINVERT	3-90
3.11.2.4	DELAY d	3-91
3.11.2.5	DURATION g	3-91
3.11.2.6	HOLDOFF h	3-91
3.11.2.7	Error Codes	3-91
3.12	EEPROM	3-92
3.12.1	EEPROM Cal Factors	3-92
3.12.2	Frequency	3-93
3.13	Instrument Identification	3-94
3.13.1	Identification Strings	3-94
3.14	Learn Modes	3-95
3.14.1	Learn Mode #1	3-96
3.14.2	Requesting the String	3-96
3.14.2.1	Sending the String	3-96
3.14.3	Learn Mode #2	3-97
3.14.3.1	Requesting the String	3-97
3.14.3.2	Sending the String	3-97
3.15	Limits	3-98
3.15.1	Setting Limits	3-98
3.15.2	Activating Limits	3-98
3.15.3	Measuring with Limits	3-99
3.16	Measurement Collection Modes (Standard)	3-100
3.16.1	Measurement Triggering	3-100
3.16.1.1	Trigger Hold (TR0)	3-100
3.16.1.2	Trigger Immediate (TR1)	3-100
3.16.1.3	Trigger Immediate with Full Averaging (TR2)	3-100
3.16.1.4	Free Run (TR3)	3-101
3.16.2	Group Execute Trigger	3-102
3.16.2.1	Group Trigger Immediate (GT1)	3-102
3.17	Measurement Collection Modes (Fast)	3-103
3.17.1	General	3-103
3.17.1.1	Sensor Measurements Supported	3-103
3.17.1.2	Averaging	3-103
3.17.1.3	Disabled Features	3-103
3.17.1.4	Measurement Changes	3-103
3.17.1.5	Warning Regarding Interruption & Reconfiguration	3-104
3.17.1.6	Fast Mode Setup	3-104
3.17.2	Data Output Formats for Fast Modes	3-105
3.17.2.1	For the Swift Free-Run Mode	3-105
3.17.2.2	For The Swift Triggered & Fast Buffered Modes	3-105
3.17.2.3	For the Fast Modulated Mode	3-105
3.17.3	Fast Buffered Mode	3-106
3.17.3.1	Fast Buffered Mode Speed Notes	3-107
3.17.4	Swift Mode	3-108
3.17.4.1	Example Programs	3-109
3.17.5	Fast Modulated Mode	3-110

Series 8650A Universal Power Meters

3.18	Measurement Mode Commands.....	3-111
3.18.1	CW Mode	3-111
3.18.2	MAP Mode	3-111
3.18.3	PAP Mode	3-112
3.18.4	BAP Mode	3-112
3.18.5	Peak Mode	3-112
3.18.6	Measurement Mode Query	3-113
3.19	Advanced Features.....	3-114
3.19.1	Burst Start Exclude	3-114
3.19.2	Burst End Exclude	3-114
3.19.3	Burst Dropout Tolerance	3-115
3.19.4	Min/Max Power Value	3-115
3.19.4.1	Enabling the Min/Max Feature.....	3-115
3.19.4.2	Reading the Min/Max Values.....	3-116
3.19.5	Offset Commands	3-116
3.19.5.1	Enabling/Disabling an Offset	3-117
3.19.5.2	Setting an Offset Value.....	3-117
3.19.6	Measured Offset Entry	3-118
3.19.7	Peak Hold	3-119
3.19.7.1	Enabling the Peak Hold Feature.....	3-119
3.19.7.2	Reading the Peak Hold Value.....	3-119
3.19.8	Peak Power Sensor Commands	3-121
3.19.8.1	Series 80350A Sensors SENS	3-121
3.19.8.2	Reading Values	3-122
3.19.9	Preset	3-123
3.19.10	Relative Measurements	3-124
3.19.11	Resolution	3-124
3.19.12	Sensor Selection	3-125
3.19.13	Status	3-126
3.19.13.1	Status Byte Message.....	3-126
3.19.13.2	Event Status Register	3-127
3.19.13.3	Status Message	3-127
3.19.13.4	Status Message Output Format.....	3-128
3.19.14	Setup	3-132
3.19.14.1	Query a Stored Setup	3-132
3.19.14.2	Store a Setup.....	3-132
3.19.15	Store & Recall	3-133
3.19.15.1	Saving a Configuration	3-133
3.19.15.2	Retrieving a Configuration	3-133
3.19.16	Units	3-134
3.19.17	V _{PROP} F Feature	3-134
3.19.17.1	Enabling & Disabling V _{PROP} F	3-134
3.19.17.2	Configuring V _{PROP} F	3-135
3.19.18	Zeroing	3-136
3.19.19	Histograms, CDF & CCDF	3-137
3.19.19.1	Setting Histogram Mode Intervals.....	3-137
3.19.19.2	Histogram Range.....	3-137
3.19.19.3	Enabling & Disabling Histograms HIST	3-137
3.19.19.4	Histogram Query.....	3-138
3.19.20	Strip Chart	3-139
3.19.20.1	Strip Pause/Resume.....	3-139
3.19.20.2	Strip Chart Query.....	3-139
3.19.21	Statistics	3-140
3.19.21.1	Statistics Enable/Disable	3-140
3.19.21.2	Statistics Query.....	3-140
3.19.22	SCPI	3-140

4

Performance Verification

4.1	Introduction	4-1
4.2	Equipment Required	4-1
4.3	Calibrator Verification Procedure.....	4-2
4.3.1	Calibrator Output Power Reference Level	4-2
4.3.1.1	Procedure	4-2
4.3.2	Calibrator Frequency Check	4-4
4.4	Performance Verification Tests	4-5
4.4.1	Equipment Required	4-5
4.4.2	Instrument Plus Power Sensor Linearity	4-6
4.4.2.1	Test Description	4-6
4.4.2.2	Setup Parameters	4-7
4.4.2.3	Test Procedure	4-7
4.4.3	GPIB Port Check	4-8

A

Typical Applications Programs

A.1	Introduction	A-1
A.2	Continuous Data Reading	A-1
A.3	Remote Calibration of a Sensor	A-1
A.4	Speed Tests: Normal & Swift	A-2
A.5	Swift Demo 1: FREERUN	A-4
A.6	Swift Demo 2: GET	A-5
A.7	Fast Buffered Demo: POST GET	A-6
A.7.1	Fast Buffered Demo: POST TTL.....	A-7

B

Power Sensors

B.1	Introduction	B-1
B.2	Power Sensor Selection	B-1
B.2.1	Power Sensor Selection Charts	B-2
B.2.2	Modulated Sensor Specifications	B-7
B.2.2.1	80401A BAP Mode Limitations	B-8
B.2.2.1	80601A BAP Mode Limitations	B-9
B.2.2.1	80701A BAP Mode Limitations	B-10
B.2.3	Directional Bridges	B-11

C

Options

C.1	Introduction	C-1
C.2	Options	C-1
C.2.1	Option 01: Rack Mount Kit	C-1
C.2.2	Option 03: Rear Panel Sensor In & Calibrator Out Connectors (8651A)	C-1
C.2.3	Option 04: Rear Panel Sensor In & Calibrator Out Connectors (8652A)	C-2
C.2.4	Option 05: Soft Carrying Case	C-2
C.2.5	Option 07: Side-mounted Carry Handle	C-2
C.2.6	Option 08: Transit Case	C-2
C.2.7	Option 09: Dual Power Meter Rack Mount Kit	C-2
C.2.8	Option 10: Assembled Dual Power Meter Rack Mount Kit.....	C-2
C.2.9	Option 12: 1 GHz, 50 MHz Switchable Calibrator	C-2
C.2.10	Option 13: Rear Panel Sensor In Connectors (8651A)	C-2
C.2.11	Option 14: Rear Panel Sensor In Connectors (8652A)	C-2

D

Menu Structure

D.1	Introduction	D-1
-----	--------------------	-----

Index

Series 8650A Universal Power Meters (Rev. F).....	Index-1
---	---------

Illustrations

Figure 1-1:	Fuse Holder	1-5
Figure 1-2:	Series 8650A Rear Panel	1-6
Figure 2-1:	8652A Front Panel Layout	2-1
Figure 2-2:	Main Menu	2-4
Figure 2-3:	Power Meter Configuration Display	2-6
Figure 2-4:	Strip Chart Illustration	2-8
Figure 2-5:	External Gating Illustration.....	2-10
Figure 2-6:	External Triggering Illustration	2-11
Figure 2-7:	Burst Edge Configuration Illustration	2-12
Figure 2-8:	Histogram Illustration	2-13
Figure 2-9:	CDF Curve Illustration	2-14
Figure 2-10:	CCDF Curve Illustration.....	2-14
Figure 2-11:	Configuration Display Menu.....	2-16
Figure 2-12:	Data Line Configuration Menu	2-17
Figure 2-13:	Sensor Setup Menu	2-20
Figure 2-14:	Setup for Sensor Calibration.....	2-24
Figure 2-15:	Peaking Meter.....	2-27
Figure 2-16:	Burst Measurement	2-29
Figure 2-17:	Delay & Delay Offsets.....	2-32
Figure 2-18:	Peak Hold	2-35
Figure 2-19:	Crest Factor	2-36
Figure 2-20:	Burst Start Exclude & Burst End Exclude	2-39
Figure 2-21:	Burst Dropout.....	2-40
Figure 3-1:	SCPI Subsystem Model.....	3-5
Figure 3-2:	CALCulate Subsystem Commands	3-7
Figure 3-3:	Additional CALCulate Subsystem Commands (Modulation Sensors)	3-8
Figure 3-4:	SENSe Subsystem Command Tree	3-9
Figure 3-5:	TRIGger Subsystem Command Tree	3-11
Figure 3-6:	SENSe Subsystem Command Tree for Configuring Modulation Sensors.....	3-12
Figure 3-7:	SENSe Subsystem Command Tree for Configuring Modulation Sensor Gate Setting	3-12
Figure 3-8:	TRIGger Subsystem Command Tree	3-28
Figure 3-9:	SCPI Status Structure Registers	3-47
Figure 4-1:	Calibrator Output Test Setup.....	4-2
Figure 4-2:	Power Linearity Test Setup.....	4-6
Figure B-1:	80401A Modulation-Related Uncertainty	B-8
Figure B-2:	80601A Modulation-Related Uncertainty	B-9
Figure B-3:	80701A Modulation-Related Uncertainty	B-10
Figure D-1:	Series 8650A Menu Tree.....	D-1
Figure D-2:	Peak Sensor Setup A Menu Structure.....	D-2
Figure D-3:	Modulation Sensor B Setup Menu Structure	D-3
Figure D-4:	Meter Setup Menu Structure.....	D-5
Figure D-5:	Display Setup Menu Structure	D-6

Series 8650A Universal Power Meters

Tables

Table 1-1:	Series 8650A Rear Panel I/O Connectors	1-6
Table 1-2:	Measurement Rates	1-11
Table 3-1:	Implemented IEEE Standards	3-1
Table 3-2:	IEEE Required Command Codes	3-6
Table 3-3:	SCPI Command Syntax	3-14
Table 3-4:	Reset & Power on Default Commands	3-57
Table 3-5:	SCPI Standard Error Messages	3-61
Table 3-6:	Device Specific Error Messages	3-62
Table 3-7:	8650A IEEE 488.2 Command Set	3-66
Table 3-8:	8540C Emulation Command Set	3-69
Table 3-9:	HP436 Emulation Command Set	3-72
Table 3-10:	HP437 Emulation Command Set	3-73
Table 3-11:	HP438 Emulation Command Set	3-75
Table 3-12:	Measurement Setting Target Default Values	3-78
Table 3-13:	Numbering Averaging	3-80
Table 3-14:	Learn Mode #1 Output Format	3-96
Table 3-15:	Preset (Default) Conditions	3-123
Table 3-16:	Status Byte & Service Request Mark	3-126
Table 3-17:	Error Code Returned in Position AA	3-129
Table 3-18:	Error Code Returned in Position aa	3-130
Table 3-19:	Other Codes in the Status Message	3-131
Table 4-1:	Required Equipment List	4-1
Table B-1:	Power Sensor Selection Guide	B-2
Table B-2:	Power Sensor Cal Factor Uncertainties	B-6
Table B-3:	Modulated Sensor Specifications	B-7
Table B-4:	Directional Bridge Selection Guide	B-11

Series 8650A Universal Power Meters

About this Publication

This operation manual covers the operation and performance verification of the Giga-tronics Series 8650A Universal Power Meters:

Preface:

In addition to a comprehensive Contents and general information about the manual, the Preface also contains a record of changes made to the manual since its publication, and a description of Special Configurations. If you have ordered a user-specific product, please refer to page xix for a description of the special configuration.

Chapters:

1 – Introduction

Contains a brief introduction to the instrument and its performance parameters.

2 – Front Panel Operation

A guide to the instrument's front panel keys, display and configuration menus.

3 – Remote Operation

A guide to the instrument's GPIB remote control interface.

4 – Performance Verification

Defines the procedures to verify the performance of the 8650A Meter.

Appendices:

A - Sample Programs

Provides examples of programs for controlling the 8650A remotely over the GPIB.

B – Power Sensors

Provides selection data, specifications and calibration procedures for power sensors.

C - Options

Describes options available for the Series 8650A.

D – Menu Structure

Pictorial mapping of the various menus used in the Series 8650A. Use this appendix as a map to locate functions to perform.

Index:

A comprehensive word index of the various elements of the 8650A publication.

Changes that occur after production of this publication, and Special Configuration data will be inserted as loose pages in the publication binder. Please insert and/or replace the indicated pages as detailed in the Technical Publication Change Instructions included with new and replacement pages.

Series 8650A Universal Power Meters

Conventions

The following conventions are used in this product publication. Additional conventions not included here will be defined at the time of usage.

Warning

WARNING

The **WARNING** statement is encased in gray and centered in the page. This calls attention to a situation, or an operating or maintenance procedure, or practice, which if not strictly corrected or observed, could result in injury or death of personnel. An example is the proximity of high voltage.

Caution

CAUTION

The **CAUTION** statement is enclosed with single lines and centered in the page. This calls attention to a situation, or an operating or maintenance procedure, or practice, which if not strictly corrected or observed, could result in temporary or permanent damage to the equipment, or loss of effectiveness.

Notes



NOTE: A *NOTE* Highlights or amplifies an essential operating or maintenance procedure, practice, condition or statement.

Series 8650A Universal Power Meters

Series 8650A Universal Power Meters

Special Configurations

When the accompanying product has been configured for user-specific application(s), supplemental pages will be inserted at the front of the publication binder. Remove the indicated page(s) and replace it (them) with the furnished Special Configuration supplemental page(s).

Series 8650A Universal Power Meters

Introduction

1.1 General Information

The Series 8650A Universal Power Meters are digital-controlled, self-calibrating instruments that can measure RF and microwave signal power over a wide range of frequencies and levels in a variety of measurement modes. They can be operated locally from the front panel or remotely over the General Purpose Interface Bus (GPIB). See Section 1.3 for performance specifications. The 8650A is available as the single-channel Model 8651A or the dual-channel Model 8652A, which can simultaneously measure and display signal data for two channels.

The 8650A and the Series 80601A and 80701A power sensors offer enhanced performance in the measurement of complex modulation signals in the communication industry. The 8650A maintains the functionality of Giga-tronics 8540B and 8540C power meters and compatibility with all existing power sensor models.



NOTE: The optional 1 GHz Calibrator is required for operation with Series 80701A Power Sensors (See Option 12 in Appendix C).

1.1.1 Features

- CW, Peak & Modulation Power Meter with Burst Mask Testing
- More than 26,000 Readings/Second in the Fast Buffered Mode (GPIB only)
- 90 dB Dynamic Range CW Sensors
- +0.3% Linearly per Degree Centigrade of Temperature Change
- True Dual-Channel Display
- SCPI Command Modes (GPIB Only)
- HP 438A, 437B & 436 Native Mode Emulation (GPIB Only)
- Giga-tronics 8540B & 8540C Native Mode Emulation (GPIB Only)
- EEPROM Based CAL FACTOR Correction Sensors
- Modulated Average Power (MAP) Mode
- Pulse Average Power (PAP) Mode
- Burst Average Power (BAP) Mode
- Triggered (Time-Gated) Measurement Mode
- Wide Modulation Bandwidth (Series 8650A is capable of Accurately Measuring Signals w/ Modulation Frequencies up to 10 MHz with the 80701A Sensors)
- Dual-Channel Modulated Measurements with the 8652A and the 80601A or 80701A Power Sensors
- Strip Chart Function to View the Power Over a Selective Period of 40 Seconds to 200 Minutes
- Statistical Functions Including Mean & Standard Deviation and Graphical Displays of Histogram, Cumulative Distribution Function (CDF) and Complementary CDF (CCDF)
- Upgradable Firmware via the RS-232 Port

Series 8650A Universal Power Meters

1.1.2 Environmental Standards

The Series 8650A instruments are type tested to MIL-PRF-28800F, Class 3 for all departments and agencies of the Department of Defense applications except as follows:

- Operating temperature range is 0 °C to 55 °C (Calibrator operating temperature range is 5 °C to 35 °C)
- Operating the 8651A/8652A Power Meters in a high level RF field (approximately 3 V/m) may degrade performance, this degradation occurs at measured levels below -36 dBm and when the frequency of the field is nominally between 50 and 1000 MHz
- Non-operating (storage) temperature range is -40 °C to +70 °C
- Relative humidity is limited to 95% non-condensing

1.1.3 Power Requirements

100/120/220/240 Vac \pm 10%, 48-440 Hz, 20 W, typical. See Section 1.2.1 for details to set the voltage and install the correct fuse for the area in which the instrument will be used.

1.1.4 Items Furnished

In addition to options and/or accessories specifically ordered, items furnished with the instrument are:

- Operation Manual (P/N 31470)
- Power Cord (1 ea.)
- Detachable Sensor Cable (for Model 8651A) (1 ea.), or
- Detachable Sensor Cables (for Model 8652A) (2 ea.)

1.1.5 Items Required

The 8650A requires an external power sensor; see Appendix B for Power Sensor specifications.

 **NOTE:** The optional 1 GHz Calibrator is required for operation with Series 80701A power sensors (See Option 12 in Appendix C).

1.1.6 Cooling

No cooling is required if the instrument is operated within its specified operating temperature range (0 to 50 °C).

1.1.7 Cleaning

The front panel can be cleaned using a cloth dampened with a mild detergent; wipe off the detergent residue with a damp cloth and dry with a dry cloth. Solvents and abrasive cleaners should not be used.

1.1.8 Receiving Inspection

Use care in removing the instrument from the carton and check immediately for physical damage, such as bent or broken connectors on the front and rear panels, dents or scratches on the panels, broken extractor handles, etc. Check the shipping carton for evidence of physical damage and immediately report any damage to the shipping carrier.

Each Giga-tronics instrument must pass rigorous inspections and tests prior to shipment. Upon receipt, its performance should be verified to ensure that operation has not been impaired during shipment. Follow the installation instructions in Section 1.2 and the operating instructions in Chapter 2 or 3.

1.1.9 Reshipment Preparation

If it is necessary to return the instrument to the factory, protect the instrument during reshipment by using the best packaging materials available. If possible, use the original shipping container. If the original container is not available, use a strong carton (350 lbs./sq.in. bursting strength) or a wooden box. Wrap the instrument in heavy paper or plastic before placing it in the shipping container. Completely fill the areas on all sides of the instrument with packaging material. Take extra precaution to protect the front and rear panels. Seal the package with strong tape or metal bands. Mark the outside of the package:

FRAGILE – DELICATE INSTRUMENT

If corresponding with the factory or the local Giga-tronics sales office regarding reshipment, please provide the model and serial number. If the instrument is being returned for repair, be sure to enclose all relevant information regarding the problem that has been found.



NOTE: *If returning an instrument to Giga-tronics for service, first contact Customer Service so that a return authorization number (RMA) can be assigned. Contact Giga-tronics via e-mail (repairs@gigatronics.com) or by phone (800.444.2878). (The 800 number is only valid within the US). Giga-tronics may also be contacted via our domestic line at 925.328.4650 or Fax at 925.328.4702.*

1.2 Installation

Select the correct operating voltage and install the proper fuse in this housing. Refer to Section 1.2.2, Line Voltage and Fuse Selection for instructions on how to select the voltage and replace the fuse. Observe the following Safety Precautions when installing the Series 8650A Universal Power Meter. See Section 1.2.4 for connecting to the rear panel. Also see Section 2.4.3 for instructions on how to connect and calibrate power sensors.

CAUTION

Do not connect main power to the unit until the required operating voltage and fuse rating have been checked. The instrument can be damaged if connected to a source voltage with the line voltage selector set incorrectly.

1.2.1 Safety Precautions

This 8650A has a 3-wire power cord with a 3-terminal polarized plug for connection to the power source and safety-ground. The ground (or safety ground) is connected directly to the chassis.

WARNING

If a 3-to-2 wire adapter is used, connect the ground lead from the adapter to earth ground. Failure to do this can cause the instrument to float above earth ground, posing a shock hazard.

The 8650A is designed for international use with source voltages of 100, 120, 220, or 240 Vac, $\pm 10\%$ at 48 to 440 Hz. The 8650A uses an internationally approved connector that includes voltage selection, fuse, and filter for RFI protection (See Figure 1-1).

1.2.2 Power

The instrument is shipped in an operational condition and no special installation procedures are required except to check and/or set the operating voltage and fuse selection as described in the following.

When the instrument is shipped from the factory, it is set for a power line voltage (120 Vac for domestic destinations). The power line fuse for this setting is 0.50 A Slo-Blo. If the source voltage is to be 220 to 240 Vac, the fuse must be changed to 0.35 A Slo-Blo (See Figure 1-1).

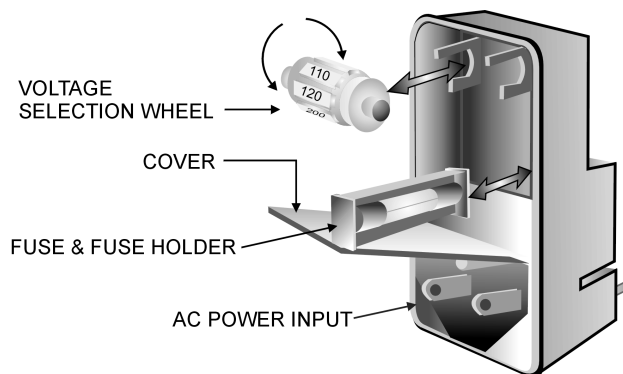

Figure 1-1: Fuse Holder

The voltage selector and fuse holder are both contained in the covered housing directly above the AC power connector on the rear panel. To gain access to them, use a small screwdriver or similar tool to snap open the cover and proceed as follows:

1. To change the voltage setting:
Use the same tool to remove the voltage selector (a small barrel-shaped component marked with voltage settings). Rotate the selector so that the desired voltage faces outward and replace the selector back in its slot. Close the housing cover; the appropriate voltage should be visible through the window (See Figure 1-1).
2. To replace the fuse:
Pull out the small drawer on the right side of the housing (marked with an arrow) and remove the old fuse. Replace with a new fuse, insert the drawer and close the housing cover (See Figure 1-1).

1.2.3 Power Sensor Precautions

Power Sensor safety precautions, selection, specifications and calibration are detailed in Appendix B to this publication.

Series 8650A Universal Power Meters

1.2.4 Interface (Rear Panel)

The rear panels for the 8651A and 8652A are identical and are illustrated in Figure 2-2. Any options that have been installed in the unit will be noted on the serial number tag. Refer to the Special Configurations section in the preface of this manual for detailed information about installed options or other special configurations. Appendix C contains information on all available options for the 8650A.

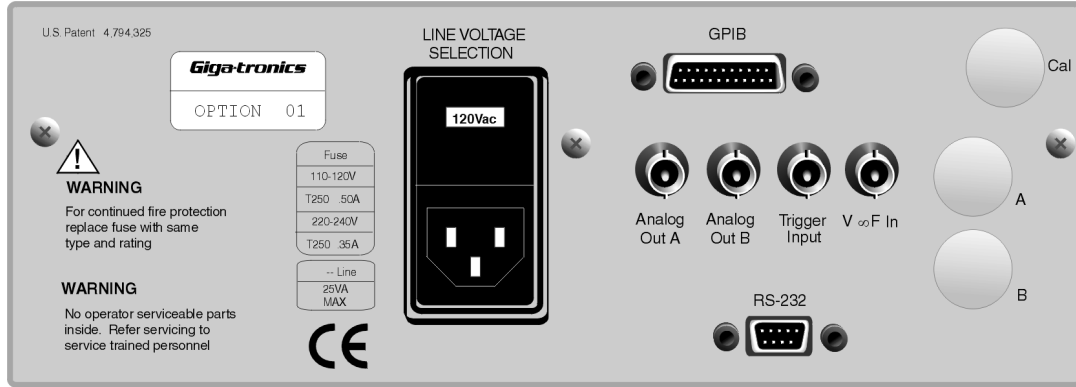

Figure 1-2: Series 8650A Rear Panel

1.2.4.1 Line Voltage Selection & Fuse

Select the correct operating voltage and install the proper fuse in this housing. Refer to Section 1.2.2 for instructions and precautions on how to select the voltage and replace the fuse.

1.2.4.2 Inputs/Outputs

Four BNC-type connectors interface the 8650A to other equipment. See the table below.

Table 1-1: Series 8650A Rear Panel I/O Connectors

Rear Panel I/O Connector	
Trigger Input	Accepts a TTL input for triggering and gating measurements as defined by the Gate/Trigger menu selections, or under GPIB control. Maximum input without damage is 15 V.
V _{PROP F} In	Accepts a voltage input that is proportional to frequency and causes the 8650A to apply appropriate frequency-related cal factors. Maximum input without damage is 15 V.
Analog Out A/B	Each provide an output voltage that is proportional to the measured power level of the respective sensors connected to the front panel.

NOTE: The Sense In connectors will be relocated to the rear panel when Option 03 (8651A) or Option 04 (8652A) is installed. The Sense In and the Calibrator Out connectors will be relocated to the rear panel when Option 13 (8651A) or Option 14 (8652A) is installed (Descriptions of these options are in Appendix C).

1.2.4.3 Remote Interface

- **GPIB** is a DB-24 connector to interface the 8650A to a host computer over the GPIB
- **RS-232** is a DB-9 connector for interfacing the meter with serial communication equipment

1.3 Specifications

1.3.1 Power Meter

Frequency Range

10 MHz to 40 GHz¹

Power Range

-70 dBm to +47 dBm (100 pW to 50 Watt)¹

Single Sensor Dynamic Range

CW Power Sensors	90 dB ¹
Peak Power Sensors	40 dB Peak, 50 dB CW
Modulation Sensors	87 dB CW; 80 dB MAP/PAP; 60 dB BAP

Display Resolution

User-selective from 1 dB to 0.001 dB in Log mode and from 1 to 4 digits of display resolution in Linear mode.

Measurement Modes

CW, Peak, MAP, BAP, PAP

Averaging

User-selective auto-averaging or manual, 1 to 512 readings. Timed averaging from 20 ms to 20 seconds. Automatic noise compensation in auto-averaging mode.

dB Rel & Offset

Allows both relative and offset readings. Power display can be offset by -99.999 dB to +99.999 dB to account for external loss/gain.

Configuration Storage Registers

Up to 20 front panel setups plus a last instrument state at power-down to be stored and recalled from non-volatile memory.

Power Measurements & Display Configuration

Any four of the following channel configurations simultaneously:

A, B, A/B, B/A, A-B, B-A, DLYA, DLYB, Min/Max, Bar Graph/Peaking Meter, Peak Hold, Crest Factor, or Mean & Std Deviation. Alternately, full-screen graphic display of Histogram, Strip Chart, Cumulative Distribution Function (CDF) and Complementary CDF (CCDF) functions.

Series 8650A Universal Power Meters

Sampling

CW Mode & Mode Modulation	2.5 to 5.0 MHz, Asynchronous
---------------------------	------------------------------

Analog Bandwidth

CW Mode	≥ 3 kHz
Modulation Mode	> 10 MHz

Time Gated Measurements

Gate Polarity	Specifies the external signal TTL high or low level as true for defining the gated time.
Trigger Delay	0 to 327 ms
Gate Time	10 ms to 327 ms
Holdoff Time	0 to 327 ms
External Trigger Polarity	Positive or negative leading edge
Delay & Range Accuracy	+ 1.5 ms or 100 ppm of the set time, whichever is greater
Settability	5 ms steps or selective by cursoring to specific digits
Trigger Signal	Standard TTL levels
Gate Polarity	Specifies the external signal TTL high or low level as true for defining the gated time.

1.3.2 Accuracy

50 MHz Calibrator (Standard)

Calibrator	+20 to -30 dBm power sweep calibration signal to dynamically linearize the sensors
Frequency	50 MHz Nominal
0.0 dBm Accuracy	$\pm 1.2\%$ worst case for one year over a temperature range of 5 to 35 °C
VSWR	< 1.05 (Return Loss > 33 dB) @ 0 dBm
Connector	Type N, 50 Ω

1 GHz Calibrator (Required for Series 80701A Sensors (See Option 12 in Appendix C))

Calibrator	+20 to -30 dBm power sweep calibration signal to dynamically linearize the sensors
Frequency	1 GHz Nominal
0.0 dBm Accuracy	$\pm 1.2\%$ worst case for one year over a temperature range of 5 to 35 °C
VSWR	< 1.07 (Return Loss > 30 dB) @ 0 dBm
Connector	Type N, 50 Ω

800 MHz to 1 GHz Synthesizer (Option 12)

Power Range	+ 15 to -30 dBm, settable in 1 dB steps
Frequency	800 MHz to 1 GHz, settable in 1 MHz steps
Power Stability	< 0.1 dB/hour
Frequency Accuracy	±0.05%



NOTE: Power accuracy for Option 12 is only guaranteed while in calibration mode at 1 GHz, 0 dBm.

Instrumentation Linearity

System Linearity @ 50 MHz	±0.02 dB over any 20 dB range from -70 to +16 dBm ¹
	±0.02 dB (±.05 dB/dB) from +16 to +20 dBm
	±0.04 dB from -70 to +16 dBm
	The following chart shows linearity plus worst case zero set and noise vs. input power

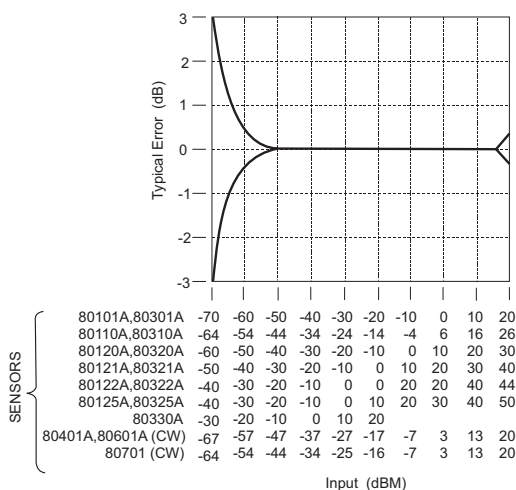

Instrumentation Linearity (Continued)

Temperature Coefficient of Linearity	< 0.3%/ °C temperature change following Power Sweep calibration. 24-hour warm-up required
Zeroing Accuracy	(CW)
Zero Set	< ±50 pW < ±100 pW (with Series 804XXA, 806XXA Modulation Power Sensors)
	< ±200 pW with Series 807XXA Sensors
	< ±100 pW during 1 hour

Series 8650A Universal Power Meters

Instrumentation Linearity (Continued)

Zero Drift (During 1 Hour) ²	< ±200 pW with Series 804XXA and 806XXA Modulation Sensors
	< ±400 pW with Series 807XXA Sensors
Noise	< ±50 pW, < ±100 pW with Series 804XXA and 806XXA Modulation power sensors
	< ±200 pW with Series 807XXA Sensors. Measurable over any 1 minute interval after zeroing, three standard deviations

Notes:

1. Depending on sensor used (See Power Sensor details in Appendix B).
2. Zero Drift Measurement
 - a. Set the meters Average to 512. Perform Calibration. Connect a 50-ohm load to the sensor after Calibration and Zero meter.
 - b. Temperature stabilize at 25 °C for 24 hours.
 - c. After the 24 hour stabilization, perform a Zero Drift test.
 - d. Zero the meter and take an initial measurement reading.
 - e. Continue taking one reading every 10 minutes until 6 readings have been taken. Plot the 6 readings, Zero Drift should be ±200pW or ±400pW, depending on the sensor.

1.3.3 Measurement Rates

Table 1-2 illustrates typical maximum measurement rates for different measurement collection modes. The rate of measurement depends on several factors including the controller speed and the number of averages. The Fast Buffered Mode speed does not include bus communication time. Measurement speed increases significantly using the 8650A Fast Buffered Mode. Storing data in the power meter's memory for later downloading to the controller reduces GPIB protocol overhead. Up to 5000 readings can be buffered.

Table 1-2: Measurement Rates

Measurement Collection Mode	Readings per Second (CW Measurement)	Readings per Second (MAP, PAP, BAP Measurement)
Normal (TR3), Continuous Single Readings	> 300	150
Swift Mode, Continuous or Buffered, Bus/TTL triggered	> 1750	800
Fast Buffered Mode, Buffered Data, Time Interval = 0	26,000	N/A
Fast Modulated Mode, Continuous Single Readings	N/A	800

Individual data points are read immediately after measurement in the Normal mode. The Normal mode and the Swift mode both slow down at low power levels (<-37 dBm for Standard Sensors) to average the effects of noise. The Swift mode allows triggering of individual data points and can store the data in the 8650A memory. Measurement timing of individual data points is controlled by setting the time interval (0 to 5000 ms) between the data points following a trigger.

Series 8650A Universal Power Meters

1.3.4 Remote Operation

GPIB Interface

All front panel operations and some GPIB-only operations to be remotely programmed in IEEE 488.2 or IEC-625 formats.

Interrupts

SRQs are generated for the following conditions: Power Up, Front Panel key actuation, Operation Complete and Illegal Command.

1.3.5 Fast Buffered Mode Controls

Trigger Source

TTL or GPIB

Data Buffer Control

Pre- or Post-measurement data is collected immediately either before or after receipt of the TTL or GPIB trigger.

Time Interval

TIME ### - controls time interval in milliseconds between measurements. Accurate to 5%, typical.

1.3.6 Inputs/Outputs

V_{PROP} Input (BNC)

Recalls cal factors using source V_{PROP} output. Corrects power readings for sensor frequency response using sweeper voltage output. Input resistance = 50K. Does not operate in the fast measurement collection modes (normal mode only).

Analog Output (BNC)

Provides an output voltage of 0 to 10V from either Channel A or Channel B in either Log or Lin units. Does not operate in the swift and fast measurement buffered modes.

Trigger Input (BNC)

Accepts a TTL trigger input signal for swift and fast measurement buffered modes and time gating mode.

GPIB Connector

Interfaces the power meter to a host computer for remote programming using SCPI, IEEE 488.2 and IEC-625 coding, also emulation modes.

RS-232 Connector

Interfaces the power meter to serial communications equipment, using RS-232 format.

1.3.7 General Specifications

Temperature Range

Operating	0 to 55 °C (32 to 132 °F)
Storage	-40° to 70 °C (-40° to 158 °F)

Power Requirements

100/120/220/240Vac $\pm 100 \mu\text{W}$ 10%, 48 to 440 Hz, 20 VA typical

Physical Characteristics

Dimensions	215 mm (8.4 in) wide, 89 mm (3.5 in) high, 368 mm (14.5 in) deep
Weight	4.55 kg (10 lbs)

1.3.8 Options

Refer to Appendix C for descriptions of options.

1.3.9 Power Sensors

See Appendix B for power sensor selection, specifications and calibration data.

Series 8650A Universal Power Meters

Front Panel Operation

2.1 Introduction

This chapter describes how to operate the Series 8650A Universal Power Meters using the front panel. It includes descriptions of the front and rear panels, configuration, display menus and practical applications. Use the items below for reference.

- Chapter 1 - Installation instructions & instrument interfacing before operating for the first time
- Chapter 3 - Remote operation instruction for operation over the GPIB (General Purpose Interface Bus) and RS-232 serial communication devices

This chapter contains the following major sections:

- Front Panel Description
- Front Panel Applications
- Measurement Guide

2.2 Front Panel Description

Although the Series 8650A has different modes of operation, the front panel is simple in design and easy to use. The instrument is configured and controlled by means of the dedicated hardkeys and the display menus, which are accessed and controlled with the data interaction softkeys. The dual-channel 8652A front panel is illustrated in Figure 2-1. The single-channel 8651A is the same in appearance but does not include the Sensor B connector.

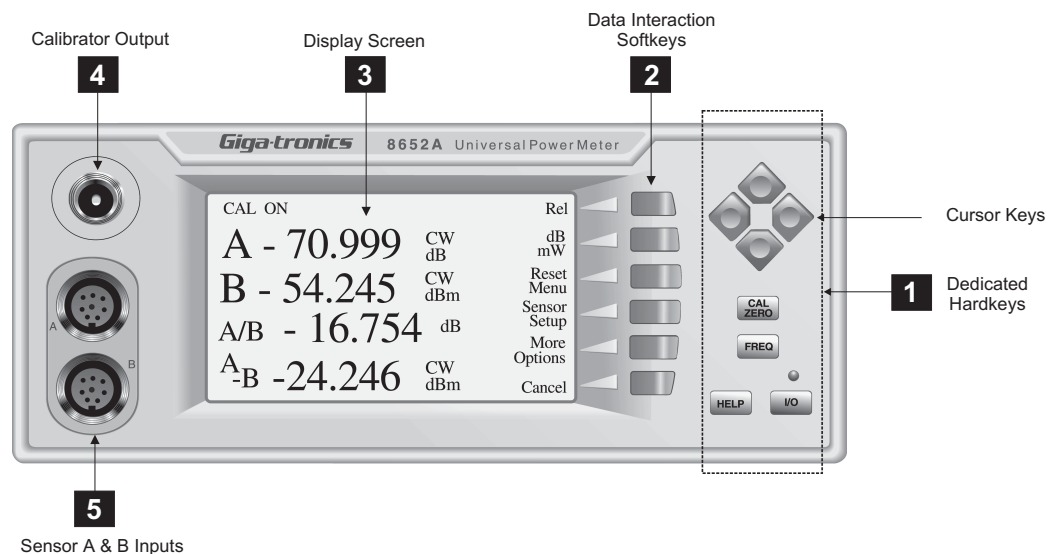

Figure 2-1: 8652A Front Panel Layout

2.2.1 Front Panel Layout Descriptions

The following are the descriptions based on the call out numbers for Figure 2-1 on the previous page.

1

Dedicated Hardkeys

The dedicated hardkeys are located on the right side of the front panel and function as described below. In this manual, instructions to press a dedicated hardkey are with the appropriate key title in bold uppercase enclosed in brackets, such as 'press **[CAL/ZERO]** to calibrate a power sensor'

Cursor Keys

These four keys are arranged in a diamond pattern and move the highlighted item (cursor) in the display to the desired location. A small diamond symbolizing the cursor keys appears in menus, with an arrow in the keys that are effective for that menu. If more than one field is highlighted, the cursor pattern will be located nearest the one that will be activated when the cursor keys are pressed.

CAL/ZERO

This key is for zeroing and calibration of a power sensor. All active sensors should be zeroed whenever any sensor is added or removed, whether it is calibrated or not.

FREQ

This key specifies the frequency of an input signal so that the power meter can apply the frequency-specific cal factor from the sensor EEPROM to the measurement.

If the frequency of the input signal changes so often that it is impractical to keep entering the frequency with the FREQ key, the frequency information can be conveyed to the 8650A by the use of a voltage input that is proportional to frequency (See the V_{PROP} connector on the rear panel). When the 8650A is controlled remotely over the GPIB, the frequency information can be sent over the bus.

HELP

Help screens describe the current display and present your options. From any menu, press **[HELP]** to display the associated Help screen. Press the up or down cursor key, if shown, to scroll the help screen up or down one line at a time. Press **[EXIT HELP]** to leave the Help screen and return to the current menu.

I/O (Power)

This push-push switch turns main power on and off. The LED above the power switch will be green when the unit is ON, and will turn yellow indicating the standby mode when the power switch is OFF with the main ac power still connected. The LED will be OFF when the ac power is disconnected. All user setting and sensor calibrations will be automatically stored in non-volatile memory for recall when ac power is turned off with the front panel on/off switch.

CAUTION

To avoid losing some current settings and ensuring that the meter powers up properly, observe the following procedures:

- 1.) Remove AC Power to the rear panel only after at least 1 second has lapsed from the time the front panel ON/OFF switch has been pressed to turn off the meter.
- 2.) Cycling the ON/OFF switch should be no faster than once a second. Pressing the **ON/OFF** switch in rapid succession is not recommended.
- 3.) If the current setup is critical, it is recommended to save it as a stored setup to prevent accidental loss

2

Data Interaction Softkeys

The data interaction softkeys select the options for configuration and measurement control. In this publication, instructions to press a softkey are identified with the selected option in italics enclosed in brackets, such as 'press [*Sensor Setup*] to configure a new power sensor'. Softkey statements will be in the same case as in the actual displays.

3

Display

The liquid crystal screen displays measurements and configuration data. It also displays the operating and control functions that can be selected with the data interaction softkeys. Figure 2-1 illustrates a typical display screen with the menu control functions aligned with the data interaction softkeys.

The menus to calibrate and perform measurements with the 8650A are many and varied. A complete menu map is provided in Appendix D of this publication. Until thoroughly familiar with the operation of the 8650A, refer to the appropriate menu map to reach the function to perform in order to speed up operation.

When turning on the power, the model number and software version will display for five seconds and then be replaced with the Main display (See Figure 2-2).

4

Calibrator Output

The Calibrator connector is a reference power output for calibrating the amplitude response of a power sensor (See Section 2.4.3 for instructions on how to calibrate and zero sensors). The frequency of the output is fixed at 50 MHz or 1 GHz, depending on the sensor in use. The Calibrator output can also be used as a programmable low-level power output (See Section 2.3.1). During a calibration run, the output level automatically sweeps from -30 dBm to +20 dBm in 1-dB steps.

5

Sensor Inputs

The **A** and **B** connectors interface Channel A and Channel B sensors to the power meter. Dual-channel 8652A has A and B sensor inputs; single-channel 8651A has only sensor A input. Refer to the Sensor Configuration details in Section 2.3.4.

CAUTION

When connecting sensor cables to these inputs, the cable pins must be aligned properly. Orient the cable so that the guide on the end of it aligns with the notch on the sensor input. If the connector does not seem to fit, forcing it will only damage the connector pins.

2.3 Front Panel Applications

The Series 8650A screen normally displays measurement data, but it also displays the setup and configuration menus for the meter, display and sensor. The setup menus are dynamic; the display adapts to the current operating mode and the type of sensors and other peripheral connections. For example, the sensor identification in Figure 2-2 will display only when a sensor is connected. If a sensor is not connected, the menu will indicate 'No Sensor A'. The menu displays these other peripheral data only when applicable.

Figure 2-2 illustrates the Main Menu; other screens will display when sensors are connected or removed.

 **NOTE:** The Main Menu is the only screen display that does not contain a mode or identification title in reverse video across the top of the screen.

The options available from the Main menu are:

- Meter Setup for configuring the meter (See Section 2.3.1)
- Display Setup for configuring the display (See Section 2.3.2)
- Sensor Setup for configuring installed sensors (See Section 2.3.4)
- dB/mW for selecting dB or power as the measurement unit (See below)
- Reset Menu to refresh a min/max value (See below)
- Rel for recording Relative Measurements (See Section 2.3.3)

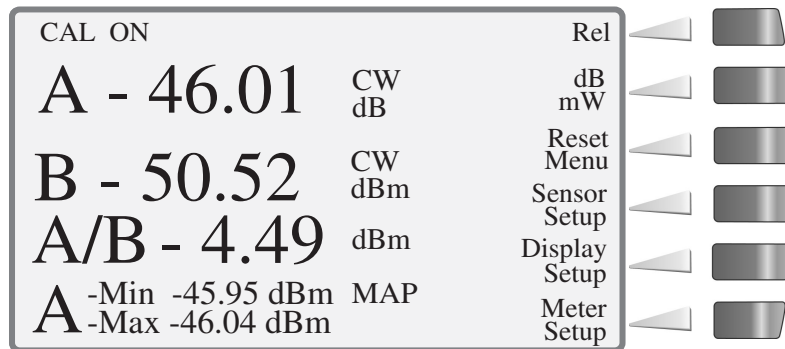

Figure 2-2: Main Menu

From the Main Menu, press *[dB/mW]* at any time to toggle between dB and mW as the measurement units. The values on the displayed lines will also change to match the units.

The Main Menu will display a *Reset Menu* selection only after configuring one or more lines to display the data gathering functions, such as Min/Max (illustrated in line 4 in Figure 2-2), Bar Graph/Peaking Meter, Peak Hold, Crest Factor, and Mean & Standard Deviation. When the selection is displayed, press *[Reset Menu]* to reset the accumulated data to its current value. Refer to Section 2.3.2 for detailed instructions on how to configure the display lines.

Most screens contain 'OK' and 'Cancel' options. After entering changes into the display, press *[OK]* to store the changes (this equates to **Enter** on a keyboard), or *[Cancel]* to cancel and return to the previous display without storing any changes (this equates to **Escape** on a keyboard).

2.3.1 Meter Setup

The Meter Setup menu provides the means to configure the meter operating mode, and to store and recall setups. From the Main menu, press **[Meter Setup]** to display the Setup Menu. Press the softkey for the function to perform. The options are:

- Calibrator to Configure and to turn the Calibrator output ON or OFF
- Config to configure the operating mode and parameters
- Sto/Rcl to store and recall meter setups
- Service to clear all memory (Additional service routines may be added to future revisions of this product)
- Display Return to return to the Main menu without selecting a configuration option

2.3.1.1 Calibrator

The section describe only how to use the Calibrator output as an RF output; See Section 2.4.3 for procedures to zero and calibrate power sensors. The Calibrator function must be turned ON to use the output as an RF source, indicated by the words **CAL ON** in the upper left corner of the Main Menu (See Figure 2-2).

Turn on the 8650A for 15 minutes then cycle the power OFF and ON, this establishes the 1 mW reference for the instrument firmware.

To turn the Calibrator ON or OFF, press **[Meter Setup]** from the Main Menu. This will display the Setup Menu. From the Setup Menu, press **[Calibrator]** to display the Calibrator menu. Toggle the Calibrator On or OFF by pressing **[On/Off]**.



NOTE: *The wording at the top of the screen will not change while this menu is displayed, but it will be changed to reflect your selection when returning to the Main Menu.*

1. Press **[Level dBm]** to set the RF output level in dBm. Enter the level with the cursor keys.
2. Press **[Level mW]** to set the RF output level in power. Enter the level with the cursor keys.
3. Press **[Frequency]** to set the output reference frequency. Enter the frequency with the cursor keys. Frequencies other than 50 MHz are available only with Option 12 (See Appendix C).
4. Press **[OK]** to accept the changes or **[Cancel]** to cancel the changes, and return to the Power Meter Configuration menu.

Series 8650A Universal Power Meters

2.3.1.2 Config

Press **[Config]** from the Setup menu to display the Power Meter Configuration menu (See Figure 2-3). From this menu to configure the following:

- GPIB (Mode & Address)
- V/F (V_{PROP}) Input & Scale Factor
- Analog A & Analog B Outputs
- Strip Chart Graphic Display
- Sound
- RS-232
- Time Gate Trigger Mode & Time Parameters
- Histogram Graphic Display

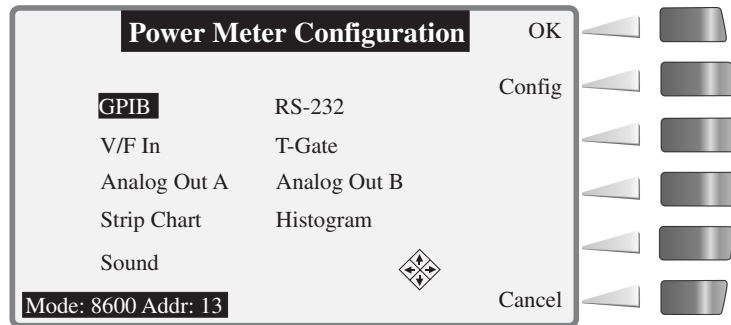

Figure 2-3: Power Meter Configuration Display

Select the item to be configured with the cursor keys, then press **[Config]**. The following options will be available for configuring the power meter:

GPIB (Mode & Address)

This option assigns the GPIB protocols and address for control of the 8650A over the GPIB interface.

1. From the Power Meter Configuration menu, move the cursor to the **GPIB** field and press **[Config]**. The menu to set the GPIB mode and address will display.
2. Press **[Mode]** to highlight the operating mode and use the cursor keys to select the desired mode of operation. The options are:
 - SCPI to use the SCPI IEEE 488 command set
 - 8600 to use the IEEE 488.2 8650 native mode
 - 8542 to use the dual-channel 8542 emulation mode (8652A only)
 - 8541 to use the single-channel 8541 emulation mode
 - 438A to use the HP-438A emulation mode
 - 437A to use the HP-437A emulation mode
 - 436B to use the HP-436B emulation mode
3. Press **[Address]** to move the cursor to the Address field. Step the address value up and down with the cursor keys. Valid addresses are:
 - 00 through 30 in the Listen & Talk mode
 - 40 in the Listen-Only mode
 - 50 in the Talk-Only mode
4. Press **[OK]** to accept the changes or **[Cancel]** to cancel the changes and return to the Power Meter Configuration menu.

V/F In

The V/F (V_{PROP}) input accepts a frequency referenced to 0 Vdc, which the power meter uses to determine and apply the appropriate correction factors (Stored in the sensor EEPROM). The voltage input is supplied by a V/GHz output from the signal source. Two values must be defined for V_{PROP} : The frequency at 0 Volts, specified in Hz, MHz or GHz, and the scale factor specified in V/GHz. The V/GHz output connector on the frequency source is usually labeled with the scale factor.

From the Power Meter Configuration menu, move the cursor to the V/F In field and press **[Config]**. The V/F Config menu will display.

1. Frequency:
 - a. Press **[Zero]** to highlight the first digit of the frequency.
 - b. Press the up/down cursor keys to select the value of the first digit of the frequency.
 - c. Continue in the same manner to set all of the digits for the desired frequency. The units adjust automatically as entering the frequency.
2. Scale:
 - a. Set the scale factor by pressing **[Scale]** and setting the value in the same manner described for the frequency.
 - b. Press **[OK]** to accept the changes or **[Cancel]** to cancel the changes, and return to the Power Meter Configuration menu.

Analog Out A & Analog Out B

The Analog A and B outputs are voltage proportional to measured power that can be applied to auxiliary test equipment such as a data recorder.

1. Select Source

The choices of output source are Line 1 through Line 4. The configuration of the Analog outputs is interactive with the Display Configuration. If any line is set for accumulated data, such as Min/Max, PKHold, CrFact, or Mean & Std Dev, it will not be displayed here for configuration.

2. Log/Lin

The mode choices are Log and Linear. Press **[Log/Lin]** to toggle between the Log and Linear modes.

3. Set Scale

The Set Scale menu adds the options to set the High and Low range in values of volts and power. Press **[Set Scale]** to enter this menu.

- a. Press **[Set High]** to select the High range or **[Set Low]** to select the low range.
- b. Press **[Power]** or **[Volts]** to toggle between the volts and power values.
- c. Use the cursor keys to set the desired value in either the High or Low range.

Series 8650A Universal Power Meters

- d. Press **[Set Volts/Set Power]** to toggle between each value. Set the digit value of each with the cursor keys.
- e. Press **[OK]** to accept the changes or **[Cancel]** to cancel the changes and return to the Power Meter Configuration menu.

Strip Chart

The Strip Chart function plots measurements on the screen over a fixed period or continuously. The X-axis displays time from the start of a measurement to a selective period of 1 to 200 minutes. While running, the adaptive autoscaled high and low plotting limits are displayed. While paused, the cursor can be used to review plotted values.

1. From the Power Meter Configuration menu, move the cursor to the **Strip Chart** field and press **[Config]** (See Figure 2-4).
2. Press **[Select Source]**. The choices for measuring sources are Lines 1 through 4. If any line is set for data gathering, it will not be displayed here.
3. Press **[Sample Rate]**. The choices are from 1 sample per minute to 5 samples per second.
4. Toggle between **[Hold Bfr]** to stop sampling when the buffer is full, or **[Rot Bfr]** to set the Strip Chart display to update continuously with new samples after the buffer is initially full while discarding the same number of beginning samples.
5. Press **[OK]** to accept the changes or **[Cancel]** to cancel the changes, and return to the Power Meter Configuration menu.

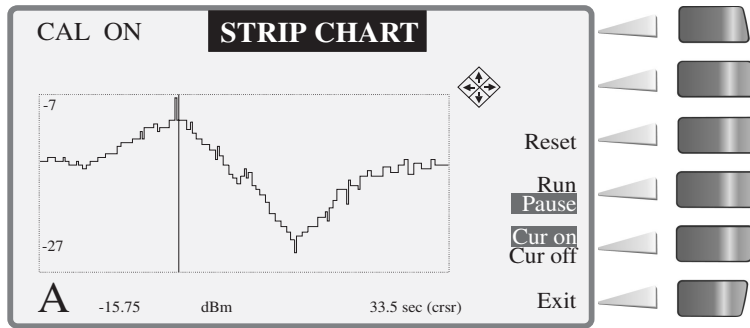

Figure 2-4: Strip Chart Illustration

Sound

A speaker within the chassis produces audible clicks and tones to register keystrokes and to draw attention to certain conditions. For example, if a limit has been exceeded or a calibration process has been completed. Press **[On]** to enable the speaker, or **[Off]** to disable it. There is no sub menu associated with this feature.

RS-232

Highlight the RS-232 option in the Power Meter Configuration menu and press **[Config]**. The RS-232 Config menu will display for configuration of the RS-232 interface.

1. Press **[Baud]** to set the Baud Rate. Select the desired rate with the up/down cursor keys. The default value is 9600.
2. Press **[Length]** to set the Data Bits. Select the desired data bit length with the up/down cursor keys. The default value is Press **[Parity]** and turn the parity on or off with the up/down cursor keys. Default parity is off.
3. Press **[Stop bits]** to set the stop bit value. Select the desired stop bit value with the up/down cursor keys. The default value is 1.
4. Press **[OK]** to accept the changes or **[Cancel]** to cancel the changes and return to the Power Meter Configuration menu.

T Gate

The Time Gate mode supplies a digital control voltage to enable or disable readings from any one or all sensors. Thus, the mode limits a power measurement to a defined interval that is controlled by a start time and a duration. The start time begins after a programmable delay following an external or internal trigger.



NOTE: The Time Gate feature operates only with modulation sensors.

Figure 2-5 illustrates the time gated measurement with an external time gated pulse applied to the trigger input. In this mode, the time gate starts and ends with the input of a high or low TTL level input. The duration of the measurement corresponds to the duration of the gated pulse.

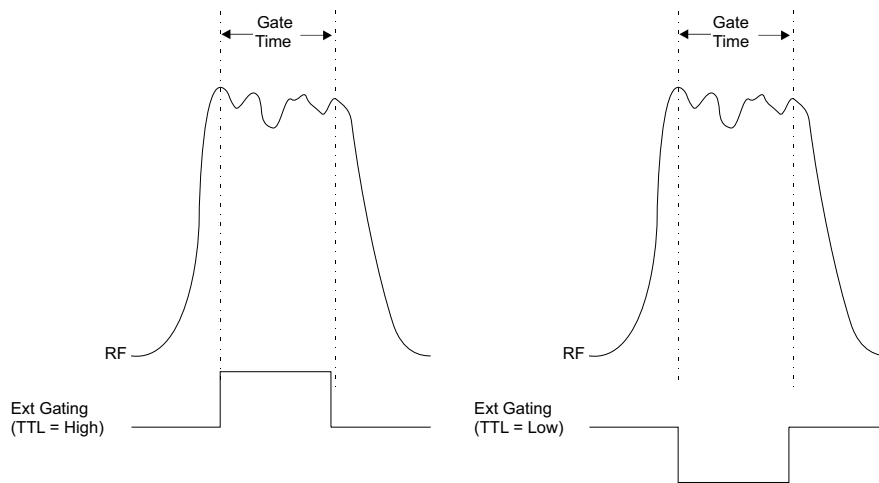

Figure 2-5: External Gating Illustration

Proceed as follows to configure the power meter for gated measurements by the sensors:

1. From the Power Meter Configuration menu, select [*T Gate*] then [*Config*] to display the Gate/Trigger menu.
2. From the Gate/Trigger menu, select the sensor with the cursor keys, then select the mode of gated operation for that sensor. The options are External Gate, Ext. Trigger Rising, External Trigger Falling and Burst Edge.
 - a. Gate

This configures the gate to measure only during a high or low input. Gate Low enables power meter readings on a low logic input, and Gate High enables readings on a high (+5 V) logic voltage input (See Figure 2-5).

- 1.) Select the sensor to be configured with the cursor keys. The current configuration of the selected sensor will be indicated in the window at the bottom of the screen.
- 2.) Press [*External Gate*] to set the sensor gate measurement to high or low.
- 3.) Press [*Gate High*] or [*Gate Low*] to set the external gating to a high or low logic state.
- 4.) Press [*OK*] to return to the Gate/Trigger menu, or <*Cancel*> to abort the configuration.

b. External Trigger

Figure 2-6 illustrates the Time Gated measurement parameters with an external trigger. When an external trigger is input (Point A in Figure 2-6), it starts the Trigger Delay. At the end of the Trigger Delay, the Gated Time measurement starts and lasts until its preselected time expires. The Holdoff Time then prevents any further trigger inputs (such as Point B below) from starting a new gated measurement until it has timed out.

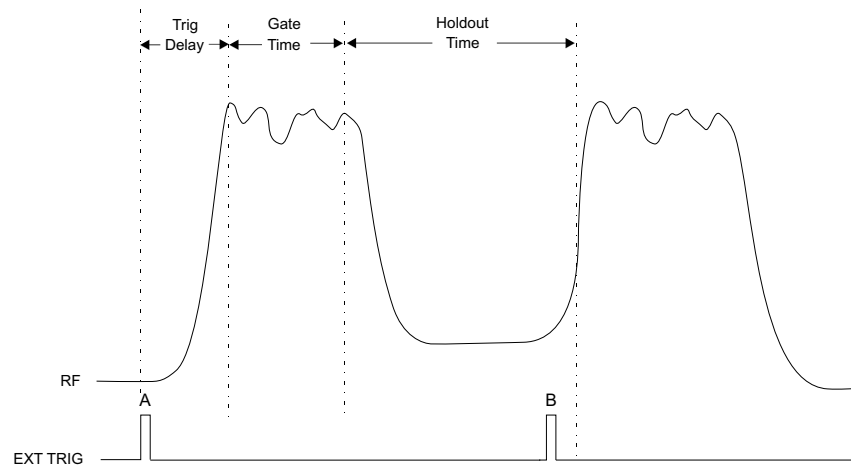

Figure 2-6: External Triggering Illustration

Series 8650A Universal Power Meters

- 1.) Press *[Ext Trigger Rising]* or *[Ext Trigger Falling]* to set the parameters of the external trigger. The settings are:
 - ✓ Delay
 - ✓ Gate Time
 - ✓ Holdoff

Upon entering the External Trigger setup, a burst profile will display at the bottom of the screen. If the following specifications are not met, the profile may be inaccurate or not displayed at all:

- a.) The time from between trigger edges is the period of the trigger. The period must be equal to or less than 50 ms.
 - b.) The burst must be at least 0.1 ms wide and have at least 0.1 ms off time.
 - c.) The trigger edge must occur before the leading edge of the burst.
 - d.) The points on the profile represent a resolution in time, which will vary according to the requirement that the burst fit on the screen, to a minimum of approximately 10 μ s per displayed point.
- 2.) Set the value of the delay with the cursor keys. The range is 0 μ s to 327.625 ms.
 - 3.) Select *[Gate Time]* and set its value. The range is 5 μ s to 327.625 ms.
 - 4.) Select *[Holdoff]* and set its value. The range is 0 μ s to 327.625 ms.
 - 5.) Press *[OK]* to accept the changes or *[Cancel]* to cancel the changes and return to the Power Meter Configuration menu.

c. Burst Edge

The Burst Edge mode uses the burst edges detected by the sensor to trigger power measurements, and is configured essentially the same as External Triggering described above. The setup screen for this mode also displays a burst graphic profile with the same conditions as described for External Triggering.

- 1.) Set the Delay and Gate time as described for External Trigger in steps 2.) and 3.) above.
- 2.) Press *[OK]* to accept the changes or *[Cancel]* to cancel the changes, and return to the Power Meter Configuration menu.

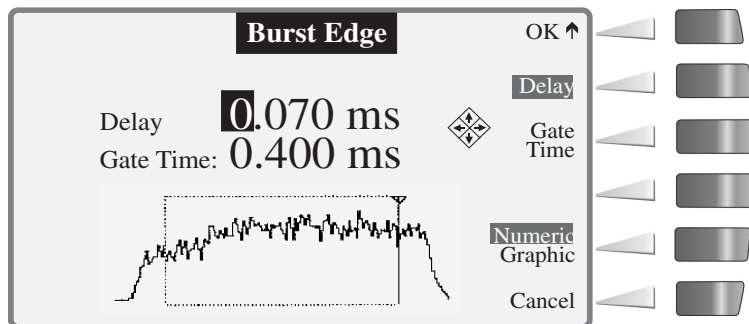

Figure 2-7: Burst Edge Configuration Illustration

Histogram

The Histogram feature displays graphical views of accumulated data distribution over a selective period of time (See Figure 2-8). Highlight the Histogram option in the Power Meter Configuration menu and press **[Config]**.

1. Press **[Select Source]** and select the input channel (8652A Only) or display the line number.
2. Toggle Log or Lin with the **[Log/Lin]** softkey.
3. Press **[Interval]** and select the duration the data is to be acquired. The range is from 1 second to 96 hours, or continuous.
4. Press **[OK]** to accept these settings or press **[Cancel]** to cancel the settings, and return to the Power Meter Configuration menu.
5. Press **[OK]** from the Power Meter Configuration menu. The Histogram will display full screen as shown in Figure 2-8.

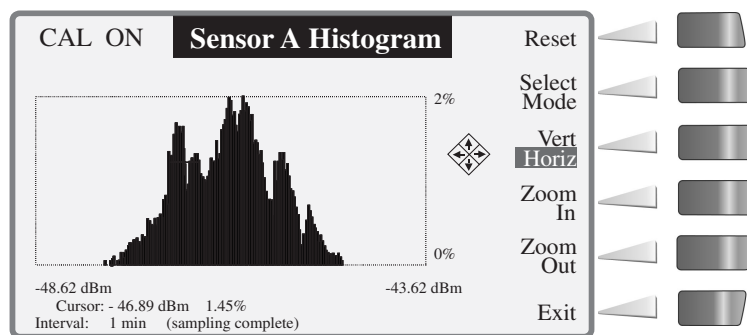

Figure 2-8: Histogram Illustration

There are additional functions available from the Histogram screen:

1. Press **[Reset]** to restart sampling.
2. Press **[Select Mode]** to toggle between distribution display functions.
 - a. The Histogram (See Figure 2-8) shows the percentage of time each power level is measured.
 - b. The CDF (Cumulative Distribution Function) shows the percentage of time a signal is below a selected power level (See Figure 2-9). The x-axis displays the power level and the y-axis displays the percentage of time the power is at or below the power level specified by the x-axis.
 - c. The CCDF (Complementary CDF) (See Figure 2-10) shows the percentage of time a signal is above a selected power level for more accustomed viewing of a descending slope.
3. Press the **[Vert/ Horiz]** toggle key to select the zoom axis scale, then press **[Zoom In]** or **[Zoom Out]** for the selected axis.

Series 8650A Universal Power Meters

4. Move the cursor along the slope of any curve to display, below the graph, the cursor position, the power level and the corresponding percentage of time the signal is above or below that level.

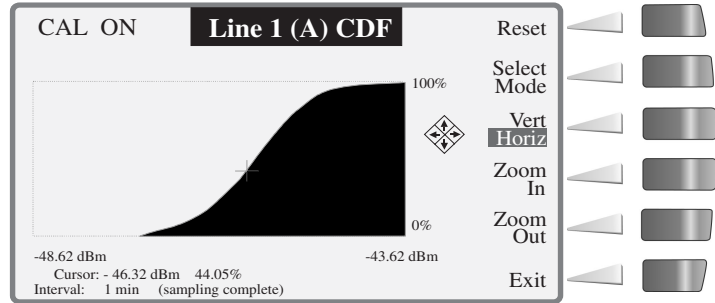

Figure 2-9: CDF Curve Illustration

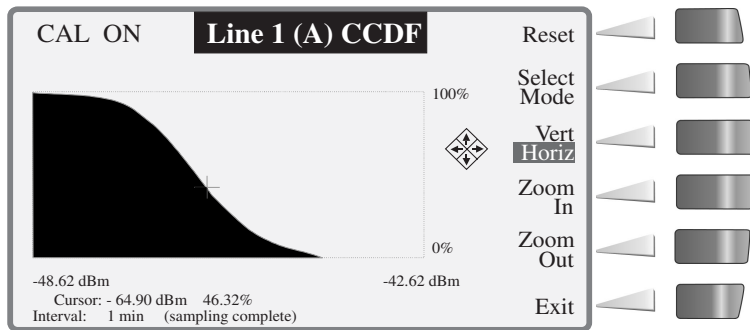

Figure 2-10: CCDF Curve Illustration

Sto/Rcl

Up to 20 setup configurations can be stored in and recalled from non-volatile memory.

Recall

1. From the Setup Menu press *[Sto/Rcl]*.
2. Select *[Recall]* to recall a previously stored setup.
3. Step through the stored setup addresses with the cursor keys until the setup to recall is displayed.
4. Press *[OK]* to recall the selected setup.
5. Press *[Recall Preset]* to recall the default setup for the connected sensors.

Store

1. To store the current configuration, press *[Sto/Rcl]* from the Setup Menu.
2. Select *[Store]* to store the current setup.
3. Select the setup ID (1 through 20) to assign to this setup.

4. A name of up to 16 characters can be used as an additional means of identifying the setup. Press *[Name]* to open the display containing this option. Set the name by moving the cursor to the first position desired with the *< and >* softkeys, then select the character for that position with the cursor keys. Repeat this process for each character in the name.
5. Press *[OK]* to accept the stored data or press *[Cancel]* TWICE to cancel the changes, and return to the Power Meter Configuration menu.

Service

This is presently used only to clear all memory in the 8650A. When pressing *[Service]*, a prompting to press *[Clear Mem]* to clear all calibration, configuration, and measurement data currently stored in the 8650A RAM. Data stored in sensor EEPROMs are not affected.

2.3.2 Display Setup

Use this option to configure the data and format that will display on each line of the screen.

From the Main Menu, press *[Display Setup]* to select the Configure Display menu (See Figure 2-11). This screen is the same as the Main Menu except the control items are changed to display line configuration options. The configuration of each line includes the source and data format, data resolution, and peaking meter (bar graph) when configuration for use. In addition, the control to set the screen brightness is included in this display (other Options).

One to four lines of data can be configured, and any attached sensor can be mapped to any of the four lines. Other information items are displayed at the top of the screen. These include **CAL ON**, which displays whenever the calibration RF source is on; **REMOTE**, which displays whenever the power meter is being operated by remote control (GPIB or RS-232); and configured inputs **A**, **B**, **A/B**, **A-B**, **B/A** and **B-A**.



NOTE: The above input configurations are available only in the 8652A. The single-channel 8651A will have input A only.

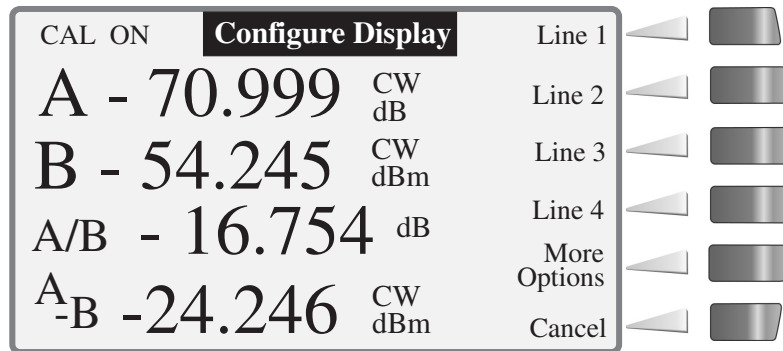

Figure 2-11: Configuration Display Menu

2.3.2.1 Line Configuration

Select the line to be configured by pressing the corresponding *[Line n]* softkey. The menu in Figure 2-12 will display. The current configuration of the selected source displays in the large window at the bottom of the screen.

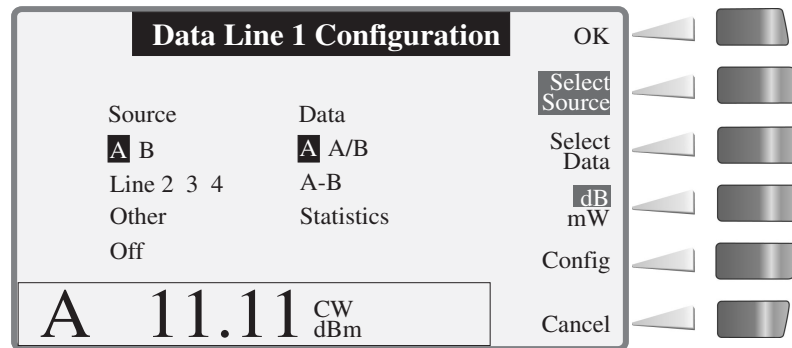

Figure 2-12: Data Line Configuration Menu

Source:

1. Press *[Select Source]* to enable the cursor in the Source field.
2. Move the highlight with the cursor keys to select the desired source.

a. A B:

This corresponds to sensor A and B inputs. The *Data field* will show the line configuration possibilities when selecting the corresponding *source input*. When selecting source A, the Data field will read A, A/B and A-B. When selecting source B, the Data field will read B, B/A and B-A.

b. Line n:

When selecting Line *n* in the Source field, the Data field will change to **Min/Max**. Configure the selected line number to be the source. For example, use the selected line to display the minimum/maximum values of another line (Line *n*). The only line numbers that will be available for selection are those which have already been configured and are not configured to show min/max values of other lines. If selecting line number to show the min/max values of another line but the line is not available in the source list, go back and reconfigure the missing line. It may not be configured at all, or it may be configured to display the min/max of another line.

c. Other:

This selection changes the Data field to copy another line into the line number configuring. The Data field will change to indicate the lines, such as *n1*—>*n2*, meaning that line *n1* will be copied into line *n2* (the line configuring). To find this option useful, for example, if changing a line, but do not want to lose its configuration; select *Other* and copy the configuration to a different line and retain the configuration on the new line.

d. Off:

Select this option to turn the line off. When a line is turned off, it will not be available as a source Line *n*. For example, if Line 4 is turned off, setting Line 3 cannot read the minimum/maximum values of line 4.

Data

1. After selecting the source for the line being configured, press **[Select Data]** to enable the cursor in the Data field.
2. Move the highlight with the cursor keys to the configuration of your choice.
 - a. When selecting source **A**, the Data field will read **A**, **A/B** and **A-B**. When selecting source **B**, the Data field will read **B**, **B/A** and **B-A**.
 - b. Other measurements that can be selected for Modulation Sensors are Peak Hold, Crest Factor, and Mean & Standard Deviation.
3. **DB/mW**:

This selection toggles the line units between dB and mW. It can be changed at any time to display the opposite units.

Config

Use the **Config** selection to set the measurement resolution, upper and lower limits, and utilization of the bar graph. Lines configured with Statistics can be configured only for *resolution*; the *Set Limits* and *Bar Graph* options will not display for these lines.

1. Press **[Config]** and use the cursor keys to set the resolution of the input. The resolution will be displayed in the large window at the bottom of the screen. Adjust the resolution with the cursor keys to the desired level. The range is 0 to 3 decimal places.
2. Press **[Set Limits]** to set the upper and lower measurement limits, or to turn the limits off.
 - a. Press **[High]** and set each digit of the high limit with the cursor keys.
 - b. Press **[Low]** and set each digit of the low limit with the cursor keys.
 - c. Press **[Limits Off]** to disable use of the limits. Press **[High]** or **[Low]** again to enable and set the limits.
3. Press **[Bar Graph]** to set the utilization of the bar graph scale.
 - a. The menu will display as described above for *Set Limits*.
 - b. Follow the *Set Limits* procedure above to set the bar graph scale, or to disable the bar graph.
 - c. The upper and lower limits of the bar graph will be displayed in the Main menu as brackets with the current measurement shown as a horizontal bar between the brackets (e.g.,[]).
4. Press **[OK]** to save all changes and return to the Configure Display screen, or **[Cancel]** to leave the configuration without saving any changes.

More Options

1. Select *[More Options]* from the Configure Display menu (See Figure 2-11) to set the brightness of the display screen. The adjustments, made with the cursor keys, is interactive, allowing the observation of the brightness. The range is 0% (off) to 100%. The default is 70%.
2. Press *[OK]* to save all changes and return to the Configure Display screen, or *[Cancel]* to leave the configuration without saving any changes.

2.3.3 Relative Mode (Rel)

Normally, each line of the display shows a sensor measurement value. When pressing *[Rel]* from the Main menu, the present measured value of each line is recorded and all subsequent measurements are expressed in dB or percentage relative to that recorded value. The Relative Measurement menu provides a means of selectively enabling or disabling the relative measurement mode for channels A or B.

1. Press *[Select Line]* repeatedly to select the line to be used for relative measurements. Use the cursor keys in this menu only to change the value of the selected line.

The selected line can be switched in and out of the Relative Mode by pressing the *[Rel On/Off]* key.

2.3.4 Sensor Setup

Sensor configuration enables selecting the operating mode of sensors, or to select the parameters for averaging time-based measurements. From the Main Menu, press **[Sensor Setup]** to display the installed sensor data and configuration options (See Figure 2-13). The power meter reads the contents of the EEPROMs for installed sensors and displays each type of sensor and its connecting input.

The **[Sensor Setup]** softkey will not function if there are no sensors attached, or if attached sensors have not been calibrated. The Sensor Setup options are dependent on the type of sensor. All sensors options are **Avg** and **Offset**. Peak and Modulation sensors add a **Config** option (See Figure 2-13).

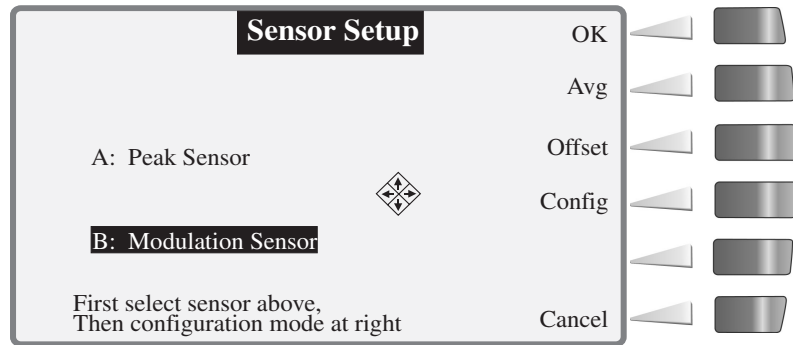

Figure 2-13: Sensor Setup Menu

Avg

Use this option to set the averaging period of power measurements, including modulated, CW and peak sensors. Press **[Avg]** from the Sensor Setup menu to display the **Sensor Setup - Averaging menu**. This menu offers three options: *Auto*, *Averages* and *Time*.

Auto

1. Select this setup option if the time is to be 'adaptive' averaged. That is, the time window changes dynamically to reduce the effects of transient changes in power levels.
2. Press **[OK]** to store the changes, or **[Cancel]** to exit without saving changes.

Averages

1. Select this setup option to set the number of periods for averaging measurement signals over a fixed period of time. Each unit is approximately 20 ms in duration. There is the choice of 'powers of two' multiples of units from 1 to 512. Set the number of periods with the up/down cursor keys.
2. Press **[OK]** to store the changes, or **[Cancel]** to exit without saving changes.

Time

1. Select this option to average measurement signals over a fixed period. A menu will display for to set the time in seconds between 20 ms and 10 seconds. The meter will automatically change the selection to the nearest of 20 ms times powers of 2 multiples of 1 to 512 (e.g., entering 1.000 seconds will be changed to 1.280 seconds). Set the time digits with the cursor keys.
2. Press **[OK]** to store the changes, or **[Cancel]** to exit without saving changes.

Offset

Select this option to enter an offset value in dB when an attenuator or amplifier is installed before the sensor input. From the Sensor Setup menu.

1. Press **[Offset]** and enter the value of the offset with the cursor keys.
2. Press **[OK]** to store the changes, or **[Cancel]** to exit without saving changes.

Config

This option is available with Peak and Modulation sensors only.

Peak Sensors

1. From the Sensor Setup menu select the Peak sensor with the cursor keys.
2. Press **[Config]** to display the Setup Mode menu. This menu offers two options: *CW* and *Peak*.
3. Press **[CW]** to select the *CW* mode for the peak sensor. There is no configuration for peak sensors operating in the *CW* mode and the screen will return to the Setup Menu to configure other sensors.
4. Press **[Trig Level]** to configure the trigger level in either the Internal or External Trigger mode.

a. Internal Trigger

Peak power will be sampled at a point defined by a Trigger Level, a Delay, and a Delay Offset. The delay-offset feature is a convenience in some applications (For example, when measuring pulse width from a point other than the trigger level, or when comparing the levels of various pulses within a pulse train).

- 1.) Press **[Int/Ext Trig]** to select Internal Triggering.
- 2.) Set the Trigger Level value with the cursor keys.
- 3.) Press **[Delay]** and use the cursor keys to adjust the Trigger Delay (0 to 100 ms). Units will change automatically.
- 4.) Press **[Delay Offset]** and use the cursor keys to adjust the Trigger Delay Offset (0 to 100 ms). Units will change automatically.
- 5.) Press **[OK]** to store the changes, or **[Cancel]** to exit without saving changes.

b. External Trigger

The External Trigger mode is configured the same as the Internal Trigger mode described above, except that the Trigger Level is specified in volts rather than dBm.

- 1.) Press **[Int/Ext Trig]** to toggle to the External Trigger mode and set the Trigger Level value in volts with the cursor keys.
- 2.) Press **[OK]** to store the changes, or **[Cancel]** to exit without saving changes.

Series 8650A Universal Power Meters

Modulation Sensors

Modulation sensors can be used in CW, Modulated Average Power (MAP), Peak Average Power (PAP) and Burst Average Power (BAP) modes.

1. From the Sensor Setup menu select the Modulation sensor with the cursor keys.
2. Press **[Config]** to select and configure a modulation sensor. The options for this configuration are CW, MAP, PAP, and BAP.
 - a. Press **[CW]** to select the CW mode. There is no configuration for modulation sensors operating in the CW mode and the screen will return to the Setup Menu to configure other sensors.
 - b. Press **[MAP]** to select the MAP mode. There is no configuration required and the screen will return to the Setup Menu to configure other sensors.
 - c. Press **[PAP]** to select the PAP mode. A prompting will occur to enter a duty cycle for pulse average inputs. Use the cursor keys to adjust the Duty Cycle. The range is 0.001% to 99.999%.
 - d. Press **[BAP]** to select the BAP mode. The options are Auto Config and User Config.
 - 1.) Press **[Auto Config]** for the meter to automatically configure itself and return to the Setup Menu.
 - 2.) Press **[User Config]** to configure the meter manually. A prompting will occur to enter the values for the *Burst Start Exclude*, *Burst End Exclude* and *Dropout*. Enter these values by pressing the corresponding softkey and using the cursor keys to change the values.

Press **[OK]** to store the changes, or **[Cancel]** to exit without saving changes, and return to the Sensor Setup menu to configure the next sensor, or return to the Main menu.



NOTE: Operating the 8651/8652A Universal Power Meters with the 80701A Sensors in a high level RF Field (Approximately 3 V/m) may degrade performance. This degradation occurs at measured levels below -30 dBm and when the frequency of the field is nominally between 100 and 200 MHz.

2.4 Measurement Guide

This section presents guidelines for practical applications of the 8650A. See Section 2.4.9 for mode restrictions.

2.4.1 Using the Power Sweep Calibrator

The Power Sweep Calibrator automatically calibrates the power sensor to the power meter. The power sweep operates from -30 to +20 dBm (the complete, non-square-law operating region) and transfers the inherent linearity of an internal, thermal-based detector to the balanced diode sensors. Output is NIST-traceable at 50 MHz, 0 dBm to an accuracy of $\pm 0.7\%$ ($\pm 1.2\%$ over one year). (NIST: *National Institute of Standards and Technology*).

2.4.2 80701A Sensor Operation

The Series 80701A power sensors are designed for the precise measurement of signals with wide modulation bandwidths (up to 10 MHz). In terms of the various measurement modes (i.e., MAP, BAP, etc.), the 80701A sensors are operated exactly as the Series 804XXA and 806XXA sensors described in Appendix B.



NOTE: Series 80701A sensors require the installation of Option 12 (See Appendix C).

There is one distinction regarding the operation of the 80701A sensors. Below 200 MHz, the modulation bandwidth of the sensor is limited by a filter which is electronically switched in the sensor. This is done to keep the RF signal out of the base band signal processing circuitry. When a 80701A sensor is calibrated on the meter for the first time (the meter reads **UNCALIBRATED** before calibration), the unit is set to the default setting of MAP mode with frequency correction set to 1 GHz. This allows the sensor to measure signals with wide-bandwidth modulation. For frequencies of 200 MHz or below, the frequency correction must be set to the measurement frequency to avoid measurement error.

The Series 80701A sensors are compatible with the 8651A and 8652A Power Meters.

CAUTION

Sensor diodes can be destroyed by momentary or continuous exposure to excess input power. The maximum power (peak or average) that can be applied to the detector elements without damage is printed on the side of the sensor housing. For standard CW and peak power sensors, the maximum level is +23 dBm (200 mW). Standard sensors should not be used above +20 dBm (100 mW) because this may degrade the sensor's performance even if it does not burn out the diodes.

When measuring pulsed signals, it is important to remember that the peak power may be much greater than the average power (it depends upon the duty cycle). It is possible to overload the sensor with a pulsed signal even though the *average* power of the signal is far below the maximum level.

To measure higher power levels, use a high power sensor; or reduce the signal amplitude using a directional coupler or a precision attenuator.

Series 8650A Universal Power Meters

2.4.3 Sensor Calibration & Zeroing

All sensors must be calibrated and zeroed before making measurements.

2.4.3.1 Calibration & Zeroing

1. Connect the sensor to be calibrated from Channel A or B to the Calibrator output (See Figure 2-14).



NOTE: Connector sensor to the Calibrator connector after the power meter is turned on. Allow a 15-minute thermal equilibrium period for the sensor and calibrator connector to minimize temperature differences.

2. Calibrate the sensor(s) within the 5 °C to 35 °C (41 to 95 °F) operating temperature range of the Calibrator.



Figure 2-14: Setup for Sensor Calibration

3. Press the [CAL/ZERO] hardkey. The meter will automatically zero and calibrate the sensor. A sensor requires several minutes to fully zero and calibrate. After the zero/calibration routine is complete, the display will return to the Main menu.



NOTE: If the calibrator is set to 0.00 dBm and turned on before or immediately after calibration, it is possible to measure approximately ± 0.02 dBm from the calibrator output instead of 0.00 dBm (0.4% difference). This is normal and within specification due to a combination of tolerances resulting from calibrator accuracy ($\pm 1.2\%$ worst case for one year, over temperature range of 5 °C to 35 °C) and connection tolerance.

2.4.3.2 Zeroing Only

1. For only zero one or both sensors, make sure both sensors are connected to the sensor inputs and that neither sensor is connected to the Calibrate output. When zeroing a sensor, it is best to connect the sensor to the device under test exactly as it will be used in measurement, and deactivate the RF output of that device. Zeroing the sensor in place is the best way to counteract system noise which could significantly effect low-level measurements.
2. Turn off the source output before zeroing the sensor. The microwave source must output less than -74 dBm of total noise power during RF Blanking for proper zeroing. The source signal power should be less than -90 dBm.



NOTE: Sufficient time must be allowed for the module to reach thermal equilibrium with the source. This could be up to 15 minutes for moderate initial temperature differences.

3. Press **[CAL/ZERO]**. The meter will check that the sensors are installed and calibrated, then it will display a menu to select Sensor A, B or both (All) to be zeroed. Select the sensor(s) to start the zeroing process, or press **[Cancel]** to abort zeroing and return to the Main menu.
4. The sensor should be zeroed just before recording final readings in the lower 15 dB of the power sensor's dynamic range.
5. The sensor should remain connected to the signal source during zeroing. By turning off the source instead of disconnecting the detector, the zeroing process automatically accounts for ground line voltages and connector interface EMF.



NOTE: Sufficient time must be allowed for the module to reach thermal equilibrium with the source. This could be up to 15 minutes for moderate initial temperature differences.

2.4.3.3 Calibration & Zeroing (High Power Sensors with Removable Attenuators)

When using a Giga-tronics high power sensor with external attenuator, Giga-tronics power meters automatically recognizes the sensor type and compensates for the attenuation factor. However when performing the front panel calibration, be sure to remove the attenuator before connecting to the calibrator port. During measurement, there is no need to enter an offset factor to account for the attenuator loss. The sensor frequency calibration factors automatically correct for the combined frequency response of the sensor and attenuator. Because the sensor and attenuator are a matched set, the serial numbers of the sensor and attenuator are identical. Do not use attenuators from other high power sensors.

1. Remove the high power attenuator from the sensor.
2. Connect the sensor to be calibrated from Channel A or B to the Calibrator Output (See Figure 2-14).
3. Press the **[CAL/ZERO]** hardkey. The meter will automatically zero and calibrate the sensor.
4. Reconnect the high power attenuator to the sensor.



NOTE: There are alignment marks (arrows) on the sensor and attenuator. To reduce measurement uncertainty, align the arrows when reconnecting the attenuator to the sensor.

2.4.3.4 Low Level Performance Check

This procedure provides a quick-check list for evaluating meter/sensor performance for low-level measurements. It is not intended to verify performance of specifications such as Noise, Temperature Coefficient and Zero Set. For complete verification, please refer to Chapter 4.

1. This test is meant to check the low level performance of the meter and sensor. In order to do so, the meter and sensor should first be separated from any external amplifiers, test systems, etc. Turn the meter on and allow stabilization at ambient for a minimum of 30 minutes. Connect the sensor cable to the meter and the sensor to the calibrator output port.
2. **Calibration.** Calibrate the power meter by pressing the **[CAL/ZERO]** button.



NOTE: *During calibration an approximate zero is established for calibration purposes only. This zero is not valid for actual measurements and can limit the measurement range as high as -50 dBm. For proper low-level measurements, the sensor must be zeroed at the test port of the system being tested. Zeroing at the test port provides corrections for ground line voltages and connector interface EMF.*

3. **Zeroing.** Validation of meter and sensor noise floor will be checked using an attenuator or termination. Connect the attenuator or termination to the sensor and allow the unit to stabilize for 3 minutes. The sensor must be thermally stabilized for proper zeroing. If the thermal conditions of the sensor varies during the zero procedure, the zero will not be valid.
4. Set averaging to 512 and configure for CW operation. After the unit has thermally stabilized, push the **[CAL/ZERO]** button.
5. Immediately after zeroing, confirm that the meter reading is at least 3 dB below the minimum CW operating range of the sensor. This checks the noise floor and zero set capabilities of the meter and sensor.
6. **Zero Drift.** Zero Drift is a measure of the change in noise over time. Each family sensor will have a specified expectation of drift over a one-hour period. To confirm, set the meter to linear display (Watts) after verifying noise floor and check that the display does not drift beyond specification over a one-hour period.

Verification for specifications such as noise, zero drift and temperature coefficient of linearity are difficult, time consuming tests. This checklist is useful to quickly determine if there is a catastrophic system failure. Failure to meet the above guidelines is not necessarily an indication of specification failure. Final confirmation of system specification performance is achieved using the verification procedures found in Chapter 4.

2.4.4 Measuring Source Output Power

To measure the source output power:

1. Connect the power sensor to the RF output of the microwave source.
2. Verify that the microwave source RF output is ON.
3. Press **[FREQ]**; enter the operating frequency (use the cursor keys to adjust the value), and press **[OK]**.
4. The 8650A will now display the microwave source output power. Adjust the source amplitude to the desired level.

The 8650A responds rapidly to amplitude changes. Ranging is automatically performed in real time through a 90 dB dynamic range using CW or modulated sensors. The peak sensor dynamic range is 40 dB Peak and 50 dB CW. Entering the operating frequency enables the 8650A to automatically apply frequency calibration factors appropriate to the sensor being used. The operating frequency can be communicated to the 8650A using the front panel menus, the GPIB, or the V_{PROP} voltage input.

2.4.5 Using the Peaking Meter

The line bar graph provides a linear display of power level on a decade range basis. For example, a power level of 3 dBm produces an approximate 50% response on the peaking meter. The peaking meter displays on the configured line as a solid horizontal bar between two brackets. The bracket on the left of the screen represents the lower limit of the peaking meter, and the bracket on the right of the screen represents the upper limit (See Figure 2-15). The procedure to turn the peaking meter on and off, and to set its limits is detailed in Section 2.3.2.

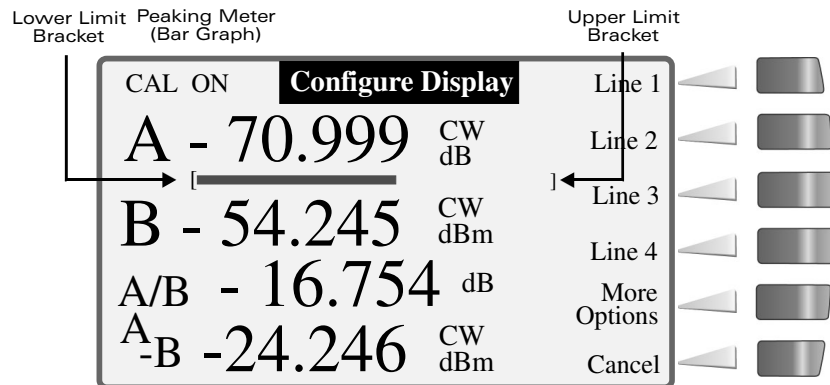

Figure 2-15: Peaking Meter

2.4.6 High Power Level Measurements

High power amplifiers and transmitters can damage standard sensors. Use only high power sensors to measure these devices without using attenuators and measurements.

For example, if the output of an RF source is amplified to +30 dBm (1 Watt), this signal cannot be measured directly using a standard sensor because the sensor's maximum input level is +23 dBm (and any level above +20 dBm is potentially harmful to a standard sensor). The signal would have to be attenuated, and the attenuation would have to be corrected for by means of a measurement offset. However, if a 5 Watt high power sensor is used, any power level up to +37 dBm can be measured directly without the use of an attenuator.

2.4.7 Modulated Measurement Modes

The 8650A series of power meters expands upon the capabilities of the previous 8540 power meters in a number of ways. In the past, power measurements of modulated signals (Pulse, Multi-tone, AM, etc.) required that the signals be attenuated to levels less than -20 dBm to avoid errors due to sensor nonlinearity. The 8650A eliminates this restriction when used with a modulation sensor, and brings the speed and accuracy of diode sensors to the power measurement of modulated signals. Basic measurement procedures are presented below, along with some useful tips on how to get the most out of the modulated measurement modes.

The modulated measurement modes are available through the sensor setup menu when the active sensor is a modulated series. The 8650A features three modulated measurement modes:

- Modulated Average Power (MAP)
- Pulse Average Power (PAP)
- Burst Average Power (BAP)

MAP and PAP modes measure the true average power of modulated and pulsed signals. PAP mode differs from MAP mode only in that it allows specifying a duty cycle figure, which is automatically factored into the measurement. In BAP mode, the true average power within the pulse is measured (the pulse pattern is detected automatically, so there is no need to specify the duty cycle).

2.4.7.1 MAP Mode

The Modulated Average Power (MAP) mode measures RF signals, which are amplitude modulated, pulse modulated, or both. In the MAP mode the 8650A calculates the average RF power received by the sensor over a period of time controlled by the time constant of the internal digital filter. The result is comparable to measurement by a thermal power sensor.

In this mode, the 8650A measures the average power of CW and modulated signals, such as:

- AM
- Two-tone
- Multi-carrier
- Pulse modulation
- Digital modulation (QPSK, QAM, etc...)

For example, if an RF signal pulse modulated at 50 Hz with a 10% duty cycle is measured with the averaging factor set to 128, the measured power reading will be 10% of the peak power during pulse ON periods. The signal is modulated at a low pulse rate (below about 1 kHz), the 8650A will synchronize the readings precisely with the start of a pulse so that each displayed reading is averaged over a whole number of pulses (There are no fractional pulses included in the measurement). This eliminates a

significant amount of noise from the readings. An important remind, even though the filter settling time has been set to a long time constant of 2.56 seconds, the update rate of the meter will be much faster, even the first reading will be very close to the fully settled value.

2.4.7.2 PAP Mode

The Pulse Average Power (PAP) mode is similar to the MAP mode, but it measures pulse-modulated signals having a known duty cycle. To specify this duty cycle and the 8650A will automatically correct the measurements so that the displayed readings indicate the peak RF power during pulse ON periods.

For example, when measuring a pulse modulated signal with 50% duty cycle, MAP mode would give a reading 3 dB lower than the reading that would be given by PAP mode with the duty cycle factor set to 50%.



NOTE: The duty cycle correction presumes a perfectly rectangular profile for the RF pulse shape. Any abnormality such as overshoot, undershoot, slow rise time or fall time, inaccuracy of the duty cycle, or deviation from a flat pulse response will cause errors in the indicated reading.

2.4.7.3 BAP Mode

The Burst Average Power (BAP) mode measures the average power during an RF burst (See Figure 2-16). This mode is very useful for measurement of pulse modulated signals which are not flat or have amplitude modulation during the pulse ON period, as in the case of TDMA (Time Division Multiple Access) communications signals. In this mode, the 8650A recognizes the beginning and end of a burst of RF power and takes an average of the power during that burst. The RF level can vary over a wide range during the burst as long as it remains above a noise threshold, which is automatically calculated by the 8650A. As soon as the RF power drops below the noise threshold, the RF burst is complete and all further readings are discarded until the next burst starts.

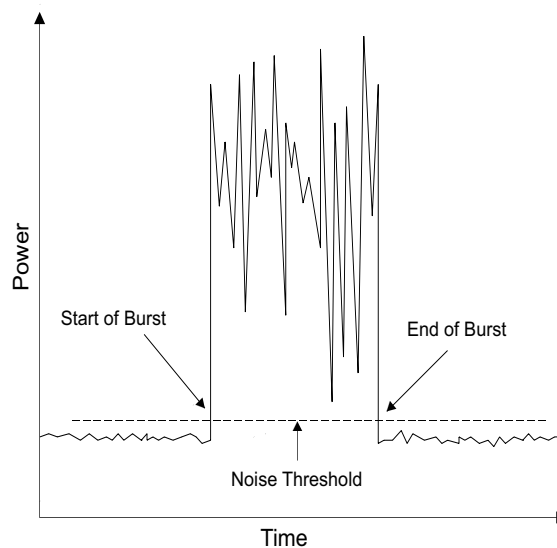

Figure 2-16: Burst Measurement

Series 8650A Universal Power Meters

In BAP mode, the 8650A automatically determines which portions of the signal are in the pulse and which are not. In computing the average power, the 8650A uses only those portions that are within the pulse. The result is that, independent of the signal's pulse duty cycle, the meter always reads the average power in the pulse or burst. As with the PAP mode, when measuring a pulse modulated signal with 50% duty cycle, the reading in the BAP mode would be 3 dB higher than in the MAP mode. However, in the BAP mode, the signal's duty cycle can change dynamically in time without affecting the meter reading. In the PAP mode, the duty cycle factor must be entered to match the duty cycle of the pulsed signal.



NOTE: *BAP Mode requires a minimum pulse on or off time as determined by the power sensor pulse width specification.*

2.4.8 Measurement Collection Modes

Using a wide range of CW and Peak Power Sensors and the GPIB fast measurement collection modes, the Series 8650A meters provide typical reading speeds of >1750 readings per second in the free-run Swift mode, 800 readings per second in the Fast Modulated mode, and >26,000 readings per second in the Fast Buffered mode. Three Swift mode triggering controls are available: Fast free-run, Bus triggered, and TTL triggered modes. Bus and TTL allow triggering control of individual measurement points. Data can be stored in an internal data buffer or read immediately.

Fast buffered power readings are internally buffered for readout at the completion of the fast buffered interval. Maximum measurement rate is about 26,000 readings per second. Data conversion and GPIB communication time are not included in this figure. The maximum buffer size is 5000 readings, or about 2.1 seconds at the maximum reading rate.

2.4.8.1 CW Mode

This mode is for measuring an unmodulated Continuous Wave (CW) signal. In this mode the RF signal level must be constant for accurate readings to be made. If the signal level changes, a settling time for the internal digital filter is required in order for measurements to be made to the specified accuracy.

The settling time (the time required for a measurement based on an averaging of samples to adapt to a changed condition and become accurate again) is affected by various factors. The maximum settling time is equal to 20 ms multiplied by the averaging factor (for example, if the averaging factor is 128, the maximum settling time is 2.56 seconds). In most situations the actual settling time is well below the maximum.

2.4.8.2 PEAK Mode (80350A Peak Power Sensor)

The Peak mode is for instantaneous peak measurements of the RF power level of a pulse modulated signal during pulse ON periods. The measurement is based on an instantaneous sample taken at a particular point in time. Sampling is triggered by a pulse rising edge either in the modulated signal itself or in a supplied trigger input signal, followed by a programmable delay. The trigger/delay combination makes it possible to specify exactly what part of the pulse is sampled.

In the peak mode, each displayed reading can consist of a single sample or of an average of multiple samples, each taken at the exact same time relative to the pulse's rising edge. If the averaging factor is set to 1, single samples are used. If it is other than 1, the averaging factor will determine the filter settling time over which the multiple samples will be taken and averaged.

Because the peak mode measures the RF power instantaneously (at the top of the pulse, provided that the delay has been set correctly), no assumptions are made about the pulse shape or duty cycle. In fact, it is possible to profile the pulse by sweeping the delay time over a range of values to reveal the pulse shape from start to finish.



NOTE: *In the peak mode the 8650A does not know where the peak is. It samples the pulse where it is told to sample the pulse whether or not the point sampled is really the peak point. This mode is therefore less intelligent than the BAP mode and must be used carefully, but its flexibility makes it a powerful tool for studying modulated signals.*

Series 8650A Universal Power Meters

Peak power measurements are made by sampling the RF input at a point which is defined by a trigger level, a delay, and a delay offset (See Figure 2-17). The initial triggering event occurs when the power input (or in the case of external triggering, a voltage input) reaches a threshold, which have been defined as the trigger level by the user. The sample is then taken after a delay, which have been defined by the user. To this delay can be added a positive or negative delay offset.

The delay offset is not necessary for peak measurement, but in some applications it is a convenience. For example, a small offset (even a negative offset) might compensate for the difference between the trigger point and some other point of interest (such as the half-power point) especially in applications where pulse width is being measured. Or if it is necessary to measure the levels of various pulses within a pulse train, the pulses can be sampled successively by changing the delay offset. A fixed delay insures that each pulse is sampled at the same point in its cycle.

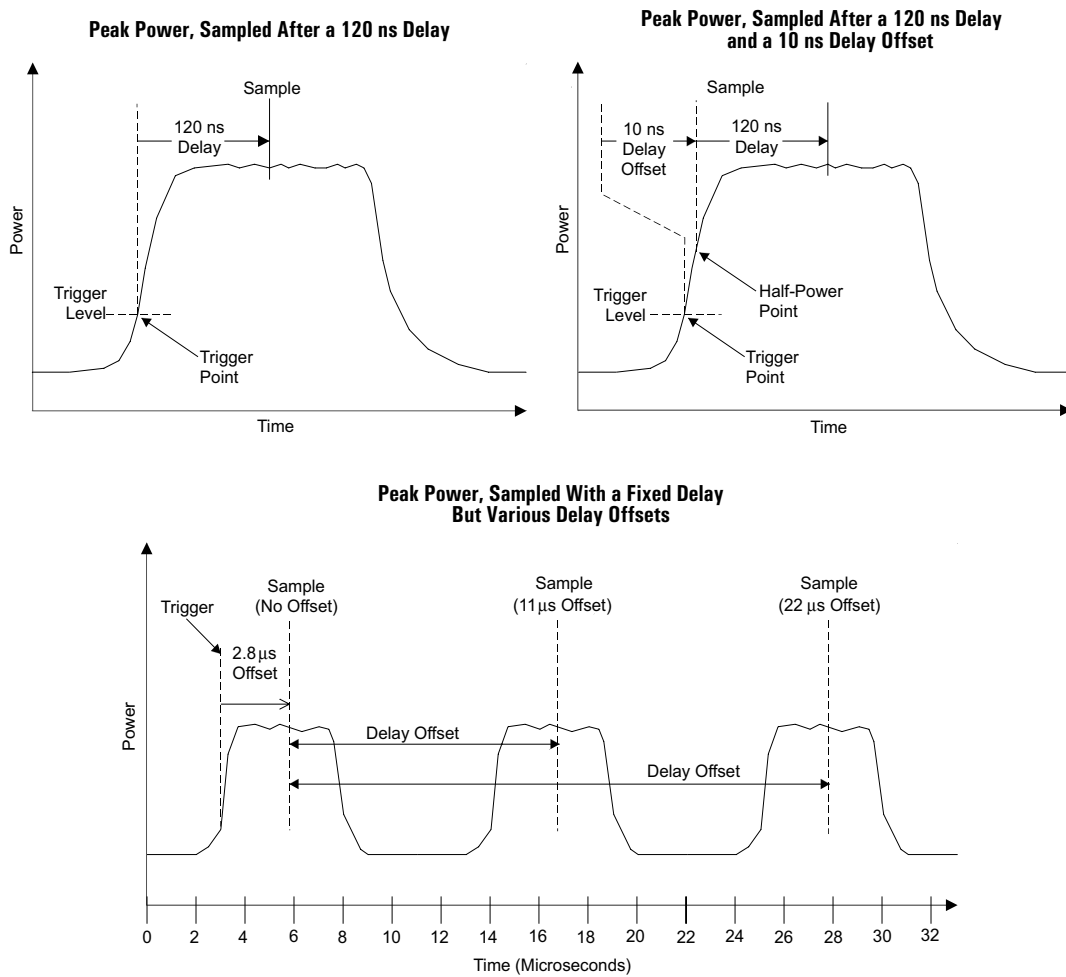

Figure 2-17: Delay & Delay Offsets

2.4.9 Mode Restrictions

In certain modes the 8650A has highly specific restrictions on its operation:

- In the fast measurement collection modes (swift and fast buffered), it is not possible to make measurements which compare the two channels. In other words, it is possible to make measurements using sensor A, or B, or both, but measurements such as A/B and A-B are not permitted.
- In GPIB remote operation, only one reading can be sent over the bus (it can be A, or B, or a comparative measurement such as A/B, but it is not possible for separate measurements of A and B to be sent over the bus). The exception is that in the swift and fast buffered measurement collection modes, it is possible for both A and B to be sent over the bus.

2.4.10 When to use CW, MAP & BAP

For measuring signals with any kind of modulation, MAP mode should be used. In this mode, the 8650A makes use of its digital signal processing algorithms to ensure that the reading is the correct average power level regardless of modulation type (See Section B.2.2 for limits on modulation rate, etc.).

CW signals may also be accurately measured in MAP mode. CW mode offers a few more dB of dynamic range at low power levels when using a CW power sensor, such as the 80301A. In addition, in CW mode the 8650A's form, fit and function are compatible with its predecessor, the 8540.

BAP mode should be used only for the measurement of signals which are pulse modulated. In this mode the meter will accurately measure the average power of the signal during the on-time of the pulse. This mode works equally well regardless of whether the signal is modulated during the pulse on time.

2.4.11 Multi-Tone Tests

Multi-tone testing refers to more than one RF carrier combined into one signal to be measured. Two-tone intermodulation testing, for example, is a common test performed on a wide variety of RF components and subsystems. MAP mode should be selected for these applications. The 8650A test procedure is as follows:

1. Calibrate the sensor according to the procedure outlined earlier in Section 2.4.3.
2. From the Main Menu press [*Sensor Setup*]. From the Sensor Setup menu, press [*Modulated Sensor*] and then select the MAP mode by pressing [*MAP*].
3. Press [*FREQ*] and enter the operating carrier frequency.
4. Connect the sensor to the multi-tone source and record the power level.

Series 8650A Universal Power Meters

For two-tone testing, small errors in the measurement will result when the carriers are separated by more than the specified bandwidth of the sensor. The amount of error is also a function of average power level. For average power less than about -20 dBm, there is no modulation-induced measurement error at any tone separation. Consult the error charts found in Section B.2.2.

Multi-carrier testing usually refers to more than two carriers combined into one signal. Common multi-carrier tests combine multiple carriers. In determining expected measurement error for these types of signals, the maximum difference in frequency between any two carriers should be used as the tone separation when applying the error charts in the manual.

Another important feature of multi-carrier signals is that they can have a high peak-to-average power ratio. This ratio can be as high as 10 dB for multiple carriers. The significance of this in terms of making power measurements is two-fold. First, care should be taken to keep the peak power level applied to the sensor below the maximum recommended level. Second, when trying to minimize modulation-induced measurement error for carriers separated by more the specified bandwidth of the sensor, it is the peak power level that should be kept below about -20 dBm.

2.4.12 Peak Hold

When the Peak Hold feature is selected, the 8650A displays the highest instantaneous power measured from the time the feature is enabled until it is reset by the user. In other words, the displayed value tracks the measured value only when the measured value is rising to a new maximum. When the measured value falls, the displayed value holds at the maximum. When the peak hold feature is reset, the displayed value falls to the current measured value and the process begins again.

When the Peak Hold feature is selected, the minimum average power level that can be accurately measured is -20 dBm. Beginning in firmware version 1.51, this has been implemented to increase accuracy and maintain wide bandwidth of Peak Hold measurement over the peak power range of -20 dBm to +20 dBm. The Peak Hold selection will also affect Histogram measurement if there is power below -20 dBm. To obtain accurate average power measurements below -20 dBm, remove the display line containing Peak Hold (or, in remote control, by sending the command which disables the Peak Hold feature).

The Peak Hold feature is available in the MAP, PAP and BAP measurement modes; it may be enabled from the front panel under the Display Data Line Configuration setup menu, or over the GPIB. Peak Hold is reset by pressing *[Reset Line n]* (or, in remote control, by sending the command which activates the Peak Hold feature). The reset function controls the time resolution of the reading (that is, for finer resolution, reset more frequently).



NOTE: *[Reset Line n]* for Peak Hold also resets the Crest Factor.

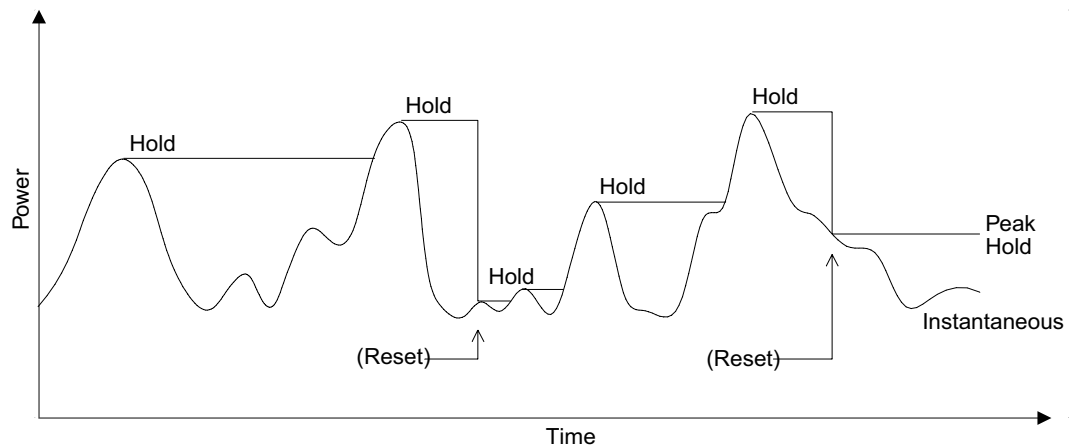

Figure 2-18: Peak Hold

2.4.13 Crest Factor

The Crest Factor feature is very similar to the peak hold feature, in that it holds on to the maximum level until a reset occurs, but in this case the displayed value is expressed (in dB) as a ratio of the held maximum power to the *average* power.

The Crest Factor feature is available in the CW, MAP, PAP or BAP modes only. It can be enabled from the front panel under the Display Data Line Configuration setup menu, or over the GPIB. The Crest Factor feature is reset by pressing [Reset Line *n*] of the appropriate line or, in remote control, by sending the GPIB command which activates the Crest Factor feature (See Section 3.8).

In Figure 2-19, the same power input trace is used in two graphs to illustrate the effect of a drop in average power, with and without a reset. In the top graph, the power drop is followed by a reset. The held value drops to the current measured value, and the crest factor represents the ratio between the new maximum level and the new average level. In the bottom graph, there is no reset after the power drop, and the crest factor represents the ratio between the old maximum level and the new average level. For this reason, the crest factor feature should be reset after an input power level change.

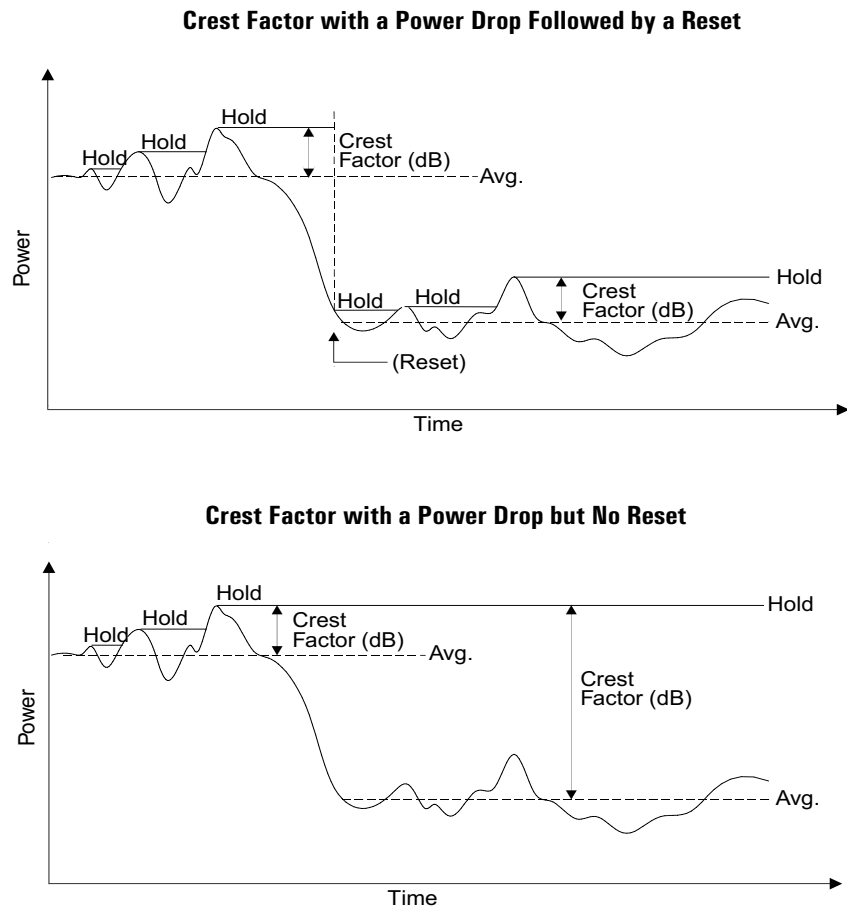

Figure 2-19: Crest Factor

Like the Peak Hold feature, the Crest Factor feature also has the same minimum average power level restriction of -20 dBm. Beginning in firmware version 1.51, this has been implemented to increase accuracy and maintain wide bandwidth of Crest Factor measurement over the peak power range of -20 dBm to +20 dBm. The Crest Factor selection will also affect Histogram measurement if there is power below -20 dBm. To obtain accurate average power measurements below -20 dBm, remove the display line containing Crest Factor (or, in remote control, by sending the command which disables the Crest Factor feature).



NOTE: *[Reset Line n] for the Crest Factor also resets Peak Hold.*

2.4.14 Burst Signal Measurements

In a burst signal, the RF is pulsed on and off (i.e., pulse modulated). Often, the RF is modulated during the pulse on time. Typical examples are TDMA digital cellular telephone formats such as NADC, PDC, and GSM. These formats and many others produce amplitude modulation of the RF during bursts.

Two types of power measurement can be made on these types of signals. If the total average power is desired, MAP mode should be used. Total average power includes both the off and on time of the pulses in the averaging. Often it is desired to know the average power just during the bursts. BAP mode makes this type of measurement very easy. The procedure is as follows:

1. Calibrate the sensor according to the procedure outlined earlier in this section.
2. From the Main Menu press *[Sensor Setup]*. From the Sensor Setup menu, press *[Modulated Sensor]* and then select the BAP mode by pressing *[BAP]*.
3. Press **[FREQ]** and enter the operating carrier frequency.
4. Connect the sensor to the burst signal source and record the power level.

The 8650A will automatically find the portions of the signal which are in the burst and include only those portions in the average.

Burst signals can have a high peak power-to-average power ratio depending on duty cycle. This ratio is proportional to the duty cycle and is given by:

$$10 \cdot \log \left(\frac{\text{Duty Cycle [\%]}}{100} \right)$$

This assumes no modulation during the burst. Modulation during the burst will increase this ratio by its own peak-to-average ratio. Due to this characteristic of burst signals, care must be taken to keep the peak power below the maximum rated input power of the sensor.



NOTE: *If the burst average power is too low or if the bursts on time or off time between the bursts are too narrow, the 8650A may lose sync with the bursts and fail to display the burst average power. When this happens, **NoSync** will flash on the screen to the right of the sensor power units, and the meter will display total average power as in MAP mode. The conditions under which the 8650A may lose sync are listed in the following Sections 2.4.15 and 2.4.16 and also in the minimum pulse width specifications in Section B.2.2 for the modulated sensor used.*

2.4.15 Burst Start Exclude, Burst End Exclude

When measuring burst signals, it is sometimes desirable to mask the beginning or the end of a burst so that overshoot and other distortions do not affect the reading.

The Burst Start Exclude and Burst End Exclude features make it possible for BAP mode measurements to exclude the beginning or the end of a burst in this way. Both features can be used simultaneously, but this requires caution: if the excluded periods overlap, there is nothing left of the burst to be measured. If the entire burst is excluded, **NoSync** will flash on the screen to the right of the sensor power units, and the meter will revert to average measurement in the style of the MAP mode.

The start exclude time is selected from a series of discrete values from 0.000 ms to 45.548 ms in increments of 0.027 ms. The end exclude time has the same discrete values available except the maximum time value is limited to 31.960 ms when burst dropout time is 0.000 ms. For non-zero values of burst dropout time, the maximum value of end exclude time is limited to 3.423 ms minus the burst dropout time setting.

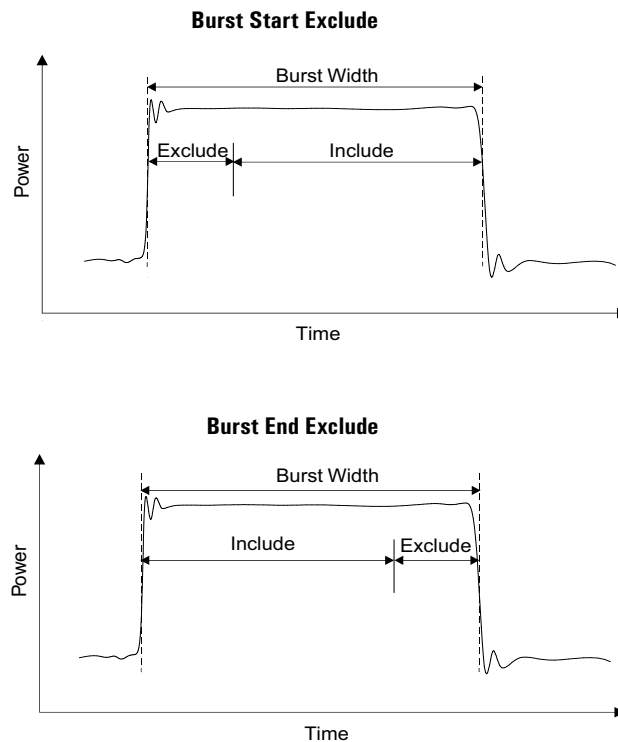

Figure 2-20: Burst Start Exclude & Burst End Exclude

2.4.16 Burst Dropout

In the BAP mode, average power is measured only during bursts. Because, in this mode, the bursts are automatically detected by the power meter, the user need not be aware of the burst repetition rate in order to make the measurement.

However, the BAP measurement algorithm defines bursts in a way which may be considered undesirable in some applications. In the example illustrated below, a 3.5 ms burst is followed by an OFF period of the same duration. During the burst, two brief dropouts occur. Normally, in BAP mode, each dropout would be interpreted as the end of a burst; the BAP algorithm would interpret the burst as three separate bursts, and the dropouts would be excluded from the average power measurement. As a result, the average power reading would be artificially raised.

When the Burst Dropout feature is enabled, the BAP algorithm is modified so that a dropout of sufficiently brief duration is not interpreted as the end of a burst. In the example below, dropout time is specified at 350 μ s. The two dropouts, which occur during the burst have a duration of less than 350 μ s; therefore the entire burst is interpreted as a single burst, and the dropouts are included in the average power measurement. The 3.5 ms OFF period following the burst is interpreted as the end of the burst, because it exceeds 350 μ s in duration.

This feature must be configured and interpreted with care. The dropout time is selected from a series of discrete values from 0.000 ms to 3.746 ms in increments of 0.027 ms when end exclude time is 0.000 ms. For non-zero values of end exclude time, the maximum value of burst dropout time is limited to 3.423 ms minus the end exclude setting. These are only the guaranteed minimum values. In practice, the BAP algorithm may tolerate dropouts up to 2.15 times as long as the minimum value. Therefore, the time between bursts must be at least 2.2 times as long as the selected dropout time (If the time between bursts is less than the tolerated dropout time, the BAP algorithm never recognizes the end of a burst, and the signal is simply averaged, as if the MAP mode had been selected). Also, dropouts occurring at the end of a burst are a problem, because the BAP algorithm cannot distinguish them from the end of the burst itself; there should be at least 250 μ s of burst remaining after the last dropout within that burst.

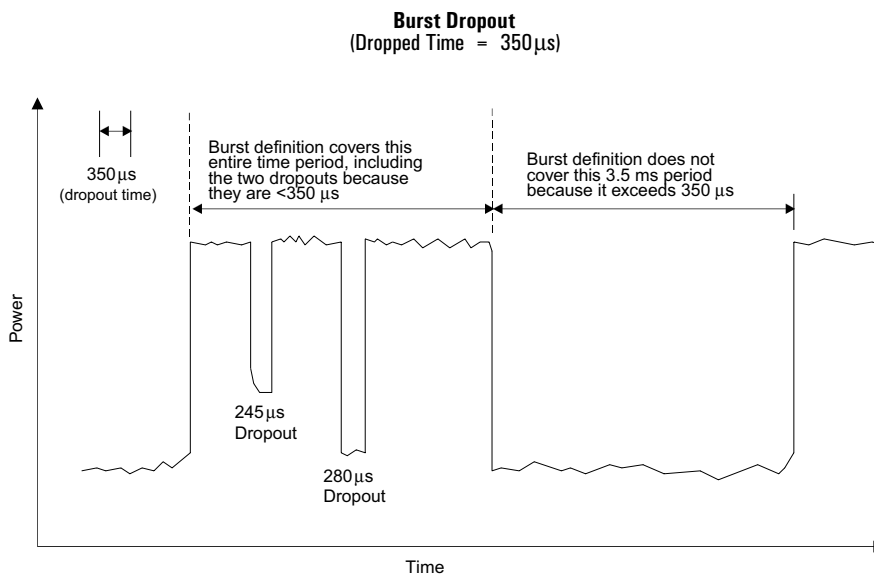

Figure 2-21: Burst Dropout

2.4.17 Optimizing Measurement Speed

In many power measurement situations, measurement speed is defined in terms of settling time following a step change in average power. In other words, it is desired to know the average power level within some specified tolerance as quickly as possible following a power level change. This is often accomplished by setting up the power meter in free-run mode over the GPIB and monitoring the collected measurement data with the host computer until it falls within the predetermined tolerance window.

The Auto average feature of the 8650A eliminates the need for the host computer to do any data monitoring and can be set up to automatically output measurement data when it has settled to within the specified tolerance. This is done by triggering each measurement with a TR2 command and waiting for the meter to signal the host with an SRQ. The SRQ is asserted and the data is put on the bus as soon as the power measurement has averaged long enough to be within the specified tolerance.

The tolerance is specified by including the measurement settling tolerance parameter with an FA command (Auto average on). This parameter is specified in terms of percentage. For example, if a measurement settling tolerance of 1% is specified, the 8650A Auto average algorithm will specify an averaging time just long enough so that the result put on the bus is within $\pm 0.5\%$ (that is, ± 0.02 dB) of the average power. Thus, the settled measurement data is available on the bus in the minimum time necessary to be within the specified tolerance.

The tolerance specified in the FA command is a *target* tolerance. For example, it is possible that the peak-to-peak power variation of the signal being measured is so great that the maximum averaging time of 20 seconds is not long enough to reduce the variation to within the specified tolerance. It is also possible that the rate of power variation is so slow that more than 20 seconds of averaging is required. In these cases, further averaging would have to be done by the host computer.

The following example program shows how to set up a triggered measurement, optimized for speed using the auto averaging feature:

```

Tr2:                                     ! Read using TR2 command
ON INTR 7 GOSUB Srq_interrupt           ! Set up SRQ interrupt
ENABLE INTR 7                           ! Enable SRQ interrupt
OUTPUT 713;*SRE41                        ! Set service request mask
OUTPUT 713;CS                            ! Clear status byte
OUTPUT 713;TR2                           ! Trigger measurement
Data_ready=0                             ! Clear flag
WHILE Data_ready=0                       ! Wait for data ready
END WHILE
RETURN
Srq_interrupt:                           ! SRQ jumps here
State=SPOLL(713)                         ! Get status byte
IF BIT(State,0) THEN                     ! If the Data Ready bit is set...
    Data_ready=1                         ! Set the flag
    ENTER 713;Tr2_reading                ! Read the measurement
    OUTPUT 713;CS                        ! Clear the status byte
    OUTPUT 713;*SRE0                    ! Clear the service request mask
END IF
RETURN
    
```

2.4.18 Peak Power Measurements

Peak power sensors directly measure the amplitude of pulsed microwave signals. The direct sampling technique is more accurate than traditional duty cycle correction methods. The sample position can be displayed on an oscilloscope.

1. Calibrate a peak power sensor and connect it to a pulsed microwave source.
2. From the Main Menu, press **[Sensor Setup]**. From the Sensor Setup menu, select the Peak sensor with the cursor keys.
3. Press **[Config]** to display the Setup mode menu and select **[Peak]**.
4. Select the desired trigger level (for internal or external triggering).
5. Select the desired sample delay (for internal or external triggering).
6. Optionally, set the desired delay offset (for internal or external triggering).
7. Connect the peak power sensor's Detector Out to an oscilloscope to view the sample position. For 80350A Peak Power Sensors, also connect the sensor's Sample Delay output to the oscilloscope and trigger on that channel.

2.4.19 Measuring an Attenuator (Single Channel Method)

Attenuators are useful for many applications. With the 8650A, attenuators can be calibrated quickly and accurately. The single channel calibration procedure outlined below is efficient for calibrating at a single frequency or at a limited number of frequencies.

1. Connect the power sensor to the signal source through a 6 dB attenuator (a matching pad) and adjust the source output power to about 0 dBm. Verify that the source output is stable.
2. Press **[FREQ]** and enter the operating frequency (this step is optional).
3. From the Main menu, press **[Rel]** to set the reference level.
4. Insert the attenuator to be calibrated between the matching pad and the power sensor.
5. Record the attenuator value.

2.4.20 Improving Accuracy

Mismatch uncertainty is the largest source of error in power measurement. The 6 dB pad that is used in the attenuator calibration procedure above reduces mismatch uncertainty by effectively improving the return loss (or reducing the SWR) of the source. Mismatch uncertainty is large when a device has a poor impedance match relative to 50 Ω .

Poorly matched devices reflect a large proportion of incident signals and create standing waves along the transmission line. At various points along the transmission line, the standing wave will be at maximum or minimum amplitude. Mismatch uncertainty is a measure of the deviation between these amplitude levels.

Inserting an attenuator into the transmission line reduces mismatch uncertainty by reducing the amplitude of the reflected signal, thereby reducing the difference between a standing wave's maximum and minimum levels.

Compared to an attenuator, most microwave sources have poor impedance matching. Using the 6 dB attenuator during the calibration has the effect of lowering the SWR of the microwave source. The only compromise is a corresponding 6 dB reduction in the source's dynamic range when the 6 dB attenuator is attached.

2.4.21 Performance Verification

Verifying accuracy and calibrating test equipment are essential to microwave engineers and technicians. Accurate, repeatable measurements are required for validating designs, certifying calibrations, making engineering decisions, approving product components, certifying standards and verifying performance specifications (See also Chapter 4).

1. A 6 dB attenuator is placed at the input port of a power splitter to provide a good impedance match from the source. This effectively reduces the VSWR of the source. Depending on the signal quality of your source over frequency, additional attenuation may be desirable. A two-resistor power splitter provides consistently matched power levels at its output ports, X and Y. The largest sources of error are power splitter tracking errors and mismatch uncertainty.
2. Connect the reference standard power meter to power splitter output X, and the power meter to be verified to splitter output Y.
3. Adjust the source frequency to a standard reference frequency (50 MHz for 803XXA and 804XXA series sensors, or 1 GHz for 806XXA and 807XXA series sensors).
4. Enter the operating frequency or frequency cal factors into the power meters.
5. Adjust the source amplitude to the maximum sensor operating level (+20 dBm for standard sensors).
6. Zero each power meter and record the measurement values immediately after settling.
7. Adjust the source for +19 dBm output level and repeat Step 6.
8. Continue testing at 1 dB increments through the rest of the standard sensor's 90 dB dynamic range.
9. Calculate measurement uncertainty and compare the measured results to the specified tolerances.

At low power levels, be sure to zero the sensor prior to taking measurements. At levels below -55 dBm, the measurements should be recorded just after zeroing is completed. The zeroing process must be repeated periodically, depending on the operating level, due to drift characteristics.

2.4.22 Sources of Error

In the previous accuracy verification procedure, there are four sources of error:

- Source output level variation
- Power splitter output tracking
- Power meter X total measurement uncertainty
- Power meter Y total measurement uncertainty

Worst case uncertainty, which should be used for calibration purposes, is the arithmetic sum of all four of these sources of error.

Source output level variation occurs in all microwave sources. This happens when the signal source output level changes during the time it takes to record the displayed value on power meter X and then to read the displayed value on power meter Y. This source of error can be minimized by using a laboratory grade signal source.

Power splitter output tracking errors are the maximum signal level variation at the splitter X output as compared to the splitter Y output.

Total measurement uncertainty for each of the power meters is the worst case combination of mismatch uncertainty, instrument accuracy, and sensor accuracy.

Mismatch uncertainty is calculated from the reflection coefficients of the sensor and the splitter (source) according to the following formula:

$$M (dB) = 20 \log_{10} [1 \pm (\rho_{SENSOR}) (\rho_{SOURCE})]$$

$$\text{where } \rho = \frac{VSWR - 1}{VSWR + 1}$$

For a source mismatch specified in terms of return loss (RL), the equation should be modified according to:

$$\rho_{SOURCE} = 10^{\frac{RL}{20}}$$

$$\text{where } \rho = \frac{-RL (dB)}{20}$$

The following factors affect instrument accuracy:

- Instrument linearity or instrumentation uncertainty
- Reference calibrator setability or power reference uncertainty

The following factors affect sensor accuracy:

- Calibration factor uncertainty
- Calibrator to sensor (or power reference to sensor) mismatch uncertainty
- Noise
- Zero set
- Calibration pad uncertainty (for thermal-based power meters only)
- Sensor linearity

Series 8650A Universal Power Meters

Remote Operation

3.1 Introduction

The Series 8650A can be operated from a remote host over the General Purpose Interface Bus (GPIB) using either Standard Commands for Programmable Instruments (SCPI) or IEEE Standard 488-1978 (Digital Interface for Programmable Instruments) commands. Table 3-1 shows which functions of the IEEE 488 standards are implemented in the 8650A.

Table 3-1: Implemented IEEE Standards

Function	8650A Implementation
Source Handshake	SH1 (complete capability)
Acceptor Handshake	AH1 (complete capability)
Talker	T5 (basic talker, serial poll, talk only mode, unaddressed if MLA)
Extended Talker	TE0 (no capability)
Listener	L3 (basic listener, listen only mode, unaddressed if MTA)
Extended Listener	LE0 (no capability)
Service Request	SR1 (complete capability)
Remote/Local	RL1 (complete capability)
Parallel Poll	PP1 (remote configuration)
Device Clear	DC1 (complete capability)
Device Trigger	DT1 (complete capability)
Controller	CO (no capability)

3.1.1 Sending Commands to the 8650A

The 8650A power meter uses standard protocols for communication over the GPIB. Commands conform to IEEE 488.1 or IEEE 488.2 guidelines. Four emulation modes (Giga-tronics 8540, HP436, HP437 and HP438) are available for users of power meters who cannot rewrite their application software.

The program examples in this chapter are written in HTBasic™ format (HTBasic is a trademark of TransEra Corporation). Other languages would use different commands but the string that is sent or received will always be the same. In HTBasic, the **OUTPUT** command sends a string to the GPIB. The number after **OUTPUT** is the GPIB address of the instrument.

The factory-set default address of the 8650A is 13 and the address of the GPIB is assumed to be 7; therefore, examples of command strings in this publication are preceded by **OUTPUT 713**.

Series 8650A Universal Power Meters

3.1.1.1 Clear Device

The interface command **CLEAR 713** resets the GPIB and sets the 8650A to its preset condition.

3.1.1.2 Clear Interface

The interface command **ABORT 7** resets the GPIB without resetting the 8650A to its preset condition. The 8650A will not be addressed after the abort.

3.1.1.3 Local & Remote Control

The interface command **LOCAL 713** places the 8650A into the local control mode.

The interface command **REMOTE 713** places the 8650A into the remote control mode. Enter LOCAL 713 to return the instrument to local mode.

The interface command **LOCAL LOCKOUT 7** places the 8650A in the local lockout mode. This is a remote control mode in which all of the 8650A front panel keys are disabled. The **GPIB LOCAL** command must be issued to return the 8650A to local mode (Disconnecting the GPIB cable will also return the instrument to local mode).

3.1.1.4 Sensor Selection & Calibration

Power sensor selection data, specifications and calibration (local and remote) are contained in Appendix B of this publication.

3.1.2 Polling

The GPIB supports parallel and serial polling. The example programs below show how to use the parallel and serial poll capabilities of the 8650A to determine when a requested zeroing operation is completed.

3.1.2.1 Parallel Polling

```

Ppoll_zero                                ! zero using parallel poll
PRINT entering parallel poll zero routine
PPOLL CONFIGURE 713;8                      ! configure response on bit zero
OUTPUT 713;CS AEZE                          ! clear status byte, zero channel A
State=0                                    ! initialize variable
WHILE State 1                               ! stay here until zero done
    State=PPOLL(7)                          ! read the poll
    END WHILE PPOLL UNCONFIGURE 713         ! cancel parallel poll mode
PRINT parallel zero done RETURN
    
```

3.1.2.2 Serial Polling

```

Srql_zero:                                ! zero with an srq interrupt
PRINT entering SRQ interrupt zero routine
ON INTR 7 GOSUB Srq_interrupt
OUTPUT 713;CS                              ! clear status byte
ENABLE INTR 7;2                            ! enable srq interrupts
OUTPUT 713;@1;CHR$(2)                      ! enable srq handshake
OUTPUT 713;AEZE                            ! execute zero command
Flag=0                                     ! test flag reset to false
    WHILE Flag=0                            ! stay here until test flag set true
        WAIT 1
        PRINT Still inside while loop
    END WHILE
PRINT SRQ interrupt zero done
RETURN
Srql_interrupt:                            ! SRQ interrupts jump here
PRINT an SRQ interrupt has occurred
Example: OUTPUT 713;CS                    ! clear status byte
Flag=1                                     ! set control flag true
RETURN
    
```

3.1.3 Data Output Formats

The data output format for the standard measurement collection mode is:

±D.DDDDE±NNCRLF

±: Sign of the Mantissa
D.DDDD: Mantissa (5 digits)
E: Exponent (indicates that an exponent follows)
±: Sign of the Exponent
NN: Magnitude of the Exponent
CR: Carriage Return
LF: Line Feed

Data output formats for the swift and fast buffered modes are expressed in the form of a signed five-digit number with two digits to the right of the decimal and no exponents. In some cases multiple values are sent:

One sensor swift mode: ±DDD.DD CRLF
Two sensor swift mode: ±DDD.DD, ±DDD.DD CRLF
Fast buffered mode: ±DDD.DD, ±DDD.DD CRLF

3.1.4 Power-On Default Conditions

The interface wake-up state is:

- GPIB Local Mode
- Unaddressed, Service Request Mask Cleared
- Status Byte Cleared
- TR3 Free Run Trigger Mode Set
- GT2 Group Execute Trigger Mode Set
- Parallel Poll Data Lined Unassigned
- Display Enabled
- Service Request Mask Cleared
- Event Status Register = 128
- Event Status Mask Clear

3.2 SCPI Command Interface

This section details operation of the 8650A power meter using the SCPI (Standard Communications for Programmable Instruments) interface commands. A SCPI command reference is presented in Table 3-3 and the sections that follow.

SCPI commands promote consistency in definition of a common instrument control and measurement command language. The structured approach of the SCPI standard offers test system design engineers a number of system integration advantages that achieve considerable efficiency gains during control program development.

SCPI compatible instrument commands are structured from a common functional organization or model of a test instrument (See Figure 3-1). Most of the power meter configuration and measurement functions fall within the Measurement Function Block and the Trigger Subsystem of the SCPI instrument model.

The 8650A uses the Sense Subsystem of the Measurement Function Block to implement commands that apply specifically to the individual power sensors; sensor 1 and sensor 2. For example, the SENSE2:CORRection:OFFSet command corrects for the attenuation of a signal that passes through an attenuator or coupler before it is measured by power sensor 2. Figure 3-1 illustrates the SCPI subsystem model.

NOTE: Throughout this publication, some commands will be in both upper- and lower-case, such as CALCulate and MEMory. The uppercase is the required input. The whole word can be used if desired. If the whole word is used, it must be used in its entirety. For example, CALCulat will not be recognized as a valid command.

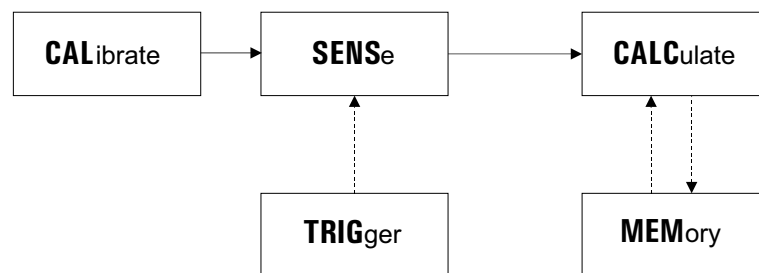

Figure 3-1: SCPI Subsystem Model

3.2.1 Sensor Calibration & Zeroing

The Calibration subsystem performs sensor calibration and zeroing. CALibrate:STATe selects if the calibration data is applied or not. If STATe is ON, then the instrument uses the calibration data for correction. If STATe:OFF is selected, then no calibration using the calibration data will be made. The CALibrate:ZERO subsystem controls the autozero calibration of the sensor.

3.2.2 Sensor & Channel Configuration

The Calculate subsystem of the Measurement Function Block contains commands that define the form of the measured data from sensor 1 and sensor 2. Calculate commands define the configuration of the two Software Calculation Channels. For example, the CALC1:POW 1 command configures channel 1 to report the power level as measured by sensor 1. CALC2: RAT 2,1 configures channel 2 to report the ratio of power levels, sensor 2 over sensor 1.

Series 8650A Universal Power Meters

3.2.3 Measurement Triggering

The power meter uses the Trigger Subsystem to trigger measurements in two different operational modes - a normal mode which maximizes the instrument's functionality, and swift and burst modes that maximize the power measurement rate.

3.2.4 Memory Functions

The MEMory commands control the configuration of the automated Voltage-Proportional-to-Frequency ($V_{PROP}F$ or VF), sensor Cal Factor correction, and the analog outputs on the rear panel. Each of these connectors is used with external devices. The $V_{PROP}F$ can be configured to match the $V_{PROP}F$ output of the microwave source. The analog outputs are used with a variety of devices including chart recorders, oscilloscopes, voltmeters and microwave source leveling inputs.

3.2.5 IEEE 488.2 Required Commands

Consistent with SCPI compliance criteria, the power meter implements all the common commands declared mandatory by IEEE 488.2 (See Table 3-2).

Table 3-2: IEEE Required Command Codes

Mnemonic	Name
*CLS	Clear Status Command
*ESE	Standard Event Status Enable Command
*ESR?	Standard Event Status Register Query
*IDN?	Identification Query
*OPC	Operation Complete Command
*RCL	Recall Command
*RST	Reset Command
*SAV	Save Command
*SRE	Service Request Enable Command
*STB?	Read Status Byte Query
*TRG	Trigger Command
*TST?	Self-Test Query
*WAI	Wait-to-Continue Command

3.2.6 Calculate Subsystem Commands

Calculate commands specify and query the configuration of power measurement channels, known in SCPI references as Software Configuration Channels, and in this publication as “channels”. See Section 3.2.7 for sensor-specific configuration and measurement function control.

The query form of `CALC#?`, with # replaced by the channel modifier (1 or 2), returns the current configuration status for that channel. This verifies configuration commands or return current status information following data acquisition or power measurements.

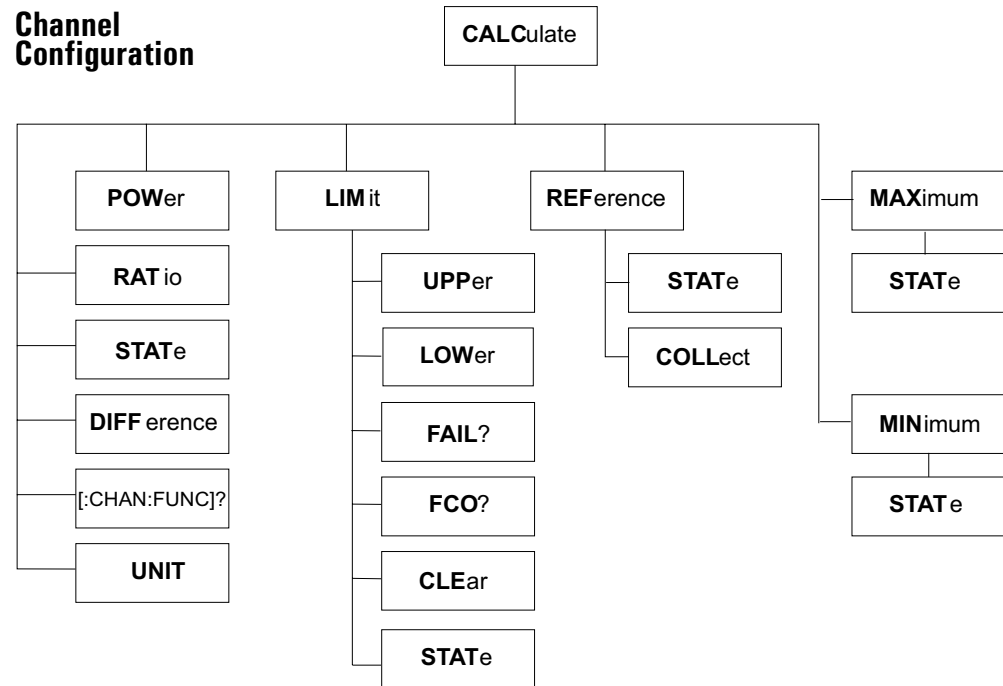

Figure 3-2: CALCulate Subsystem Commands

Limit Lines are set on a channel basis. These commands set limits, monitor the number of violations, and allow the violation counter to be cleared.

The REFerence command allows channel-based offset values. For example, using `CALC#:REF:COLL` automatically converts the inverse of the current channel measurement value to an offset — simplifying the 1 dB compression testing of amplifiers.

MIN and MAX commands monitor deviation of measured values over a user controllable time period.

The two software calculation channels can individually and simultaneously perform the internal instrument functions that calculate final measurement data. The final measurement data is calculated from Sense subsystem sensor data as well as the Calculate subsystem channel configuration data.

This means that only two measurement configurations can be obtained from the 8650A simultaneously. For example, the controller can obtain measurements for sensor 1 plus sensor 2/sensor 1 simultaneously, but not sensor 1 plus sensor 2 plus sensor 2/sensor 1 simultaneously.

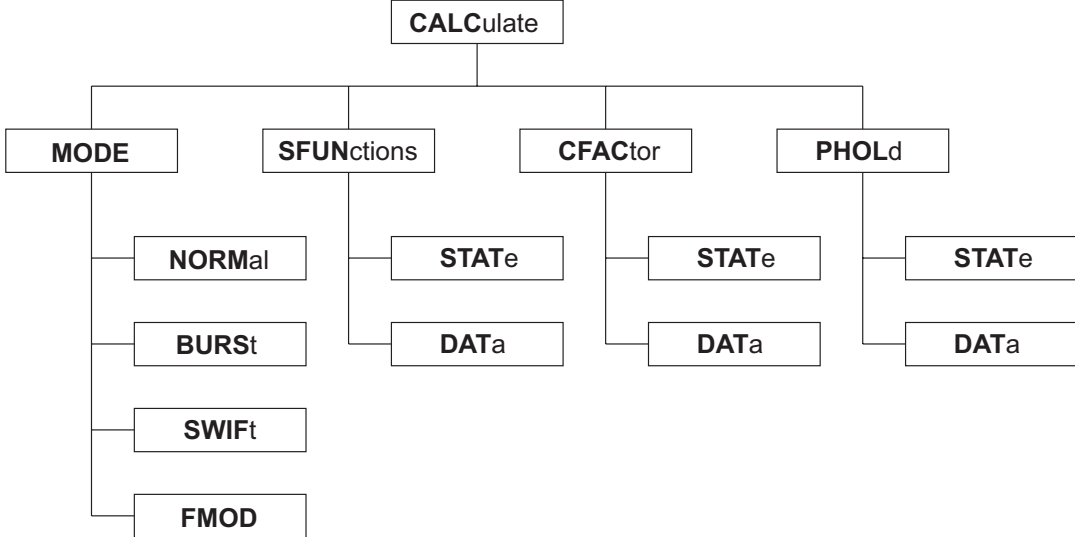

Figure 3-3: Additional CALCulate Subsystem Commands (Modulation Sensors)

3.2.7 Sense Subsystem Commands

The Sense subsystem configuration commands, illustrated in Figure 3-4, apply to individual sensors. These commands alter the value of the measured power level according to the sensor's characteristics. For example, measured power levels can be offset for attenuators or couplers in the measurement path so that the power data reading reflects the power level at the measurement point of interest.

Use the Sense subsystem commands for:

- Averaging power measurements in the 8650A
- Offsetting power measurements for attenuation or amplification
- Entering the operating frequency of the measured signal computes and applies sensor specific Calibration Factor corrections, which compensates for sensor frequency response characteristics
- Controlling Peak Power Sensor triggering
- Controlling Modulation Power Sensors

Sense subsystem commands control functions that are related directly to the individual power sensors. For example, these commands control items that would not apply to numerical alteration of a ratio measurement of Sensor1/Sensor2. Controls that would apply to that type of a configuration are channel functions, not sensor functions, and would therefore be located in the Calculate subsystem.

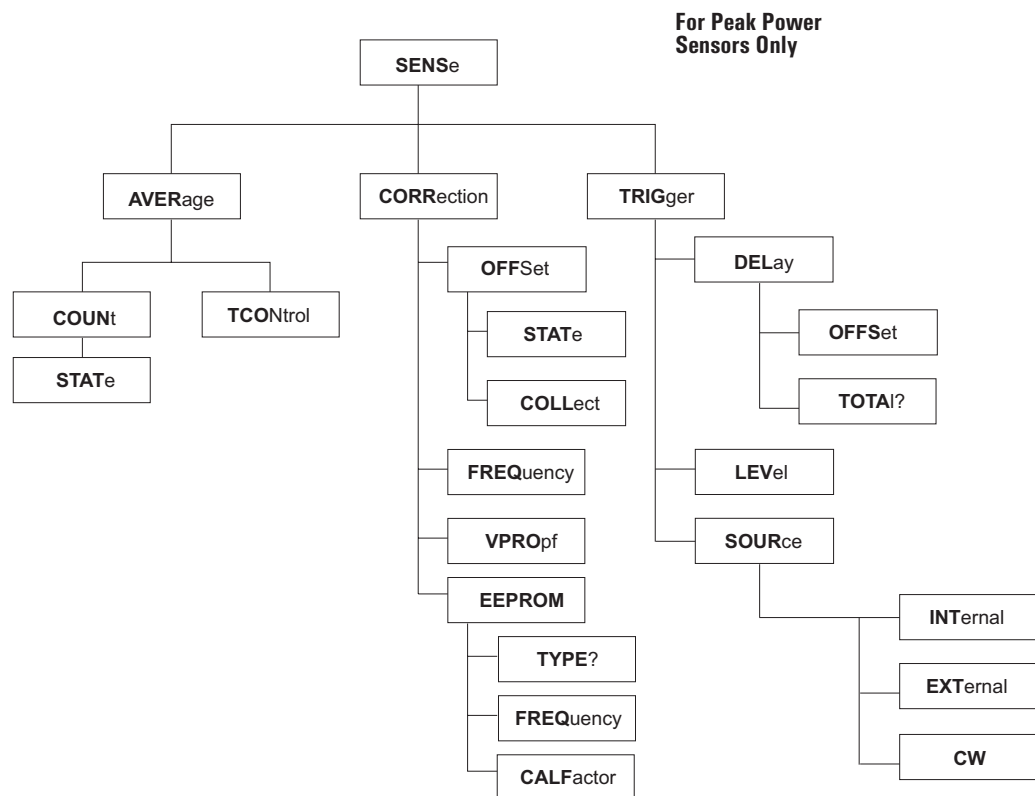

Figure 3-4: SENSE Subsystem Command Tree

SENSE:AVERage functions control the number of data samples for each measurement and the manner in which those numbers are accumulated. COUNT determines the averaging number or AUTO-averaging. TCONtrol determines whether each new sample is added to previous COUNT # of samples or if COUNT # of samples are taken each time the 8650A is triggered. Please note that the SENSE:TRIGger commands are not instrument triggers, but Peak Power Sensor configuration controls.

Series 8650A Universal Power Meters

SENSe:TRIGger functions apply only to Giga-tronics Peak Power Sensors. The DELay and LEVel functions of these Peak Power Sensor controls apply to the 80350A Peak Power Sensors. The AVERage and CORRection commands apply to all 803XXA Series CW & Peak Power Sensors.

STATe ON OFF controls for COUNT and DELay, previous page, are not shown.

3.2.8 Trigger Subsystem Commands

The Trigger Subsystem is divided into two sections; Instrument Measurement Event Triggering and Special Triggering Configuration commands for the fast-reading buffered data modes (Burst and Swift modes). The Trigger command tree is illustrated in Figure 3-5.

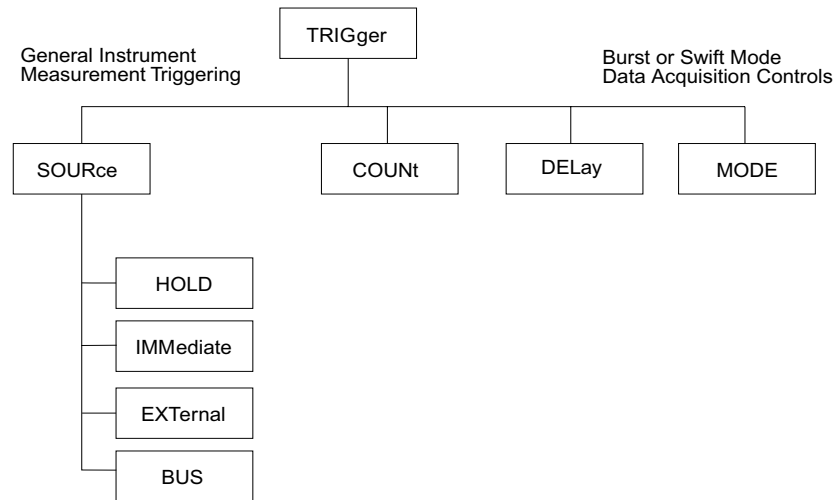

Figure 3-5: TRIGger Subsystem Command Tree

The query form of these commands, TRIGger? with the appropriate modifier inserted ahead of the ?, will return the instrument's current configuration status. This can be used to verify triggering configuration or return status information following command errors which are commonly caused by using illegal configuration commands during Swift or Burst Modes.

SOURce:IMMediate triggering allows the 8650A to control measurement triggering; this is the default configuration. External triggering is performed using a TTL signal input. BUS allows software controlled triggering.

COUNT refers to the number of data points to store in the meter's 5000 reading buffer (128,000 with option 02) before the measurement data is requested by the controller.

DELay controls the time interval between Burst Mode data samples, and the MODE command controls whether the data is taken after receipt of the instrument trigger or if data is collected (in a FIFO buffer) immediately preceding receipt of an instrument trigger.

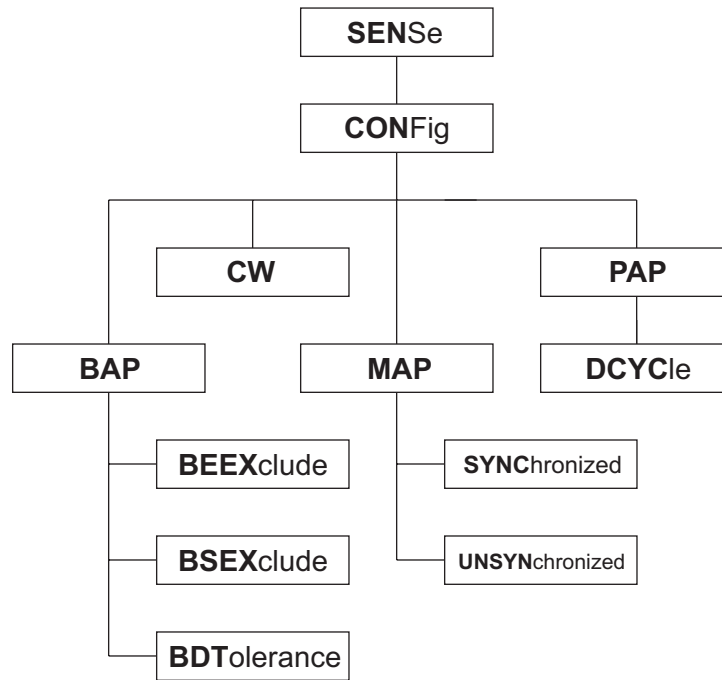

Figure 3-6: SENSE Subsystem Command Tree for Configuring Modulation Sensors

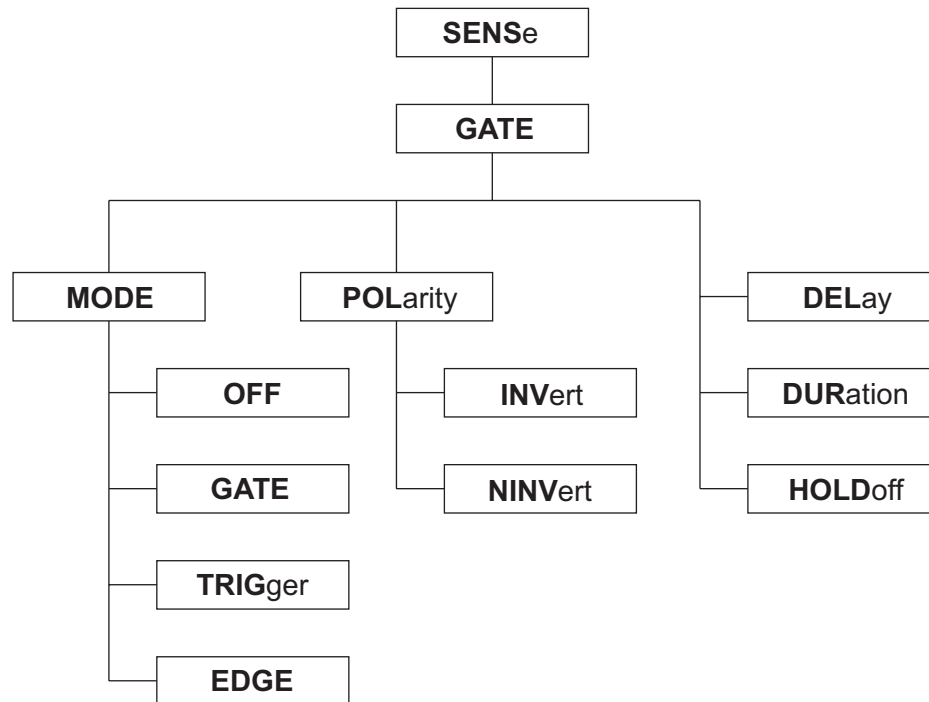

Figure 3-7: SENSE Subsystem Command Tree for Configuring Modulation Sensor Gate Setting

3.2.9 GPIB Command Syntax

The following conventions are used with the GPIB commands in this publication. Some commands will be in both upper- and lower-case, such as CALCulate and MEMory. The uppercase is the required input. The whole word can be used if desired. Table 3-3 lists in alphabetical order all of the GPIB commands supported by the power meter. The basic function performed by that command is given, and the page number of this chapter where a description of each command can be located.

3.2.9.1 Commands in Brackets

Commands and command separators within brackets, such as [COMMand:], are optional. These portions of the commands may be used in the program command strings, but are not required for proper operation of the power meter.

3.2.9.2 Programmer Selective Parameters

Command descriptions enclosed in angle brackets (< and >) show the syntax placement of configurable parameters. A description of the necessary parameter and the range of values or mnemonics valid for that parameter are enclosed in angle brackets.

3.2.9.3 Italics in Syntax Descriptions

Some command syntax descriptions show certain words in italics such as *space* and *comma* to indicate where the character must be included within a command string.

3.2.9.4 Query Format

Except where specifically noted, all query commands are formed by adding a question mark (?) to the command header. Be sure to omit command parameters when using the query format. Some commands have only a query format. With the exception of the Calibration queries, query commands will not change the status of the power meter. The CALibration1? and CALibration1:ZERO? commands query respectively to automatically begin the calibration and zeroing process.

3.2.9.5 Linking Command Strings

The 8650A uses ASCII strings for commands. When sending more than one command in a single string, a semicolon must be used as a delimiter between commands. No spaces or other characters are necessary. Use only a semicolon to link commands in a string.

3.2.9.6 Measurement Data Output Format

The examples in this chapter are written in HTBasic™ format. Different languages will use different commands, but the string sent or received will always be the same. In HTBasic, the OUTPUT command sends a string to the GPIB bus. The number or variable after the word OUTPUT is the GPIB address of the power meter.

™HTBasic is a trademark of TransEra Corporation.

Series 8650A Universal Power Meters

Table 3-3: SCPI Command Syntax

Command Syntax	Function	Page
SCPI Required Codes		
*CLS	Clear SRQ and status byte registers	3-46
*ESE	Enable bit 4 of event status register mask	3-46
*ESR?	Returns event status register value	3-46
*IDN?	Query instrument mfg and model number	3-59
*OPC	Allows a one-time SRQ enable	3-27 3-46
*OPC?	Returns a value of 1 after an operation is completed	3-27 3-46
*RCL	Recall 8650A register <i>n</i>	3-55
*RST	Reset 8650A configuration	3-57
*SAV	Save at 8650A register <i>n</i>	3-55
*SRE	Service Request Enable	3-47
*STB?	Query status byte register	3-47
*TRG	BUS Trigger Event	3-29
*TST?	Query self-test result	3-61
*WAI	Wait, following command completion	3-30
SCPI Function Codes		
ABORt	Halts measurement & triggering	3-55
CALCulate < channel 1 to 4 > :CFACtor:STATespace < ON OFF >	Enable/Disable crest factor measurements.	3-33
CALCulate < channel 1 to 4 > :CFACtor:DATA?	Reads the crest factor measurements.	3-34
CALCulate < channel 1 to 4 > [:CHANnel]: differeNcespace < sensor 1 or 2 > :sensor 2 or 1 >	Configures channel 1 to measure Sensor 2 minus Sensor 1 power	3-32
CALCulate < channel 1 to 4 > :DATA?	Query channel 1 & 2 burst mode data	3-37
CALCulate < channel 1 to 4 > [:FUNction]?	Query channel 2 sensor mode	3-33
CALCulate < channel 1 to 4 > :LIMit:CLEar[:IMMediate]	Reset channel 1 limit violation indicator to 0	3-51
CALCulate < channel 1 to 4 > :LIMit:FCOunt?	Query number of channel 1 limit failures	3-51
CALCulate < channel 1 to 4 > :LIMit:FAIL?	Check for channel 1 limit line violation (Output 0 = OK; 1 = fail)	3-51
CALCulate < channel 1 to 4 > :LIMit:LOWerspace < numeric value in dB from -299.99 to 299.99 >	Set channel 1 lower limit line to -50 dBm	3-52
CALCulate < channel 1 to 4 > :LIMit:STATespace < ON OFF >	Enable channel 1 upper and lower limit checking. (0 = off; 1 = on)	3-53
CALCulate < channel 1 to 4 > :LIMit:UPPerspace < numeric value in dB from -299.99 to 299.99 >	Set channel 1 upper limit line to 17 dBm	3-53
CALCulate < channel 1 to 4 > :PHOLd:STATespace < ON OFF >	Enable/disable peak hold measurements	3-34
CALCulate < channel 1 to 4 > :PHOLd:DATA?	Reads the peak hold measurements	3-34
CALCulate < channel 1 to 4 > [:CHANnel]:POWerspace < sensor 1 or 2 >	Configures channel 2 to measure Sensor 1 power	3-32

Table 3-3: SCPI Command Syntax (Continued)

Command Syntax	Function	Page
CALCulate < channel 1 to 4 > [:CHANnel]:RATiospace < sensor 1 or 2 comma sensor 2 or 1 >	Configures channel 1 to measure Sensor 2 over Sensor 1 power	3-32
CALCulate < channel 1 to 4 > :MODEspace < NORMal, BURst, SWIFt or FMOD Selection >	Set up time gating mode on the specified input	3-37
CALCulate < channel 1 to 4 > :MAXimum:STATespace < ON OFF >	Enable channel 2 maximum value monitoring	3-50
CALCulate < channel 1 to 4 > :MAXimum[:MAGnitude]?	Query channel 2 maximum value in dBm	3-50
CALCulate < channel 1 to 4 > :MINimum:STATespace < ON OFF >	Enable channel 1 min. value monitoring	3-50
CALCulate < channel 1 to 4 > :MINimum[:MAGnitude]?	Query channel minimum value in dBm	3-50
CALCulate < channel 1 to 4 > :REference:STATespace < ON OFF >	Activate level reference for relative measurements	3-43
CALCulate < channel 1 to 4 > :REference[:MAGnitude] < dB Offset value from -299.999 to 299.999 >	Set channel 2 reference offset value in dB Reset channel 2 Relative meas. operation	3-43
CALCulate < channel 1 to 4 > :REference:COLlect	Take channel 2 reading as reference value. Reset with CALC:REF 0.0	3-43
CALCulate < channel 1 to 4 > :SFUNctions:STATespace < ON OFF >	Enables/disables statistical functions (means and standard)	3-34
CALCulate < channel 1 to 4 > :SFUNctions:DATA?	Reads the result produced by the statistics function. The response is in the form < means > , < standard deviation >	3-34
CALCulate < channel 1 to 4 > :STATespace < ON OFF >	Disable channel 1 measurement	3-33
CALCulate < channel 1 to 4 > :UNIT[:POWER]space < data units selection, dBm or Watt >	Selects channel 1 linear units in Watts Selects channel 1 Log Units in dBm	3-33
CALibrate < sensor 1 or 2 > [:SENSor]	Calibrate Sensor 1	3-18
CALibrate < sensor 1 or 2 > :STATe?	Query sensor for calibration status	3-18
CALibrate < sensor 1 or 2 > :ZERO	Zero Sensor 1	3-19
FETCh < channel 1 to 4 > ?	Read previously triggered channel 1 power, Normal, Swift, Burst or FMOD mode data	3-26
INITiate[:IMMediate]	Initiate instrument triggering cycle	3-31
INITiate:CONTinuousspace < ON OFF >	8650A self-triggers continuously	3-31
MEASure < channel 1 to 4 > [:SCALar:POWER]?	Configure triggering and measure channel 2 power in NORMal mode	3-26
MEMory[:TABLe]:CHANnelsepace < channel 1 to 4 >	Set analog out to channel 2	3-53
MEMory[:TABLe]:FREQuency < Start frequency >	Set V _{PROP} F start frequency to 1 GHz	3-36
MEMory[:TABLe]:POWerspace < start value from -80 to +20 dBm > comma < stop value from -80 to +20 dBm >	Set analog out power range (in dBm) from -80 to 20 dBm	3-53
MEMory[:TABLe]:POWerspace < start value from 0 to 0.01W > comma < stop value from 0 to 0.01W >	Set analog out power range (in Watts) from 0 to 0.01 Watts	3-53
MEMory[:TABLe]:SElectspace < ANALOGout, VPROP1, VPROP2 >	Select memory table V _{PROP} F1 for editing in following lines	3-35 3-53
MEMory[:TABLe]:SLOPespace < Volts per Hz >	Set V _{PROP} F slope in 1V/GHz	3-35
MEMory[:TABLe]:UNITspace < Units for analog output configuration, dBm or Watt >	Set analog out power unit	3-53
MEMory[:TABLe]:VOLTagespace < start value from -10 to +10 V > comma < stop value from -10 to +10 V >	Set analog out voltage range from -8 to 2 volts corresponding to power	3-54

Series 8650A Universal Power Meters

Table 3-3: SCPI Command Syntax (Continued)

Command Syntax	Function	Page
OUTPut[:BNC]:ANALog[:STATe]space < ON OFF >	Enable analog out function	3-53
OUTPut:ROSCillator[:STATe]space < ON OFF >	Turn ON 0.0 dBm Calibrator Oscillator	3-60
READ < channel 1 to 4 > [:POWer]?	Trigger measurement and read channel 2	3-26
SENSe < sensor 1 or 2 > :AVERage:COUNTspace < averaging value 1,2,4,8,16,32,64,128,256,or512 >	Set sensor 1 average number to 16	3-42
SENSe < sensor 1 or 2 > :AVERage:COUNT:AUTOspace < ON OFF >	Select sensor 2 Auto-average mode	3-42
SENSe < sensor 1 or 2 > :AVERage:TCONtrolspace < data acquisition averaging method, MOVing or REPeat >	Set sensor 1 to acquire fresh measurement data before averaging	3-42
SENSe < sensor 1 or 2 > :CONFIg?	Query sensor configuration on specified input. Response is character data	3-20
SENSe < sensor 1 or 2 > :CONFIg:BAP	Query sensor configuration on specified input. Response is character data	Starts 3-20
SENSe < sensor 1 or 2 > :CONFIg:BAP:BEEclude:space < samples >	Enables BAP mode on the specified input	
SENSe < sensor 1 or 2 > :CONFIg:BAP:BEEclude?	Reads the number of burst end exclude samples	
SENSe < sensor 1 or 2 > :CONFIg:BAP:BSEclude?space < samples >	Set number of burst start exclude samples	
SENSe < sensor 1 or 2 > :CONFIg:BAP:BSEclude?	Reads the number of burst end exclude samples	
SENSe < sensor 1 or 2 > :CONFIg:BAP:BDTolerance:space < samples >	Set the burst tolerance duration in milliseconds	
SENSe < sensor 1 or 2 > :CONFIg:BAP:BDTolerance?	Reads the current burst dropout tolerance duration	
SENSe < sensor 1 or 2 > :CONFIg:CW	Enables CW mode on the specified input	3-21
SENSe < sensor 1 or 2 > :CONFIg:MAP[SYNChronized]	Enables synchronized MAP mode on the specified input	Starts 3-21
SENSe < sensor 1 or 2 > :CONFIg:MAP[USYNChronized]	Enables unsynchronized MAP mode on the specified input	
SENSe < sensor 1 or 2 > :CONFIg:PAP	Enables PAP mode on the specified input	Starts 3-22
SENSe < sensor 1 or 2 > :CONFIg:PAP:DCYCLE:space < Duty Cycle Value >	Sets the duty cycle value that will be used when PAP is enabled	
SENSe < sensor 1 or 2 > :CONFIg:PAP:DCYCLE?	Query the duty cycle	
SENSe < sensor 1 or 2 > :CORRection:EEPROM:TYPE?	Query sensor 1 eeprom type	3-60
SENSe < sensor 1 or 2 > :CORRection:EEPROM:FREQuency?	Query sensor 1 eeprom frequency table	3-60
SENSe < sensor 1 or 2 > :CORRection:EEPROM:CALFactor?	Query sensor 1 eeprom cal factor table	3-60
SENSe < sensor 1 or 2 > :CORRection:FREQuency[:CW-FIXed] 5e7	Set sensor 2 frequency to 50 MHz	3-35
SENSe < sensor 1 or 2 > :CORRection:OFFSet:COLLect	Take sensor 1 current reading as offset value	3-44
SENSe < sensor 1 or 2 > :CORRection:OFFSet [:MAGnitude]space < offset value in dB -99.99 to 99.99 >	Compensate sensor 2 for 10.2 dB attenuation	3-44
SENSe < sensor 1 or 2 > :CORRection:OFFSet:STATe:space < ON OFF >	Enable sensor 2 offset correction	3-44
SENSe < sensor 1 or 2 > :CORRection:VPROp[:STATe]space < ON OFF >	Enable sensor 1 v_prop_f function	3-35
SENSe < sensor 1 or 2 > :GATE:MODE:space < OFF, GATE, TRIGger or EDGE >	Sets up time gating mode on the specified input	3-23
SENSe < sensor 1 or 2 > :GATE:POLarity:space < INVert or NINVert >	Sets the polarity of the trigger input signal	3-24
SENSe < sensor 1 or 2 > :GATE:DELay:space < time >	Sets the delay time from the trigger input edge to the start of the gating period	3-24

Table 3-3: SCPI Command Syntax (Continued)

Command Syntax	Function	Page
SENSe < sensor 1 or 2 > :GATE:DURationspace < time >	Sets the duration of the gating period. This command is relevant only in the External gating period	3-24
SENSe < sensor 1 or 2 > :GATE:HOLDoff < time >	Sets the hold-off time from the end of the gating period to the time when the circuit will accept another trigger input edge. This command is relevant only in the External Trigger mode	3-24
SENSe < sensor 1 or 2 > :TEMPerature?	Query sensor 1 temperature (in centigrade)	3-19
SENSe < sensor 1 or 2 > :TRIGger:SOURcespace < peak sensor triggering INTERNAL, EXTERNAL or CW >	Set sensor 1 peak trigger mode to CW mode	3-40
SENSe < sensor 1 or 2 > :TRIGger:DELay[:MAGnitude]:space < Peak Sensor sample delay in seconds from -20e-9 to 104e-3 >	Set sensor 2 peak delay value to 1e6 seconds	3-40
SENSe < sensor 1 or 2 > :TRIGger:DELay:STATespace < ON OFF >	Enable peak sensor 1 delay function	3-41
SENSe < sensor 1 or 2 > :TRIGger:LEVel[:MAGnitude]:space < trigger level of peak power sensor >	Set peak sensor 1 trigger level to 1.7 volts	3-41
SENSe < sensor 1 or 2 > :TRIGger:OFFSet[:MAGnitude]	Set peak sensor 1 trigger offset time to 0 second	3-41
SENSe < sensor 1 or 2 > :TRIGger:TOTAL[:MAGnitude]?	Query peak sensor 1 total trigger delay time	3-41
*SREspace < event status register value, 128, 64, 32, 16, 8, 4, 2, 1 >	Enable bit 5 of Status Byte register	3-47
STATus:OPERation[:EVENT]?	Query operation event register result	3-47
STATus:OPERation[:ENABLE]	Set Status Enable Mask	3-47
STATus:PRESet	Clears all the status register value	3-47 3-57
SYSTem:COMMunicate:SERial:REceive:BAUDspace < baud rate >	Set the receive baud rate	3-45
SYSTem:COMMunicate:SERial:TRANsmit:BAUDspace < baud rate >	Set the transmit baud rate	3-45
SYSTem:ERRor?	Query system error message	3-61
SYSTem:LANGuage NATIVE	Switch to native language	3-56
SYSTem:PRESet	Reset 8650A configuration	3-57
SYSTem:VERSion?	Query SCPI version	3-59
TRIGger[:IMMediate]	Trigger measurement cycle	3-29
TRIGger:SOURcespace < instrument triggering source IMMEDIATEBUS, HOLD, or EXTERNAL >	Set instrument measurement trigger source to IMMEDIATE	3-29
TRIGger:MODEspace < burst mode data gathering POST trigger receipt or PRE trigger receipt >	Set Burst or Swift mode data collection relative to Timing of event trigger post	3-28
TRIGger:DELayspace < delay time between buffered readings in sec 0.000 to 5.000 >	Set Burst mode measurement time to 5 ms between measurements (resolution, one msec)	3-29
TRIGger:COUNTspace < number of data values to buffer in memory from 1 to 5000 for standard 8650s from 1 to 128,000 on one channel with option 02; from 1 to 64000 for two channels with option 02 >	Set Burst or Swift mode buffer reading number to 100	3-30

3.2.10 Sensor Calibration & Zeroing

- **CALibrate < sensor 1 or 2 >**
- **CALibrate < sensor 1 or 2 > STATE?**
- **CALibrate < sensor 1 or 2 > ZERO**
- **SENSe < sensor 1 or 2 > :TEMPerature?**

3.2.10.1 Sensor Calibration

The CALibration commands for sensor calibration and zeroing are important for accurate power measurement results. Be sure to perform the sensor calibration prior to beginning measurement operation or channel configuration. Sensors must be calibrated to the meter before performing measurements.

Zeroing of all active sensors should always be performed whenever a second sensor (whether calibrated or not) is added or removed. Zeroing should also be performed prior to measurement of low signal levels, generally within the lower 15 dB of a sensor's dynamic range. For standard sensors, this is -55 dBm.

CAL#

Syntax:	CALibration < sensor 1 or 2 > [:SENSor]	
Example:	OUTPUT @PWR_MTR;CAL1	! CALIBRATE SENSOR 1
Description:	This command begins the sensor power sweep calibration process. Power sweep calibration can be performed only during Normal mode. The sensor must be attached to the front panel CALIBRATOR (use an adapter for high frequency sensors with Type K connectors). If the sensor is not connected or if the sensor is disconnected during the power sweep calibration procedure, the calibration automatically fails and the sensor power sweep calibration table is restored to its previous values.	

CALibrate:STATE?

Syntax:	CALibrate < sensor 1 or 2 > :STATE?	
Example:	OUTPUT @PWR_MTR;CAL1:STAT?	! QUERIES SENSOR FOR CALIBRATION STATUS
Response:	1 if sensor is calibrated, or 0 if sensor is not calibrated.	
Description:	This command queries whether or not a sensor has been calibrated.	

3.2.10.2 Sensor Zero

Zeroing automatically accounts for ground noise and other noise in the measurement system. Measurements will be sensitive to noise-induced errors only in the lowest 15 dB of the sensor dynamic range. *Be sure to turn off the signal going into the sensor during zeroing, otherwise a failure will be indicated.*

CAL#:ZERO

Syntax:	CALibration < sensor 1 or 2 > :ZERO	
Example:	OUTPUT @PWR_MTR;CAL1:ZERO	! ZERO SENSOR 1
Description:	This command begins the zeroing process. To offset for measurement circuit noise during zeroing, The sensor needs to remain attached to the measurement circuit during zeroing. Disable the signal source into the sensor. If disabling the signal source cannot occur, connect the sensor to a grounded connector (preferably RF grounded) or leave the sensor disconnected. Do not connect the sensor to the power meter front panel calibrator port. If the meter detects excessive RF power at the start of the zeroing process (generally above -50 dBm for standard sensors), zeroing will automatically fail.	

SENS#:TEMP?

Syntax:	SENSe < sensor 1 or 2 > :TEMPerature?	
Example:	OUTPUT @PWR_MTR;SENS1:TEMP?	! QUERIES SENSOR 1 TEMPERATURE (IN CENTIGRADE)
Response:	Current sensor temperature in degrees centigrade	
Description:	This command reports sensor temperature. If the temperature varies in the operating environment, monitor the relative temperature variations. If the variation since the previous power sweep calibration exceeds ± 5 °C (± 9 °F), perform the power sweep calibration for that sensor.	

Example programs for Sensor Calibration and Zeroing are contained in Appendix A.

3.2.11 Sensor Configuration Commands

- **SENSe:CONFig?**
- **SENSe:CONFig:BAP**
- **SENSe:CONFig:MAP**
- **SENSe:CONFig:CW**
- **SENSe:CONFig:PAP**

The following commands are for sensor configuration.

SENSe:CONFig?

Syntax:	SENSe < sensor 1 or 2 > :CONFig?	
Example:	OUTPUT @PWR_MTR;SENS1:CONFIG?	! QUERIES SENSOR 1
Description:	Queries sensor configuration on specified input. Response is character response data: CW MAP MAPU BAP PAP UNCAL NOSENSOR.	

SENSe:CONFig:BAP

Syntax:	SENSe < sensor 1 or 2 > :CONFig:BAP	
Example:	OUTPUT @PWR_MTR;SENS1:CONFIG:BAP	! ENABLES SENSOR 1 FOR BAP MODE
Description:	Enables BAP mode on the specified input. This command does not affect the burst star or end exclude or dropout tolerance parameters. The default values, set by *RST, correspond to the "automatic" settings in manual mode.	

Syntax:	SENSe < sensor 1 or 2 > :CONFig:BAP:BEEExclude <i>space</i> < samples > (Where <samples> is an integer in the range of 0 to 123)	
Example:	OUTPUT @PWR_MTR;CONFIG:BAP:BEE 2	! SETS NUMBER OF BURST END EXCLUDE SAMPLES
Response:	The timing for each sample is approximately 27 μ s.	
Description:	Sets the burst end exclude to 2, i.e., 54 μ s.	

Syntax:	SENSe < sensor 1 or 2 > :CONFig:BAP:BEEExclude?	
Example:	OUTPUT @PWR_MTR;CONFIG:BAP:BEE?	! READS THE NUMBER OF BURST END EXCLUDE SAMPLES
Description:	Query form for burst end exclude.	

Syntax:	SENSe < sensor 1 or 2 > :CONFig:BAP:BSEExclude <i>space</i> < samples > (Where <samples> is an integer in the range of 0 to 1565)	
Example:	OUTPUT @PWR_MTR;CONFIG:BAP:BSE 1	! SETS NUMBER OF BURST START EXCLUDE SAMPLES
Response:	The timing for each sample is approximately 27 μ s.	
Description:	Sets the burst start exclude to 1, i.e., 27 μ s.	

Syntax:	SENSe < sensor 1 or 2 > :CONFig:BAP:BSExclude?	
Example:	OUTPUT @PWR_MTR;SENS1:CONFig:BAP:BSEX?	! READS THE NUMBER OF BURST START EXCLUDE SAMPLES
Description:	Query form for burst start exclude.	

Syntax:	SENSe < sensor 1 or 2 > :CONFig:BAP:BDTolerance <i>space</i> < dropout > (Where <dropout> is the dropout time in milliseconds in the range of 0 to 74 and with a resolution of 0.1 ms. The system selects the nearest value from a series of discrete values.)	
Example:	OUTPUT @PWR_MTR;SENS1:CONFig:BAP:BDT:0.054	! SETS THE BURST DROPOUT TOLERANCE DURATION IN MILLISECONDS
Description:	Sets the burst dropout tolerance to 54 μ s.	

Syntax:	SENSe < sensor 1 or 2 > :CONFig:BAP:BDTolerance?	
Example:	OUTPUT @PWR_MTR;SENS1:CONFig:BAP:BDT?	! READS THE CURRENT BURST DROPOUT TOLERANCE DURATION
Description:	Query form for burst dropout tolerance.	

SENSe:CONFig:CW

Syntax:	SENSe < sensor 1 or 2 > :CONFig:CW	
Example:	OUTPUT @PWR_MTR;SENS1:CONFig:CW	! ENABLES CW MODE ON THE SPECIFIED INPUT
Description:	Configures CW or Modulation sensor for CW mode.	

SENSe:CONFig:MAP

Syntax:	SENSe < sensor 1 or 2 > :CONFig:MAP[SYNChronized]	
Example:	OUTPUT @PWR_MTR;SENS1:CONFig:MAP	! ENABLES SYNCHRONIZED MAP MODE ON THE SPECIFIED INPUT
Description:	Configures modulation sensor for MAP (Modulated Average Power) Synchronized mode.	

Syntax:	SENSe < sensor 1 or 2 > :CONFig:MAP[UNSYnchronized]	
Example:	OUTPUT @PWR_MTR;SENS1:CONFig:UNSYMAP	! ENABLES UNSYNCHRONIZED MAP MODE ON THE SPECIFIED INPUT
Description:	Configures modulation sensor for MAP (Modulated Average Power) Unsynchronized mode or when performing measurements using high average values where the signal exhibits very large power swings. If an irregularly modulated signal is measured in MAP mode, measurement settling time will vary as the power meter attempts to synchronize to the modulation, disabling synchronization achieves faster measurement.	

Series 8650A Universal Power Meters

SENSe:CONFig:PAP

Syntax:	SENSe < sensor 1 or 2 > :CONFig:PAP	
Example:	OUTPUT @PWR_MTR;SENS1:CONFig:PAP	! ENABLES PAP MODE ON THE SPECIFIED INPUT
Description:	Configures modulation sensor for PAP (Pulse Average Power) Synchronized mode. This mode requires duty cycle configuration.	

Syntax:	SENSe < sensor 1 or 2 > :CONFig:PAP:DCYClE <i>space</i> < Duty Cycle Value > (Where <Duty Cycle Value> is in the range 0.001 to 99.999% with a resolution of 0.001.)	
Example:	OUTPUT @PWR_MTR;SENS1:CONFig:PAP:DCYCLE 0.001	! SETS THE DUTY CYCLE VALUE THAT WILL BE USED WHEN PAP IS ENABLED
Description:	Configures duty cycle setting for PAP mode.	

Syntax:	SENSe < sensor 1 or 2 > :CONFig:PAP:DCYClE?	
Example:	OUTPUT @PWR_MTR;SENS1:CONFig:PAP:DCYCLE?	! QUERIES THE DUTY CYCLE
Description:	Query form for PAP duty cycle command.	

3.2.12 Sensor Gate Commands

- **SENSe:GATE:MODE**
- **SENSe:GATE:MODE?**
- **SENSe:GATE:POLarity**
- **SENSe:GATE:POLarity?**
- **SENSe:GATE:DELay**
- **SENSe:GATE:DELay?**
- **SENSe:GATE:DURation**
- **SENSe:GATE:DURation?**
- **SENSe:GATE:HOLDoff**
- **SENSe:GATE:HOLDoff?**

The following commands are for sensor gate settings.

SENSe:GATE:MODE

Syntax:	SENSe < sensor 1 or 2 > :GATE:MODE <i>space</i> < OFF, GATE, TRIGger or EDGE >	
Example:	OUTPUT @PWR_MTR;SENS1:GATE:MODE GATE	! SETS SENSOR 1 TO GATE TIME GATING MODE
Description:	Configures sensor for Time Gating operation. Selection is GATE, TRIGGER and EDGE. In GATE mode, the meters measures the average power of a signal while the system is triggered. The duration of the measurement is determined by the duration of the trigger signal. In TRIGGER mode, the meter measures the average of a signal for the duration specified in by the Gate Duration command after the gate delay time has been satisfied. A TTL signal supplied at the trigger input initiates the trigger cycle. IN EDGE mode, the meter internally detects the rising edge of a pulsed signal to trigger a gated measurement. TRIGGER and EDGE mode require the delay and duration to be set.	

SENSe:GATE:MODE?

Syntax:	SENSe < sensor 1 or 2 > :GATE:MODE?	
Example:	OUTPUT @PWR_MTR;SENS1:GATE:MODE GATE?	! REQUESTS THE CURRENT SENSOR GATE MODE FROM THE METER
Description:	Query form for sensor gate mode. Response can be OFF, GATE, TRIG or EDGE.	

SENSe:GATE:POLarity

Syntax:	SENSe < sensor 1 or 2 > :GATE:POLarity <i>space</i> < INVert or NINVert >	
Example:	OUTPUT @PWR_MTR;SENS1:GATE:POL NINV	! SETS NON-INVERTED POLARITY FOR THE TRIGGER INPUT
Description:	Configures the Time Gating trigger input for positive or negative polarity. INV configures the meter to trigger from the falling edge of the trigger input.	

SENSe:GATE:POLarity?

Syntax:	SENSe < sensor 1 or 2 > :GATE:POLarity?	
Example:	OUTPUT @PWR_MTR;SENS1:GATE:SENS1:GATE:POL?	! QUERIES THE METER FOR POLARITY OF THE TRIGGER INPUT SIGNAL
Description:	Query form for sensor gate polarity. Response can be INV or NINV.	

SENSe:GATE:DElAy

Syntax:	SENSe < sensor 1 or 2 > :GATE:DElAy <i>space</i> < time > <small>(Where <time> is in the range 0 to 327.675 ms with a resolution of 5 ms, where 0 represents some minimum non-zero delay time.)</small>	
Example:	OUTPUT @PWR_MTR;SENS1:GATE:DELAY 20E-3	! SETS THE GATE DELAY TO 20 MS
Description:	Sets the delay time from the trigger input edge to the start of the gating period.	

SENSe:GATE:DElAy?

Syntax:	SENSe < sensor 1 or 2 > :GATE:DElAy?	
Example:	OUTPUT @PWR_MTR;SENS1:GATE:DEL?	! REQUESTS SENSOR 1 GATE DELAY SETTING
Description:	Query form for sensor gate delay command.	

SENSe:GATE:DUrAtion

Syntax:	SENSe < sensor 1 or 2 > :GATE:DUrAtion <i>space</i> < time > <small>(Where <time> is in the range 0 to 327.675 μs with a resolution of 5 μs)</small>	
Example:	OUTPUT @PWR_MTR;SENS1:GATE:DUr 250E-3	! SETS THE DURATION TO 250 USEC
Description:	Sets the time gate duration for TRIGGER and EDGE mode.	

SENSe:GATE:DUrAtion?

Syntax:	SENSe < sensor 1 or 2 > :GATE:DUrAtion?	
Example:	OUTPUT @PWR_MTR;SENS1:GATE:DUr?	! REQUESTS SENSOR 1 TIME GATE DURING SETTING
Description:	Query form for sensor gate duration command.	

SENSe:GATE:HOLDoff

Syntax:	SENSe < sensor 1 or 2 > :GATE:HOLDoff <i>space</i> < time > <small>(Where <time> is in the range 0 to 327.675 μs with a resolution of 5 μs)</small>	
Example:	OUTPUT @PWR_MTR;SENS1:GATE:HOLD 10E-6	! SETS THE GATE HOLD-OFF TO 1 USEC
Description:	Specifies the hold-off time from the end of the gating period to the time when the circuit will accept another trigger.	

SENSe:GATE:HOLDoff?

Syntax:	SENSe < sensor 1 or 2 > :GATE:HOLDoff?	
Example:	OUTPUT @PWR_MTR;SENS1:GATE:HOLD?	! REQUESTS SENSOR 1 TIME GATE HOLD-OFF SETTING
Description:	Query form for sensor gate hold-off command. Response is trigger hold-off time in seconds.	

3.2.13 Reading Power Measurements

- **FETCh?**
- **MEASure?**
- **READ?**
- ***OPC**
- ***OPC?**

These commands return measurement data from the 8650A. During Normal mode the data will be single measurement values. During Swift or Burst modes, the data will be an array of values. Generally, it is a single array if one sensor is connected and calibrated, and a dual array if two sensors are connected and calibrated.

FETCh?

Syntax:	FETCh < channel 1 to 4 > ?	
Example:	OUTPUT @PWR_MTR;FETC1?	! READS PREVIOUSLY TRIGGERED CHANNEL 1 POWER ! NORMAL, SWIFT, BURST OR FMOD MODE DATA
Response:	Whatever is in the output buffer whether it is a new measurement or an old one.	
Description:	<p>The FETCh? query command returns post-processed measurement data from the active channels of the 8650A. After receiving FETCh? the 8650A will output the contents of its active data output buffer. The data size and output format of the buffer are dependent upon channel and measurement mode configuration.</p> <p>For example, if channel 1 is defined as sensor 1 and channel 2 is defined as sensor 2/1, the FETCh? query command will return the power level incident upon sensor 1 and the ratio of the power levels incident upon sensor 2 and 1. FETCh? is used with NORMal mode measurements when INITiate:IMMediate is active, and for reading SWIFt, BURSt and FMOD Mode measurement data from the meter's data buffer.</p>	

MEAS?

Syntax:	MEASure < channel 1 to 4 > [:SCALar:POWer]?	
Example:	OUTPUT @PWR_MTR;MEAS2?	! ARMS, TRIGGERS AND MEASURES CHANNEL 2 ! POWER IN NORMAL MODE
Response:	A power measurement.	
Description:	<p>The MEAS? command returns measured data from the active software calculation channels of the 8650A. The MEAS? command will also initiate the trigger cycle and will turn on the Auto Averaging mode; that is, measurement will be triggered and the data will be transmitted from the power meter. This is in contrast to the FETCh? command, which is capable of causing immediate output of the measurement data but not initiating the triggering cycle.</p>	

READ?

Syntax:	READ < channel 1 to 4 > < channel 1 to 4 > < channel 1 to 4 > [:POWer]?	
Example:	OUTPUT @PWR_MTR;READ2?	! TRIGGER MEASUREMENT AND READ CHANNEL 2
Response:	A power measurement.	
Description:	<p>The READ[:POWer]? query command triggers measurement and sends the data to the controller. The READ? command enables the power meter to acquire data at the next instrument trigger and return post-processed measurement data from the active channels of the 8650A. READ uses the current sensor averaging setup.</p>	

*OPC

Example:	OUTPUT @PWR_MTR;*OPC	! *OPC ALLOWS ONE-TIME SRQ ENABLE
Description:	The *OPC command determines when an operation is completed. This command is generally used to monitor the completion of long measurement sequences. It sets the operation complete bit in the event status register upon completion of operation.	

*OPC?

Example:	OUTPUT@PWR_MTR;*OPC?	! RETURNS A VALUE OF 1 AFTER AN OPERATION IS COMPLETED
Description:	The *OPC? operation complete query allows synchronization between the controller and the test set using either the message available (MAV) bit in the status byte, or a read of the output OPC?.	

3.2.13.1 Special Errors

An unusual or non-sense numeric response, such as 9e+40, indicates an error response. For instance, not performing the power sweep calibration procedure to calibrate the sensor to the power meter, the response to a MEAS#? command will be 9.0000e+40.

Selected basic SCPI syntax and execution errors apply to these commands.

If using the READ#? measurement query and INIT:CONT is ON, a bad value is returned, 9e+40. Sending SYST:ERR? error query, -213, Init ignored will be returned. READ#? contains the low level function INIT, since INIT:CONT is ON the INIT within READ#? generates an error. Set INIT:CONT to OFF when using READ#?.

There are no device-specific errors for the preset configuration or status reset commands except the high level -300, Device-specific error response.

Example programs for Reading Power Measurements are contained in Appendix A.

3.2.14 Instrument Triggering

- *TRG
- TRIGger[:IMMEDIATE]
- TRIGger:SOURce
- TRIGger:MODE
- TRIGger:DELaY
- TRIGger:COUNt
- INITiate:CONTInuous
- INITiate[:IMMEDIATE]
- *WAI

These SCPI commands trigger the measurement cycle. They do not configure or provide triggering for Peak Power Sensors. Those commands are defined in Section 3.2.19. For power meter operation, the TRIGger Subsystem is divided into two sections; Instrument Measurement Event Triggering, and Special Triggering Configuration commands for the fast reading buffered data, Burst, and Swift modes.

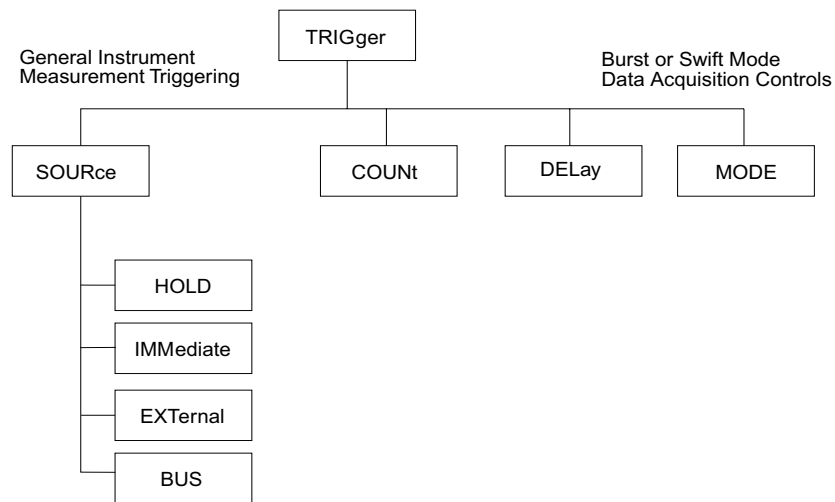

Figure 3-8: TRIGger Subsystem Command Tree

EXT triggering is performed with the rear panel BNC connector and functions only in the BURSt and SWIFt Modes. EXT triggering is not available in the NORMal Mode. Provision has been made for a hardware ready for new trigger type handshaking capability using the analog output.

BUS triggering is available for all operating modes, BURSt, SWIFt and NORMal.

IMMEDIATE triggering allows the 8650A to free run and perform continuous measurements. This is the default setting. To INITiate on IMMEDIATE to increase measurement speed. During Normal Mode, with both of these controls set to IMM, power measurements can be read with MEAS, READ, or FETCh. IMMEDIATE triggering is not compatible with the BURSt Mode. To send the CALC#:MODE BURSt command to enter the BURSt Mode, IMM instrument triggering for NORMal Mode will automatically be switched to TRIG:SOUR BUS. To send the CALC#: MODE SWIF command to enter the SWIFt Mode, IMM instrument triggering will remain IMM but a device-specific error will be generated whenever specifying a TRIG:COUN# higher than 1.

*TRG

Syntax:	*TRG	
Example:	OUTPUT @PWR_MTR;*TRG	! BUS TRIGGER EVENT
Description:	*TRG is an IEEE 488.2 compatible programming command to initiate BUS triggered measurements. The power meter interprets *TRG as a BUS source for instrument triggering events. This command will not trigger Peak Power Sensors. It is the same as the TRIG command.	

TRIG

Syntax:	TRIGger[:IMMEDIATE]	
Example:	OUTPUT @PWR_MTR;TRIG	! TRIGGER MEASUREMENT CYCLE
Description:	TRIG is the SCPI command form of *TRG. The power meter interprets TRIG as a BUS source for instrument triggering events. If INIT:CONT is OFF, measurements using FETCh#? will not proceed until triggering is armed and instrument triggering is actuated.	

TRIG:SOUR

Syntax:	TRIGger:SOURcespace < instrument triggering sourc IMMEDIATE, BUS, HOLD, or EXTernal >																					
Example:	OUTPUT @PWR_MTR;TRIG:SOUR IMM	! SETS INSTRUMENT MEASUREMENT TRIGGER ! SOURCE TO IMMEDIATE																				
Description:	<p>TRIG:SOUR IMM sets trigger control to the 8650A. BUS triggering sets the triggering control to the controller software using TRIG or *TRG commands. HOLD halts triggering sequences. EXTernal sets triggering control to the front panel BNC connector. The following data shows triggering and operating mode compatibility.</p> <table border="1"> <thead> <tr> <th>Operating Mode</th> <th>IMM</th> <th>BUS</th> <th>HOLD</th> <th>EXT</th> </tr> </thead> <tbody> <tr> <td>NORMal</td> <td>X</td> <td>X</td> <td>X,</td> <td></td> </tr> <tr> <td>SWIFt</td> <td>X</td> <td>X</td> <td></td> <td>X</td> </tr> <tr> <td>BURSt</td> <td></td> <td>X</td> <td></td> <td>X</td> </tr> </tbody> </table> <p>If the power meter has been configured for EXT triggering in the BURSt or SWIFt modes and the operating mode is switched to NORMal, the triggering configuration remains EXT. However, if the configuration is IMM in NORMal mode and the meter is switched to BURSt, it automatically switches to BUS. As a general rule, when a measurement subroutine switches operating modes, send the triggering configuration.</p>		Operating Mode	IMM	BUS	HOLD	EXT	NORMal	X	X	X,		SWIFt	X	X		X	BURSt		X		X
Operating Mode	IMM	BUS	HOLD	EXT																		
NORMal	X	X	X,																			
SWIFt	X	X		X																		
BURSt		X		X																		

TRIG:MODE

Syntax:	TRIGger:MODEspace < burst mode data gathering POST trigger receipt or PRE trigger receipt >	
Example:	OUTPUT @PWR_MTR;TRIG:MODE POST	! SETS BURST OR SWIFT MODE DATA COLLECTION ! RELATIVE TO TIMING OF EVENT TRIGGER POST
Description:	<p>This command is only for BURSt Mode measurements. Send this command only immediately after CALC#:MODE BURS. TRIG:MODE controls the operation of the FIFO data buffer inside the power meter. When set to POST, the burst of data points is taken after the receipt of a valid instrument trigger. When set to PRE, the burst of data is assumed to be those data points that have arrived immediately preceding the valid instrument trigger event. Using PRE requires some caution: The single processor in the 8650A is constantly performing data acquisition. To send any configuration commands while it is collecting the PRE trigger data, the timing of the data point collection can be interrupted.</p>	

Series 8650A Universal Power Meters

TRIG:DEL

Syntax:	TRIGger:DEL <i>space</i> < delay time between buffered readings in sec, 0.000 to 5.000 >	
Example:	OUTPUT @PWR_MTR;TRIG:DEL 5E-3	! SETS BURST MODE MEASUREMENT TIME TO ! 5 MS BETWEEN MEASUREMENTS.
Example 2:	OUTPUT @PWR_MTR;TRIG:DEL 0	! MAX. MEASUREMENT RATE (RESOLUTION, ! 1 MSEC)
Description:	<p>This command applies only to the BURSt Mode. It sets the time interval between the measurements and is accurate to about 5%. This is the only way to control the data acquisition of individual data points in a burst measurement. Burst measurement data is taken following or just prior to a single instrument trigger event. The number of measurements taken is controlled by TRIG:COUNT. Timing can be set in 0.001 second increments from 0.000 to 5.000 seconds, inclusive. Setting this control to 0.000 activates the highest reading rate (5100 rdgs/sec) possible with the 8650A.</p> <p>Triggering of the Peak Power Sensor occurs independently from instrument triggering. Therefore, there is a moderate ability to control triggering at the Peak Power Sensors. Generally, if controlling is required of individual data point triggering, the SWIFt mode will provide the highest measurement rates, with or without SRQ or hardware handshaking.</p>	

TRIG:COUN

Syntax:	TRIGger:COUN <i>space</i> < number of data values to buffer in memory from 1 to 5000 for the standard 8650; from 1 to 128,000 on one channel with option 02; and 1 to 64000 for two channels with option 02 >	
Example:	OUTPUT @PWR_MTR;TRIG:COUN 100	! SETS BURST OR SWIFT MODE BUFFER READING ! NUMBER TO 100
Description:	<p>The power meter has an internal and expandable data buffer for storing measurement data until the slot 0 controller/resource manager is ready to read the data. During the SWIFt or BURSt modes, this command controls the number of power readings that are stored in the 8650A data buffer.</p> <p>The value specified here applies to each individual channel. That is, if two sensors are attached and calibrated, the 8650A will perform the specified measurement and buffering for both channels. In the example shown below for this command, that would be 100 points per channel. Option 02 adds additional memory for 128,000 data point buffering. When two sensors are attached and calibrated, the maximum is 64,000 readings per channel.</p> <p>During BURSt mode, the COUNT# of readings will be taken with just one instrument trigger. During the SWIFt Mode however, to control the triggering of individual data points. set triggering to EXT, the power meter will perform one measurement each time it detects a TTL level signal. The value is then stored in the data buffer. This continues until the meter has received and processed a COUNT# of triggers and also read in a COUNT# of data points to the buffer.</p>	

*WAI

Example:	OUTPUT @PWR_MTR;*WAI	! WAIT, FOLLOWING COMMAND COMPLETION
Description:	The *WAI command causes the power meter to wait until all previous commands and queries are completed before continuing operation. It functions only when using the Normal mode of operation.	

Example programs for Instrument Triggering are contained in Appendix A.

3.2.15 Arming the Triggering Cycle

- **INITiate:CONTinuous**
- **INITiate[:IMMEDIATE]**

The Initiate commands enable the power meter to acquire measurement data at the next instrument trigger. In the absence of an instrument signal, the 8650A is placed in the waiting-for-trigger-state. The default configuration is continuous initiation, INIT:CONT ON.

INITiate[:IMMEDIATE] causes the power meter to exit the idle state and causes the trigger system to initiate and complete one full trigger cycle, returning to the idle state upon completion. For example, INITiate[:IMMEDIATE] can be used with Peak Power Sensors to measure the power level of transient or one-shot pulsed microwave signals. After execution of the triggering sequence, send the FETCh? query command to return the measurement data from the 8650A.

Perform triggering configuration with the TRIGger Subsystem commands. When TRIGger:SOURce is IMMEDIATE, the measurement will start as soon as INITiate is sent to the 8650A and executed (or INITiate:CONTinuous ON sent and executed).

INIT:CONT

Syntax:	INITiate:CONTinuous \langle space \langle ON OFF \rangle	
Example:	OUTPUT @PWR_MTR;INIT:CONT ON	! CONTINUOUS TRIGGERING
Description:	<p>This allows user control of measurement cycle arming. When INIT:CONT is set to ON, measurement cycle arming occurs automatically. The default setting is OFF. To take control of arming the triggering of the measurement cycle, set this control to OFF and use MEAS#? or INIT with READ#? to perform the measurement. Another legal measurement control option would be INIT with TRIG: IMM and FETCh#?</p> <p>When INITiate:CONTinuous is ON, the instrument triggering cycle resets continuously. That is, upon instrument triggering, data is constantly being acquired and updated. Upon completion of a trigger cycle, the meter will immediately enter the wait-for-trigger state rather than the idle state, as is the case with INITiate:CONT OFF.</p>	

INIT:IMM

Syntax:	INITiate[:IMMEDIATE]	
Example:	OUTPUT @PWR_MTR;INIT	! INITIATE INSTRUMENT TRIGGERING CYCLE
Description:	<p>This command enables the triggering cycle. Instrument triggering will not occur unless INIT has been enabled, even when sending BUS or EXT triggers to the 8650A. Either this command or INIT:CONT ON performs measurements with FETCh? and READ?. MEAS? is a high level function which contains the INITiation enabling function. Arming occurs automatically when using the MEAS#? command to automatically INITiate, TRIGger and FETCh the measurement data. However, if using READ#? or FETCh#? to read data, this command arms the 8650A for triggering upon the occurrence of the next valid trigger.</p> <p>The INITiate[:IMMEDIATE] command places the power meter in the wait-for-trigger-state. When used with EXT (TTL levels) instrument triggering, this command is useful for measuring signals that are asynchronous with programming (BUS triggered) sequences. When INITiate:CONTinuous is set to OFF, INITiate[:IMMEDIATE] enables the instrument triggering cycle. Sending INITiate[:IMMEDIATE] when INITiate:CONTinuous is set to ON will cause a -123 command error. The INITiate [:IMMEDIATE] command is an event; no query form exists for this command.</p>	

3.2.16 Channel Configuration

- **CALCulate:POWer**
- **CALCulate:RATio**
- **CALCulate:DIFFerence**
- **CALCulate?**
- **CALCulate:UNIT**
- **CALCulate:STATe**
- **CALCulate:STATe?**
- **CALCulate:CFACTor:STATe**
- **CALCulate:CFACTor:DATA?**
- **CALCulate:PHOLD:STATe**
- **CALCulate:PHOLD:STATe?**
- **CALCulate:PHOLD:DATA?**
- **CALCulate:MODE**
- **CALCulate:SFUNctions:STATE**
- **CALCulate:SFUNctions:DATA?**

CALC#:POW

Syntax:	CALCulate < channel 1 to 4 > [:CHANnel]:POWerspace < sensor 1 or 2 >	
Example:	OUTPUT @PWR_MTR;CALC2:POW 1	! CONFIGURES CHANNEL 2 TO ! MEASURES SENSOR 1 POWER
Description:	This command configures a sensor to an individual channel, and the channel measures the sensor power level. This command does not have a query format. For the example above, the response to a CALC2? query is POW 1. This command should be executed only after the designated sensor has been calibrated.	

CALC#:RAT

Syntax:	CALCulate < channel 1 to 4 > [:CHANnel]:RATiospace < sensor 1 or 2comma sensor 2 or 1 >	
Example:	OUTPUT @PWR_MTR;CALC1:RAT 2,1	! CONFIGURES CHANNEL 1 TO MEASURE ! SENSOR 2 OVER SENSOR 1 POWER
Description:	This command configures a channel as a ratio of the power levels present at the two sensors. When UNITS are dBm, RATio configuration produces measurements in dB. When UNITS are Watts, RATio configuration measurements are percentage. This command does not have a query format. For the above example, the response to a CALC1? query is RAT 2,1. This command should be executed only after the designated sensor has been calibrated.	

CALC#:DIFF

Syntax:	CALCulate < channel 1 to 4 > [:CHANnel]:DIFFerencespace < sensor 1 or 2comma sensor 2 or 1 >	
Example:	OUTPUT @PWR_MTR;INIT:CONT ON	! CONFIGURES CHANNEL 1 TO MEASURE ! SENSOR 2 MINUS SENSOR 1 POWER
Description:	This command configures a channel as the difference between the power levels present at the two sensors. UNITS are dBm or Watts. This command does not have a query format. For the above example, the response to a CALC1? query is DIFF 2,1. This command should be executed only after the designated sensor has been calibrated.	

CALC#?

Syntax:	CALCulate < channel 1 to 4 > [:FUNCTION]?	
Example:	OUTPUT @PWR_MTR;CALC2?	! QUERIES CHANNEL 2 SENSOR CONFIGURATION
Response:	POW #, RAT #, #, OR DIFF #, #	
Description:	This command returns the current channel configuration. This command is a query format only.	

CALC#:UNIT

Syntax:	CALCulate < channel 1 to 4 > :UNIT[:POWER]space < data units selection, dBm or Watt >	
Example:	OUTPUT @PWR_MTR;CALC1:UNIT W	! SELECTS CHANNEL 1 LINEAR UNITS, WATTS
Example 2:	OUTPUT @PWR_MTR;CALC1:UNIT DBM	! SELECTS CHANNEL 1 LOG UNITS, DBM
Description:	This command configures a channel to report power measurements in either linear Watts units or logarithmic dBm units. When UNIT is dBm, the RATio configuration produces measurements in dB, and POWer and DIFF measurements in dBm. When UNIT is Watts, the RATio configuration measurements are percentages, and POWer and DIFF measurements are in Watts.	

CALC#:STAT

Syntax:	CALCulate < channel 1 to 4 > :STATspace < ON OFF >	
Example:	OUTPUT @PWR_MTR;CALC1:STAT OFF	! DISABLES CHANNEL 1 MEASUREMENT
Description:	This command turns a channel off or on. Default is ON. During Normal and Swift modes, measurement speed increases when only one sensor (Channel Configuration is CALC#:POW) is performing measurements.	

CALC#:STAT?

Syntax:	CALCulate < channel 1 to 4 > :STATe?	
Example:	OUTPUT @PWR_MTR;CALC1:STAT?	! QUERIES CHANNEL 1 MEASUREMENT STATUS
Response:	0 = off, 1 = on	
Description:	This command is the query format of the command above.	

CALC:CFACTOR:STATE

Syntax:	CALCulate < channel 1 to 4 > CFACTOR:STATspace < ON OFF >	
Example:	OUTPUT @PWR_MTR;CALC1:STAT ON	! ENABLE/DISABLE CREST FACTOR MEASUREMENTS
Description:	Enables crest factor measurements. Sending 'ON' when crest factor is already enabled causes the value to be reset. The crest factor function holds on to the highest instantaneous power measured from the time the function is enabled until it is reset.	

CALC:CFACtor:DATA?

Syntax:	CALCulate < channel 1 to 4 > CFACtor:DATA?	
Example:	OUTPUT @PWR_MTR;CALC3:CFAC:DAT?	! READS THE CREST FACTOR MEASUREMENT
Description:	Reads the crest factor measurement from display channel line 3.	

CALC:PHOLd:STATe

Syntax:	CALCulate < channel 1 to 4 > PHOLd:STATe <i>space</i> < ON OFF >	
Example:	OUTPUT @PWR_MTR;CALC1:PHOL:STAT ON	! ENABLES/DISABLE PEAK HOLD FUNCTION
Description:	The Peak Hold feature causes the measured value to hold at the highest instantaneous power measured from the time the feature is enabled until it is reset (the measured value changes only when it is rising to a new maximum, or when it is reset).	

CALC:PHOLd:STAT?

Syntax:	CALCulate < channel 1 to 4 > PHOLd:STAT?	
Example:	OUTPUT @PWR_MTR;CALC1:PHOL:STAT?	! ENABLES/DISABLE PEAK HOLD FUNCTION
Description:	This command is the query format of the command above.	

CALC:PHOLd:DATA?

Syntax:	CALCulate < channel 1 to 4 > PHOLd:DATA?	
Example:	OUTPUT @PWR_MTR;CALC1:PHOL:DAT?	! READS THE PEAK HOLD MEASUREMENT
Description:	The Peak Hold function monitors the maximum power as it is measured; but does not provide any feedback to the controller until a Peak Hold command or CALC#:PHOL:DAT? is received.	

CALC:SFUNctions:STATe

Syntax:	CALCulate < channel 1 to 4 > :SFUNctions:STATe <i>space</i> < ON OFF >	
Example:	OUTPUT @PWR_MTR;CALC3:SFUN:STAT ON	! ENABLES/DISABLE STATISTICAL FUNCTIONS
Description:	This command enables or disables the statistic computation function of mean and standard deviation over a period of time.	

CALC:SFUNctions:DATA?

Syntax:	CALCulate < channel 1 to 4 > :SFUNctions:DATA?	
Example:	OUTPUT @PWR_MTR;CALC3:SFUN:DAT?	! READS STATISTICAL MEASUREMENT
Description:	The command queries statistics data of the current active GPIB measurement. Error measurement is returned if statistics is not active.	

Example programs for Channel Configuration are contained in Appendix A.

3.2.17 Cal Factor Correction

- **SENS#:CORR:FREQ**
- **MEMory:FREQuency**
- **MEMory:SElect**
- **MEMory:SLOPe**

Power Sensors have a measurable frequency response. During manufacture, this response is calibrated at 1 GHz intervals. Instead of printing the data on the sensor label, each Giga-tronics power sensor includes a built-in EEPROM which has been programmed with the frequency calibration factor data for that particular power sensor.

The following SCPI commands tell the 8650A the operating frequency of the measured microwave or RF signal. Thus, the meter automatically interpolates the correct Cal Factor and applies that value to the measurement data. By performing this automatically, there is no need to read Cal Factor data from the side of sensor housings and program the data into tables within the ATE programming. Except for advanced measurement techniques using Burst Mode, there is no need to write cal factor interpolation routines; this is all done by the power meter. As shown below, sensor Cal Factor data can be read into the computer. Also see the Sensor EEPROM Commands in Section 3.2.34 for Cal Factor programming.

SENS#:CORR:FREQ

Syntax:	SENSe < sensor 1 or 2 > :CORRection:FREQuency[:CW-FIXed] 5e7	
Example:	OUTPUT @PWR_MTR;SENS2:CORR:FREQ 5E7	! SETS SENSOR 2 FREQUENCY TO 50 MHZ
Response:	0 = off, 1 = on	
Description:	This command allows correcting for sensor frequency response characteristics. The power meter uses this frequency to automatically interpolate and apply the Cal Factor for that sensor (computed from Cal Factor data points stored within each sensor's EEPROM). Unless the EEPROM has been modified subsequent to shipment, the Cal Factor is always 0.0 dB at 50 MHz, 5e7. Be sure to correct for sensor cal factor by using this command, using automated V_{PROPF} correction, sending cal factor REFERENCE value, or correcting for Cal Factor in the ATE system by downloading Cal Factor points for the 8650A.	

SENS#:CORR:FREQ

Syntax:	SENSe < sensor 1 or 2 > :CORRection:VPROpf[:STATE]space < ON-OFF >	
Example:	OUTPUT @PWR_MTR;SENS1:CORR:VPRO ON	! ENABLES SENSOR 1 V_{PROPF} FUNCTION
Description:	Setting this control to ON activates V_{PROPF} and deactivates SENS#:CORR:FREQ.	



NOTE: Example programs for Cal Factor Corrections are contained in Appendix A of this publication.

MEM:FREQ

Syntax:	MEMory[:TABLE]:FREQuency <i>space</i> < Start frequency >	
Example:	OUTPUT @PWR_MTR;MEM:FREQ 1E9	! SETS V _{PROP} F FREQUENCY TO 1 GHZ
Description:	This command sets the automated V _{PROP} F correction start frequency. The frequency at which the voltage input into the 8650A is 0.0 V.	

MEM:SEL

Syntax:	MEMory[:TABLE]:SElect <i>space</i> < ANALOGout,VPROpf1,VPROpf2 >	
Example:	OUTPUT @PWR_MTR;MEM:SEL VPROPF1	! SELECTS MEMORY TABLE V _{PROP} F1 ! FOR EDITING IN FOLLOWING LINES
Description:	This command selects between one of three editable tables. Using the meter's automated V _{PROP} F capability to correct for Cal Factor requires configuring the V _{PROP} F IN connector to match the signal that source will output. This is performed by setting the frequency so that source's V _{PROP} F output is 0.0 V. Then the slope relationship is entered in the form of a value representing the V/Hz relationship. If source is a Giga-tronics GT 9000 Series Signal Generator, this relationship is 0.5 V/GHz or 5e-8 V/Hz.	

MEM:SLOP

Syntax:	MEMory[:TABLE]:SLOP <i>space</i> < Volts per Hz >	
Example:	OUTPUT @PWR_MTR;MEM:SLOP 1E-9	! SETS V _{PROP} F SLOPE TO 1 V/GHZ
Description:	This command sets the V/Hz relationship for automated Cal Factor correction.	

3.2.17.1 Cal Factor Error Control

- See Error Messages in Section 3.2.36
- Selected basic SCPI syntax and execution errors apply to these commands
- Device-specific errors include the following and other -300 level errors
- A common device-specific error occurs when the frequency sent to the 8650A in the **SENS#:CORR:FREQ ###** command is outside the sensor operating frequency range. For example, sending SENS1:CORR:FREQ 18.4e9 when an 18 GHz (max) 80301A CW Power Sensor is attached will yield a device-specific error

3.2.18 High Speed Measurements

- **CALCulate:DATA?**
- **CALCulate:MODE**
- **TRIGger:MODE**
- **TRIGger:DElay**
- **TRIGger:COUNT**

Measurements in Normal mode are fastest with only one sensor attached. When two sensors are attached, the Normal mode measurement rate is reduced. This applies for all three major measurement commands, FETCh, READ and MEASure. Both of the averaging types, MOVing and REPeat, slow down when in the Normal mode. MOVing provides faster averaging; the speed is equivalent to REPeat whenever the Averaging number is 1.

When performing measurements in either Swift or Burst modes, measurement rates are the same with two sensors as with one sensor. Approximate measuring speeds are listed in Table 1-1.

CALC:DATA?

Syntax:	CALCulate < channel 1 to 4 > :DATA?	
Example:	OUTPUT @PWR_MTR;CALC1:DATA?	! QUERIES CHANNEL 1 & 2 BURST MODE DATA
Description:	<p>This command interrupts the burst measurement and dumps the measurement buffer. All empty locations will be filled with -300 before the data dump. The Burst mode remains active after this command so that a trigger will start a new measurement reference.</p> <p>The command returns measurement data (while the measurement is completing) during BURSt mode only. This command is not used in NORMal or SWIFt Modes. Operation is similar to using FETCh? Both are instrument (not channel) commands. That is, when both sensors are connected, calibrated, and the channel set to ON, this command will return power level data for both channels.</p>	

3.2.18.1 Operating Mode Control

The Operating mode is controlled through the CALC#:MODE command. The choices are NORMal, BURSt, SWIFt and FMOD. Sending CALC1:MODE will set the operating mode for the entire instrument, not just for channel 1. The fast mode permits more frequent return of measurement data to the host during operation in the modulated measurement modes (MAP, PAP or BAP).

CALC:MODE

Syntax:	CALCulate < channel 1 to 4 > :MODE <i>space</i> < NORMal, BURSt, SWIFt or FMOD selection >	
Example:	OUTPUT @PWR_MTR;CALC2:MODE FMOD	! SETS THE MEASUREMENT TO FMOD
Description:	<p>This command sets the measurement mode. This is NOT a channel-specific command; it is an instrument configuration command. Selecting one channel changes both channels to the desired mode. Use this command to select the level of functionality and performance for unique applications. NORMal Mode is full functioned. SWIFt Mode allows individual data point triggering. BURSt Mode allows the fastest measurement rates. FMOD added to the list of available modes.</p>	

Series 8650A Universal Power Meters

The following commands are duplicates of those given in the Instrument Triggering section of this chapter and are shown here for convenience. These commands must be used with BURSt mode operation.

TRIG:MODE

Syntax:	TRIGger:MODE <i>space</i> < burst mode data gathering POST trigger receipt or PRE trigger receipt >	
Example:	OUTPUT @PWR_MTR;TRIG:MODE POST	! SETS BURST OR SWIFT MODE DATA COLLECTION ! RELATIVE TO TIMING OF EVENT TRIGGER POST
Description:	This command is only for BURSt Mode measurements. Send this command only after CALC#:MODE BURS. TRIG:MODE controls the operation of the FIFO data buffer in the 8650A. When set to POST, the burst of data points is taken after the receipt of a valid instrument trigger. When set to PRE, the burst of data is assumed to be those data points that have arrived immediately preceding the valid instrument trigger event. Using PRE requires some caution: the single processor inside the 8650A is performing data acquisition constantly. Sending any configuration commands while the 8650A is collecting the PRE trigger data, interrupting the timing of the data point collection can be done.	

TRIG:DEL

Syntax:	TRIGger:DEL <i>space</i> < delay time between buffered readings in sec, 0.000 to 5.000 >	
Example:	OUTPUT @PWR_MTR;TRIG:DEL 5E-3	! SETS BURST MODE MEASUREMENT TIME TO ! 5 MS BETWEEN MEASUREMENTS
Example 2:	OUTPUT @PWR_MTR;TRIG:DEL 0	! MAX. MEASUREMENT RATE, 5100/SEC. (RESOLUTION, ONE MSEC)
Description:	<p>This command applies only to BURSt Mode. It sets the time interval between the measurements; it is accurate to about 5%. This is the only way to control the meter's data acquisition of individual data points in a burst measurement. Burst measurement data is taken following or just prior to a single instrument trigger event. The number of measurements taken is controlled by TRIG:COUNt. Timing can be set in 0.001 second increments from 0.000 to 5.000, inclusive. Setting this control to 0.000 activates the highest reading rate possible with 8650; 5100 readings per second.</p> <p>Triggering of the Peak Power Sensor occurs independently from instrument triggering. There is a moderate ability to control triggering at the Peak Power Sensors. Generally, if requiring control of individual data point triggering, SWIFt mode will provide the highest measurement rates, with or without SRQ or hardware handshaking. The 8650A controls its gain ranges transparently by verifying internal range changes just before and just after individual measurement points. If the internal range does not remain the same, the data point will be discarded as invalid.</p>	

TRIG:COUN

Syntax:	TRIGger:COUN <i>space</i> < number of data values to buffer in memory from 1 to 5000 >	
Example:	OUTPUT @PWR_MTR;TRIG:COUN 100	! SETS BURST OR SWIFT MODE BUFFER READING ! NUMBER TO 100
Description:	<p>The 8650A has an internal data buffer for storing measurement data until the slot 0 controller/resource manager is ready to read the data. During SWIFt or BURSt modes, this command controls the number of power readings that are stored in the 8650A data buffer.</p> <p>The value specified here applies to each channel. If two sensors are attached and calibrated, the 8650A will perform the specified measurement and buffering for both channels. In the example above, that would be 100 points per channel.</p> <p>During BURSt mode, the COUNT # of readings will be taken with just one instrument trigger. During SWIFt Mode however, control the triggering of individual data points. Setting triggering to EXT, the 8650A will perform one measurement each time a TTL level signal is detected by the 8650A. Then the value is stored in the data buffer. This continues until the 8650A has received and operated the COUNT # of triggers and also read in the COUNT # of data points to the buffer.</p>	

3.2.18.2 Triggering Notes

Refer to Instrument Triggering in Section 3.2.14 for more information.

EXT triggering is performed with the front panel BNC connector and will work only in BURSt and SWIFt Modes. EXT triggering is not available in NORMal Mode. Provision has been made for a hardware ready type handshaking capability using the analog output. This feature can be used as a loop back test when performing troubleshooting procedures.

BUS triggering is available for all operating modes, BURSt, SWIFt and NORMal.

IMMediate triggering is not compatible with BURSt and SWIFt Modes. If sending the CALC#:MODE BURS command to enter the BURSt Mode, IMM instrument triggering for NORMal Mode will automatically be switched to TRIG:SOUR BUS. If using the CALC#:MODE SWIF command to enter the SWIFt Mode, IMM instrument triggering will remain IMM, but a device-specific error will be generated whenever specifying a TRIG:COUN # higher than 1. Using the FETCh#? measurement query, taking accurate measurements can be done anyway; do not set TRIG:COUN.

Using FETCh#? when having time-dependent measurement processes can be a little tricky unless using SRQs. If the 8650A has not had enough time to process the measurement or has not received a trigger, it will return an abnormally large number — 9.e40 is common, but other obviously invalid readings can occur. Not using SRQs is fastest for measurement speed, manage the measurement/triggering timing problem closely.

3.2.18.3 Measurement Level Notes

The SWIFt Mode should not be used for measuring power in the bottom 10 dB of the CW dynamic range. At low power levels, the NORMal mode reduces the measurement speed to account for the effects of noise.

Example programs for High Speed Measurements are contained in Appendix A.

3.2.19 Peak Power Sensor Triggering

■ SENSE:TRIGger

The Peak Power Sensors sample power levels almost instantaneously. Since there is a sampler built into the Peak Power sensor housing, there are several controls to configure the source of the sensor trigger signal. These include the delay time from triggering to when the sample is to be taken (Sample Delay), and the trigger level. All Peak Power Sensors will operate in the SWIFt and BURSt modes when in the CW measurement mode (SOURce) configuration (not when using INT or EXT trigger).

SENSe:TRIGger

Syntax:	SENSe < sensor 1 or 2 > :TRIGger:SOURce:space < INTernal, EXTernal, or CW >	
Example:	OUTPUT @PWR_MTR;SENS1:TRIG:SOUR CW	! SETS SENSOR 1 PEAK TRIGGER MODE TO CW MODE
Description:	<p>This command controls the trigger source for the sensors. Both the 80350A Series respond to this command. INTernal triggering is performed automatically by the 80350A Sensor; however, the trigger level must be set to a value of power that is lower than the power level of the pulsed signal incident upon the sensor. EXTernal triggering is performed by inputting a baseband pulse into the rear connector on the sensor housing. BNC to SMB cables have been provided for this purpose. For high speed trigger pulses, SMB to SMA adapters are available from Giga-tronics. CW triggering sets the power sensors to measure CW power and triggering is essentially disabled. CW is automatically set by the 8650A during power sweep calibration; do not apply any triggering to the peak power sensor during power sweep calibration.</p> <p>Be sure to set the trigger level, SENS:TRIG:LEV ###.# after the INTernal or EXTernal triggering is selected.</p>	

Syntax:	SENSe < sensor 1 or 2 > :TRIGger:DELay(:MAGnitude):space < delay in seconds from -20e-9 to 105e-3 >	
Example:	OUTPUT @PWR_MTR;SENS1:TRIG:DEL 1E-/6	! SETS SENSOR 2 PEAK DELAY VALUE TO 1E-6 ! SECONDS
Description:	<p>The SENS:TRIG:DEL # is the time in seconds between the 80350A Series Peak Power Sensor's receipt of a sensor trigger (INT is auto, EXT is a trigger input) and the time that the sampler is fired. This delay is typically accurate to about 0.5%; repeatability is an order of magnitude better. There is a delay line built into the peak power sensor. Therefore, measuring the power on the leading edge of the pulsed signal even if it is the same edge on which the sensor was triggered. This also allows limited look ahead capability as identified by the allowed negative time values for this command. The other reason negative time values are allowed is due to the sample delay offset capability.</p>	

Syntax:	SENSe < sensor 1 or 2 > :TRIGger:DELay:STATespace < ON OFF >	
Example:	OUTPUT @PWR_MTR;SENS1:TRIG:DEL:STAT ON	! ENABLES PEAK SENSOR 1 DELAY FUNCTION
Description:	This command activates the sample delay in the 80350A Series Peak Power Sensors.	

Syntax:	SENSe < sensor 1 or 2 > :TRIGger:LEVel[:MAGNitude]space < R In EXT triggering use -0.1 to 5.000 V. In INT triggering use -30 to +20 dBm >	
Example:	OUTPUT @PWR_MTR;SENS1:TRIG:LEV 1.7	! SETS PEAK SENSOR 1 TRIGGER LEVEL TO 1.7 VOLTS
Description:	<p>This command sets the trigger level for the 80350A Series Peak Power Sensors. Under INTERNAL triggering the value is in dBm (-30 to +20 dBm, with default of -20 dBm). When EXTERNAL triggering is used the value is in Volts (-0.100 to 5.000 V, with a default of 1.700 V). The trigger level must be lower than the signal that is triggering the peak power sensor. Under Internal triggering, this means that a -16 dBm signal must be triggered with a setting that is less than -16 dBm. EXT responds similarly. The input impedance to the EXT trigger port on the back of the sensor housing is not 50 ohms: it is a high impedance to prevent damage from triggering inputs such as 5.0 V TTL signals. Using a high speed 50 Ω trigger source, this may cause unwanted signal reflections and noise on the trigger line. An SMB to SMB attenuator is available from Giga-tronics to alleviate this condition. The attenuation reduces the reflected noise, and reduces/eliminates the noisy trigger characteristics.</p> <p>Be sure to set the trigger level after the INTERNAL or EXTERNAL triggering is selected.</p>	
Syntax:	SENSe < sensor 1 or 2 > :TRIGger:OFFSet[:MAGNitude]	
Example:	OUTPUT @PWR_MTR;SENS1:TRIG:OFFS 0	! SETS PEAK SENSOR 1 TRIGGER OFFSET TIME TO 0 ! SECOND
Description:	This command sets the peak power sensor trigger offset time.	
Syntax:	SENSe < sensor 1 or 2 > :TRIGger:TOTAL[:MAGNitude]?	
Example:	OUTPUT @PWR_MTR;SENS1:TRIG:TOTA?	! QUERIES PEAK SENSOR 1 TOTAL TRIGGER DELAY ! TIME
Response:	Current peak power sensor total trigger delay setting; a single value in seconds.	
Description:	This query reports the peak power sensor total trigger delay time.	

3.2.20 Averaging

■ SENSE:AVERAge

Averaging is applied during normal operating mode. In the normal mode, Avg_n results in n x 192 samples taken. In the Swift or Burst modes, Avg_n results in 2_n samples taken. Auto averaging takes 4 samples all the time. For auto averaging in the normal mode, the averaging number is level dependent with very low averaging at +20 dBm, and many samples taken at very low levels.

SENSe:Average

Syntax:	SENSe < sensor 1 or 2 > :AVERAge:COUNTspace < 1,2,4,8,16,32,64,128,256, or 512 >	
Example:	OUTPUT @PWR_MTR;SENS1:AVER:COUN 16	! SETS SENSOR 1 AVERAGE NUMBER TO 16
Description:	This command averages successive sensor readings in a digital averaging filter. As the measured signal level approaches the noise floor of the power sensor, measurement data values begin to fluctuate. To measure very low signal levels (within a few dB of the sensor noise floor), set a large value for averaging such as 128, 256, or 512. Be sure to zero the sensor, CALibration:ZERO, prior to critical measurements.	

Syntax:	SENSe < sensor 1 or 2 > :AVERAge:COUNT:AUTOspace < ON OFF >	
Example:	OUTPUT @PWR_MTR;SENS2:AVER:COUN:AUTO ON	! SELECTS SENSOR 2 AUTO-AVERAGING MODE
Description:	Auto-Averaging optimizes the measurement averaging value for reading stability and update rate when the measurement data is being repeatedly updated. At high power levels (measured), minimum averaging is applied to optimize measurement speed. As the power level drops, additional averaging is applied to steady the measured data reading.	

Syntax:	SENSe < sensor 1 or 2 > :AVERAge:TCONtrolspace < data acquisition averaging method, MOVing or REPeat >	
Example:	OUTPUT @PWR_MTR;SENS1:AVER:TCON REP	! SETS SENSOR 1 TO ACQUIRE FRESH ! MEASUREMENT DATA BEFORE AVERAGING
Description:	<p>The SENSE:AVERAge:TCONtrol commands are instrument level commands that control the internal measurement data averaging of the power meter. Two modes are selectable, MOVing and REPeat.</p> <p>The MOVing control applies the current measurement to the previously measured data. That is, even if the averaging number is 16, a measurement data point every time a sample is taken will occur, not just after every 16 samples. There is some limited built in level sensing capability. For example, when Auto-Averaging is used and the power is suddenly changed from a low value to a high, MOVing averaging throws out the very low level previous data as the gain range changes and begins averaging fresh data. Thus, wide abrupt changes in power level are not masked by the MOVing averaging. The 8650A can fully range in about 4 ms. MOVing averaging is similar to TR1 mode in typical benchtop power meters.</p> <p>REPeat averaging performs full averaging every time the 8650A is triggering. Unless the averaging number is set to 1, REPeat is slower than MOVing averaging. REPeat control is similar to TR2 mode in typical benchtop power meters. Fresh data is measured and averaged with each complete measurement cycle.</p>	

3.2.21 Relative or Referenced Measurements

■ CALCulate:REFerence

Relative and referenced measurements are used when one measured value needs to be compared to another measured value on the same channel. For example, this function is used when it is desired to monitor the power level variation around an initial turn on or reference set value.

Referenced measurements are performed when finding the 1 dB compression power of an amplifier or using a return loss bridge. When a stable source is used, a relative measurement is useful for measuring the loss through an attenuator with a single sensor or channel.

Due to the ability to set a specific value of reference using the CALC:REF[MAG] # command, this reference measurement function can also be used setting personal calibration factors. Thus the channel and sensor offset functions can remain dedicated to other setup dependent controls in programming.

CALCulate:REFerence

Syntax:	CALCulate < channel 1 to 4 > :REFerence:STATespace < ON OFF >	
Example:	OUTPUT @PWR_MTR;CALC2:REF:STAT ON	! ACTIVATES LEVEL REFERENCE FOR RELATIVE ! MEASUREMENTS
Description:	This command activates the meter's level reference to give it the ability to perform relative measurements.	

Syntax:	CALCulate < channel 1 to 4 > :REFerence [:MAGnitude] < dB Offset value from -299.999 to 299.999 >	
Example:	OUTPUT @PWR_MTR;CALC2:REF -30.11	! SETS CHANNEL 2 REFERENCE OFFSET VALUE IN DB
Description:	This command sets the value to subtract from the channel measurement value. This command applies to the channel (1, or 2, or 1/2, ...), not the sensor (1 or 2, only).	

Syntax:	CALCulate < channel 1 to 4 > :REFerence:COLLect	
Example:	OUTPUT @PWR_MTR;CALC2:REF:COLL	! CURRENT RDG. == > REF LEVEL. ! TAKE CHANNEL 2 READING AS REFERENCE VALUE
Description:	The CALCulate:REFerence:COLLect command will cause the level of the current power measurement to become the reference level. There is no query form of this command. After sending this command, the channel measurement will be zero, assuming the power levels at the sensor(s) did not change and REF:STAT is ON.	

3.2.21.1 Error Control

- Selected basic SCPI syntax and execution error apply to these commands.
- Device-specific errors include the following and other -300 level errors.
- Use **CALC:REF** commands only in the NORMal Mode. Attempts to use these commands in the SWIFt and BURSt modes will be ignored and the error, -300, Device-specific error; Normal mode is off, will be generated.

3.2.22 Offsets

■ SENSE:CORRection

Sensor power offsets apply to the individual sensor. Use sensor offsets to account for the loss of attenuators, which are commonly used during measurement to reduce standing waves to improve measurement accuracy. If measuring high power signals (>100 mW), but are not using Giga-tronics high power sensors, use a power attenuator between the high power output and the sensor input to prevent damage. Enter the value of attenuation as a sensor offset, and the 8650A will automatically respond with the actual power level output in its measurement data.

SENSE:CORRection

Syntax:	SENSe < sensor 1 or 2 > :CORRection:OFFSet:COLlect	
Example:	OUTPUT @PWR_MTR;SENS1:CORR:OFFS:COLL	! TAKE SENSOR 1 CURRENT READING AS OFFSET ! VALUE
Description:	This command enters the current power level reading as the offset value.	

Syntax:	SENSe < sensor 1 or 2 > :CORRection:OFFSet[:MAGnitude]space < offset value in dB, -99.99 to 99.99 >	
Example:	OUTPUT @PWR_MTR;SENS2:CORR:OFFS 10.2	! COMPENSATE SENSOR 2 FOR 10.2 DB ! ATTENUATION
Description:	This command enters a specific sensor offset value.	

Syntax:	SENSe < sensor 1 or 2 > :CORRection:OFFSet:STATespace < ON OFF >	
Example:	OUTPUT @PWR_MTR;SENS2:CORR:STAT ON	! ENABLES SENSOR 2 OFFSET CORRECTION
Description:	This command activates and deactivates the sensor offset function.	

3.2.23 Communication Configurations

- **STATus:COMMunicate:SERial:RECeive**
- **STATus:COMMunicate:SERial:TRANsmit**

STAT:COMMunicate:SERial:RECeive

Syntax:	SYST:COMMunicate:SERial:RECeive:BAUDspace < baud rate > (Where baud rate values are: 300, 1200, 2400, 4800, 9600, 19200, 38400)	
Example:	OUTPUT@PWR_MTR; "SYST:COMM:SER:REC:BAUD 38400"	! SETS THE RECEIVE BAUD RATE TO 38400
Example 2:	OUTPUT@PWR_MTR; "SYST:COMM:SER:REC:BAUD?" (Command is available for GPIB and RS-232 connection)	
Description:	Command modifies the receive baud rate for the RS-232 communications port to the specified baud rate. Query form is available.	

STAT:COMMunicate:SERial:TRANsmit

Syntax:	SYST:COMMunicate:SERial:TRANsmit:BAUDspace < baud rate > (Where baud rate values are: 300, 1200, 2400, 4800, 9600, 19200, 38400)	
Example:	OUTPUT@PWR_MTR; "SYST:COMM:SER:TRAN:BAUD 38400"	! SETS THE RECEIVE BAUD RATE TO 38400
Example 2:	OUTPUT@PWR_MTR; "SYST:COMM:SER:TRAN:BAUD?" (Command is available for GPIB and RS-232 connection)	
Description:	Command modifies the transmit baud rate for the RS-232 communications port to the specified baud rate. Query form is available.	

3.2.24 SRQ & Status Monitoring

- ***CLS**
- ***ESE**
- ***ESR?**
- ***OPC**
- ***OPC?**
- ***SRE**
- **STATus:OPERation**
- **STATus:PREset**
- ***STB?**

*CLS

Example:	OUTPUT @PWR_MTR;*CLS	! CLEARS SRQ AND STATUS BYTE REGISTERS
Description:	<p>*CLS is the clear status command defined by IEEE 488.2. This command clears all of the status bytes to the value 0. After a service request interrupt is transmitted from the 8650A to the controller, use the *STB command to read the status byte from the 8650A. Then reset the SRQ and use *CLS clear status command to reset the numeric status indication of the status byte/registers to 0 (all bits will be 0).</p> <p>*CLS does not affect the enabled or disabled status of the status byte/register masks. For example, having bit 8 of the operation register enabled before sending *CLS, it will remain enabled afterward. *CLS also clears the output queue (takes 0.3 sec to complete this function).</p>	

*ESE

Syntax:	ESEspace < event status register value, 0 to 255 >	
Example:	OUTPUT @PWR_MTR;*ESE 16	! ENABLES BIT 4 OF EVENT STATUS REGISTER MASK
Description:	This command sets/clears the event status register enable mask.	

*ESR?

Example:	OUTPUT @PWR_MTR;*ESR?	! RETURNS EVENT STATUS REGISTER VALUE
Description:	This query returns the current status register value.	

*OPC

Example:	OUTPUT @PWR_MTR;*OPC	! *OPC ALLOWS ONE TIME SRQ ENABLE
Description:	*OPC determines when an operation is completed. This command is generally used to monitor the completion of long measurement sequences. It sets the operation complete bit in the event status register upon completion of operation.	

*OPC?

Example:	OUTPUT @PWR_MTR;*OPC?	! RETURNS A VALUE OF 1 AFTER AN OPERATION IS COMPLETED
Description:	The *OPC? operation complete query allows synchronization between the controller and the test set using either the message available (MAV) bit in the status byte, or a read of the output OPC?.	

*SRE

Syntax:	*SREspace < event status register value, 128, 64, 32, 16, 8, 4, 2, 1 >	
Example:	OUTPUT @PWR_MTR;*SRE 32	! ENABLES BIT 5 OF STATUS BYTE REGISTER
Description:	This command sets the mask of the Status Byte register.	

STAT:OPER

Syntax:	STATus:OPERation[:EVENT]?	
Example:	OUTPUT @PWR_MTR;STAT:OPER?	! QUERIES OPERATION EVENT REGISTER RESULT
Description:	This query returns the operation event register result.	

Syntax:	STATus:OPERation:ENABlespace < event register value 0 through 65535 >	
Example:	OUTPUT @PWR_MTR;STAT:OPER:ENAB 1	! SETS THE EVENT REGISTER ENABLE MASK
Description:	This command sets the enable mask, which allows true conditions in the event register to be reported in the summary bit.	

STAT:PRES

Syntax:	STATus:PRESet	
Example:	OUTPUT @PWR_MTR;STAT:PRES	! CLEARS ALL THE STATUS REGISTER VALUE
Description:	This command clears all status registers.	

*STB?

Example:	OUTPUT @PWR_MTR;*STB?	! QUERIES STATUS BYTE REGISTER
Description:	This query returns status byte register result.	
	The SCPI status reporting structure includes the IEEE 488.2 Status Registers. Please note that bit 5 of the OPERation Status Register is only used during BURSt and SWIFt modes. NORMAl mode does not use this function.	

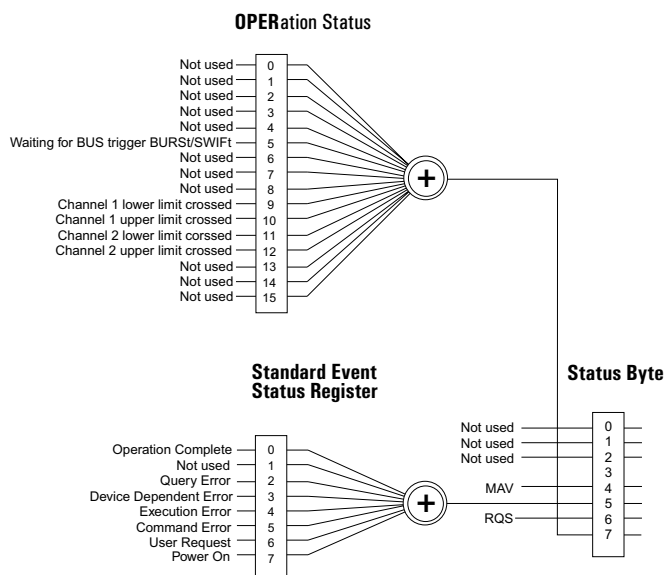

Figure 3-9: SCPI Status Structure Registers

Series 8650A Universal Power Meters

3.2.24.1 Event Status Register

The *ESE command is used in combination with group commands that form the meter's service request system. These commands and their responses are almost identical to the IEEE 488 (GPIB) SRQ service request command structures. The *ESE command is used to enable bits of the event status register mask.

The *ESE command is one of the commands that can be used to monitor the status of the power meter. Together with the status byte (also see commands *STB? or *SRE?) and the operation status register (STATUS:OPERation), the event status register provides information on several critical 8650A functions and error conditions.

7	6	5	4	3	2	1	0
Power On	0	Command Error	Execution Error	Device-Dependent Error	Query Error	0	Operation Complete
Value = 128	Value = 64	Value = 32	Value = 16	Value = 8	Value = 4	Value = 2	Value = 1



NOTE: The logical value in the register is used both to enable a bit's event function and to enable that bit of the event status register mask to report the event status (Following the *ESR? command).

The event status register is 8 bits long and is structured as follows:

Bits 1 and 6 are not used. When bit 3 is a 1, a device-dependent error has occurred. When bit 4 is a 1, an execution error has occurred. When bit 5 is a 1, a command error has occurred. Bit 7 is a 1 when the 8650A is turned ON. The 8650A does not have a standby mode; therefore, it is probably not useful to enable bit 7 of the event status register mask (by sending the command *ESE 128).

In the default state, the meter's event status register is masked, or set to off. None of the bits are enabled. If an execution error occurs, a service request will not be sent to the controller and the event status register will remain set to 0. The *ESE command is used to enable individual bits. These bits must be enabled individually. They can be cleared or turned off as a group by sending the *CLS command.

To use the event status register, bit 5 of the status byte must also be enabled by sending the command *SRE 32.

The *ESR? query returns the current value of the event status register.



NOTE: The logical value in the register is used both to enable a bit's event function and to enable that bit of the event status register mask to report the event status (Following the *ESR? command).

3.2.24.2 Status Byte Register

7	6	5	4	3	2	1	0
Operational Status	Require Service (RQS)	Event Status	Message Available	0	0	0	0

Notes:

1. The condition indicated in bits 1 through 5 must be enabled by the Service Request Mask to cause a Service Request Condition. The mask is set with the *SRE command followed by ASCII characters. The value of the byte is determined by summing the weight of each bit to be checked.
2. The RQS (bit 6) is true when any of the conditions of bits 4, 5 and 7 are enabled and occur.
3. Bits remain set until the Status Byte is cleared.

3.2.25 Min/Max Configuration & Monitoring

- **CALCulate:MAXimum**
- **CALCulate:MINimum**

MIN and MAX channel monitoring records the minimum and maximum variation of channel amplitude over time. Time zero is set by setting the MIN or MAX STATE to ON. The default Preset and turn on configuration is ON. After setting to ON, the minimum and maximum value of the measured value on that channel will be recorded. To reset the MIN and MAX value back to the current value, set the STATE to ON again. The STAT OFF does not need to be sent during reset of MIN and MAX values. Individual sensor minimum and maximum power level variations can be monitored only if that sensor is defined directly to a channel with POW 1 or POW 2. MIN and MAX channel monitoring is only available in Normal Mode. BURSt and SWIFt modes do not perform MIN and MAX monitoring.

CALC:MAX

Syntax:	CALCulate < channel 1 to 4 > :MAXimum:STATespace < ON OFF >	
Example:	OUTPUT @PWR_MTR;CALC2:MAX:STAT ON	! ENABLES CHANNEL 2 MAXIMUM TRACKING
Description:	ON activates the MAX monitoring function. The maximum value of the channel (not sensor) is monitored until the value is reset by CALC#:MAX:STAT ON or CALC#:MAX:STAT OFF is sent.	

Syntax:	CALCulate < channel 1 to 4 > :MAXimum[:MAGnitude]?	
Example:	OUTPUT @PWR_MTR;CALC2:MAX?	! QUERIES CHANNEL 2 MAXIMUM VALUE IN DBM
Response:	Highest power reading since CALC2:MAX:STAT ON was sent.	
Description:	This command reports the value maintained as the maximum in the 8650A max monitor.	

CALC:MIN

Syntax:	CALCulate < channel 1 to 4 > :MINimum:STATespace ON OFF	
Example:	OUTPUT @PWR_MTR;CALC1:MIN:STAT ON	! ENABLES CHANNEL 1 MINIMUM TRACKING
Description:	This command activates the minimum channel value monitor.	

Syntax:	CALCulate < channel 1 to 4 > :MINimum [:MAGnitude]?	
Example:	OUTPUT @PWR_MTR;CALC1:MIN?	! QUERIES CHANNEL MINIMUM VALUE IN DBM
Response:	Lowest power reading since CALC2:MIN:STAT ON was sent.	
Description:	This command reports the value maintained as the minimum in the 8650A min monitor.	

3.2.26 Limit Line Configuration & Monitoring

■ CALCulate:LIMit

The CALCulate:LIMit commands specify and query the status of power measurement limit values and limit line pass/fail checking. This allows the 8650A to monitor measured values and determine if the values are outside certain limits or above/below a single limit. The upper limit cannot be specified any lower than the lower limit; meaning that an exclusion zone of values cannot be specified.

Limit values can be specified separately for either of the two software calculation channels - 1 and 2. These channels can be specified to correspond to power sensors 1 and 2 (default) or as a combination of the power sensors. For example, set limit lines to monitor overload or under range conditions on an amplifier's output power and gain by specifying channel 1 as sensor 1 limits checking and channel 2 as Sensor 2/Sensor 1. Power sensor assignments to channel measurement definition is also part of the CALCulate Subsystem. Limit monitoring can not be performed for individual sensors unless a channel is configured for single sensor, POW 1 or POW 2 operation.

Upper and Lower limits can be active simultaneously.

Unless serial requests are enabled, the CALCulate:LIMit commands can not be configured to automatically alert the controller directly during a limit violation; the 8650A must be queried to receive information regarding pass/fail status of limit line violations.

Automatic notification of limit line violations is accomplished using the status byte and the operation register. A controller can be notified of a limit line violation via the request service, *SRE command. After the controller receives the request service, query the event status register. Check the status register for a limit line violation or send CALCulate:LIMit:FAIL? to check if a limit line is being or has been violated. 1 indicates a limit line violation. 0 indicates the channel measurement is within the limit lines.

CALCulate:LIMit

Syntax:	CALCulate < channel 1 to 4 > :LIMit:CLEar[:IMMEDIATE]	
Example:	OUTPUT @PWR_MTR;CALC1:LIM:CLE	! RESET CHANNEL 1 LIMIT VIOLATION INDICATOR TO 0
Description:	This command resets the limit line pass/fail indicator to 0.	

Syntax:	CALCulate < channel 1 to 4 > :LIMit:FCOunt?	
Example:	OUTPUT @PWR_MTR;CALC1:LIM:FCO?	! QUERIES NUMBER OF CHANNEL 1 LIMIT FAILURES
Response:	Single number; the number of times the limit lines were exceeded.	
Description:	This command reports the number of times a limit line has been exceeded since the limit checking function was set to ON, or the limit line monitor was cleared with CALC#:LIM:CLE.	

Syntax:	CALCulate < channel 1 to 4 > :LIMit:FAIL?	
Example:	OUTPUT @PWR_MTR;CALC1:LIM:FAIL?	! CHECK FOR CHANNEL 1 LIMIT LINE VIOLATION
Response:	0 = OK; 1 = fail	
Description:	This command reports whether or not a limit line has been exceeded since the limit checking function was set to ON, or the limit line monitor was cleared with CALC#:LIM:CLE.	

Series 8650A Universal Power Meters

Syntax:	CALCulate < channel 1 to 4 > :LIMit:LOWerspace < numeric value in dB from -299.99 to 299.99 >	
Example:	OUTPUT @PWR_MTR;CALC1:LIM:LOW -50.0	! SETS CHANNEL 1 LOWER LIMIT LINE TO -50 DBM
Description:	This command specifies the lower limit line power level. The value should allow for any offset values currently in use. The default value is -299.99 dB or dBm.	

Syntax:	CALCulate < channel 1 to 4 > :LIMit:STATespace < ON OFF >	
Example:	OUTPUT @PWR_MTR;CALC1:LIM:STAT ON	! ENABLES CHANNEL 1 UPPER AND LOWER LIMIT ! CHECKING
Response:	0 = off; 1 = on	
Description:	This command activates and deactivates the limit line checking. The default condition is OFF.	

Syntax:	CALCulate < channel 1 to 4 > :LIMit:UPPerspace < numeric value in dBm or dB from -299.99 to 299.99 >	
Example:	OUTPUT @PWR_MTR;CALC1:LIM:UPP 17.0	! SETS CHANNEL 1 UPPER LIMIT LINE TO 17 DBM
Description:	This command specifies the upper limit line power level. The value should allow for any offset values currently in use. The default value is 299.99 dB or dBm.	

3.2.27 Analog Output

- **MEMory:CHANnel**
- **MEMory:UNIT**
- **MEMory:POWer**
- **MEMory:VOLTAge**
- **OUTPut:ANALog**

The ANALOG OUT BNC connector on the front panel can be configured to output a voltage that corresponds to the power levels on one of the channels. This is useful for applications such as source leveling or printing to a chart recorder.

The Analog Output operates only in NORMAl Mode. It is automatically deactivated during SWIFt or BURSt modes, and comes back when operation is returned to the NORMAl Mode.

MEM:CHANnel

Syntax:	MEMory[:TABLe]:CHANnel <i>space</i> < channel 1 to 4 >	
Example:	OUTPUT @PWR_MTR;MEM:CHAN 2	! SETS ANALOG OUT TO CHANNEL 2
Description:	This command selects which channel will be present on the analog output connector.	

Syntax:	MEMory[:TABLe]:SElect <i>space</i> < ANALOGout,VPROPF1,VPROPF2 >	
Example:	OUTPUT @PWR_MTR;MEM:SEL VPROPF1	! SELECTS MEMORY TABLE VPROPF1 ! FOR EDITING IN FOLLOWING LINES
Description:	This command selects between one of three editable tables. Using the meter's Analog Output capability requires configuring the numerically linear power measurement to voltage output relationship by defining the corresponding end points of power and voltage.	

MEM:UNIT

Syntax:	MEMory[:TABLe]:UNIT <i>space</i> < choice of units dBm or Watt >	
Example:	OUTPUT @PWR_MTR;MEM:UNIT DBM	! SETS ANALOG OUT POWER UNIT
Description:	This command selects between one of two configurations, log units or linear units. In either case the voltage output will be numerically linear. Be sure to set the units control properly (dBm or W) before trying to set the numeric values.	

MEM:POWer

Syntax:	MEMory[:TABLe]:POWer <i>space</i> < start value from -80 to +20 dBm > <i>comma</i> < stop value from -80 to +20 dBm >	
Example:	OUTPUT @PWR_MTR;MEM:POW -70,20	! SETS ANALOG OUT POWER RANGE (IN DBM) ! FROM -70 TO 20 DBM
Description:	If log units are selected for analog output control, this command selects the beginning and end points of the power levels which will be assigned corresponding voltages at the analog output.	

Series 8650A Universal Power Meters

Syntax:	MEMory[:TABLE]:POWerspace < start value from 0 to 0.01 W > comma < stop value from 0 to 0.01 W >	
Example:	OUTPUT @PWR_MTR;MEM:POW 0,1E2	! SETS ANALOG OUT POWER RANGE (IN WATTS) ! FROM 0 TO 0.01 WATTS
Description:	If linear units are selected for analog output control, this command selects the beginning and end points of the power levels which will be assigned corresponding voltages at the analog output. Also see MEM:VOLT below.	

MEM:VOLTage

Syntax:	MEMory[:TABLE]:VOLTagespace < start value from -10 to +10 V > comma < stop value from -10 to +10 V >	
Example:	OUTPUT @PWR_MTR;MEM:VOLT -7,2	! SETS ANALOG OUT VOLTAGE RANGE FROM ! -8 TO 2 VOLTS CORRESPONDING TO POWER
Description:	This command is not units dependent. It selects the beginning and end points of the voltage levels desired to be present at the analog output. These voltages correspond to the power end points that are defined with either MEM:VOLT or MEM:POW.	

OUTP:ANALog

Syntax:	OUTPut[:BNC]:ANALog[:STATE]space < ON OFF >	
Example:	OUTPUT @PWR_MTR;OUTP:ANA ON	! ENABLES ANALOG OUT FUNCTION
Description:	This command activates and deactivates the analog output. The analog output will not operate unless this control is set to ON.	

3.2.28 Saving & Recalling Configurations

- ***RCL**
- ***SAV**

The 8650A has 21 instrument state memory registers. Registers 1 through 20 are available for store and recall. Register 0 contains the previous state of the instrument and can be used to toggle between two different instrument configuration states.

Instrument configuration can be saved to registers 1 through 20.

CAUTION

Any configuration items which are not listed under the *RST or PRESet conditions are not savable. Make sure all aspects of the configuration are savable. For example, sensor power sweep calibration curves can not be saved in the configuration memory registers. Sensors must be calibrated to the 8650A power meter each time a new sensor is attached.

*RCL

Syntax:	*RCL <i>space</i> < memory location number 0 to 20 >	
Example:	OUTPUT @PWR_MTR;*RCL 19	! RECALL 8650A REGISTER 19
Description:	Recalls instrument configuration. 0 is the PRESet configuration.	

*SAV

Syntax:	*SAV <i>space</i> < memory location number 1 to 20 >	
Example:	OUTPUT @PWR_MTR;*SAV 20	! SAVES AT 8650A REGISTER 20
Description:	Saves current configuration to memory. Saving a configuration to memory position 0 cannot be done.	

3.2.29 Halting Operation

- **ABORt**

ABORt

Example:	OUTPUT @PWR_MTR;ABOR	! HALTS MEASUREMENT & TRIGGERING
Description:	This command stops operation, but it does not interrupt the completion of the current action. For example, sensor calibration is not interrupted. Burst mode data collection is not interrupted.	

3.2.30 Language Configuration

■ **SYSTem:LANGuage NATIVE**

SYST:LANG NATIVE

Example:	OUTPUT@PWR_MTR;SYST:LANG NATIVE	! SWITCHES ACTIVE GPIB COMMAND SET TO NATIVE LANGUAGE
Description:	Command modifies the active GPIB command set to native (8600) from SCPI. Query from is not available for this command.	

3.2.31 Preset Configuration

- *RST
- STATus:PRESet
- SYSTem:PRESet

*RST

Example:	OUTPUT @PWR_MTR;*RST	! RESET 8650A CONFIGURATION
Description:	This command resets the 8650A configuration to a known condition (See Table 3-4). These are not the power ON conditions. The 8650A has an internal battery which powers a non-volatile memory chip to retain configuration information. The only configuration that will change between power OFF and power ON is noted at the end of the table.	

STATus:PRESet

Example:	OUTPUT @PWR_MTR;STAT:PRES	! CLEARS ALL THE STATUS REGISTER VALUE
Description:	This command resets the 8650A Status information buffers. See Table 3-4. Note that these are not the power ON conditions.	

SYSTem:PRESet

Example:	OUTPUT @PWR_MTR;SYST:PRES	! RESET 8650A CONFIGURATION
Description:	This command resets the 8650A configuration to a known condition. SYST:PRES is identical in function to *RST (Command Default, Minimum, Maximum).	

Table 3-4: Reset & Power on Default Commands

Command	Default	Minimum	Maximum
CALCulate1[:CHANnel]: CALCulate2[:CHANnel]:	POWer 1 POWer 2	,	
CALCulate1-2: LIMit			
STATe	OFF		
UPPer	299.999	-299.999	299.999
LOWer	-299.999	-299.999	299.999
FAIL?	0		
FCOunt?	0		
MAXimum:			
STATe	OFF		
[MAGnitude]	299.999	-299.999	299.999
MINimum:			
STATe	OFF		
[MAGnitude]	-299.99	-29.999	29.99
MODE	NORmal		
REFerence:			
STATe	OFF		
[MAGnitude]	0	-299.99	299.99
STATe	ON		
UNIT	dBm		
INITiate:CONTInuous	OFF	,	

Series 8650A Universal Power Meters

Table 3-4: Reset & Power on Default Commands (Continued)

Command	Default	Minimum	Maximum
MEASure1-2[:SCALar:POWer]	With Auto average on	,	
MEMory[:TABLe]: CHANnel FREQuency POWer SELEct ANALOGout SLOPe VOLTage UNIT	1 0 -80,20 0 -10,10 dBm	1 0 -80,-80 0 -10,-10	2 40e9 20,20 10e9 10,10
OUTput: ROSCillator[:STATe] [BNC:]ANALog[:STATe]	OFF OFF	,	
SENSe1-2: AVERage: COUNT: AUTO TCONtrol CORRection: FREQ OFFset: STATe [MAGnitude] VPROpf[:STATe] TRIGger: DElay: STATe [MAGnitude] LEVel (if INT trig) LEVel (if EXT trig) SOURce	1 ON MOVing 5e7 OFF 0 OFF 1e-6 -20.0 1.7 IMMediate	1 0 -99.999 -5e-8 -30.0 0.1	512 4e10 99.999 104e-3 20.0 5.000
TRIGger: COUNT DElay MODE SOURce	1 0.000 POST IMMediate	0 0.000	128000 5.000
UNIT1-2[:POWer]	dBm	,	
POWER ON will override the internal battery back up memory and reset only the following configuration items as shown below. All other configuration items will remain the same as was true before power OFF.			
CALCulate1-2:MODE	NORMal	,	
INITiate:CONTInuous	OFF	,	
MEMory[:TABLe]:SELEct	ANALOGout	,	
OUTput:ROSCillator[:STATe]	OFF	,	
TRIGger: COUNT DElay MODE SOURce	1 0.000 POST IMMediate	0 0.000	128000 5.000

3.2.32 Identification Commands

- ***IDN**
- **SENSe:CORRection:EEPROM:TYPE?**
- **SYSTem:VERSion**

Identification commands ensure that the power meter and sensor are appropriate for the test program. The sensor identification commands allow monitoring what model of sensor is attached and ensure that the sensor has been properly calibrated to the power meter.



NOTE: Example programs for Identification Commands are contained in Appendix A of this publication.

*IDN?

Example:	OUTPUT @PWR_MTR;*IDN?	QUERY INST. MFGR & MODEL #
Response:	Giga-tronics, 8650,0,1.09 where 1.09 is software version	
Description:	The *IDN? is the identify query command defined by IEEE 488.2. Upon receipt of this command, the power meter will output a string that identifies itself as the Giga-tronics 8650A and indicates the firmware version number.	

SENSe:CORR:EEPROM:TYPE?

Syntax:	SENSe < sensor 1 or 2 > :CORRection:EEPROM:TYPE?	
Example:	OUTPUT @PWR_MTR;SENS1:CORR:EEPROM:TYPE?	! QUERIES SENSOR 1 EEPROM TYPE
Response:	80301,1818436 which is model number and serial number respectively	
Description:	This command returns sensor model and serial number information.	

SYST:VERSion

Syntax:	SYSTem:VERSion?	
Example:	OUTPUT @PWR_MTR;SYST:VERS?	! QUERIES SCPI VERSION
Response:	1995.0	
Description:	This query returns the compiled SCPI version.	

3.2.33 Calibrator Controls

■ **OUTPut:Reference:OSCillator**

The reference oscillator is the RF calibration source for the sensors.

■ **OUTP:ROSC**

OUTP:ROSC

Syntax:	OUTPut:ROSCillator[:STATe] <i>space</i> < ON OFF >	
Example:	OUTPUT @PWR_MTR;OUTP:ROSC ON	QUERY INST. MFR & MODEL #
Description:	The reference oscillator (Calibrator port) connection is on the front panel of the power meter. The OUTPut:ROSCillator ON command turns on this 0 dBm, 50 MHz output. The reference oscillator power level should be calibrated annually. Please refer to the Calibration Procedures in Chapter 4 for additional details.	

3.2.34 Sensor EEPROM Commands

■ **SENSe:CORRection:EEPROM:TYPE?**

■ **SENSe:CORRection:EEPROM:CALFactor?**

■ **SENSe:CORRection:EEPROM:FREQuency?**

SENSe:CORRection:EEPROM:TYPE?

Syntax:	SENSe < sensor 1 or 2 > :CORRection:EEPROM:TYPE?	
Example:	OUTPUT @PWR_MTR;SENS1:CORR:EEPROM:TYPE?	! QUERIES SENSOR 1 EEPROM TYPE
Response:	Typically, 80301,1818436 which is model number and serial number respectively	
Description:	This command allows programming to verify correct sensor usage and monitor whether power sweep calibration has been performed or not.	

SENSe:CORRection:EEPROM:CALFactor?

Syntax:	SENSe < sensor 1 or 2 > :CORRection:EEPROM:CALFactor?	
Example:	OUTPUT @PWR_MTR;SENS1:CORR:EEPROM:CALF?	! QUERIES SENSOR 1 EEPROM CAL FACTOR TABLE
Response:	Typically, 5.000e7,2.000e9,.....	
Description:	Provides a listing of calibration factors in the sensor, sorted in frequency order, to match previous command. The number of items matches the sum of the number at standard frequencies, and the number of special frequencies reported by DIAG:SENS1:EEPROM:CALFR?	

SENSe:CORRection:EEPROM:FREQuency?

Syntax:	SENSe < sensor 1 or 2 > :CORRection:EEPROM:FREQuency?	
Example:	OUTPUT @PWR_MTR;SENS1:CORR:EEPROM:FREQ?	! QUERIES SENSOR 1 EEPROM FREQUENCY TABLE
Response:	Typically, 5.000e7,2.000e9,.....	
Description:	Provides a listing of calibration frequencies in the sensor, sorted by frequency, so that both standard and special frequencies are listed. The number of items matches the sum of the number at standard frequencies, and the number of special frequencies.	

3.2.35 Self-Test

■ *TST?

*TST?

Syntax:	*TST?	
Example:	OUTPUT @PWR_MTR;*TST?	! QUERIES SELF-TEST RESULT
Response:	0 if all is OK, otherwise, it returns a value of 1.	

3.2.36 Error Messages

■ SYSTEM:ERRor?

SYSTEM:ERRor?

Syntax:	SYSTEM:ERRor?	
Example:	OUTPUT @PWR_MTR;SYST:ERR?	! QUERIES SYSTEM ERROR MESSAGE
Description:	This command reads error messages from the error buffer. Use *CLS and CLEAR @PM_address to clear the SYST:ERR buffer just prior to entering measurement configurations and measurement routines. A listing of compatible standard SCPI error and device-specific errors follows.	

Table 3-5: SCPI Standard Error Messages

Error Number	Description
0	No Error
-7	Invalid Error Number
-108	Parameter Not Allowed
-111	Header Separator Error
-113	Undefined Header; - - -
-120	Numeric Data Error
-200	Execution Error
-211	Trigger Ignored
-213	Init Ignored
-214	Trigger Deadlock
-230	Data Corrupt or Stale
-300	Device-specific errors (See Table 3-6)

Series 8650A Universal Power Meters

Table 3-6: Device Specific Error Messages

Command	Error Message	Example of Problem
ABORt		
CALCulate1:DATA?	Burst mode is off	Not burst mode; Command requires BURSt mode
CALCulate1:DIFFerence 1,1 CALCulate1:RATio 1,1	Conflict in channel configuration	Same sensor
CALCulate1:LIMit:LOWer:UPPer	Conflict between upper and lower limits	Upper is smaller than lower or lower is greater than upper
CALCulate1:MAXimum:STATe	Channel is not valid	No sensor or sensor not calibrated
CALCulate1:MINimum:STATe	Channel is not valid	No sensor or sensor not calibrated
CALCulate1:MODE	No valid sensor Channel is not valid	No sensor No sensor or sensor not calibrated
CALCulate1:REFerence:COLLect	Normal mode is off Channel is not valid	Burst mode setup No sensor or sensor not calibrated
CALibrate 1	No sensor Sensor not connected to calibrator Sensor calibration error	No sensor Calibration error
CALibrate 1:ZERO	No sensor Sensor zeroing error	Zeroing error
DIAGnostic:SENSe1:EEPROM:CORRection	No valid sensor sensor eeprom data:correction factor number does not match	No sensor
DIAGnostic:SENSe1:EEPROM:READ	No valid sensor	No sensor
DIAGnostic:SENSe1:EEPROM:CALFSpecial DIAGnostic:SENSe1:EEPROM:CALFSTandard	No valid sensor Sensor eeprom data is over space Sensor eeprom data:cal factor number does not match	No sensor Too much data
DIAGnostic:SENSe1:EEPROM:FREQStandard?	No valid sensor Sensor eeprom data is over space	No sensor Too much data
DIAGnostic:SENSe1:EEPROM:CALFRange DIAGnostic:SENSe1:EEPROM:TYPE	No valid sensor	No sensor
DIAGnostic:SENSe1:EEPROM:FREQSpecial	No valid sensor Sensor eeprom data is over space Sensor eeprom data:freq is above upper freq limit Sensor eeprom data:freq is below lower freq limit Sensor eeprom data:freq number do not match	No sensor Too much data
DIAGnostic:SENSe1:EEPROM:TYPE	No valid sensor Sensor eeprom data:upper freq should be larger than lower freq	No sensor
DIAGnosticSENSe1:EEPROM:WRITe	No valid sensor Sensor eeprom data:write error Password is incorrect	No sensor Sensor eeprom error Password is activated

Table 3-6: Device Specific Error Messages (Continued)

Command	Error Message	Example of Problem
FETCh1?	Data corrupt or stale TTL trigger mode not applicable	No valid sensor Normal mode
INITiate:IMMEDIATE	Init ignored	Continuous is on
MEASure1?	Data corrupt or stale Normal mode is off	No valid sensor Burst or swift mode
MEMory:TABLE:FREQuency	No valid sensor V _{PROP} F Table is not selected V _{PROP} F Table freq data error	No sensor Select others Start freq is greater than sensor maximum
MEMory:TABLE:POWer	Analog out Table is not selected Analog out Table data input error	Other table Lower power is greater than upper power
MEMory:TABLE:SLOPe	No valid sensor V _{PROP} F Table is not selected	Select others No sensor
MEMory:TABLE:UNIT	Analog out Table is not selected	Other table
MEMory:TABLE:VOLTage	Analog out Table is not selected Analog out Table data input error	Other table Lower voltage is greater than upper voltage
READ1?	Data corrupt or stale Normal mode is off Trigger deadlock	No valid sensor Burst or swift mode is on TRIG:SOUR is not in IMM mode
SENSe1:EEPROM:CALFactor? SENSe1:EEPROM:FREQuency?	No valid sensor Sensor eeprom data is over space	No sensor Too much data
SENSe1:CORRection:VPROpf:STATe	No valid sensor	No sensor
SENSe1:TRIGger:DELay SENSe1:TRIGger:LEVel	No valid sensor Sensor is in CW source mode	No pulse sensor
SENSe1:TRIGger:DELay:STATe ON	No valid sensor	No pulse sensor
TRIGger:COUNter	Normal mode is on Counter has to be one in Swift immediate source No valid sensor Channel is not valid	Not in burst or swift mode Swift mode, imm source No sensor Ratio mode setup
TRIGger:IMMEDIATE	Init ignored	Source is in immediate mode
TRIGger:MODE PRE	No PRE mode for trigger immediate source	
TRIGger:SOURce:IMMEDIATE	Counter has to be one in Swift immediate source No valid sensor Channel is not valid	Swift mode is on No sensor Ratio mode setup

3.3 IEEE 488.2 Interface Command Codes

3.3.1 Command Syntax

The elements of the 8650A interface commands are introduced in this section. Because some commands are included only for compatibility with earlier models, there are some variations in syntax from one command to another, which must be carefully observed.

3.3.1.1 Function Codes

An interface command includes a function code to indicate the nature and purpose of the command. Some commands contain a function code and nothing else. For example, the function AP, which causes the 8650A to measure power using the A sensor, stands alone as a command. Commands consisting only of a function code are referred to in this manual as *simple* commands. However, most commands consist of a function code combined with other elements.

The CH *n* EN (where *n* = display line number) command must precede commands for setting units and resolution of power measurement and for setting relative mode, limits, min/max, and statistics. All subsequent commands will apply to the same display line number.

Function codes are listed alphabetically in the Command Code Sets in this section.

3.3.1.2 Prefixes

Some commands must begin with a prefix that identifies the sensor to which the command applies. For example, function code ZE (which causes a sensor to be zeroed) must be combined with a prefix to specify which sensor is zero'ed. The full command is either AE ZE (for sensor A) or BE ZE (for sensor B).

Many of the commands described in this chapter require an AE or BE prefix, which specifies the sensor that will be affected by the command. When the 8650A receives a command containing a sensor-specific prefix, it assumes that all subsequent commands refer to the same sensor until a command is received to specify the other sensor. Therefore, if a command prefixed by AE is received, subsequent commands can omit the prefix provided that they are intended for Sensor A.

It does no harm to include the prefix even when it is not required; some users may find that the most convenient approach is to include the prefix in all applicable commands.

3.3.1.3 Variables

Some commands must include one or more variables to specify quantities or options for the command. For example, the function code ANALOG (used in commands to configure the analog output) is combined with several variables to specify different aspects of the analog output. In the command

```
ANALOG LOG -80.0, 20.0, 0.0, 10.0
```

the variables are interpreted as follows:

- LOG** Specifies that power is to be measured in logarithmic units (that is, dB or dBm).
- 80.0** Specifies that the low end of the analog output voltage range represents -80 dBm in.
- +20.0** Specifies that the high end of the analog output voltage range represents +20 dBm in.
- 0.00** Specifies that the low end of the analog output range is 0 volts.
- 10.0** Specifies that the high end of the analog output range is 10 volts.

In the above example, the numeric variables are strung together with separator characters between them (See *Separators*, Section 3.3.1.5 below). However, in some commands, numeric variables are preceded in the command string by the variable name. For example, in the command FBUF PRE TTL BUFFER 200 TIME 1300, the numeric variables known as buffer and time are identified by name within the string.

Many variables are qualitative rather than quantitative; they select from among the various modes or options available for a particular function.

3.3.1.4 Suffixes

Some commands require a terminating suffix. For example, the function code DY specifies a duty cycle. It requires an AE or BE prefix to identify the sensor, and a numeric variable to indicate the duty cycle as a percentage. Finally, the command must include a terminating suffix (the choices of suffix in this case are EN, PCT and %). The command AE DY 50 % sets the duty cycle for sensor A to 50 percent.



NOTE: *Some commands that include numeric variables require a terminating suffix while other commands do not, and interface problems will occur if the suffixes are used in commands which do not need them. Each command must be used so that its particular syntax requirements are met.*

3.3.1.5 Separators

Spaces, commas, colons, and semicolons can be used as separators between the various elements of a command (function codes, variables, etc.). For readability, commands in this manual are usually spelled out with spaces inserted between the elements (for example, SWIFT PRE GET BUFFER 100). Although separators within a command are permitted, they are usually not required. In the command descriptions in this chapter (beginning with Section 3.4), required separators are noted.

3.3.1.6 Command Format Illustrations

A command format is used in this manual to show the possible elements of a command, as illustrated below:

[AE or BE] DY [n] [EN or PCT or %]

Variables are shown within brackets. In this example, the prefix can be AE or BE, the function is DY, a numerical variable [n] follows the function, and the suffix at the end can be EN, PCT, or %.

Possible commands which use this example format include AE DY 42 % and BE DY 29.5 EN.

Because the Model 8651A supports only one sensor, the AE and BE prefixes can be omitted from any command issued to that model.

Series 8650A Universal Power Meters

3.3.2 8650A Command Code Set

Table 3-7 lists the IEEE 488.2 common commands that are implemented in the 8650A. Most of these codes do not stand alone; commands; prefixes, variables, and suffixes must be combined with them. For further information refer to the sections cited in Table 3-7.

Table 3-7: 8650A IEEE 488.2 Command Set

Command	Description	Section
Required Commands		
*CLS	Clear status byte	3.19.13
*ESE	Set Event Status Enable Register	3.19.13
*ESE?	Ask for current status of Event Status Enable Register	3.19.13
*ESR?	Ask for and clear Event Status Register bits	3.19.13
*IDN?	Ask for instrument ID	3.13
*OPC	Operation complete command	3.2.13 3.2.24
*OPC?	Operation complete query	3.2.13 3.2.24
*RST	Software reset	3.19.9
*SRE	Set the service request mask	3.19.13
*SRE?	Ask for service request mask	3.19.13
*STB?	Ask for status byte	3.19.13
Function Commands		
@1	Set service request mask	3.19.13
@2	Set learn mode 2 data	3.14.3
?ID	Ask for instrument ID	3.13
AD	Measure A-B	3.19.12
AE	Select sensor A or analog output A for subsequent settings	3.3.1
ANALOG	Configure analog output	3.4
AP	Measure sensor A	3.19.12
AR	Measure A/B	3.19.12
BAP	BAP mode	3.18.4
BD	Measure B-A	3.19.12
BE	Select sensor B or analog output B for subsequent settings	3.3.1
BP	Measure sensor B	3.19.12
BR	Measure B/A	3.19.12
BSPE	Burst end exclude	3.19
BSTE	Burst start exclude	3.19
BTDP	Burst dropout	3.19.3
BURST	Fast buffered mode (see also FBUF in this table)	3.17.3
CH	Select active measurement line for subsequent commands	3.3.1
CL	Calibrate sensor	3.7
CRF	Ask for crest factor value	3.8

Table 3-7: 8650A IEEE 488.2 Command Set (Continued)

Command	Description	Section
CR	Crest factor	3.8
CS	Clear status byte	3.19.3
CW	CW mode	3.18
DA	Test LCD display	3.9
DC0	Duty cycle disable	3.10
DC1	Duty cycle enable	3.10
DD	Display disable	3.9
DE	Display enable	3.9
DU	Display user message	3.9
DY	Set duty cycle	3.10
EEPROM	Sensor EEPROM query	3.12
FA	Auto averaging	3.5
FBUF	Fast buffered mode	3.17.3
FH	Hold current averaging number	3.5.1
FM	Set averaging number	3.5.2
FMOD	Fast modulated mode	3.17.5
FR	Frequency	3.12.2
GATE	Time gating function	3.11
GTO	Cancel GET	3.16.2
GT1	GET single measurement	3.16.2
GT2	GET full measurement with settling	3.16.2
HIST	Histogram display	3.19.19
ID	Ask for instrument ID	3.13
KB	Enter cal factor	3.6
LG	Log units (dB or dBm)	3.19.6
LH	Set high limit	3.15
LL	Set low limit	3.15
LM0	Disable limit checking	3.15
LM1	Enable limit checking	3.15
LN	Linear units (Watts or %)	3.19.16
LP1	Ask for learn mode #1 string	3.14.1
LP2	Ask for learn mode #2 output	3.14.3
MAP	MAP mode	3.18
MAX	Ask for max value	3.19.4
MEAS	Ask for measurement mode	3.18.6
MIN	Ask for minimum value	3.19.4
MNO	Min/max disable	3.19.4
MN1	Min/max enable	3.19.4
OC0	Disable calibrator source	3.7.2
OC1	Enable calibrator source	3.7.2

Series 8650A Universal Power Meters

Table 3-7: 8650A IEEE 488.2 Command Set (Continued)

Command	Description	Section
OF0	Offset disable	3.19.5
OF1	Offset enable	3.19.5
OS	Set offset value	3.19.5 3.19.6
PAP	PAP mode	3.18
PEAK	Peak sensor settings	3.19.8
PH0	Peak hold off	3.19.7
PH1	Peak hold on	3.19.7
PKH	Ask for peak hold value	3.19.7
PR	Preset the 8650A	3.19.9
PULSE	Peak sensor settings	3.19.8
RE	Display resolution	3.19.11
RLO	Disable relative measurement	3.19.10
RL1	Enable relative measurement	3.19.10
RL2	Use old reference for relative measurement	3.19.10
RV	Ask for service request mask	3.19.13
SETUP	Setup Configuration	3.19.14
SM	Ask for status message	3.19.13
ST	Store instrument state	3.19.14.2 3.19.15
STAT	Statistical analysis	3.19.21
STRIP	Strip Chart pause/resume and query	3.19.20
SWIFT	Swift mode	3.17.4
TEST	Test calibrator power output level	3.7.3
TEST CALIB	Test calibrator output power level	3.7.3
TR0	Trigger hold mode	3.16
TR1	Trigger single measurement	3.16
TR2	Trigger full measure with settling	3.16
TR3	Free run trigger mode	3.16
VPROPF	Configure V_{PROP} feature	3.19.17
ZE	Sensor zeroing	3.19.18

The 8650A is always able to measure over its entire dynamic range; there is no need to specify the range. Therefore, range-related commands have no effect on the measurement capability of the 8650A. The auto range, range hold, and set range commands only offset the analog output voltage, and only in HP436, HP437 or HP438 GPIB emulation modes. In these emulation modes (when using a single sensor, and not measuring in a relative mode), the power will be scaled to a range of 0 to 1 volts, representing the relative power within the current 10 dB range of the 8650A. The range hold and set range commands will simulate locking the range of power represented by the output voltage.

3.3.3 8540C Emulation Command Code Set

Table 3-8 lists the 8540C IEEE 488.2 emulation commands that are implemented in the 8650A. Most of these codes do not stand alone; commands; prefixes, variables and suffixes must be combined with them. For further information refer to the manual sections cited in Table 3-8.

Table 3-8: 8540C Emulation Command Set

Command	Description	Section
Required Commands		
*CLS	Clear status byte	3.19.13
*ESE	Set Event Status Enable Register	3.19.13
*ESE?	Ask for current status of Event Status Enable Register	3.19.13
*ESR?	Ask for and clear Event Status Register bits	3.19.13
*OPC	Operation complete command	3.2.13 3.2.24
*OPC?	Operation complete query	3.2.13 3.2.24
*RST	Software reset	3.19.9
*STB?	Ask for status byte	3.19.13
*SRE	Set the service request mask	3.19.13
*SRE?	Ask for service request mask	3.19.13
*IDN?	Ask for instrument ID	3.13
Function Commands		
@1	Set service request mask	3.19.13
@2	Set learn mode 2 data	3.14.3
?ID	Ask for instrument ID	3.13
AD	Measure A-B	3.19.2
AE	Specifies the A sensor	3.3.1
ANALOG	Configure analog output	3.4
AP	Measure sensor A	3.19.12
AR	Measure A/B	3.19.12
BAP	BAP mode	3.18.4
BD	Measure B-A	3.19.12
BE	Specifies the B sensor	3.3.1
BP	Measure sensor B	3.19.12
BR	Measure B/A	3.19.12
BSPE	Burst end exclude	3.19
BSTE	Burst start exclude	3.19
BTDP	Burst dropout	3.19.3
BURST	Fast buffered mode	3.17.3
CL	Calibrate sensor	3.7

Series 8650A Universal Power Meters

Table 3-8: 8540C Emulation Command Set (Continued)

Command	Description	Section
CRF	Ask for crest factor value	3.8
CR	Crest factor	3.8
CS	Clear status byte	3.19.13
CW	CW mode	3.18
DA	Test LCD display	3.9
DC0	Duty cycle disable	3.10
DC1	Duty cycle enable	3.10
DD	Display disable	3.9
DE	Display enable	3.9
DU	Display user message	3.9
DY	Set duty cycle	3.10
EEPROM	Sensor EEPROM query	3.12
FA	Auto averaging	3.5
FBUF	Fast buffered mode	3.17.3
FH	Hold current averaging number	3.5.1
FM	Set averaging number	3.5.2
FMOD	Fast modulated mode	3.17.5
FR	Frequency	3.12.2
GATE	Time gating function	3.11
GTO	Cancel GET	3.16.2
GT1	GET single measurement	3.16.2
GT2	GET full measurement with settling	3.16.2
ID	Ask for instrument ID	3.13
KB	Enter cal factor	3.6
LG	Log units (dB or dBm)	3.19.6
LH	Set high limit	3.15
LL	Set low limit	3.15
LM0	Disable limit checking	3.15
LM1	Enable limit checking	3.15
LN	Linear units (Watts or %)	3.19.16
LP1	Ask for learn mode #1 string	3.14.1
LP2	Ask for learn mode #2 output	3.14.3
MAP	MAP mode	3.18
MAX	Ask for max value	3.19.4
MEAS	Ask for measurement mode	3.18.6
MIN	Ask for minimum value	3.19.4

Table 3-8: 8540C Emulation Command Set (Continued)

Command	Description	Section
MNO	Min/max disable	3.19.4
MN1	Min/max enable	3.19.4
OCO	Disable calibrator source	3.7.2
OC1	Enable calibrator source	3.7.2
OFO	Offset disable	3.19.5
OF1	Offset enable	3.19.5
OS	Set offset value	3.19.5
PAP	PAP mode	3.18
PEAK	Peak sensor settings	3.19.8
PHO	Peak hold Off	3.19.7
PH1	Peak Hold On	3.19.7
PKH	Ask for peak hold value	3.19.7
PR	Preset the 8650A	3.19.9
PULSE	Peak sensor settings	3.19.8
RC	Recall a saved instrument state	3.19.14.2 3.19.15
RE	Display resolution	3.19.11
RLO	Disable relative measurement	2.3.3
RL1	Enable relative measurement	2.3.3
RL2	Use old reference for relative measurement	2.3.3
RV	Ask for service request mask	3.19.13
SCPI	Switches to SCPI command mode	3.19.22
SM	Ask for status message	3.19.13
ST	Store instrument state	3.19.15
SWIFT	Swift mode	3.17.4
TRO	Trigger hold mode	3.16
TR1	Trigger single measurement	3.16
TR2	Trigger full measure with settling	3.16
TR3	Free run trigger mode	3.16
V _{PROP} F	Configure V _{PROP} F feature (See Figure 3-6)	3.19.17
ZE	Sensor zeroing	3.19.18

3.3.4 HP436 Emulation Command Code Set

Table 3-9 lists the GPIB commands that are available when the instrument is placed in the HP436 emulation mode:

Table 3-9: HP436 Emulation Command Set

Command	Description
5 ¹	Set range 5
4 ¹	Set range 4
3 ¹	Set range 3
2 ¹	Set range 2
1 ¹	Set range 1
9 ¹	Set auto range
A	Set linear units (Watts)
B	Set relative mode
C	Set relative value
D	Set Log units (dBm)
Z	Zero sensor
++	Enable cal factors
-	Disable cal factors (ignored)
H	Set TR0 mode
T	Set TR2 mode
I	Set TR1 mode
R	Set TR3 mode
V	Set TR3 mode

1. The 8650A is always able to measure over its entire dynamic range; there is no need to specify the range. Therefore, range-related commands have no effect on the measurement capability of the 8650A. The auto range, range hold, and set range commands only offset the analog output voltage, and only in HP436, HP437 or HP438 GPIB emulation modes. In these emulation modes (when using a single sensor, and not measuring in a relative mode), the power will be scaled to a range of 0 to 1 volts, representing the relative power within the current 10 dB range of the 8650A. The range hold and set range commands will simulate locking the range of power represented by the output voltage.

In HP436 emulation, the specified range is also indicated in the power data strings returned to the host.

3.3.5 HP437 Emulation Command Code Set

These are the GPIB commands that are available when the instrument is placed in the HP437 emulation mode. Footnotes appear at the end of Table 3-10.

Table 3-10: HP437 Emulation Command Set

Command	Description
Required Commands	
*CLS	Clear all Status Registers ²
*ESE	set the event status enable mask ³
*ESE?	event status register enable mask query ³
*ESR?	event status register query ³
*IDN?	GPIB identification query ²
*RST	Software reset
*SRE	Set the Service Request Mask value ²
*SRE?	Service Request Mask query
*STB?	Read the Status Byte
Function Commands	
@1	Prefix for Status Mask
@2	Learn mode prefix
CL	CAL ¹
CS	Clear the Status Byte
CT0 - CT9	clear sensor data tables 0 thru 9 [ignored]
DA	Test LCD display
DC0	Duty Cycle on
DC1	Duty Cycle off
DD	Display disable
DE	Display enable
DN	down arrow emulation [ignored]
DU	Display user message
DY	Duty Cycle (enter duty cycle value)
ERR?	device error query
ET0 - ET9	edit sensor cal factor table 0 thru 9 [ignored]
EX	exit [ignored]
FA	automatic filter selection
FM	manual filter selection ¹
FR	frequency entry
GTO	ignore Group Execute Trigger (GET) bus command
GT1	trigger immediate response to GET command
GT2	trigger with Delay response to GET command
ID	GPIB identification query
KB	Cal Factor ¹
LG	Log display
LH	High limit ¹
LL	Low limit ¹

Series 8650A Universal Power Meters

Table 3-10: HP437 Emulation Command Set (Continued)

Command	Description
LM0	Disable limits checking function
LM1	Enable limits checking function
LN	Linear display
LP2	HP437 learn mode
LT	Left arrow [ignored]
OCO	Reference oscillator off
OC1	Reference oscillator on
OD	Output display text [ignored]
OFO	Offset off - Local
OF1	Offset on - Local
OS	Offset (enter offset value)
PR	Preset
RA	Auto range ⁴
RC	Recall ¹
RE	Resolution ¹
RFO - RF9	Enter sensor ref cal factor [ignored]
RH	Range hold ⁴
RLO	Exit REL mode
RL1	Enter REL mode using REL value
RL2	Use old ref number
RM	Set range ^{1, 4}
RT	Right arrow [ignored]
RV	Read Service Request Mask value
SE	Sensor [ignored]
SM	Status Message
SNO - SN9	enter sensor serial number [ignored]
ST	Store instrument state
TR0	Trigger hold
TR1	Trigger immediate
TR2	Trigger with delay
TR3	Trigger - free run
UP	Up arrow [up arrow]
ZE	Zero

Notes:

1. A numeric entry is required by these GPIB codes, followed by the code EN (ENTER).
2. This GPIB code uses the next 6 characters (0-9, A-Z, or an underscore) as input data.
3. The asterisk (*) must be included as part of the GPIB command string.
4. The 8650A can always measure over its entire dynamic range; there is no need to specify the range. Therefore, range-related commands have no effect on the measurement capability of the 8650A. The auto range, range hold, and set range commands only offset the analog output voltage, and only in HP436, HP437, or HP438 GPIB emulation modes. In these emulation modes (when using a single sensor, and not measuring in a relative mode), the power will be scaled to a range of 0 to 1 volts, representing the relative power within the current 10 dB range of the 8650A. The range hold and set range commands will simulate locking the range of power represented by the output voltage.

3.3.6 HP438 Emulation Command Code Set

These are the GPIB commands that are available when the instrument is placed in the HP438 emulation mode. Footnotes appear at the end of Table 3-11.

Table 3-11: HP438 Emulation Command Set

Command	Description
IEEE 488.2 Function Commands	
?ID	Ask for ID
@1	Prefix for Service Request Mask
@1;CHR\$(4)	Set Service Request Mask to 4
AD	Measure A-B
AE	Specifies the A sensor
AP	Measure sensor A
AR	Measure A/B
BD	Measure B-A
BE	Specifies the B sensor
BP	Measure sensor B
BR	Measure B/A
CL ¹	Calibrate sensor (precede with AE or BE)
CS	Clear status byte
DA	Test LCD display
DD	Display disable
DE	Display enable
FA	Set auto average filtering (precede with AE or BE)
FM	Set averaging number
GTO	Group execute trigger cancel
GT1	Group execute trigger single measurement
GT2	Group execute trigger full measurement with settling
KB	Cal Factor
LG	Set Log units (dB or dBm)
LH	High limit
LL	Low limit
LM0	Disable limit checking
LM1	Enable limit checking
LN	Set linear units (Watts or %)
LP1	Set learn mode #1
LP2	Set learn mode #2

Series 8650A Universal Power Meters

Table 3-11: HP438 Emulation Command Set (Continued)

Command	Description
OC0	Turn off calibrator source
OC1	Turn on calibrator source
OS	Offset
PR	Preset the instrument to a known state
RA ²	Resume autorange [not supported]
RC	Recall previous instrument state
RH ²	Do a range hold
RLO	Turn off rel mode
RL1	Turn on rel mode
RM ²	Set manual range
RV	Ask for status request mask
SM	Ask for status message
ST	Store instrument state
TR0	Trigger hold mode
TR1	Trigger single measurement
TR2	Trigger full measurement with settling
TR3	Free run trigger mode
ZE	Zero sensor (precede with AE or BE)

Notes:

1. A numeric entry is required by these GPIB codes, followed by the EN suffix.
2. The 8650A is always able to measure over its entire dynamic range; there is no need to specify the range. Therefore, range-related commands have no effect on the measurement capability of the 8650A. The auto range, range hold, and set range commands only offset the analog output voltage, and only in HP436, HP437, or HP438 GPIB emulation modes. In these emulation modes (when using a single sensor, and not measuring in a relative mode), the power will be scaled to a range of 0 to 1 volts, representing the relative power within the current 10 dB range of the 8650A. The range hold and set range commands will simulate locking the range of power represented by the output voltage.

3.4 Analog Output

These commands control the A and B analog outputs.

3.4.1 Enabling & Disabling the Output

The ANALOG function can enable or disable the analog outputs. The command format for this purpose is:

Syntax:	ANALOG [STD or OPT] STATE [ON OFF]	
	[STD or OPT] specifies analog output A or B respectively	
	STATE indicates that the analog output ON/OFF status is being configured	
	The variables ON and OFF indicate whether the analog output is to be enabled or disabled	
Example:	OUTPUT 713;ANALOG STD STATE ON	! ENABLES ANALOG A OUTPUT
Example 2:	OUTPUT 713;ANALOG OPT STATE OFF	! DISABLES ANALOG B OUTPUT

3.4.2 Setting Options for the Output

The ANALOG function can also configure various aspects of the analog output. The command format is:

Syntax:	ANALOG [STD or OPT] [TOP or BOT] [LG or LN] [a b c d]	
	[STD or OPT] specifies the analog output A or B respectively	
	[LG or LN] specifies logarithmic (dBm) or linear (Watts) measurement	
	The command string ends with four numeric variables (with at least one separator character between each pair of them), which define the relationship between the input power range and the output voltage range: a: power level represented by the minimum output voltage, b: power level represented by the maximum output voltage, c: minimum output voltage, d: maximum output voltage Valid power range numbers are -100 to +100 [dBm] for LOG, or 0 to 15 [Watts] for LIN. Valid voltage range numbers are 0.00 to +10.00 [VDC]	
Example:	OUTPUT 713;ANALOG STD LOG -80.0, 20.0, 0.0, 10.0	! CONFIGURES THE ANALOG A OUTPUT CHANNEL AS FOLLOWS: ! LOGARITHMIC UNITS, -80 TO +20 DBM INPUT, 0 TO 10 VOLT OUTPUT
Example 2:	OUTPUT 713;ANALOG OPT LIN 0.00, 1.00E-3, 0.0, 1.0	! CONFIGURES THE ANALOG B OUTPUT CHANNEL AS FOLLOWS: ! LINEAR UNITS, 0 TO 1.00 MW, 0 TO 1 VOLT OUTPUT

3.5 Averaging

3.5.1 Auto Averaging

The 8650A is normally used in the auto averaging mode. The power meter chooses an averaging factor that is appropriate for the ambient noise level.

3.5.1.1 Activating the Auto Filter Mode

The command which activates auto averaging for a sensor is based on the FA function. The command format is:

Syntax:	[AE or BE] FA	
	[AE or BE] prefix specifies Sensor A or Sensor B. FA activates the auto filter mode for the selected sensor	
Example:	OUTPUT 713;AE FA	! ACTIVATES AUTO AVERAGING FILTERING FOR SENSOR A

3.5.1.2 Setting the Measurement Settling Target

In the auto averaging mode, the 8650A chooses the lowest averaging factor that will yield a stable measurement at the present resolution setting. Stability is defined in terms of peak to peak variation in the measurement; the variation target value is expressed as a percentage of average power. Default values for this Measurement Settling Target are:

Table 3-12: Measurement Setting Target Default Values

Resolution	Peak to Peak Variation
xx.	25% (~1 dB)
xx.x	4.7% (~.2 dB)
xx.xx	0.46% (~.02 dB)
xx.xxx	0.10% (~.004 dB)

Because the target value affects the speed of measurement, it is possible to increase measurement speed by increasing the target value (a small increase in the target value can result in a large increase in speed). If the auto averaging mode is selected using the front panel menus, or the AE FA or BE FA commands as described above, the default target values shown in the table are used. However, it is possible to add a numeric variable after FA in order to specify a different target value:

Syntax:	[AE or BE] FA [t] [EN % or PCT]	
	[t] represents the measurement settling target value in percent, and has a valid range of 0.10 to 100.00	
Example:	OUTPUT 713;BE FA .8 %	! ACTIVATES AUTO AVERAGING FILTERING FOR SENSOR B, WITH ! A MEASUREMENT SETTling TARGET OF .8%

3.5.1.3 Freezing the Present Averaging Number

The command which causes auto filtering to hold its present averaging number is based on the FH function. The command format is:

Syntax:	[AE or BE] FH	
	[AE or BE] prefix specifies sensor A or Sensor B	
	FH causes the 8650A to hold its present averaging number; auto averaging is deactivated	
Example:	OUTPUT 713;BE FH	! HOLDS PRESENT AVERAGE NUMBER FOR SENSOR B

Series 8650A Universal Power Meters

3.5.2 Manual Averaging

The averaging number can be specified directly. The commands for this purpose are based on the FM function. The command format is:

Syntax:	[AE or BE] FM [v] EN	
	[AE or BE] prefix specifies Sensor A or Sensor B	
	FM specifies manual averaging	
	[v] has allowable values of 0 through 10. Each value represents a particular averaging number. The numbers are shown in Table 3-13	
	A terminating suffix is required (EN)	
Example:	OUTPUT 713;AE FM 2 EN	! SETS AVERAGING NUMBER TO 4

Table 3-13: Numbering Averaging

Value of ν	Averaging Number	Value of ν	Averaging Number
0	1	5	32
1	2	6	64
2	4	7	128
3	8	8	256
4	16	9	512
		10	1024

Example 2:	OUTPUT 713;AE FM 8 EN	! SETS AVERAGING NUMBER TO 256
------------	-----------------------	--------------------------------

3.6 Cal Factors

The commands described below do not need to be employed with the 8650A; it is included here for the sake of compatibility with remote programs written for older power meters.

When a sensor is attached to the 8650A, the power meter automatically loads calibration factors from an EEPROM in the sensor. This data is frequency related, and in order for the 8650A to make use of it, the user must supply frequency information to the power meter, either by means of the front panel FREQ key, by means of the GPIB FR command (See FREQUENCY, Section 3.12.2), or by means of the $V_{PROP}F$ input. Once the frequency has been specified, the 8650A automatically applies the appropriate cal factor to each reading.

The KB function code specifies a cal factor which is to be used in place of the cal factors stored in the sensor EEPROM. The command format is:

Syntax:	[AE or BE] KB [n] EN	
	[AE or BE] prefix specifies Sensor A or Sensor B	
	[n] specifies a cal factor, expressed as a percentage with a valid range of 1.0 to 150.0	
	A terminating suffix is required (EN)	
Example:	OUTPUT 713;AE KB 96 EN	! ENTERS A 96% CAL FACTOR FOR SENSOR A
Example 2:	OUTPUT 713;BE KB 102 EN	! ENTERS 102% CAL FACTOR FOR SENSOR B

3.7 Calibration

Commands which cause the 8650A to calibrate a sensor are based on the CL function code. The command format is:

Syntax:	[AE or BE] CL [<i>n</i>] [EN or PCT or %]	
	[AE or BE] prefix specifies Sensor A or Sensor B	
	<i>n</i> represents a reference calibration factor of <i>n</i> %. The 8650A makes no use of this variable; instead it reads cal factors from the sensor EEPROM. The variable is included in the command format only for compatibility with power meters which require it. Any value between 50 and 120 can be entered for <i>n</i>	
	A terminating suffix is required (EN, PCT or %)	
Example:	OUTPUT 713;AE CL 100 EN	! CALIBRATE SENSOR A
Example 2:	OUTPUT 713;BE CL 100 EN	! CALIBRATE SENSOR B

The appropriate sensor must be attached to the calibrator output for the calibration process to function. If the sensor is not attached, the calibration will fail, and operation will continue as before.

3.7.1 Calibration Routine

The following is an example of a GPIB program to calibrate a sensor. It is strongly recommended that this format be followed for remote calibration. Note that the service request feature is used to determine when the calibration has completed; this will result in the fastest calibration routine.

```

Calibrate:                                     ! calibration routine
ON INTR 7 GOSUB Srq_interrupt                 ! setup serial poll interrupt jump location
ENABLE INTR 7;2                               ! enable SRQ interrupts3;*SRE010
! set service request mask to 23;CS          ! clear status byte
OUTPUT 713;CL100EN                            ! start calibration
Flag=0                                         reset control flag
WHILE Flag=0                                  ! wait while calibrating
END WHILE
RETURN
Srq_interrupt:                                ! SRQ interrupts jump here
13;*STB?
ENTER 713;State
IF BIT(State, 1) THEN
    PRINT GOOD CAL
ELSE
    IF BIT(State, 3) THEN
        PRINT BAD CAL
    ENDIF
ENDIF
OUTPUT 713;CS                                 ! clear status byte
Flag=1                                         ! set control flag true
RETURN
    
```

3.7.2 Calibrator Source

The 8650A Calibrator output (a fixed signal at 0 dBm) is activated and deactivated by means of two simple commands:

Syntax:	[OC1 or OC0]	
Example:	OUTPUT 713;OC	! TURNS ON CALIBRATOR SOURCE
Example 2:	OUTPUT 713;OC0	! TURNS OFF CALIBRATOR SOURCE

 **NOTE:** This command is needed for test purposes only. The calibrator source is enabled automatically during calibration of a sensor.

The following command sets the calibrator frequency for Option 12:

Syntax:	[OC1] <i>d</i> (where <i>d</i> = HZ, KZ, MZ, GZ)	
Example:	OUTPUT 713;OC1 1.000 GZ	! SETS THE CALIBRATOR FREQUENCY TO 1.000 GHZ

 **NOTE:** This command resets calibration output to 0.00 dBm.

3.7.3 Calibrator Test

These commands set and query the calibrator output power level:

Syntax:	TEST CALIB POWER <i>d</i> , where <i>d</i> is the dBm power level	
Example:	OUTPUT 713;TEST CALIB POWER 10	! SETS THE CALIBRATOR OUTPUT POWER AT 10 DBM

Syntax:	TEST CALIB POWER?	
Example:	OUTPUT 713;TEST CALIB POWER?	! QUERIES THE CALIBRATOR OUTPUT POWER LEVEL

These commands set and query the calibrator frequency for Option 12:

Syntax:	TEST CALIB FREQ <i>d</i> , (HZ, KZ, MZ, GZ)	
Example:	OUTPUT 713;TEST CALIB FREQ 800.0 MZ	! SETS THE CALIBRATOR FREQUENCY TO 800 MHZ

Syntax:	TEST CALIB FREQ?	
Example:	OUTPUT 713;TEST CALIB FREQ?	! QUERIES THE CALIBRATOR FREQUENCY

 **NOTE:** During power sensor calibration, the calibrator frequency is automatically set to 50 MHz for all sensors except 807XXA which are calibrated at 1 GHz.

3.7.4 Channel Designation

The command is required to specify which channel (display line) will be assigned to all subsequent commands that are affected.

The affected commands are: LG, LN, RE, RL(0/1/2), LH, LL, LM(0/1), MAX, MIN, MIN(0/1) and STAT.

Syntax:	[AE or BE] CH <i>n</i> EN (where <i>n</i> = 1,2,3 or 4 line number)	
Example:	OUTPUT 713;BE CH 3 EN	! THE COMMANDS TO FOLLOW APPLY TO SENSOR B AND DISPLAY LINE #3

3.8 Crest Factor

The Crest Factor feature holds on to the highest instantaneous power measured from the time the feature is enabled until it is reset; it is similar to the Peak Hold feature, except that the measurement is expressed as a ratio in relation to average power.

Like the Peak Hold feature, the Crest Factor feature also has the same minimum average power level restriction of -20 dBm. Beginning in firmware version 1.51, this has been implemented to increase accuracy and maintain wide bandwidth of Crest Factor measurement over the peak power range of -20 dBm to +20 dBm. The Crest Factor selection will also affect Histogram measurement if there is power below -20 dBm. To obtain accurate average power measurements below -20 dBm, the Crest Factor feature should be disabled.



NOTE: The Crest Factor feature can only be used in the standard measurement collections modes (not in the fast modes), and only in a modulated measurement mode (MAP, PAP or BAP). Crest Factor is not recommended for use in combination with the V_{PROP}^F function.

3.8.1 Enabling the Crest Factor Feature

The Crest Factor feature is enabled or disabled by one of two function codes:

Syntax:	[AE or BE] [CR0 or CR1]	
Example:	OUTPUT 713;AE CR1	! ENABLES THE CREST FACTOR FEATURE FOR SENSOR A
Example 2:	OUTPUT 713;BE CR0	! DISABLES THE CREST FACTOR FEATURE FOR SENSOR B
Description:	Like the PH0 and MN0 commands, the CR0 command will disable Peak Hold and Min/Max measurements. Sending a CR1 command after the Crest Factor is enabled will reset both the Crest Factor and Peak Hold (See Section 3.19.7).	

3.8.2 Reading the Crest Factor Value

The Crest Factor value is read over the bus using a simple command:

Syntax:	[AE or BE] CRF	
Example:	OUTPUT 713;AE CRF	! SENDS THE CREST FACTOR VALUE FOR SENSOR A

The Crest Factor feature monitors the maximum power as it is measured, but does not provide any feedback to the controller until a CRF command is received. To monitor for a limit violation, the Limits feature may be more useful (See Section 3.15).

Series 8650A Universal Power Meters

The Crest Factor feature returns the current ratio between held power and average power, as displayed on the front panel. A CRF command does not initiate data collection in same manner as a trigger command, such as TR1. To get a good reading of the Peak Hold value, the procedure is:

1. Set up the signal being measured, and send CR1 to reset the Crest Factor measurement.
2. Send TR2.
3. Read the TR2 data, or wait for the data ready service request (this allows for settling).
4. Send CRF.
5. Read the Crest Factor value.

3.9 Display Control

3.9.1 Display Testing

The LCD display window and can be tested remotely, by means of three simple commands:

Syntax:	DE (Enable the display) DA (Test the display) DD (Disable the display)	
Example:	OUTPUT 713;DE	! ACTIVATES THE LCD DISPLAY ! (THIS HAS THE EFFECT OF CANCELING A DA OR DD COMMAND)
Example 2:	OUTPUT 713;DA	! PERFORMS A TEST OF THE DISPLAY
Example 3:	OUTPUT713;DD	! DISABLES THE DISPLAY

3.9.2 Displaying Messages

The DU function can show a test message in the LCD display window. The command format for this purpose is:

Syntax:	DU [string]	
	The test message string can contain up to 32 characters.	
Example:	OUTPUT 713;DU THIS IS A TEST	! SHOWS THE MESSAGE THIS IS A TEST ON THE ! LCD DISPLAY WINDOW

3.10 Duty Cycle Commands

3.10.1 Activating or Deactivating a Duty Cycle

The commands which activate or deactivate a duty cycle are based on the DC0 and DC1 functions. The command format is:

Syntax:	[AE or BE] [DC0 or DC1]	
	[AE or BE] prefix specifies Sensor A or Sensor B	
	[DC0] turns the duty cycle off (for the specified sensor); if the sensor is in Pulse Average Power measurement mode, this command will change the sensor measurement mode to Modulated Average Power. If the sensor is not measuring Pulse Average Power at the time this command is received, then this command will have no effect	
	[DC1] turns the duty cycle on. This is equivalent to the PAP command (See Measurement Mode Commands in Section 3.18)	
Example:	OUTPUT 713;AE DC0	! TURNS OFF THE DUTY CYCLE FOR SENSOR A
Example 2:	OUTPUT 713;BE DC1	! TURNS ON THE DUTY CYCLE FOR SENSOR B

3.10.2 Specifying a Duty Cycle

The commands which specify a duty cycle are based on the DY function. The command format is:

Syntax:	[AE or BE] DY [n] [EN or PCT or %]	
	[AE or BE] prefix specifies Sensor A or Sensor B	
	DY specifies a duty cycle value; it also configures the sensor to Pulse Average Power mode. Therefore, this function includes the capabilities (and entry error reporting) of the PAP function (See Measurement Mode Commands in Section 3.18)	
	[n] species the duty cycle value in percent with a valid range of .001 to 99.999)	
	A terminating suffix is required (EN, PCT or %)	
Example:	OUTPUT 713;AE DY 50 %	! SETS 50% DUTY CYCLE FOR SENSOR A
Example 2:	OUTPUT 713;BE DY 25.000 EN	! SETS 25% DUTY CYCLE FOR SENSOR B
Example 3:	OUTPUT 713;BE DY 40.412 PCT	! SETS 40.412% DUTY CYCLE FOR SENSOR B

3.10.3 Reading Duty Cycle Status

The status message bit O indicates whether the duty cycle function is active for the selected sensor. 0 indicates OFF; 1 indicates ON.

3.11 Time Gating Measurement

The structure of the Time Gating GPIB commands for the Series 8650A Universal Power Meters has been modified from the format used in the Series 8540C Universal Power Meters. The timing parameters cannot be concatenated into a single command string. Each parameter must be specified in an individual string.



NOTE: For the Series 8650A in 8540C Emulation, the 8540C Time Gating commands must be modified to meet the 8650A Time Gating GPIB command structure.

3.11.1 Description

The time gating measurement option limits a power measurement to a defined interval that is controlled by a start time and a duration. The start time begins after a programmable delay following a hardware trigger applied to the Trigger Input connector on the instrument's rear panel.

Off/Gated/Trigger	This selects between two modes of specifying the measurement period.
Off	Cancels the time gating function.
Gated	Selects the External Gating Mode in which measurements are taken while the trigger input signal is true.
Trigger	Selects the External Trigger Mode and initiates a sequence of timers for defining the measurement duration.

3.11.1.1 External Gating Mode

Gate Polarity	This specifies the external signal TTL high or low level as true for defining the gated time.
----------------------	---

3.11.1.2 External Trigger Mode

Trigger Polarity	This specifies the rising or falling edge of the trigger signal as the time reference point.
Trigger Delay	This is the delay time from receipt of an externally gated trigger edge input to the start of the gated measurement period.
Gate Time	This specifies of the length of the gated measurement period.
Holdoff Time	This is the timeout period between the end of the measurement period and the time another trigger will be accepted.

3.11.2 Time Gating Mode

The Time Gating mode is fully defined and illustrated in Section 2.3.1 of this publication. The following are the commands for using this feature over the GPIB.

3.11.2.1 Gate A or B

All time gating commands begin with GATE. Only one setup data structure is stored by the meter, so the parameters specified apply to the one channel that has time gating enabled. For example, the command GATEA enables the time gating on channel A with previously specified parameters, and GATEB switches time gating to channel B with the same parameters.

3.11.2.2 OFF or GATE or TRIGGER or EDGE

OFF turns off the time gating on either channel regardless of the channel specified. If GATE is sent, the time gating board is set up in the External Gating Mode. If TRIGGER is sent, the External Trigger Mode will be enabled. Although it is legal to send any of the indicated parameters in one command, only the last specified parameter is relevant. For example, if the command GATEA OFF TRIGGER GATE is sent, the time gating option will be set up in the External Gating Mode.

Example:	OUTPUT 713;GATEA EDGE
----------	-----------------------

3.11.2.3 INVERT or NONINVERT

INVERT and NONINVERT specify the polarity of the trigger input signal. In the External Gating Mode, INVERT specifies that measurements can be taken when the trigger input is low, and NONINVERT specifies the measurements can be taken when the trigger input is high. In the External Trigger Mode, INVERT specifies that a falling edge on the trigger input triggers the gating, and NONINVERT specifies that a rising edge triggers the gating. Although it is legal to send both of the parameters in one command, only the last specified parameter is relevant.

Example:	OUTPUT 713;GATEA NONINVERT
----------	----------------------------

3.11.2.4 DELAY *d*

DELAY *d* specifies the delay time from the trigger input edge to the start of the gating period. The *d* must be time specified in seconds in the range of 0 to 327.675 μ s in 5 μ s steps, where 0 represents some minimum non-zero delay time. This parameter is relevant only in the External Trigger Mode. For example, if the command

Example:	OUTPUT 713;GATEA DELAY 20E-3
----------	------------------------------

is sent, the External Trigger Mode will be enabled on channel A with a trigger delay of 20 ms. Since the previous set up may be unknown, the DELAY, DURATION and HOLDOFF should be sent in the same command.

3.11.2.5 DURATION *g*

DURATION *g* specifies the duration of the gating period. The *g* must be a time specified in seconds in the range of 5 μ s to 327.675 μ s, with a resolution of 5 μ s. This parameter is relevant only in the External Trigger Mode. For example, if the command

Example:	OUTPUT 713;GATEA DURATION 250E-3
----------	----------------------------------

is sent, the External Trigger Mode will be enabled on channel A with a gate duration of 250 ms.

3.11.2.6 HOLDOFF *h*

HOLDOFF *h* specifies the holdoff time from the end of the gating period to the time when the circuit will accept another trigger input edge. The *h* must be a time specified in seconds in the range of 0 to 327.675 μ s, with a resolution of 5 μ s. This parameter is relevant only in the External Trigger Mode. For example, if the command

Example:	OUTPUT 713;GATEA HOLDOFF 0
----------	----------------------------

is sent, the External Trigger Mode will be enabled on channel A with no holdoff delay.

3.11.2.7 Error Codes

Specifying a channel where no sensor is connected, or it is a peak sensor not in CW mode, then the Entry Error bit of the Status byte is set, as well as the Execution Error bit of the Event Status register. If requesting the Status Message, the code in the Entry Error portion of the message will be 64.

If specifying an out of range value for the delay, gate duration, or holdoff values, the Entry Error bit of the Status byte is also set as well as the Execution Error bit of the Event Status register. If requesting the Status Message, the code in the Entry Error portion will be 65 for a delay range, 66 for a gate duration range error and 67 for a holdoff range error.

3.12 EEPROM

3.12.1 EEPROM Cal Factors

The EEPROM command is used to query the cal factor data in the sensor EEPROM. The cal factor data is typically stored in the EEPROM at 1 GHz steps over the frequency range of the sensor. Additional cal factors may also be stored at additional special frequencies. When a measurement frequency is specified which does not exactly match the frequencies at which cal factors have been stored, the power meter determines the appropriate cal factor via interpolation.

Commands to read EEPROM cal factor data are based on the EEPROM function code. The command format is:

Syntax:	EEPROM [A or B] [CALF? or FREQ?]	
	[A or B] specifies Sensor A or Sensor B	
	[CALF?] queries the cal factors. The cal factor data is output as a table of cal factors expressed in dB, separated by commas	
	[FREQ?] queries the frequencies which correspond to the cal factors. The frequency data is output as a table of frequencies expressed in Hz, separated by commas	
Example:	OUTPUT 713;EEPROM A CALF?	! QUERIES SENSOR A EEPROM WHOLE CAL FACTOR ! TABLE ! (THIS EXAMPLE IS FROM AN 80301A SENSOR)
Response:	0.00, 0.00, 0.00, 0.00, 0.00, 0.00, 0.00, 0.00, 0.00, 0.00, 0.00, 0.00, 0.00, 0.00, 0.00, 0.00, 0.00	
Example:	OUTPUT 713;EEPROM A FREQ?	! QUERIES SENSOR A EEPROM WHOLE ! FREQUENCY TABLE ! (THIS EXAMPLE IS FROM AN 80301A SENSOR)
Response:	5.000e7, 2.000e9, 3.000e9, 4.000e9, 5.000e9, 6.000e9, 7.000e9, 8.000e9, 9.000e9, 1.000e10, 1.100e10, 1.200e10, 1.300e10, 1.400e10, 1.500e10, 1.600e10, 1.700e10, 1.800e10	

3.12.2 Frequency

Cal factors are stored in the sensor’s EEPROM by frequency. Specifying a frequency causes the 8650A to apply the cal factor appropriate to that frequency. To cancel the use of cal factors, specify a frequency of 50 MHz (this is the frequency of the front panel Calibrator reference output, and has a cal factor of zero).

Commands which specify a frequency are based on the FR function. The command format is:

Syntax:	[AE or BE] FR [n] [HZ or KZ or MZ or GZ]	
	[AE or BE] prefix specifies Sensor A or Sensor B	
	FR specifies a frequency value	
	[n] specifies the frequency value (the units are Hz, kHz, MHz, or GHz, depending on the terminating suffix used). A terminating suffix is required (HZ, KZ, MZ, or GZ)	
Example:	OUTPUT 713;AE FR 5.67 GZ	! FREQUENCY FOR SENSOR A IS 5.7 GHZ
Example 2:	OUTPUT 713;AE FR 1.0E9 HZ	! FREQUENCY FOR SENSOR A IS 1E9 HZ (1 GHZ)
Example 3:	OUTPUT 713;BE FR 84.6 MZ	! FREQUENCY FOR SENSOR B IS 84.6 MHZ

3.13 Instrument Identification

The 8650A can be queried over the GPIB for purposes of identification; user application programs make use of such queries in order to verify that the appropriate equipment is connected. The 8650A will reply to an ID query by sending back an identification string.

The simple commands which query the instrument ID consist of any of three function codes:

Syntax:	[ID or ?ID or *IDN?]	
Example:	OUTPUT 713;*IDN?	! ASKS FOR ID STRING
Example 2:	ENTER 713; NAME	! READS ID INTO STRING VARIABLE NAME

3.13.1 Identification Strings

The ID string is determined by the configuration choices that were made (from the front panel) under the Config/GPIB menu. In the 8651A modes, the ID string consists of four fields separated by commas:

- Field 1 is the manufacturer (GIGA-TRONICS)
- Field 2 is the model (8651A, 8652A, 8541C or 8542C)
- Field 3 is the serial number field (it displays the serial number of the calibrator EEPROM)
- Field 4 is the software version number

Example strings:

8652A mode	Name = GIGA-TRONICS,8652A,9548024,3.00
8451C mode	Name = GIGA-TRONICS,8451C,9548024,3.00
8452C mode	Name = GIGA-TRONICS,8452C,9548024,3.00

However, the ID strings for the following emulation modes are fixed, as follows:

HP437B mode	Name = HEWLETT-PACKARD,437B,1.8
HP438A mode	Name = HP438A,VER1.10
HP436A mode	Not Applicable

HP and Hewlett Packard are registered trademarks of the Hewlett Packard Company.

3.14 Learn Modes

The 8650A has the ability to send information regarding its current configuration to the controller. The controller requests this information by sending a learn mode command. At a later time, the controller can send the configuration information back to the power meter in order to reconfigure the 8650A to the same state it was in when it received the learn mode command.

Conceptually this feature is similar to the store and recall capability of the 8650A but with several important differences:

- The configuration information is stored in the controller's memory and not in the 8650A memory
- Learn Mode #1 returns information regarding the current GPIB operational configuration (such as the trigger mode) which would not be covered by the store/recall function
- The learn modes do not support many of the advanced features of the 8650A
- The learn modes involve transmission of long strings of data between the controller and the 8650A. These strings must be transmitted without interruption; transmissions cannot be considered complete until EOI is read

The two learn modes are discussed under separate headings on the following pages.

The learn modes are provided for the sake of compatibility with remote programs written for older power meters. The configuration information returned to the host is not as complete as the information that would be stored in the 8650A memory using the store/recall function; the configuration data for many features of the 8650A are not included in the learn mode data.

Series 8650A Universal Power Meters

3.14.1 Learn Mode #1

Learn Mode #1 is used to return the configuration of the 8650A to the controller in the form of a sequence of GPIB commands.

3.14.2 Requesting the String

The simple command which requests the Learn Mode #1 string has the following format:

Syntax:	LP1	
Example:	OUTPUT 713;LP1	! REQUESTS LEARN MODE #1 STRING

After receiving the LP1 command, the 8650A will return the Learn Mode #1 string the next time it is addressed to talk. The string will consist of up to 128 ASCII characters. The last character is sent with EOI true. Table 3-14 shows the information contained in the Learn Mode #1 string and the order in which it is sent.

Table 3-14: Learn Mode #1 Output Format

Parameter	Output from the Power Meter ¹
Trigger Mode	TRd
Measurement Mode	AP, BP, AR, BR, AD, or BD
SENSOR A PARAMETERS Cal Factor Offset Range Filter Low Limit High Limit	AE KB ddd.d EN OS ±dd.dd EN RA d EN FA or FM d EN LL ±ddd.ddd EN LH ±ddd.ddd EN
SENSOR B PARAMETERS Cal Factor Offset Range Filter Low Limit High Limit	BE KB ddd.d EN OS ±dd.dd EN RA d EN FA or FM d EN LL ±ddd.ddd EN LH ±ddd.ddd EN
Active Entry Channel	AE or BE
Measurement Units	LG or LN
Reference Oscillator Status	OCO or OC1
Group Trigger Mode	GTd
Limits Checking Status	LMO or LM1
Carriage Return Line Feed	EOI
¹ ± indicates sign; d indicates a single digit.	

3.14.2.1 Sending the String

The power meter can be restored to the configuration described in the Learn Mode #1 string, by sending the string to the 8650A.

3.14.3 Learn Mode #2

Learn Mode #2 is used to return the 8650A configuration information to the controller in the form of a series of binary values.

3.14.3.1 Requesting the String

The simple command which requests the Learn Mode #2 string has the following format:

Syntax:	LP2	
Example:	OUTPUT 713;LP2	! REQUESTS LEARN MODE #2 STRING

After receiving the LP2 command, the 8650A will return the Learn Mode #2 string the next time it is addressed to talk. The string starts with two ASCII characters, @ and 2, followed by a string of 28 (58 for the 437 emulation mode) 8-bit binary bytes. The last byte is sent with EOI true. Learn Mode #2 requires a controller that can receive and send information in binary form.

The Learn Mode #2 string contains the following information:

- Measurement mode
- REL mode status (ON | OFF)
- Reference oscillator status (ON | OFF)
- Current reference value if in REL mode
- Measurement units (Log or Lin)
- Cal Factor for each sensor
- Offset for each sensor
- Range for each sensor
- Filter for each sensor

3.14.3.2 Sending the String

The command that sends the Learn Mode #2 data to the 8650A is based on the @2 function. The command format is:

binary bytes

The 8650A will change its configuration to match the configuration defined by the Learn Mode #2 string.

3.15 Limits

 **NOTE:** Both limits need to be set and LL must always be lower than LH. The reason is that the default settings are 0 dBm for LL and LH.

3.15.1 Setting Limits

Commands which set limits are based on the LH and LL function codes. The command format is:

Syntax:	[LH or LL] [n] EN	
	[LH] specifies the high limit; LL specifies the low limit	
	[n] is a limit value, expressed in dBm or dB as appropriate	
	A terminating suffix is required (EN)	
Example:	OUTPUT 713;LH 12.34 EN	! SETS HIGH LIMIT TO +12.34 DB
Example 2:	OUTPUT 713;LL -2.58 EN	! SETS LOW LIMIT TO -2.58 DB

 **NOTE:** These commands must be preceded by CH [n] EN command.

3.15.2 Activating Limits

Limit-checking is activated or deactivated by simple commands consisting of one of two function codes:

Syntax:	[LMO or LM1]	
	[LMO] disables limit checking	
	[LM1] enables limit checking	
Example:	OUTPUT 713;LMO	! DISABLES LIMIT CHECKING
Example 2:	OUTPUT 713;LM1	! ENABLES LIMIT CHECKING

Before enabling limit checking (LM1), set the high and low limits (LH and LL). Once enabled, the Status Byte (Bit 4) will signal a too high or too low condition. The status message AA bytes will indicate a too high condition (Error code 21), or a too low condition (Error code 23). Status Message byte L contains the limit status. 0 indicates within limits, 1 indicates too high, and 2 indicates too low.

The LCD display will indicate a too high condition with Over Limit displayed to the right of the reading, and Under Limit displayed to the right of the reading for a too low condition.

 **NOTE:** These commands must be preceded by CH [n] EN command.

3.15.3 Measuring with Limits

For Sensor A or B measurements with limits are enabled by the command

Syntax:	LM1.	
Example:	OUTPUT 713; AP LM1	! MEASURES SENSOR A AND ENABLE LIMIT CHECKING

This measures Sensor A with the previously set LL and LH limits.

Example:	OUTPUT 713; BP LM1	! MEASURES SENSOR B AND ENABLE LIMIT CHECKING
----------	--------------------	---

This measures Sensor B with previously set LL and LH limits.

3.16 Measurement Collection Modes (Standard)

3.16.1 Measurement Triggering

Trigger modes determine when a measurement will be made. Four simple commands consisting of one of four function codes select the desired mode:

Syntax:	[TR0 or TR1 or TR2 or TR3]
---------	----------------------------

All four modes discussed here are standard measurement collection modes (as opposed to the fast modes described in Section 3.17), and use the standard data output format.

3.16.1.1 Trigger Hold (TR0)

This command places the instrument in standby mode. The LCD display is frozen at the current values. The display will be updated when the instrument receives a TR1 or TR2 command. To resume the normal free run mode of the instrument and display, use the TR3 command. During the standby mode, the instrument continues to make measurements and update the internal digital filter, but does not update the display or the GPIB buffer.

Example:	OUTPUT 713;TR0	! SELECTS THE TRIGGER HOLD MODE
----------	----------------	---------------------------------

3.16.1.2 Trigger Immediate (TR1)

This command triggers a single reading; the reading is added to the internal digital filter. An ENTER statement will return the updated filter power level. After a TR1 command, the instrument returns to the standby mode.

Example:	OUTPUT 713;TR1	! TRIGGER A SINGLE MEASUREMENT
----------	----------------	--------------------------------

3.16.1.3 Trigger Immediate with Full Averaging (TR2)

This mode triggers a new series of readings; enough to update the digital filter for a noise free reading at the current power level. An ENTER statement will return the fully updated filter power level. After a TR2 command, the instrument returns to the standby mode.

Example:	OUTPUT 713;TR2	! TRIGGER A FULL MEASUREMENT, WITH SETTling
----------	----------------	---

3.16.1.4 Free Run (TR3)

This free run trigger mode (which is the default mode) allows the user to read the power at any time with an ENTER statement. There is no need to send the TR3 command again. Multiple ENTER statements can be executed. The power meter will return the present power level just as if looking at the LCD display.

Example:	OUTPUT 713;TR3	! FREE RUN TRIGGER MODE
----------	----------------	-------------------------

3.16.2 Group Execute Trigger

The GPIB GET command (group execute trigger) causes all the devices on the interface which are currently addressed to listen to start a device dependent operation (usually a measurement). Three simple commands (consisting of one of three function codes) regulate the 8650A response to a GET command:

Syntax:	[GT0 or GT1 or GT2]
---------	---------------------

This command disables the response of the 8650A to a GPIB GET command.

Example:	OUTPUT 713;GT0	! GROUP EXECUTE TRIGGER CANCEL
----------	----------------	--------------------------------

3.16.2.1 Group Trigger Immediate (GT1)

This mode is similar to the mode specified by the TR1 command (trigger immediate), except that the GT1 command causes the 8650A to wait for a GPIB GET command. When the GET command is received, it triggers a single reading which is added to the internal digital filter. An ENTER statement will return the updated filter power level. After a GT1 command, the instrument is placed in the standby mode.

Example:	OUTPUT 713;GT1	! GROUP EXECUTE TRIGGER SINGLE MEASUREMENT
----------	----------------	--

This mode is similar to the mode specified by the TR2 command (trigger immediate with full averaging), except that the GT2 command causes the 8650A to wait for a GPIB GET command. When the GET command is received, it triggers a new series of readings; enough to update the digital filter for a noise free reading at the current power level. An ENTER statement will return the fully updated filter power level. After a GT2 command, the instrument is placed in the standby mode.

Example:	OUTPUT 713;GT2	! GROUP EXECUTE TRIGGER FULL MEASUREMENT WITH SETTLING
----------	----------------	--

3.17 Measurement Collection Modes (Fast)

3.17.1 General

The 8650A offers three special fast measurement collection modes which are available only during remote operation over the GPIB. These fast modes make it possible to take more measurements per second, but at the cost of limited functionality compared to the standard measurement collection mode. The fast modes operate differently from the standard measurement collection mode in several important ways. The three fast modes are called Swift, Fast Buffered and Fast Modulated.

3.17.1.1 Sensor Measurements Supported

One restriction on the 8650A functionality in the fast modes is that it cannot perform comparative measurements (that is, measurements consisting of a comparison between the two sensors, such as A/B or A-B). However, when the 8650A operates in the Swift and Fast Buffered modes, it does have an added capability which is not otherwise available: measurements from both sensors can be returned to the host. In the Fast Modulated mode, only one sensor measurement can be performed and returned to the host.

3.17.1.2 Averaging

The averaging feature has a unique implementation in the Swift and Fast Buffered modes. Note that in standard measurement collection modes, and in the Fast Modulated modes, the averaging factor is taken to indicate the amount of filtering desired. Each measurement which is returned to the host is a true running average for a period of time which is derived from the averaging factor.

In the Swift and Fast Buffered modes, the averaging indicates the exact number of samples to be taken for each returned measurement, with the proviso that a minimum of four samples are taken (even if a number below four is requested).



NOTE: Four samples are also taken if auto averaging is selected. Each measurement returned to the host reflects all new data. Therefore, operation will be much faster with an averaging number of four than with a higher number.

3.17.1.3 Disabled Features

The following features are disabled during operation in any of the three fast modes: over-range alert, limit checking, min/max power, relative measurements, peaking meter, analog output and $V_{\text{PROP}}^{\text{F}}$ (voltage proportional to frequency) correction.

3.17.1.4 Measurement Changes

Other changes to the operation of the instrument during fast operation include the following: the temperature of the sensors is not read and updated, so the temperature correction will become inaccurate over time if the temperature of the sensor changes.

3.17.1.5 Warning Regarding Interruption & Reconfiguration

Another important consideration is that, while any of the three fast measurement modes is running, it should not be interrupted, and the measurement setup should not be changed. The measurement setup must be thoroughly configured before the command is sent to start the fast measurement mode. To reconfigure the instrument, or to zero a sensor, it is necessary to exit the fast mode and then restart it. If a measurement setup command is sent after a fast mode command, the results are undefined.

3.17.1.6 Fast Mode Setup

Prior to initiating a fast measurement collection mode, the host should select the measurement (i.e., AP or BP), select the measurement mode (i.e., CW, MAP, PAP, PEAK or BAP), define the frequency correction (via the FR or KB command, but not via the V_{PROP} function), define the offset (if any), define the averaging (via the FA or FM command), and define the duty cycle (if applicable). When a fast mode is initiated, the display will blank and a message will display indicating the fast mode selected.

3.17.2 Data Output Formats for Fast Modes

The data output formats for fast measurement collection are illustrated below. Fast mode data is always returned in units of dBm. Each A or B represents a single digit (0 to 9).

3.17.2.1 For the Swift Free-Run Mode

If one sensor is used, the format is:

±AAA.AA CR LF
±AAA.AA CR LF etc.
or:
±BBB.BB CR LF
±BBB.BB CR LF etc.

If two sensors are used, the format is:

±AAA.AA,±BBB.BB CR LF
±AAA.AA,±BBB.BB CR LF etc.

3.17.2.2 For The Swift Triggered & Fast Buffered Modes

If one sensor is used, the format is :

±AAA.AA, ±AAA.AA, etc. CR LF
or:
±BBB.BB, ±BBB.BB, etc. CR LF

If two sensors are used, the format is:

±AAA.AA, ±AAA.AA, etc. [until the specified number of readings has been sent]
±BBB.BB, ±BBB.BB, etc. [until the specified number of readings has been sent],
CR LF

3.17.2.3 For the Fast Modulated Mode

In this mode, only one sensor can be used; the format is:

±AAA.AA CR LF
±AAA.AA CR LF etc.
or:
±BBB.BB CR LF
±BBB.BB CR LF, etc.



NOTE: If BAP is unable to sync, 200.00 is added to the actual value in order to flag this error condition.

3.17.3 Fast Buffered Mode

Fast Buffered Mode is a fast measurement collection mode, which makes it possible for a series of measurements to be taken and buffered rapidly, without external triggering of each measurement. The measurement collection can consist of a buffer-load of measurements taken after a trigger, or a buffer-load of measurements taken prior to a trigger (that is, the trigger marks the beginning or the end of the measurement period, depending on the option selected). This mode also makes it possible to buffer a very large number of data points. For the sake of speed, no chopped measurements are taken in the fast buffered mode.

The fast buffered mode cannot be entered if a modulated measurement (MAP, PAP or BAP) is being performed.

Commands related to the fast buffered mode are based on the FBUF command. (For the sake of backward compatibility with earlier Giga-tronics power meter designs, the command BURST is accepted as a substitute for FBUF. However, this command has nothing to do with the burst average power measurement mode; it is a vestige of the terminology applicable to previous models). For the FBUF commands, the command format is:

Syntax:	<p>FBUF [PRE or POST] [GET or TTL] BUFFER [b] TIME [t]</p> <hr/> <p>[PRE or POST] define the relationship between the measurement period and the trigger: [PRE] the trigger marks the end of the measurement period. The 8650A will continuously take measurements and buffer them until a trigger is received. At that point, it will stop collecting data and output all of the previously collected data in a continuous data stream the next time it is addressed to talk</p> <p>[POST] the trigger marks the beginning of the measurement period. The 8650A will wait for a trigger before taking and buffering the measurements. After the requested number of measurement have been taken and buffered, it will be ready to output all of the data in a continuous stream the next time it is addressed to talk. If the GPIB GET command is specified as the trigger, the 8650A will assert a service request at this time</p> <p>[GET or TTL] define the trigger</p> <p>[GET] the expected trigger is a GPIB GET command</p> <p>[TTL] the expected trigger is a TTL high at the rear panel trigger input</p> <p>The buffer value (numeric variable [b]) specifies the number of measurements to be taken and stored in the buffer. The minimum value is one. The maximum value is 5,000</p> <p>The time value (numeric variable [t]) is an optional variable which specifies a fixed delay between measurements. The time value specifies the time (in ms) to wait between measurements; the minimum value is zero. The maximum value is 5000 ms (five seconds)</p>
----------------	--



NOTE: This delay is in addition to the relatively short time it takes to perform each measurement. If no time value is specified, [t] is assumed to be zero, and the measurements are taken as fast as possible.

Example:	OUTPUT 713;FBUF PRE GET BUFFER 200	! TAKE MEASUREMENTS (AS FAST AS POSSIBLE) ! UNTIL GET IS RECEIVED ! THEN OUTPUT THE LAST 200 MEASUREMENTS ! TAKEN
Example 2:	OUTPUT 713;FBUF POST TTL BUFFER 100 TIME 2	! WAIT FOR A TTL TRIGGER, THEN TAKE READINGS ! AT INTERVALS OF 2 MS ! UNTIL A TOTAL OF 100 MEASUREMENTS HAVE ! BEEN TAKEN

Two simpler commands are also based on the FBUF function code:

Syntax:	FBUF [DUMP or OFF]	
	[DUMP] stops the data measurement and buffering, and prepares to return the data taken so far to the host, even if fewer than the requested number of measurements have been taken. The requested number of measurements are still returned to the host (the extra measurements beyond those actually taken are represented by the number - 300.00)	
	[OFF] causes the 8650A to exit the fast buffered mode. All unread data is lost	
Example:	OUTPUT 713;FBUF DUMP	! STOP MEASUREMENT AND BUFFERING
Example 2:	OUTPUT 713;FBUF OFF	! EXIT THE FAST BUFFERED MODE

3.17.3.1 Fast Buffered Mode Speed Notes

The fast buffered mode is the fastest method of collecting measurement data. Top speed in the fast buffered mode is achieved by using a low averaging number (≤ 4), the POST trigger mode, and no time delay between measurements.

The POST trigger mode is faster than the PRE trigger mode because in the latter mode the 8650A must check for a trigger between each measurement. In the POST mode, the 8650A is in freerun operation after the trigger is received.

After issuing the Fast Buffered command, allow for the 8650A to set up in Fast Buffered mode before issuing a TTL or GET (Group Executable Trigger). Typical delay may vary from 200 msec to 500 msec based on the number of samples to be collected.

Series 8650A Universal Power Meters

3.17.4 Swift Mode

Swift mode is a fast mode which allows for fast continuous data taking and return of each measurement to the host as it is taken (the freerun mode). Swift mode also allows for triggered buffered measurements, in which a host or external trigger indicates when to take each measurement.

The swift mode cannot be entered if a modulated measurement (MAP, PAP or BAP) is being performed.

Commands related to the swift mode are based on the SWIFT function code:

Syntax:	SWIFT [FREERUN or OFF]	
	[FREERUN] initiates the freerun mode (continuous taking and returning of measurements)	
	[OFF] causes the 8650A to exit the swift mode; all unread data is lost	
Example:	OUTPUT 713;SWIFT FREERUN	! INITIATE SWIFT FREERUN MODE
Example 2:	OUTPUT 713;SWIFT OFF	! EXIT THE SWIFT MODE

For commands which set up triggered measurements, the command format is:

Syntax:	SWIFT [GET or TTL] BUFFER [b]	
	[GET or TTL] define the trigger:	
	[GET] the expected trigger is a GPIB GET command. The 8650A signals the host by asserting SRQ every time it is ready to take a measurement	
	[TTL] the expected trigger is a TTL high at the rear panel trigger input	
	BUFFER (followed by the numeric variable [b]) specifies the number of measurements to be taken and stored in the buffer. The minimum value is one. The maximum value is 5000	
Example:	OUTPUT 713;SWIFT GET BUFFER 200	! TAKE MEASUREMENTS UNTIL GET IS RECEIVED ! THEN OUTPUT THE LAST 200 MEASUREMENTS ! TAKEN
Example 2:	OUTPUT 713;SWIFT TTL BUFFER 200	! WAIT FOR A TTL TRIGGER, THEN TAKE 100 ! MEASUREMENTS

3.17.4.1 Example Programs

The following program can measure, buffer and print 30 readings on one sensor:

```

REAL Data(30)7
Example: OUTPUT 713;SWIFT GET BUFFER 30WAIT 0.5
                                     ! wait for instrument configuration

FOR I=1 to 30
  Srq_flag=0
  ! wait for ready condition
  TRIGGER 713
  ! trigger measurement
  WHILE Srq_flag=0
    Srq_flag=SPOLL(713)
  END WHILE
NEXT I
  ENTER 713;Data(*)
  FOR I=1 TO 30
    PRINT I,Data(I)
  NEXT I

```



NOTE: For a computer that does not support matrix reads, read the entire buffer into a string and parse the data. Multiple ENTER commands will not work.

The following program can be used to perform 20 measurements on two sensors in swift freerun mode:

```

OUTPUT 713;APBP
OUTPUT 713;SWIFT FREERUN
WAIT 0.5
FOR I=1 to 20
  ENTER 713;ReadA,ReadB
  PRINT ReadA,ReadB
NEXT I
OUTPUT 713;SWIFT OFF

```

The following program can be used to measure, buffer, and print 30 readings on each of two sensors:

```

REAL DataA(30),DataB(30)
OUTPUT 713;SWIFT GET BUFFER 30
WAIT 0.5
FOR I=1 to 30
  srq_flag=0
  TRIGGER 713                                     ! send group execute trigger
  WHILE srq_flag=0
    srq_flag=SPOLL (713)
  END WHILE
NEXT I
  ENTER 713;DataA(*),DataB(*)                       ! read the buffer
  FOR I=1 to 30
    PRINT I,DataA(I),DataB(I)
  NEXT I

```

3.17.5 Fast Modulated Mode

This is a fast mode which permits more frequent return of measurement data to the host, during operation in the modulated measurement modes (MAP, PAP or BAP). The commands which activate or deactivate this mode are based on the FMOD function code:

Syntax:	FMOD [ON OFF]	
	[ON OFF] enables or disables the fast modulated mode	
	When the fast modulated mode is enabled, data will be taken and returned continuously. This is analogous to the swift freerun mode	
	The fast modulated mode cannot be initiated unless a modulated measurement (MAP, PAP or BAP) is being performed	
Example:	OUTPUT 713;FMOD ON	! ENABLES FAST MODULATED MODE
Example 2:	OUTPUT 713;FMOD OFF	! DISABLES FAST MODULATED MODE

3.18 Measurement Mode Commands

3.18.1 CW Mode

Commands which specify the CW measurement mode are based on the CW function code:

Syntax:	CW [A or B]
	[AE or BE] specifies Sensor A or Sensor B

These commands can be used with any sensor (although it is superfluous in the case of a CW sensor). Possible GPIB entry errors: 60 (uncalibrated sensor), 61 (missing sensor). Refer to Table 3-18 for error numbers.

Example:	OUTPUT 713;CW A	! SELECTS CW MODE FOR SENSOR A
Example 2:	OUTPUT 713;CW B	! SELECTS CW MODE FOR SENSOR B

3.18.2 MAP Mode

Commands which specify the modulated average power measurement mode are based on the MAP function code:

Syntax:	MAP [A or B]
	[AE or BE] specifies Sensor A or Sensor B

These commands will work only with a modulated sensor. Possible GPIB entry errors: 60/61 (uncalibrated or missing sensor A/B), 62/63 (not a modulated sensor, or two sensor operation active, A/B). Refer to Table 3-18 for error numbers.

Example:	OUTPUT 713;MAP A	! SELECTS MAP MODE FOR SENSOR A
Example 2:	OUTPUT 713;MAP B	! SELECTS MAP MODE FOR SENSOR B

If an irregularly modulated signal is measured in MAP mode, measurement settling time will vary as the power meter attempts to synchronize to the modulation. In such a situation, it may be desirable to disable synchronization for faster measurement. The commands which disable synchronization are based on the MAP function code.

Syntax:	MAP [A or B] 0
	[AE or BE] specifies Sensor A or Sensor B 0 specifies that synchronization is to be disabled

Example:	OUTPUT 713;MAP A 0	! DISABLES MAP MODE SYNCHRONIZATION FOR SENSOR A
Example 2:	OUTPUT 713;MAP B 0	! DISABLES MAP MODE SYNCHRONIZATION FOR SENSOR B



NOTE: To reactivate synchronization, send the MAP A or MAP B command again.

Series 8650A Universal Power Meters

3.18.3 PAP Mode

Commands which specify the pulse average power measurement mode are based on the PAP function code:

Syntax:	PAP [A or B]
	[A or B] specifies Sensor A or Sensor B

These commands will work only with a modulated sensor. Possible GPIB entry errors: 60/61 (uncalibrated or missing sensor A/B), 62/63 (not a modulated sensor, or two sensor operation active, A/B). Refer to Table 3-18 for error numbers.

Example:	OUTPUT 713;PAP A	! SELECTS PAP MODE FOR SENSOR A
Example 2:	OUTPUT 713;PAP B	! SELECTS PAP MODE FOR SENSOR B

3.18.4 BAP Mode

Commands which specify the burst average power measurement mode are based on the BAP function code:

Syntax:	BAP [A or B]
	[A or BE] specifies Sensor A or Sensor B

These commands will work only with a modulated sensor. Possible GPIB entry errors: 60/61 (uncalibrated or missing sensor A/B), 62/63 (not a modulated sensor, or two sensor operation active, A/B). Refer to Table 3-18 for error numbers.

Example:	OUTPUT 713;BAP A	! SELECTS BAP MODE FOR SENSOR A
Example 2:	OUTPUT 713;BAP B	! SELECTS BAP MODE FOR SENSOR B

3.18.5 Peak Mode

The commands for Peak mode are discussed under separate headings for the 80350A sensors (See Section 3.19.8).

3.18.6 Measurement Mode Query

It is possible to query the 8650A over the bus to determine what measurement mode has been selected for a particular sensor. The 8650A will respond to a measurement mode query by returning one of the following strings to the controller:

- NO SENSOR
- UNCAL
- CW
- MAP (or MAP SYNC OFF)¹
- PAP
- PEAK
- BAP (or BAP *a b c*)²

Measurement mode query commands are based on the MEAS function code.

Notes:

1. MAP SYNC OFF will be returned if MAP mode synchronization has been disabled.
2. BAP *a b c* will be returned if any of the advanced features have been enabled. In this message, *a* represents the burst start exclude time in ms, *b* represents the burst end exclude time in ms, and *c* represents burst dropout time in ms. The value ranges are $0.000 \leq a \leq 45.548$; $0.000 \leq b \leq 31.949$; $0.000 \leq c \leq 3.747$.

Syntax:	MEAS [A? or B?]	
	[A? or B?] specifies Sensor A or Sensor B	
Example:	OUTPUT 713;MEAS A?	! QUERIES THE MEASUREMENT MODE SETTING FOR SENSOR A
Example 2:	OUTPUT 713;MEAS B?	! QUERIES THE MEASUREMENT MODE SETTING FOR SENSOR B

3.19 Advanced Features

3.19.1 Burst Start Exclude

Commands which cause the beginning of a burst to be excluded from measurement are based on the BSTE function code (this feature is available only in the BAP mode):

Syntax:	[AE or BE] BSTE [a] EN	
	[AE or BE] prefix specifies Sensor A or Sensor B	
	[a] specifies the number of 0.027 ms samples to be excluded; it has an integer value in the range of 0 to 1686 with 1686 samples corresponding to 45.519 ms. The command is ignored for [a] values that are out of acceptable range	
Example:	OUTPUT 713;AE BSTE 1 EN	! EXCLUDES ONE SAMPLE = 0.027 MS FROM START OF BURST, FOR BAP ! MEASUREMENTS ON SENSOR A
Example 2:	OUTPUT 713;BE BSTE 3 EN	! EXCLUDES THREE SAMPLES = 0.081 MS FROM START OF BURST, FOR BAP ! MEASUREMENTS ON SENSOR B

3.19.2 Burst End Exclude

Commands which cause the end of a burst to be excluded from measurement are based on the BSPE function code (this feature is available only in BAP mode):

Syntax:	[AE or BE] BSPE [a] EN	
	[AE or BE] prefix specifies Sensor A or Sensor B	
	[a] specifies the number of 0.027 ms samples to be excluded; it has an integer value in the range of 0 to 1183 (1183 samples correspond to 31.936 ms) when burst dropout time is 0.000 ms. For non-zero values of burst dropout time, the maximum value of end exclude time is limited to 3.396 ms minus the burst dropout time setting. The command is ignored for [a] values that are out of acceptable range	
Example:	OUTPUT 713;AE BSPE 1 EN	! EXCLUDES ONE SAMPLE = 0.027 MS FROM END OF BURST, FOR BAP ! MEASUREMENTS ON SENSOR A
Example 2:	OUTPUT 713;BE BSPE 3 EN	! EXCLUDES THREE SAMPLES = 0.081 MS FROM END OF BURST, FOR BAP ! MEASUREMENTS ON SENSOR B

3.19.3 Burst Dropout Tolerance

Commands which define a tolerated burst dropout time are based on the BTDP function code (this feature is available only in BAP mode):

Syntax:	[AE or BE] BTDP [a] EN	
	[AE or BE] prefix specifies Sensor A or Sensor B	
	[a] specifies the dropout time in milliseconds with a range of 0 to 3.346 when the burst end exclude time is 0.000 ms. The value entered will be rounded to the nearest multiple of 0.027 ms. For non-zero values of end exclude time, the maximum value of burst dropout time is limited to 3.396 ms minus the end exclude time. The command is ignored for [a] values that are out of acceptable range. The actual value can be checked by means of a MEAS query. The dropout time represents a guaranteed minimum time; the time actually tolerated will usually be greater, and can be up to 2.125 times greater. (Note: Selecting a value of zero effectively disables this function)	
Example:	OUTPUT 713;AE BTDP .02 EN	! SETS DROPOUT TIME TO 0.02 MS OR NEAREST (=0.027 MS) DISCRETE ! VALUE, FOR BAP MEASUREMENTS ON SENSOR A
Example 2:	OUTPUT 713;BE BTDP .06 EN	! SETS DROPOUT TIME TO 0.06 MS OR NEAREST (=0.054 MS) DISCRETE ! DISCRETE VALUE, FOR BAP MEASUREMENTS ON SENSOR B

3.19.4 Min/Max Power Value

The Min/Max feature monitors the measurements being taken, and maintains a continuously updated record of the highest and lowest values measured so far.



NOTE: The Min/Max feature can only be used in the standard measurement collections modes (not in the fast modes).

3.19.4.1 Enabling the Min/Max Feature



NOTE: These commands must be preceded by CH [n] EN command.

The Min/Max feature is enabled or disabled by simple commands consisting of one of two function codes:

Syntax:	[MNO or MN1]	
	[AE or BE] prefix specifies Sensor A or Sensor B	
Example:	OUTPUT 713;MN	! ENABLES THE MIN/MAX FEATURE
Example 2:	OUTPUT 713;MNO	! DISABLES THE MIN/MAX FEATURE

The MN1 command, like the LG command, has the effect of specifying logarithmic measurement units (dB or dBm). Like the PH0 and CR0 commands, this command will disable crest factor and peak hold measurements.

Series 8650A Universal Power Meters

3.19.4.2 Reading the Min/Max Values

Min/Max values are read over the bus using simple commands consisting of one of two function codes:

Syntax:	[MIN or MAX]	
	MIN specifies that the current minimum measured value should be sent MAX specifies that the current maximum value should be sent	
Example:	OUTPUT 713;MIN	! SENDS THE MINIMUM MEASURED VALUE
Example 2:	OUTPUT 713;MAX	! SENDS THE MAXIMUM MEASURED VALUE

The Min/Max feature monitors the minimum and maximum powers as they are measured and displayed on the front panel. Transient drop-outs or spikes in the power may not be captured by this feature. If it is necessary to examine transient or unusual events, the triggering capability of the peak power sensor, the fast measurement modes, or the Peak Hold feature may provide a better way to characterize the signal in question. The Min/Max feature monitors for the minimum and maximum power, but does not provide any feedback to the controller until a MIN or MAX command is received. To monitor for a limit violation, the Limits feature may be more useful (See Section 3.15).

The Min/Max feature returns the current Min/Max values as displayed on the front panel. A Min or Max commands does not initiate data collection in same manner as a trigger command, such as TR1. To get a good reading of Min/Max values, the procedure is:

1. Set up the signal being measured, and send MN1 to reset the Min/Max measurements.
2. Send TR2.
3. Read the TR2 data, or wait for the data ready service request (this allows for settling).
4. Send MIN or MAX.
5. Read the Min or Max value.

3.19.5 Offset Commands

Power offsets (in dB) can be specified, in order to provide a fixed correction for loss or gain in the test setup. The offset is added to, not a replacement of, the sensor's cal factors. All measurement data returned by the 8650A over the bus is corrected for the offset that has been specified (even in the fast measurement collection modes).

Be careful with offsets when using the analog outputs. The offset value is reflected in the analog output voltage. A change in the offset value may result in a measurement which is outside of the power range represented by the voltage range of the analog output.

3.19.5.1 Enabling/Disabling an Offset

The commands which enable and disable the offset function are based on the function codes OF0 and OF1:

Syntax:	[AE or BE] [OF0 or OF1]	
	[AE or BE] prefix specifies Sensor A or Sensor B [OF0] deactivates the offset; [OF1] activates the offset	
Example:	OUTPUT 713;AE OF0	! DISABLES OFFSET FOR SENSOR A
Example 2:	OUTPUT 713;BE OF1	! ENABLES OFFSET FOR SENSOR B

3.19.5.2 Setting an Offset Value

The commands which specify the offset value are based on the OS function code:

Syntax:	[AE or BE] OS [n] EN	
	[AE or BE] specifies Sensor A or Sensor B	
	[OS] indicates that an offset is being specified for the sensor [n] specifies the offset in dB. The value of n can range from -99.999 dB to +99.999. A terminating suffix (EN) is required	
Example:	OUTPUT 713;AE OS 20.00 EN	! SETS +20 DB OFFSET FOR SENSOR A
Example 2:	OUTPUT 713;BE OS -15.12 EN	! SETS -15.12 DB OFFSET FOR SENSOR B

 **NOTE:** A change to the offset of a sensor will reset any Peak Hold or Crest Factor measurement involving that sensor.

Series 8650A Universal Power Meters

3.19.6 Measured Offset Entry

A measurement can be saved and used as an offset. The command format for this purpose is:

Syntax:	[AP, BP, AR, BR, AD, or BD] OS DO EN	
	The command begins with a function code which describes the measurement that is to be stored as an offset value. There are six possible function codes; they are interpreted as follows:	
	AP:A BP:B AR:A/B BR:B/A AD:A-B BD:B-A	
	OS followed by DO indicates that the difference between the current offset and the current value of the measurement described in the prefix, is to be saved as an offset value	
	A terminating suffix (EN) is required	
Example:	OUTPUT 713;AP OS DO EN	! SAVES MEASUREMENT A AS AN OFFSET
Example 2:	OUTPUT 713;BP OS DO EN	! SAVES MEASUREMENT B AS AN OFFSET
Example 3:	OUTPUT 713;AR OS DO EN	! SAVES MEASUREMENT A/B AS AN OFFSET
Example 4:	OUTPUT 713;BR OS DO EN	! SAVES MEASUREMENT B/A AS AN OFFSET
Example 5:	OUTPUT 713;AD OS DO EN	! SAVES MEASUREMENT A-B AS AN OFFSET
Example 6:	OUTPUT 713;BD OS DO EN	! SAVES MEASUREMENT B-A AS AN OFFSET

3.19.7 Peak Hold

The Peak Hold feature causes the measured value to hold at the highest instantaneous power measured from the time the feature is enabled until it is reset (the measured value changes only when it is rising to a new maximum, or when it is reset).

When the Peak Hold feature is selected, the minimum average power level that can be accurately measured is -20 dBm. Beginning in firmware version 1.51, this has been implemented to increase accuracy and maintain wide bandwidth of Peak Hold measurement over the peak power range of -20 dBm to +20 dBm. The Peak Hold selection will also affect Histogram measurement if there is power below -20 dBm. To obtain accurate average power measurements below -20 dBm, the Peak Hold feature should be disabled.

The Peak Hold feature can only be used in the standard measurement collections modes (not in the fast modes), and only in a modulated measurement mode (MAP, PAP or BAP). *Peak Hold is not recommended for use in combination with the V_{PROPF} function.*

3.19.7.1 Enabling the Peak Hold Feature

The Peak Hold feature is enabled or disabled by simple commands consisting of one of two function codes:

Syntax:	[AE or BE] [PH0 or PH1]	
	[AE or BE] prefix specifies Sensor A or Sensor B	
	[OF0] deactivates the offset; [OF1] activates the offset	
Example:	OUTPUT 713;AE PH1	! ENABLES THE PEAK HOLD FEATURE FOR SENSOR A
Example 2:	OUTPUT 713;BE PH0	! DISABLES THE PEAK HOLD FEATURE FOR SENSOR B
Description:	Like the MN0 and CR0 commands, The PH0 command will disable Crest Factor and Min/Max measurements. Sending the PH1 command after Peak Hold is enabled will reset it. Peak Hold will also reset when sending a CR1 command (See Section 3.8).	

3.19.7.2 Reading the Peak Hold Value

The Peak Hold value is read over the bus using a simple command:

Syntax:	[AE or BE] PKH	
Example:	OUTPUT 713;AE PKH	! SENDS THE PEAK HOLD VALUE FOR SENSOR A
Description:	The Peak Hold feature monitors the maximum power as it is measured, but does not provide any feedback to the controller until a PKH command is received. To monitor for a limit violation, the Limits feature may be more useful (See Section 3.15).	

Series 8650A Universal Power Meters

The Peak Hold feature returns the current held value as displayed on the front panel. A PKH command does not initiate data collection in same manner as a trigger command, such as TR1. To get a good reading of the Peak Hold value, the procedure is:

1. Set up the signal being measured, and send PH1 to reset the Peak Hold measurement.
2. Send TR2.
3. Read the TR2 data, or wait for the data ready service request (this allows for settling).
4. Send PKH.
5. Read the Peak Hold value.

3.19.8 Peak Power Sensor Commands

Commands related to the peak power sensor are based on the function code PEAK (for the sake of backward compatibility with earlier Giga-tronics power meter designs, the command PULSE is accepted as a substitute for PEAK).

3.19.8.1 Series 80350A Sensors SENS

The command format for setting trigger modes and levels is:

Syntax:	PEAK [A or B] [INT or EXT] TRIG [n]	
	A or B specifies Sensor A or Sensor B	
	[INT or EXT] specifies internal or external triggering	
	TRIG indicates that a trigger level is being set	
	[n] specifies the trigger level in units of dBm in the case of internal triggering, or volts in the case of external triggering	
Example:	OUTPUT 713:PEAK A INT TRIG -10.00	! CONFIGURES SENSOR A FOR INTERNAL TRIGGERING AT ! A TRIGGER LEVEL OF -10.00 DBM
Example 2:	OUTPUT 713:PEAK B EXT TRIG 1.50	! CONFIGURES SENSOR B FOR EXTERNAL TRIGGERING ! AT A TRIGGER LEVEL OF 1.50 VDC

The command format for selecting the CW mode is:

Syntax:	PEAK [A or B] CW	
	[A or B] specifies Sensor A or Sensor B	
	CW specifies the CW mode	
Example:	OUTPUT 713:PEAK A CW	! CONFIGURES SENSOR A FOR CW MEASUREMENTS

A delay between the trigger and the actual measurement can be specified (in the CW mode, delay settings have no effect). The command format for setting the delay is:

Syntax:	PEAK [A or B] DELAY [n]	
	[A or B] specifies Sensor A or Sensor B	
	DELAY indicates that a delay value is being set	
	[n] is a numerical variable which specifies the delay in seconds. It has a range of -20E-9 (-20 ns) to 104E-3 (104 ms)	
Example:	OUTPUT 713:PEAK A DELAY 1.20E-6	! CONFIGURES SENSOR A FOR A DELAY OF 120 MS
Example 2:	OUTPUT 713:PEAK B DELAY 33.5E-9	! CONFIGURES SENSOR B FOR A DELAY OF 33.5 NS



NOTE: The actual duration of the delay is the sum of this setting and the delay offset setting.

Series 8650A Universal Power Meters

An offset to the trigger delay can be specified (in the CW mode, delay settings have no effect). The command format for setting the delay offset is:

Syntax:	PEAK [A or B] OFFSET [n]	
	[A or B] specifies Sensor A or Sensor B	
	OFFSET indicates that a delay offset value is being set	
	[n] is a numerical variable which specifies the offset in seconds. It has a range of -20E-9 (-20 ns) to 104E-3 (104 ms). The default value of the offset is 0	
Example:	OUTPUT 713;PEAK A OFFSET 1.20E-6	! CONFIGURES SENSOR A FOR A DELAY OFFSET OF ! 120 μs

3.19.8.2 Reading Values

Trigger

The query format for trigger settings is:

Syntax:	PEAK [A or B]	
	[A or B] Sensor A or Sensor B	
Example:	OUTPUT 713;PEAK A	! QUERIES THE CURRENT SENSOR A TRIGGER SETTING
Example 2:	OUTPUT 713;TRIG\$! ENTERS THE RETURNED STRING INTO THE STRING VARIABLE TRIG

The possible replies to the query are CW, INT_TRIG and EXT_TRIG.

Delay & Delay Offset

The query format for delay and delay offset settings is:

Syntax:	PEAK [A or B] [DELAY? or OFFSET?]	
	[A or B] specifies Sensor A or sensor B	
	[DELAY?] indicates that delay is being queried [OFFSET?] indicates that delay offset is being queried	
Example:	OUTPUT 713;PEAK A DELAY?	! QUERIES THE CURRENT DELAY SETTING FOR SENSOR A
Example 2:	ENTER 713;DELAY	! ENTERS THE RETURNED NUMBER INTO THE VARIABLE DELAY
Example 3:	OUTPUT 713;PEAK B OFFSET?	! QUERIES THE CURRENT DELAY OFFSET SETTING FOR SENSOR B
Example 4:	ENTER 713;OFFSET	! ENTERS THE RETURNED NUMBER INTO THE VARIABLE OFFSET

3.19.9 Preset

The PR command resets the 8650A to its default settings, leaving the user settings intact as *Previous Settings* if they were different from the default settings. This command does not function while in the SWIFT, FMOD or CM modes.

Alternatively, the IEEE 488.2 command *RST also resets the 8650A to its default settings, and functions in the SWIFT, FMOD and CM modes. These modes must be re-entered either over the GPIB or from the front panel.

The preset conditions of the instrument are outlined in Table 3-15.

Table 3-15: Preset (Default) Conditions

Sensors (All parameters apply to sensor A & sensor B)		General	
Parameter	Condition	Parameter	Condition
Cal Factor	100.0%	Sensor Selection	Sensor A
Offset	0.00 dB	Calibrator	Off
Filter	AUTO	Default Sensor Prefix	Sensor A
Range	AUTO	Resolution	2 (0.01 dB)
Low Limit	0.000 dBm	Limits Checking	Off
High Limit	0.000 dBm	Max/Min	Off
Frequency	50 MHz	REL	Off
Duty Cycle	OFF, 1.000%	Trigger Mode	TR3
Measurement Mode	See Note 1	Group Execute Trigger Mode	GT2
		Display Function	Display Enable
		Peaking Meter Mode	Status
		Pulse Sensor Mode	Internal Trigger
		Measurement Units	See Note 2
		Sound	On
		Analog Output	Off

Notes:

1. The default measurement mode depends on the sensor type. For a CW sensor, the default is CW. For a modulation sensor, the default is MAP. For a peak sensor, the default is INT TRIG. Regardless of the sensor type, all advanced features are turned off.
2. There is a slight difference between the preset conditions as set by a remote command, and as set from the front panel menus. This difference has to do with measurement units. If the 8650A is preset from the front panel, this sets the measurement units to dBm in all cases. If the 8650A is preset over the bus, this sets the measurement units to Watts in the case of HP438 emulation, and has no effect at all in the case of HP436 emulation; otherwise, it sets the measurement units to dBm.

This distinction is made to accommodate differences between emulations for remote programming purposes without affecting the benchtop user.

Series 8650A Universal Power Meters

3.19.10 Relative Measurements

In the relative measurement mode, the 8650A saves the current measured power level as a reference. Subsequent measurements will be expressed relative to this reference level; the measurement units become dBr (for logarithmic measurement) or % (for linear measurement).



NOTE: These commands must be preceded by the CH [n] EN command.

The simple commands associated with relative measurement modes consist of one of three function codes:

Syntax:	[AE or BE] RLO or RL1 or RL2	
	[RLO] deactivates the relative measurement mode	
	[RL1] activates the relative mode, and causes the current measured level to be recorded as the reference level	
	[RL2] activates the relative mode and causes the reference level that was saved under a prior RL1 command to be used as the reference level. That is, if the relative mode is activated by an RL1 command, and then deactivated by an RLO command, the effect of RL2 is to restore the reference level that was saved in response to the RL1 command	
Example:	OUTPUT 713;AE RLO	! DISABLES THE RELATIVE MODE FOR SENSOR A
Example 2:	OUTPUT 713;BE RL1	! ENABLES THE RELATIVE MODE FOR SENSOR B ! SAVES THE CURRENT LEVEL AS A REFERENCE
Example 3:	OUTPUT 713; BE RL2	! REPLACE THE CURRENT REFERENCE LEVEL FOR SENSOR B ! WITH THE PREVIOUS LEVEL

3.19.11 Resolution



NOTE: These commands must be preceded by CH [n] EN command.

Commands which specify measurement resolution are based on the function code RE. The command format is:

Syntax:	RE [a] EN	
	RE indicates that resolution is being set	
	[a] indicates the resolution with four values allowed (0, 1, 2 and 3). These specify the number of digits to the right of the decimal point	
	A terminating suffix (EN) is required	
Example:	OUTPUT 713;RE 0 EN	! SETS THE DISPLAY RESOLUTION TO XX.
Example 2:	OUTPUT 713;RE 1 EN	! SETS THE DISPLAY RESOLUTION TO XX.X
Example 3:	OUTPUT 713;RE 2 EN	! SETS THE DISPLAY RESOLUTION TO XX.XX
Example 4:	OUTPUT 713;RE 3 EN	! SETS THE DISPLAY RESOLUTION TO XX.XXX

3.19.12 Sensor Selection

Six simple commands (consisting of one of six function codes) specify how the sensors are used:

Syntax:	[AP BP AR BR AD BD]	
Example:	OUTPUT 713;AP	! MEASURES SENSOR A
Example 2:	OUTPUT 713;BP	! MEASURES SENSOR B
Example 3:	OUTPUT 713;AR	! MEASURES A DIVIDED BY B
Example 4:	OUTPUT 713;BR	! MEASURES B DIVIDED BY A
Example 5:	OUTPUT 713;AD	! MEASURES A LESS B
Example 6:	OUTPUT 713;BD	! MEASURES B LESS A

These commands, like the prefixes AE and BE, are sensor-specific, and cause the 8650A to assume that subsequent commands are intended for the same sensor unless they specify otherwise. Also, these commands (like the MNO, CRO and PHO command) have the effect of disabling Min/Max monitoring, Crest Factor and Peak Hold.

Series 8650A Universal Power Meters

3.19.13 Status

3.19.13.1 Status Byte Message

The power meter responds to a Serial Poll Enable (SPE) bus command by sending an 8-bit byte when addressed to talk. If the instrument is holding the SRQ bus control line true (issuing the Require Service message), bit position 6 in the Status Byte and the bit representing the condition causing the Require Service message to be issued will both be true. The bits in the Status Byte are latched, but can be cleared by sending the Clear Status (CS) program code.

Table 3-16: Status Byte & Service Request Mask

Bit	Weight	Service Request Condition
7	128	Over/Under Limit
6	64	RQS bit Require Service
5	32	Event Status
4	16	MAV
3	8	Measurement or Cal Zero Error
2	4	Entry Error
1	2	Cal/Zero Complete
0	1	Data Ready

The condition indicated in Bits 1-5 must be enabled by the Service Request Mask to cause a Service Request Condition. The mask is set with the @1 program code followed by an 8-bit byte, or the *SRE program code followed by three ASCII characters. The value of the byte is determined by summing the weight of each bit to be checked (the three ASCII characters are the value of the byte in decimal). The RQS (bit 6) is true when any of the conditions of bits 1-5 are enabled and occur. Bits remain set until the Status Byte is cleared.

OUTPUT 713;CS	! CLEARS SRQ AND STATUS BYTE
or	
OUTPUT 713;*CLS	! CLEARS SRQ AND STATUS BYTE (488.2)
STATE = SPOLL(713)	! READS STATUS BYTE
or	
OUTPUT 713;*STB?	! ASKS FOR STATUS BYTE (488.2)
ENTER 713;STATE	! READS STATUS BYTE WITH 3 ASCII DIGIT NUMBERS
OUTPUT 713;@1;CHR\$(4)	! SETS SERVICE REQUEST MASK TO 4
or	
OUTPUT 713;*SRE004	! SETS SERVICE REQUEST MASK TO 4
OUTPUT 713;RV	! ASKS FOR SERVICE REQUEST MASK
or	
OUTPUT 713;*SRE?	! ASKS FOR SERVICE REQUEST MASK (488.2)

3.19.13.2 Event Status Register

The Event Status Register (ESR) is essentially a second status byte; it is an 8-bit byte, described in the table below. When a specified event occurs, the ESR bits are set true; they can be read by sending an *ESR? command. When the command is received, the 8650A responds by sending an ASCII 3 digit value (from 0 to 255) that describes the present state of the register. This ASCII value is arrived at by summing the weighted values of the transmitted bits.

The ESR bits consist of the following:

Power On	This bit will always be set.
Command Error	This bit is set when an improper GPIB code is sent to the instrument. The command WT would be considered a command error, for example.
Execution Error	When incorrect data is sent to the instrument, this bit will be set. For example, the command FR-1.0MZ would be considered an execution error.
Device Dependent Error	Errors 1 through 49 are measurement errors, and will set this bit true whenever they occur.

If an ESR bit is set true, this causes bit 5 of the Status Byte to be set only when a corresponding bit in the Event Status Enable Register is enabled. This register is similar to the Service Request Mask, in that it can be used to specify which bits in the ESR register will set bit 5 of the Status Byte.

The Event Status Enable Register is set by sending the program code *ESE, followed by an ASCII 3 digit value (the value is determined by summing the weights of the bits to be checked). To read the current setting of the Event Status Register, send the command *ESE?. The 8650A sends an ASCII 3 digit value that describes the current state of the register (the value is determined by summing the weights of the bits that are set).

Bit 7	Bit 6	Bit 5	Bit 4	Bit 3	Bit 2	Bit 1	Bit 0
Power On	0	Command Error	Execution Error	Device Dependent Error	0	0	0

3.19.13.3 Status Message

Example:	OUTPUT 713;SM	! ASKS FOR STATUS MESSAGE
Example 2:	ENTER 713;STATUSMESS\$! READS STATUS MESSAGE

Series 8650A Universal Power Meters

3.19.13.4 Status Message Output Format

The output format is as follows:

AAaaBBCCccDDddEFGHIJKLMNOP<CR><LF>

AA	Measurement Error Code
aa	Entry Error Code
BB	Operating Mode
CC	Sensor A Range
cc	Sensor B Range
DD	Sensor A Filter
dd	Sensor B Filter
E	Measurement Units
F	Active Entry Channel
G	Oscillator Status
H	REL Mode Status
I	Trigger Mode
J	Group Trigger Mode
K	Limits Checking Status
L	Limits Status
M	NA
N	Offset Status
O	Duty Cycle Units/Status
P	Measurement Units
<CR>	Carriage Return
<LF>	Line Feed

Each letter in the Status Message Output Format denotes a single ASCII character. See the list of codes in Tables 3-17 through 3-19 on the following pages for expanded definitions of the individual elements in this format.

Table 3-17: Error Code Returned in Position AA

Error Code	Message	Notes
00	All OK	
01	Cannot zero sensor A	Ensure no RF power to sensor A
02	Cannot zero sensor B	Ensure no RF power to sensor B
03	Sensor A not connected to Calibrator	Connect sensor A to Calibrator
04	Sensor B not connected to Calibrator	Connect sensor B to Calibrator
05	Cannot Cal Sensor A	Check sensor A connection to Calibrator; reference must be 1.00 mW
06	Cannot Cal sensor B	Check sensor B connection to Calibrator; reference must be 1.00 mW
21	Over limit	An over-limit condition has occurred
23	Under limit	An under-limit condition has occurred
26	Sensor A unable to synchronize burst average power measurements to a pulse stream	Check measurement setup and RF signal
27	Sensor B unable to synchronize burst average power measurements to a pulse stream	Check measurement setup and RF signal
31	No sensor on Channel A	Connect sensor A, or change channels if B is connected
32	No sensor on Channel B	Connect sensor B, or change channels if A is connected

Series 8650A Universal Power Meters

Table 3-18: Error Code Returned in Position aa

Error Code	Message	Notes
00	All OK	
50	Entered Cal Factor out of range	Enter value between 1.0% and 150.0%
51	Entered Offset out of range	Enter value between -99.999 dB and +99.999 dB
53	Entered average number out of range	Enter valid average number
54	Entered recall memory number out of range	Enter valid recall memory number between 0 and 20
55	Entered store memory number out of range	Enter valid store memory number between 1 and 20
60	Unable to set requested measurement mode or sensor measurement because sensor A is unattached or uncalibrated	This may be due to receipt of a MAP, PAP, BAP, DC1 or DY command
61	Same as Error 60 above, but for sensor B	
62	Unable to set up sensor A to perform a modulated measurement (MAP, PAP, or BAP), because the sensor is not a modulated sensor. OR: Unable to modify a BAP measurement because the sensor is not a modulated sensor	This may be set due to receipt of a MAP, BAP, DC1, DY, BSTE, BSPE or BTDP command
63	Same as Error 62, but for sensor B	
67	Unable to activate Peak Hold or Crest Factor features	This may be set due to receipt of a CR1 or PH1 command. Peak Hold and Crest Factor can be enabled only in MAP, PAP or BAP modes
68	Unable to initiate fast measurement collection mode	Verify using modulation sensor and measurement mode selections
70	Entered peak sensor A data error	Check entered data
71	Entered peak sensor B data error	Check entered data
72	Entered peak sensor A delay out of range	Check entered delay
73	Entered peak sensor B delay out of range	Check entered delay
74	Entered peak sensor A trigger out of range	Check entered trigger value
75	Entered peak sensor B trigger out of range	Check entered trigger value
76	Sensor EEPROM data entry has error	Check entry data
77	Sensor A does not exist	Check sensor A. This error code refers only to the EEPROM command
78	Sensor B does not exist	Check sensor B. This error code refers only to the EEPROM command
79	Measurement settling target for auto-average mode is out of range	Value must be 0.10% to 100.00%
81	Duty cycle out of range	Value must be between 0.001% and 99.999%
82	Frequency value out of range	Value must be between 0 Hz and 100 GHz
85	Resolution value out of range	Value must be between 0 and 3
90	GPIB data parameter error	Check, then enter with valid prefix
91	Invalid GPIB code	Check, then enter with correct code

Table 3-19: Other Codes in the Status Message

Position	Significance	Codes
BB	Operating Mode	00 = Sensor A 08 = Cal A 01 = Sensor B 09 = Cal B 02 = A/B 10 = Ext Cal A 03 = B/A 11 = Ext Cal B 04 = A-B 20 = Peak A delay 05 = B-A 21 = Peak B delay 06 = Zeroing A 07 = Zeroing B
CC & cc	Sensor A range & Sensor B range	Manual Range: 01 = 1 02 = 2 03 = 3 04 = 4 05 = 5 Auto Range: 11 = 1 12 = 2 13 = 3 14 = 4 15 = 5
DD & dd	Sensor A filter & Sensor B filter	Manual Filter: 00 = 0 01 = 1 02 = 2 03 = 3 04 = 4 05 = 5 06 = 6 07 = 7 08 = 8 09 = 9 Auto Filter: 10 = 0 11 = 1 12 = 2 13 = 3 14 = 4 15 = 5 16 = 6 17 = 7 18 = 8 19 = 9
E	Measurement Units	0 = Watts, 1 = dBm
F	Active Entry Channel	A = A, B = B
G	Calibrator Output Status	0 = Off, 1 = On
H	REL Mode Status	0 = Off, 1 = On
I	Trigger Mode	0 = Freerun, 1 = Hold
J	Group Trigger Mode	0 = GTO, 1 = GT1, 2 = GT2
K	Limits Checking Status	0 = Disabled, 1 = Enabled
L	Limits Status	0 = In limits 1 = Over high limit
M	NA	2 = Under low limit
N	Offset Status	0 = Off, 1 = On
O	Duty Cycle	0 = Off, 1 = On
P	Measurement Units	0 = Watts, 1 = dBm, 2 = %, 3 = dB

Series 8650A Universal Power Meters

3.19.14 Setup

These commands allow recalling stored configuration setups and to query the setups.

3.19.14.1 Query a Stored Setup

This command queries a setup configuration, where n is the stored setup ID# (1 to 20). Its response is used in conjunction with its set form. This command is used in conjunction with SETUP n to **download** setup raw data from the 8650A.

Syntax:	SETUP? n EN	
Example:	OUTPUT 713;SETUP? 12 EN	! QUERIES SETUP FROM ADDRESS 12



NOTE: The data returned from the SETUP? Command can exceed 1030 bytes. Variables should be dimensioned to accommodate the large string size.

3.19.14.2 Store a Setup

This command loads a stored setup configuration by address number. The number (n) is 1 to 20, and <data> is raw setup data. This command is used in conjunction with SETUP? to **upload** setup raw data to the 8650A.

Syntax:	SETUP n <data> n = 1 to 20 and <data> is raw setup data	
Example:	OUTPUT 713;SETUP 7 <DATA>	! STORES A SETUP TO ID# 7 OR ! LOADS (SETUP) DATA TO SETUP ID# 7

3.19.15 Store & Recall

The instrument's current configuration can be saved in a register for later recall.

3.19.15.1 Saving a Configuration

The commands for saving the instrument state are based on the ST function code:

Syntax:	ST [r] EN	
	ST is the Save function code	
	[r] identifies the register in which the instrument's configuration is to be saved (and from which it can later be retrieved). The value of [r] can be any number from 1 through 20	
	A terminating suffix (EN) is required	
Example:	OUTPUT 713;ST12EN	! SAVES THE CURRENT INSTRUMENT CONFIGURATION IN REGISTER 12



NOTE: Register 0 contains the previous state of the instrument; to recover from an accidental preset, recall the configuration from that register.

3.19.15.2 Retrieving a Configuration

The commands for recalling a configuration from a register are based on the RC function code:

Syntax:	RC [r] EN	
	RC is the Recall function code	
	[r] identifies the register in which the instrument's prior configuration has been saved and from which it is now to be retrieved. The value of [r] can be any number from 0 through 20	
	A terminating suffix (EN) is required	
Example:	OUTPUT 713;RC3EN	! RECALL THE CONFIGURATION THAT WAS SAVED IN REGISTER 3
Example 2:	OUTPUT 713;RC0EN	! RECALL THE PRIOR CONFIGURATION (THIS COMMAND RECOVERS ! FROM CONFIGURATION ERRORS)

Series 8650A Universal Power Meters

3.19.16 Units



NOTE: These commands must be preceded by CH [n] EN command.

Logarithmic or linear measurement units are specified by simple commands consisting of the function codes LG and LN.

Syntax:	LG or LN	
Example:	OUTPUT 713;LG	! SETS LOG UNITS (DB OR DBM)
Example 2:	OUTPUT 713;LN	! SETS LINEAR UNITS (WATTS OR %)

These commands affect all types of measurements, except for the fast measurement collection modes. These modes always return measurement readings in dBm.

3.19.17 $V_{PROP}F$ Feature

The $V_{PROP}F$ feature (Voltage Proportional to Frequency) provides a means of indicating to the 8650A the approximate frequency of the signal that it is measuring, so that the appropriate cal factor can be applied. The frequency is indicated by means of a variable voltage input. The 8650A reads the voltage as an expression of frequency, and applies the proper cal factor from the table stored in the sensor EEPROM (interpolating for frequencies that fall between the stored values).

In order for the 8650A to interpret the input voltage input correctly, it is necessary to specify the starting point (that is, the frequency at zero volts) and the slope (the rate at which voltage increases with frequency).

3.19.17.1 Enabling & Disabling $V_{PROP}F$

Commands related to the $V_{PROP}F$ function are based on the function code $V_{PROP}F$. The command format, for purposes of activating or deactivating the $V_{PROP}F$ feature, is as follows:

Syntax:	VPROPF [A or B] STATE [ON OFF]	
	[A or B] specifies Sensor A or Sensor B	
	STATE indicates that the $V_{PROP}F$ feature is being enabled or disabled	
	[ON OFF] enable or disable the $V_{PROP}F$ function	
Example:	OUTPUT 713;VPROPF A STATE ON	! ENABLES $V_{PROP}F$ FOR SENSOR A
Example 2:	OUTPUT 713;VPROPF B STATE OFF!	! DISABLES $V_{PROP}F$ FOR SENSOR B

3.19.17.2 Configuring $V_{PROP}F$

The command format, for purposes of configuring the $V_{PROP}F$ feature, is as follows:

Syntax:	<p>$V_{PROP}F$ [A or B] MODE [f] [s]</p> <hr/> <p>[A or B] specifies Sensor A and Sensor B</p> <p>MODE indicates that the $V_{PROP}F$ feature is being configured (that is, the start frequency and slope are being specified)</p> <p>[f] indicates the start frequency (the frequency at zero volts), expressed in Hz. The start frequency must be less than the upper frequency limit of the sensor</p> <p>[s] indicates the slope of the $V_{PROP}F$ (the ratio of input voltage to input frequency), expressed in V/Hz. The value must be between $1E-12$ and $1E-8$</p>	
Example:	<p>OUTPUT 713;VPROP F A MODE 2.00E9 1.00E-9</p>	<p>! CONFIGURES THE $V_{PROP}F$ FEATURE FOR SENSOR A ! AS FOLLOWS: ! 2.00 GHZ START FREQUENCY ! 1.00 VOLT PER GHZ SLOPE</p>

Series 8650A Universal Power Meters

3.19.18 Zeroing

The commands used for zeroing of a sensor are based on the function code ZE. The command format is:

Syntax:	[AE or BE] ZE	
	[AE or BE] prefix specifies Sensor A or Sensor B	
Example:	OUTPUT 713;AE ZE	! ZEROS SENSOR A
Example 2:	OUTPUT 713;BE ZE	! ZEROS SENSOR B



NOTE: If the sensor is attached to an RF source, the source must be turned off prior to zeroing. Zeroing before calibration is not necessary; zeroing of the sensor is part of the sensor calibration process.

The following is an example of how to zero a sensor with the GPIB program. The service request feature determines when the zero has completed; this results in the quickest zeroing routine.

```
Zero:                                ! zero routine
ON INTR 7 GOSUB Srq_interrupt        ! setup serial poll interrupt jump location
ENABLE INTR 7;2                      ! enable SRQ interrupts
OUTPUT 713;*SRE010                  ! set service request mask to 2
    OUTPUT 713;CS                   ! clear status byte
    OUTPUT 713;ZE                   ! start zero
Flag=0                                ! reset control flag
WHILE Flag=0                          ! wait while zeroing
END WHILE
RETURN
Srq_interrupt:                        ! SRQ interrupts jump here
OUTPUT 713;*STB?
ENTER 713;State
IF BIT(State, 1) THEN
    PRINT GOOD ZERO
ELSE
    IF BIT(State, 3) THEN
        PRINT BAD ZERO
    ENDIF
ENDIF
ENDIF
OUTPUT 713;CS                        ! clear status byte
Flag=1                                ! set control flag true
RETURN
```

3.19.19 Histograms, CDF & CCDF



NOTE: These commands must be preceded by CH [n] EN command.

These commands set up displays in graphical format for analyzing power measurements over a period of time. The displays are divided into Histograms, Cumulative Distribution Functions (CDF) and Complementary CDF, which are automatic functions of Histograms and displayed by pressing [Select Mode] from the respective menus.

3.19.19.1 Setting Histogram Mode Intervals

This command set the histogram interval. A value of 0 indicates no limits.

Syntax:	HIST INTERVAL <i>n</i> (<i>n</i> = 0 to 356400 seconds)	
Example:	OUTPUT 713;HIST INTERVAL 60	! SETS THE HISTOGRAM INTERVAL TO 60 SECONDS

3.19.19.2 Histogram Range

This command sets the histogram range, where M is minimum and N is maximum. If the histogram format is dBm, the range value is dBm; if the histogram format is linear, the range value is linear.

Syntax:	HIST RANGE M	
Example:	OUTPUT 713;HIST -20 -10	! SETS THE HISTOGRAM RANGE FROM -20 TO -10 DBM

3.19.19.3 Enabling & Disabling Histograms HIST

This command sets up or exits the histogram mode. Histograms can only be activated from normal measurement mode. Selecting sensor A or B or measurement line 1, 2, 3 or 4 depends on what was last set. If sensor was last selected, then the histogram will show the sensor level data. If the measurement line was last selected, the histogram will show the measurement line data.

Syntax:	[AE or BE] HIST [ON OFF]	
Example:	OUTPUT 713; AE HIST ON	! FOR SENSOR A, TURN ON THE HISTOGRAM ! DISPLAY (OR CDF OR CCDF IF EITHER WAS ! LAST DISPLAYED)
Example 2:	OUTPUT 713;HIST OFF	! TURNS OFF THE HISTOGRAM FUNCTION, ALSO THE CDF ! AND CCDF

Series 8650A Universal Power Meters

3.19.19.4 Histogram Query

This command queries the current Histogram.

Syntax:	HIST?	
Example:	OUTPUT 713;HIST?	! QUERIES THE CURRENT HISTOGRAM DATA
Example 2:	ENTER 713;HIST	! READS RESPONSE INTO VARIABLE HIST

Data response received from 8650A via GPIB is approx. 48K bytes in the format: -77.00, Value; -76.95, Value; ... 22.95, Value where Value is in scientific notation with 1.00 E00 = 100%. i.e., starts at -77 dBm incrementing by .05 dBm up to 22.95 dBm.

3.19.20 Strip Chart

The Strip Chart function allows viewing the varying power levels of a signal over a period of time.

3.19.20.1 Strip Pause/Resume

This command pauses and resumes the collection of strip chart data. There is no strip chart activation command.

Syntax:	STRIP [PAUSE or RESUME]	
Example:	OUTPUT 713;STRIP PAUSE	! PAUSES STRIP CHART DATA COLLECTION
Example 2:	OUTPUT 713;STRIP RESUME	! RESUMES STRIP CHART DATA COLLECTION

3.19.20.2 Strip Chart Query

This command queries the strip chart data.

Syntax:	STRIP?	
Example:	OUTPUT 713;STRIP?	! QUERIES THE STRIP CHART DATA
Example 2:	OUTPUT 713;STRIP	! READS RESPONSE INTO VARIABLE STRIP

Data response received from 8650A via GPIB is 200 readings in scientific notation using approximately 2.4K bytes.

Series 8650A Universal Power Meters

3.19.21 Statistics

The Statistics feature enables computation of mean and standard deviation over a period of time.

3.19.21.1 Statistics Enable/Disable



NOTE: These commands must be preceded by CH [n] EN command.

This command enables or disables the statistic function. The active GPIB measurement line is used as the input and display. Statistic can display only if active the GPIB measurement line is not showing a secondary measurement.

Syntax:	STAT ON/OFF	
Example:	OUTPUT 713;STAT ON	! ENABLES THE STATISTIC FUNCTION

3.19.21.2 Statistics Query

This command queries statistics data of the current active GPIB measurement line. Error measurement is returned if statistic is not active.

Syntax:	STAT?	
Example:	OUTPUT 713;STAT?	! QUERIES THE DATA IN THE STATISTIC FUNCTION

3.19.22 SCPI

This command modifies the active GPIB command set to SCPI from native (8600). Query from is not available for this command.

Syntax:	SCPI	
Example:	OUTPUT 713;SCPI	! SETS THE ACTIVE GPIB COMMAND SET TO SCPI MODE

Performance Verification

4.1 Introduction

This chapter defines procedures for performance verification of the Series 8650A Universal Power Meters. Refer to Appendix B of this publication for power sensor selection and calibration.

4.2 Equipment Required

Table 4-1 lists the equipment required for performance verification of the Series 8650A Power Meters.

Table 4-1: Required Equipment List

Description	Representative Model	Key Characteristics
CW Thermistor Power Meter	HP 432A	V_{RF} and V_{COMP} available externally
Thermistor Mount	HP 478A-H75	≤ 1.07 VSWR @ 50 MHz (30 dB return loss) Accuracy $\pm 0.5\%$ @ 50 MHz
Digital Voltmeter (DVM)	HP 34401A	$\pm 0.05\%$ accuracy & $1 \mu V$ resolution
Directional Coupler, 10 dB	Mini Circuits ZFDC-10-1 10 dB	≤ 1.15 SWR @ 50 MHz
Step Attenuator, 0 to 90 dB in 10 dB increments	Weinschel Model AC 118A-90-33	≤ 1.15 SWR @ 50 MHz ± 0.1 dB attenuation
RF Source (Signal Generator) (High Power)	Wavetek Model 2405 Option XP	+22 dBm @ 50 MHz
Low Pass Filter	Integrated Microwave Model 904 881	> 30 dB attenuation @ 100 MHz
GPIB Controller for IBM PC	AT-GPIB/TNT	With driver software
Frequency Counter	B+K Precision 1856B	≥ 1.5 GHz, 50 ppm, ≥ 6 digit resolution

4.3 Calibrator Verification Procedure

If any of the instrument performance characteristics are not within specifications, refer the problem to Giga-tronics Customer Service.

4.3.1 Calibrator Output Power Reference Level

This test determines if the Calibrator Output Power Reference Level given in this section is valid for an ambient temperature range between +5° C and +35° C (+41° F to +95° F).

The Calibrator Output power reference is factory adjusted to 1 mW $\pm 0.7\%$. To achieve this accuracy, Giga-tronics uses a precision measurement system with accuracy to $\pm 0.5\%$ (traceable to the NIST - formerly the NBS), and allows for a transfer error of $\pm 0.2\%$ for a total of $\pm 0.7\%$. If an equivalent measurement system is used for verification, the power reference oscillator output can be verified to 1 mW $\pm 1.9\%$ ($\pm 1.2\%$ accuracy, $\pm 0.5\%$ verification system error, $\pm 0.2\%$ transfer error, for a maximum error of $\pm 1.9\%$). To ensure maximum accuracy in verifying the Calibrator Output power reference, the following procedure provides step-by-step instructions for using specified test instruments of known capability. If equivalent test instruments are substituted, refer to the Key Characteristics section in Table 4-1.

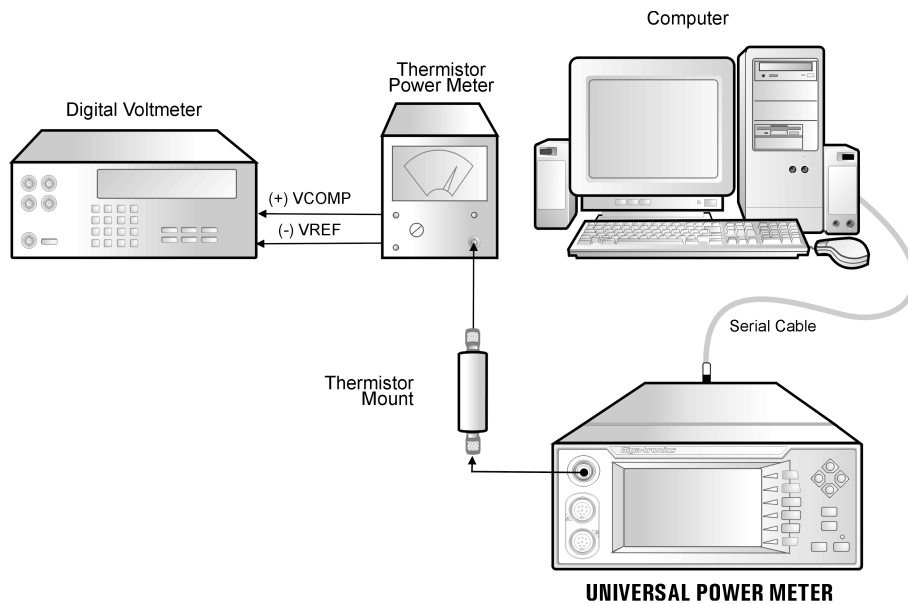

Figure 4-1: Calibrator Output Test Setup

4.3.1.1 Procedure

In the following steps, thermistor power measurements will be made using the 432A Power Meter. For detailed information on using the 432A, please refer to the operating section on the 432A manual.

1. Turn on the 8650A and the associated test equipment.
2. After 15 minutes, turn the 8650A's power OFF and ON. This establishes the 1mW reference for the instrument firmware.

3. Connect the Thermistor Mount to the 8650A Calibrator output “N” type connector as show in Figure 4-1. Allow a 15 minute thermal equilibrium period between the Thermistor and Calibrator connector to minimize temperature differences.
4. Set the 432A RANGE switch to COARSE ZERO, and adjust the front panel COARSE ZERO control to obtain a zero ($\pm 2\%$ F.S.) meter indication.



NOTE: Ensure that the DVM input leads are isolated from chassis ground when performing the next step.

5. Set the DVM to a range that results in a resolution of $1 \mu\text{V}$ and connect the positive and negative input, respectively, to the V_{COMP} and V_{RF} connectors on the rear panel of the 432A.
6. Fine zero the 432A on the most sensitive range, then set the 432A range switch to 1 mW.
7. Record the DVM indication as V_0 .
8. Turn ON the 8650A Calibrator RF power as follows:

Press [Meter Setup] [Calibrator] [Frequency], set to 50.0 MHz, press [ON] then [OK]. Record the reading shown on the DVM as V_1 .



NOTE: The V_1 reading must be taken within 15 seconds after pressing [OK]. Otherwise, turn the Calibrator OFF and repeat steps 7 and 8.

9. Disconnect the DVM negative lead from the V_{RF} connector on the 432A, and reconnect it to the 432A chassis ground. Record the new indication observed on the DVM as V_{COMP}
10. Repeat Step 7, except select OFF to turn the Calibrator off.
11. Calculate the Calibrator Output level (P_{CAL}) using the following formula:

$$P_{\text{CAL}}(\text{Watts}) = \frac{2V_{\text{COMP}} \left(\frac{V_1 \cdot V_0}{1 \cdot 0} + \frac{V_0^2 \cdot V_1^2}{0 \cdot 1} \right)}{4R (\text{Calibration Factor})}$$

where:

P_{CAL} = calibrator output power reference level
 V_{COMP} = previously recorded value in Step 8
 V_1 = previously recorded value in Step 7
 V_0 = previously recorded value in Step 6
 $R = 200\Omega$ (assuming HP478A-H75 mount)

Calibration factor = value for the thermistor mount at 50 MHz (traceable to the NIST)

12. Verify that the P_{CAL} is within the following limits:
1 mW ± 0.019 mW (0.981 to 1.019 mW)

For record purposes, the measured value of P_{CAL} can be entered on the Performance Verification Test Data Sheet on page 4-9.

13. For Option 12, set the calibrator frequency to 1.000 GHz as in step 8 and repeat steps 9 through 12.

4.3.2 Calibrator Frequency Check

To measure the frequency of the calibrator:

1. Connect the frequency counter to the calibrator output connector.
2. Turn ON the calibrator according to the procedure given in Procedure Step 8 on the previous page.
3. Measure 49 to 51 MHz.
4. Set the calibrator frequency to 1.000 GHz (with Option 12 only).
5. Measure 999.5 MHz to 1.0005 GHz (with Option 12 only).
6. Turn the calibrator OFF.

4.4 Performance Verification Tests

Information in this section is useful for periodic evaluation of the 8650A and its power sensors. These tests can also be used for incoming inspection testing when the instrument is first received, if required.

If the 8650A has not previously been used, review the precautions in Section 1.2.1 of the publication before the instrument is turned on. Prior to starting the following procedures, the instrument should be allowed to warm up for at least 24 hours to assure maximum stability during testing.

The instrument plus power sensor linearity test is valid when the sensor has been calibrated using the front panel calibrator at a temperature between 0° C and +50° C (+32° F to +122° F), and if operating within $\pm 5^{\circ}\text{C}$ ($\pm 9^{\circ}\text{F}$) of that calibration temperature.

It is recommended that the verification be done in the order described since some of the steps use the configuration from a previous step.

4.4.1 Equipment Required

See Table 4-1 for a list of the equipment required for performance testing of the 8650A power meters.

The Performance Verification Test Data Sheet located on page 4-9 through 4-10 can be copied for recording test results each time performance verification testing is performed on the specific instrument described by this publication.

Series 8650A Universal Power Meters

4.4.2 Instrument Plus Power Sensor Linearity

4.4.2.1 Test Description

Connect the test setup as shown in Figure 4-2. The linearity will be tested over the range +20 dBm to -60 dBm. At low power levels, the linearity measurement will include the uncertainty due to the zero set specification. The procedure should be repeated for each sensor used with the 8650A.

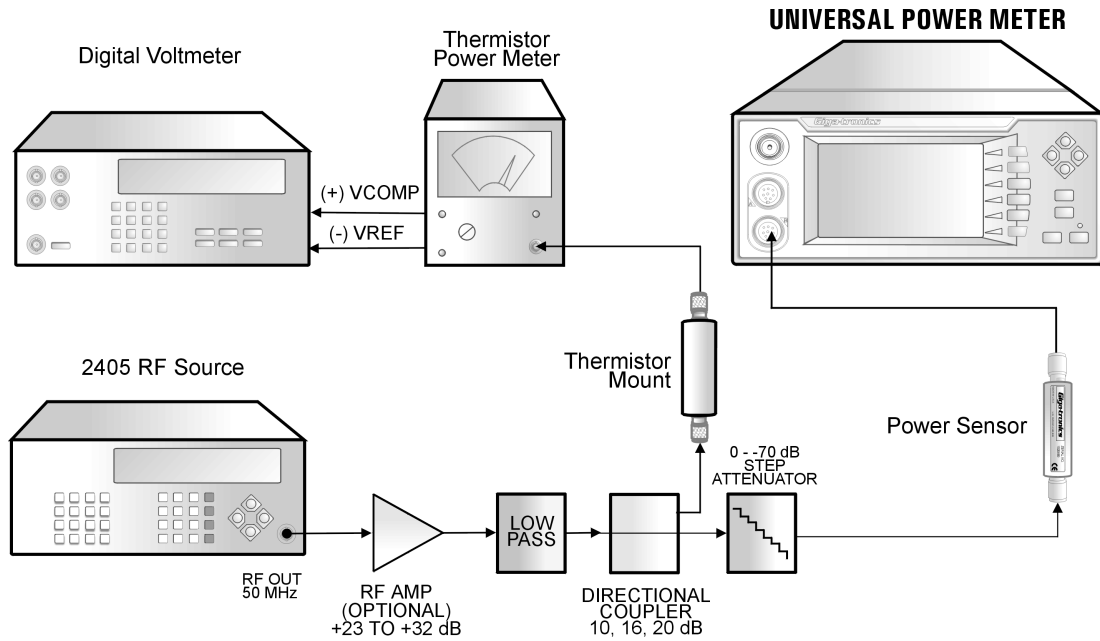

Figure 4-2: Power Linearity Test Setup

When measuring the linearity of a high power sensor, the power output of the source as well as the directional coupler coupling factor, must be increased. The power coefficient of the step attenuator will also have to be considered. The specification of power coefficient for the Weinschel attenuator cited in the Equipment List is: $<0.005 \text{ dB/dB/W}$. The latter will affect the linearity of each 10 dB segment, and make it necessary to expand the overall linearity specification by this quantity.

In assembling the test setup shown in Figure 4-2, keep in mind that if testing is to be conducted with Low VSWR or High Power sensors, the optional RF Amplifier must have frequency and bandwidth parameters to match the sensor's characteristics (See the Sensor Selection Guide in Chapter 1, if unsure of characteristics), and the Directional Coupler must be increased as stated above for the particular series of sensors. All Standard (Series 8030XA) and True RMS (Series 8033XA) sensors are tested with a 10 dB Directional Coupler and without the optional RF amplifier.

Refer to the Linearity Data recording section of the Performance Verification Data Sheets on pages 4-9 through 4-10. The tolerance is already entered for the various steps, and includes an allowance for specified zero set errors at low power levels.



NOTE: To ensure accurate and repeatable measurements, the 432A power meter should be zeroed just before taking each reading that will be used to calculate P1 in the Power Meter column of the Performance Verification Test Data Sheet on pages 4-9 through 4-10.

4.4.2.2 Setup Parameters

The following setup parameters should be accomplished prior to performing the Power Linearity test:

1. The 8650A and sensor should be calibrated (See Section 2.4.3. Refer also to the complete instructions on how to calibrate the sensor in Appendix B of this publication).
2. The Averaging is set to AUTO by entering the key sequence (See Figure D-2 to D-3):
[Sensor Setup] select Sensor A or B *[Avg]* set the number of Periods *[Averages]* *[Auto]*

4.4.2.3 Test Procedure

Extreme care is required in the following procedure since the accuracy requirements are critical to ensure the most accurate test results.

Power readings are determined using the thermistor power meter in the same general way as given in the Power Reference Level test. That is, P1 and P2 north Power Meter reading column of the Performance Verification Test Data Sheet tables are calculated each time for the respective values of V_{COMP} , V_0 , and V_1 read on the DVM.

1. Set the step attenuator to 70 dB. Turn the source power output off, and then zero the 8650A. (The 8650A is zeroed by pressing **[CAL/ZERO]** and then following the softkey label instructions.)
2. Set the step attenuator to 0 dB after the 8650A has zeroed.
3. Set the power output of the RF source so that the thermistor power meter indicates 1.00 mW ± 0.025 mW.
4. Record the calculated power meter reading and the displayed 8650A reading in the correct columns of the Linearity Data recording sheet on page 4-9.
5. Set the power output of the RF source so that the thermistor power meter indicates 3.98 mW ± 0.10 mW.
6. Record the new calculated power meter reading and the new displayed 8650A reading as in Step 4 above.
7. Set the power output of the RF Source so that the thermistor power meter indicates 5.01 mW ± 0.13 mW.
8. Record the new calculated power meter reading and the new displayed 8650A reading as in Step 4 above.
9. Repeat using the power meter indications in the Performance Verification Data Sheet on page 4-10. Note that the Step Attenuator is used to generate the remaining 70 dB range of 10 dB steps for a total range of 80 dB. Repeat Step 1, above, between each 10 dB step shown on the Linearity Data Recording sheet.
10. Make the calculations indicated on the Linearity Data sheet, and enter the values in the appropriate blank spaces.

4.4.3 GPIB Port Check

The following steps confirm that the GPIB port is functional:

1. Set the 8650A to the desired address (the default is 13; see Section 2.3.2 for instructions on how to set the GPIB mode and address).
2. Connect the GPIB controller to the GPIB Port on the rear of the 8650A.
3. Send the command (if emulating an HP 438):
*IDN? or ?ID

(*IDN? is the IEEE 488.2 Common ID query. When addressed to talk after receiving the command, the 8650A will output a string that identifies itself as 8651A or 8652A.)
4. Display the response on the controller.

This completes the performance verification test for the 8650A Universal Power Meters and its sensors. If the instrument has performed as described in this chapter, it is correctly calibrated and within specifications.

SERIES 8650A UNIVERSAL POWER METERS
Performance Verification Test Data Sheet (Page 1 of 2)

Date:	
Operator:	
Test Number (If Required):	
Series 8650A S/N:	
Power Sensor S/N:	

Calibrator Output Power Reference

Minimum	Actual Reading	Maximum
0.981 mW		1.019 mW

Linearity Data - (+16 dBm to +20 dBm)

Step Attenuator Value	Power Set Point	Power Meter Reading (P)	8650A (DUT) Reading (R)	Reference Power Ratio	8650A (DUT) Reading Ratio	Linearity Error (%) ¹	
						Linearity Specification	Accumulated Linearity Error ²
0 dB	1.00 mW ±0.025 mW	P1 =	R1 =	P1/P2 =	R1/R2 =	±1%	Same as Lin. error above
	3.98 mW ±0.10 mW	P2 =	R2 =				
0 dB	3.98 mW ±0.10 mW	P1 =	R1 =	P1/P2 =	R1/R2 =	+1% -1.6%	
	5.01 mW ±0.13 mW	P2 =	R2 =				
0 dB	5.01 mW ±0.13 mW	P1 =	R1 =	P1/P2 =	R1/R2 =	+1% -2.7%	
	6.31 mW ±0.16 mW	P2 =	R2 =				
0 dB	6.31 mW ±0.16 mW	P1 =	R1 =	P1/P2 =	R1/R2 =	+1% -3.8%	
	7.94 mW ±0.2 mW	P2 =	R2 =				
0 dB	7.94 mW ±0.2 mW	P1 =	R1 =	P1/P2 =	R1/R2 =	+1% -4.9%	
	10 mW ±0.25 mW	P2 =	R2 =				

(continued)

-60 dBm to +16 dBm Linearity Data are on the next page.

NOTES:

- Linearity Error (%) = [(R1/R2) / (P1/P2) - 1] x 100
- Accumulated error is the sum of the current dB segment linearity error plus the previous accumulated error.

SERIES 8650A UNIVERSAL POWER METERS

Performance Verification Test Data Sheet (Page 2 of 2)

Linearity Data - (-60 dBm to +16 dBm)

Step Attenuator Value	Power Set Point	Power Meter Reading (P)	8650A (DUT) Reading (R)	Reference Power Ratio	8650A (DUT) Reading Ratio	Linearity Error (%) ¹	
						Linearity Specification	Accumulated Linearity Error ²
0 dB						See Note 3	
						±1%	Same as Lin. error above
10 dB	1.00 mW ±0.025 mW	P1 =	R1 =	P1/P2 =	R1/R2 =		
	10.00 mW ±0.25 mW	P2 =	R2 =			±1%	
20 dB	1.00 mW ±0.025 mW	P1 =	R1 =	P1/P2 =	R1/R2 =		
	10.00 mW ±0.25 mW	P2 =	R2 =			±1%	
30 dB	1.00 mW ±0.025 mW	P1 =	R1 =	P1/P2 =	R1/R2 =		
	10.00 mW ±0.25 mW	P2 =	R2 =			±1%	
40 dB	1.00 mW ±0.025 mW	P1 =	R1 =	P1/P2 =	R1/R2 =		
	10.00 mW ±0.25 mW	P2 =	R2 =			±1%	
50 dB	1.00 mW ±0.025 mW	P1 =	R1 =	P1/P2 =	R1/R2 =		
	10.00 mW ±0.25 mW	P2 =	R2 =			±1%	
60 dB	1.00 mW ±0.025 mW	P1 =	R1 =	P1/P2 =	R1/R2 =		
	10.00 mW ±0.25 mW	P2 =	R2 =			±1.5%	
70 dB	1.00 mW ±0.025 mW	P1 =	R1 =	P1/P2 =	R1/R2 =		
	10.00 mW ±0.25 mW	P2 =	R2 =			±6%	

NOTES:

- Linearity Error (%) = $[(R1/R2) / (P1/P2) - 1] \times 100$
- Accumulated error is the sum of the current dB segment linearity error plus the previous accumulated error.
- Use the first CW Linearity error value entered in the +16 dBm to +20 dBm Linearity Data on page 4-9.

Typical Applications Programs

A.1 Introduction

This section provides examples of programs for controlling the Series 8650A remotely over the GPIB.

A.2 Continuous Data Reading

```

        OUTPUT 713;TR3           ! set freerun mode
Main:   ENTER 713;Reading       ! make reading
        PRINT Reading
        GO TO MAIN

```

A.3 Remote Calibration of a Sensor

```

        OUTPUT 713;PR           ! preset the instrument to a known state
        CH 1 EN                 ! selects line 1 for subsequent settings
        OUTPUT 713;LG           ! set Log units (dB or dBm)
        OUTPUT 713;AP           ! Measure sensor A
Main:   ! start of measurement loop
        OUTPUT 713;TR2         ! Trigger full measurement with settling
        ENTER 713;Reading      ! Read the data over the bus into variable N
        PRINT Reading
        GO TO Main
Calibrate ! calibration routine
        ON INTR 7 GOSUB Srq_interrupt ! setup serial poll interrupt jump location
        ENABLE INTR 7;2        ! enable SRQ interrupts
        OUTPUT 713;*SRE002     ! set service request mask to 2
        OUTPUT 713;CS          ! clear status byte
        OUTPUT 713;CLEN        ! start calibration
        Flag=0                 ! reset control flag
        WHILE Flag=0           ! wait while calibrating
        END WHILE
        RETURN
Srq_interrupt: ! SRQ interrupts jump here
        IF BIT(State, 1) THEN
            PRINT GOOD CAL
        ELSE
            IF BIT(State, #) THEN
                PRINT BAD CAL
            ENDIF
        ENDIF
        ENDIF
        OUTPUT 713;CS          ! clear status byte
        Flag=1                 ! set control flag true
        RETURN

```

A.4 Speed Tests: Normal & Swift

```
CSUB          PROG 494 RE-STORE WSPEED
11           ! SPEED TESTS FOR THE GIGA-TRONICS 8652A
12           ! 7/15/02
20           Giga-tronics=713
30           DIM A(100) ,B(100)
31           OUTPUT Giga-tronics;PR LG OC1
32           OUTPUT Giga-tronics;AE FM0 EN
34           OUTPUT Giga-tronics;DU GIGA-TRONICS 8652A SPEED TESTS
35           WAIT 1
36           OUTPUT Giga-tronics;DU UN-PLUG B SENSOR
37           PRINT
40           PRINT GIGA-TRONICS 8652A SPEED TESTS
60           PRINT CONNECT A SENSOR ONLY. NO B SENSOR
61           PRINT PRESS RETURN WHEN READY
70           INPUT A$
71           OUTPUT Giga-tronics;DE
80           !
90           PRINT
100          PRINT NORMAL TR3 TRIGGER MODE SINGLE CHANNEL
110          GOSUB Timeloop1
111          !
112          PRINT
113          PRINT NORMAL TR2 TRIGGER MODE SINGLE CHANNEL
114          GOSUB Timeloop4
120          !
130          OUTPUT Giga-tronics;SWIFT FREERUN
140          WAIT 1
150          PRINT
160          PRINT SWIFT MODE SINGLE CHANNEL
170          GOSUB Timeloop2
180          OUTPUT Giga-tronics;SWIFT OFF
181          !
190          PRINT
200          PRINT END OF SINGLE CHANNEL MODE
210          PRINT CONNECT B SENSOR FOR NEXT SET OF TESTS
211          PRINT PRESS RETURN WHEN READY
212          OUTPUT Giga-tronics;DU CONNECT B SENSOR
220          INPUT A$
221          OUTPUT Giga-tronics;DE
223          !
230          PRINT
240          PRINT NORMAL TR3 TRIGGER MODE TWO CHANNELS
250          GOSUB Timeloop3
251          !
260          PRINT
270          PRINT SWIFT MODE DUAL CHANNEL
280          OUTPUT Giga-tronics;SWIFT FREERUN
290          WAIT 1
300          GOSUB Timeloop2
310          PRINT
320          OUTPUT Giga-tronics;SWIFT OFF
330          PRINT END OF TESTS
```

```
340      STOP
350      !
360      Timeloop1:! SINGLE CHANNEL MEASUREMENTS
370          T1=TIMEDATE
380          FOR I=1 TO 100
390              ENTER Giga-tronics;A(I)
400          !   PRINT A(I)
410          NEXT I
420          T2=TIMEDATE
430          PRINT 100/(T2-T1);PER SECOND
440          !   FOR I=1 TO 100
450          !   PRINT A(I)
460          !   NEXT I
          [continued...]
470          !   PRINT
480          RETURN
490          !
500      Timeloop2:! TWO CHANNELS IN SWIFT MODE
510          T1=TIMEDATE
520          FOR I=1 TO 100
530              ENTER Giga-tronics;A(I),B(I)
540          NEXT I
550          T2=TIMEDATE
560          PRINT 100/(T2-T1);PER SECOND FOR BOTH CHANNELS
570          RETURN
580          !
590      Timeloop3:!
600          T1=TIMEDATE
610          FOR I=1 TO 100
620              OUTPUT Giga-tronics;AP
630              ENTER Giga-tronics;A(I)
640              OUTPUT Giga-tronics;BP
650              ENTER Giga-tronics;B(I)
660          NEXT I
670          T2=TIMEDATE
680          PRINT 100/(T2-T1);PER SECOND BOTH CHANNELS
690          OUTPUT Giga-tronics;AP
700          RETURN
701          !
702      Timeloop4:!
703          T1=TIMEDATE
704          FOR I=1 TO 100
705              OUTPUT Giga-tronics;TR2
706              ENTER Giga-tronics;A(I)
709          NEXT I
710          T2=TIMEDATE
711          PRINT 100/(T2-T1);PER SECOND SINGLE CHANNEL
712          OUTPUT Giga-tronics;TR3
713          RETURN
714          END
```

A.5 Swift Demo 1: FREERUN

```
10          ! RE-STORE SWIFT
20          !
30          ! DEMO PROGRAM FOR 8650A SWIFT MODE
40          !
50          ! 7/15/02
60          !
70          Giga-tronics=713
80          N=100
90          OPTION BASE 1
110         REAL Nums(100)
120         OUTPUT Giga-tronics;PR LG
130         OUTPUT Giga-tronics;SWIFT FREERUN
140         WAIT .5
145         WINDOW 1 ,N,-70,20
150         Mainloop
151         FOR I=1 TO N
170         ENTER Giga-tronics;Nums(I)
180         NEXT I
190         GCLEAR
200         PEN 2
210         GRID 10,10
220         PEN 1
230         MOVE 1 ,Nums(I)
240         FOR I=1 TO N
250             DRAW I ,Nums (I)
260         NEXT I
270         GOTO Mainloop
280         OUTPUT Giga-tronics;SWIFT OFF
300         END
```

A.6 Swift Demo 2: GET

```
10      ! RE-STORE SWIFT
20      ! DEMO PROGRAM FOR 8650A SWIFT MODE
40      !
50      ! 7/15/02
60      !
70      Giga-tronics=713
80      N=100
90      OPTION BASE 1
110     REAL Nums(100)
120     OUTPUT Giga-tronics;PR LG
130     OUTPUT Giga-tronics;SWIFT GET;N
140     WAIT .5
145     WINDOW 1,N-70,20
150     Mainloop
151     FOR I=1 TO N
160     TRIGGER Giga-tronics
161     NEXT I
170     ENTER Giga-tronics;Nums(*)
190     GCLEAR
200     PEN 2
210     GRID 10,10
220     PEN 1
230     MOVE 1,Nums(1)
240     FOR I=1 TO N
250     DRAW I,Nums(I)
260     NEXT I
270     GOTO Mainloop
280     OUTPUT Giga-tronics;SWIFT OFF
300     END
```

A.7 Fast Buffered Demo: POST GET

```
10      ! RE-STORE FAST BUFFERED
20      !
30      ! DEMO PROGRAM FOR 8650A FAST BUFFERED MODE
40      !
50      ! 7/15/02
60      !
70      Giga-tronics=713
80      N=100
90      OPTION BASE 1
110     REAL Nums(100)
120     OUTPUT Giga-tronics;PR LG
130     OUTPUT Giga-tronics;FBUF POST GET BUFFER;N
140     WAIT .5
145     WINDOW 1,N,-70,20
150     Mainloop
152     Wait .05
160     TRIGGER Giga-tronics
170     ENTER Giga-tronics;Nums(*)
190     GCLEAR
200     PEN 2
210     GRID 10,10
220     PEN 1
230     MOVE 1,Nums(1)
240     FOR I=1 TO N
250         DRAW I,Nums(I)
260     NEXT I
270     GOTO Mainloop
280     OUTPUT Giga-tronics;FBUF OFF
300     END
```

A.7.1 Fast Buffered Demo: POST TTL

```
10      ! RE-STORE FAST BUFFERED
20      !
30      ! DEMO PROGRAM FOR 8650A FAST BUFFERED MODE WITH TTL TRIGGER
40      !
50      ! 7/15/02
60      !
70      Giga-tronics=713
80      N=200
90      OPTION BASE 1
110     REAL Nums(200)
120     OUTPUT Giga-tronics;PR LG
130     OUTPUT Giga-tronics;FBUF POST TTL BUFFER;N
140     WAIT .5
145     WINDOW 1,N,-70,20
150     Mainloop
170     ENTER Giga-tronics;Nums(*)! waits here until TTL trigger happens
190     GCLEAR
200     PEN 2
210     GRID N/10,10
220     PEN 1
230     MOVE 1,Nums(1)
240     FOR I=1 TO N
250         DRAW I,Nums(I)
260     NEXT I
270     GOTO Mainloop
300     END
```

Series 8650A Universal Power Meters

Power Sensors

B.1 Introduction

This appendix contains the selection, specifications and calibration data for the Giga-tronics power sensors used with the Series 8650A Universal Power Meters. This appendix is divided into the following sections:

- Power Sensor Selection
- Modulated Sensor Specifications
- Peak Power Sensor Selection
- Directional Bridges
- Remote Calibration of Sensors

All Giga-tronics power sensors contain balanced zero-biased Schottky diodes for power sensing.

CAUTION

Input power in excess of +23 dBm (200 mW, which is the 100% average for standard and pulse sensors) can degrade or destroy these diodes. Diodes degraded or destroyed in this manner will not be replaced under warranty. Destructive signal levels are higher for high power, true rms, and low VSWR sensors. When connecting power sensors to other devices, do not turn the body of the sensor in order to tighten the RF connection. This can damage the connector mating surfaces.

B.2 Power Sensor Selection

Standard sensors include the 80300A series for CW signals, the 80350A series for Peak or CW power, the 80400A, 80600A and 80700A series for modulated and CW signals, the 80500 series CW Return Loss Bridges, and the 80330A series True RMS sensors.

Giga-tronics True RMS sensors are recommended for applications such as measuring quadrature modulated signals, multi-tone receiver intermodulation distortion power, noise power, or the compression power of an amplifier. These sensors include a pad to attenuate the signal to the RMS region of the diode's response. This corresponds to the -70 dBm to -20 dBm linear operating region of Standard CW Sensors. The pad improves the input VSWR to ≤ 1.15 at 18 GHz.

High Power (1, 5, 25 and 50 Watt) and Low VSWR sensors are also available for use with the 8650A Power Meters. Table B-1 lists the Giga-tronics power sensors used with the 8650A. Refer to applicable notes on page B-6. See Figures B-1 or B-2 for modulation-induced measurement uncertainty.

Series 8650A Universal Power Meters

B.2.1 Power Sensor Selection Charts

Table B-1: Power Sensor Selection Guide

CW Power Sensors								
Model	Freq. Range/ Power Range	Max. Power	Power Linearity ⁴ (Freq > 8 GHz)	RF Conn	Length	Dia.	Wgt.	VSWR
200 mW Peak Power Sensors								
80301A	10 MHz to 18 GHz -70 to +20 dBm	+23 dBm (200 mW)	-70 to -20 dBm ±0.00 dB -20 to +20 dBm ±0.05 dB/10 dB	Type N(m) 50Ω	114.5 mm (4.5 in)	32 mm (1.25 in)	0.18 kg (0.4 lb)	1.12:0.01 - 2 GHz 1.22:2 - 12.4 GHz 1.29:12.4 - 18 GHz
80302A	10 MHz to 18 GHz -70 to +20 dBm	+23 dBm (200 mW)	-70 to -20 dBm ±0.00 dB -20 to +20 dBm ±0.05 dB/10 dB	APC-7 50Ω				
80303A	10 MHz to 26.5 GHz -70 to +20 dBm	+23 dBm (200 mW)	-70 to +20 dBm ±0.00 dB -20 to +20 dBm ±0.1 dB/10dB	Type K(m) ¹ 50Ω	114.5 mm (4.5 in)	32 mm (1.25 in)	0.18 kg (0.4 lb)	1.12:0.01 - 2 GHz 1.22:2 - 12.4 GHz 1.38:12.4 - 18 GHz 1.43:18 - 26.5 GHz 1.92:26.5 - 40 GHz
80304A	10 MHz to 40 GHz -70 to 0 dBm	+23 dBm (200 mW)	-70 to -20 dBm ±0.00 dB -20 to 0 dBm ±0.2 dB/10 dB					
Low VSWR CW Power Sensors								
80310A	10 MHz to 18 GHz -64 to +26 dBm	+29 dBm (800 mW)	-64 to -14 dBm ±0.00 dB -14 to +26 dBm ±0.05 dB/10 dB	Type K(m) ¹ 50Ω	127mm (5.0 in)	32 mm (1.25 in)	0.23 kg (0.5lb)	1.13:0.01 - 2 GHz 1.15:2 - 12 GHz 1.23:12 - 18 GHz 1.29:18 - 26.5 GHz 1.50:26.5 - 40 GHz
80313A	10 MHz to 26.5 GHz -64 to +26 dBm	+29 dBm (800 mW)	-64 to -14 dBm ±0.00 dB -14 to +26 dBm ±0.1 dB/10 dB					
80314A	10 MHz to 40 GHz -64 to +6 dBm	+29 dBm (800 mW)	-64 to -14 dBm ±0.00 dB -14 to +6 dBm ±0.2 dB/10 dB					
1W CW Power Sensors								
80320A	10 MHz to 18 GHz -60 to +30 dBm	+30 dBm (1 W)	-60 to -10 dBm ±0.00 dB -10 to +30 dBm ±0.05 dB/10 dB	Type K(m) ¹ 50Ω	127 mm (5.0 in)	32 mm (1.25 in)	0.23 kg (0.5 lb)	1.11:0.01 - 2 GHz 1.12:2 - 12 GHz 1.18:12 - 18 GHz 1.22:18 - 26.5 GHz 1.36:26.5 - 40 GHz
80323A	10 MHz to 26.5 GHz -60 to +30 dBm	+30 dBm (1 W)	-60 to -10 dBm ±0.00 dB -10 to +30 dBm ±0.1 dB/10 dB					
80324A	10 MHz to 40 GHz -60 to +10 dBm	+30 dBm (1 W)	-60 to -10 dBm ±0.00 dB -10 to +10 dBm ±0.2 dB/10 dB					
5W CW Sensor²								
80321A	10 MHz to 18 GHz -50 to +37 dBm	+37 dBm (5 W)	-50 to +0 dBm ±0.00 dB 0 to +37 dBm ±0.05 dB/10 dB	Type N(m) 50Ω	150 mm (5.9 in)	32 mm (1.25 in)	0.23 kg (0.5 lb)	1.20:0.01 - 2 GHz 1.25:6 - 12.4 GHz 1.35:12.4 - 18 GHz
25W CW Sensor³								
80322A	10 MHz to 18 GHz -40 to +44 dBm	+44 dBm (25 W)	-40 to +10 dBm ±0.00 dB +10 to +44 dBm ±0.05 dB/10 dB	Type N(m) 50Ω	230 mm (9.0 in)	104 mm (4.1 in)	0.3 kg (0.6 lb)	1.20:0.01 - 2 GHz 1.30:6 - 12.4 GHz 1.40:12.4 - 18 GHz
50W CW Sensor³								
80325A	10 MHz to 18 GHz -40 to +47 dBm	+47 dBm (50 W)	-40 to +10 dBm ±0.00 dB +10 to +47 dBm ±0.05 dB/10 dB	Type N(m) 50Ω	230mm (9.0 in)	104 mm (4.1 in)	0.3 kg (0.6 lb)	1.25:0.01 - 2 GHz 1.35:6 - 12.4 GHz 1.45:12.4 - 18 GHz

Peak Power Sensors								
Model	Freq. Range/ Power Range	Max. Power	Power Linearity ⁴ (Freq > 8 GHz)	RF Conn	Length	Dia.	Wgt.	VSWR
200 mW Peak Power Sensors								
80350A	45 MHz to 18 GHz -20 to +20 dBm, Peak -30 to +20 dBm, CW	+23 dBm (200 mW) CW or Peak	-30 to -20 dBm ±0.00 dB -20 to +20 dBm ±0.05 dB/ 10 dB	Type N(m) 50Ω	165 mm (6.5 in)	37 mm 1.25 in)	0.3 kg (0.7 lb)	1.12:0.045 - 2 GHz 1.22:2 - 12.4 GHz 1.37:12.4 - 18 GHz 1.50:18 - 26.5 GHz 1.92:26.5 - 40 GHz
80353A	45 MHz to 26.5 GHz -20 to +20 dBm, Peak -30 to +20 dBm, CW	+23 dBm (200 mW) CW or Peak	-30 to -20 dBm ±0.00 dB -20 to +20 dBm ±0.1 dB/10 dB	Type K(m) ¹ 50Ω	165 mm (6.5 in)	37 mm 1.25 in)	0.3 kg (0.7 lb)	
80354A	45 MHz to 40 GHz -20 to +0.0 dBm, Peak -30 to +0.0 dBm, CW	+23 dBm (200 mW) CW or Peak	-30 to -20 dBm ±0.00 dB -20 to 0.0 dBm ±0.2 dB/10dB	Type K(m) ¹ 50Ω	165 mm (6.5 in)	37 mm 1.25 in)	0.3 kg (0.7 lb)	
5W Peak Power Sensor^{5,7}								
80351A	45 MHz to 18 GHz 0.0 to +40 dBm, Peak -10 to +37 dBm, CW	CW: +37 dBm (5 W Avg.) Peak: +43 dBm	-10 to +0 dBm ±0.00 dB +0 to +40 dBm ±0.05 dB/ 10 dB	Type N(m) 50Ω	200 mm (7.9 in)	37 mm (1.25 in)	0.3 kg (0.7 lb)	1.15:0.045 - 4 GHz 1.25:4 - 12.4 GHz 1.35:12.4 - 18 GHz
25W Peak Power Sensor^{6,7}								
80352A	45 MHz to 18 GHz +10 to +50 dBm, Peak 0.0 to +44 dBm, CW	CW: +44 dBm (25 W Avg.) Peak: +53 dBm	0.0 to +10 dBm ±0.00 dB +10 to +50 dBm ±0.05 dB/ 10 dB	Type N(m) 50Ω	280 mm (11.0 in)	104 mm (4.1 in)	0.3 kg (0.7 lb)	1.20:0.045 - 6 GHz 1.30:6 - 12.4 GHz 1.40:12.4 - 18 GHz
50W Peak Power Sensor^{6,7}								
80355A	45 MHz to 18 GHz +10 to +50 dBm, Peak 0.0 to +47 dBm, CW	CW: +47 dBm (50 W Avg.) Peak: +53 dBm	0.0 to +10 dBm ±0.00 dB +10 to +50 dBm ±0.05 dB/ 10 dB	Type N(m) 50Ω	280 mm (11.0 in)	104 mm (4.1 in)	0.3 kg (0.7 lb)	1.25:0.045 - 6 GHz 1.35:6 - 12.4 GHz 1.45:12.4 - 18 GHz

See NOTES on page B-6

Bridge Selection Guide								
Model	Freq. Range/ Power Range	Max. Power	Power Linearity ⁴ (Frequency > 8 GHz)	Input	Test Port	Direct- tivity	Wgt.	VSWR
Precision CW Return Loss Bridges								
80501	10 MHz to 18 GHz -35 to +20 dBm	+27 dBm (0.5W)	-35 to +10 dBm ±0.1 dB +10 to +20 dBm ±0.1 dB ±0.005 dB/dB	Type N(f) 50 Ω	Type N(f) 50 Ω	38 dB	0.340 kg	< 1.17:0.01 - 8 GHz < 1.27:8 - 18 GHz
80502	10 MHz to 18 GHz -35 to +20 dBm	+27 dBm (0.5 W)	-35 to +10 dBm ±0.1 dB +10 to +20 dBm ±0.1 dB ±0.005 dB/dB	Type N(f) 50 Ω	APC-7(f) 50 Ω	40 dB	0.340 kg	< 1.13:0.01 - 8 GHz < 1.22:8 - 18 GHz
80503	10 MHz to 26.5 GHz -35 to +20 dBm	+27 dBm (0.5 W)	-35 to +10 dBm ±0.1 dB +10 to +20 dBm ±0.1 dB ±0.005 dB/dB	SMA(f) 50 Ω	SMA(f) 50 Ω	35 dB	0.340 kg	< 1.22:0.01 - 18 GHz < 1.27:8 - 26.5 GHz
80504	10 MHz to 40 GHz -35 to +20 dBm	+27 dBm (0.5 W)	-35 to +10 dBm ±0.1 dB +10 to +20 dBm ±0.1 dB ±0.005 dB/dB	Type K(f) 50 Ω	Type K(f) 50 Ω	30 dB	0.198 kg	< 1.35:0.01 - 26.5 GHz < 1.44:26.5 - 40 GHz

Series 8650A Universal Power Meters

Modulation Power Sensors ($f_m \leq 40$ KHz)								
Model	Freq. Range/ Power Range	Max. Power	Power Linearity ⁴ (Freq > 8 GHz)	RF Conn	Length	Dia.	Wgt.	VSWR
200 mW Modulation Power Sensors								
80401A	10 MHz to 18 GHz -67 to +20 dBm	+23 dBm (200 mW)	-67 to -20 dBm ± 0.00 dB -20 to +20 dBm: ± 0.05 dB/10 dB	Type N(m) 50 Ω	114.5mm (4.5 in)	32 mm (1.25 in)	0.18 kg (0.4 lb)	1.12:0.01 - 2 GHz 1.22:2 - 12.4 GHz 1.29:12.4 - 18 GHz
80402A	10 MHz to 18 GHz -67 to +20 dBm	+23 dBm (200 mW)	-67 to -20 dBm ± 0.00 dB -20 to +20 dBm: ± 0.05 dB/10 dB	APC-7 50 Ω				
Low VSWR Modulation Power Sensors								
80410A	10 MHz to 18 GHz -64 to +26 dBm	+29 dBm (800 mW)	-64 to -14 dBm ± 0.00 dB -14 to +26 dBm ± 0.05 dB/10 dB	Type K(m) ¹ 50 Ω	127 mm (5.0 in)	32 mm (1.25 in)	0.23 kg (0.5 lb)	1.13:0.01 - 2 GHz 1.16:2 - 12 GHz 1.23:12 - 18 GHz
1 W Modulation Power Sensors								
80420A	10 MHz to 18 GHz -57 to +30 dBm	+30 dBm (1 W)	-57 to -10 dBm ± 0.00 dB -10 to +30 dBm ± 0.05 dB/10 dB	Type K(m) ¹ 50 Ω	127 mm (5.0 in)	32 mm (1.25 in)	0.23 kg (0.5 lb)	1.11:0.01 - 2 GHz 1.12:2 - 12 GHz 1.18:12 - 18 GHz
5 W Modulation Power Sensors²								
80421A	10 MHz to 18 GHz -47 to +37 dBm	+37 dBm (5 W)	-47 to +0 dBm ± 0.00 dB 0 to +37 dBm ± 0.05 dB/10 dB	Type N(m) 50 Ω	150 mm (5.9 in)	32 mm (1.25 in)	0.23 kg (0.5 lb)	1.20:0.011 - 6 GHz 1.25:6 - 12.4 GHz 1.35:12.4 - 18 GHz
25 W Modulation Power Sensors³								
80422A	10 MHz to 18 GHz -37 to +44 dBm	+44 dBm (25 W)	-37 to +10 dBm ± 0.00 dB +10 to +44 dBm ± 0.05 dB/10 dB	Type N(m) 50 Ω	230 mm (9.0 in)	104 mm (4.1 in)	0.3 kg (0.6 lb)	1.20:0.01 - 6 GHz 1.30:6 - 12.4 GHz 1.40:12.4 - 18 GHz
50 W Modulation Power Sensors³								
80425A	10 MHz to 18 GHz -34 to +47 dBm	+47 dBm (50 W)	-34 to +10 dBm ± 0.00 dB +10 to +47 dBm ± 0.05 dB/10 dB	Type N(m) 50 Ω	230 mm (9.0 in)	104 mm (4.1 in)	0.3 kg (0.6 lb)	1.25:0.01 - 6 GHz 1.35:6 - 12.4 GHz 1.45:12.4 - 18 GHz

See NOTES on page B-6

Modulation Power Sensors ($f_m \leq 1.5$ MHz)

Model	Freq. Range/ Power Range	Max. Power	Power Linearity ⁴ (Freq > 8 GHz)	RF Conn	Length	Dia.	Wgt.	VSWR
200 mW Modulation Power Sensor								
80601A ⁹	10 MHz to 18 GHz -67 to +20 dBm	+23 dBm (200 mW)	-67 to -20 dBm ± 0.00 dB -20 to +20 dBm ± 0.05 dB/10 dB	Type N(m) 50 Ω	137 mm (5.39 in)	41 mm (1.62 in)	0.23 kg (0.4 lb)	1.12:0.01 - 2 GHz 1.22:2 - 12.4 GHz 1:29:12.4 - 18 GHz
5 W Modulation Power Sensor^{5,7}								
80621A	10 MHz to 18 GHz -47 to +37 dBm	+37 dBm (5 W)	-47 to 0 dBm ± 0.00 dB 0 to +37 dBm ± 0.05 dB/10 dB	Type N(m) 50 Ω	175 mm (6.90 in)	41 mm (1.62 in)	0.23 kg (0.6 lb)	1.20:0.01 - 6 GHz 1.25:6 - 12.4 GHz 1:35:12.4 - 18 GHz

Modulation Power Sensors ($f_m \leq 10$ MHz)

Model	Freq. Range/ Power Range	Max. Power	Power Linearity ⁴ (Freq > 8 GHz)	RF Conn	Length	Dia.	Wgt.	VSWR
80701A ¹⁰	50 MHz to 18 GHz -64 TO +20 dBm, CW 250 MHz to 18 GHz -60 to +20 dBm, Mod.	+23 dBm (200 mW)	Frequency > 8 GHz: -60 to +20 dBm: ± 0.00 dB -20 to +20 dBm: ± 0.05 dB/10 dB Frequency < 500 MHz: -60 to +20 dBm: ± 0.00 dB -20 to +20 dBm: ± 0.05 dB/10 dB	Type N(m) 50 Ω	120 mm (4.72 in)	27 mm (1.06 in)	0.10 kg (0.2 lb)	1.12:0.01 - 2 GHz 1.22:2.0 - 12.4 GHz 1.29:12.4 - 18 GHz

True RMS Sensors ($f_m > 1.5$ MHz) (-30 to +20 dBm)

Model	Freq. Range/ Power Range	Max. Power	Power Linearity ⁴ (Freq > 8 GHz)	RF Conn	Length	Dia.	Wgt.	VSWR
80330A 80333A 80334A	10 MHz to 18 GHz 10 MHz to 26.5 GHz 10 MHz to 40 GHz	+33 dBm (2 W)	-30 to +20 dBm ± 0.00 dB	Type K(m) ¹ 50 Ω	152.5 mm (6.0 in)	32 mm 1.25 in	0.27 kg (0.6 lb)	1.12:0.01 - 12 GHz 1.15:12 - 18 GHz 1.18:18 - 26.5 GHz 1.29:26.5 - 40 GHz

See Notes on page B-6

Series 8650A Universal Power Meters

Table B-2: Power Sensor Cal Factor Uncertainties

Freq. (GHz)		Root Sum of Squares (RSS) Uncertainties (%) ⁸						
Lower	Upper	80301A 80302A 80350A 80401A 80402A 80601A 80701A ¹⁰	80303A 80304A 80353A 80354A	80310A 80313A 80314A 80410A	80320A 80323A 80324A 80420A	80321A ⁹ 80322A ⁹ 80325A ⁹ 80421A ⁹ 80422A ⁹ 80425A ⁹ 80621A ⁹	80330A 80333A 80334A	80351A ⁹ 80352A ⁹ 80355A ⁹
Min	1	1.04	1.64	1.58	1.58	4.54	1.58	4.92
1	2	1.20	1.73	1.73	1.73	4.67	1.73	5.04
2	4	1.33	1.93	1.91	1.91	4.89	1.90	7.09
3	6	1.41	2.03	2.02	2.01	5.01	2.01	7.17
6	8	1.52	2.08	2.07	2.06	5.12	2.06	7.25
8	12.4	1.92	2.55	2.54	2.53	5.56	2.53	7.56
12.4	18	2.11	2.83	2.80	2.79	5.89	2.78	12.37
18	26.5	---	3.63	3.68	3.62	---	3.59	---
26.5	40	---	6.05	5.54	5.39	---	5.30	---

Notes:

1. The K connector is electrically and mechanically compatible with the APC-3.5 and SMA connectors. Use a Type N(m) to SMA(f) adapter (P/N 29835) for calibration of power sensors with Type K(m) connectors.
2. Power coefficient equals <0.01 dB/Watt.
3. Power coefficient equals <0.015 dB/Watt.
4. For frequencies above 8 GHz, add power linearity to system linearity.
5. Power coefficient equals <0.01 dB/Watt (Average).
6. Power coefficient equals <0.015 dB/Watt (Average).
7. Peak operating range above CW maximum range is limited to <10% duty cycle.
8. Square root of sum of the individual uncertainties squared (RSS).
9. Cal Factor numbers allow for 3% repeatability when connecting attenuator to sensor, and 3% for attenuator measurement uncertainty and mismatch of sensor/pad combination.
10. Series 807XXA sensors require the installation of Option 12 for use.

B.2.2 Modulated Sensor Specifications

Table B-3 lists the specifications for Series 80401A, 80601A and 80701A modulation sensors. Series 80701A sensors require the installation of Option 12.

Table B-3: Modulated Sensor Specifications

Sensor Measurement Capabilities			
Signal Type	Sensor Model		
	80401A	80601A	80701A
CW Power Level	-67 to +20 dBm	-67 to +20 dBm	-64 to +20 dBm
Amplitude Modulation Rate, Power Range	$f_m \leq 40$ kHz, -60 to +20 dBm $f_m > 40$ kHz, -60 to -20 dBm	$f_m \leq 1.5$ MHz, -60 to +20 dBm $f_m > 1.5$ MHz, -60 to -20 dBm	$f_m \leq 10$ MHz, -60 to +20 dBm
Two-Tone Maximum Separation between Carriers	≤ 40 kHz, -60 to +20 dBm > 40 kHz, -60 to -20 dBm	≤ 1.5 MHz, -60 to +20 dBm > 1.5 MHz, -60 to -20 dBm	≤ 10 MHz, -60 to +20 dBm > 10 MHz, -60 to -20 dBm
Pulse Modulation	> 200 μ s Pulse Width	> 300 μ s Pulse Width	> 100 μ s Pulse Width
Burst with Modulation	$f_m \leq 40$ kHz, > 200 μ s Pulse width; -40 to +20 dBm $f_m > 40$ kHz, > 200 μ s Pulse width; -40 to -20 dBm	$f_m \leq 1.5$ MHz, > 300 μ s Pulse width; -40 to +20 dBm $f_m > 1.5$ MHz, > 300 μ s Pulse width; -40 to -20 dBm	$f_m \leq 10$ MHz, > 100 μ s Pulse width; -30 to +20 dBm $f_m > 10$ MHz, > 200 μ s Pulse width; -30 to -20 dBm

f_m = modulation rate

Modulation-Induced Measurement Uncertainty for the 80401A Sensor

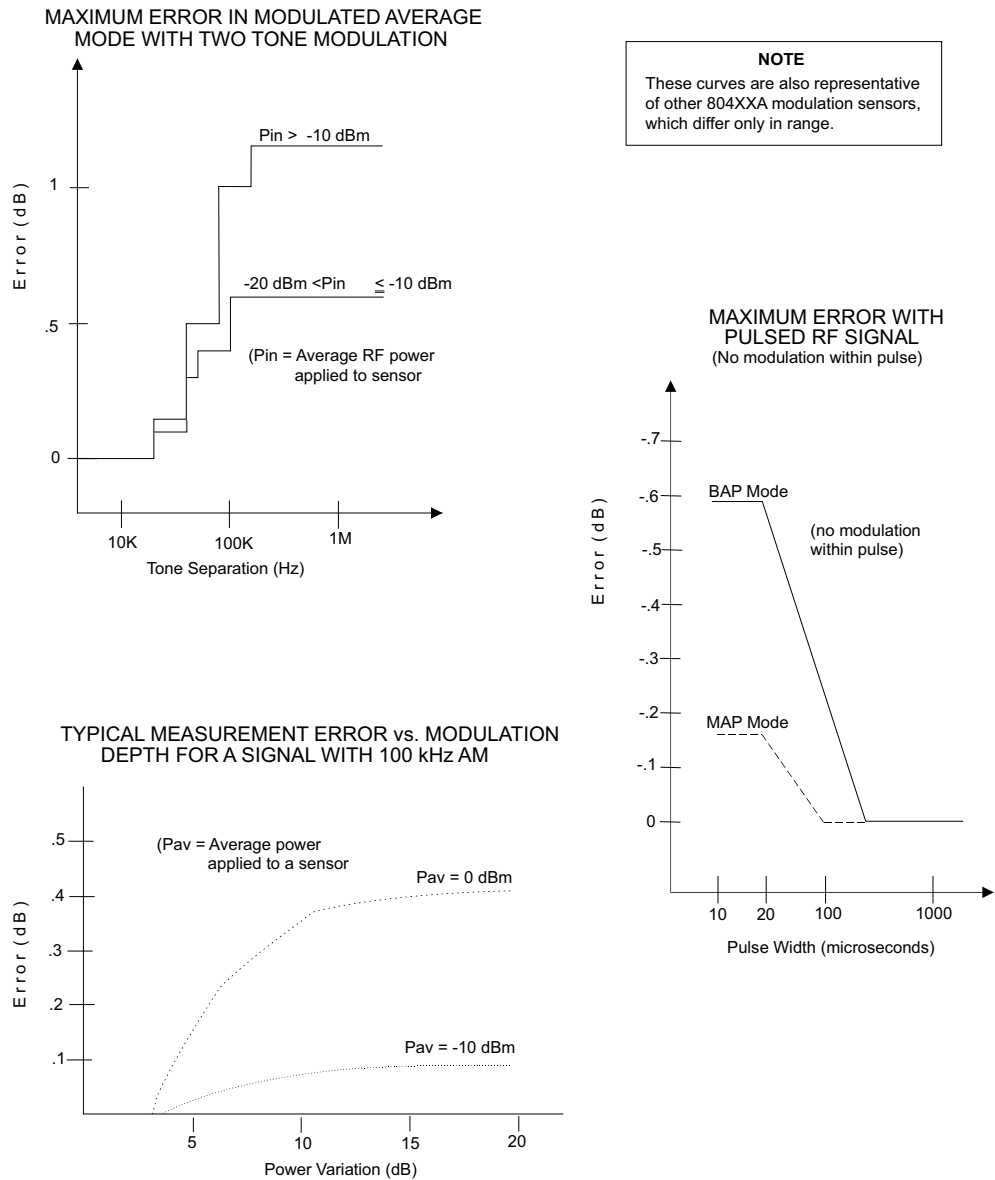

Figure B-1: 80401A Modulation-Related Uncertainty

B.2.2.1 80401A BAP Mode Limitations

The minimum input level is -40 dBm (average); the minimum pulse repetition frequency is 20 Hz. If the input signal does not meet these minima, NoSync will flash on the display to the right of the line configured for BAP mode sensor to indicate that the input is not suitable for BAP measurement. The 8650A will continue to read the input but the BAP measurement algorithms will not be able to synchronize to the modulation of the input; the input will be measured as if the 8650A were in MAP mode. In addition, some measurement inaccuracy will result if the instantaneous power within the pulse falls below -43 dBm; however, this condition will not cause NoSync to flash.

Modulation-Induced Measurement Uncertainty for the 80601A Sensor

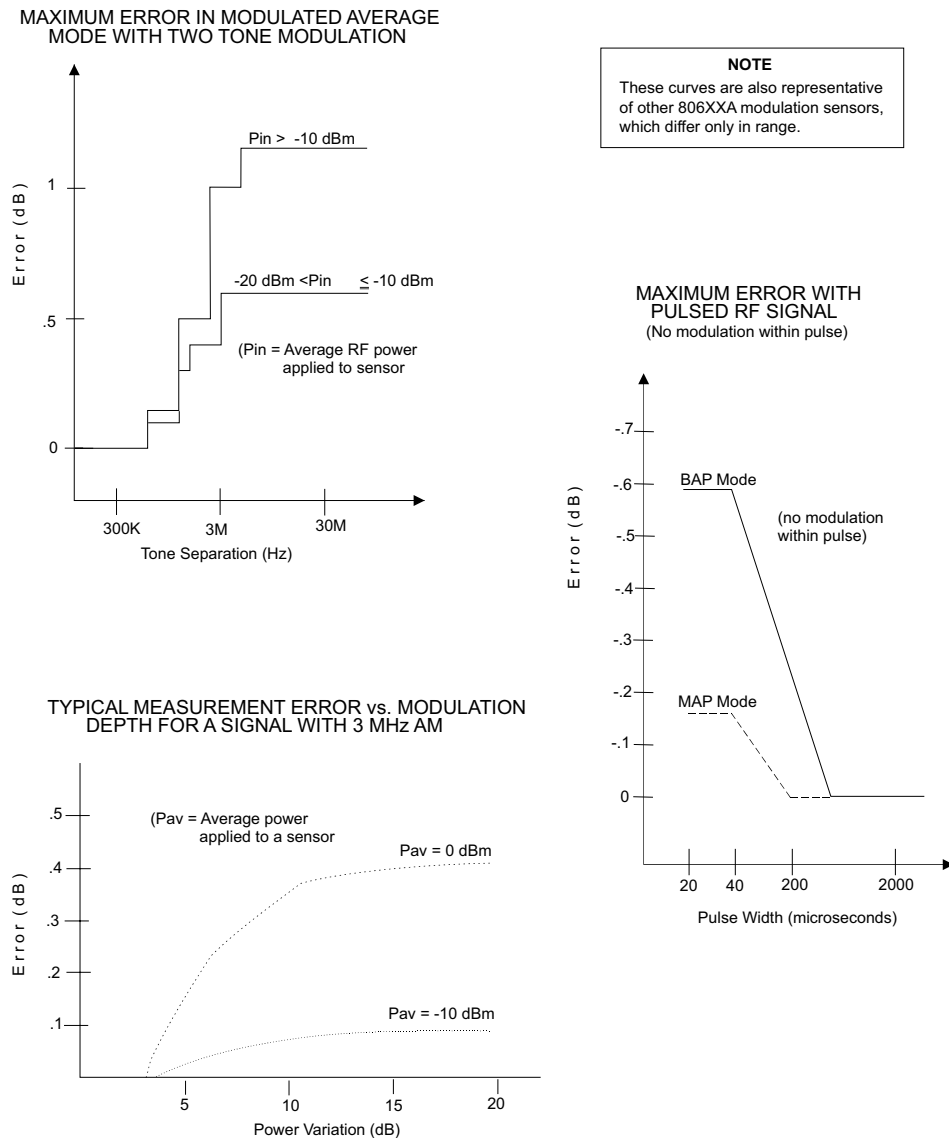

Figure B-2: 80601A Modulation-Related Uncertainty

B.2.2.1 80601A BAP Mode Limitations

The minimum input level is -35 dBm (average); the minimum pulse repetition frequency is 20 Hz. If the input signal does not meet these minima, NoSync will flash on the display to the right of the line configured for BAP mode sensor the front panel to indicate that the input is not suitable for BAP measurement. The 8650A will continue to read the input but the BAP measurement algorithms will not be able to synchronize to the modulation of the input; the input will be measured as if the 8650A were in MAP mode. In addition, some measurement inaccuracy will result if the instantaneous power within the pulse falls below -38 dBm; however, this condition will not cause NoSync to flash. See Section 2.3.2 for modulation bandwidth limitations below 200 MHz. When the modulation bandwidth is below 200 MHz, the 806XXA sensors' performance is equal to that of the 804XXA sensors.

Modulation-Induced Measurement Uncertainty for the 80701A Sensor

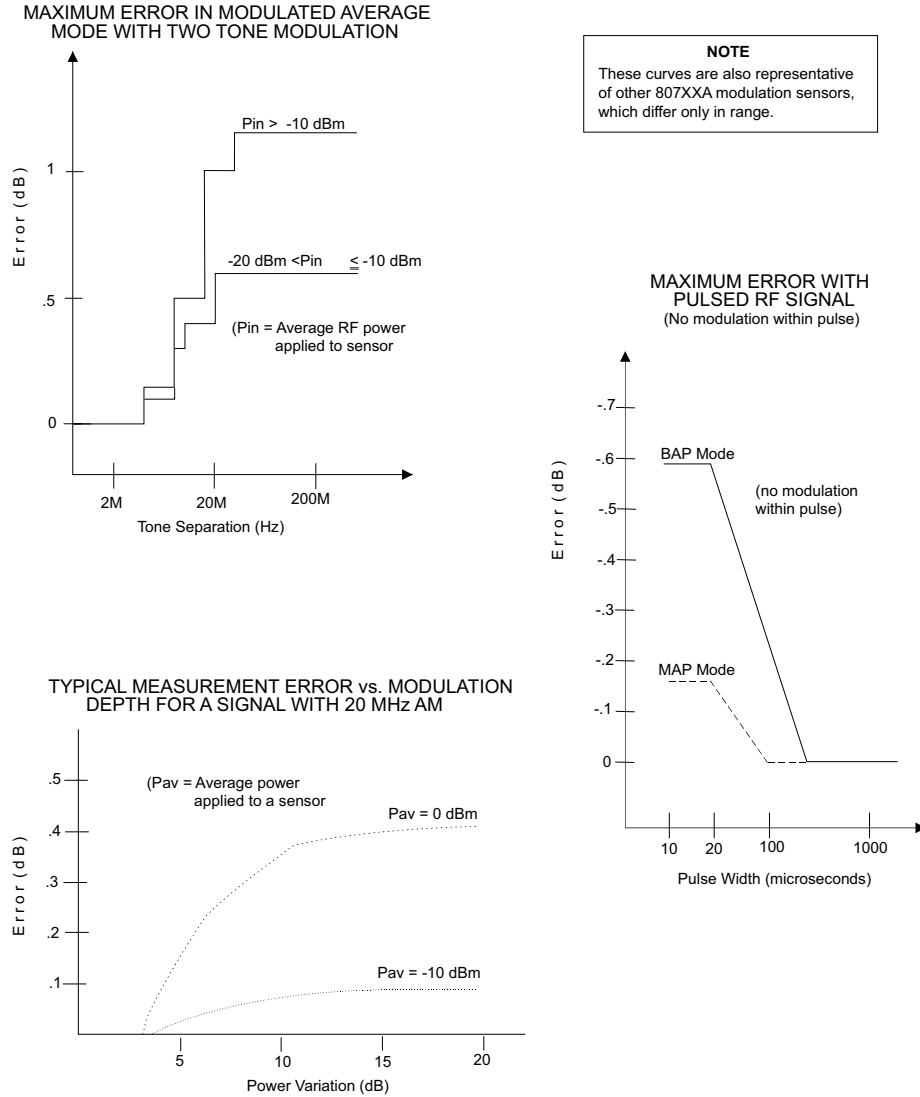

Figure B-3: 80701A Modulation-Related Uncertainty

B.2.2.1 80701A BAP Mode Limitations

The minimum input level is -35 dBm (average); the minimum pulse repetition frequency is 20 Hz. If the input signal does not meet these minima, NoSync will flash on the display to the right of the line configured for BAP mode sensor to indicate that the input is not suitable for BAP measurement. The 8650A will continue to read the input but the BAP measurement algorithms will not be able to synchronize to the modulation of the input; the input will be measured as if the 8650A were in MAP mode. In addition, some measurement inaccuracy will result if the instantaneous power within the pulse falls below -28 dBm; however, this condition will not cause NoSync to flash. See Section 2.3.2 for modulation bandwidth limitations below 200 MHz. When the modulation bandwidth is below 200 MHz, the 807XXA sensors' performance is equal to that of the 804XXA sensors.

B.2.3 Directional Bridges

The 80500 CW Directional Bridges are designed specifically for use with Giga-tronics power meters to measure the Return Loss/SWR of a test device. Each bridge includes an EEPROM which has been programmed with Identification Data for that bridge.

Table B-4: Directional Bridge Selection Guide

Precision CW Return Loss Bridges								
Model	Freq. Range/ Power Range	Max. Power	Power Linearity ⁴ (Frequency > 8 GHz)	Input	Test Port	Directivity	Wgt.	VSWR
80501	10 MHz to 18 GHz -35 to +20 dBm	+27 dBm (0.5W)	-35 to +10 dBm ±0.1 dB +10 to +20 dBm ±0.1 dB ±0.005 dB/dB	Type N(f) 50 Ω	Type N(f) 50 Ω	38 dB	0.340 kg	< 1.17:0.01 - 8 GHz < 1.27:8 - 18 GHz
80502	10 MHz to 18 GHz -35 to +20 dBm	+27 dBm (0.5 W)	-35 to +10 dBm ±0.1 dB +10 to +20 dBm ±0.1 dB ±0.005 dB/dB	Type N(f) 50 Ω	APC-7(f) 50 Ω	40 dB	0.340 kg	< 1.13:0.01 - 8 GHz < 1.22:8 - 18 GHz
80503	10 MHz to 26.5 GHz -35 to +20 dBm	+27 dBm (0.5 W)	-35 to +10 dBm ±0.1 dB +10 to +20 dBm ±0.1 dB ±0.005 dB/dB	SMA(f) 50 Ω	SMA(f) 50 Ω	35 dB	0.340 kg	< 1.22:0.01 - 18 GHz < 1.27:8 - 26.5 GHz
80504	10 MHz to 40 GHz -35 to +20 dBm	+27 dBm (0.5 W)	-35 to +10 dBm ±0.1 dB +10 to +20 dBm ±0.1 dB ±0.005 dB/dB	Type K(f) 50 Ω	Type K(f) 50 Ω	30 dB	0.198 kg	< 1.35:0.01 - 26.5 GHz < 1.44:26.5 - 40 GHz

The Selection Guide in Table B-4 shows primary specifications. Additional specifications are:

Bridge Frequency Response

Return loss measurements using the 8541/8542 power meter can be frequency compensated using the standard Open/Short supplied with the bridge.

Insertion Loss

6.5 dB, nominal, from input port to test port

Directional Bridge Linearity Plus Zero Set & Noise vs. Input Power

+27 dBm (0.5 W)

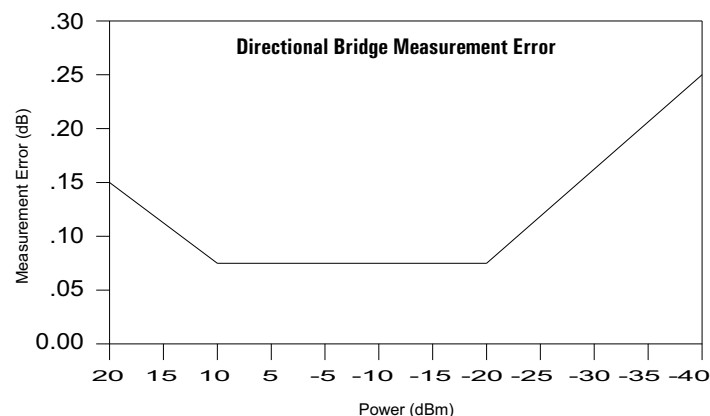

Series 8650A Universal Power Meters

Weight

80501	340 g (12 oz.)
80502	340 g (12 oz.)
80503	198 (7 oz.)
80504	198 (7 oz.)

Directional Bridge Accessories

An Open/Short is included for establishing the 0 dB return loss reference during path calibration.

Dimensions

80501	76 x 50 x 28 mm (3 x 2 x 1- ¹ / ₈ in.)
80502	76 x 50 x 28 mm (3 x 2 x 1- ¹ / ₈ in.)
80503	19 x 38 x 29 mm (³ / ₄ x 1- ¹ / ₂ x 2- ¹ / ₈ in.)
80504	19 x 38 x 29 mm (³ / ₄ x 1- ¹ / ₂ x 2- ¹ / ₈ in.)

C.1 Introduction

The options described in this appendix are available for the Series 8650A:

Option	Description	Part Number	Field Installable
01	Rack Mount Kit	21334	Yes
03	Rear Panel Sensor Input & Calibrator Output Connectors (8651A)	29864	No
04	Rear Panel Sensors Input & Calibrator Output Connectors (8652A)	29889	No
05	Soft Carry Case	21312	N/A
07	Side-mounted Carrying Handle	21339	No
08	Transit Case (Includes Soft Carry Case)	21344	NA
09	Dual Power Meter Rack Mount Kit	21684	Yes
10	Assembled Dual Power Meter Rack Mount	21647	No
12	1 GHz, 50 MHz Switchable Calibrator	29893	No
13	Rear Panel Sensor Input Connector (8651A)	29902	No
14	Rear Panel Sensor Input Connectors (8652A)	29903	No

C.2 Options

C.2.1 Option 01: Rack Mount Kit

Option 01 is a rack mounting kit for the 8650A.

C.2.2 Option 03: Rear Panel Sensor In & Calibrator Out Connectors (8651A)

When Option 03 is installed, the Sensor In and Calibrator Out connectors (which are normally located on the front panel of the 8651A) are relocated to the rear panel.

Series 8650A Universal Power Meters

C.2.3 Option 04: Rear Panel Sensor In & Calibrator Out Connectors (8652A)

When Option 04 is installed, the Sensor In and Calibrator Out connectors (which are normally located on the front panel of the 8652A) are relocated to the rear panel.

C.2.4 Option 05: Soft Carrying Case

Option 05 is a padded, soft carrying case for the 8650A.

C.2.5 Option 07: Side-mounted Carry Handle

Option 07 is a side-mounted carrying handle for the 8650A.

C.2.6 Option 08: Transit Case

Option 08 is a transit case for the 8650A; this option also includes the soft case described under Option 05.

C.2.7 Option 09: Dual Power Meter Rack Mount Kit

Option 09 is a field-installable dual power meter rack mounting kit (with assembly instructions) for the 8650A. The dual rack mount makes it possible to install two 8650As side-by-side in an instrument rack.

C.2.8 Option 10: Assembled Dual Power Meter Rack Mount Kit

Option 10 is a field-installable dual power meter rack mounting kit for the 8650A. The dual rack mount makes it possible to install two 8650As side-by-side in an instrument rack.

C.2.9 Option 12: 1 GHz, 50 MHz Switchable Calibrator

Option 12 provides a factory-configured switchable 1 GHz or 50 MHz calibrator.



NOTE: The 1 GHz calibrator is required for operation with the 80701A series power sensors.

C.2.10 Option 13: Rear Panel Sensor In Connectors (8651A)

Option 13 relocates the Sensor In connector, normally located on the front panel of the 8651A, to the rear panel. The Calibrator Out connector remains on the front panel.

C.2.11 Option 14: Rear Panel Sensor In Connectors (8652A)

Option 14 relocates the two Sensor In connectors, normally located on the front panel of the 8652A, to the rear panel. The Calibrator Out connector remains on the front panel.

Menu Structure

D.1 Introduction

This appendix pictorially describes the menu structure of the Series 8650A Universal Power Meters. Figure D-1 is a general layout of the menu tree; the diagrams in this appendix describe each menu in greater detail.

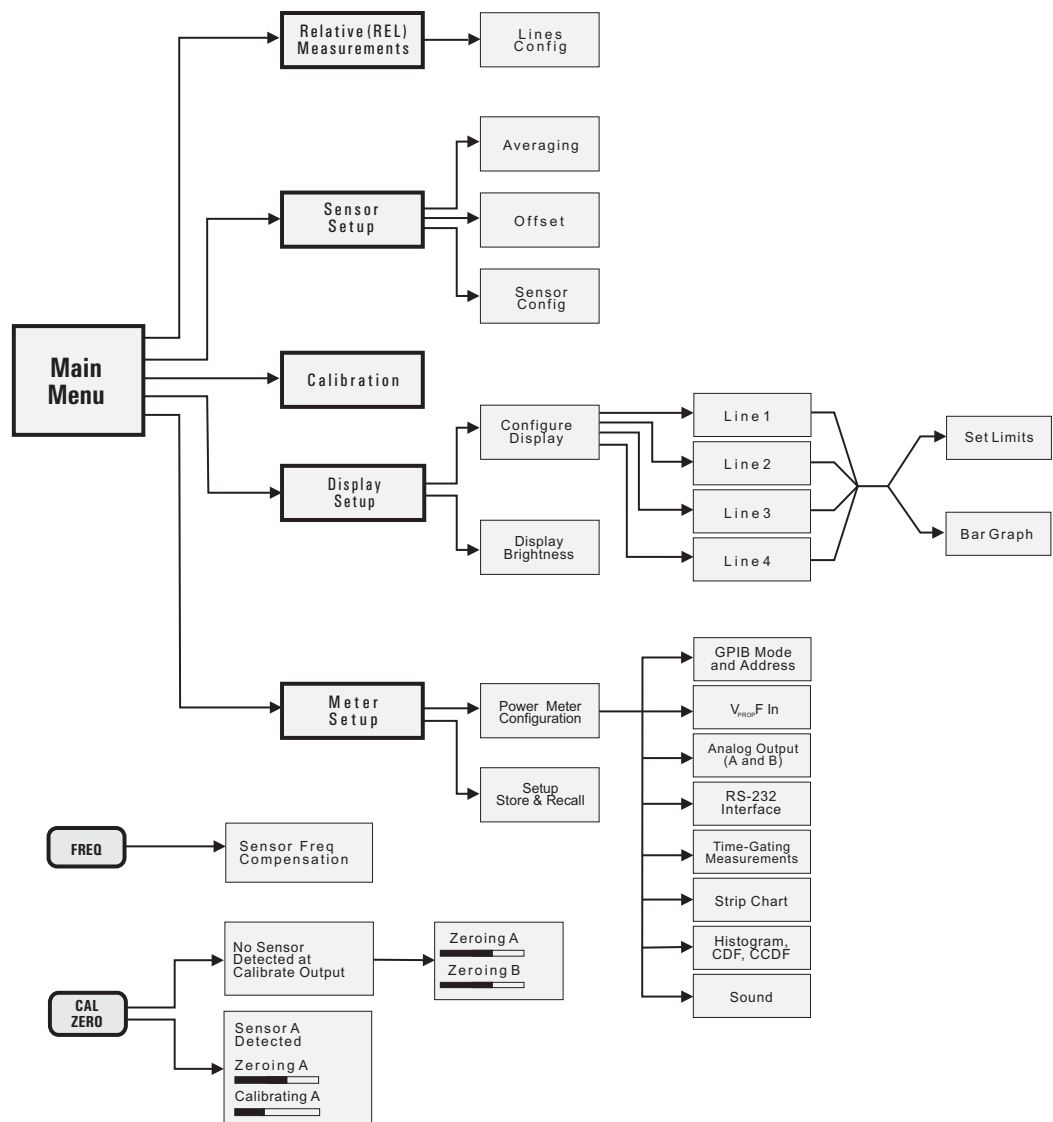

Figure D-1: Series 8650A Menu Tree

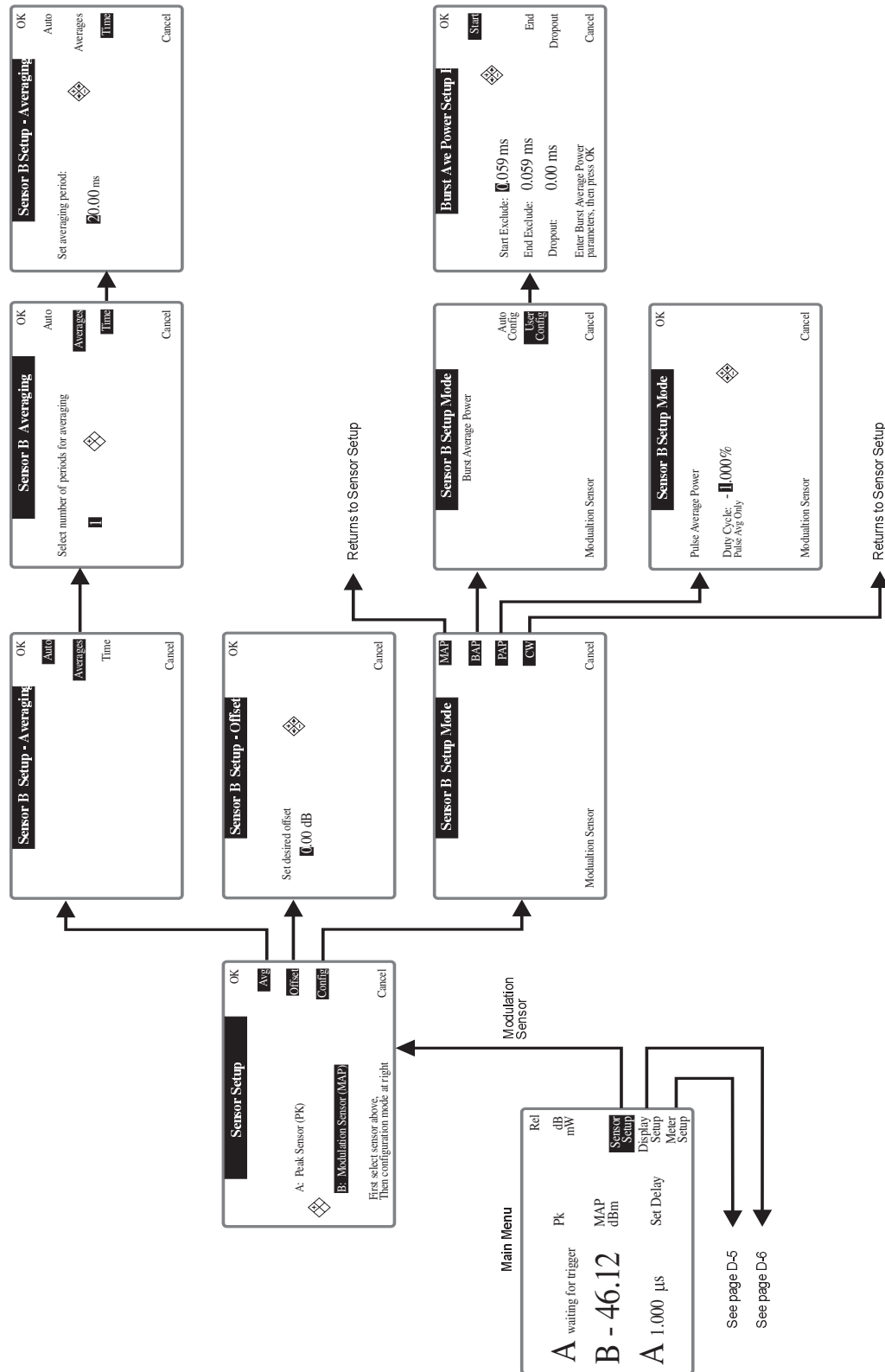

Figure D-3: Modulation Sensor B Setup Menu Structure

Series 8650A Universal Power Meters

11" x 17" (Landscape) pages follow continuing Appendix D of the Series 8650A Manual

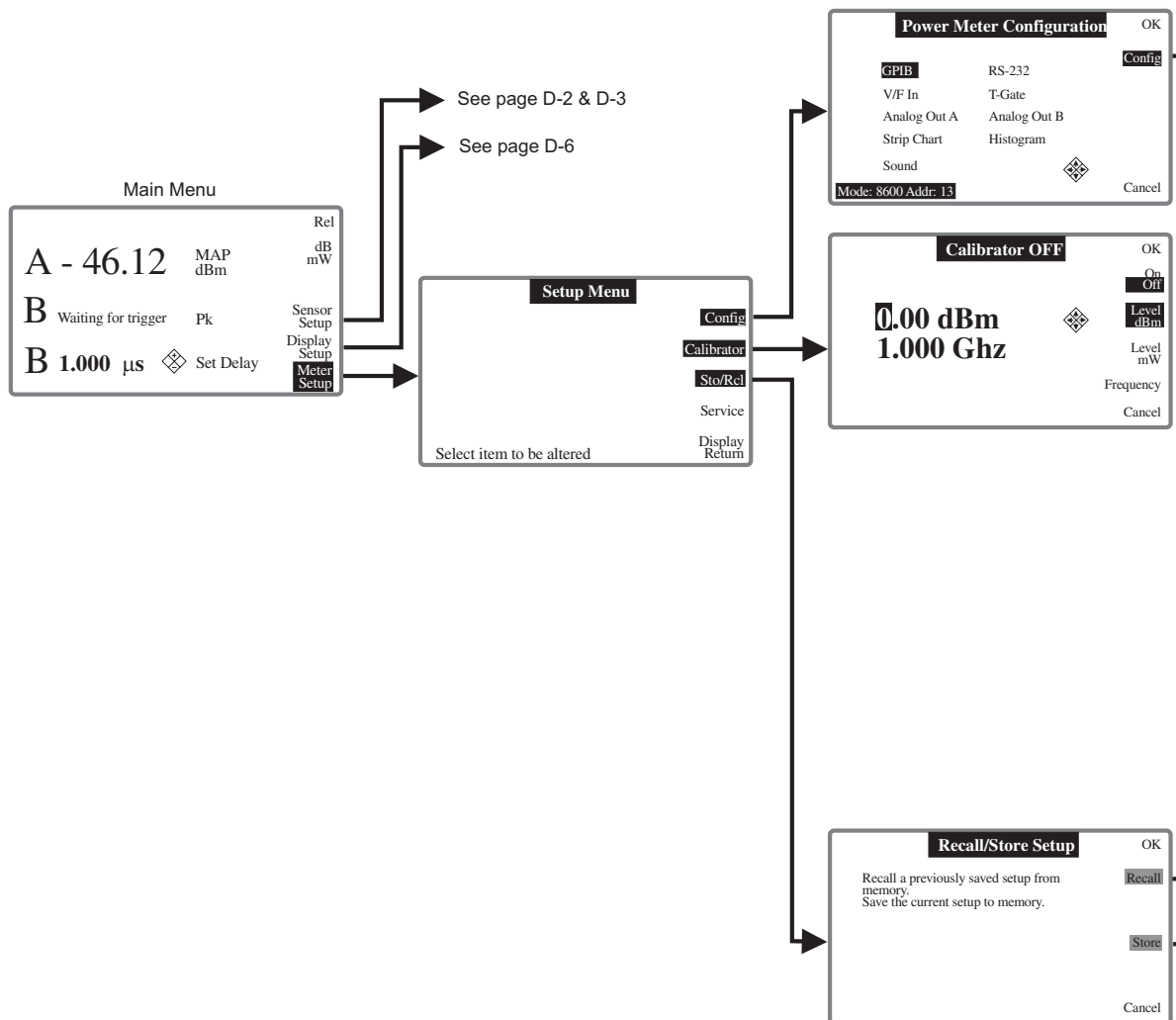

Figure D-4: Meter Setup Menu Structure

Series 8650A Universal Power Meters

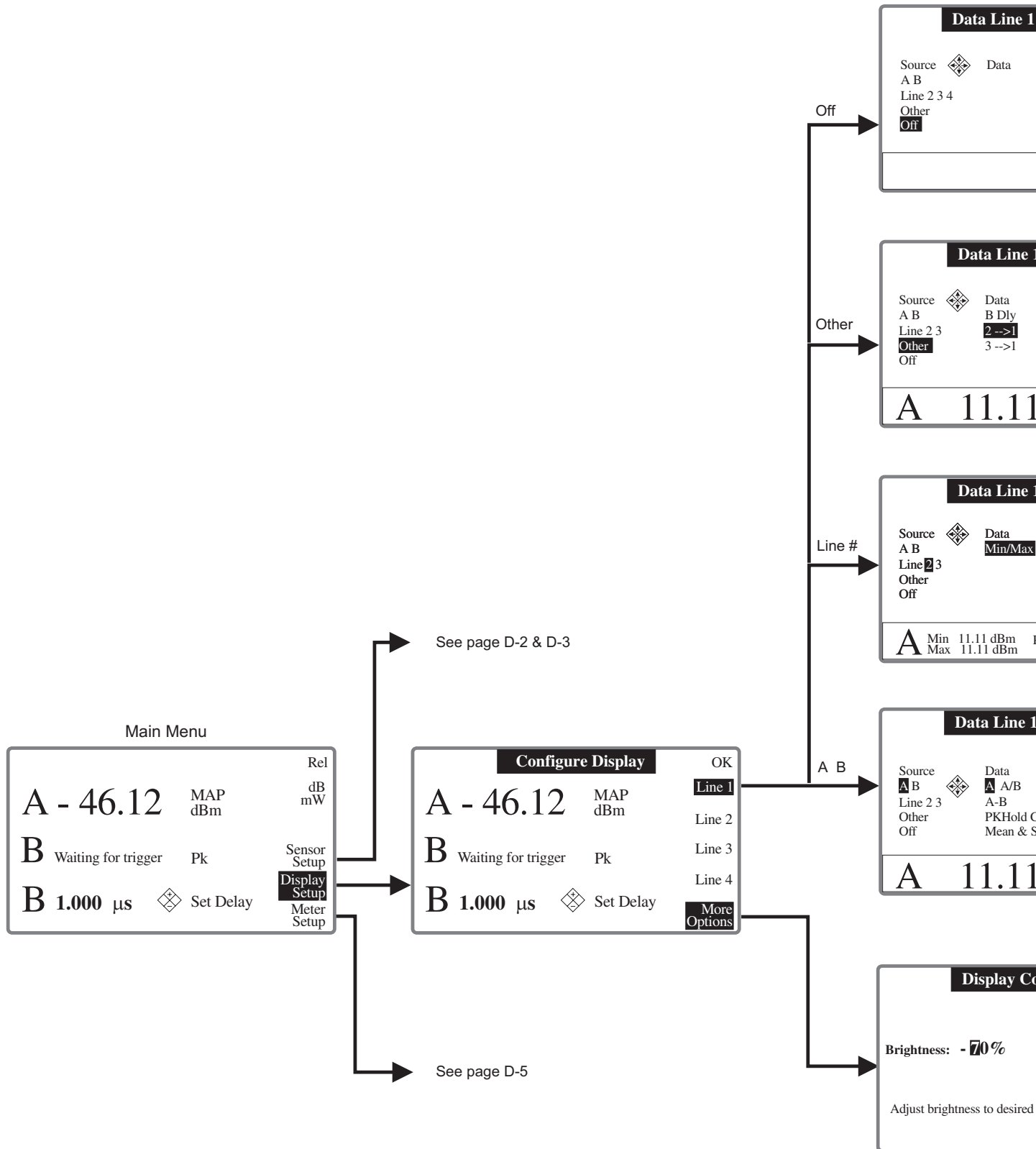

Figure D

Display

Series 8650A Universal Power Meters (Rev. F)

Numerics

80401A BAP Mode Limitations B-8
80601A BAP Mode Limitations B-9
80701A BAP Mode Limitations B-10
80701A Sensor Operation 2-23
8540C Emulation Command Code Set 3-69
8650A Configuration 2-4
8650A Series Features 1-1

A

About this Publication xi
Activating Limits 3-98
Activating or Deactivating a Duty Cycle 3-88
Advanced Features
 Burst Dropout 2-40, 3-115
 Burst End Exclude 2-39, 3-114
 Burst Start Exclude 2-39, 3-114
 Measured Offset Entry 2-21, 3-118
 Min/Max Configuration & Monitoring 2-17
 Min/Max Power Value 3-115
 Offset Commands 3-116
 Peak Hold 2-35, 3-119
 Peak Power Sensor Commands 3-121
 Preset 2-14, 3-123
 Relative Measurements 2-19, 3-124
 Resolution 2-18, 3-124
 Sensor Selection 3-125
 Setup 2-14, 3-132
 Status 3-126
 Store & Recall 2-14, 3-133
 Units 2-4, 3-134
 V_{PROP}F Feature 3-134
 Zeroing 2-25, 3-136
Analog Output 3-53
 Enabling & Disabling the Output 3-77
 Setting Options for the Output 3-77
Arming the Triggering Cycle 3-31
Averaging 3-42, 3-103
 Auto Averaging 2-20, 3-78
 Activating the Auto Filter Mode 3-78
 Freezing the Present Averaging Number 3-79
 Setting the Measurement Settling Target 3-78
 Manual Averaging 2-20, 3-80

B

BAP Mode 2-29, 3-112
Bar Graph 2-16
Brightness 2-19
Burst Dropout 2-40
Burst Dropout Tolerance 2-40, 3-115
Burst Edge 2-12
Burst End Exclude 2-39, 3-114
Burst Signal Measurements 2-38
Burst Start Exclude 2-39, 3-114

C

Cal Factor Correction 3-35
Cal Factor Error Control 3-36
Cal Factors 3-81
Calculate Subsystem Commands 3-7
Calibration 2-16
 Calibration & Zeroing HPS w/ Removable Attenuators 2-25
 Calibration Routine 3-82
 Calibrator Test 3-83
 Low Level Performance Check 2-26
 Sensor Calibration & Zeroing 3-5, 3-18
 Source 3-83
Calibration Routine 3-82
Calibrator 2-5
Calibrator Controls 3-60
Calibrator Frequency Check 4-4
Calibrator Source 3-83
Calibrator Test 3-83
CCDF 2-13
CDF 2-13
Channel Configuration 3-32
Channel Designation 3-84
Cleaning 1-2
Clear Device 3-2
Clear Interface 3-2
Command Format Illustrations 3-65
Command Interface
 GPIB Command Syntax 3-13
Command Syntax
 Function Codes 3-64
 Prefixes 3-64
 Separators 3-65
 Suffixes 3-65
 Variables 3-64
Commands in Brackets 3-13
Communication Configurations 3-45
Configuration 2-4, 2-6
Configuration (Front Panel Applications) 2-4
Conventions (Publication) xiii
Cooling 1-2

Series 8650A Universal Power Meters

Crest Factor 2-18, 2-36
 Enabling the Crest Factor Feature 3-85
 Reading the Crest Factor Value 3-85
CW Mode 2-31, 3-111

D

Data 2-18
Data Output Formats 3-4
Data Output Formats for Fast Modes 3-105
DELAY d 3-91
Description (Time Gating) 3-89
Directional Bridges B-11
Disabled Features 3-103
Display 2-16
Display Control
 Display Testing 3-87
 Displaying Messages 3-87
Display Screen 2-2
Display Setup
 Bar Graph 2-16
 Line Configuration 2-17
 More Options 2-19
 Relative Measurements 2-19
Display Testing 3-87
Displaying Messages 3-87
DURATION g 3-91
Duty Cycle Commands
 Activating or Deactivating a Duty Cycle 3-88
 Reading Duty Cycle Status 3-88
 Specifying a Duty Cycle 3-88

E

EEPROM
 Cal Factors 3-92
 Frequency 3-93
Enabling & Disabling Histograms HIST 3-137
Enabling & Disabling the Output 3-77
Enabling & Disabling V_{PROP} 3-134
Enabling the Crest Factor Feature 3-85
 Crest Factor 2-18
Enabling the Min/Max Feature 2-17, 3-115
Enabling the Peak Hold Feature 3-119
Enabling/Disabling an Offset 3-117
Environmental Standards 1-2
Equipment Required 4-5
Error Codes 3-91
Error Control 3-43
Error Messages 3-61
Event Status Register 3-48, 3-127
Example Programs 3-109
External Gating Mode 2-10, 3-89
External Trigger Mode 2-11, 3-89

F

Fast Buffered Mode 3-106
Fast Mode Setup 3-104
Fast Modulated Mode 3-110
Free Run (TR3) 3-101
Freezing the Present Averaging Number 3-79
Frequency 3-93
Front Panel 2-1
Front Panel Operation
 Display Screen 2-2
 Introduction 2-1
 Sensor Inputs 2-3
Function Codes 3-64

G

Gate A or B 3-90
General (Measurement Collection Modes - Fast)
 Averaging 3-103
 Disabled Features 3-103
 Fast Mode Setup 3-104
 Measurement Changes 3-103
 Sensor Measurements Supported 3-103
 Warning Regarding Interruption & Reconfiguration 3-104
General Information
 8650A Series Features 1-1
 Cleaning 1-2
 Cooling 1-2
 Environmental Standards 1-2
 Items Furnished 1-2
 Items Required 1-2
 Power Requirements 1-2
 Receiving Inspection 1-3
 Reshipment Preparation 1-3
 GPIB 1-6, 2-6
 GPIB Command Syntax
 Commands in Brackets 3-13
 Italics in Syntax Descriptions 3-13
 Link Command Strings 3-13
 Measurement Data Output Format 3-13
 Programmer Selective Parameters 3-13
 Query Format 3-13
 GPIB Port Check 4-8
 Group Execute Trigger
 Group Trigger Immediate (GT1) 3-102

H

Halting Operation 3-55
High Power Level Measurements 2-28
High Speed Measurements
 Measurement Level Notes 3-39
 Measurement Speeds 3-39
 Operating Mode Control 3-37
 Triggering Notes 3-39
Histogram Query 3-138
Histogram Range 3-137

Histograms

- Mode Intervals 3-137
- Query 3-138
- Range 3-137

Histograms, CDF & CCDF 3-137

HOLDOFF h 3-91

HP436 Emulation Command Code Set 3-72

HP437 Emulation Command Code Set 3-73

HP438 Emulation Command Code Set 3-75

I

Identification Commands 3-59

Identification Strings 3-94

IEEE 488.2 Interface Command Codes

- 8540C Emulation Command Code 3-69
- 8650A Command Code Set 3-66
- Command Syntax 3-64
- HP436 Emulation Command Code Set 3-72
- HP437 Emulation Command Code Set 3-73
- HP438 Emulation Command Code Set 3-75

IEEE 488.2 Required Commands 3-6

Improving Accuracy 2-43

Installation

- 8650A Configuration 2-4
- Interface (Rear Panel) 1-6
 - Analog Outputs 1-6
 - Line Voltage Selection & Fuse 1-6
- Meter Setup 2-5
- Power 1-5
- Power Sensor Precautions 1-5
- Safety 1-4

Instrument Identification 3-94

Instrument Plus Power Sensor Linearity

- Setup Parameters 4-7
- Test Description 4-6
- Test Procedure 4-8

Instrument Triggering 3-28

Interface (Rear Panel) 1-6

- Remote Interface 1-6

Introduction 2-1, 3-1, 4-1, A-1, B-1, C-1, D-1

Italics in Syntax Descriptions 3-13

Items Furnished 1-2

Items Required 1-2

L

Language Configuration 3-56

Learn Modes 3-95

- Learn Mode #1 3-96
 - Requesting the String 3-96
 - Sending the String 3-96
- Learn Mode #2 3-97
 - Requesting the String 3-97
 - Sending the String 3-97

Limit Line Configuration & Monitoring 3-51

Limits 2-18

- Activating Limits 3-98
- Measuring with Limits 3-99
- Setting Limits 3-98
- Line Configuration
 - Configuration 2-18
 - Data 2-18
 - Mean & Standard Deviation 2-18
 - More Options 2-19
 - Source 2-17

Linking Command Strings 3-13

Local & Remote Control 3-2

M

Manual Averaging 2-20, 3-80

MAP Mode 2-28, 3-111

Mean & Standard Deviation 2-18

Measured Offset Entry 2-21, 3-118

Measurement Changes 3-103

Measurement Collection Modes

- Averaging 3-42
- CW Mode 2-31
- Peak Mode 2-31

Measurement Collection Modes (Fast)

- Data Output Formats for Fast 3-105
- Fast Buffered Mode 3-106
- Fast Modulated Mode 3-110
- General 3-103
- Swift Mode 3-108

Measurement Collection Modes (Standard) 3-100

- Group Execute Trigger 3-102
- Triggering 3-6

Measurement Data Output Format 3-13

Measurement Guide

- 80701A Sensor Operation 2-23
- Burst Dropout 2-40
- Burst End Exclude, Burst End Exclude 2-39
- Burst Signal Measurement 2-38
- Crest Factor 2-36
- High Power Level Measurements 2-28
- Improving Accuracy 2-43
- Measurement Collection Modes 2-31
- Measuring an Attenuator (Single Channel Method) 2-42
- Measuring Source Output Power 2-27
- Mode Restrictions 2-33
- Modulated Measurement Modes 2-28
- Multi-Tone Tests 2-33
- Optimizing Measurement Speed 2-41
- Peak Hold 2-35
- Peak Power Measurements 2-42
- Peaking Meter 2-27
- Performance Verification 2-44
- Sensor Calibration & Zeroing 2-24
- Sources of Error 2-45
- Using the Power Sweep Calibrator 2-23
- When to use CW, MAP & BAP 2-33

Measurement Level Notes 3-39

Measurement Mode Commands

- BAP Mode 3-112
- CW Mode 3-111
- MAP Mode 3-111
- Measurement Mode Query 3-113
- PAP Mode 3-112
- Peak Mode 3-112

Series 8650A Universal Power Meters

- Measurement Mode Query 3-113
- Measurement Speeds 3-39
- Measurement Triggering 3-6
 - Free Run (TR3) 3-101
 - Trigger Hold 3-100
 - Trigger Immediate (TR1) 3-100
 - Trigger Immediate with Full Averaging 3-100
- Measuring an Attenuator (Single Channel) 2-42
- Measuring Source Output Power 2-27
- Measuring with Limits 3-99
- Memory Functions 3-6
- Menu Structure D-1
- Meter Setup 2-5
 - Burst Mode 2-12
 - External Gate Mode 2-10
 - External Trigger Mode 2-11
 - GPIB 2-6
 - Store & Recall 2-14, 3-133
- Min/Max Configuration & Monitoring 2-17, 3-50
- Min/Max Power Value 2-17
 - Enabling the Min/Max Feature 3-115
 - Reading the Min/Max Values 3-116
- Mode Restrictions 2-33
- Modulated Measurement Modes
 - BAP Mode 2-29
 - MAP Mode 2-28
 - PAP Mode 2-29
- Modulated Sensor Specifications B-7
- More Options
 - Brightness 2-19
- Multi-Tone Tests 2-33

N

- Notes on Speed in the Fast Buffered Mode 3-107

O

- OFF or GATE or TRIGGER 3-90
- Offset Commands 3-116
- Offset Value 2-21
- Offsets 3-44
- Operating Mode Control 3-37
- Optimizing Measurement Speed 2-41
- Options
 - Calibrator C-2
 - Opt. 01 - Rack Mount Kit C-1
 - Opt. 03 - Rear Panel Sensor In & C.O. Cntrs (8651A) C-1
 - Opt. 04 - Rear Panel Sensor In & C.O. Cntrs (8652A) C-2
 - Opt. 05 - Soft Carrying Case C-2
 - Opt. 07 - Side-mounted Carry Handle C-2
 - Opt. 08 - Transit Case C-2
 - Opt. 09 - Dual Power Meter Rack Mount Kit C-2
 - Opt. 10 - Assembled Dual Power Meter Rack Mount Kit C-2
 - Opt. 12 - 1 GHz, 50 MHz Switchable Calibrator C-2
 - Opt. 13 - Rear Panel Sensor In Connectors, Model 8651A C-2
 - Opt. 14 - Rear Panel Sensor In Connectors, Model 8652A C-2
 - Rack Mount C-2
- Output Power Reference Level 4-2

P

- PAP Mode 2-29, 3-112
- Parallel Polling 3-3
- Peak Hold 2-35
 - Enabling the Peak Hold Feature 3-119
 - Reading the Peak Hold Value 3-119
- Peak Mode 2-31, 3-112
- Peak Power Measurements 2-42
- Peak Power Sensor Commands 3-121
- Peak Power Sensor Triggering 2-42, 3-40
- Peaking Meter 2-27
- Performance Verification 2-44
 - Calibrator Procedure 4-2
 - Equipment Required 4-1
 - Frequency Check 4-4
 - GPIB Port Check 4-8
 - Instrument Plus Power Sensor Linearity 4-6
 - Output Power Reference Level 4-2
 - Performance Verification Tests 4-5
- Polling
 - Parallel Polling 3-3
 - Serial Polling 3-3
- Power 1-5
- Power Requirements 1-2
- Power Sensor
 - Cal Factor Uncertainties B-6
- Power Sensor Precautions 1-5
- Power Sensor Selection B-1
- Power Sensors
 - 80401A BAP Mode Limitations B-8
 - 80601A BAP Mode Limitations B-9
 - 80701A BAP Mode Limitations B-10
 - Cal Factor Uncertainties B-6
 - Directional Bridges B-11
 - Introduction B-1
 - Modulated Sensor Specifications B-7
 - Peak Power Sensor Triggering 3-40
 - Selection Charts B-2
- Power-On Default Conditions 3-4
- Prefixes 3-64
- Preset 2-14, 3-123
- Preset Configuration 3-57
- Programmer Selective Parameters 3-13

Q

- Query a Stored Setup 3-132
- Query Format 3-13

R

- Reading Duty Cycle Status 3-88
- Reading Power Measurements 3-26
- Reading the Crest Factor Value 3-85
- Reading the Min/Max Values 3-116
- Reading the Peak Hold Value 3-119
- Receiving Inspection 1-3
- Record of Publication Changes xv

Relative Measurements 2-19, 3-124
 Relative or Referenced Measurements 3-43
 Remote Interface 1-6
 Remote Operation
 Advanced Features 3-114
 Analog Output 3-77
 Averaging 3-78
 Cal Factors 3-81
 Calibration 3-82
 Crest Factor 2-36, 3-85
 Data Output Formats 3-4
 EEPROM 3-92
 Instrument Identification 3-94
 Learn Modes 3-95
 Limits 3-98
 Measurement Collection Modes (Standard) 3-100
 Measurement Mode Commands 3-111
 Polling 3-3
 Power-On Default Conditions 3-4
 SCPI Command Interface 3-5
 Sending Commands to the 8650A 3-1
 Time Gating Measurement 3-89
 Reshipment Preparation 1-3
 Resolution 2-18, 3-124
 Restrictions 2-33
 Retrieving a Configuration 3-133
 RS-232 1-6

S

Safety Precautions 1-4
 Saving & Recalling Configurations 2-14, 3-55
 Saving a Configuration 2-14, 3-133
 Saving and Recalling Configurations 2-14
 SCPI (Native) 3-140
 SCPI Command Interface
 Analog Output 3-77
 Arming the Triggering Cycle 3-31
 Averaging 3-42
 Cal Factor Correction 3-35
 Calculate Subsystem Commands 3-7
 Calibrator Controls 3-60
 Channel Configuration 3-5, 3-32
 Communication Configurations 3-45
 Error Messages 3-61
 GPIB Command Syntax 3-13
 Halting Operation 3-55
 High Speed Measurements 3-37
 Identification Commands 3-59
 IEEE 488.2 Required Commands 3-6
 Instrument Triggering 3-28
 Language Configuration 3-56
 Limit Line Configuration & Monitoring 3-51
 Measurement Triggering 3-6, 3-100
 Memory Functions 3-6
 Min/Max Configuration & Monitoring 3-50
 Offsets 3-44
 Peak Power Sensor Triggering 3-40
 Preset Configuration 3-57, 3-123
 Reading Power Measurements 3-26
 Referenced Measurements 3-43
 Relative Measurements 3-43
 Self-Test 3-61
 Sense Subsystem Commands 3-9
 Sensor & Channel Configuration 3-5, 3-32
 Sensor Calibration & Zeroing 3-5, 3-18
 Sensor Configuration Commands 3-20
 Sensor EEPROM Commands 3-60
 Sensor Gate Commands 3-23
 SRQ & Status Monitoring 3-46
 Trigger Subsystem Commands 3-11
 Self-Test 3-61
 Sending Commands to the 8650A 3-1
 Clear Device 3-2
 Clear Interface 3-2
 Local & Remote Control 3-2
 Sense Subsystem Commands 3-9
 Sensor 3-19, 3-23
 Sensor & Channel Configuration 3-5
 Sensor Calibration 2-24, 3-18, 3-20
 Sensor Calibration & Zeroing 2-24, 3-5, 3-18
 Sensor Configuration 2-21
 Sensor Configuration Commands 3-20
 Sensor EEPROM Commands 3-60
 Sensor Gate Commands 3-23
 Sensor Inputs 2-3
 Sensor Measurements Supported 3-103
 Sensor Selection 3-125
 Sensor Selection & Calibration 3-2
 Sensor Setup
 80701A Sensor Operation 2-23
 Averaging 2-20
 Averaging Period 2-20
 Time 2-20
 Configuration 2-21
 Peak Sensors 2-21
 External Trigger 2-21
 Internal Trigger 2-21
 Meter Setup 2-5
 Modulation Sensors 2-22
 Offset Value 2-21
 Sensor Calibration & Zeroing 2-24
 Separators 3-65
 Serial Polling 3-3
 Series 80350A Sensors SENS 3-121
 Service 2-15
 Setting an Offset Value 2-21, 3-117
 Setting Histogram Mode Intervals 3-137
 Setting Limits 2-18, 3-98
 Setting Options for the Output 2-7, 3-77
 Setup
 Query a Stored Setup 3-132
 Store a Setup 2-14, 3-132
 Sources of Error 2-45
 Special Configurations xvii
 Specifications
 Accuracy 1-8
 Fast Buffered Mode Controls 1-12
 General Specifications 1-13
 Inputs/Outputs 1-12
 Measurement Rates 1-11
 Options 1-13
 Power Meter 1-7
 Power Sensors 1-13
 Remote Operation 1-12
 Specifying a Duty Cycle 2-22, 3-88
 SRQ & Status Monitoring 3-46
 Event Status Register 3-48, 3-127
 Statistics 2-18
 Query 3-140
 Statistics Enable/Disable 3-140

Series 8650A Universal Power Meters

Status

- Event Status Register 3-48, 3-127
- Status Byte Message 3-126
- Status Message 3-127
- Status Message Output Format 3-128
- Status Byte Register 3-49
- Status Message 3-127
- Status Message Output Format 3-128
- Store & Recall 2-14, 3-55
 - Retrieving a Configuration 3-133
 - Saving a Configuration 3-133
- Store a Setup 2-14, 3-132
- Strip Chart
 - Pause/Resume 3-139
 - Query 3-139
- Suffixes 3-65
- Swift Mode 3-108

T

Time Gating Measurement

- Description 3-89
 - External Gating Mode 2-10, 3-89
 - External Trigger Mode 2-11, 3-89
 - Time Gating Mode 3-90
- ### Time Gating Mode
- DELAY d 3-91
 - DURATION g 3-91
 - Gate A or B 3-90
 - HOLDOFF h 3-91
 - OFF or GATE or TRIGGER 3-90
- ### Trigger Hold (TR0) 3-100
- ### Trigger Immediate (TR1) 3-100
- ### Trigger Immediate with Full Averaging (TR2) 3-100
- ### Trigger Subsystem Commands 3-11
- ### Triggering
- Arming the Triggering Cycle 3-31
 - Instrument Triggering 3-28
 - Peak Power Sensor Triggering 3-40
- ### Triggering Gate Mode
- Burst Edge Mode 2-12
 - External Gating Mode 2-10, 3-89
 - External Trigger Mode 2-11, 3-89
- ### Triggering Notes 3-39
- ### Typical Applications Programs
- Continuous Data Reading A-1
 - Fast Buffered Demo - POST GET A-6
 - Fast Buffered Demo - POST TTL A-7
 - Remote Calibration of a Sensor A-1
 - Speed Tests - Normal & Swift A-2
 - Swift Demo 1 - FREERUN A-4
 - Swift Demo 2 - GET A-5

U

- Units 2-4, 2-18, 3-134
- Using the Power Sweep Calibrator 2-23

V

- Variables 3-64
- V_{PROP}F Feature 3-134
 - Configuring V_{PROP}F 3-135

W

- Warning Regarding Interruption & Reconfiguration 3-104
- When to use CW, MAP & BAP 2-33

Z

- Zeroing 2-25, 3-136
 - Sensor Calibration & Zeroing 2-24, 3-5, 3-18