

# HUNTRON<sup>®</sup> TRACKER<sup>®</sup>

## OPERATOR MANUAL

FOR MODELS

HTR 1005B-1S

HTR 1005B-1ES

HTR 1005B-1JS

HUNTRON<sup>®</sup>



## TABLE OF CONTENTS

### SECTION 1 - GENERAL INFORMATION

1.1 ABOUT THIS MANUAL	
1.2 TRACKER DESCRIPTION	1-1
1.3 PRINCIPLES OF TRACKER OPERATION	1-3
1.3.1 Tracker Test Signal	1-3
1.3.2 Horizontal and Vertical Deflection of the Display	1-3
1.3.3 Short and Open Circuit Displays	1-4

### SECTION 2 - TRACKER OPERATION

2.1 GENERAL	2-1
2.2 CONTROLS AND INDICATORS	2-1
2.3 ALTERNATE MODE OPERATION	2-3
2.4 FUSE REPLACEMENT	2-3

### SECTION 3 - TESTING DIODES

3.1 THE SEMICONDUCTOR DIODE AND ITS CHARACTERISTICS	3-1
3.1.1 Diode Symbol and Definition	3-1
3.1.2 The Volt-Ampere Characteristic	3-2
3.2 SILICON RECTIFIER DIODES	3-2
3.2.1 Patterns of a Good Diode	3-2
3.2.2 Patterns of a Defective Diode	3-3
3.3 HIGH VOLTAGE SILICON DIODES	3-3
3.4 RECTIFIER BRIDGES	3-5
3.5 LIGHT-EMITTING DIODES	3-8
3.6 ZENER DIODES	3-8

### SECTION 4 - TESTING TRANSISTORS

4.1 BIPOLAR JUNCTION TRANSISTORS	4-1
4.2 NPN BIPOLAR TRANSISTORS	4-1
4.2.1 B-E Junction Testing	4-2
4.2.2 C-E Connection Testing	4-2
4.2.3 C-B Junction Testing	4-3
4.3 PNP BIPOLAR TRANSISTORS	4-4
4.4 POWER TRANSISTORS - NPN OR PNP	4-5
4.5 DARLINGTON TRANSISTORS	4-5
4.6 JFET TRANSISTORS	4-8
4.7 MOSFET TRANSISTORS	4-9
4.7.1 General	4-9
4.7.2 Depletion Mode MOSFET	4-10
4.7.3 Enhancement Mode MOSFET	4-11
4.7.4 MOSFET with Protection Diode	4-12
4.8 UNIUNCTION TRANSISTORS (UJT)	4-15

### SECTION 5 - RESISTORS, CAPACITORS, AND INDUCTORS

5.1 RESISTORS	5-1
5.1.1 General	5-1
5.1.2 Low Range	5-1
5.1.3 Medium Range	5-2
5.1.4 High Range	5-2
5.2 CAPACITORS	5-3
5.3 INDUCTORS	5-3
5.4 TOROID INDUCTORS	5-6

## **SECTION 6 - TESTING MULTIPLE COMPONENT CIRCUITS**

6.1 TRACKER DIAGNOSTIC PRINCIPLES .....	6-1
6.2 DIODE/RESISTOR CIRCUIT .....	6-2
6.2.1 Diode in Parallel with Resistor .....	6-2
6.2.2 Diode in Series with Resistor .....	6-4
6.3 DIODE AND CAPACITOR PARALLEL COMBINATION .....	6-5
6.4 RESISTOR AND CAPACITOR PARALLEL COMBINATION .....	6-7
6.5 INDUCTOR WITH DIODE .....	6-8

## **SECTION 7 - TESTING INTEGRATED CIRCUITS**

7.1 INTRODUCTION .....	7-1
7.1.1 Integrated Circuit Technology .....	7-1
7.1.2 Integrated Circuit Testing Techniques .....	7-2
7.2 LINEAR OPERATIONAL AMPLIFIERS .....	7-2
7.3 LINEAR VOLTAGE REGULATORS .....	7-5
7.3.1 The 7805 Regulator .....	7-5
7.3.2 The 7905 Regulator .....	7-7
7.4 555 TIMERS .....	7-9
7.5 TTL DIGITAL INTEGRATED CIRCUITS .....	7-12
7.5.1 General .....	7-12
7.5.2 TTL Devices .....	7-13
7.5.3 LS TTL Devices .....	7-14
7.5.4 Tri-State TTL Digital Devices .....	7-15
7.6 CMOS INTEGRATED CIRCUITS .....	7-17
7.7 MICROPROCESSORS .....	7-19

## **SECTION 8 - TESTING RECTIFIERS**

8.1 SILICON CONTROLLED RECTIFIERS .....	8-1
8.2 TRIAC DEVICES .....	8-3

## **SECTION 9 - TESTING POWER SUPPLIES**

9.1 GENERAL .....	9-1
9.2 TESTING PROCEDURE .....	9-2

## **SECTION 10 - TESTING COMPONENTS BY COMPARISON**

10.1 INTRODUCTION .....	10-1
10.2 SETUP PROCEDURES .....	10-1
10.3 HIGH VOLTAGE TRANSISTOR (TIP-50) .....	10-2
10.3.1 TIP-50 B-E Junction .....	10-2
10.3.2 TIP-50 C-E Junction .....	10-3
10.4 HIGH VOLTAGE DIODE HV-15F .....	10-4
10.5 100uF 25V ELECTROLYTIC CAPACITOR .....	10-4
10.6 1458 DUAL OP-AMP .....	10-5
10.7 7905 NEGATIVE REGULATOR .....	10-8

## **SECTION 11 - SOLVING BUS PROBLEMS**

11.1 INTRODUCTION .....	11-1
11.2 STUCK WIRED-OR BUS .....	11-1
11.3 DEFECTIVE WAVESHAPE ON BUS .....	11-1
11.4 MEMORIES .....	11-1

## **SECTION 12 - TROUBLESHOOTING TIPS**

APPENDIX A .....	A1
------------------	----

APPENDIX B .....	A5
------------------	----

# SECTION 1

## GENERAL INFORMATION

### 1.1 ABOUT THIS MANUAL

This manual is provided for the operator of the Huntron Tracker. The information contained within this manual familiarizes the reader first with the tracker and its principles of operation, and then with its specific uses. A working knowledge of the tracker's operating principles greatly assists the user in evaluating the tracker's display, especially when using the instrument for troubleshooting purposes.

The manual is divided into sections. Each section contains information pertinent to a certain application of the unit. The sections contain the following information.

#### Section 1 - GENERAL INFORMATION

This section provides a description of the tracker and lists its specifications. It also describes the principles on which the tracker operates, using a pure resistance and a diode as examples.

#### Section 2 - TRACKER OPERATION

This section describes the front panel controls of the tracker. It also describes the tracker's comparative testing feature.

#### Section 3 - DIODE TESTING

This section describes the characteristics of the diode (showing its voltage-to-current relationship), which is essential to understanding the tracker display. This section also illustrates and describes tracker displays produced when the test leads are connected to (or across) circuits containing the following devices: silicon diodes, high voltage silicon diodes, zener diodes, bridging diodes, and light-emitting diodes.

#### Section 4 - TRANSISTOR TESTING

This section illustrates and describes tracker displays produced when the test leads are connected to (or

across) circuits containing the following devices: NPN and PNP transistors, Darlington pairs, germanium transistors, MOSFET's, J FET's, and unijunction transistors.

#### Section 5 - PASSIVE COMPONENTS

This section describes and illustrates tracker displays produced when the test leads are connected to capacitive, inductive, and resistive circuits or devices.

#### Section 6 - TESTING MULTIPLE COMPONENT CIRCUITS

This section covers the testing of diode/resistor combinations, diode/capacitor combinations, and capacitor/resistor combinations.

#### Section 7 - TESTING INTEGRATED CIRCUITS

This section discusses integrated circuit technology followed by testing information for linear devices such as operational amplifiers and voltage regulators. Testing information is also provided for the LM555 Timer as well as TTL, LS TTL, and CMOS devices.

#### Section 8 - TESTING RECTIFIERS

This section describes the testing of silicon-controlled rectifiers and TRIAC devices.

#### Section 9 - TESTING POWER SUPPLIES

This describes how to use the tracker to test the typical transformer/full-wave bridge type power supply.

#### Section 10 - TESTING COMPONENTS BY COMPARISON

This section provides tracker displays for defective components as compared to known good devices. The tracker is used in the alternate mode to check a high voltage transistor, a high voltage diode, an electrolytic capacitor, an op-amp, and a regulator.

**SECTION 11 - SOLVING BUS PROBLEMS**

This section contains information that may be helpful when attempting to isolate faults caused by defective devices connected to a common bus.

**SECTION 12 - TROUBLESHOOTING TIPS**

This section contains a series of troubleshooting suggestions and information that should assist the user when using the tracker.

Table 1-1. Specifications

<b>TEST SIGNAL DATA</b>	
Waveform Type .....	sinusoidal
Frequency .....	80Hz
<b>Voltage/Current Characteristics - Low Range</b>	
Open Circuit Voltage (peak-to-peak) .....	20
Short Circuit Current (mA rms) .....	64
Power (mW rms) .....	81
Power (mW peak) .....	161
Short Circuit Current (mA peak) .....	170
<b>Voltage/Current Characteristics - Medium Range</b>	
Open Circuit Voltage (peak-to-peak) .....	40
Short Circuit Current (mA rms) .....	0.27
Power (mW rms) .....	0.23
Power (mW peak) .....	0.45
Short Circuit Current (mA peak) .....	0.7
<b>Voltage/Current Characteristics - High Range</b>	
Open Circuit Voltage (peak-to-peak) .....	120
Short Circuit Current (mA rms) .....	0.29
Power (mW rms) .....	0.26
Power (mW peak) .....	0.52
Short Circuit Current (mA peak) .....	0.8
NOTE: All power ratings are conditions existing across a single silicon diode in the test terminals of the tracker.	
CRT SCREEN SIZE .....	7cm diagonal
CRT ACCELERATION POTENTIAL .....	1350V regulated
<b>INPUT PROTECTION</b>	
Protection provided against damage caused by touching probes to line voltages.	
<b>TRACE ALTERNATE MODE</b>	
Alternates display between channel A and B inputs at 0.8Hz rate	
<b>POWER REQUIREMENTS</b>	
HTR 1005B-1S .....	117V, 60Hz
HTR 1005B-1ES 220/240V, 50/60Hz	
HTR 1005B-1JS 100V, 50/60Hz	
WEIGHT .....	5 pounds, 5 ounces (2.4 kg)
DIMENSIONS (inches) .....	8-3/4 W x 3-1/2 H x 11-1/2 D (21.9 cm x 7.4 cm x 24.2 cm)
<b>AMBIENT TEMPERATURE</b>	
Operating .....	zero to +50 degrees Celsius
Storage .....	-50 to +60 degrees Celsius
<b>SHOCK AND VIBRATION</b>	
Will withstand shock and vibration encountered in commercial shipping and handling	

## 1.2 TRACKER DESCRIPTION

The tracker is a general purpose troubleshooting test instrument. It qualitatively evaluates digital, analog, and hybrid semiconductor devices, as well as capacitive and inductive devices, in or out of circuit, in a power off state. The tracker operates by providing an ac stimulus to the component or circuit under test and displaying the resultant current and voltage levels and their phase relationship. The tracker display indicates any component leakage, shorts, opens, noise, plus any combination of these problems. Table 1-1 lists the specifications of the tracker.

Included with each tracker is a set of Huntron Micro Probe test leads. These test leads plug into the front panel test jacks of the tracker and have special tips that allow contact with very small component terminals and printed circuit board traces without the danger of touching adjacent component leads and terminals.

Also included with the tracker is a special common test lead that allows the connection of tracker common to two components. This test lead is used in the alternate mode of operation.

## 1.3 PRINCIPLES OF TRACKER OPERATION

### 1.3.1 Tracker Test Signal

The tracker applies an 80Hz sinewave test signal across two terminals (or nodes) of a device to be tested. The test signal

causes current to flow through the device and a voltage drop to appear across it. The current flow through the device causes vertical deflection of the tracker display while the voltage drop across the device causes horizontal deflection of the tracker display.

The test signal is selected for application to a device or circuit under test in one of three available ranges: low, medium, and high. The open-circuit voltage values for each range are listed in Table 1-1. Note that current-limiting is provided on each range for complete protection of the device or circuit under test.

### 1.3.2 Horizontal and Vertical Deflection of the Display

The test signal output of the tracker causes current flow through the device under test and a voltage drop across it. Vertical deflection above the center line of the graticule indicates the amount of current flow when the test signal is on a positive half-cycle. Vertical deflection below the center line indicates the amount of current flow when the test signal is on the negative half-cycle.

The voltage drop across the device causes horizontal deflection of the tracker display; the greater the voltage drop, the greater the deflection on the display. Horizontal deflection to the right of the center line indicates the amount of voltage drop when the test signal is on a negative half-cycle. Horizontal deflection to the left of the center line indicates the amount of voltage drop when the test signal is on the positive half-cycle.

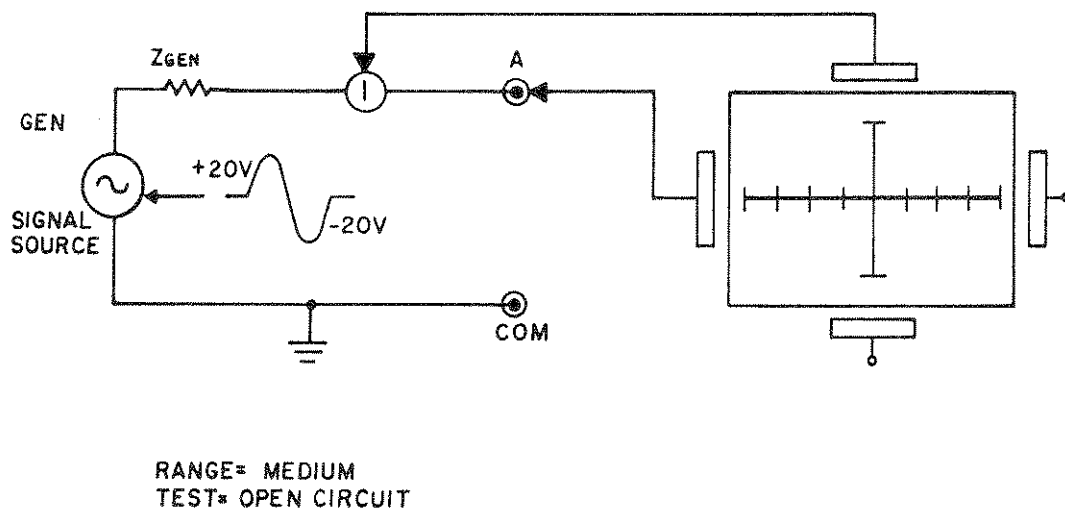

Figure 1-1. Electrical Equivalent of the Test Signal Generator

Figure 1-1 shows the electrical equivalent of the test signal generator within the tracker and how the current through and voltage drop across the test terminals provide vertical and horizontal deflection of the display. The 80Hz test signal is provided by the signal generator and its series impedance ( $Z_{gen}$ ). All current that passes through the test terminals to the device under test, also passes through a current sensing point (I). The vertical deflection plates receive deflection voltage from this current sensing point. The amount of deflection voltage provided to the vertical deflection plates is proportional to the amount of current flowing through the device under test.

The voltage appearing across the test terminals (and the device under test) is also applied across the horizontal deflection plates. The amount of voltage provided to the horizontal deflection plates is proportional to the voltage drop across the device under test.

### 1.3.3 Short and Open Circuit Displays

An open circuit, such as the test leads unconnected, causes zero current flow through and maximum voltage drop across the test terminals. This condition causes the displays shown in Figure 1-2 for the three operating ranges. In the high and medium ranges the zero current and maximum voltage is represented by a straight horizontal trace from the far left to the far right of the display. In the low range, the tracker is designed to produce a diagonal trace for an open circuit condition.

A short circuit (e.g., the test leads shorted together) causes maximum current flow through and zero voltage drop across the test terminals. This condition causes the displays shown in Figure 1-3 for the three operating ranges. In all ranges the zero voltage and maximum current is represented by a straight vertical trace from the top to the bottom of the display.

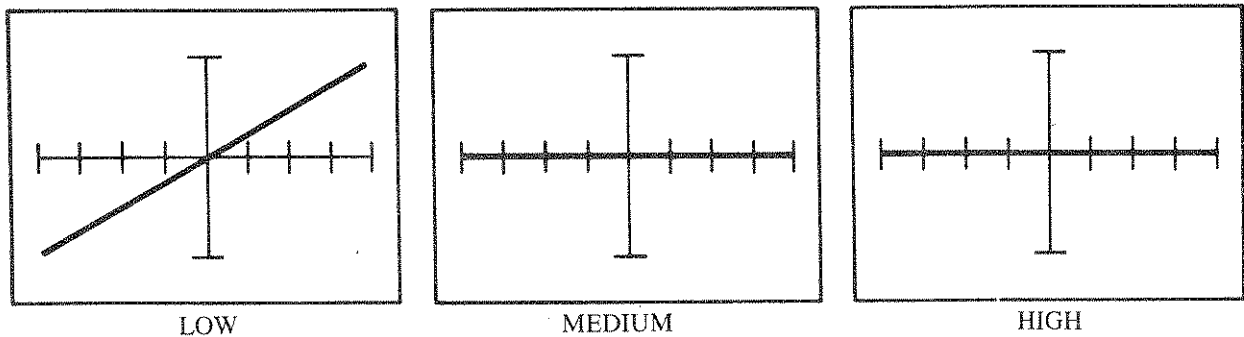

Figure 1-2. Open Circuit Displays

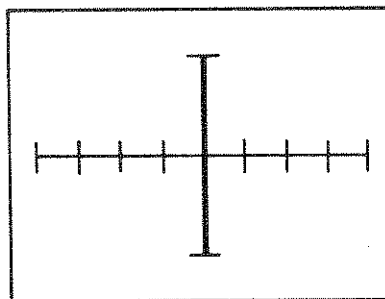

Figure 1-3. Short Circuit Display for all Ranges



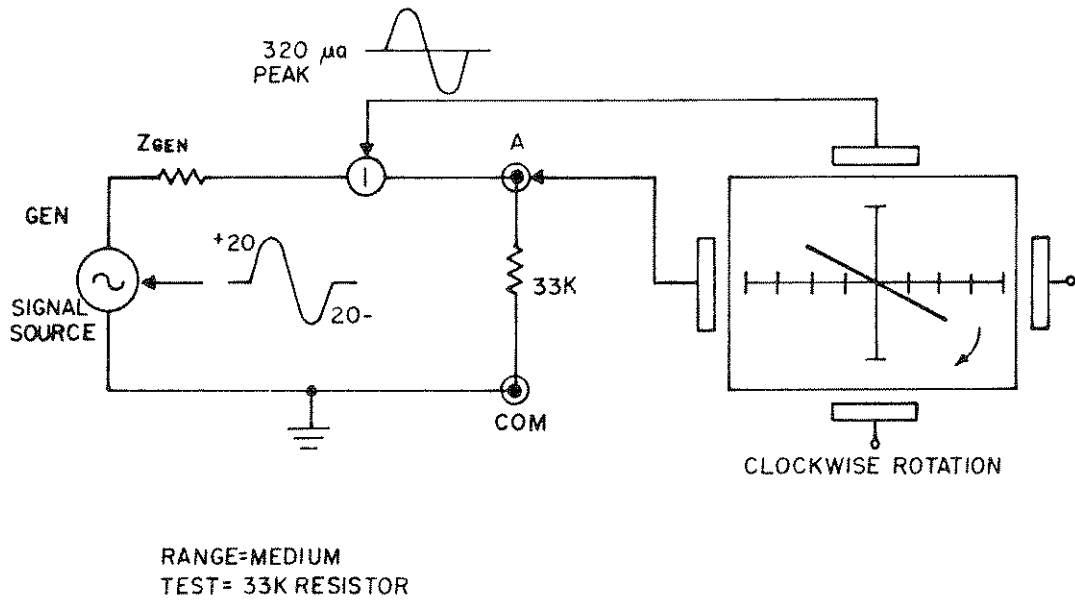

Figure 1-4. Pure Resistance Display

A pure resistance connected across the test leads would cause both current flow and voltage drop, resulting in a deflected straight trace on the tracker display. On the high and medium ranges, the trace would be deflected clockwise around the center of the display from the horizontal (open circuit) position, while on the low range it would be deflected clockwise from the open circuit diagonal position. On all ranges, the length of the trace is reduced due to the internal impedance of ( $Z_{gen}$ ) the test signal generator. The amount of trace reduction and rotation depends on the test resistance value and the range chosen for the test. Figure 1-4 shows the typical effect of resistance on the tracker display.

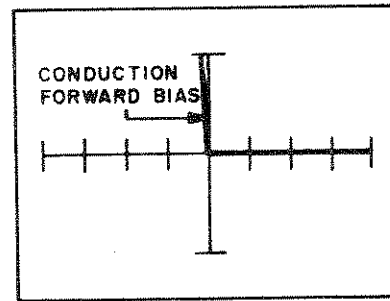

Figure 1-5. Trace of a Silicon Diode. Medium/High Range

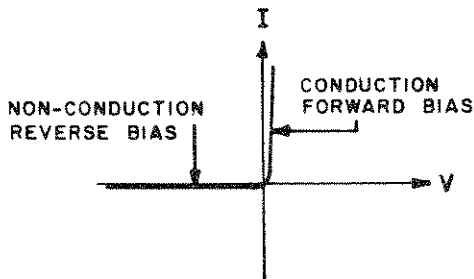

Figure 1-6. Voltage-to-Current Characteristic of a Diode

Since a pure resistance is electrically linear, the resulting trace will always be a straight line. However, non-linear electrical devices do not produce a straight line over the entire length of the trace. A non-linear component such as a silicon diode allows a large amount of current to flow during the half cycle of the test signal when it is forward-biased, and only a minute amount of current to flow during the half cycle when it is reverse-biased. The voltage drop across the diode junction is small when forward-biased (short circuit), and near maximum when reversed biased (open circuit). Figure 1-5 shows the trace produced by the tracker when connected across a silicon diode. Figure 1-6 shows the typical voltage-to-current characteristic of the same diode. Note that the trace produced by the tracker is a near mirror-image of the voltage-to-current characteristic.

**NOTES:**

# SECTION 2

## TRACKER OPERATION

### 2.1 GENERAL

Components are tested by the tracker using a two terminal system, where two test leads are placed across the component under test. All testing is performed under power-off conditions for the component/equipment under test. The tracker tests components while in-circuit, even when bridged by other components. Included with each tracker is a set of Huntron Micro Probe test leads. Also included with the tracker is a special common test lead that allows the connection of tracker common to two components. This test lead is used in the alternate mode of operation.

### 2.2 CONTROLS AND INDICATORS

Operation of the tracker, for the mostpart, amounts to determining the significance of the trace(s) appearing on the display. While the tracker is equipped with several front panel controls to assist in optimizing displays, only limited use of these controls is necessary to during actual use of the tracker. Table 2-1 lists and describes the front panel controls, and Figure 2-1 shows the control, although the main emphasis on tracker operation is on the determination of tracker displays. For this reason, the majority of information contained in this document is relative to tracker displays.

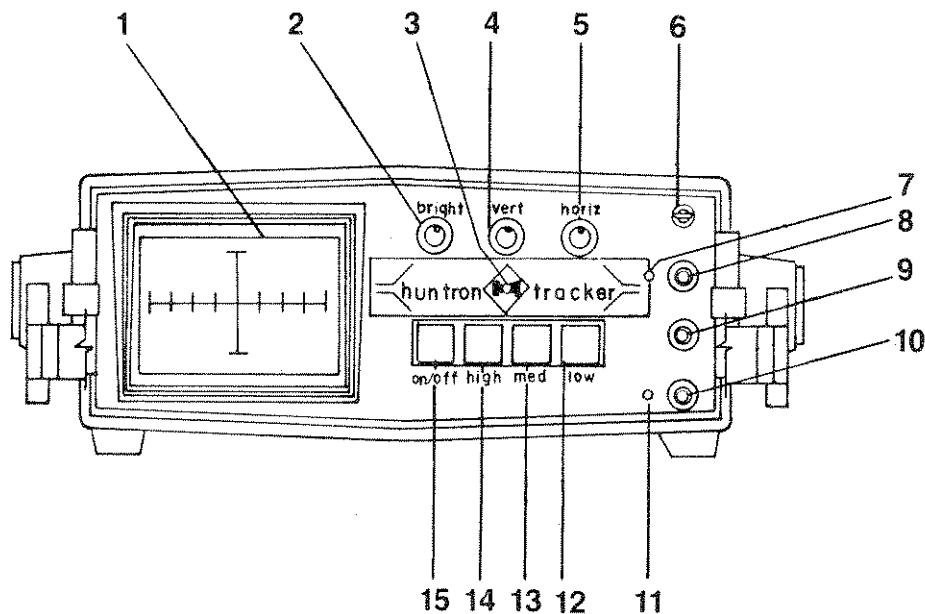

Figure 2-1. Location of Front Panel Controls

Table 2-1. Front Panel Controls and Indicators

FIG. 2-1 ITEM NO.	NOMENCLATURE	DESCRIPTION
1	Display	The tracker display is a CRT (cathode ray tube), and is used to present all component/circuit indications to the operator. All tracker display illustrations contained in this document are representative of the displays generated on this CRT.
2	Bright Control	The brightness control adjusts the intensity of the traces appearing on the CRT display.
3	Power-On Indicator	The power-on LED lights when ac power is applied to the unit.
4	vert Control	The vertical control permits vertical adjustment of the trace appearing on the CRT display. To center the trace, adjust this control with the test leads in an open condition with the high or medium range selected.
5	horiz Control	The horizontal control permits horizontal adjustment of the trace appearing on the CRT display. To center the trace, adjust this control with the test leads in a shorted condition.
6	Channel Selection Switch	This three-position switch allows the selection of the channel A, channel B, or alternate mode. When in the upper position, the channel A input is selected; when in the lower position, the channel B input is selected; and when the center position, the alternate mode is selected. Refer also to Alternate Mode Operation.
7	Channel A Indicator	The channel A indicator lights when the channel selection switch is in the upper position to indicate that the channel A input is displayed on the CRT.
8	Channel A Input	This input makes connection to channel A of the tracker.
9	Common Input	This input makes connection to internal common of the tracker.
10	Channel B Input	This input makes connection to channel B of the tracker.
11	Channel B Indicator	The channel B indicator lights when the channel selection switch is in the upper position to indicate that the channel B input is displayed on the CRT.
12	low Range Switch	This pushbutton switch selects a 20V peak-to-peak sinewave test signal at the test lead tips.
13	med Range Switch	This pushbutton switch selects a 40V peak-to-peak sinewave test signal at the test lead tips.
14	high Range Switch	This pushbutton switch selects a 120V peak-to-peak sinewave test signal at the test lead tips.
15	on/off Switch	This pushbutton switch applies power to and removes power from the tracker.

## 2.3 ALTERNATE MODE OPERATION

The tracker can alternate automatically between the displays of the channel A and channel B inputs. This allows the user to directly compare the display of the suspect circuit to that of a known good circuit for quality assurance operations, or for troubleshooting purposes. Figure 2-2 shows how a tracker is connected to compare a known good board with a board under test. This testing mode utilizes the dual common test lead supplied with the unit and alternates between the channels at a 0.8 Hz rate.

**CAUTION: THE SYSTEM TO BE CHECKED MUST HAVE POWER TURNED OFF, AND HAVE ALL HIGH VOLTAGE CAPACITORS FULLY DISCHARGED BEFORE CONNECTING THE TRACKER**

## 2.4 FUSE REPLACEMENT

The tracker contains a 0.25 ampere fuse (F1) connected in series with the channel A and B input leads. Accidental contact of the leads to charged capacitors or other voltage sources, will blow this fuse, making replacement necessary. When F1 fails it will not be possible to deflect the pattern on the CRT from a horizontal or diagonal line.

**WARNING: REPLACEMENT OF THE FUSE SHOULD BE PERFORMED BY QUALIFIED SERVICE PERSONNEL ONLY.**

To replace the fuse, disconnect the tracker from the ac power source. Remove the four cover retaining screws located on the bottom of the unit. Holding the tracker in an upright position, lift off the top cover to expose the interior of the unit. Locate F1 on the main printed circuit board assembly immediately behind the power switch, and replace with a 0.25A, 250V, type AGX.

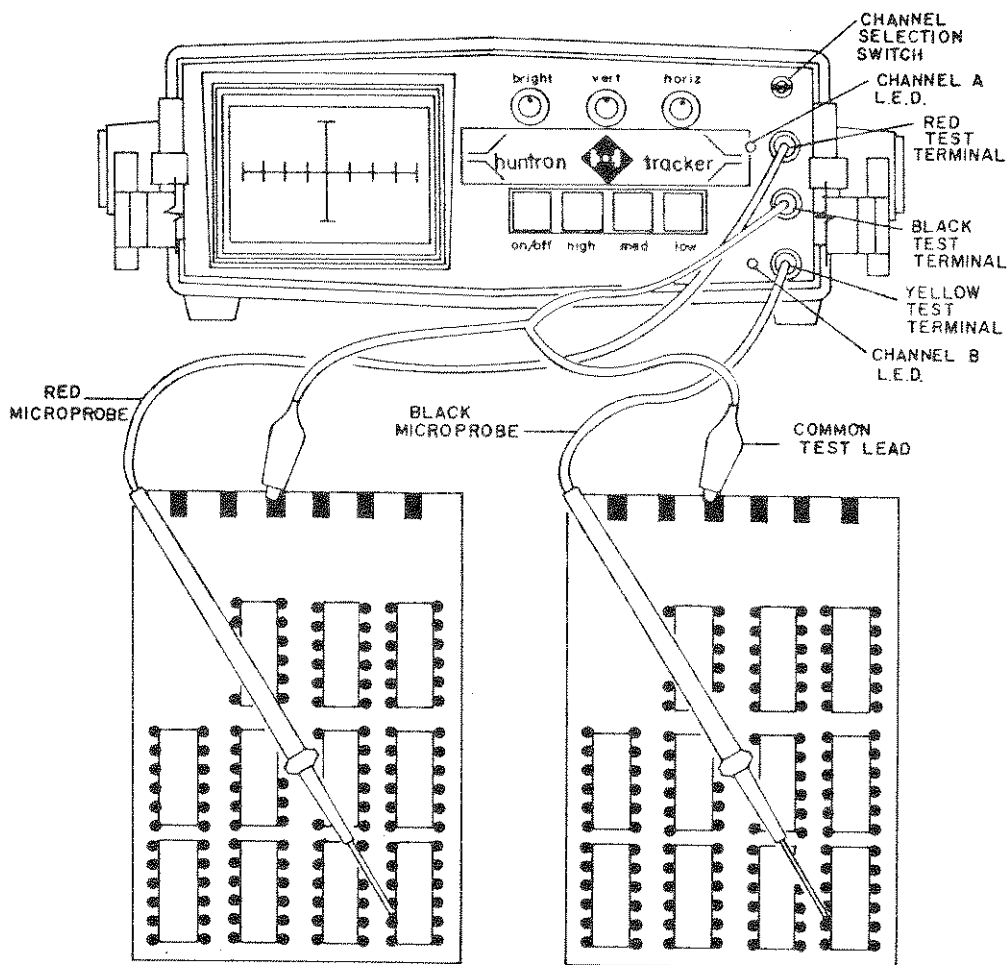

Figure 2-2. Comparing a Known Good Board With a Defective Board

**NOTES:**



# SECTION 3

## TESTING DIODES

### 3.1 THE SEMICONDUCTOR DIODE AND ITS CHARACTERISTICS

#### 3.1.1 Diode Symbol and Definition

A semiconductor diode is formed into a diode by the creation of a junction between P-material and N-material within a crystal during the process of manufacture. The standard semiconductor diode has in its symbol, an arrow to indicate the direction of forward current flow, as shown in Figure 3-1.

With positive voltage applied to the P-junction and negative voltage applied to the N-junction, the diode is said to be forward biased, as shown in Figure 3-2. The current ( $I_f$ ) increases rapidly with small increases in applied voltage ( $V$ ).

When the applied voltage is reversed, the P-junction is negative with respect to the N-junction, and very small levels of current flow through the diode. Figure 3-3 shows the P-N junction in the reverse bias mode. The small current ( $I_o$ ) is the diode "reverse saturation current", and its magnitude increases with temperature. In practice,  $I_o$  can be ignored.

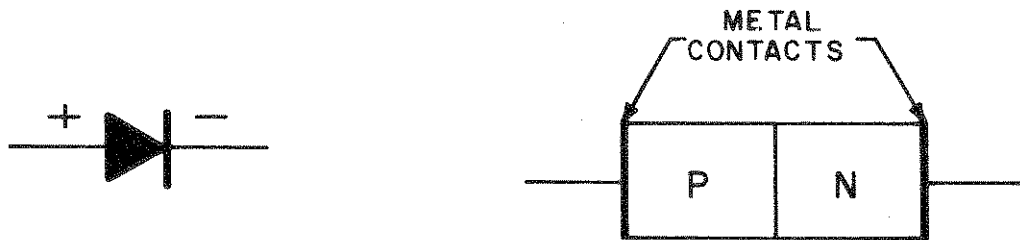

Figure 3-1. Diode Symbol

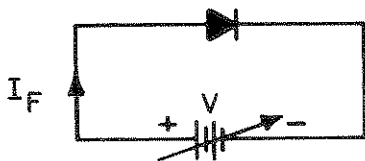

Figure 3-2. P-N Junction Biased in the Forward Direction

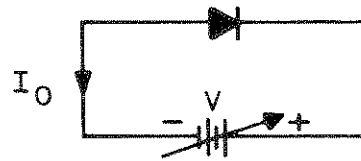

Figure 3-3. P-N Junction Biased in the Reverse Direction

### 3.1.2 The Volt-Ampere Characteristic

For a P-N junction, the current (I) is related to the voltage (V) by the following equation:

$$I = I_0(\exp kV - 1)$$

Where k is a constant depending on the temperature and material. The volt-ampere characteristic described by the equation above is shown in Figure 3-4. For the sake of clarity, the current ( $I_0$ ) has been greatly exaggerated in magnitude. The dashed portion of the curve of Figure 3-4 indicates that, at a certain reverse voltage ( $V_{BR}$ ), the diode characteristic exhibits an abrupt and marked departure from the equation above. At this critical voltage, a large reverse current flows and the diode is said to be in the "breakdown region".

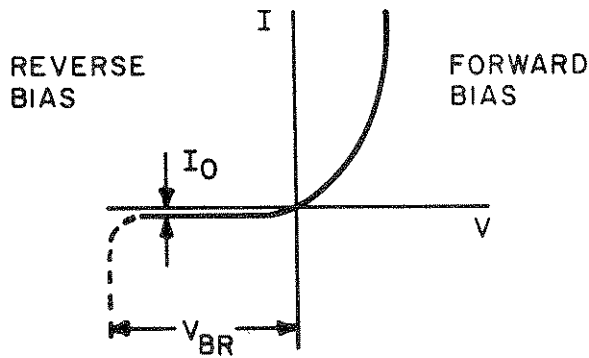

Figure 3-4. The Volt-Ampere Characteristic of a Semiconductor Diode

### 3.2 SILICON RECTIFIER DIODES

#### 3.2.1 Patterns of a Good Diode

A good diode has very large reverse-biased resistance and small forward-biased resistance. The forward junction voltage drop ( $V_f$ ) is between 0.5 volts and 2.8 volts, depending on the semi-conductor material; for example,  $V_f$  for a silicon diode is 0.6 volts; and for a typical light-emitting diode, is 1.5 volts. The tracker can visually display all these parameters.

Figure 3-5 shows the tracker-diode connections for diode testing. Figure 3-6 shows typical patterns (low, medium, and high ranges) and waveforms, plus the circuit equivalent, for a good silicon diode (1N4001). The forward junction voltage drop of a diode can be determined (approximately) from low range display.

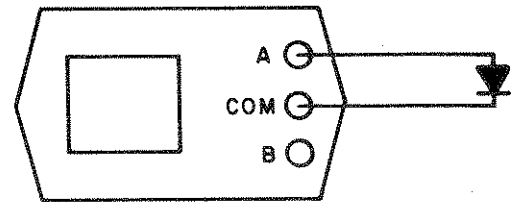

Figure 3-5. Tracker Test Circuit

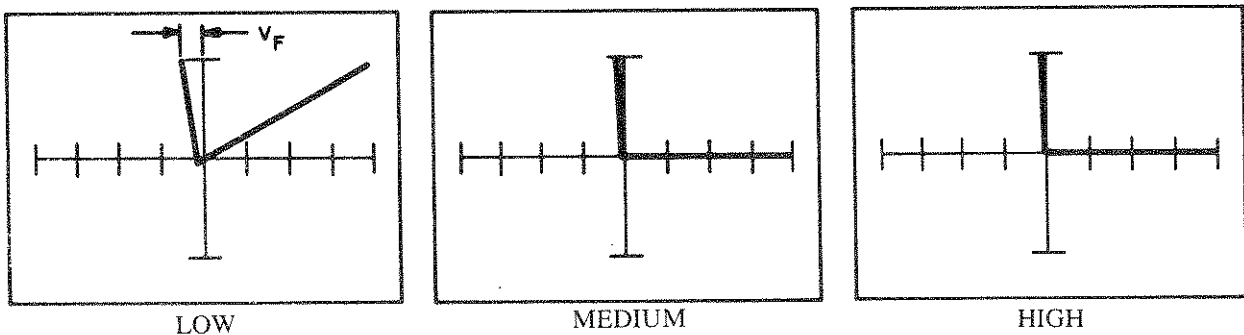
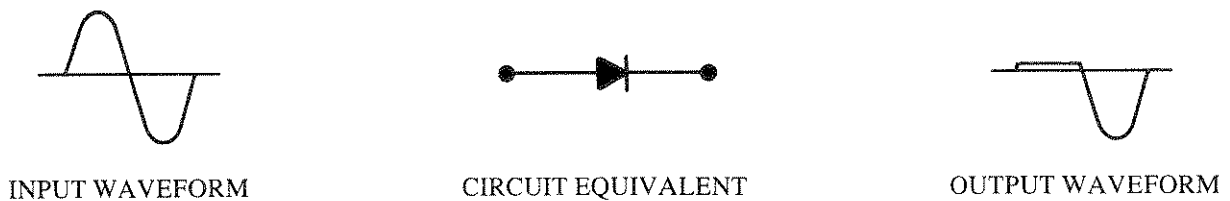

Figure 3-6. Waveforms and Typical Patterns - Good Silicon Diode



### 3.2.2 Patterns of Defective Diodes

A rectifier diode is defective if it is open, is shorted (low impedance), contains high internal impedance, or contains leakage. Figure 3-7 shows the patterns of an "open" diode in the low, medium, and high ranges.

The tracker is capable, in the low range, of detecting resistance higher than one ohm, and this resistance causes the vertical line to rotate in a counterclockwise direction. The angle of rotation is a function of the resistance. Figure 3-8 shows the effect of circuit resistances on the trace rotation while in the low range. This small short-circuit resistance does not cause rotation in the medium and high ranges of the tracker.

Figure 3-9 shows the waveforms, circuit equivalent and waveforms of a diode that exhibits a non-linear resistance in

series with the diode junction. This resistance effects the ability of the diode to turn-on at the proper voltage.

Figure 3-10 shows the waveforms, circuit equivalent and waveforms of a diode that exhibits a non-linear resistance in parallel with the diode junction (leaky) when reverse-biased. This resistance effects the ability of the diode to provide maximum output for a given input.

### 3.3 HIGH VOLTAGE SILICON DIODES

High voltage diodes are tested in the same manner as that described for rectifier in section 3.2. High voltage diodes, such as the HV15F, display higher forward voltage drop ( $V_f$ ) than the rectifier diodes described in section 3.2. Figure 3-11 shows the patterns of the HV15F high voltage diode. The  $V_f$  for the high voltage diode is higher on all tracker ranges than that of a regular diode.

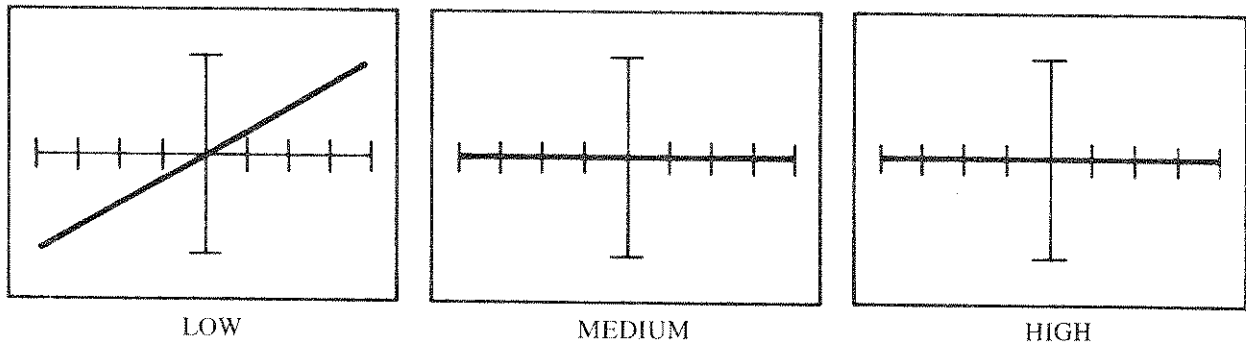

Figure 3-7. Patterns of an Open Diode

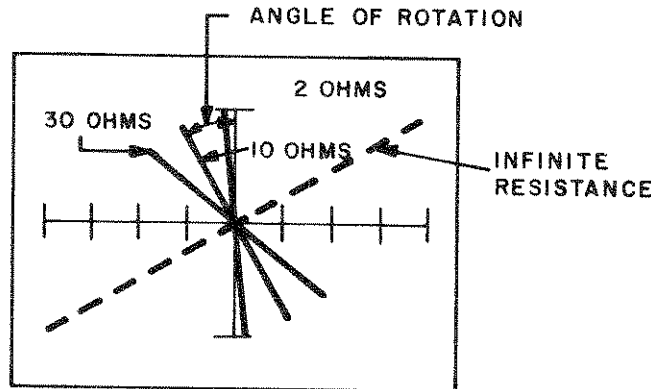

Figure 3-8. The Effect of Diode Short-Circuit Resistance - Low Range

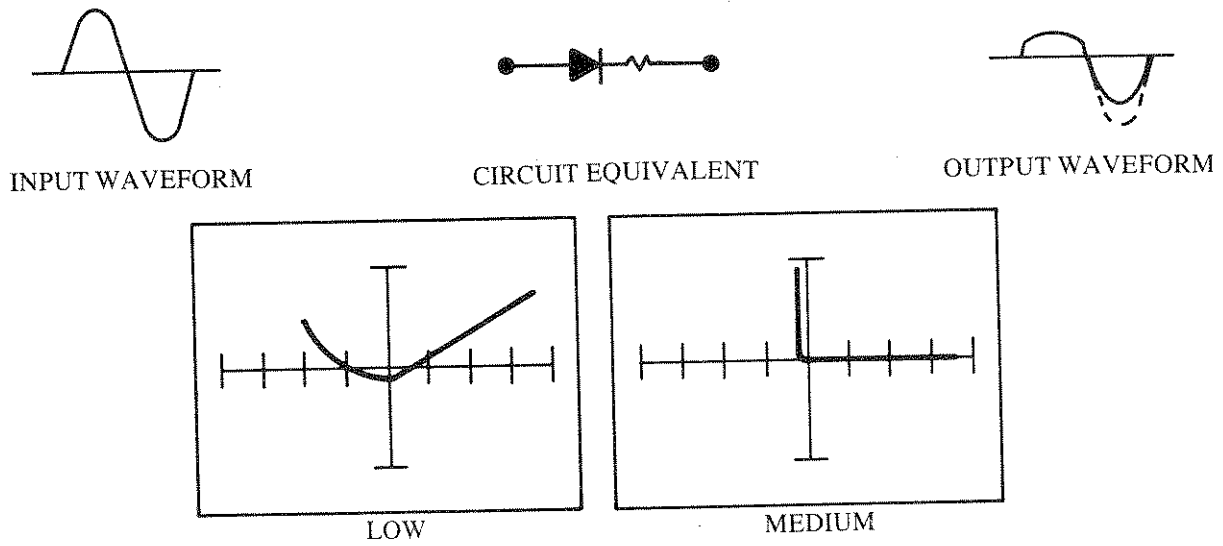

Figure 3-9. Waveforms and Typical Patterns - High Impedance Diode

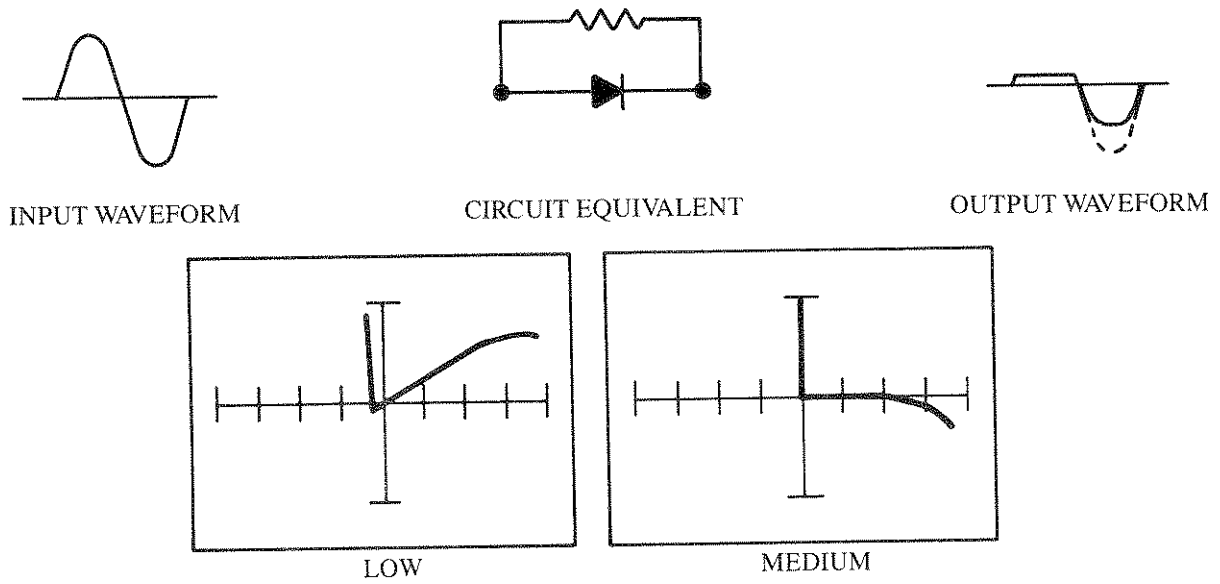

Figure 3-10. Waveforms and Typical Patterns - Leaky Diode

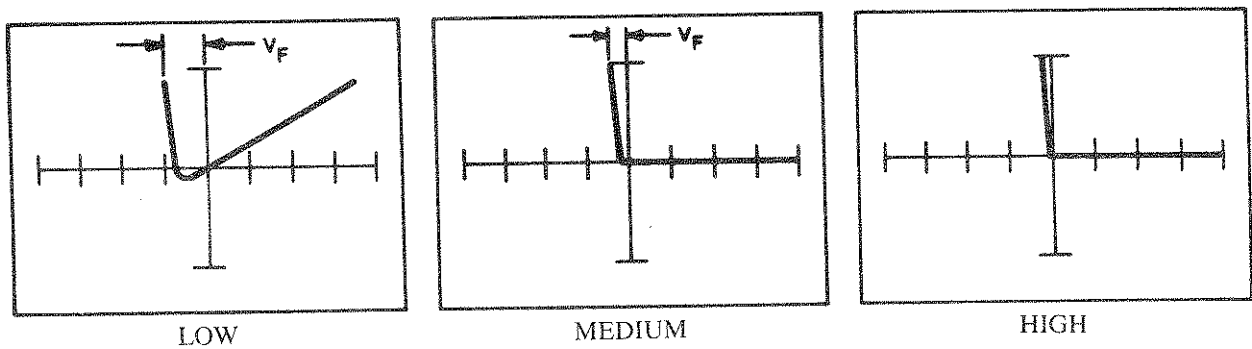

Figure 3-11. Pattern of a High Voltage Diode, HV15F

### 3.4 RECTIFIER BRIDGES

A rectifier bridge assembly is made up of four diodes configured as shown in Figure 3-12. Points A and B are ac power input terminals; C and D are the positive and negative output terminals, respectively. To test the bridge, the tracker is connected to terminals A and B as shown in Figure 3-12.

A good bridge appears as an open circuit to the tracker because the diodes are reverse-biased. Figure 3-13 shows the patterns produced by a good bridge with the tracker connected across points A and B. Figure 3-14 shows the patterns produced by a bridge with either diode D2 or D4 shorted:

while Figure 3-15 shows the patterns produced with either diode D1 or D3 shorted.

Figure 3-16 shows the test connections of the tracker to the positive and negative terminals of the rectifier bridge. Tracker channel A is connected to the positive terminal, and tracker common to the negative terminal. Figure 3-17 shows the patterns of a good bridge when connected as shown in Figure 3-16.

Figure 3-18 shows a reversal of the test connections shown in Figure 3-16. Figure 3-19 shows the patterns resulting from the reversal of the test connections to the bridge.

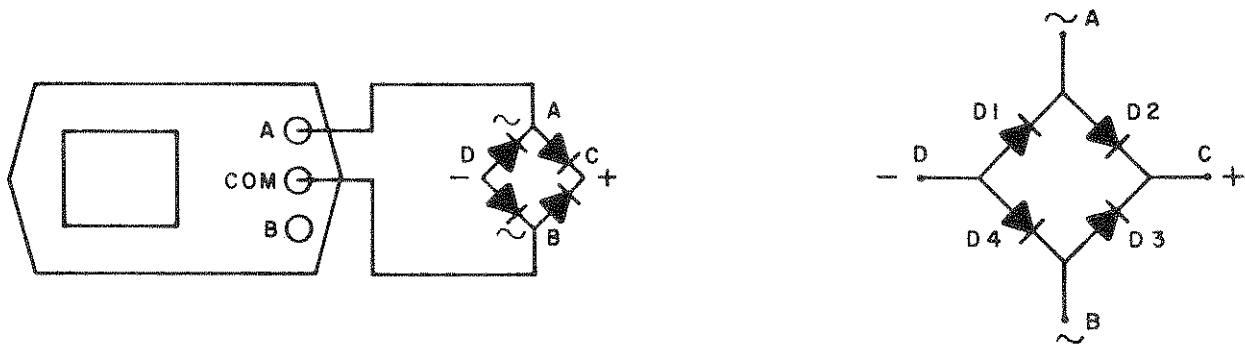

Figure 3-12. Rectifier Bridge Test Connections - AC Input

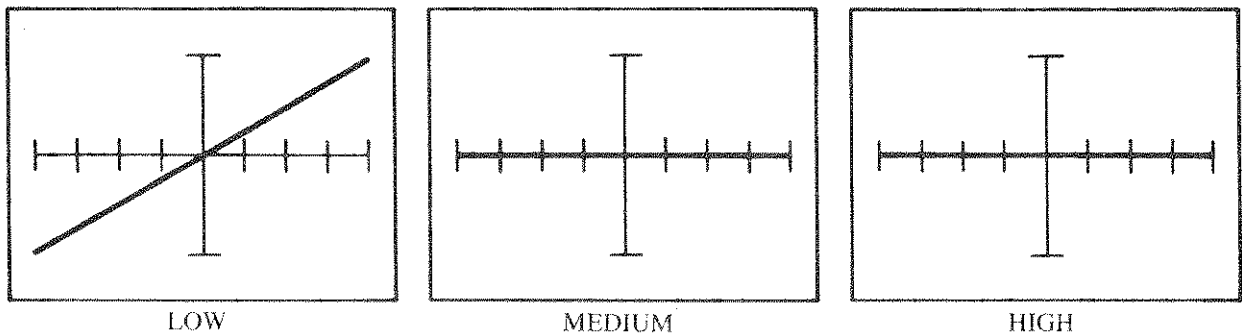

Figure 3-13. Patterns of a Good Rectifier Bridge

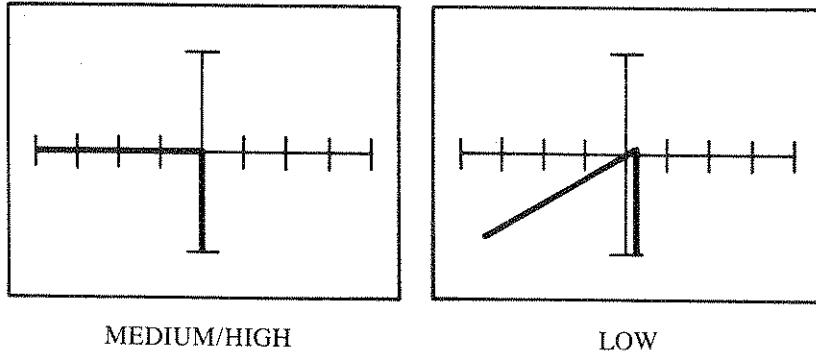

Figure 3-14. Patterns with D2 or D4 Shorted

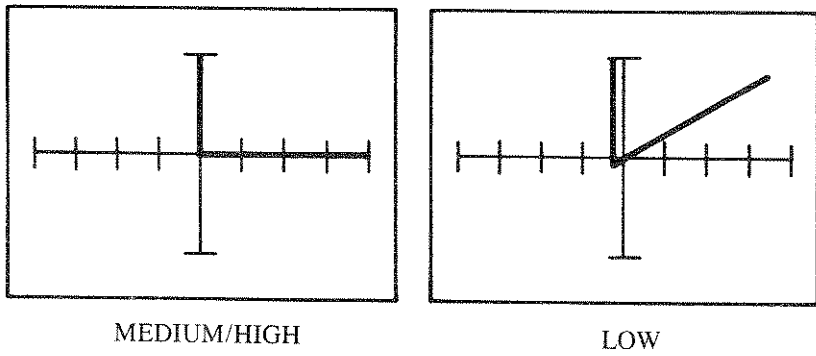

Figure 3-15. Patterns with D1 or D3 Shorted

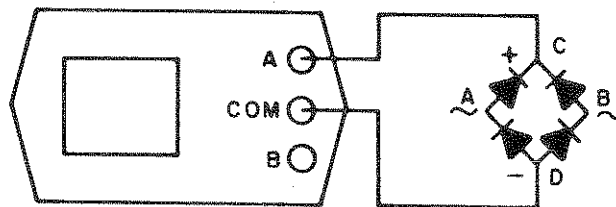

Figure 3-16. Rectifier Bridge Test Connections - DC Output

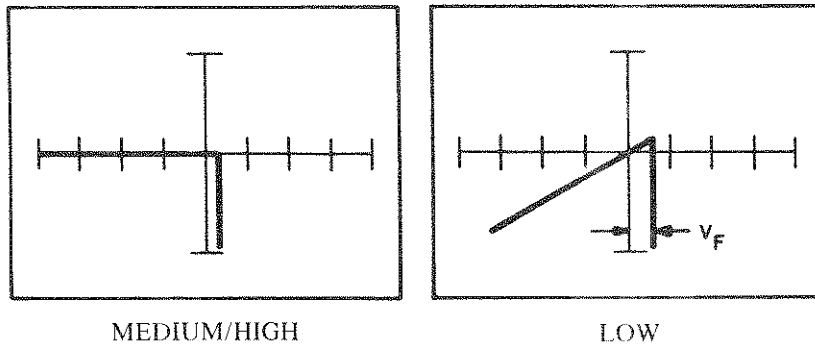

Figure 3-17. Patterns at Output Terminals

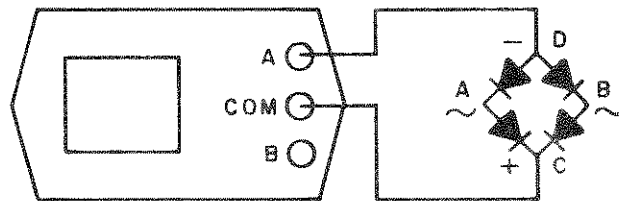

Figure 3-18. Rectifier Bridge, Reversed Test Connections

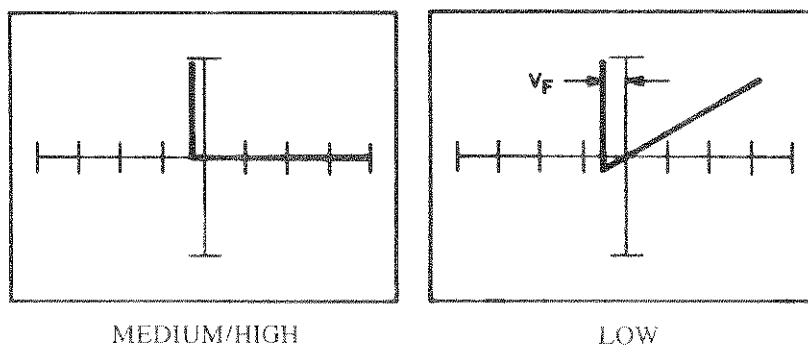

Figure 3-19. Tracker Patterns, Output Terminals Reversed

### 3.5 LIGHT-EMITTING DIODES

Light-emitting diodes (LEDs) may be tested with the tracker by using the low range and connecting the probes across the

LED. A good LED provides an adequate amount of light as a result of the tracker connections. Figure 3-20 shows the patterns for different colored LEDs, each of which exhibit different forward voltages ( $V_f$ ).

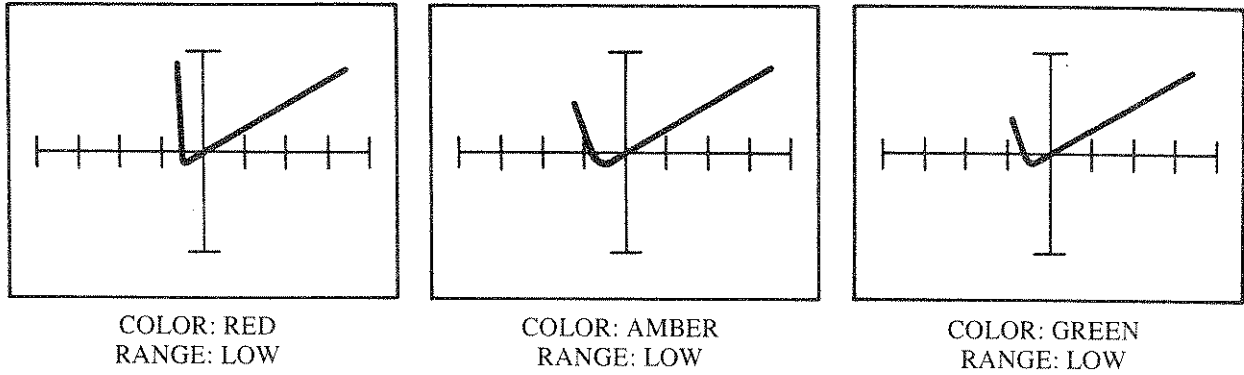

Figure 3-20. LED Patterns

### 3.6 ZENER DIODES

The zener diode is unique among the semiconductor family of devices in that its electrical properties are derived from a rectifying junction which operates in the reverse-breakdown region. Figure 3-21 shows the volt-ampere characteristics of a typical 30-volt zener diode.

Figure 3-21 shows that the zener diode conducts current in both directions, with the forward current being a function of the forward voltage. Note that the forward current is small until the forward voltage is approximately 0.65V, then the forward current increases rapidly. When the forward voltage is greater than 0.65V, the forward current is limited primarily by the circuit resistance external to the diode.

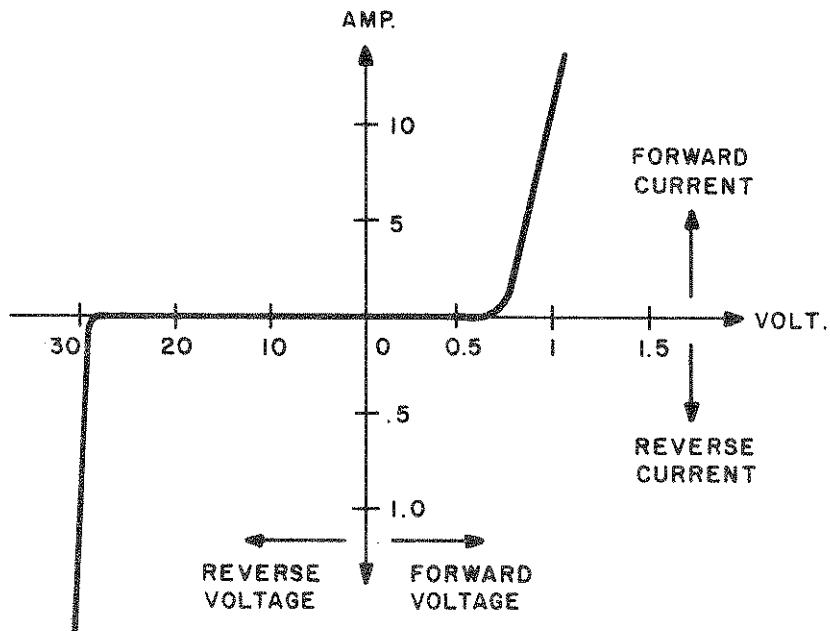

Figure 3-21. Characteristics of a Typical 30V Zener Diode

The reverse current is a function of the reverse voltage and, for most practical purposes, is zero until such time as the reverse voltage equals the PN junction breakdown voltage. At this point, the reverse current increases rapidly. The PN junction breakdown voltage ( $V_Z$ ) is usually called the zener voltage. Commercial zener diodes are available with zener voltages from about 2.4V to 200V. The tracker displays the zener diode breakdown voltage ( $V_Z$ ) on the display.

Figure 3-22 shows the connection of a base-emitter junction (of a NPN transistor) to the tracker. Figure 3-23 shows that the base-emitter junction of a silicon bipolar transistor (a PN2222) exhibits the property of a zener diode. The zener voltage ( $V_Z$ ) can be determined from the trace. In this example,  $V_Z$  is approximately 6.3V (medium range).

A good zener diode gives a sharp, well-defined pattern of zener breakdown voltage, while an inferior zener device gives a pattern with a rounded corner. (Refer to Figures 3-24 and 3-25.)

Figure 3-26 shows the tracker connections to a 1N5242 zener diode, a 12-volt device. Figure 3-27 shows the traces produced by the zener diode.

In the low range, the tracker test signal at the probes is 20 volts peak-to-peak, and is insufficient to cause zener (1N5242) breakdown. As a result, the trace looks identical to that of a general purpose diode such as a 1N4001. However, in the medium range, the tracker test signal is 40 volts peak-to-peak and the zener voltage ( $V_Z$ ) can be seen.

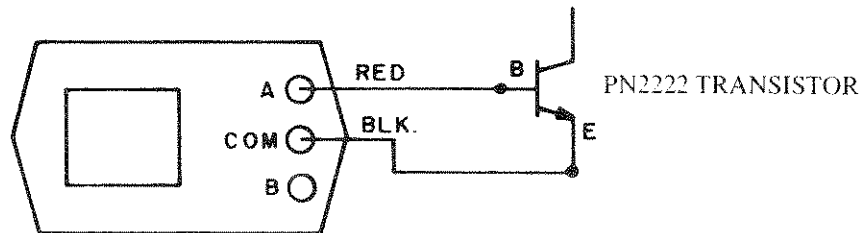

Figure 3-22. NPN Base-Emitter Junction Connections

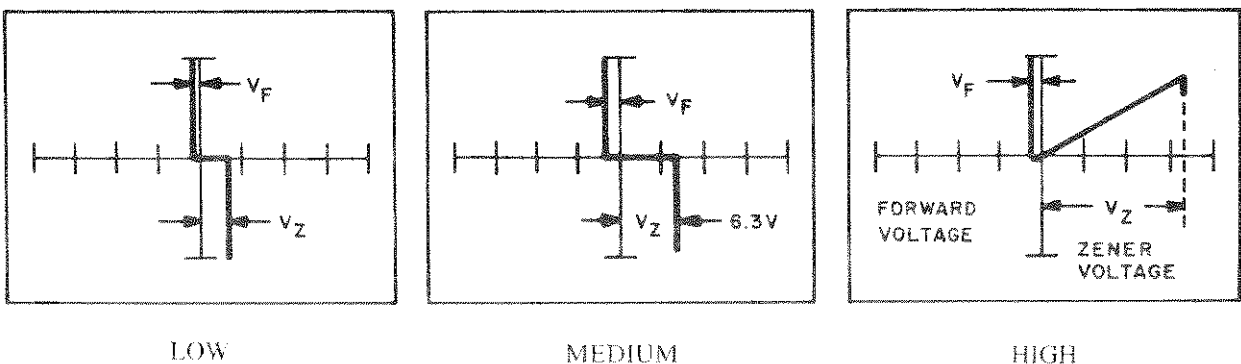

Figure 3-23. Traces of a Silicon Bipolar Transistor, Base-Emitter Junction

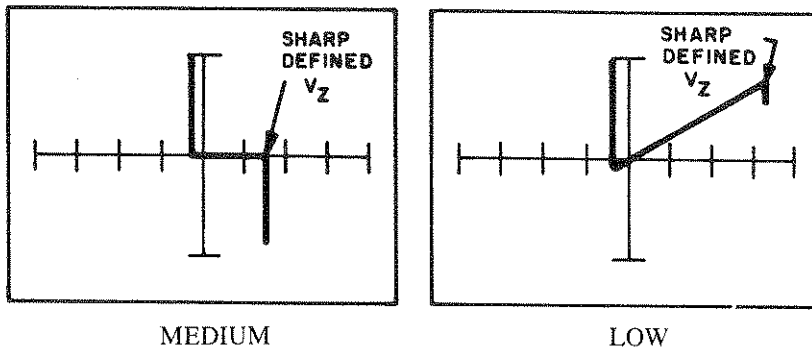

Figure 3-24. Traces of a Good Zener Diode

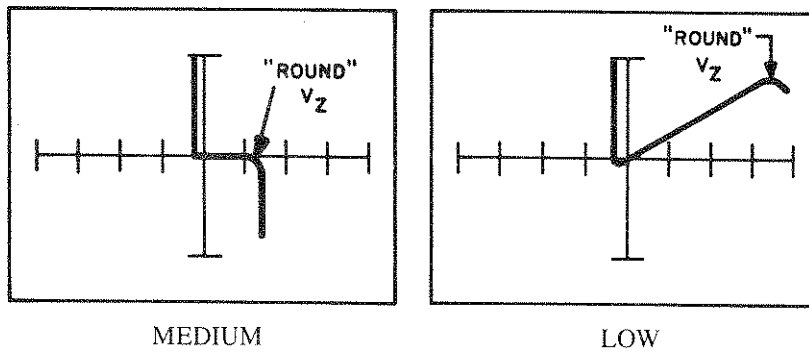

Figure 3-25. Traces of an Inferior Zener Diode

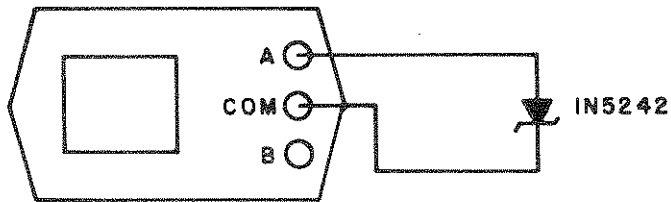

Figure 3-26. Zener Diode Connections

NOTE: NO ZENER VOLTAGE IS DISPLAYED IN THE LOW RANGE

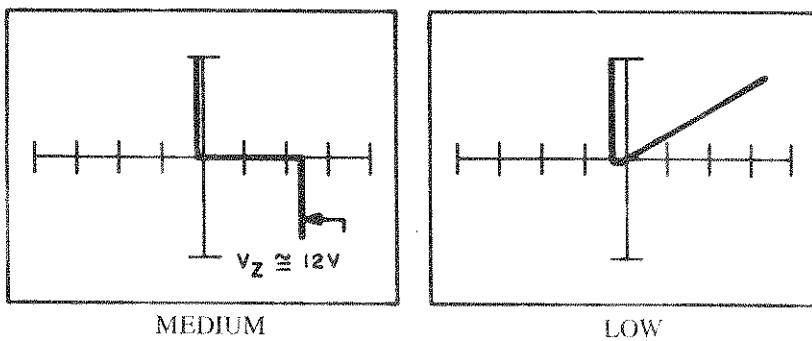

Figure 3-27. Traces of a 1N5242 Zener Diode



# SECTION 4

## TESTING TRANSISTORS

### 4.1 BIPOLAR JUNCTION TRANSISTORS

A bipolar junction transistor consists of a silicon crystal in which a layer of N-type silicon is sandwiched between two layers of P-type silicon. This type of transistor is referred to as a PNP type. Figure 4-1 shows a PNP transistor and its circuit symbol.

A transistor may also consist of a layer of P-type silicon sandwiched between two layers of N-type silicon. This is referred to as an NPN transistor. Figure 4-2 shows an NPN transistor and its circuit symbol.

The three portions of a transistor are known as emitter, base, and collector. The arrow on the emitter lead specifies the direction of current flow when the emitter-base is biased in the forward direction.

### 4.2 NPN BIPOLAR TRANSISTORS

The test signals at the tracker probes are sinusoidal and can be used to forward-bias, as well as reverse-bias, a semiconductor junction. To test a transistor, the base-to-emitter (B-E), collector-to-base (C-B), and collector-to-emitter (C-E) junctions (all) need to be examined.

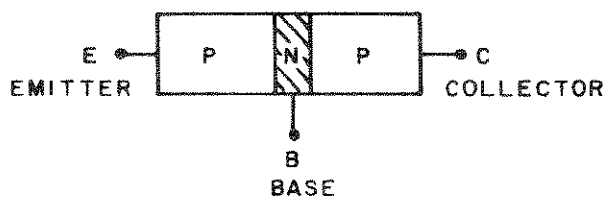

Figure 4-1. PNP Transistor and Circuit Symbol

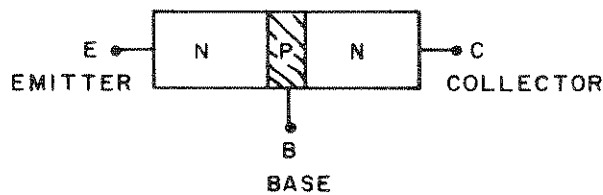

Figure 4-2. NPN Transistor and Circuit Symbol

### 4.2.1 B-E Junction Testing

The B-E junction of a transistor exhibits a zener diode characteristic (i.e., heavy current conduction when the B-E junction is forward-biased, and zener breakdown when it is reversed-biased).  $V_z$  is approximately 6.5 volts. Figure 4-3

shows the connection of the tracker to the B-E junction of a PN2222 transistor. Figure 4-4 shows the patterns produced by the B-E junction in the low and medium ranges.

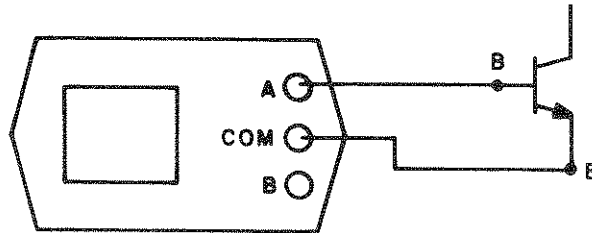

Figure 4-3. Base-Emitter Junction Connections

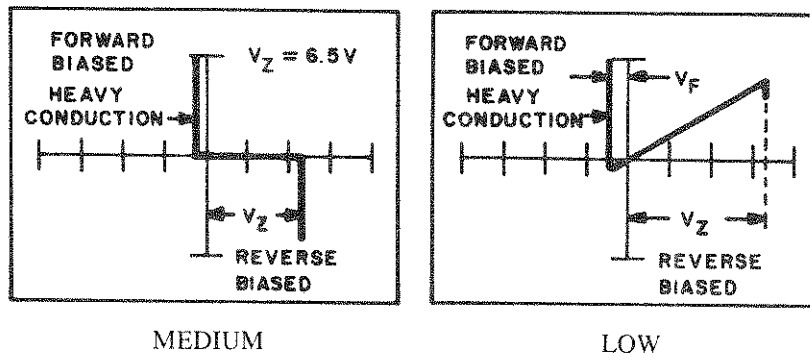

Figure 4-4. Base-Emitter Junction Patterns

### 4.2.2 C-E Connection Testing

For a good transistor, the C-E connection should appear as an open circuit (to the tracker) when the collector voltage is positive with respect to the emitter. When the collector voltage is negative with respect to the emitter, the transistor goes into non-destructive breakdown at  $V_{BR}$ .

Figure 4-5 shows the connection of the tracker to the C and E terminals of a PN2222 transistor. Figure 4-6 shows the patterns produced by the C-E connection in all ranges.

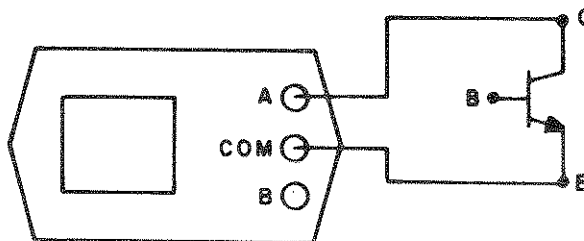

Figure 4-5. Collector-Emitter Connections - PN2222 Transistor

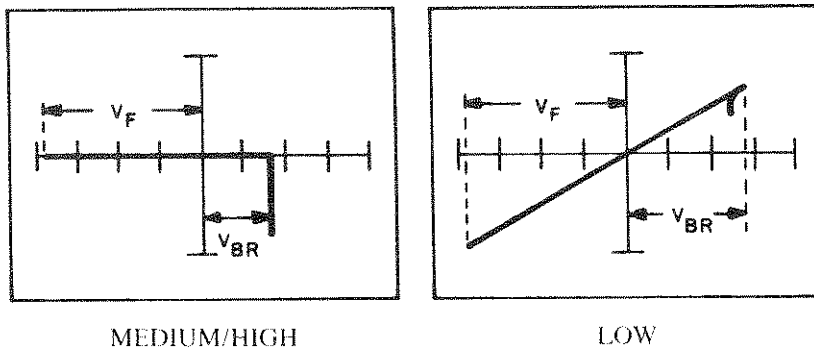

Figure 4-6. Collector-Emitter Connection Patterns - PN2222 Transistor

### 4.2.3 C-B Junction Testing

The pattern of a good C-B junction looks like that of a diode. Figure 4-7 shows the connection of the tracker to the C-B junction of a PN2222 transistor. Figure 4-8 shows the pat-

terns produced by the C-B junction in the low and medium ranges.

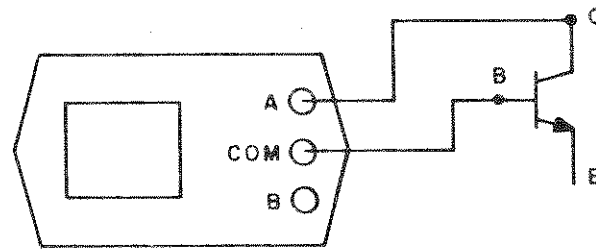

Figure 4-7. Collector-Base Junction Connections

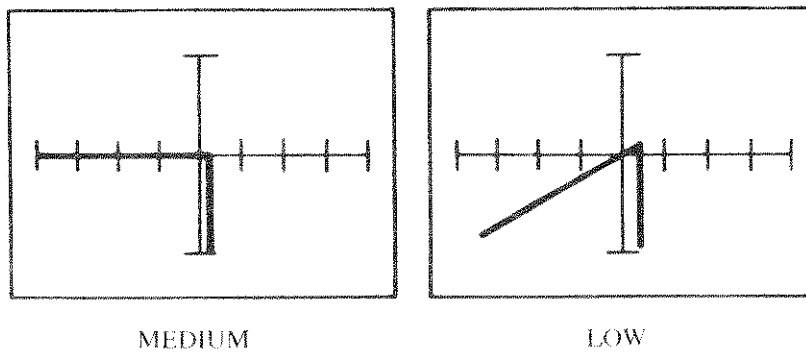

Figure 4-8. Collector-Base Junction Patterns

### 4.3 PNP BIPOLAR TRANSISTORS

The testing of PNP transistors is the same as that described for NPN transistors, except that the patterns are reversed

from their NPN equivalent. Refer to Figures 4-9, 4-10, and 4-11.

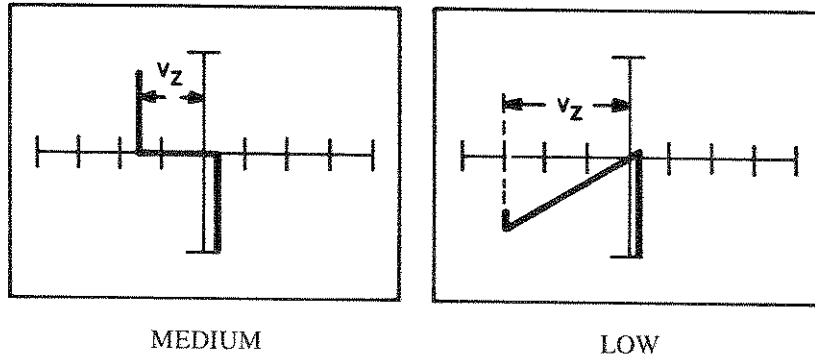

Figure 4-9. Pattern of B-E Connection - MPSA92 Transistor

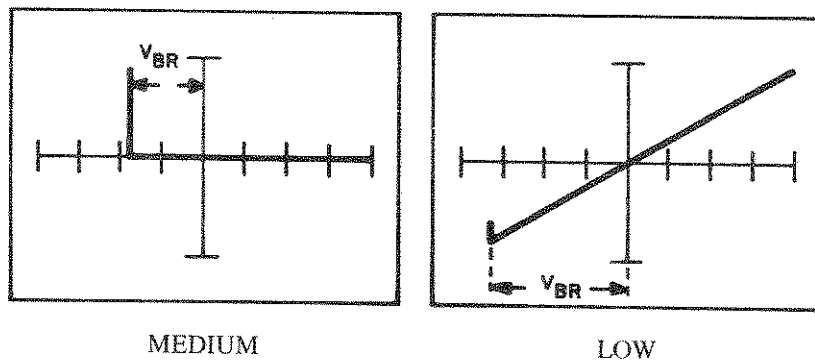

Figure 4-10. Pattern of C-E Connection - MPSA92 Transistor

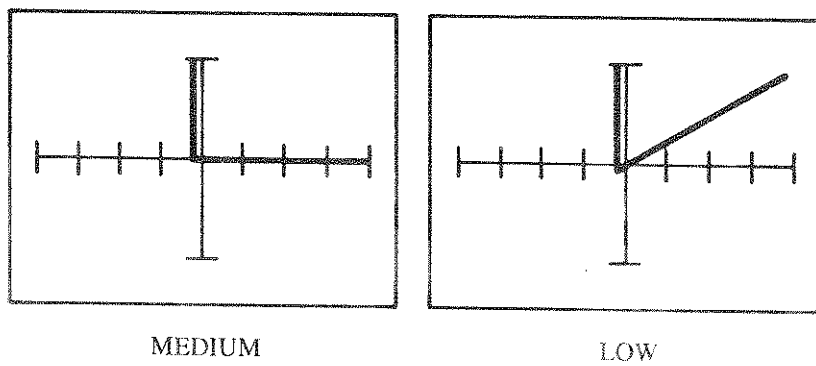

Figure 4-11. Pattern of C-B Connection - MPSA92 Transistor

#### 4.4 POWER TRANSISTORS - NPN AND PNP

Transistor testing procedures described in paragraphs 4.2 and 4.3 are applicable to power transistors. However, some power transistors show capacitance on the pattern in the high

range. Figure 4-12 shows the loop in the pattern caused by capacitance.

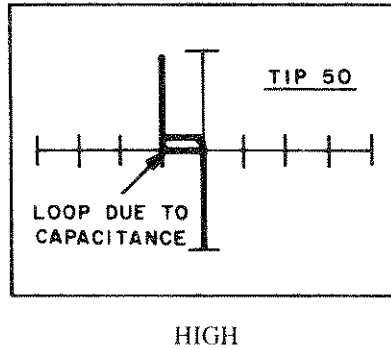

Figure 4-12. Pattern of Power Transistor Showing Capacitance Loop

#### 4.5 DARLINGTON TRANSISTORS

The Darlington transistor is basically two transistors connected to form a composite pair as shown in Figure 4-13. The input resistance of Q2 constitutes the emitter load for Q1.

and PNP bipolar transistors, except that their tracker patterns differ. Figure 4-14 shows the equivalent circuit of a commonly-used Darlington transistor, the TIP-112, and its pin assignments.

Darlington transistors are tested in the same manner as NPN

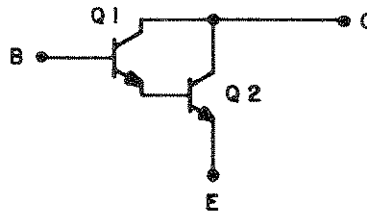

Figure 4-13. Darlington Transistor - Schematic Diagram

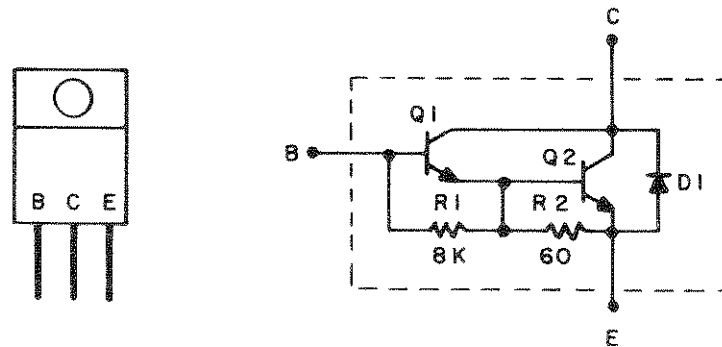

Figure 4-14. The TIP-112 Darlington Transistor

To test the TIP-112, apply the tracker probes to the B and E terminals. The composite effect due to Q1, Q2, R1, R2, and D is displayed by the tracker. Set the tracker to the "alternate" mode and connect the B and E terminals of a regular transistor (a TIP-29) to channel B and common of the tracker. This arrangement allows comparison of a regular transistor (TIP-29) with a Darlington transistor (TIP-112).

Figure 4-15 shows the tracker pattern of a TIP-112 and a TIP-29 at their B-E terminals. The TIP-112 shows a larger voltage drop, which is due to the individual B-E junction of Q1 and Q2 in series. No zener voltage is displayed by the tracker.

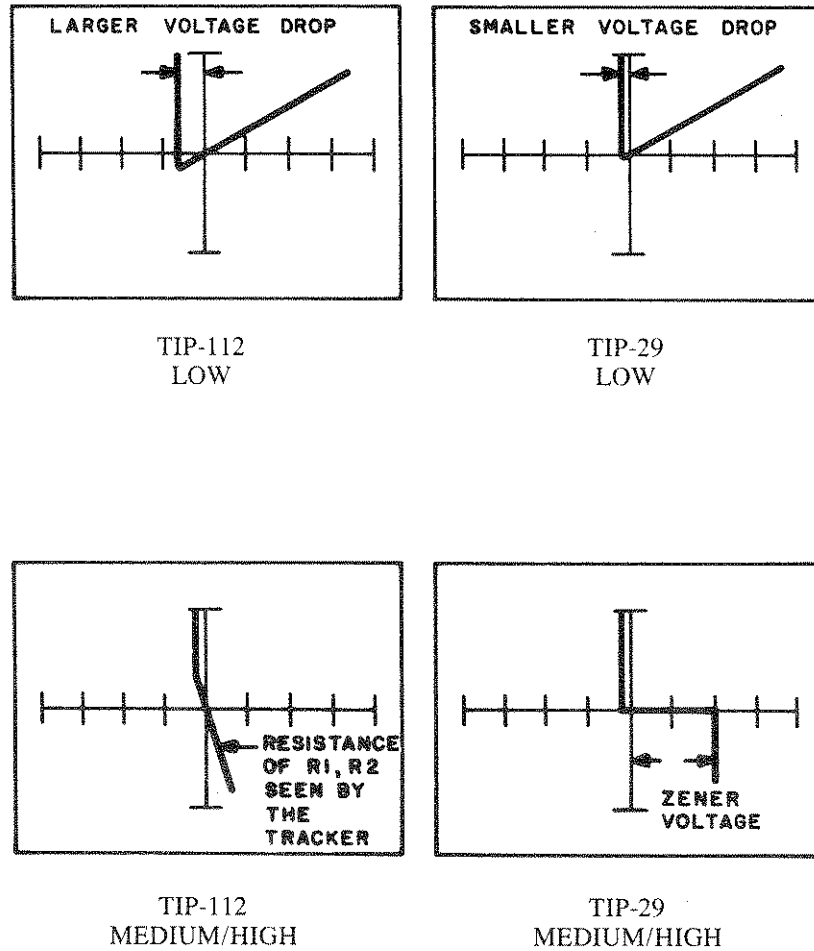

Figure 4-15. Patterns of a TIP-112 and TIP-29 at the B-E Terminals

To further test the TIP-112, connect the tracker probes to the C and E terminals of the TIP-112 and the TIP-29, then set the tracker to the alternate mode. Figure 4-16 shows the tracker pattern at the C and E terminals of the TIP-112 and the TIP-29. For the TIP-112, the internal diode (D1) dictates the tracker pattern.

To perform the final test of the TIP-112, connect the tracker probes to the C and B terminals of the TIP-112 and the TIP-29, then set the tracker to the alternate mode. The tracker provides the typical diode pattern similar to those shown in Figure 4-11.

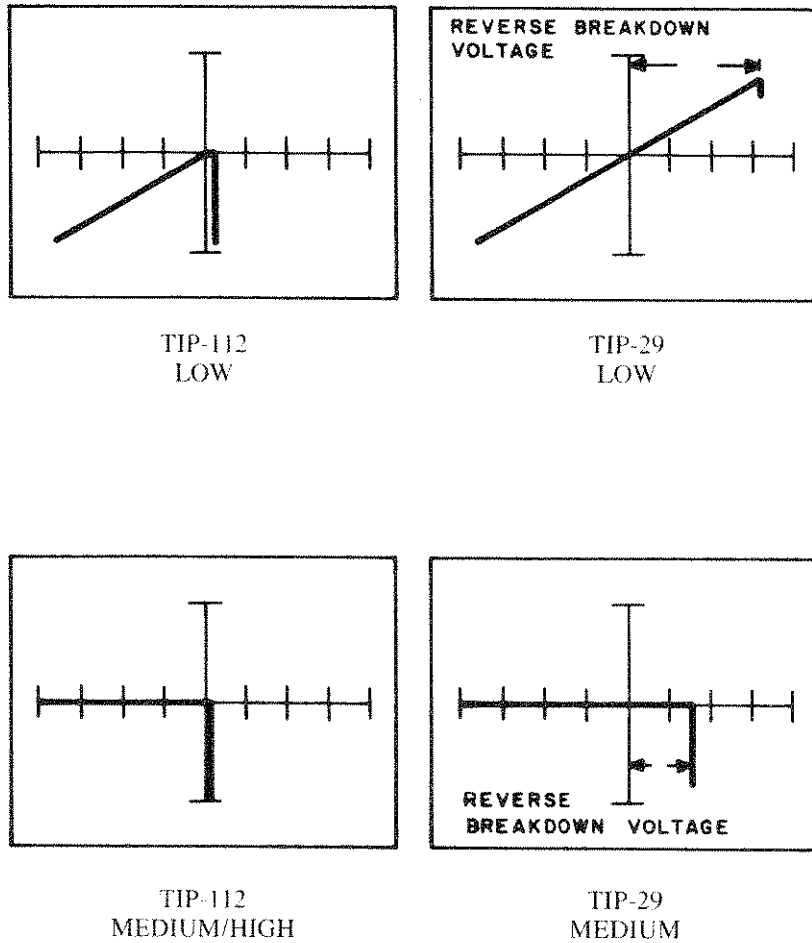

Figure 4-16. Pattern of the TIP-112 and TIP-29 at the C-E Terminals

## 4.6 JFET TRANSISTORS

Field effect transistors (FETs) may be divided into two main types, the junction FET (JFET) and the metaloxide-silicon FET (MOSFET). (For information about testing MOSFETs with the tracker, refer to section 4.8.) While MOSFET devices are available in both enhancement and depletion mode, junction FETs are all depletion mode devices. Junction FETs are tested by placing the tracker test leads across the gate and drain, and across the gate and source. Both of these tests check the quality of the junction that exists between the gate, the drain, and the source. As with any high quality junction, a fairly sharp knee should be noted when the tracker is in the low range.

Figure 4-17A shows a gate/source and gate/drain pattern with the tracker in the low range. Figure 4-17B shows the source/drain pattern with gate open. Motion will be noted along the pattern of Figure 4-17B because the open gate lead modulates the channel with 60 Hz. Consequently, this is not a valid test.

Figure 4-17C and 4-17D show the patterns that result from connecting the gate to the source and to the drain. The curved portion of these patterns result from the non-linearity of the channel resistance while the gate is in a continuously changing depletion mode. A discontinuity or break in the pattern will indicate a defective device providing it is not caused by another external device during testing under "in circuit" conditions. The sharpness of the knee is an indication of the device quality.

The transistor selected for the patterns shown in Figure 4-17 is a 2N5638, a N-channel JFET that has a very low channel resistance and is normally used as an analog switch. Other devices will exhibit slightly different patterns, but the described test conditions still apply.

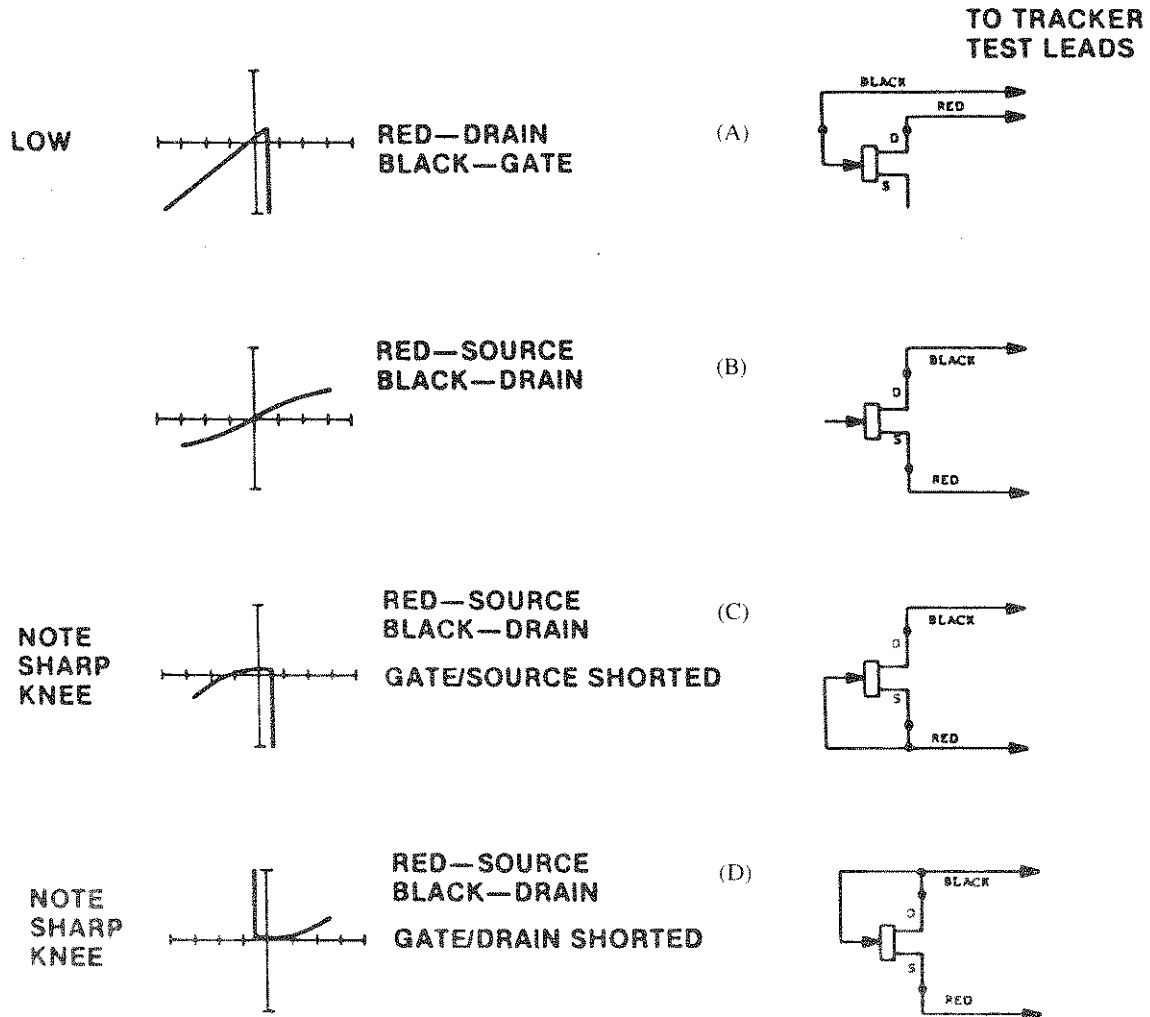

Figure 4-17. N-Channel JFET Patterns, Low Range



## 4.7 MOSFET TRANSISTORS

### 4.7.1 General

MOS field effect transistors are constructed as either "depletion" or "enhancement" mode gate biasing. Each type requires a distinct test procedure with the tracker. Figure 4-18 shows the construction and circuit symbol of N-channel and P-channel MOSFETs. The depletion-mode MOSFET is a "normally on" device. When  $V_{gs} = 0$ , a conducting path exists between source and drain. An enhancement-mode MOSFET is a "normally off" device, and increasing the

voltage applied to the gate will enhance channel conduction, and depletion will never occur.

Because MOS devices require higher voltage levels for testing than junction FETs, the tracker's medium range must be used. The amount of "in circuit" loading that can be tolerated is limited by the impedance of the tracker's signal generator.

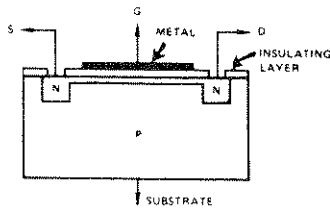

Idealized cross-section through an N-channel depletion-type MOSFET

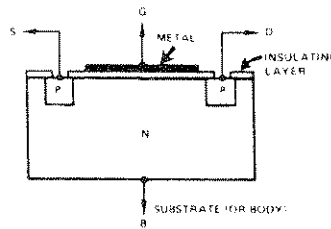

Idealized cross-section through a P-channel enhancement MOSFET

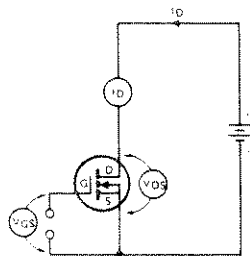

Circuit arrangement for N-channel depletion MOSFET

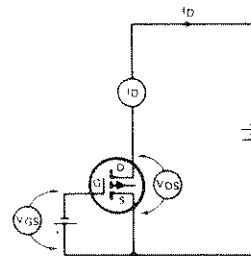

Circuit arrangement for P-channel enhancement MOSFET

Figure 4-18. N-channel and P-channel MOSFET Devices

## 4.7.2 Depletion Mode MOSFET

Figure 4-19A shows the circuit and pattern required to test this type of device. The vertical leg (1) results from the junction between the drain and substrate being forward biased by the negative test signal from the tracker. This test must be performed with the tracker in the medium range. The slight tilt in the vertical leg results from the 2.4K resistor in series with the source. This test was done out of circuit.

A high quality transistor will have a fairly sharp, clean break at the knee and a somewhat flat horizontal leg (2). The height of the horizontal leg above the display center line will be influenced by the  $G_m$  of the device.

Figure 4-19B shows the display of a faulty device. Note that there is no distinct breakpoint after the junction is reverse

biased. The curved leg (2) indicates a great deal of leakage through the channel area.

Figure 4-19C displays the tracker pattern when a 10K-ohm resistor is shunted across the tracker input. This circuit simulates the condition that would exist in some "in circuit" testing situations. If the load resistor becomes too small, the transistor must be removed from the circuit for a clear test. Note that the break at the knee is still sharp and not rounded. Also the break is somewhat above the axis of the display.

Figure 4-19D displays the tracker pattern when a defective transistor is shunted by a 10K-ohm resistor. Note that the leg (2) is a fairly straight line, but the break originates very close to the display axis.

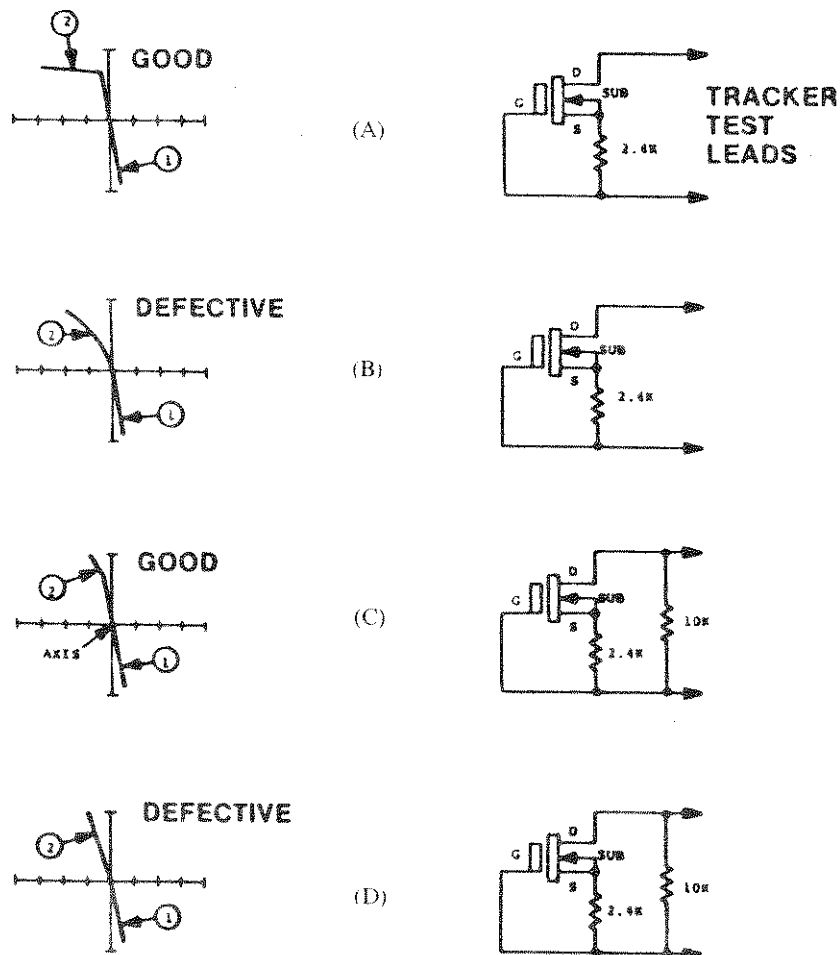

Figure 4-19. N-Channel Depletion Mode MOSFET. Medium Range

### 4.7.3 Enhancement Mode MOSFET

In this type of transistor, the gate must be biased in the forward direction. Active operation of the transistor does not come about until the gate voltage is increased to a certain level, depending on the parameters of the particular transistor.

In the pattern shown in Figure 4-20A, the test transistor becomes active as the gate voltage approaches approximately -4 volts. As soon as active operation is achieved, the channel resistance becomes very low, causing channel current to increase, as shown by leg (1) in Figure 4-20A.

Point (2) in the pattern is the voltage level at which the base causes normal active operation. Point (3) is the reverse voltage level that activates the drain/substrate junction in the

forward direction. Leg (4) is the junction current leg.

Point (2) knee will be slightly rounded in a good device. Point (3) will have a very sharp break. The horizontal leg of the Figure 4-20A pattern will exhibit zero tilt when testing a good transistor.

Figure 4-20B shows the pattern of a transistor that has a defective channel. Figure 4-20C shows the pattern of a good transistor that is shunted with 10K ohms of resistance. Note that leg (2) of the Figure 4-20C pattern is straight and slanted. Both knee points are fairly sharp and well defined. Figure 4-20D shows the pattern of a defective transistor that is shunted with 10K ohms of resistance.

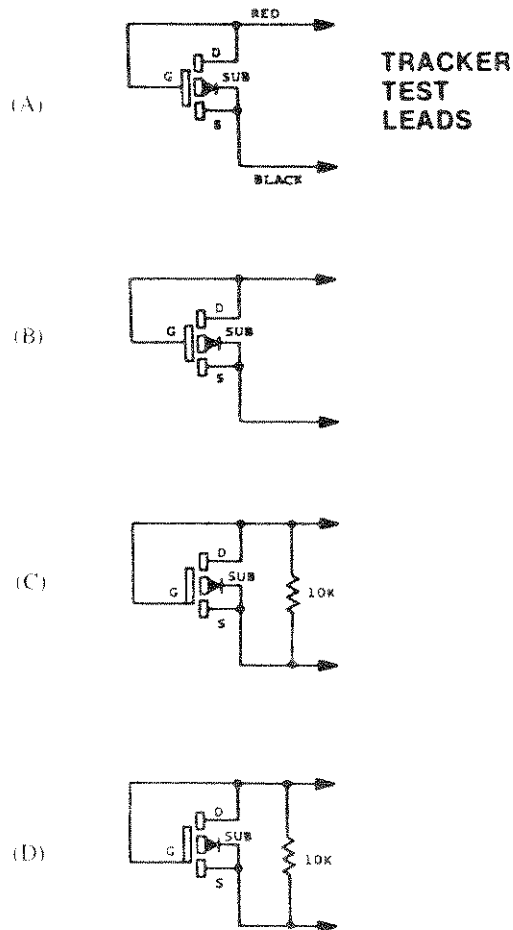
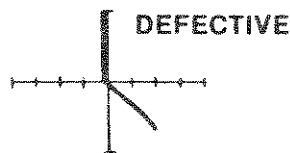
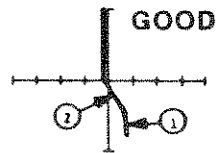
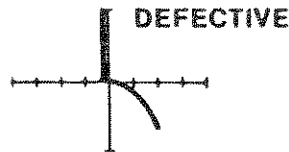
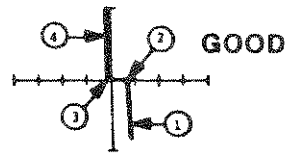

Figure 4-20. P-Channel Enhancement Mode MOSFET, Medium Range

#### 4.7.4 MOSFET With Protection Diode

**INTRODUCTION.** Some MOSFET devices have an input protection diode, and the tracker displays the effect of this diode. Figure 4-21 shows a Siliconix N-channel enhancement mode MOSFET (VN10KM). This device has a protection diode between the gate and source, and the substrate is internally connected to the source.

**TESTING GATE AND SOURCE.** To test the gate and source of the VN10KM, connect the test probes to the gate (G) and source (S) terminals as shown in Figure 4-22. Note that the drain (D) terminal is not connected.

Figure 4-23 shows the patterns of the protection zener diode in the low, medium and high ranges. The test signal in the low range is 20 volts peak-to-peak and is not high enough to cause zener breakdown. The test signal in the medium range is 40 volts peak-to-peak, and is still not high enough to cause zener breakdown. However, in the high range, the test signal is sufficient to cause zener breakdown.

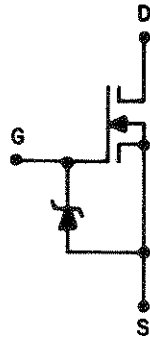

Figure 4-21. VN10KM MOSFET With Gate-to-Source Protection Diode

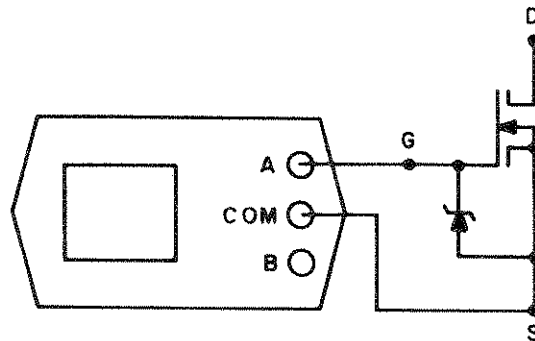

Figure 4-22. Tracker Connections to the Gate and Source

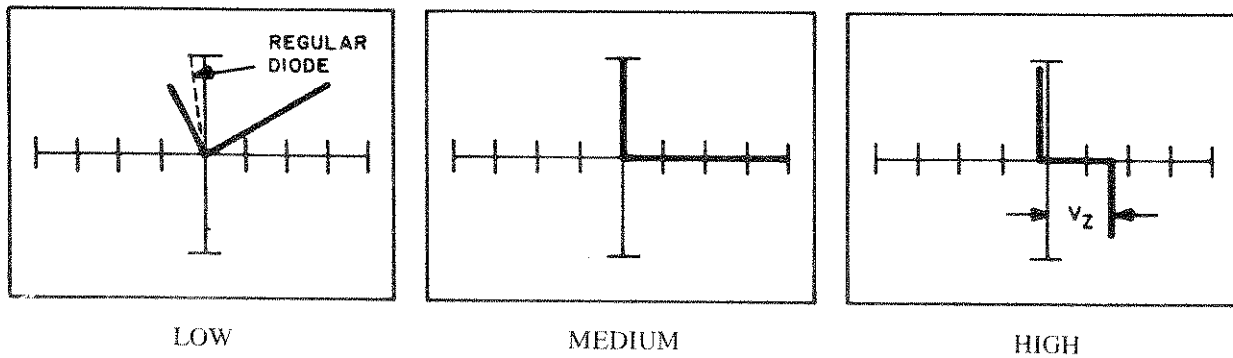

Figure 4-23. Gate-to-Source Patterns

**TESTING THE SOURCE AND DRAIN.** To test the source and drain, connect the test probes to the source (S) and drain (D) terminals as shown in Figure 4-24; the gate (G) terminal is not connected. The tracker test signal is a sinewave and during the time the voltage at D is positive with respect to S, the D and S terminals appear as an open circuit to the tracker. However, when S is positive with respect to D, the substrate diode is displayed by the tracker. If the gate (G) is in contact

with a finger, the diode pattern will be modulated by a 50/60Hz signal transmitted from the body to the gate.

Figure 4-25 shows the patterns in the low and medium range of the substrate diode with the gate touched by a finger, while Figure 4-26 shows the patterns with the gate terminal unconnected.

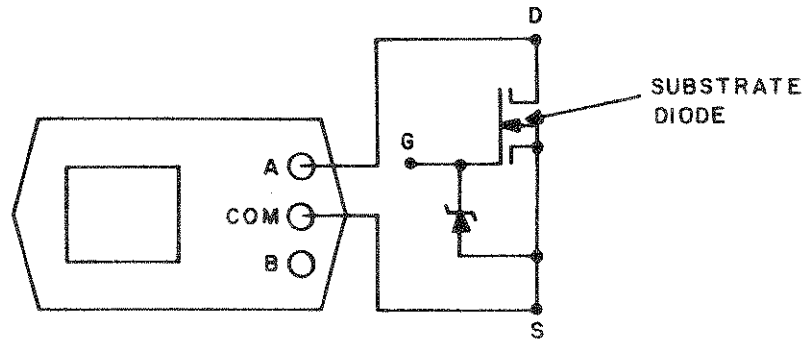

Figure 4-24. Tracker Connections to the Gate and Source

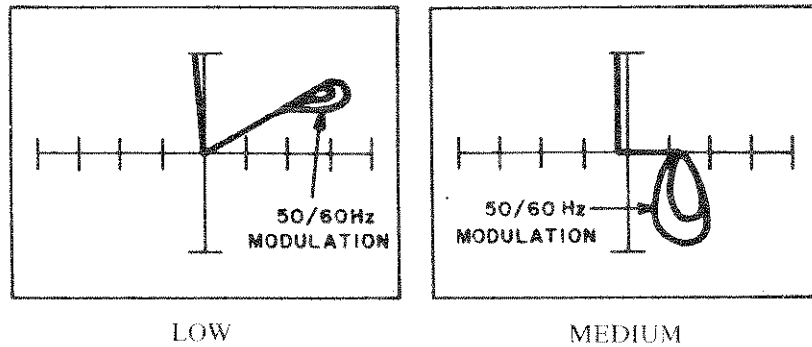

Figure 4-25. Patterns of VN10KM MOSFET at D and S Terminals with Finger in Contact with Gate

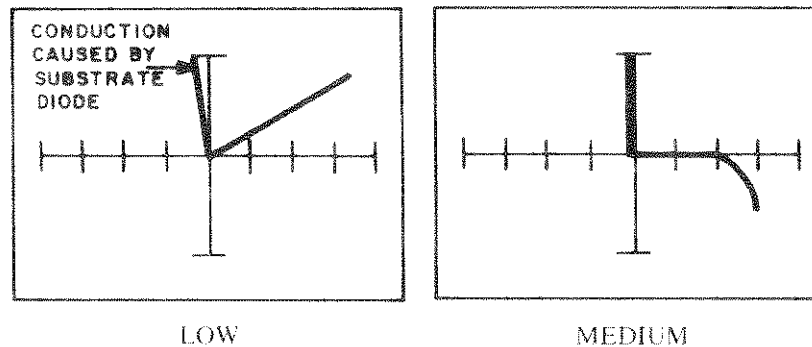

Figure 4-26. Patterns of VN10KM MOSFET at D and S Terminals with Gate Unconnected

**TESTING THE GATE AND DRAIN.** To test the VN10KM gate and drain, connect the test probes to the gate (G) and drain (D) as shown in Figure 4-27.

Figure 4-28 shows the pattern in the low range. The D and G terminals appear as an open circuit and the resultant pattern is a diagonal line.

In the medium range, the D and G terminals appear as open circuit, but modulated by 50/60Hz signal from the surround-

ings. Figure 4-29 shows the pattern in the medium range. This tracker range provides a test signal from a high source impedance and is able to show the modulation effect.

When operated in the high range, the tracker test signal is a 120-volt peak-to-peak sinewave (with limited current). This voltage is sufficient to cause the D-G connection to go into non-destructive breakdown, and the source impedance is sufficient to show the modulation effect caused by 50/60Hz signal. Refer to Figure 4-30.

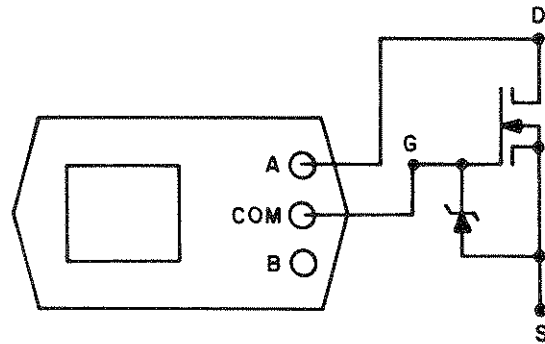
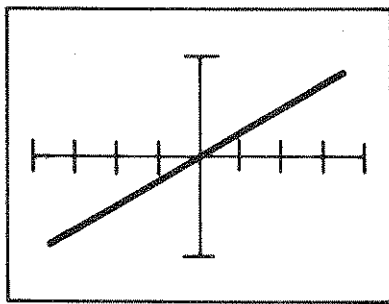
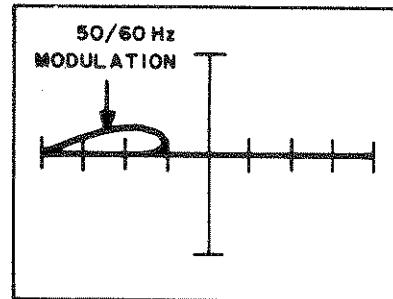

Figure 4-27. Tracker Connections to the Gate and Drain



LOW

Figure 4-28. Patterns of VN10KM MOSFET at the D and G Terminals



MEDIUM

Figure 4-29. Patterns of a VN10KM MOSFET at the D and G Terminals with 50/60Hz Modulation

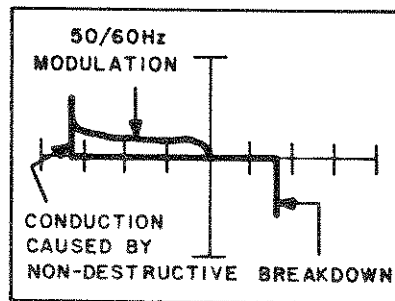

LOW

Figure 4-30. Patterns of a VN10KM MOSFET at the D and G Terminals with Non-Destructive Breakdown

## 4.8 UNIUNCTION TRANSISTORS (UJT)

The unijunction transistor, or double-base diode, has a small rod of P material extending into the block of N material which serves as a P-N junction. Two metallic contacts, called bases, are welded to the N block without creating new junctions. Figure 4-31 shows the construction and symbol of the unijunction transistor.

Figure 4-32 shows the test connections of the UJT and also the lead assignments for a 2N4871 device. Set the tracker to the alternate mode and the low range, then verify a pattern as shown in Figure 4-33 for diodes E-B1 and E-B2. (There is a slight difference in forward voltage drops between the diodes; the difference depends on the intrinsic standoff ratio of the UJT.)

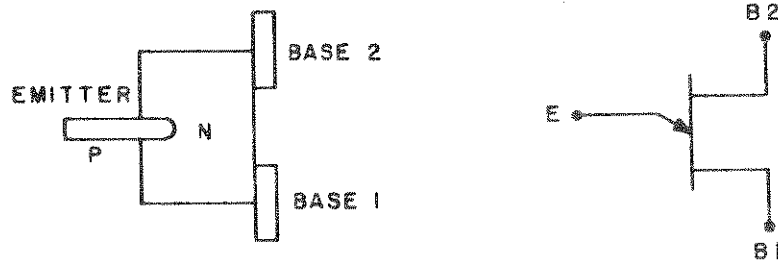

Figure 4-31. The Unijunction Transistor

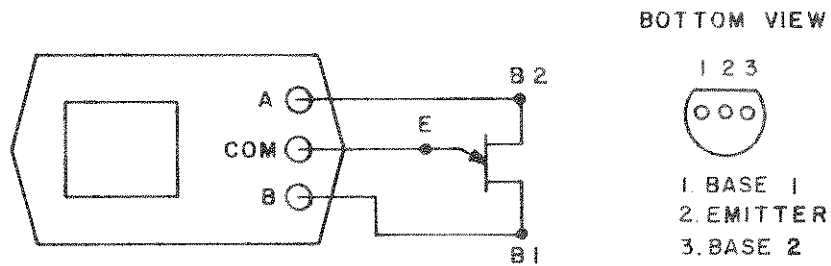

Figure 4-32. Test Circuit, Emitter-Base Junction - 2N4871 Transistor

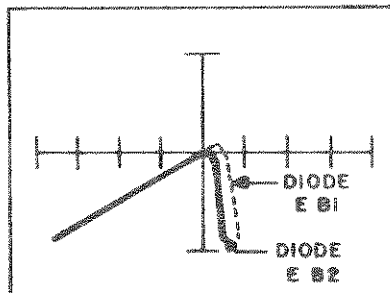

Figure 4-33. Low Range Pattern for Diodes E-B1 and E-B2

To test base 1 (B1) to base 2 (B2) of the UJT, set up the test circuit as shown in Figure 4-34. The patterns should be as shown in Figure 4-35 for B1 to B2 in all ranges.

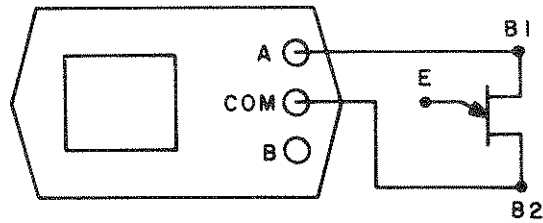

Figure 4-34. Test Circuit for B1 to B2 - 2N4871 Transistor

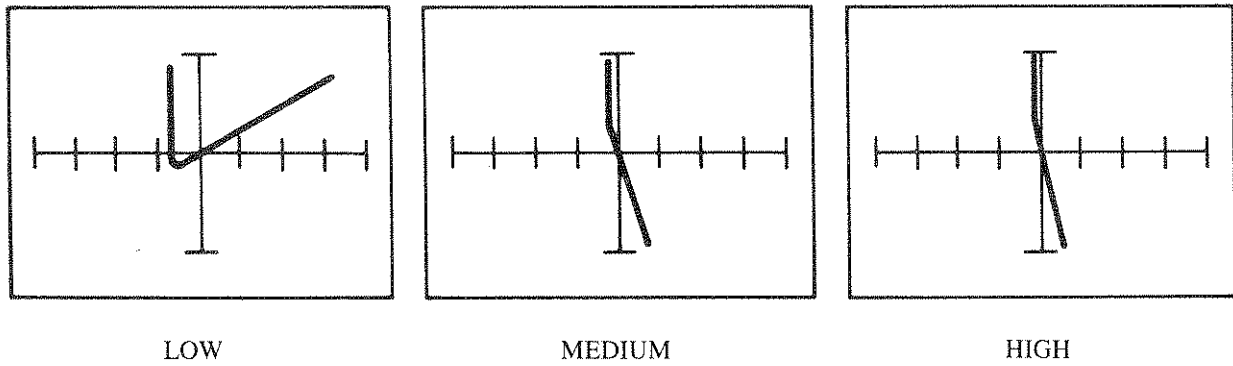

Figure 4-35. Patterns for B1 to B2



# SECTION 5

## RESISTORS, CAPACITORS, AND INDUCTORS

### 5.1 RESISTORS

#### 5.1.1 General

A pure resistance across the test probes will cause the trace on the tracker display to rotate clockwise on its center axis. The degree of rotation is a function of the resistance value. For the high and medium ranges, the trace rotates in clockwise direction from the horizontal (open circuit) position. For the low range, the trace rotates clockwise from the open circuit diagonal position. On all ranges, the length of the trace is reduced because of the voltage drop caused by the internal impedance of the tracker.

#### 5.1.2 Low Range

This range is designed to detect resistance between zero and 1K ohm. Figure 5-1 shows the effect of resistance on the angle of rotation in the low range. A 500-ohm resistor causes a slight trace rotation. A 50-ohm resistor causes the trace to rotate to such an angle, that it becomes a horizontal line. A 20-ohm resistor causes 90 degrees of rotation, and a zero-ohm resistor is indicated by a vertical line.

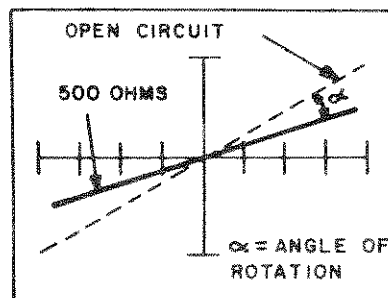

500-OHM RESISTOR

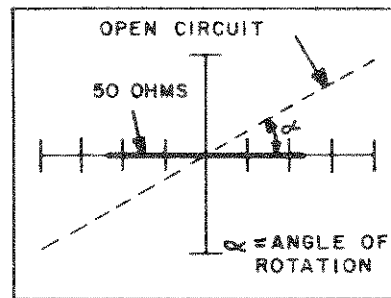

50-OHM RESISTOR

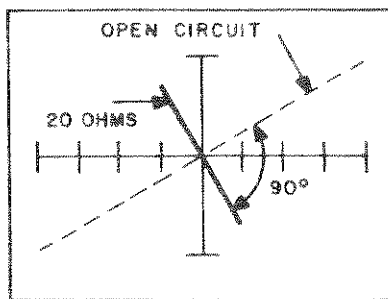

20-OHM RESISTOR

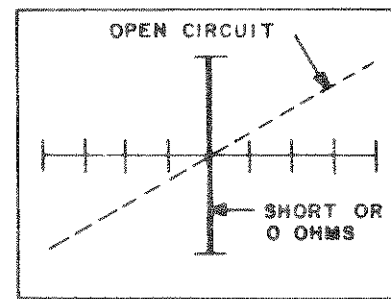

ZERO-OHM RESISTOR

Figure 5-1. Effects of Resistors on the Angle of Rotation - Low Range

### 5.1.3 Medium Range

This range is designed to detect resistance between 1K and 200K ohm. Figure 5-2 shows the tracker trace for a 1k resistor, a 15K resistor, and a 200K resistor, using the medium range. Resistances of smaller values than 1K appear almost as a vertical line. A 15K resistor causes an angle of

rotation of 45 degrees, while the tracker trace for a 200K resistor causes only slight rotation. Resistor values higher than 200K, produce such a small rotation angle that it appears almost as a horizontal line.

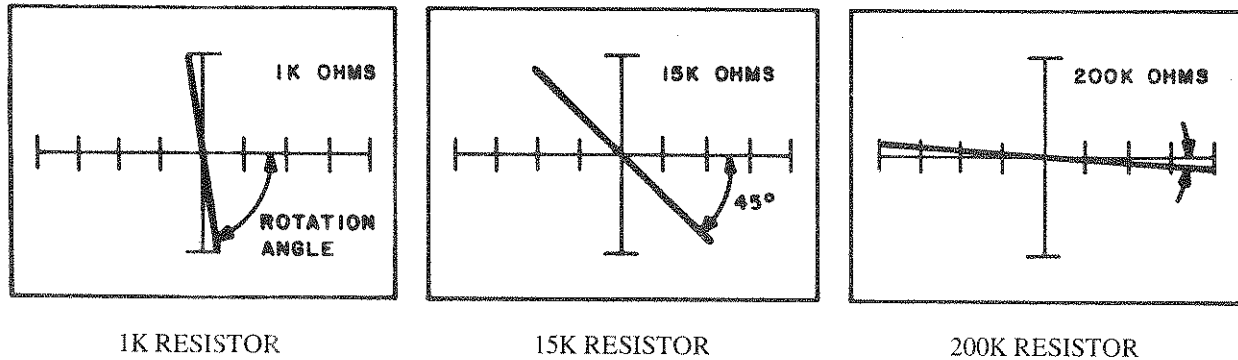

Figure 5-2. Effects of Resistor on Angle of Rotation - Medium Range

### 5.1.4 High Range

This range is designed to detect resistance between 3K and one megohm. Figure 5-3 shows the tracker trace for a 3K resistor, a 50K resistor, and a one Megohm resistor, using the high range. Resistances smaller than 3K appear almost as a vertical line. A 50K resistor causes an angle of rotation of

45 degrees, while the tracker trace for a one megohm resistor causes only slight rotation. Resistor values higher than one megohm produce such a small rotation angle that it appears almost as a horizontal line.

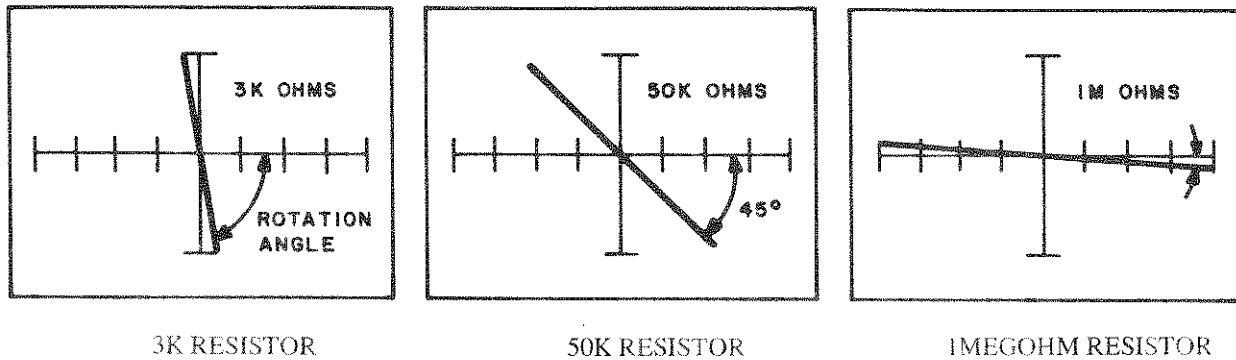

Figure 5-3. Effects of Resistor on Angle of Rotation - High Range

## 5.2 CAPACITORS

With a capacitor connected to the tracker as shown in Figure 5-4:

the voltage ( $V(t)$ ) across the capacitor is given as

$$V(t) = a \sin \omega t \dots\dots\dots (1)$$

the current  $I(t)$  in the loop is 90 degrees out of phase with respect to the voltage ( $V(t)$ ) and is given as

$$I(t) = b \cos \omega t \dots\dots\dots (2)$$

where  $a$  and  $b$  are constants,  $\omega$  is the test signal frequency

From equation (1):

$$V(t)/a = \sin \omega t$$

or

$$V^2(t)/a^2 = \sin^2 \omega t \dots\dots\dots (3)$$

From equation (2):

$$I(t)/b = \cos \omega t$$

or

$$I^2(t)/b^2 = \cos^2 \omega t \dots\dots\dots (4)$$

Add equations (3) and (4):

$$\begin{aligned} V^2(t)/a^2 + I^2(t)/b^2 \\ = \sin^2 \omega t + \cos^2 \omega t \\ = 1 \dots\dots\dots (5) \end{aligned}$$

This is the equation of an ellipse. It becomes a circle if  $a = b$ .

The size and shape of the ellipse depends on capacitor value and tracker range. Figure 5-5 shows the tracker patterns for various capacitor values in the low range. Figure 5-6 shows the tracker patterns for various capacitor values in the medium range. Figure 5-7 shows the tracker patterns for various capacitor values in the high range.

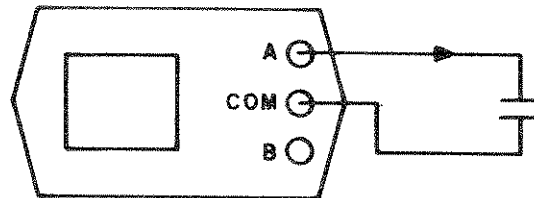

Figure 5-4. Capacitor Test Connections

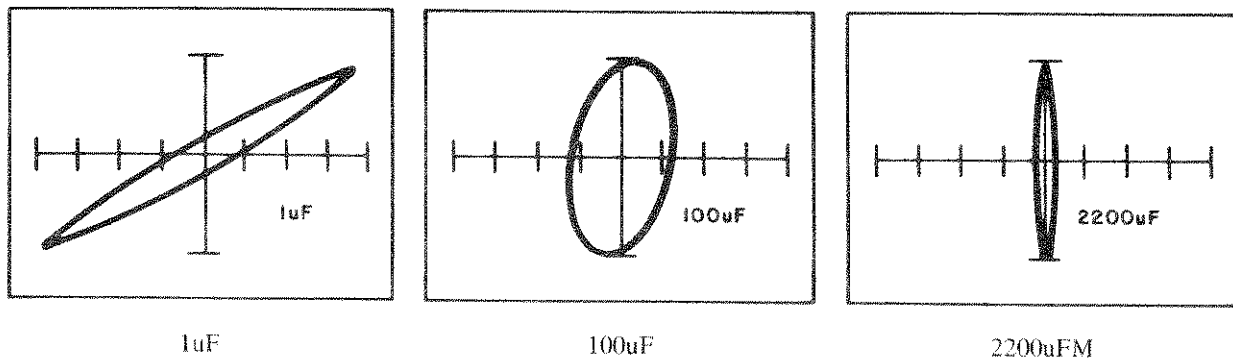

Figure 5-5. Capacitor Patterns Using the Low Range

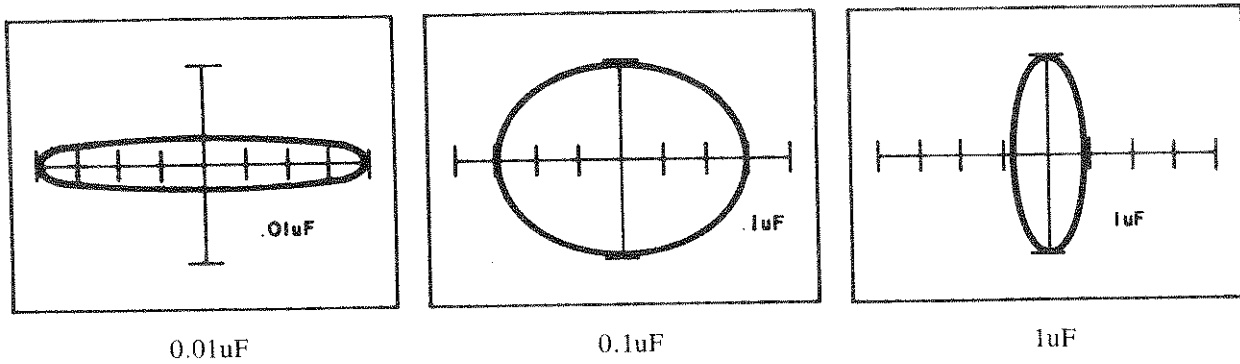

Figure 5-6. Capacitor Patterns Using the Medium Range

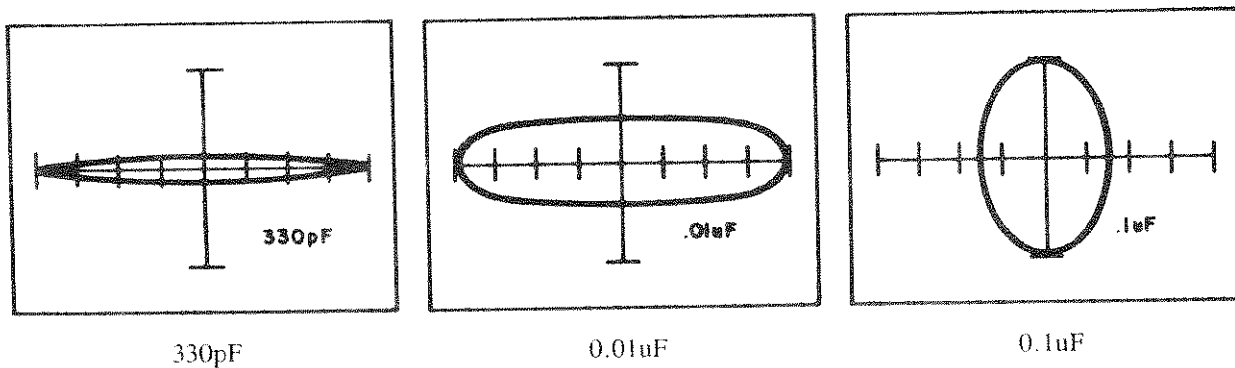

Figure 5-7. Capacitor Patterns Using the High Range

For capacitor testing, low range covers 1uF to 2200uF; medium range covers 0.01uF to 1.0uF, and high range covers 330pf to 0.1uF. Capacitive values less than 1.0uF appear as an open circuit in the low range, while capacitors with values higher than 10uF appear as short circuit in the medium and

high ranges. Figure 5-8 shows that the trace for a capacitor of less than 0.1uF appears as an open circuit in the low range. Figure 5-9 shows that the trace for a capacitor higher than 10uF appears as a short circuit in the medium and high ranges.

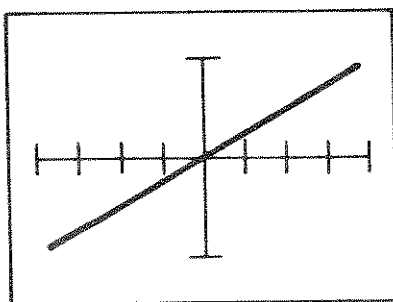

Figure 5-8. 0.1uF Capacitor in the Low Range

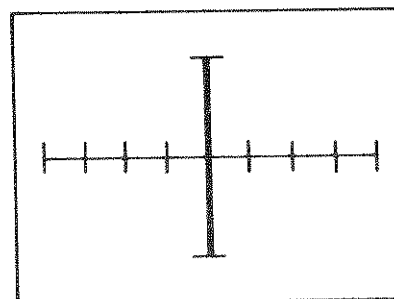

Figure 5-9. 10uF Capacitor in the Medium and High Ranges

### 5.3 INDUCTORS

Inductors produce a similar effect on tracker patterns to capacitors, except that the current lags the voltage applied to the inductor. Like capacitors, inductors produce an elliptical pattern. Figure 5-10 shows the patterns for a 6H inductor in the low, medium, and high ranges.

For a 6H inductor, the impedance at the test signal frequency (80Hz) is so large compared with low range internal impedance, that it appears as an open circuit. In the medium and high ranges, distorted ellipses are produced. The distortion is

caused by the non-linear properties of the iron core material.

Figure 5-11 shows the test circuit and electrical equivalent for a 250 mH inductor. Figure 5-12 shows the pattern for the 250 mH inductor (which is equivalent to an inductance in series with an 84-ohm resistor). In high range, the inductive reactance (due to the 250 mH inductance) is insignificant compared to the resistance (84 ohms), which is a fairly good short, so a vertical line is observed. However, a small ellipse is seen in the medium and low ranges.

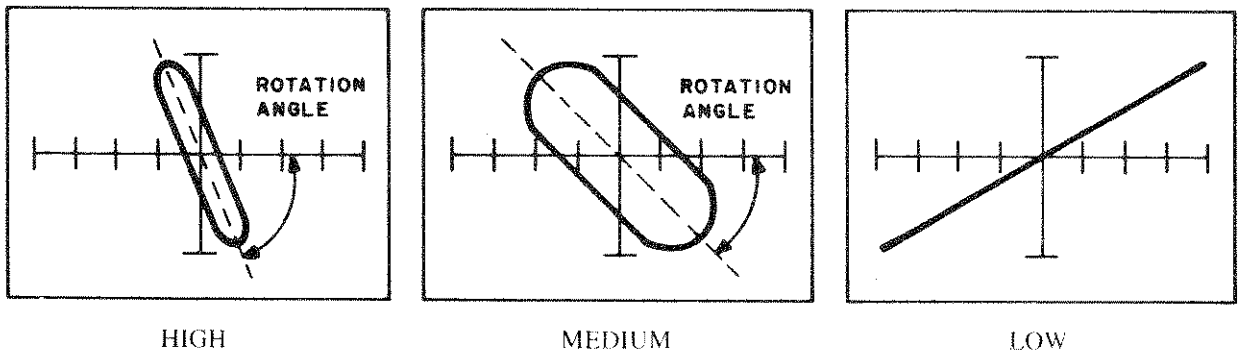

Figure 5-10. Patterns for a 6H Inductor

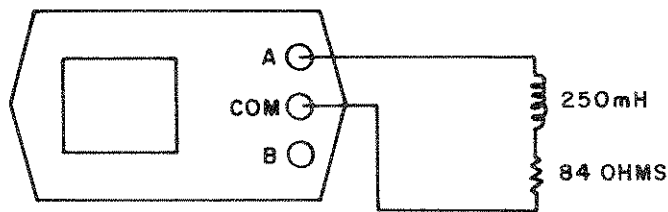

Figure 5-11. Test Circuit for a 250mH Inductor

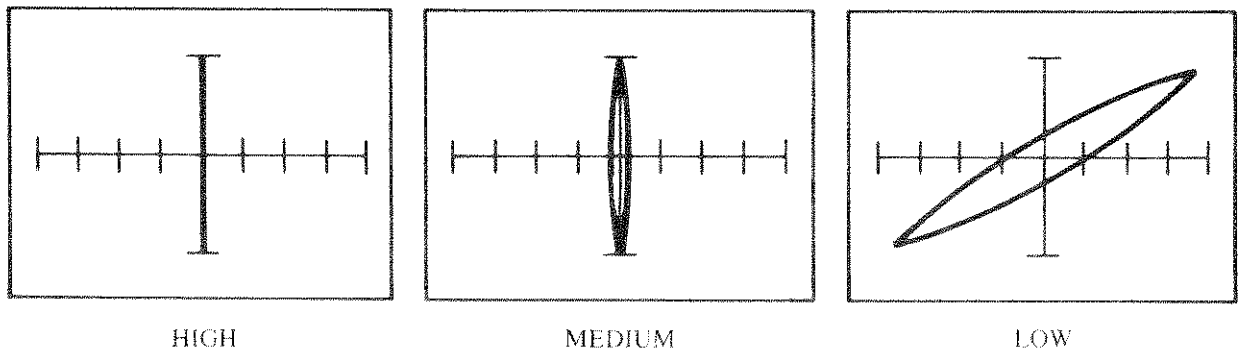

Figure 5-12. Patterns for a 250mH Inductor

## 5.4 TOROID INDUCTORS

Toroid inductors can be checked with the tracker, but produce a pattern that differs from the previously described

inductor. Toroids are tested using the low range, and typically produce the pattern shown in Figure 5-13.

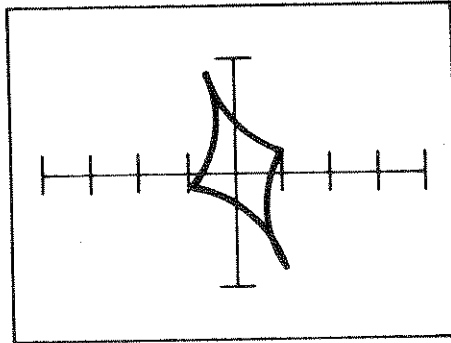

Figure 5-13. Pattern for a Toroid Inductor - Low Range

# SECTION 6

## TESTING MULTIPLE COMPONENT CIRCUITS

### 6.1 TRACKER DIAGNOSTIC PRINCIPLES

The preceding sections discuss in detail the test patterns for diodes, transistors, resistors, capacitors, and inductors. Section 6 examines circuits formed by multiple components, such as diodes in series, or parallel, with a capacitor, etc. It is

very important for users to understand composite circuit patterns prior to printed circuit board level troubleshooting. Based on the information contained in the previous sections, the following diagnostics are presented in Table 6-1.

Table 6-1. Diagnostic Table

COMPONENTS	RANGE	PATTERN DESCRIPTION
Open circuit	Low	Diagonal line
	Medium, high	Horizontal line
Short circuit	All	Vertical line
Resistor	Low	Straight lines rotated clockwise from diagonal line
	Medium, high	Straight line rotated clockwise from horizontal line
Diode	Low	Check mark
	Medium, high	"L" shape
Capacitor	All	Ellipse or circle
Inductor	All	Ellipse or circle

## 6.2 TESTING DIODE/RESISTOR CIRCUIT

When testing diode/resistor circuits, the test pattern on the tracker depends on whether the diode is in series or in parallel with a resistor, the value of the resistor, and the tracker range.

### 6.2.1 Diode in Parallel with Resistor

Figure 6-1 shows the test circuit for a diode in parallel with a resistor. Figure 6-2 shows the effect of various resistance values on a diode (1N4001) pattern with the low range selected on the tracker. When the value of a resistor is over 1000 ohms, it contributes little to the pattern, and the tracker

displays mainly the diode effect. On the other hand, resistors of less than five ohms will dominate the pattern.

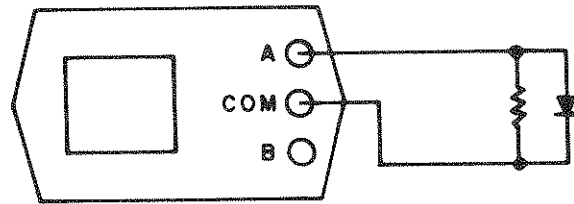

Figure 6-1. Test Circuit for a Parallel Diode and Resistor

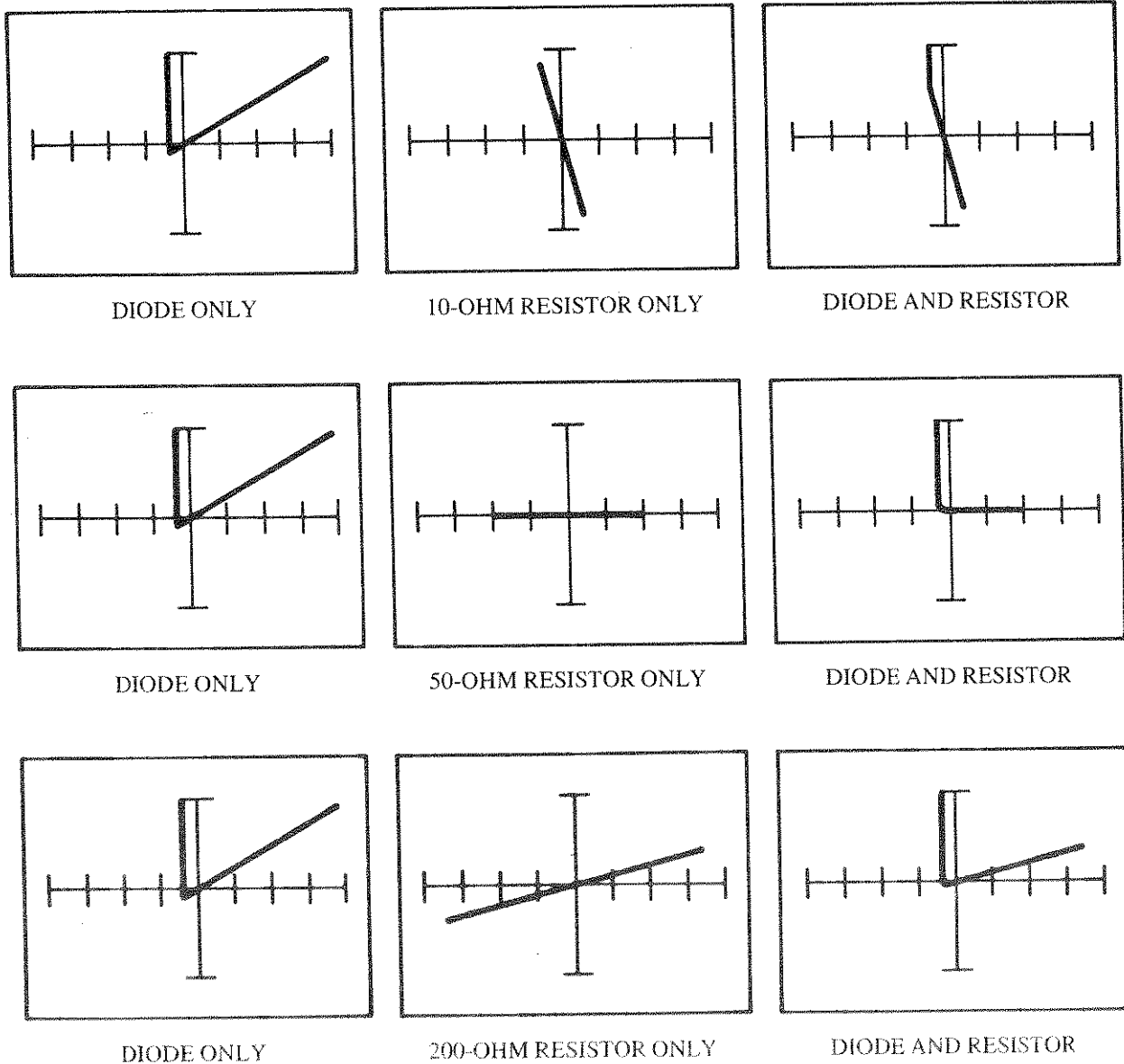

Figure 6-2. Parallel Diode/Resistor Traces - Low Range



Figure 6-3 shows the patterns for various resistors in parallel with the diode and the medium range selected on the tracker. Resistors with values greater than 200K have insignificant influence on the diode pattern. For resistors of less than 1000

ohms, the pattern is dominated by the resistor, while the diode contributes little. The high range of the tracker provides traces similar to that of medium range, except it covers higher values of resistors.

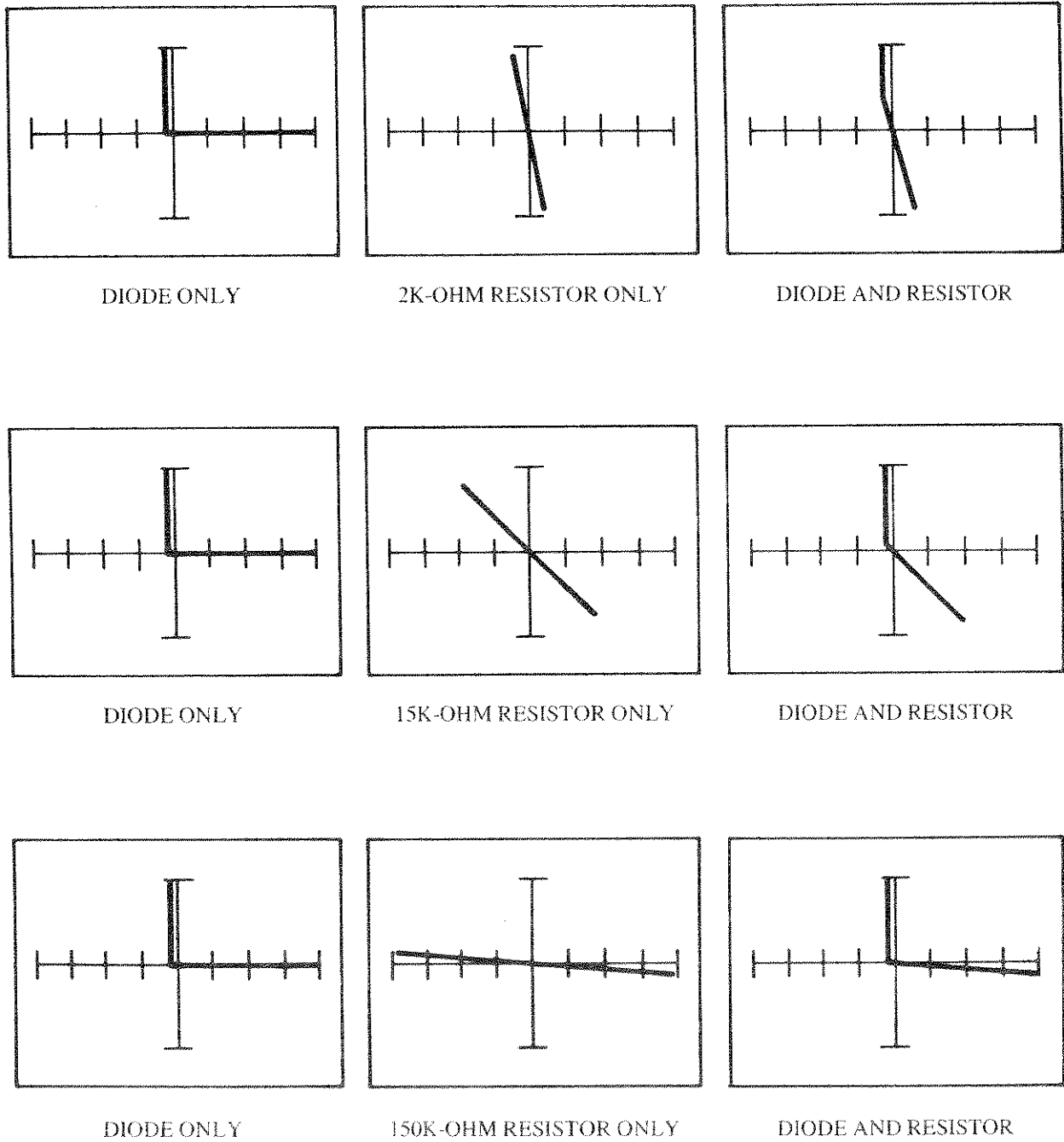

Figure 6-3. Parallel Diode/Resistor Traces - Medium Range

## 6.2.2 Diode in Series with Resistor

Figure 6-4 shows the test circuit for a diode and resistor connected in series. When the diode is forward biased, it is in a low impedance state and the tracker displays only the resistor. However, if the diode is reverse biased, the series circuit appears as an open circuit to the tracker. Figure 6-5

also shows the equivalent circuits for the diode-resistor series combination when forward and reverse biased.

Figures 6-6, 6-7, and 6-8, show the tracker patterns for various values of resistors in series with a diode while operating the tracker in the low, medium, and high ranges.

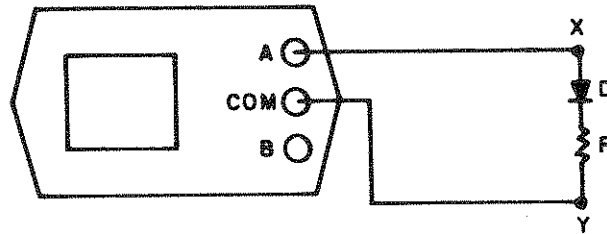

Figure 6-4. Test Circuit for a Series Diode and Resistor

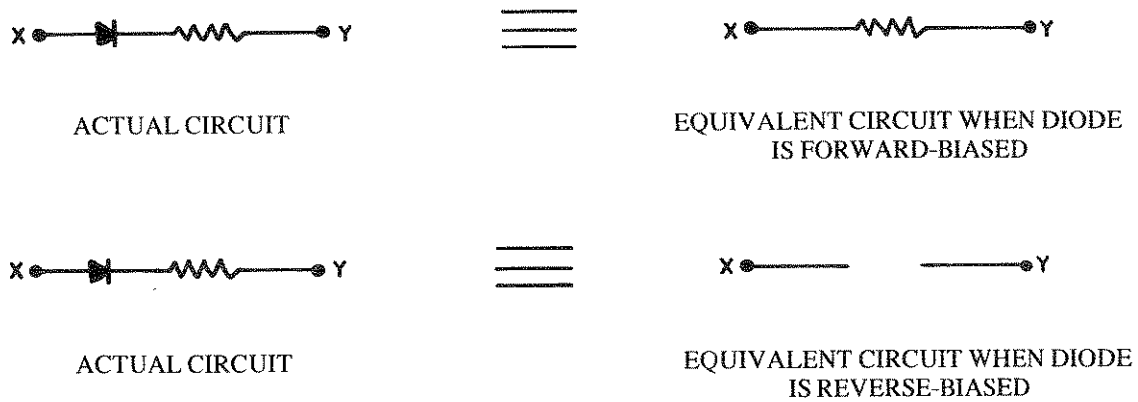

Figure 6-5. Diode/Resistor Equivalent Circuits

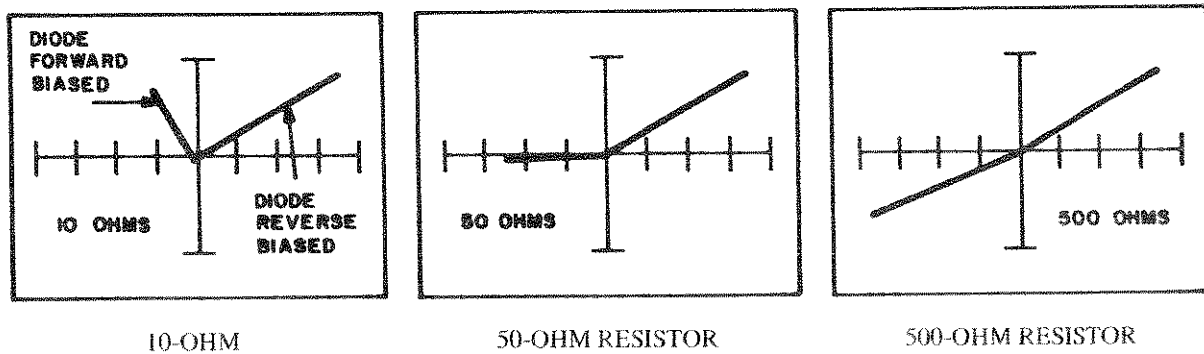
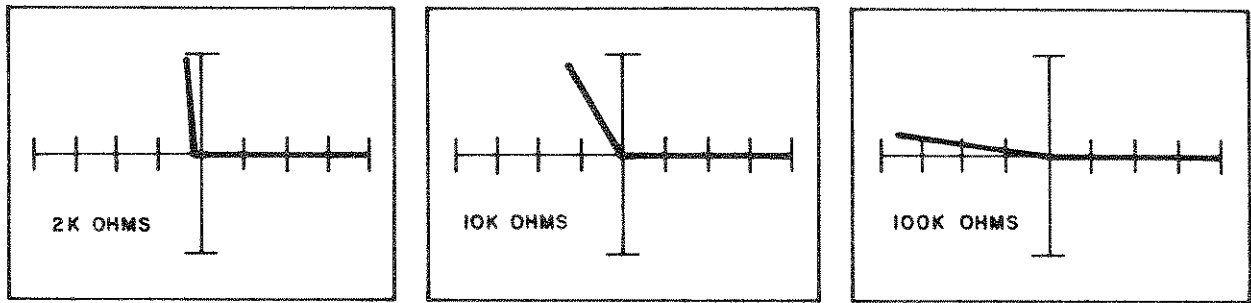

Figure 6-6. Low Range Patterns for Various Resistors and Series Diode



2K-OHM RESISTOR

10K-OHM RESISTOR

100-OHM RESISTOR

Figure 6-7. Medium Range Patterns for Various Resistors/Series Diode

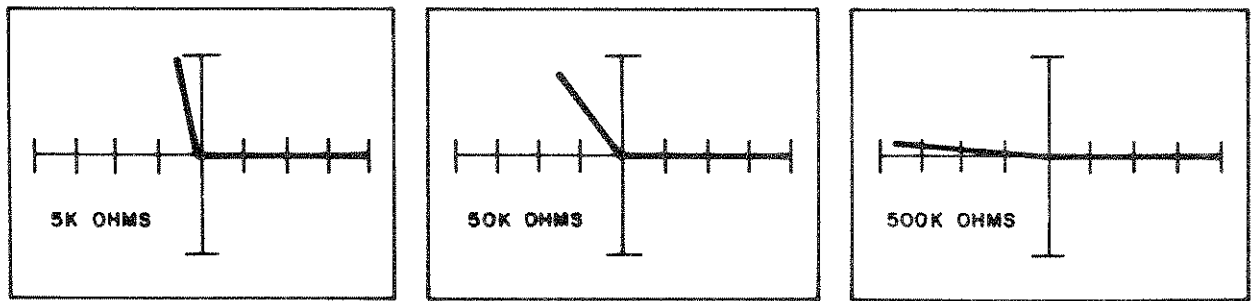

5K-OHM RESISTOR

50K-OHM RESISTOR

500K-OHM RESISTOR

Figure 6-8. High Range Patterns for Various Resistors/Series Diode

### 6.3 DIODE AND CAPACITOR PARALLEL COMBINATION

Figure 6-9 shows the test circuit for the parallel diode-capacitor combination. Figures 6-10 through 6-13 show the tracker displays for different values of capacitance with all three tracker ranges. In Figure 6-13, the 100uF capacitor causes a vertical trace in the medium and high range regardless of the diode.

Capacitors having values higher than 1000uF dominate the pattern and diode effect is negligible. In such a case, the medium and high ranges produce a vertical trace while the low range yields a small ellipse. Refer to Figure 6-14, which shows the effect of a 2200uF capacitor in parallel with a diode.

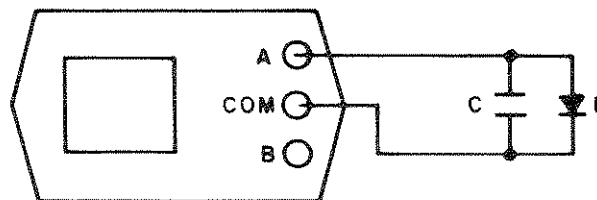

Figure 6-9. Test Circuit for Parallel Diode/Capacitor Combination

NOTE: CAPACITOR HAS NO EFFECT ON LOW RANGE PATTERN

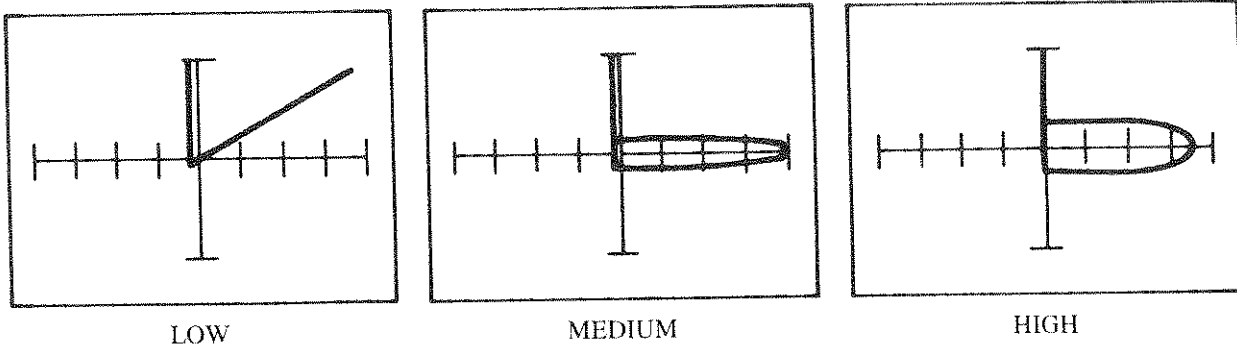

Figure 6-10. Tracker Display - Diode and a 0.01uF Capacitor

NOTE: CAPACITOR HAS NO EFFECT ON LOW RANGE PATTERN

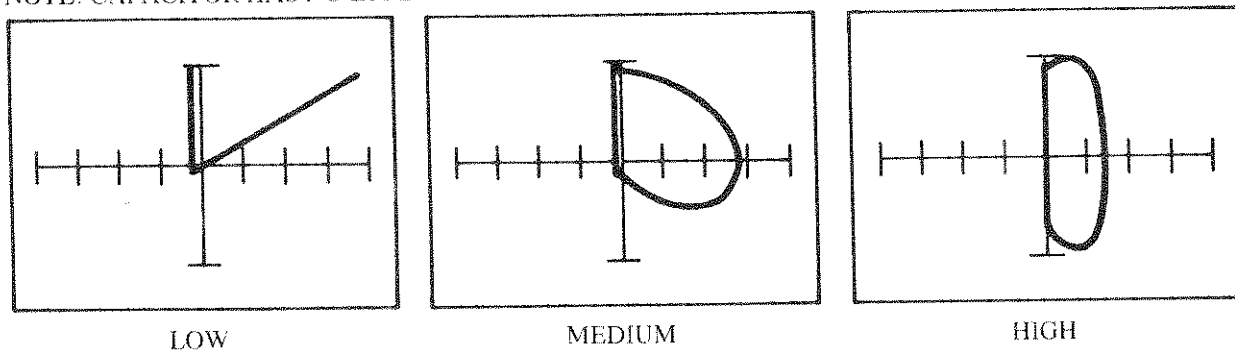

Figure 6-11. Tracker Display - Diode and a 0.1uF Capacitor

NOTE: DIODE HAS LITTLE EFFECT ON THE MEDIUM AND HIGH RANGE PATTERNS

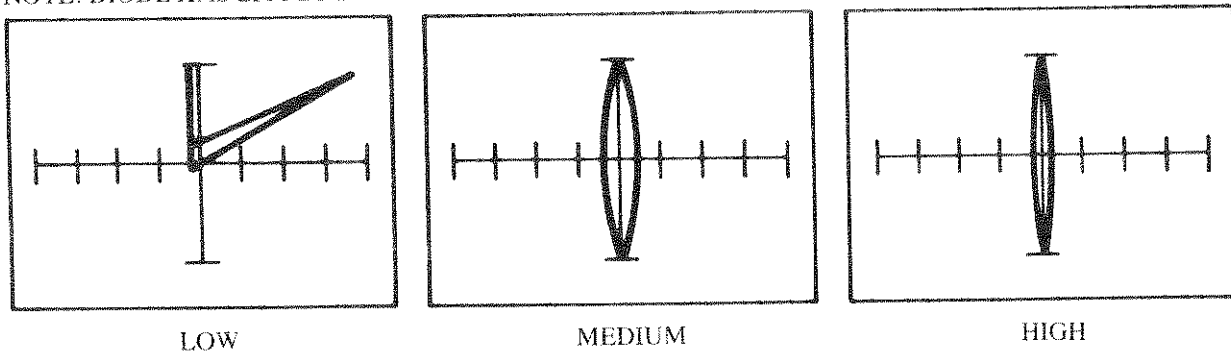

Figure 6-12. Tracker Display - Diode and a 1.0uF Capacitor

NOTE: DIODE HAS NO EFFECT ON MEDIUM AND HIGH RANGE PATTERNS

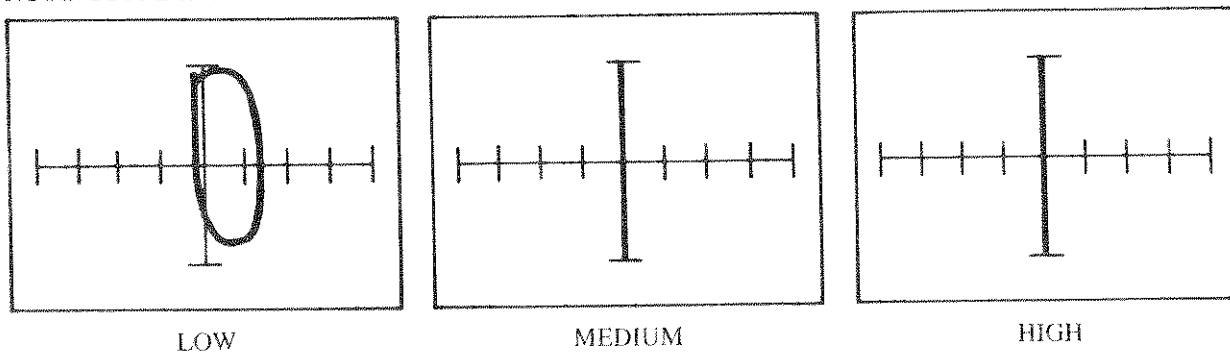

Figure 6-13. Tracker Display Using a 100uF Capacitor

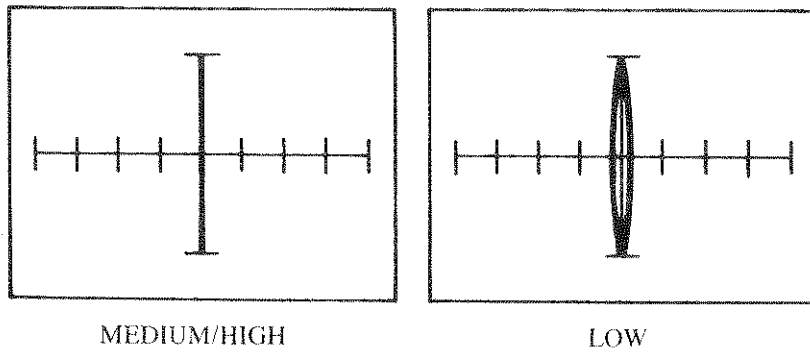

Figure 6-14. Tracker Display Using a 2200uF Capacitor in Parallel with a Diode

### 6.4 RESISTOR AND CAPACITOR PARALLEL COMBINATION

As previously discussed, a capacitor produces an ellipse, and a resistor produces trace rotation and amplitude reduction. Consequently, a resistor reduces the size of an ellipse and causes its major axis to rotate. The magnitude of the angle is determined by the value of the resistor and the range selected on the tracker. Figure 6-15 shows the test circuit for the parallel capacitor-resistor combination, while Figure 6-16 shows the effect of a 55K-ohm resistor/0.01uF capacitor combination, and Figure 6-17 shows the effect of a 5K-ohm resistor/0.12uF capacitor combination.

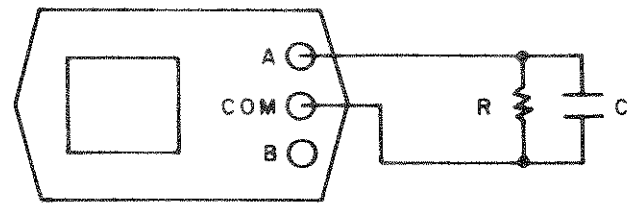

Figure 6-15. Test Circuit for Resistor and Capacitor in Parallel

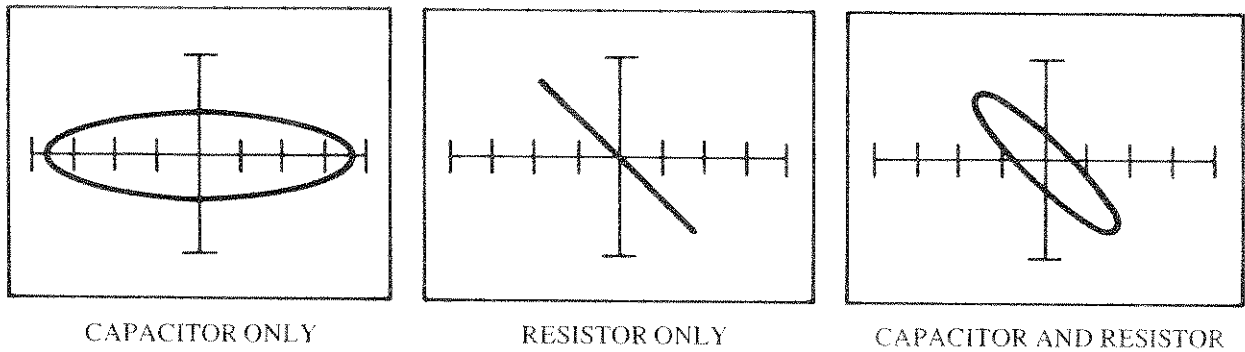

Figure 6-16. Effects of a 55K-Ohm Resistor and 0.01uF Capacitor in the High Range

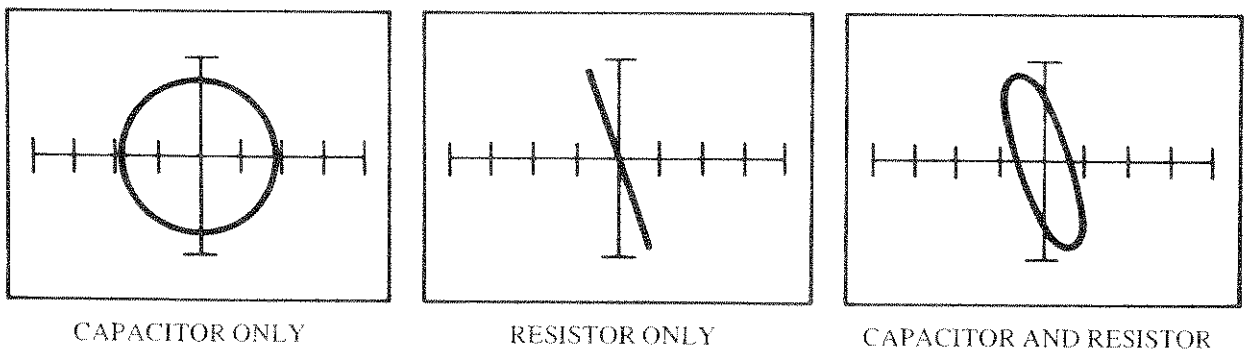

Figure 6-17. Effects of a 5K-Ohm Resistor and 0.12uF Capacitor in the Medium Range

## 6.5 INDUCTOR WITH DIODE

This type of circuit is found in relays and line printers. The diode suppresses the high voltage "kick" produced when the inductor or coil is de-energized. To test this device combination,

connect the tracker probes to points A and B shown in Figure 6-18. Figures 6-19 through 6-22 show the patterns produced by the described circuit conditions.

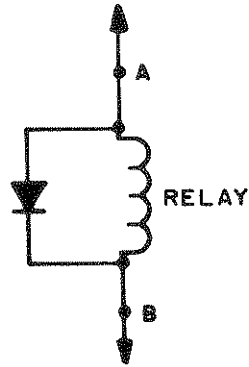

Figure 6-18. Inductance/Diode Combination

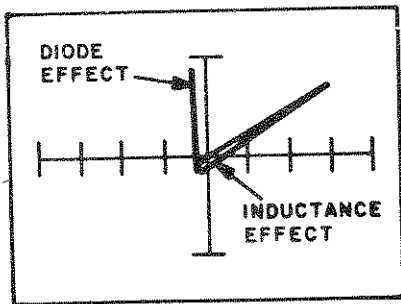

Figure 6-19. Pattern of Good Working Circuit - Low Range

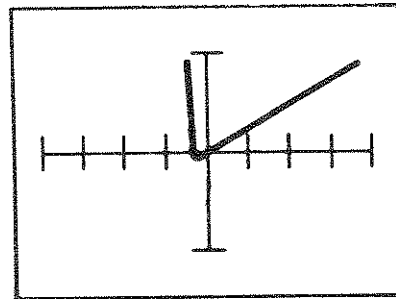

Figure 6-20. Pattern of Open Coil - Low Range

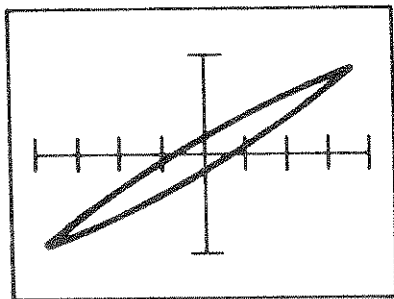

Figure 6-21. Pattern of Open Diode - Low Range

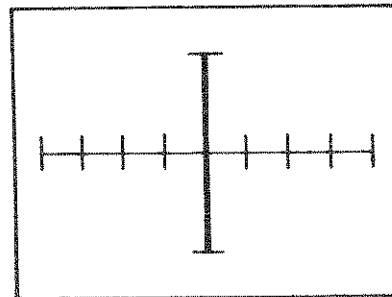

Figure 6-22. Pattern of Shorted Diode - Low Range

# SECTION 7

## TESTING INTEGRATED CIRCUITS

### 7.1 INTRODUCTION

#### 7.1.1 Integrated Circuit Technology

An integrated circuit consists of a single-crystal chip of silicon, typically 50 x 50 mils in cross-section, containing both active and passive elements, plus their interconnections. Such circuits are produced by the same processes used to fabricate individual transistors and diodes. These processes include epitaxial growth, masked impurity diffusion, oxide growth, and oxide etching, using photolithography for pattern definition.

The basic structure of an integrated circuit is shown in Figure 7-1, and consists of four distinct layers of material. The

bottom layer (1) (6 mils thick) is P-type silicon and serves as a substrate upon which the integrated circuit is to be built. The second layer (2), typically 25 mils thick, is an N-type layer which is grown as a single-crystal extension of the substrate. All components are built within the N-type layer using a series of diffusion steps. The third layer of material (3) is silicon oxide, and it also provides protection of the semiconductor surface against contamination. Finally, a fourth metallic (aluminum) layer (4) is added to supply the necessary interconnections between components.

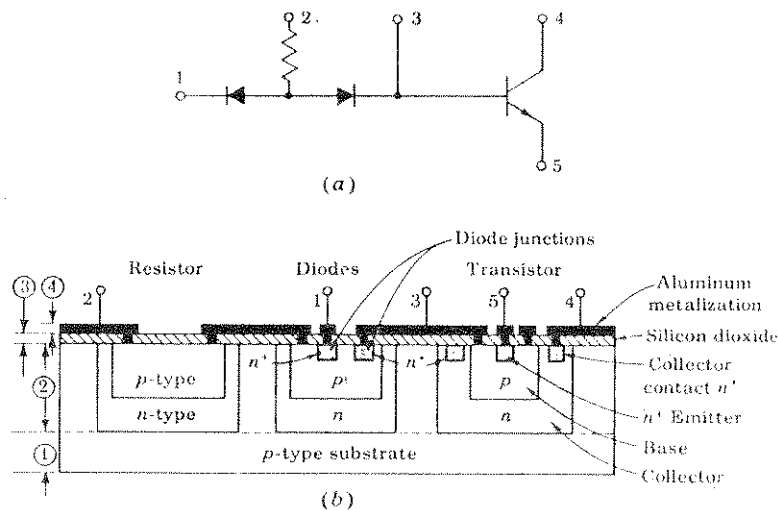

(a) A circuit containing a resistor, two diodes, and a transistor. (b) Cross-sectional view of the circuit in (a) when transformed into a monolithic form (not drawn to scale). The four layers are ① substrate, ② n-type crystal containing the integrated circuit, ③ silicon dioxide, and ④ aluminum metalization. (After Phillips.<sup>2</sup> Not drawn to scale.)

Figure 7-1. Typical Integrated Circuit Construction

## 7.1.2 Integrated Circuits Testing Techniques

So far, this manual has discussed the techniques of testing resistors, capacitors, inductors, diodes, transistors, FETs, and UJTs. All these techniques can be applied to test integrated circuits. The tracker pattern produced across any two pins of an integrated circuit, is a resultant effect of resistors, diodes, transistors, and capacitors. Apply the tracker probes between two pins on an integrated circuit to display the resultant pattern of these composite components.

This section provides information related to testing the following devices:

- Linear operational amplifier
- Linear voltage regulators
- The 555 timer
- TTL digital ICs
- Low power Schottky digital ICs
- CMOS digital ICs

To test an integrated circuit, the tracker leads are connected to two pins at a time. Since the typical integrated circuit has many pins, the number of possible testing combinations becomes very large: for example, a 16-pin device has 240 possible two-pin combinations. It becomes impractical to test

all possibilities, and experience shows that it is adequate to test the input and output pins with respect to  $V+$  and  $V-$  in order to determine whether a device is good or bad.

## 7.2 LINEAR OPERATIONAL AMPLIFIERS

When checking an analog device or circuit, the low range is used a large percentage of the time. Analog circuits have many more single junctions to examine, and these will usually show any flaws more easily in the low range. Also, the 32-ohm internal impedance in the low range makes it less likely that other components, in parallel with the device under test, will load the tracker sufficiently to modify the patterns produced if the device were tested out-of-circuit.

When checking an op-amp in-circuit, it is almost mandatory to do a direct comparison with a known good circuit because the many different feedback loops associated with op-amps may cause an almost infinite number of patterns. Figure 7-2 shows the schematic and connection diagram of a National Semiconductor 1458 op-amp.

Figures 7-3 through 7-6 show the patterns between pin 8 ( $V+$ ) and the other pins of an LM-1458, while Figures 7-7 through 7-9 show the patterns between pin 4 ( $V-$ ) and the other pins.

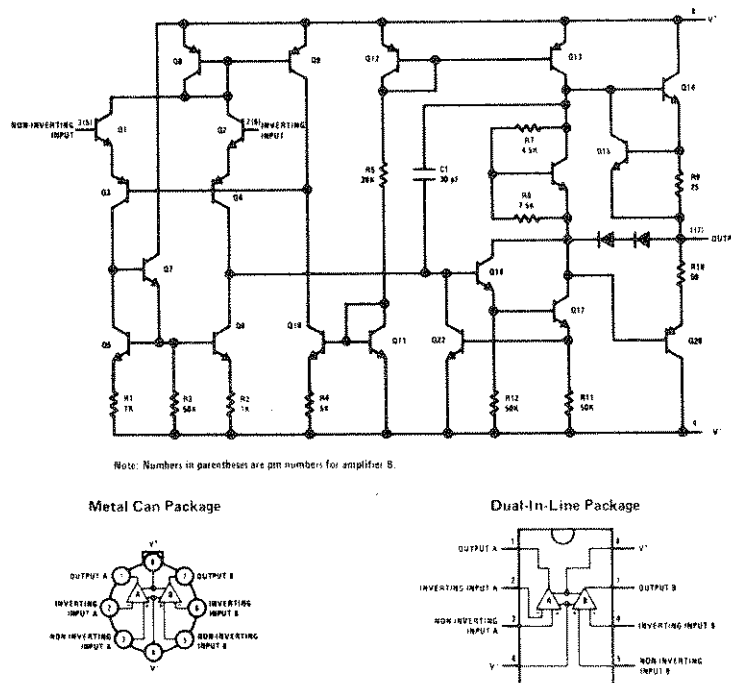

Figure 7-2. The LM-1458 Op-Amp. Schematic and Connections



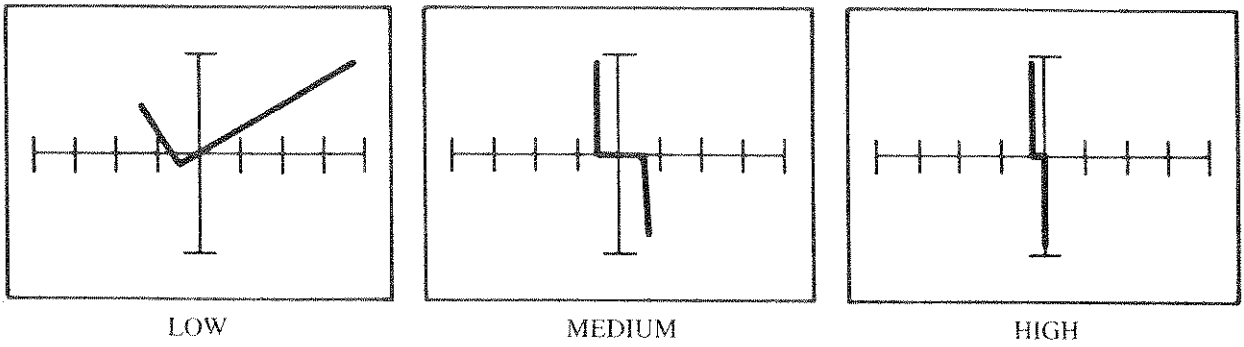

Figure 7-3. Patterns Between Pins 1 and 8 (V + and Output Pin)

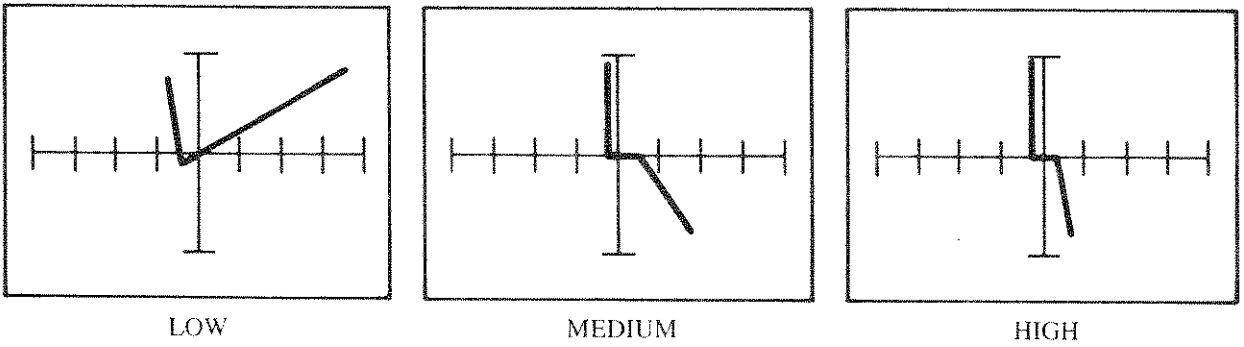

Figure 7-4. Patterns Between Pins 4 and 8 (V + and V-)

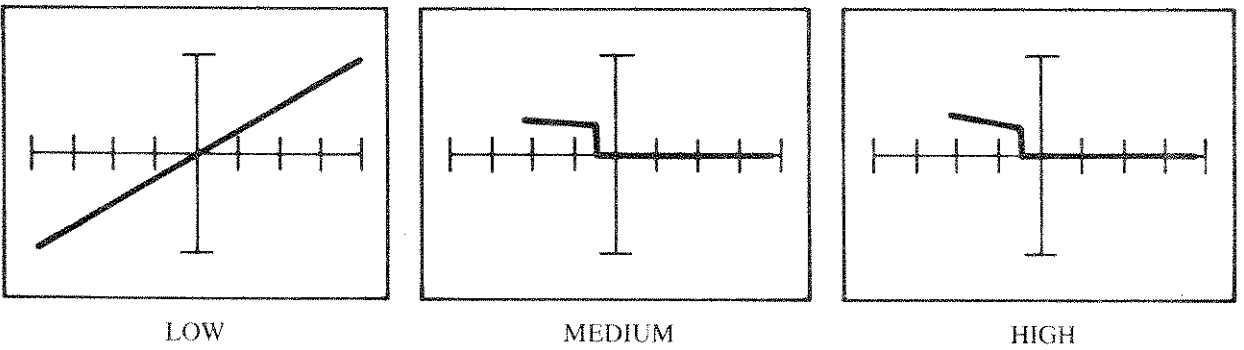

Figure 7-5. Patterns Between Pins 8 and 3 (V + and Non-Inverting Input)

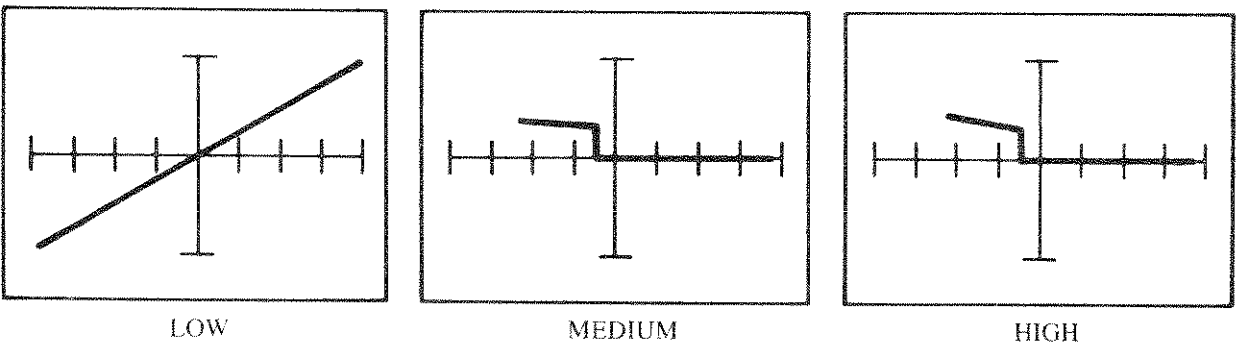

Figure 7-6. Patterns Between Pins 8 and 2 (V + and Inverting Input)

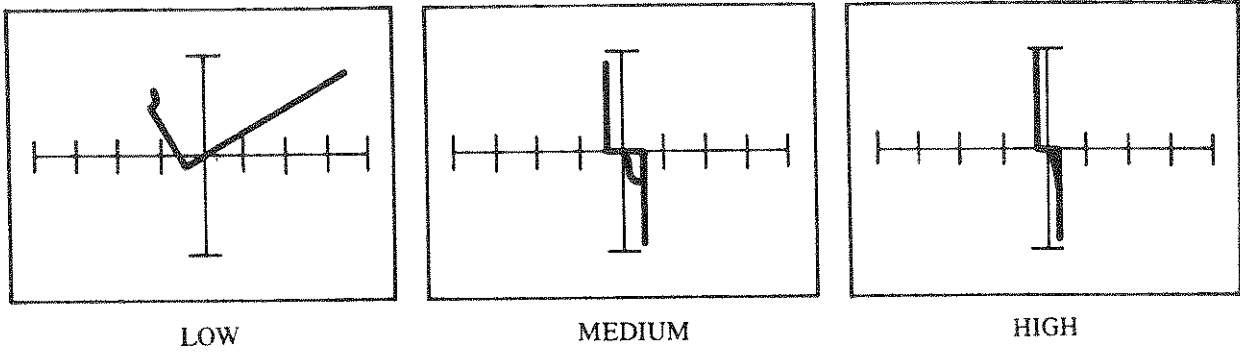

Figure 7-7. Patterns Between Pins 4 and 1 (V- and Output Pin)

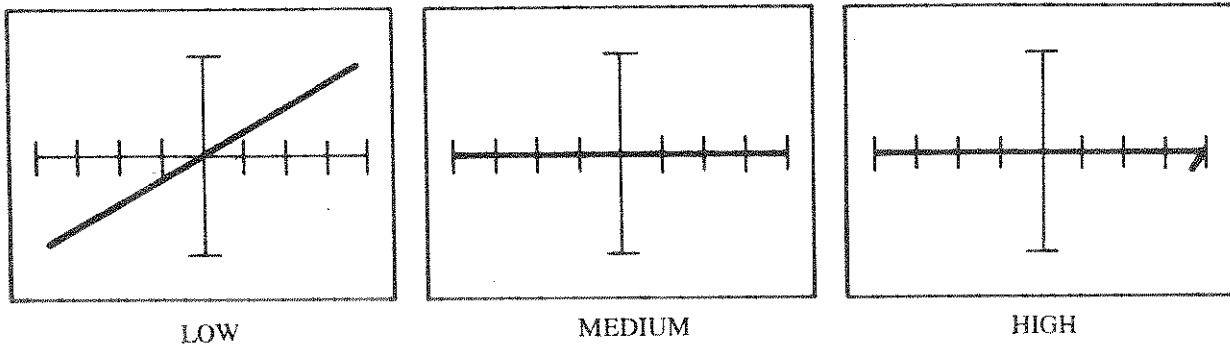

Figure 7-8. Patterns Between Pins 4 and 3 (V- and Non-Inverting Input)

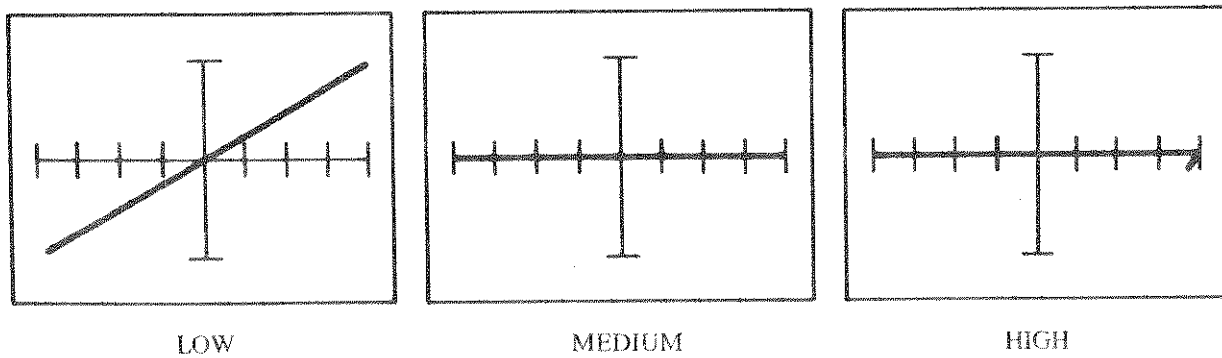

Figure 7-9. Patterns Between Pins 4 and 2 (V- and Inverting Input)

## 7.3 LINEAR VOLTAGE REGULATORS

Voltage regulators, especially 7800 and 7900 series, are used in most pieces of electronic equipment.

### 7.3.1 The 7805 Regulator

Figure 7-10 shows the schematic and the connection of 7805 regulator. Figure 7-11 shows the test connections to the 7805

voltage regulator terminals. Figures 7-12 through 7-14 show the test patterns for a 7805 voltage regulator, and vary for voltages other than 5 volts. Different manufacturers implement their products with different topologies and it is expected that the patterns will vary for the same devices from different manufacturers.

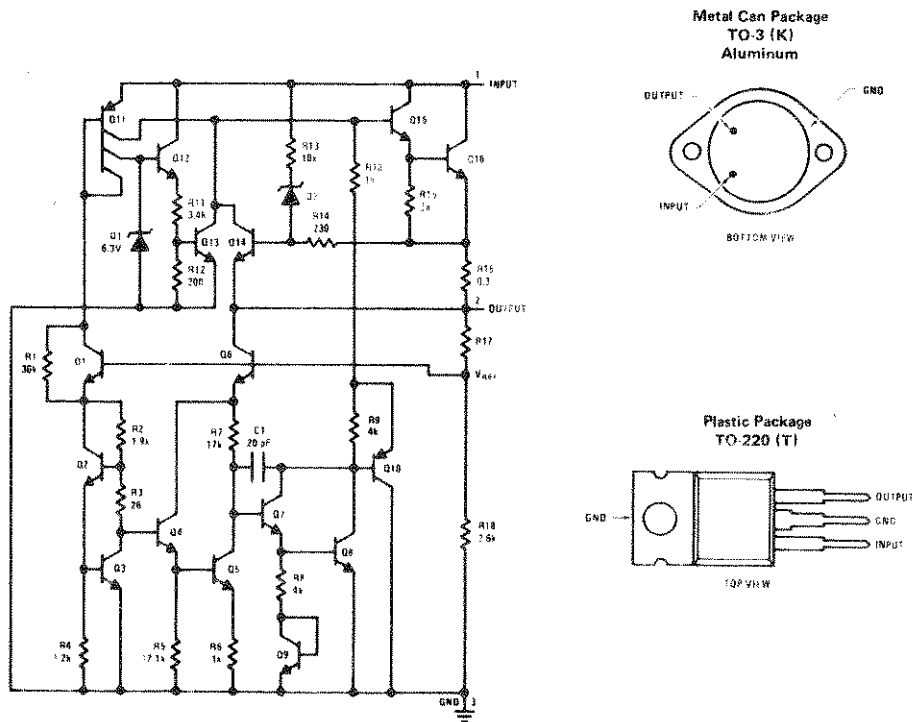

Figure 7-10. 7805 Schematic and Pin Layout

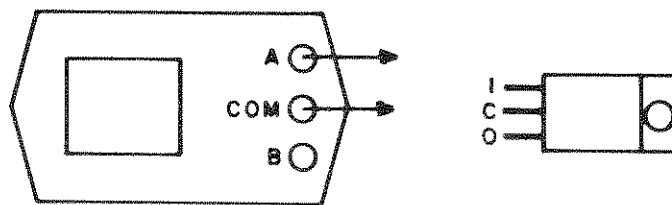

Figure 7-11. Test Connections to the 7805 Regulator

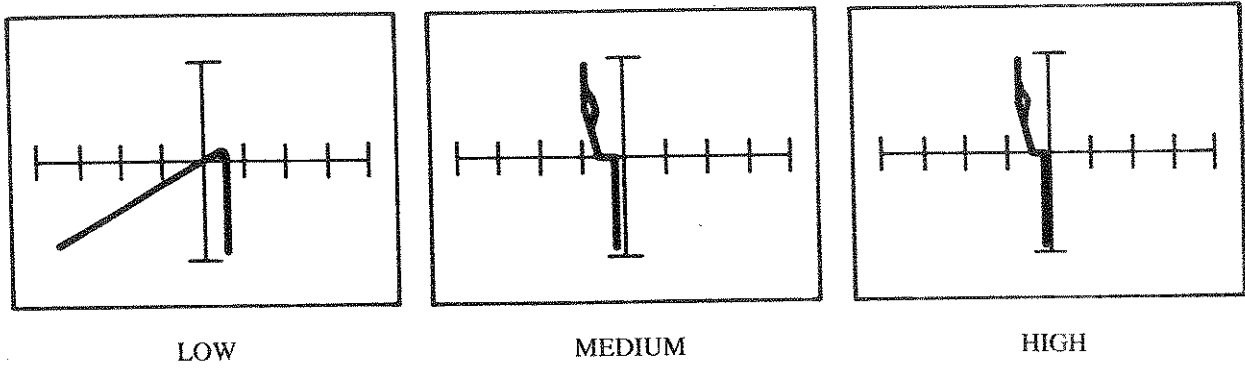

Figure 7-12. Patterns Between Input and Ground Pins - 7805

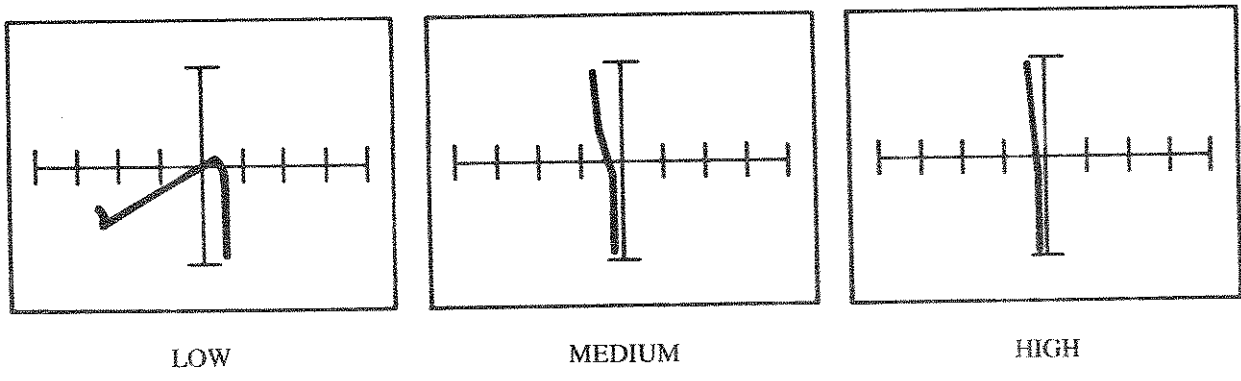

Figure 7-13. Patterns Between Output and Ground Pins - 7805

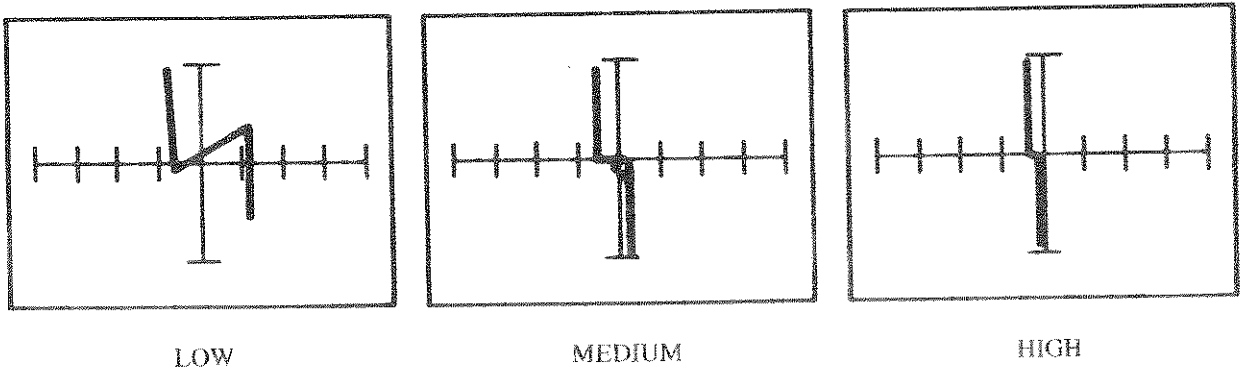

Figure 7-14. Patterns Between Input and Output Pins - 7805

### 7.3.2 The 7905 Regulator

Figure 7-15 shows the schematic and connection diagrams for 7905 negative voltage regulator. Figure 7-16 shows the test connections to the 7905 voltage regulator. Figures 7-17

through 7-19 show the test patterns for a 7905 voltage regulator on all ranges. Again, these patterns are for references only and change slightly from manufacturer to manufacturer.

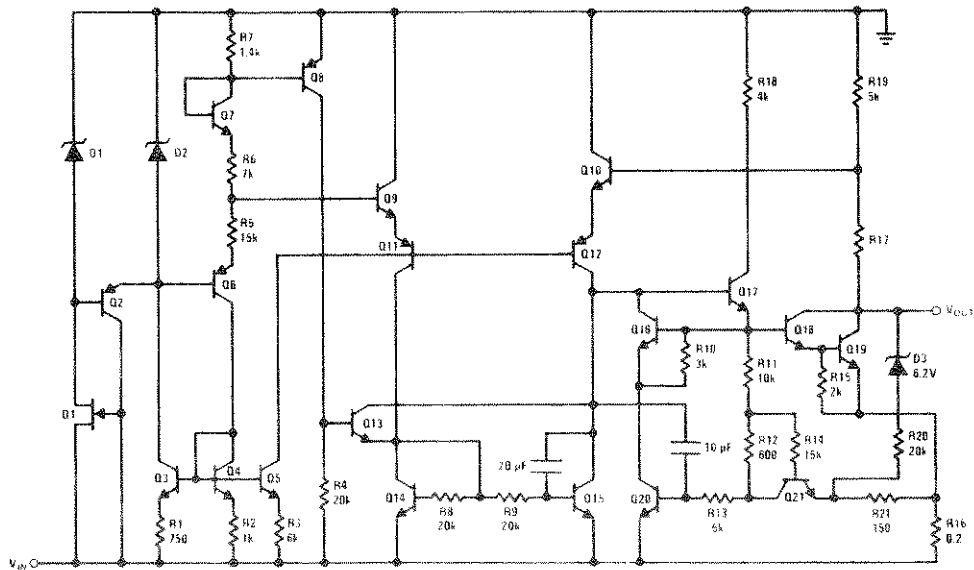

Figure 7-15. Schematic and Connections of the 7905 Regulator

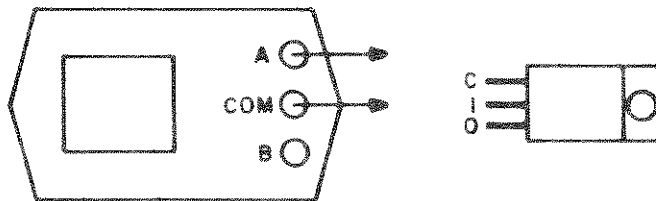

Figure 7-16. Test Connections to the 7905 Regulator

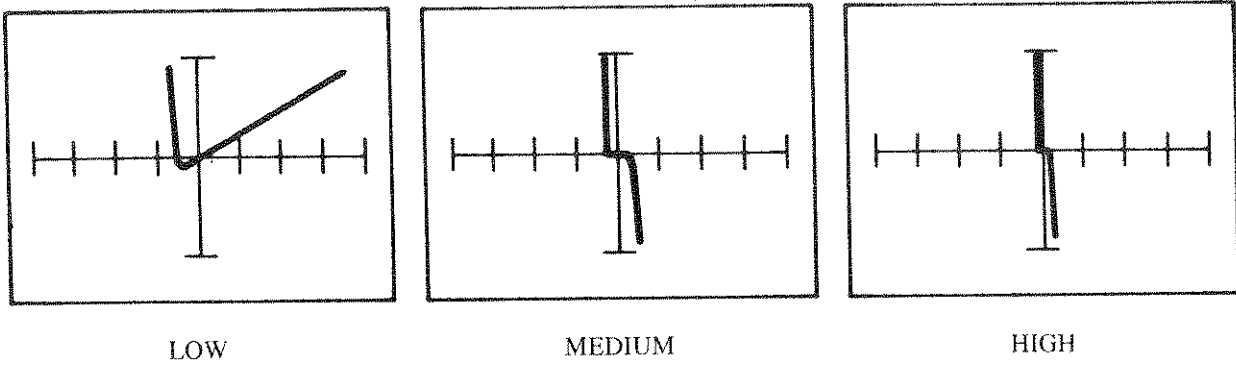

Figure 7-17. Patterns Between Input and Ground Pins - 7905

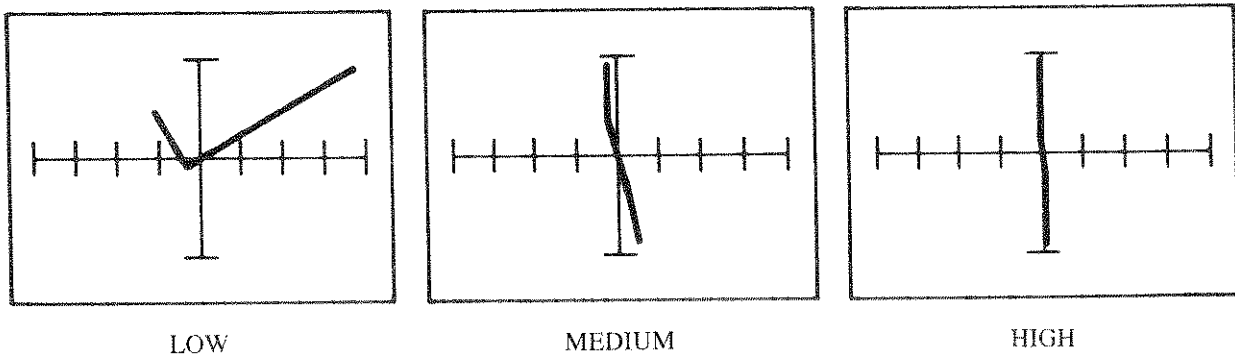

Figure 7-18. Patterns Between Output and Ground Pins - 7905

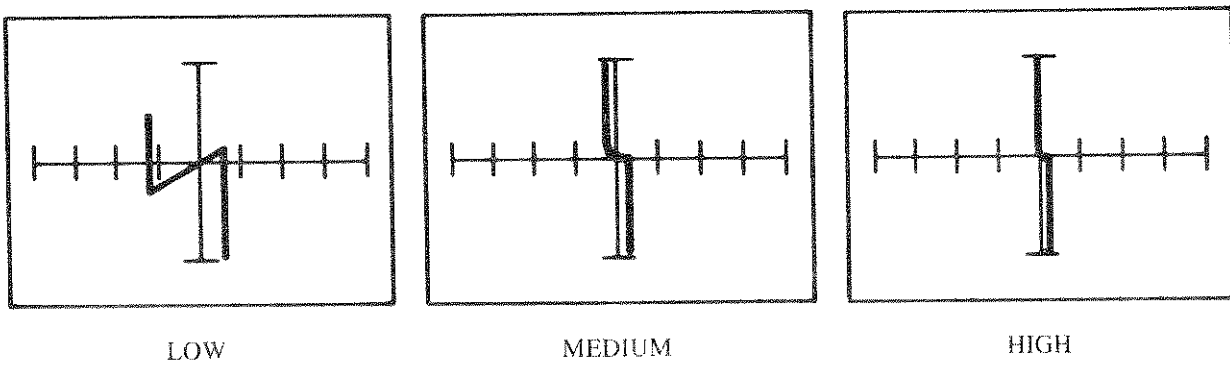

Figure 7-19. Patterns Between Input and Output Pins - 7905

## 7.4 555 TIMERS

The 555 timer is a popular linear integrated circuit, and is used in precision timing, pulse generation, and pulse width modulation applications. The tracker is used to examine patterns between various pins with respect to ground. Figure

7-20 shows the schematic and connection diagram of the National Semiconductor LM555 timer. Figure 7-21 shows the test connections of the LM555 to the tracker.

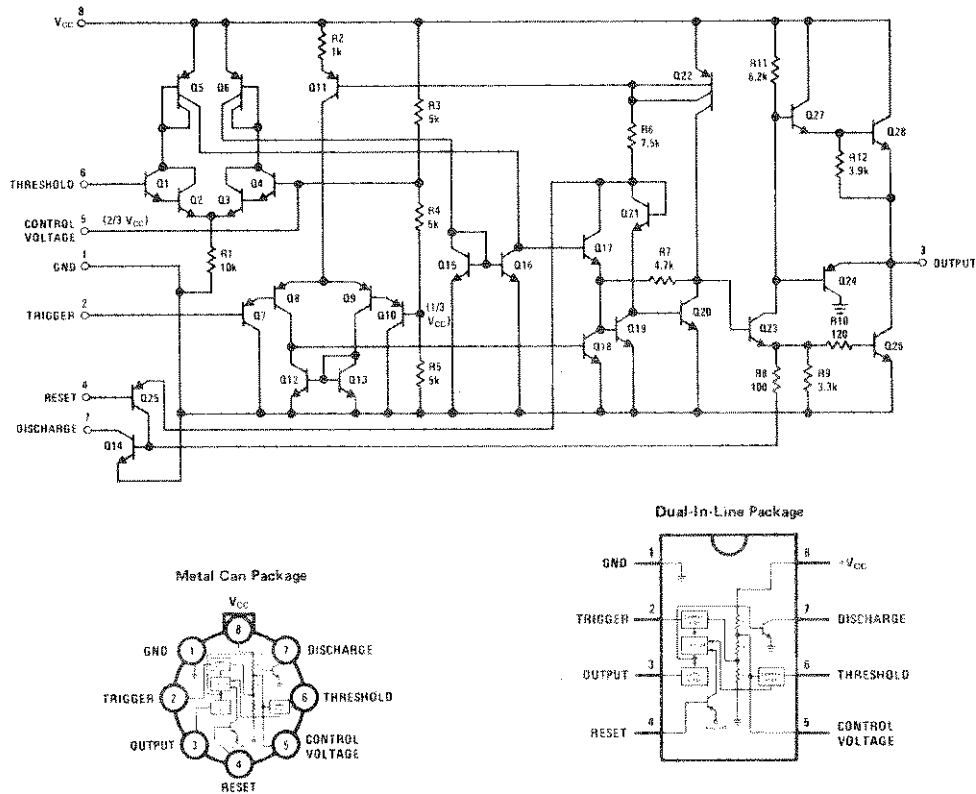

Figure 7-20. Schematic and Connection Diagram of LM555 Timer

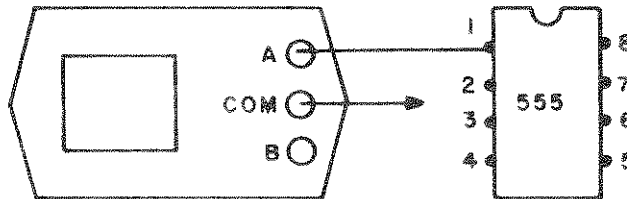

Figure 7-21. Test Connections to the LM555 Timer

Figures 7-22 through 7-25, and 7-27 through 7-29, show the patterns between different pins of the LM555 using all ranges of the tracker. In Figure 7-22, the tracker displays the base-collector junction of transistor Q7 (see Figure 7-20).

Figure 7-24 shows the patterns between pins 4 (reset) and 1. In this case, the tracker displays the junctions cascaded by transistors Q25 and Q14 (see Figure 7-20). Consequently, a transistor pattern is expected.

Figure 7-25 shows test patterns between pins 5 (control voltage) and 1. Pin 5 is connected to resistors R3, R4, R5, and the Darlington transistor formed by Q3 and Q4. Refer also to Figure 7-26. The impedance between pins 5 and 4 is too high to cause any significant effect in low range. As a result, a diagonal line, slightly rotated, is produced.

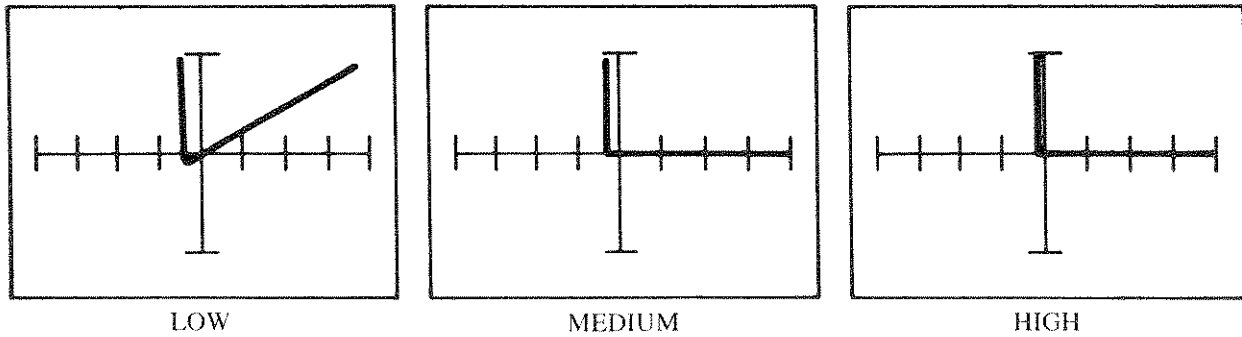

Figure 7-22. Patterns Between Pins 2 and 1

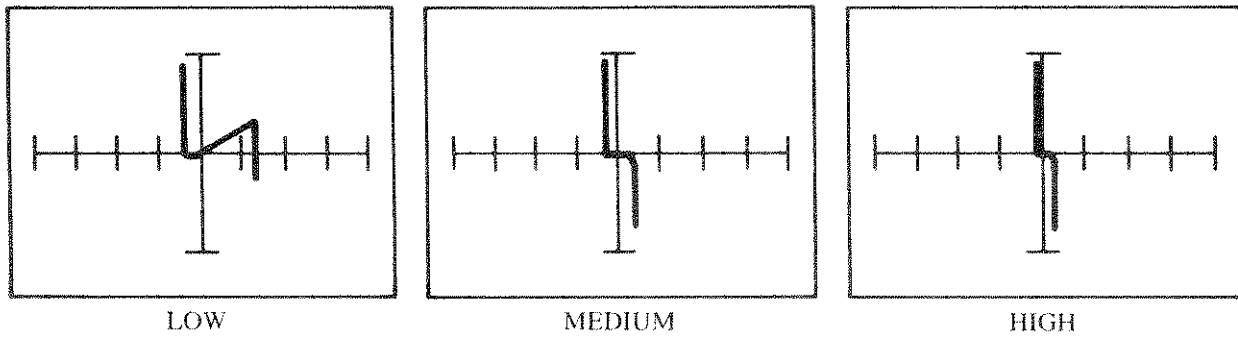

Figure 7-23. Patterns Between Pins 3 (Output) and 1

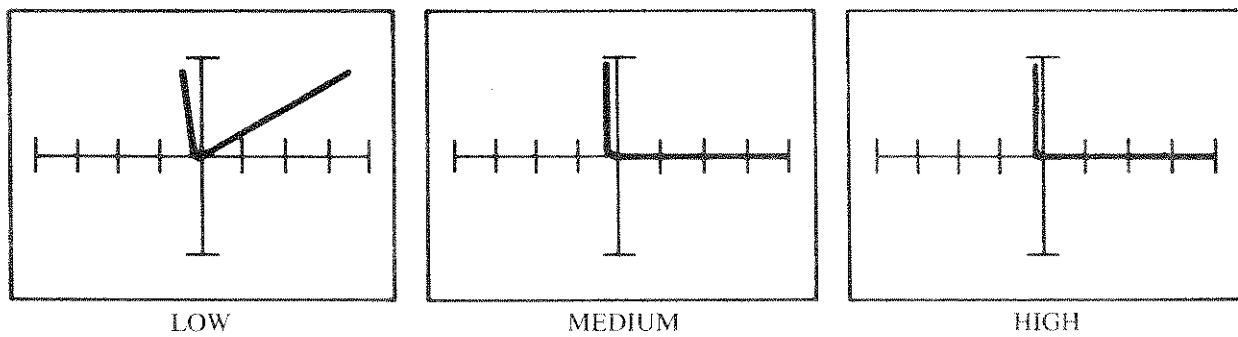

Figure 7-24. Patterns Between Pins 4 (reset) and 1

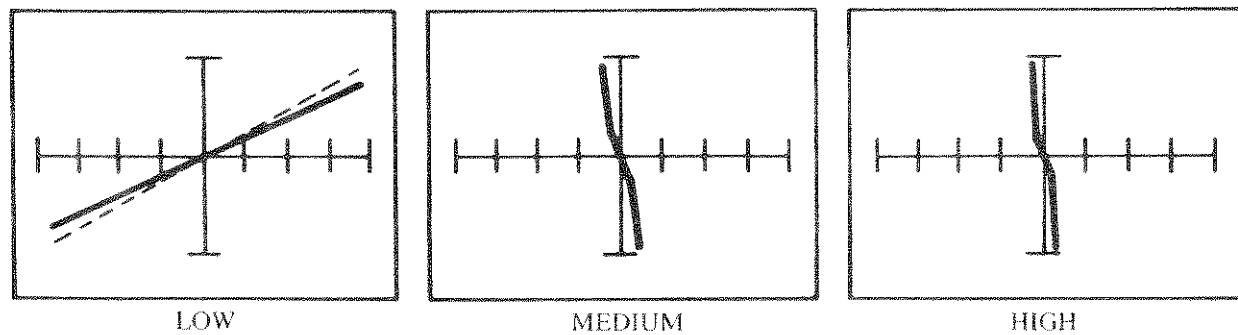

Figure 7-25. Patterns Between Pins 5 (control voltage) and 1



Figure 7-27 shows test patterns between pins 6 and 1. Pin 6 is connected to a darlington transistor (formed by Q1 and Q2) which is in series with resistor R1 (10k resistor). The impedance is too high to show much change in the low range.

Figure 7-28 shows test patterns between pins 7 and 1. These pins are connected to the collector and emitter of Q14. A typical transistor C-E pattern is seen.

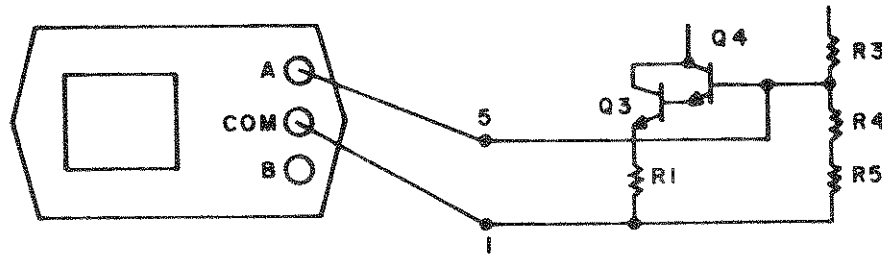

Figure 7-26. Connection of LM555 Pins 1 and 5 to the Tracker

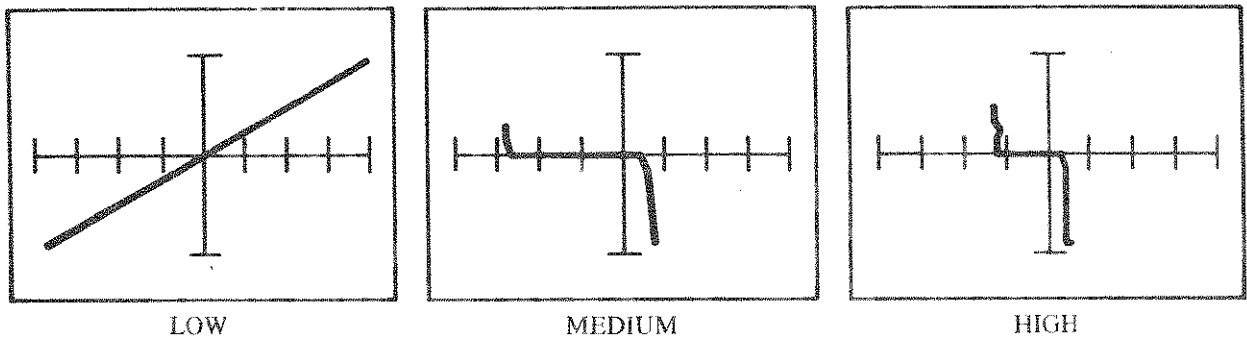

Figure 7-27. Patterns Between Pins 6 and 1

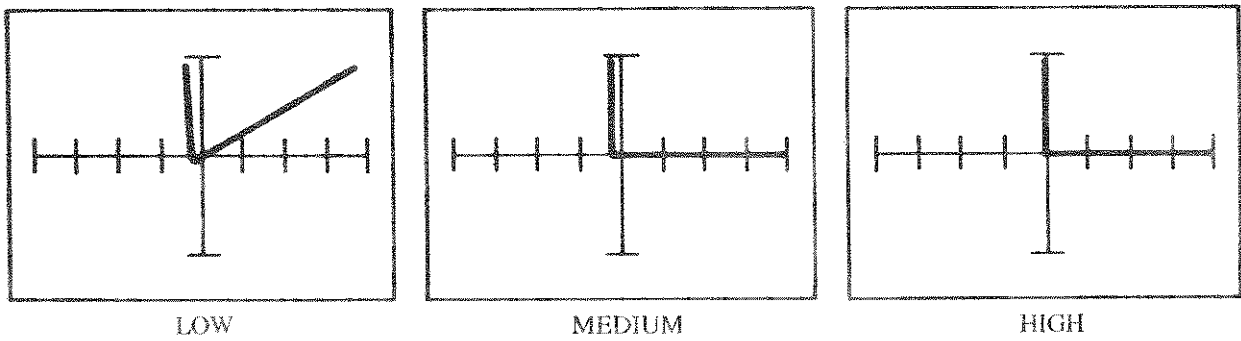

Figure 7-28. Patterns Between Pins 7 and 1

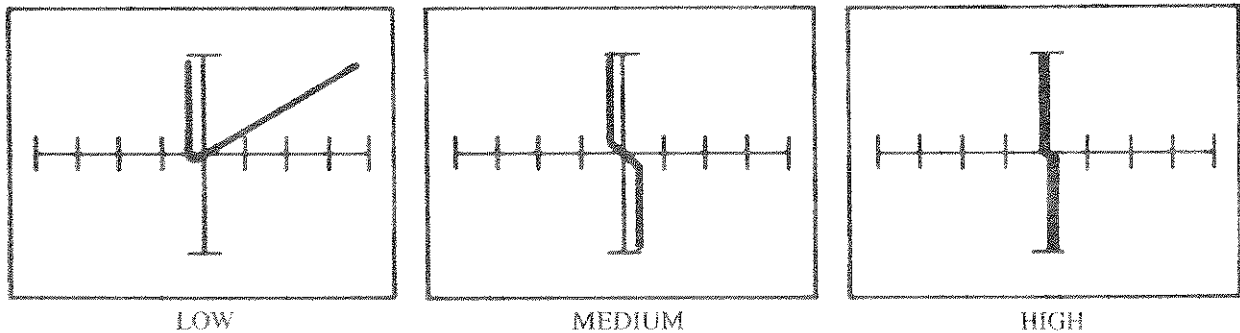

Figure 7-29. Patterns Between Pins 8 (Vcc) and 1 (a) (b) (c) (d) (e)

## 7.5 TTL DIGITAL INTEGRATED CIRCUITS

### 7.5.1 General

The schematics of the basic gates of the various families are shown in Figure 7-30a, b, c, d, and e. All are similar, containing an input and gate, a phase splitter (Q2) with emitter and collector load resistors, a pull-up mechanism (Q3/Q4) and a pull-down transistor (Q5). In all except LS-TTL circuits, the AND function is formed by a multi-emitter transistor in which the emitter-base junctions serve to isolate the input signal sources from each other.

The inputs of these gates contain input protection diodes. To test a digital IC, we need to examine:

- Inputs with respect to ground to see if the input diode and transistor are damaged or not.
- Output pin with respect to ground to see if the C-E junction of Q5 transistor is still good.
- Output pin with respect to Vcc to see if transistor Q4 is still good
- Vcc with respect to ground. Generally, the tracker can "catch" flaws caused by overloading.

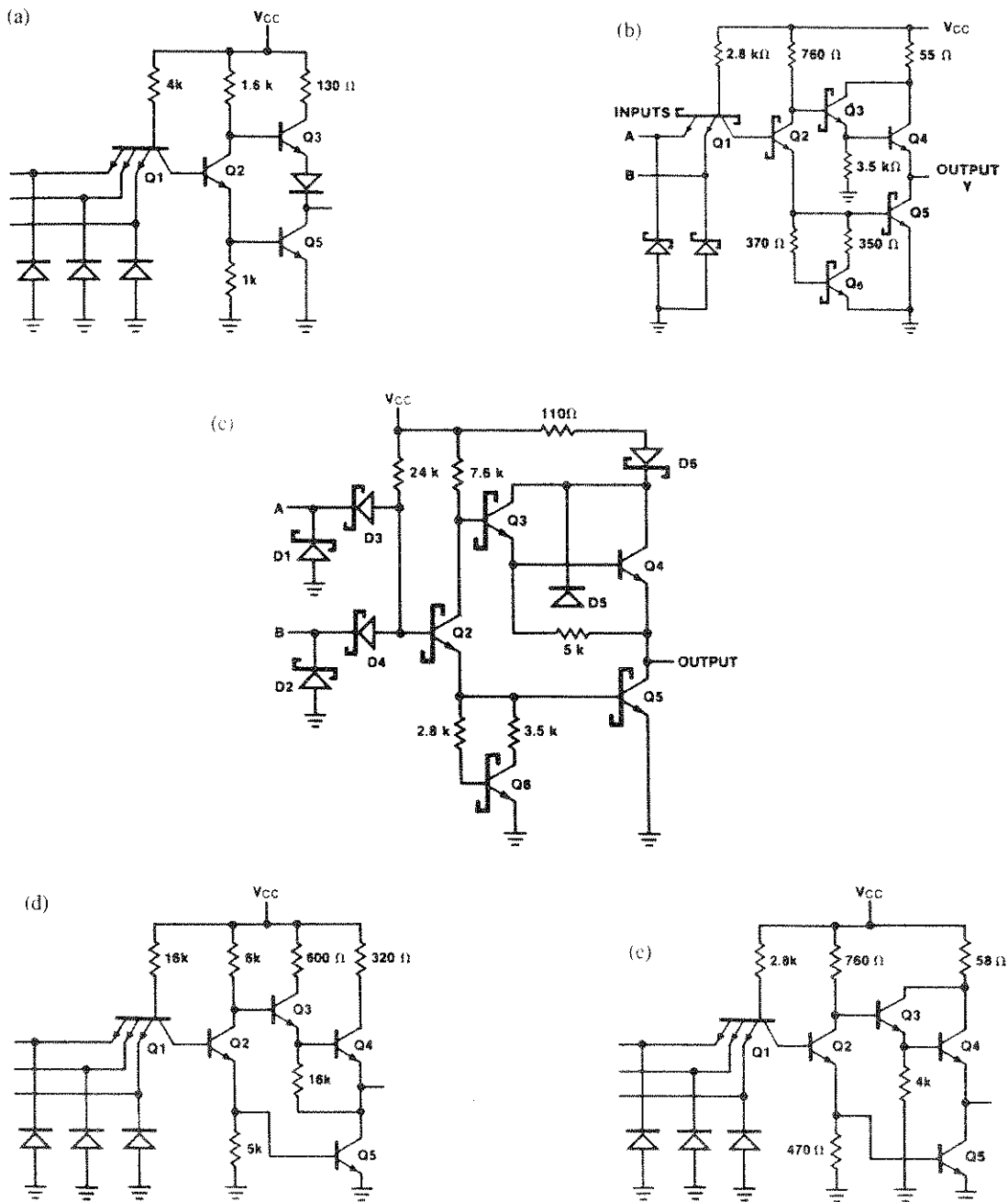

Figure 7-30. Various TTL Implementation

## 7.5.2 TTL Devices

Figure 7-31 shows the tracker test connections to a 7410 NAND gate. Figures 7-32 through 7-35 show the patterns of input, output, and  $V_{cc}$  with respect to ground of the 7410 TTL device. As mentioned previously, the test patterns may vary from device to device, and from manufacturer to manufacturer, depending on the level of doping and logic implementation.

Figure 7-32 shows test patterns taken between input and ground. In the low range, the input protection diode pattern is represented by ABC instead of ABD (as a regular diode

would have been represented). The difference between a regular diode and protection diode is that protection diode has a 50-ohm resistance in series with the diode junction.

Figure 7-33 shows the test patterns between output and ground. In low range, the test voltage is not high enough to cause non-destructive breakdown. These patterns are typical transistor C-E junction patterns.

Figure 7-34 shows the test patterns between  $V_{cc}$  and ground.

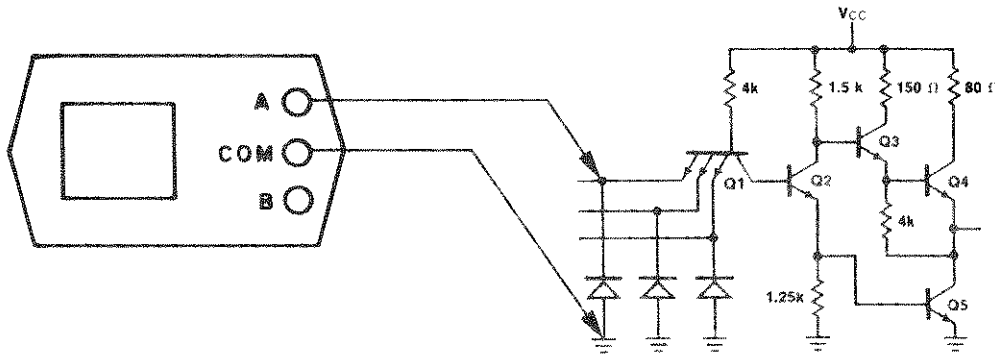

Figure 7-31. Test Circuit for the 7410 NAND Gate

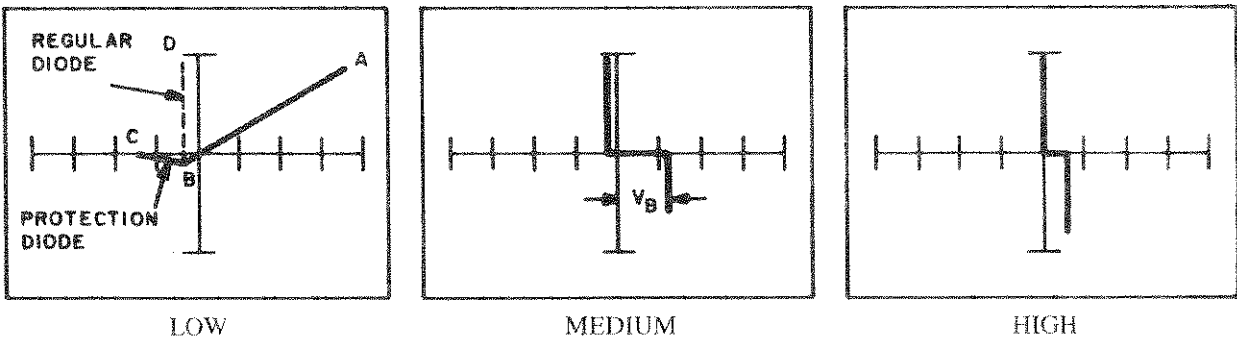

Figure 7-32. Patterns Between Input and Ground - 7410

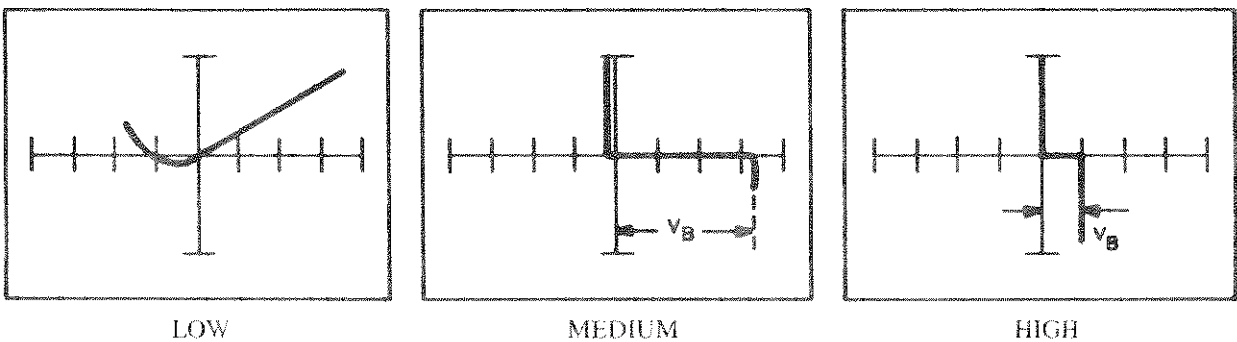

Figure 7-33. Patterns Between Output and Ground - 7410

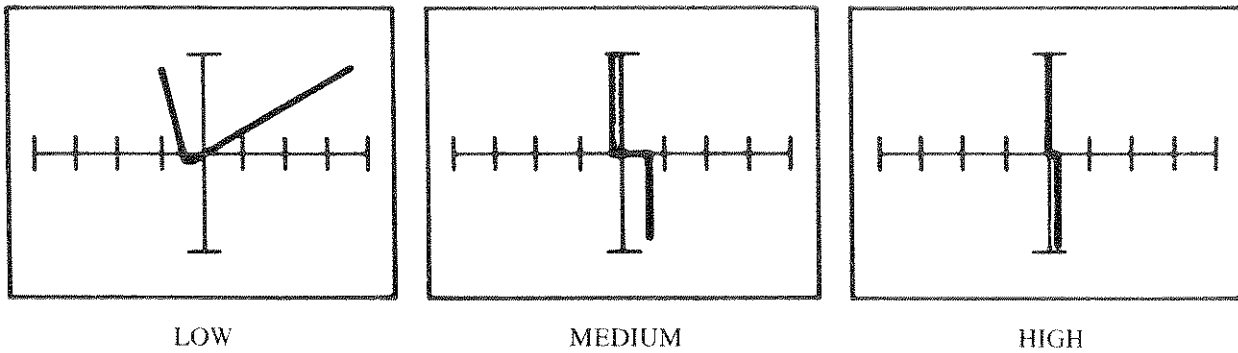

Figure 7-34. Patterns Between Vcc and Ground - 7410

### 7.5.3 LS TTL Devices

Implementation of LS digital ICs is different from others (refer to Figure 7-30). LS series are not implemented with

multiple-emitter transistor topology. Figures 7-35 through 7-37 show test patterns between different pins of a 74LS00.

NOTE: THE HIGH RANGE SHOWS THE REVERSE BREAKDOWN VOLTAGE

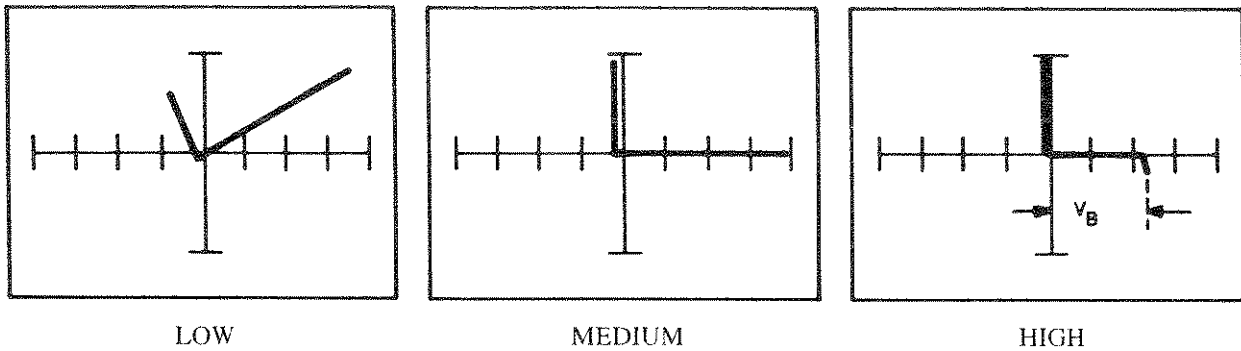

Figure 7-35. Patterns Between Input and Ground - 74LS00

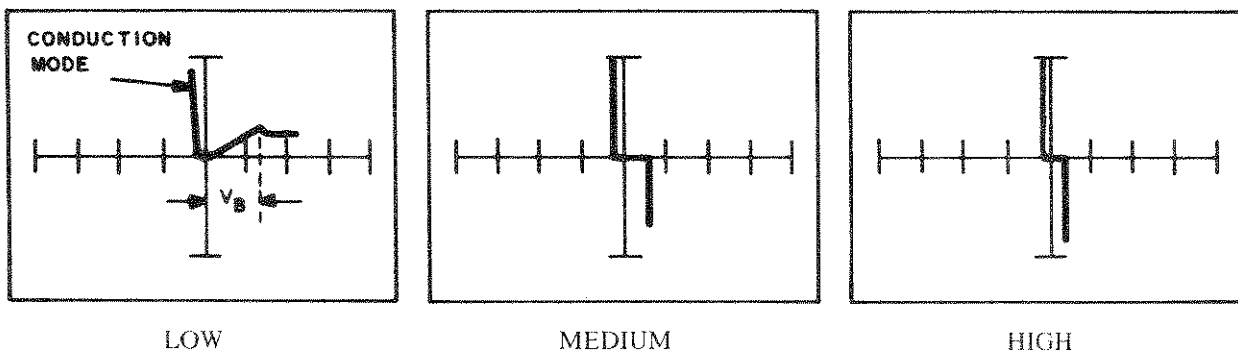

Figure 7-36. Patterns Between Output and Ground - 74LS00

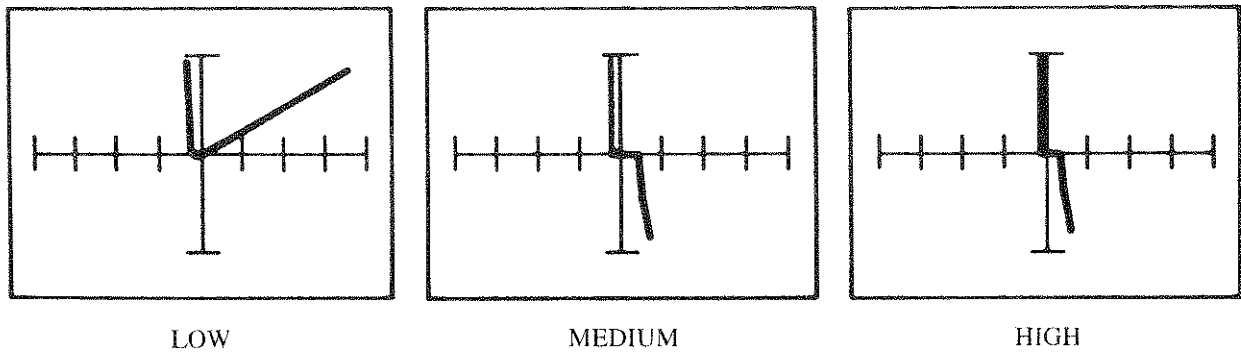

Figure 7-37. Patterns Between Vcc and Ground - 74LS00

### 7.5.4 Tri-State TTL Digital Devices

In the later, or tri-state, TTL families, there are many circuits that have an auxiliary control input that allows both the output pull-up and pull-down circuitry to be disabled. This condition is called the high impedance (high Z) state and allows the outputs of different circuits to be connected to a common line or data bus. Figure 7-38 shows a typical tri-state

output device. The device to be tested has power off, so the enable pin is considered just another input pin, and tri-state devices are tested in the same manner as other TTL devices except their patterns are different. It is extremely easy to test a tri-state device when compared with a known-good device. Figure 7-39 shows a connection diagram of 74125.

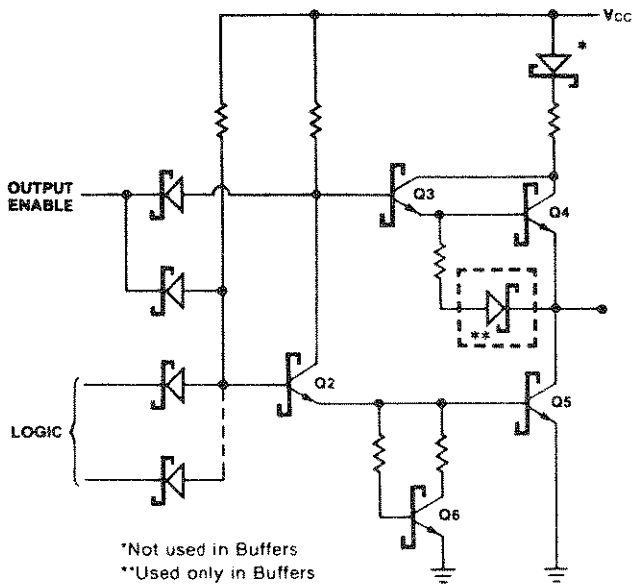

Figure 7-38. Typical Tri-State Output Control

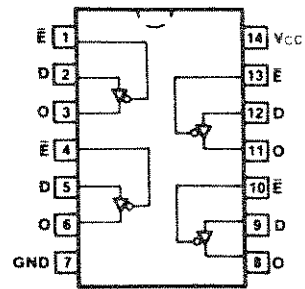

Figure 7-39. Connection Diagram of a 74125

Figures 7-40 through 7-42 show patterns of a 74L25 tri-state buffer taken at different pins. The test patterns shown in

Figure 7-40 look like those of a typical diode with reverse breakdown voltage  $V_B$ .

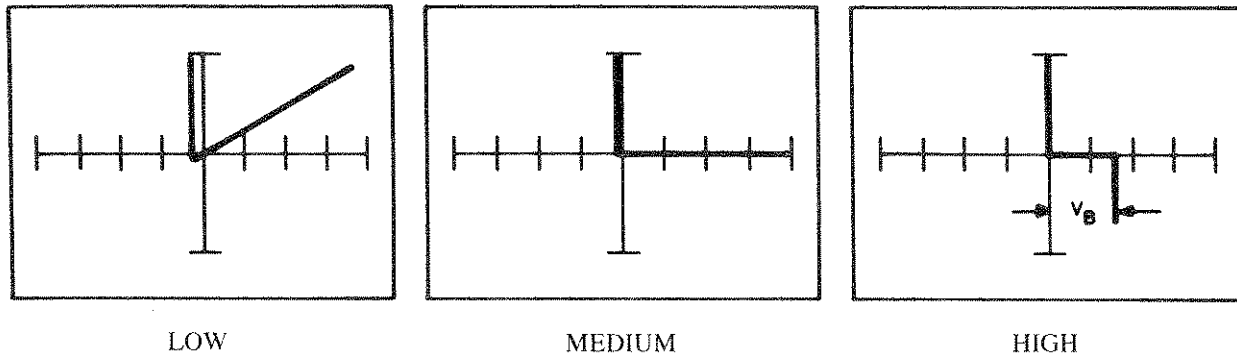

Figure 7-40. Pattern Between Enable Pin and Ground

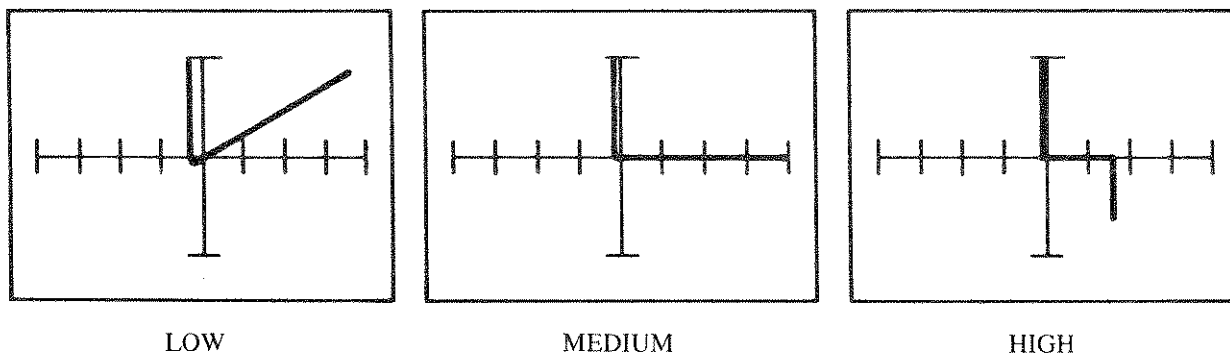

Figure 7-41. Pattern Between Input Pin and Ground

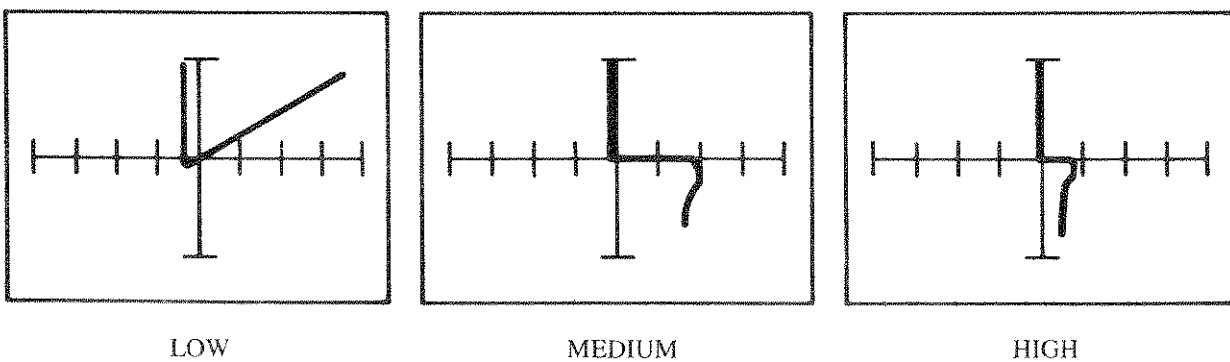

Figure 7-42. Pattern Between Output Pin and Ground

## 7.6 CMOS INTEGRATED CIRCUITS

NOTE: Tests were conducted in a independent laboratory to show that all ranges are safe to test CMOS, MOS and low power Schottky devices. Refer to the Appendixes at the back of this manual.

The CMOS IC has become very popular because of its low power consumption and high noise immunity. Figure 7-43 shows the schematic and connection diagram of RCA CD4011UB CMOS NAND gate. All CMOS input pins have protection diodes which have fairly high dc resistance. Thus, in low range, the tracker does not produce a diode pattern.

Figures 7-44 through 7-46 show tracker patterns between different pins of the CD4011UB.

Figure 7-44 shows the test patterns between the input pin and ground of the CD4011. In the low range, the pattern does not look like that of a regular diode because of high input resistance in series with protection diodes. In the medium and high ranges, the solid trace is moving back and forth between A and B as indicated by the dotted traces. This is due to the beating of the oscillator frequency and the power supply frequency.

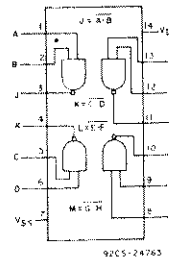
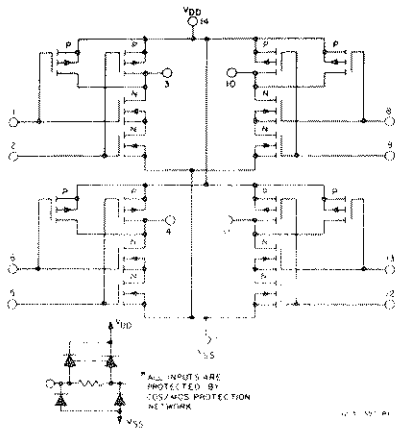

Figure 7-43. Schematic and Connection Diagram of a CD4011UB

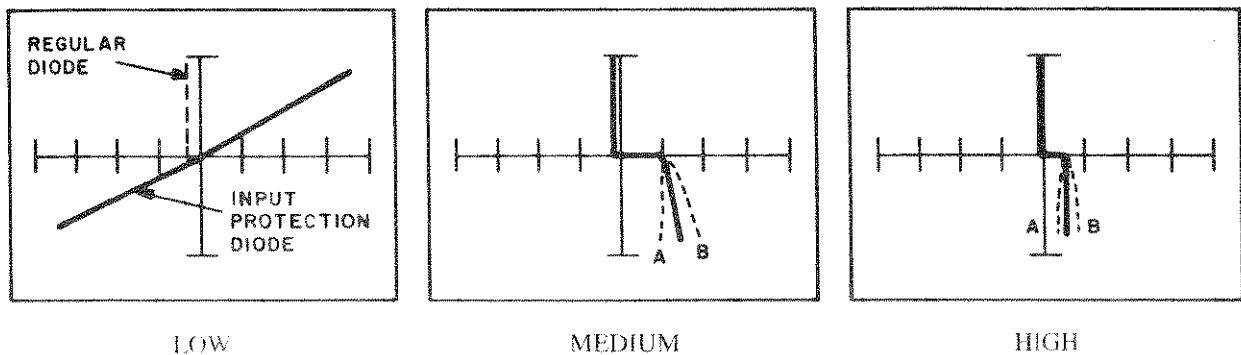

Figure 7-44. Patterns Between the Input Pin and Ground - CD4011

Figure 7-45 shows the test patterns between the output pin and ground of the CD4011. The tracker displays the two lower transistors which are connected in series.

Figure 7-46 shows the test patterns between the Vcc and ground pins of the CD4011. In the low range, the trace looks like that of a diode. Again, in the medium and high ranges, the traces show a beating effect.

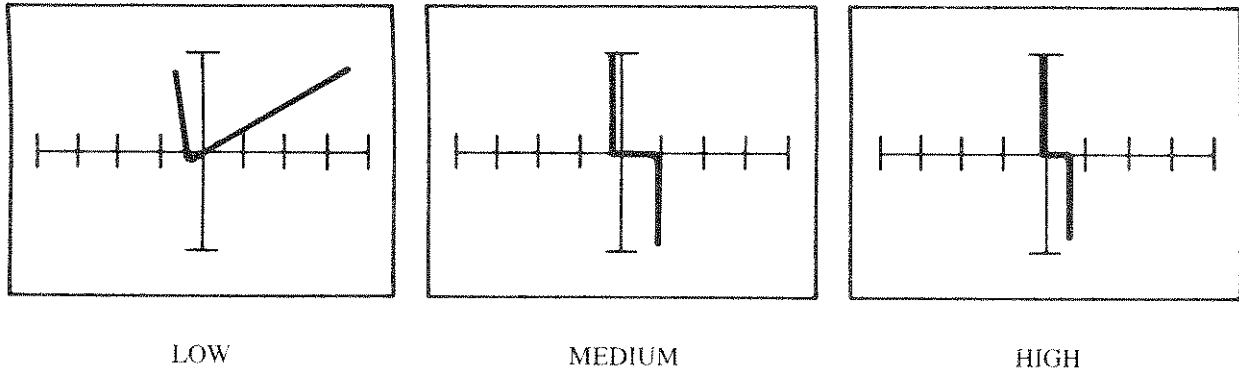

Figure 7-45. Patterns Between the Output Pin and Ground - CD4011

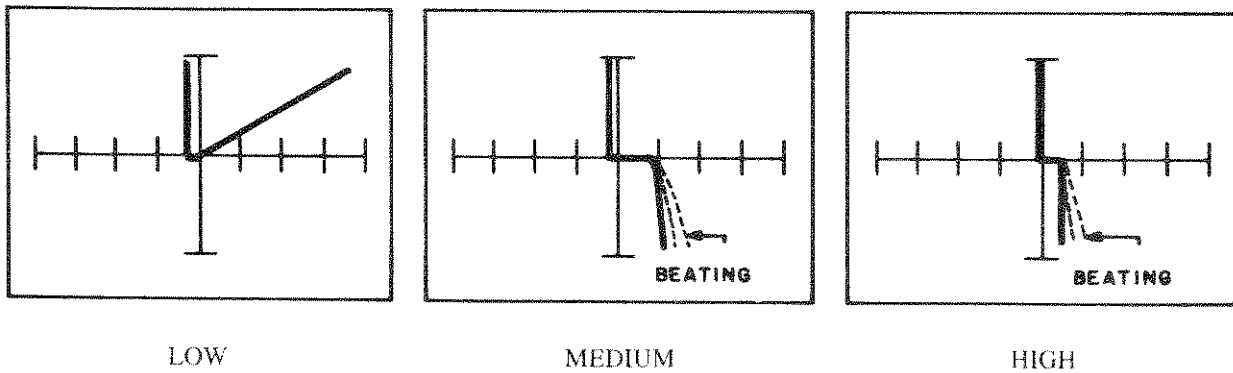

Figure 7-46. Patterns Between the Vcc Pin and Ground - CD4011



## 7.7 MICROPROCESSORS

NOTE: Tests were conducted in a independent laboratory to show that all tracker ranges are safe to test CMOS, MOS and low power Schottky devices. Refer to the Appendixes at the back of this manual.

Figure 7-47 shows the test patterns between pins 11 and 12 of an 8080 microprocessor. The tracker displays an internal

short when used in the low range, while the medium range is used to indicate a good device.

Figure 7-48 shows the test patterns between pins 11 and 24 of an 8080 microprocessor, using the tracker in the medium range.

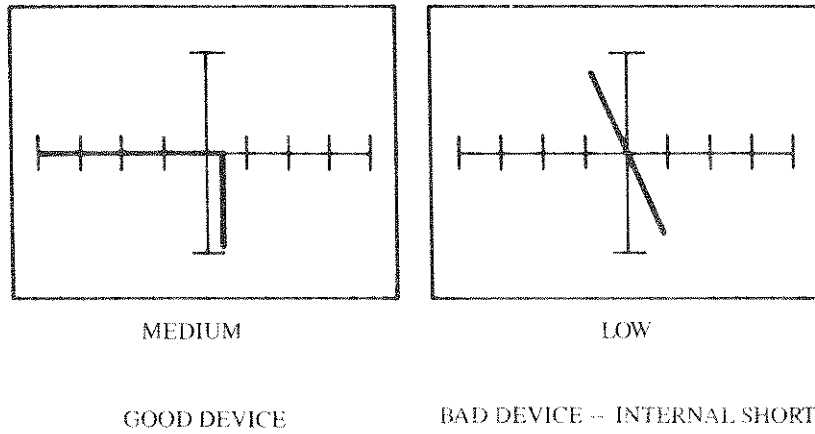

Figure 7-47. Patterns Between 8080 Pins 11 and 12

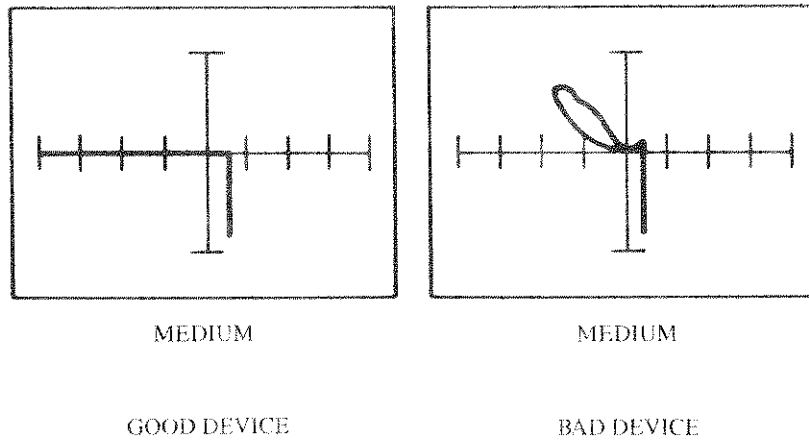

Figure 7-48. Patterns Between 8080 Pins 11 and 24

**NOTES:**

# SECTION 8

## TESTING RECTIFIERS

### 8.1 SILICON CONTROLLED RECTIFIERS (SCR)

The silicon controlled rectifier is a modification of a Schottky diode. A gate connection is formed to the lower P layer of the NPNP structure. As shown in Figure 8-1.

Between the gate and cathode, there is diode D1. If the tracker is connected to the gate and cathode as shown in Figure 8-2, a diode pattern appears on the display as shown in Figure 8-3.

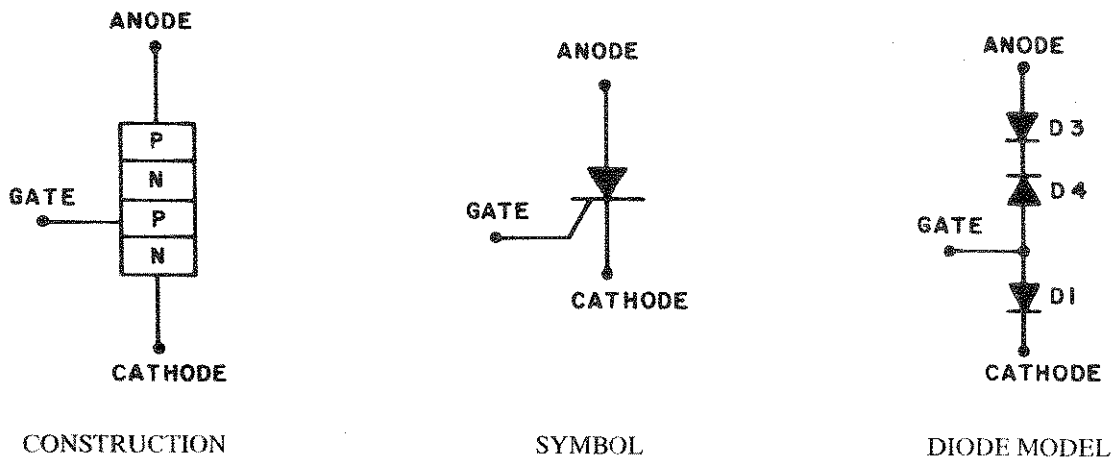

Figure 8-1. Silicon Controlled Rectifier (SCR)

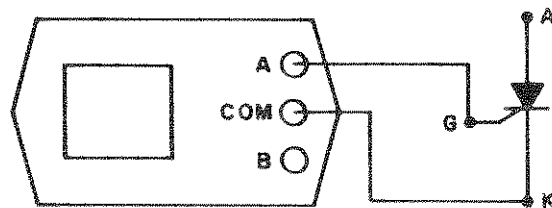

Figure 8-2. Test Circuit for the C103 SCR

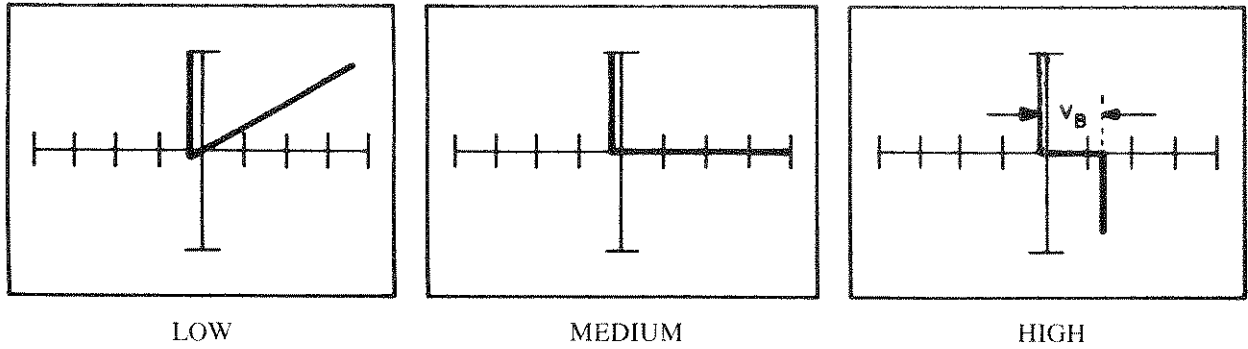

Figure 8-3. Test Patterns Between Gate and Cathode of a GE C103 SCR

Between the gate and anode, two diodes, D2 and D3, are connected back-to-back. The tracker displays the back-to-back diodes as an open circuit. Testing across the anode and cathode terminals also appears as an open circuit to the tracker. Figure 8-4 shows the tracker connections to test the anode and gate. Figure 8-5 shows the connections to test the anode and cathode.

Figure 8-6 shows the test patterns of an anode with respect to the gate or cathode of a C103 SCR. For a good SCR, they should be open-circuit in all ranges.

NOTE: HUNTRON TRACKER MODEL 2000 DYNAMICALLY TESTS SCR AND TRIAC DEVICES.

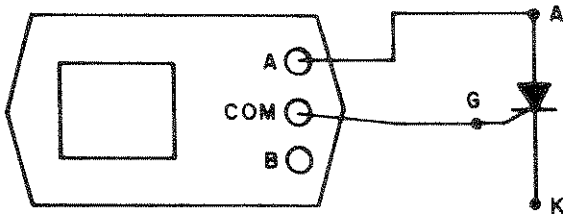

Figure 8-4. Anode and Gate Test Connections

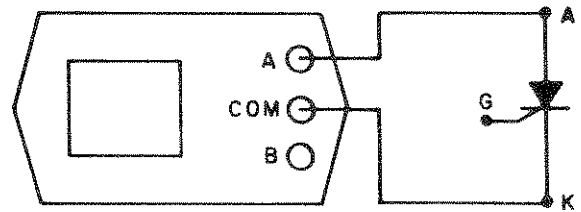

Figure 8-5. Anode and Cathode Test Connections

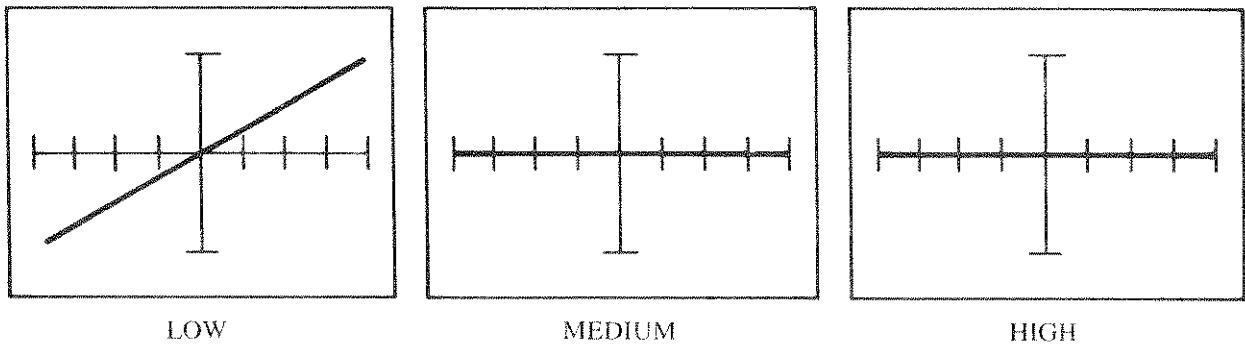

Figure 8-6. Test Patterns for a C103 SCR

## 8.2 TESTING TRIAC DEVICES

The TRIAC is a bidirectional triode thyristor that has been developed to extend the positive or negative supply of an SCR to allow firing on either polarity with either positive or negative gate current pulses. Figure 8-7 shows the construction and symbol of a TRIAC.

Apply tracker probes to the TRIAC 2N6070 as shown in Figure 8-8. Between gate and A2, there are two diodes in parallel.

Apply the tracker probes as shown in Figure 8-10. The tracker should display an open circuit in all ranges.

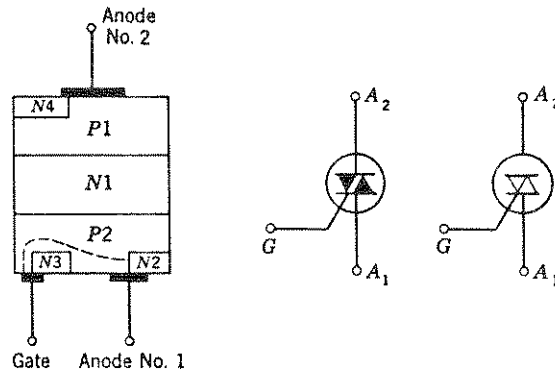

Figure 8-7. The Construction and Symbol of a TRIAC

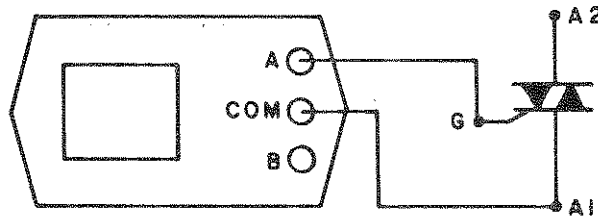

Figure 8-8. The Test Circuit for the TRIAC

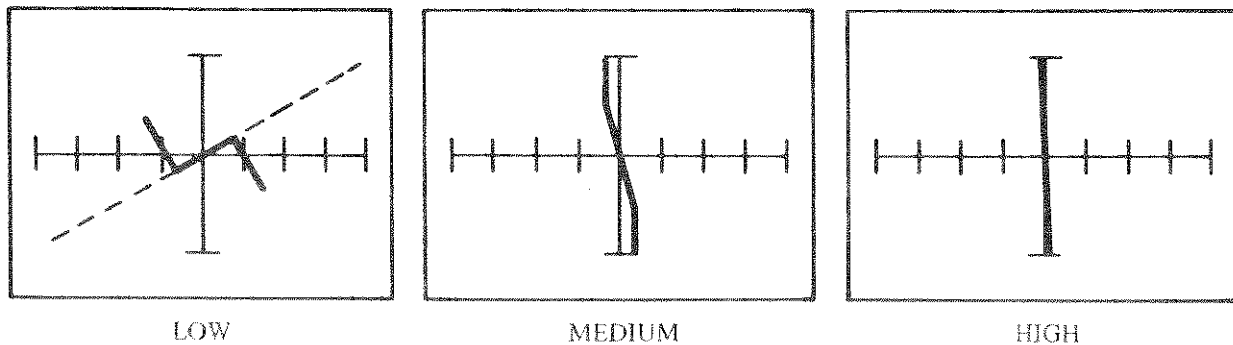
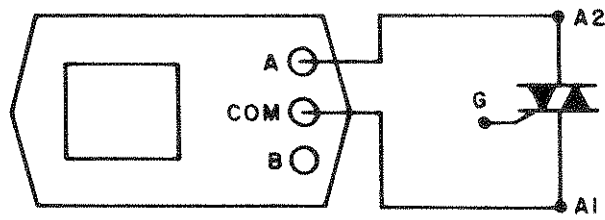
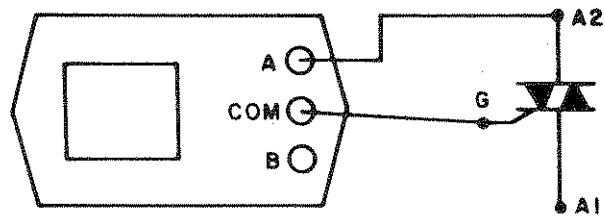

Figure 8-9. Test Patterns Between G and A1 - Motorola TRIAC 2N6070



TEST A2 AND A1



TEST A1 AND G

Figure 8-10. Test Connections for A2 and A1, A1 and G

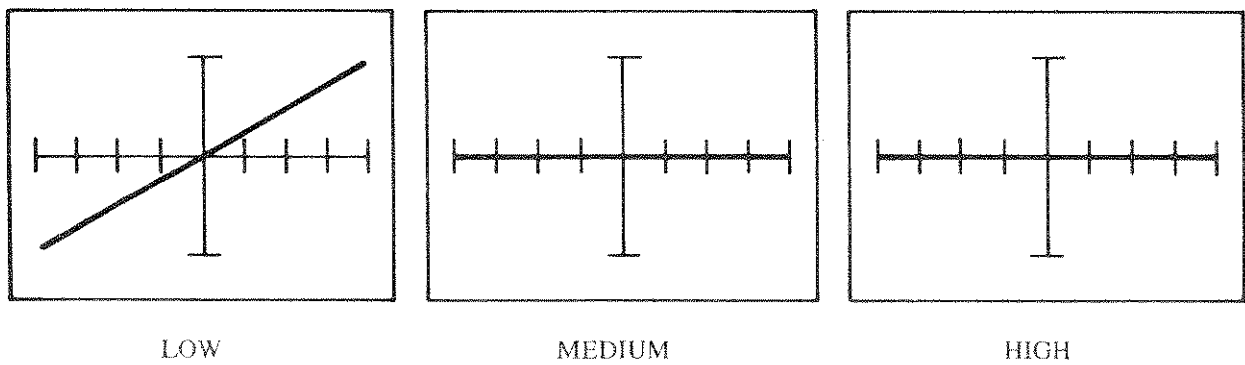

Figure 8-11. Test Patterns for A2 and A1, A1 and G - Open Circuits

# SECTION 9

## TESTING POWER SUPPLIES

### 9.1 GENERAL

The power supply is the most common functional block in electronic equipment. Traditionally, it has been impossible to troubleshoot without being in a power-on condition. With power on, components, even good ones, can be damaged due to excessive current levels.

Basically, all linear power supplies consist of a transformer, a rectifier, electrolytic capacitors, and a load that represents the rest of the system. Figure 9-1 shows the typical power supply (equivalent circuit).

When testing power supplies, make sure all power is removed from the supply and all capacitors are discharged. If the supply is a linear type, then proceed to test all the capacitors, rectifiers, zener diodes, series regulator transistors, control transistors, etc.

Switching regulator supplies are a little different to test because the ac input is first rectified and filtered and then fed to the switching devices.

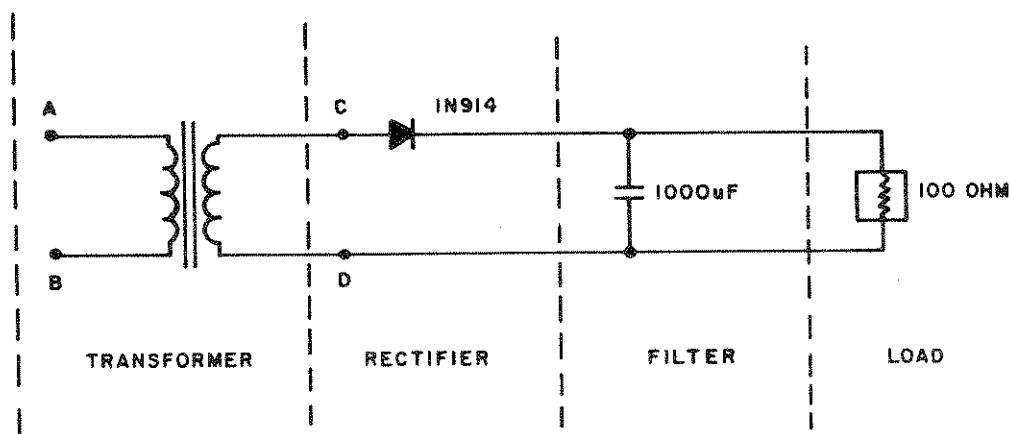

Figure 9-1. Typical Power Supply - Equivalent Circuit

## 9.2 TESTING PROCEDURE

With the tracker connected across points A and B in Figure 9-1, the display shown in Figure 9-2 should be obtained. Figure 9-2 shows a pattern generated in the medium range. The diode effect and inductive effect are reflected to the primary through transformer action.

If the primary winding of the transformer is an open circuit, the display shows a horizontal line in the medium and high ranges, and a diagonal line in the low range. Refer to Figure 9-3.

If the diode is open, the remainder of the circuit is disconnected from the transformer. The tracker displays only the primary winding inductance, and shows a slightly distorted ellipse due to iron core saturation. Refer to Figure 9-4.

With the tracker probes connected across points C and D of Figure 9-1, the patterns shown in Figures 9-5 through 9-10 will result from the indicated circuit conditions. Figure 9-5 shows the display of a good working circuit.

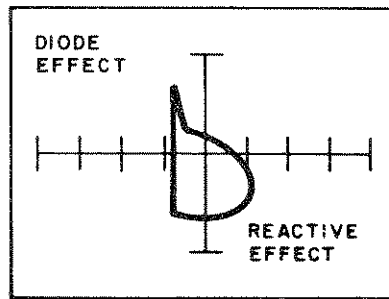

MEDIUM

Figure 9-2. Pattern Across Transformer Primary

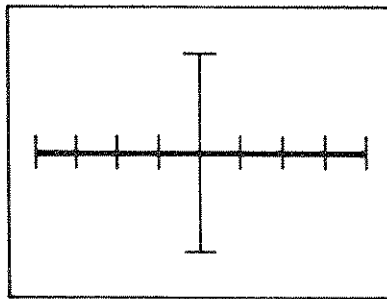

MEDIUM/HIGH

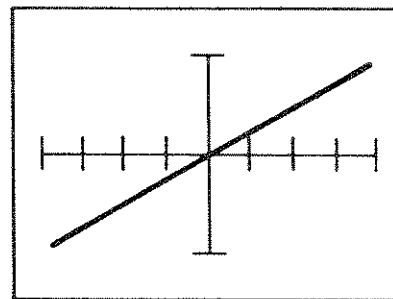

LOW

Figure 9-3. Pattern Due to Open Transformer Primary

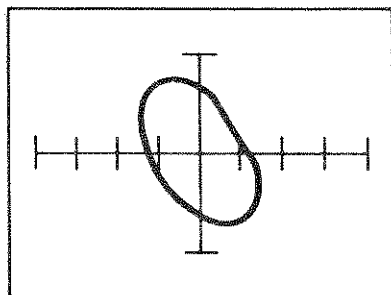

MEDIUM

Figure 9-4. Pattern Due to Open Diode

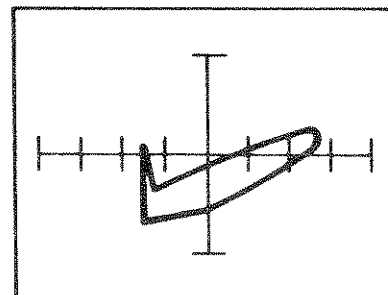

LOW

Figure 9-5. Pattern of a Good Circuit

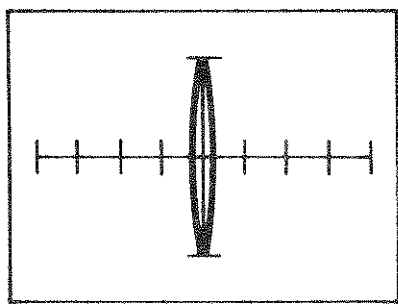

Figure 9-6 shows the pattern produced by a shorted diode. With the shorted diode, the tracker displays the secondary winding, the capacitor, and the 100-ohm resistor, all in parallel. However, at 80 Hz, the 1000uF is dominant (no diode effect).

Figure 9-7 shows the pattern produced by an open diode. With the open diode, the tracker displays the secondary winding only.

Figure 9-8 shows the pattern produced by a shorted capacitor. With the shorted capacitor, the tracker displays the diode effect and the inductive effect from the winding in parallel with the diode.

With the open capacitor, the tracker displays the circuit in Figure 9-9 and produces the trace shown in Figure 9-10.



LOW

Figure 9-6. Pattern with Shorted Diode

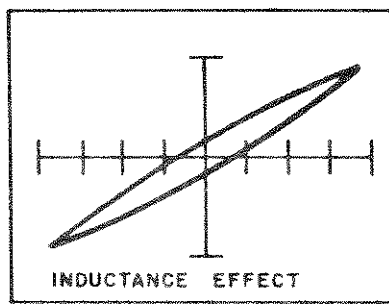

LOW

Figure 9-7. Pattern with Open Diode

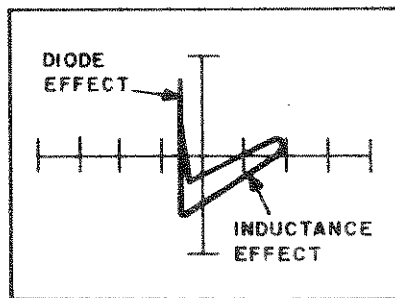

LOW

Figure 9-8. Pattern with Shorted Capacitor

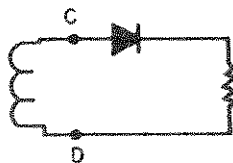
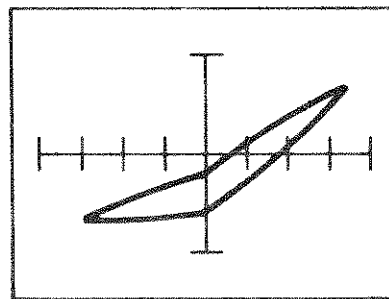

Figure 9-9. Open Capacitor Equivalent Circuit



LOW

Figure 9-10. Pattern with Open Capacitor

**NOTES:**

# SECTION 10

## TESTING COMPONENTS BY COMPARISON

### 10.1 INTRODUCTION

The previous sections of this manual have described the techniques of using the tracker to examine good components. This section describes the examination of defective components using the tracker in the alternate (comparison) mode.

As described in Section 2, when the channel select switch is placed in the center position, the tracker operates in the alternate mode and will switch from displaying channel A to displaying channel B at approximately one second intervals. In this mode, the common input terminal is connected to an appropriate common on a known good circuit or device, and to the same common on the circuit or device under test. A dissimilarity in the patterns then shows an impedance difference between the known good unit and the unit under tested. Refer to Figure 10-1 for tracker connections in the alternate mode.

### 10.2 SETUP PROCEDURES

Set up the tracker, the known good device, and the device under test as follows:

1. Connect the channel test lead A to a known good device.
2. Connect the channel B to the same node of the device under test.
3. Connect tracker common to the same nodes of the known good device and the device under test.
4. Set the select switch to the center position. The tracker circuit will alternately display the pattern of the known good device and the device under test. By examining the pattern differences, a defective component can be detected.

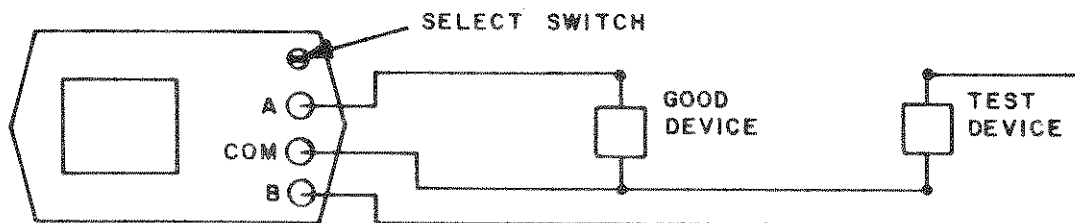

Figure 10-1. A Typical Circuit for Test by Comparison

## 10.3 HIGH VOLTAGE TRANSISTOR (TIP-50)

### 10.3.1 TIP-50 B-E Junction

Figure 10-2 shows the patterns of a known good TIP-50 using the emitter as common. This device has good zener voltage ( $V_z$ ) across the B-E junction.

Figure 10-3 shows the patterns of a defective TIP-50. This device has no zener voltage across the B-E junction in the medium and high ranges.

The B-E junction has become a diode with a parallel resistance of approximately 250 ohms. In the medium and high ranges, the tracker cannot differentiate between a low impedance caused by a forward biased diode, and that caused by a 250-ohm resistance, so the trace appears as a short. However, in the low range, a 250-ohm resistance produces only a slight rotation of the open circuit trace and the diode junction is still visible.

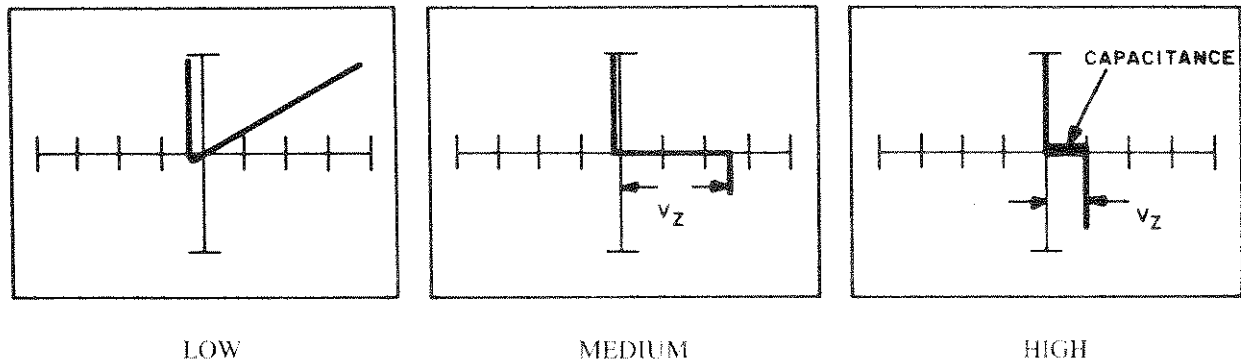

Figure 10-2. Patterns of a Known Good TIP-50

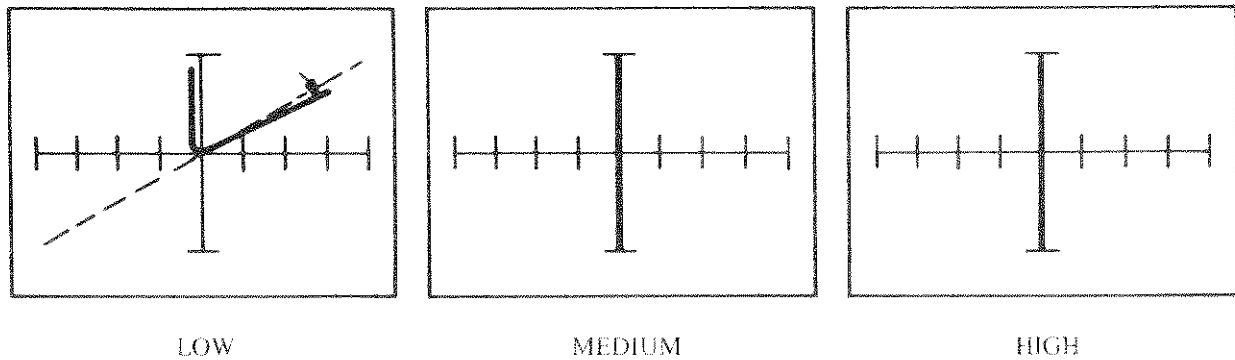

Figure 10-3. Patterns of a Defective TIP-50

### 10.3.2 TIP-50 C-E Junction

Figure 10-4 shows the patterns of a known good TIP-50 using the emitter as common. The TIP-50 has a 500-volt C-E breakdown voltage so the left side of the trace (positive half-cycle of the test signal) appears as an open circuit in all ranges. The right side of the trace is due to a series connection of the C-B junction (forward biased) and the B-E junction (zener breakdown). Since this is an NPN transistor, only the left side (positive C-E voltages) is normally used in most circuits, and the reverse breakdown does not affect anything.

junction has become a low resistance (see section 10.2.1) so the knee is much closer to the vertical axis as only the C-B junction is still intact.

The defective TIP-50 transistor was found in the tracker circuitry which failed to regulate the high voltage power supply. For the C-E junction, there are obvious pattern differences in all ranges. For the B-E junction, there is a slight pattern difference in low range; however the difference is obvious in medium and high ranges.

Figure 10-5 shows the patterns of a defective TIP-50. The B-E

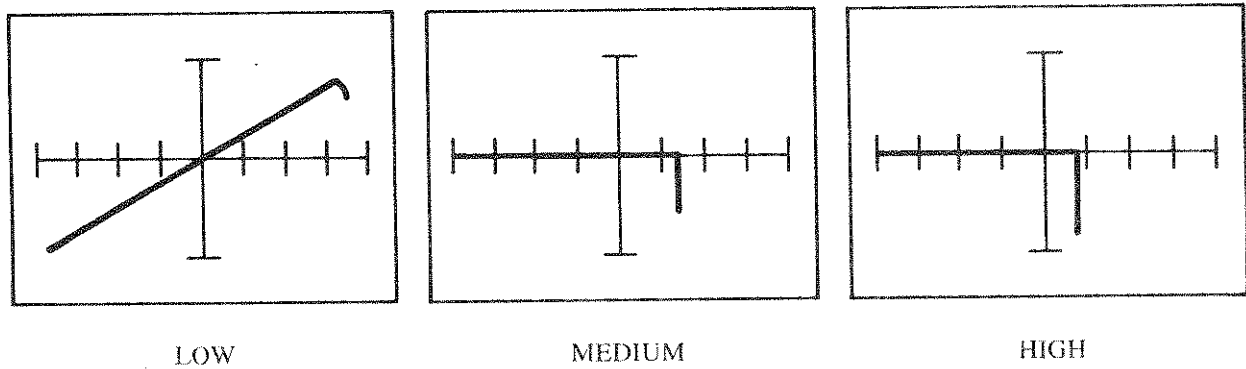

Figure 10-4. Patterns of a Known Good TIP-50

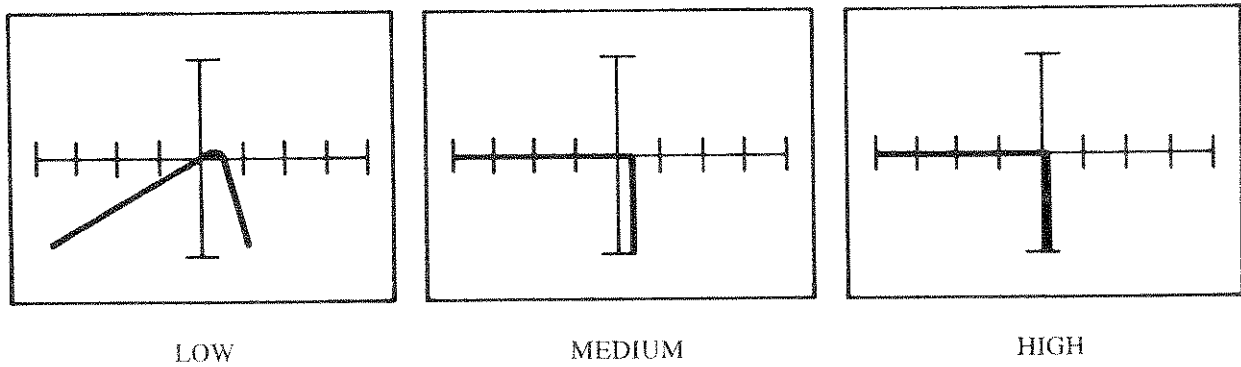

Figure 10-5. Patterns of a Defective TIP-50

## 10.4 HIGH VOLTAGE DIODE HV-15F

There is no pattern difference between a known good diode and a defective diode in the low and medium ranges. In the

high range, the difference is obvious. Refer to Figures 10-6 and 10-7.

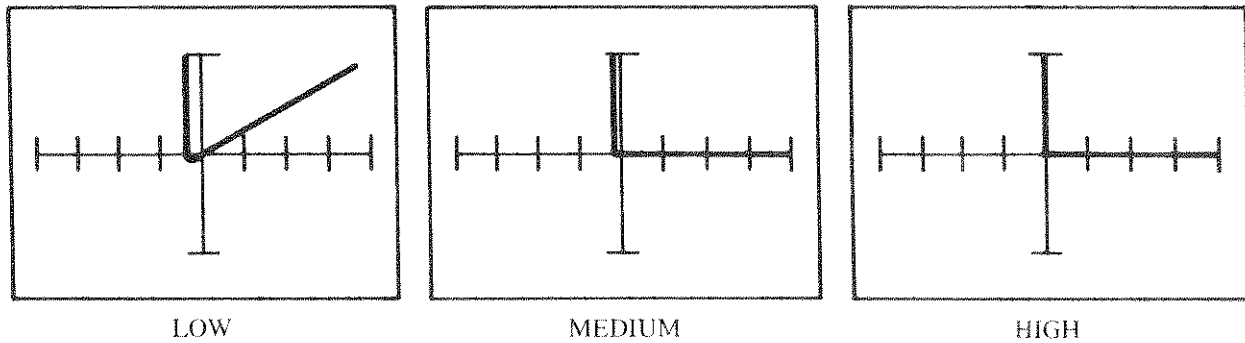

Figure 10-6. Patterns of a Known Good Diode - HV-15F

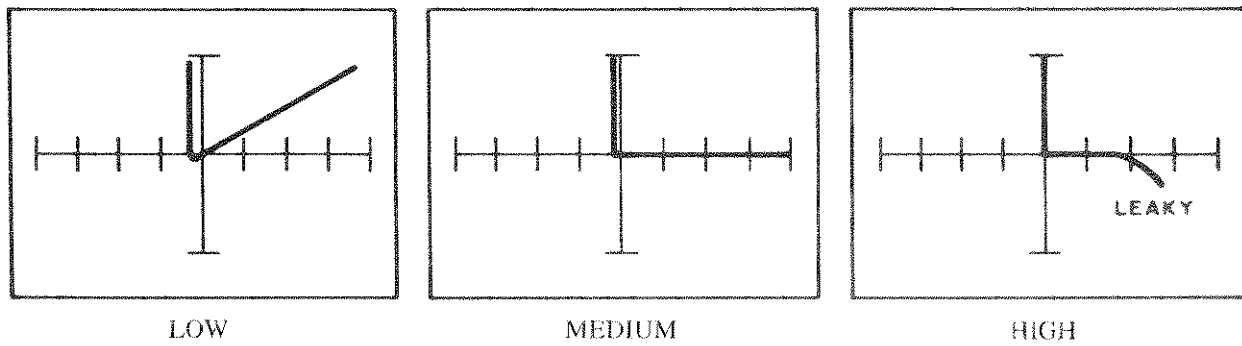

Figure 10-7. Patterns of a Defective (Leaky) Diode - HV-15F

## 10.5 100 $\mu$ F 25V ELECTROLYTIC CAPACITOR

For a good 100 $\mu$ F capacitor, a smooth ellipse is produced in the low range, while a defective capacitor displays an irregu-

lar shape. Figures 10-8 and 10-9 provide a comparison of good to defective capacitors.

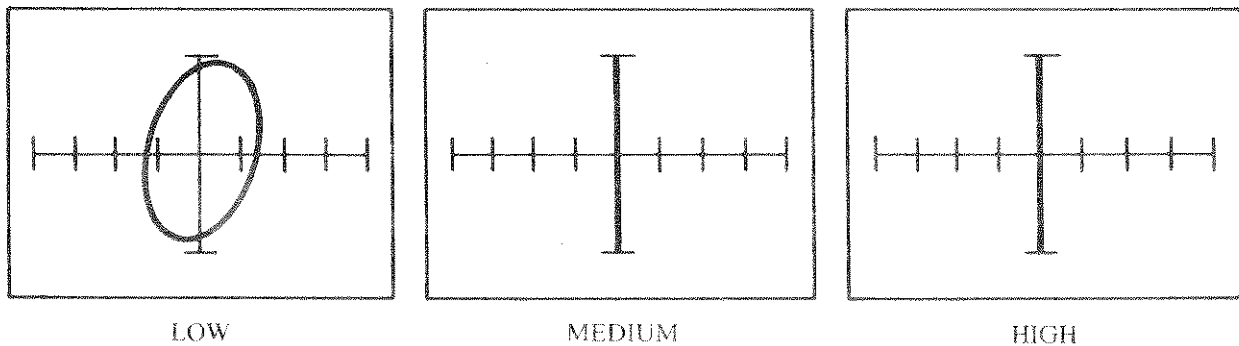

Figure 10-8. Patterns of a Known Good Capacitor.

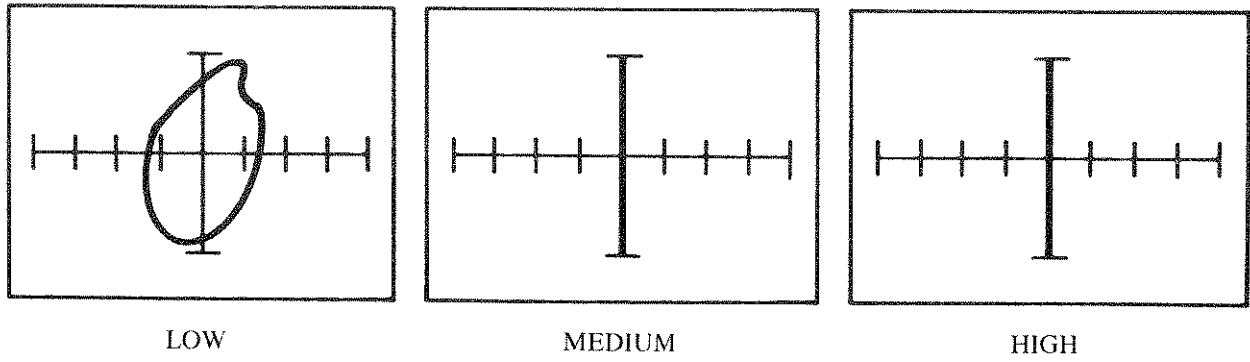

Figure 10-9. Patterns of a Defective Capacitor.

### 10.6 1458 DUAL OP-AMP

When testing the 1458 op amp, use pin 4 (V-) as the common reference. Apply the probes to all pins in sequence using the

low and medium ranges. Figures 10-10 through 10-17 show various possible patterns when testing the 1458 op amp.

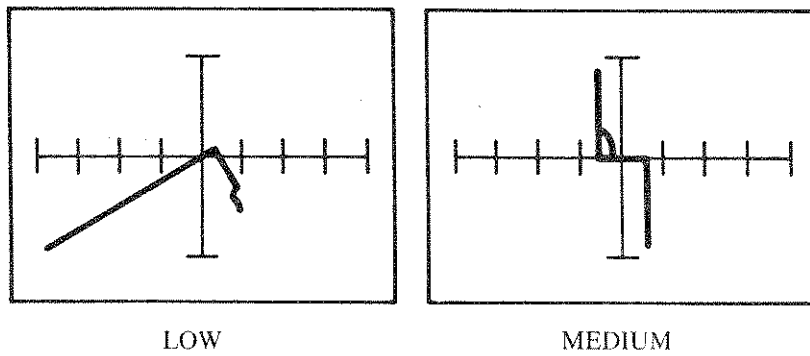

Figure 10-10. Patterns of Good 1458 - Pins 1 and 4

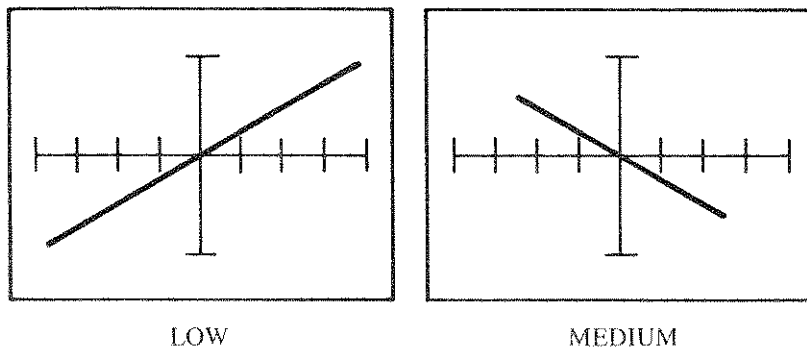
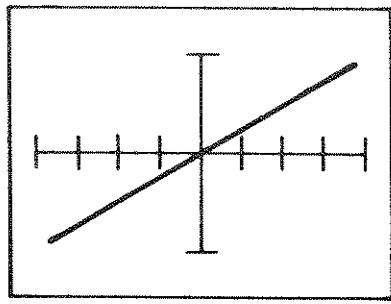
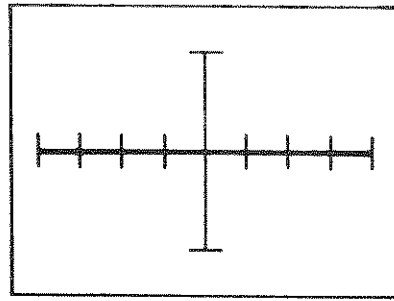

Figure 10-11. Patterns of Defective 1458 - Pins 1 and 4



LOW



MEDIUM

Figure 10-12. Patterns of Good 1458 - Pins 2 and 4

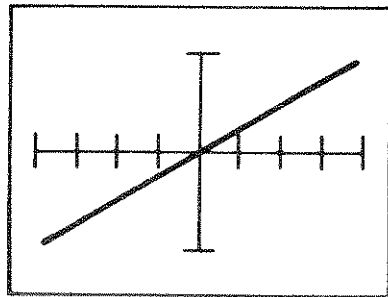

LOW

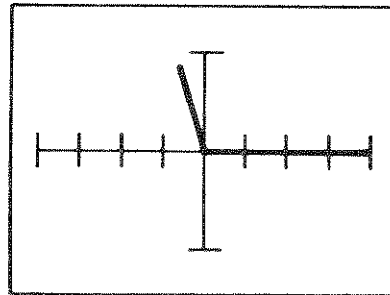

MEDIUM

Figure 10-13. Patterns of Defective 1458 - Pins 2 and 4

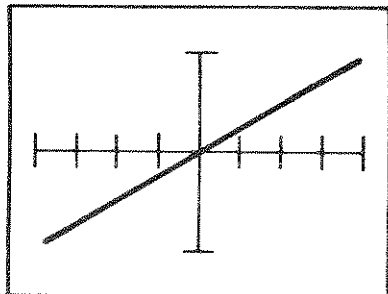

LOW

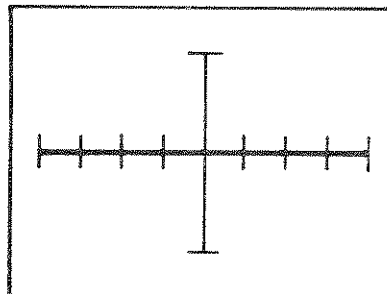

MEDIUM

Figure 10-14. Patterns of Good 1458 - Pins 5 and 4



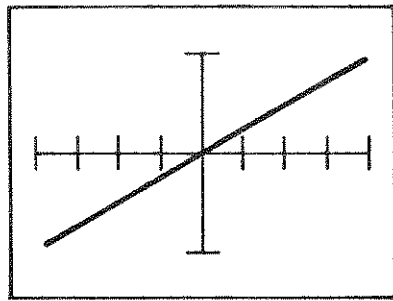

LOW

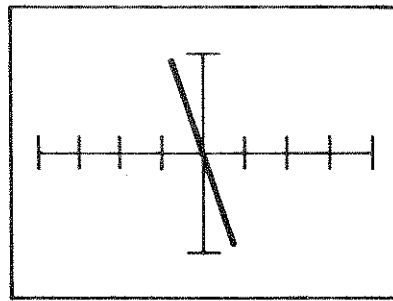

MEDIUM

Figure 10-15. Patterns of Defective 1458 - Pins 5 and 4

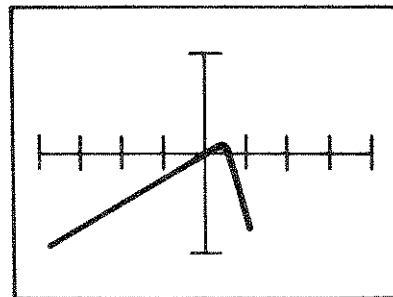

LOW

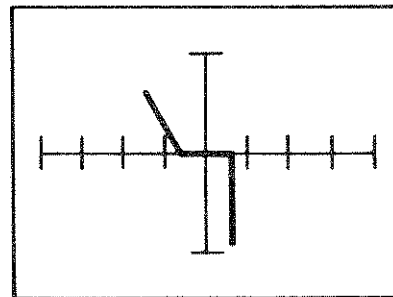

MEDIUM

Figure 10-16. Patterns of Good 1458 - Pins 8 and 4

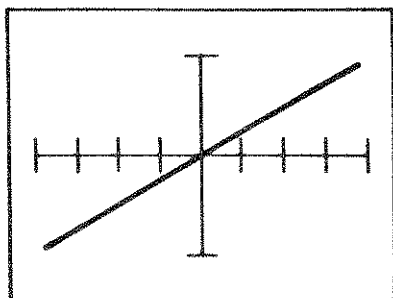

LOW

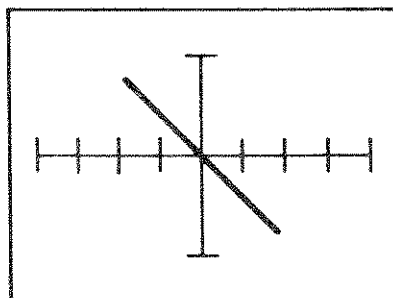

MEDIUM

Figure 10-17. Patterns of Defective 1458 - Pins 8 and 4

## 10.7 7905 NEGATIVE REGULATOR

When defective, the 7905 produces a very small output voltage. To test the 7905, set the tracker to the comparison mode and connect the common probe of the tracker to both the defective and known good device. Check the other pins of

each device with the channel A and channel B probes. Figure 10-18 shows the pin assignment of the 7905, and Figures 10-19 through 10-24 show the traces produced when testing various pins of both good and defective devices.

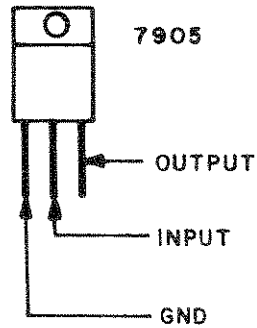

Figure 10-18. 7905 Pin Assignments

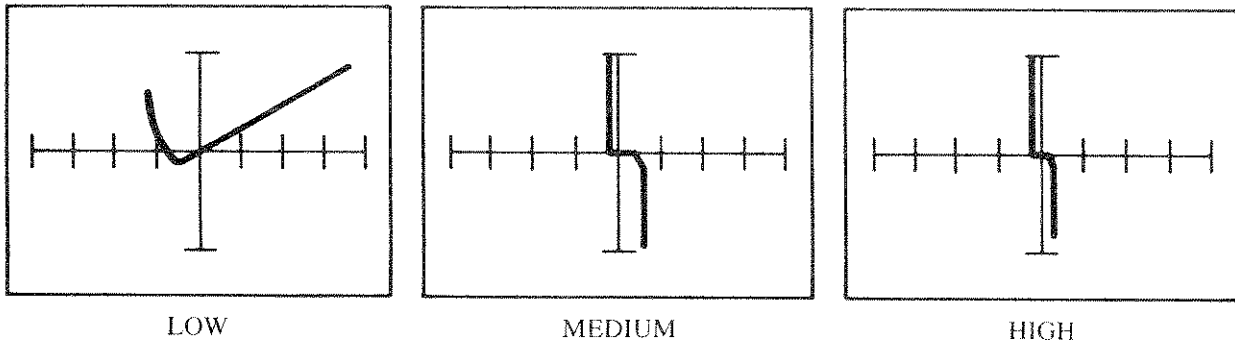

Figure 10-19. Patterns of a Good 7905 - Ground and Input

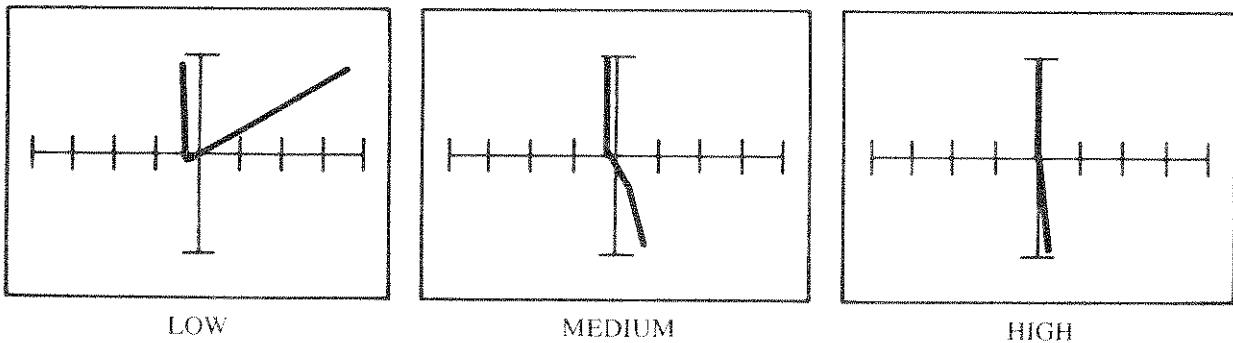

Figure 10-20. Patterns of a Defective 7905 - Ground and Input

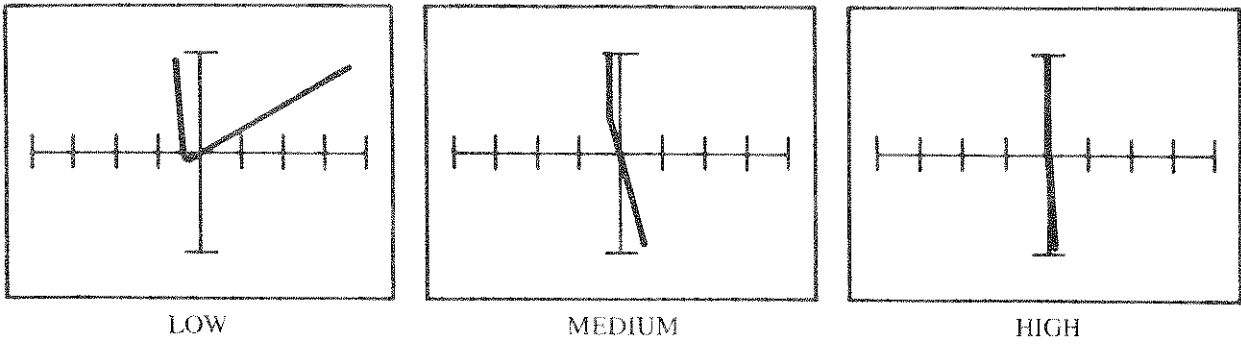

Figure 10-21. Patterns of a Good 7905 - Ground and Output

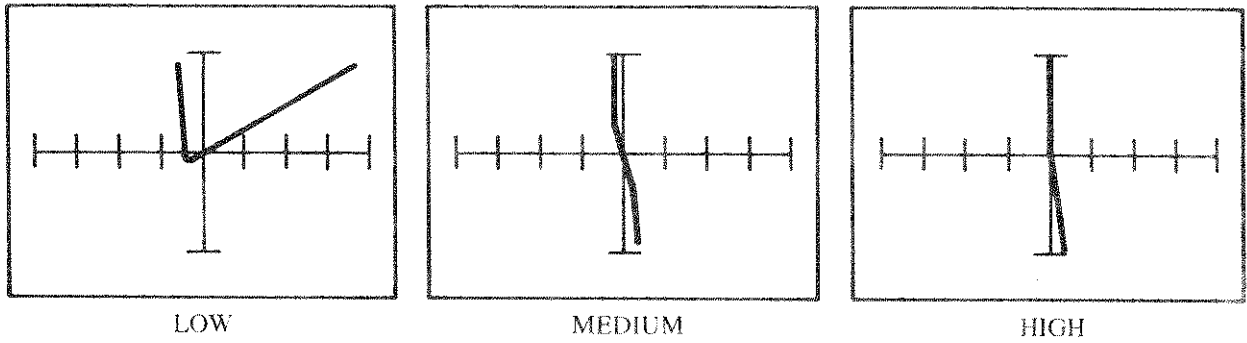

Figure 10-22. Patterns of a Defective 7905 - Ground and Output

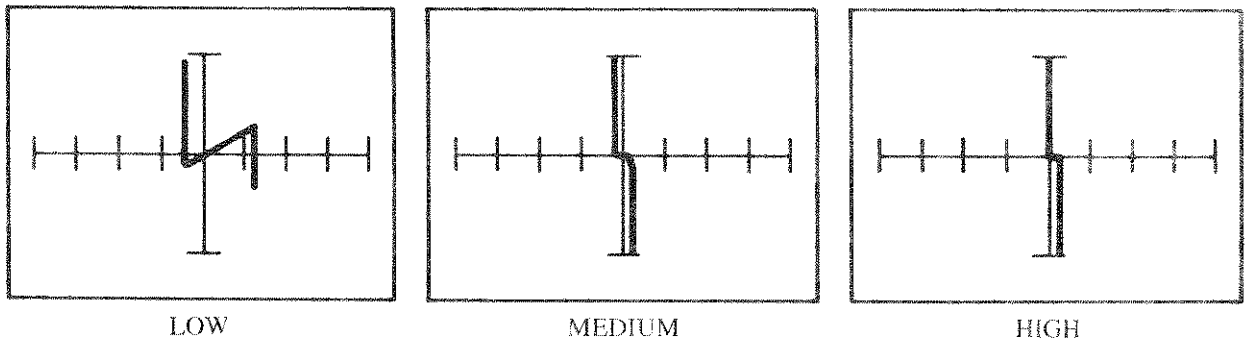

Figure 10-23. Patterns of a Good 7905 - Input and Output

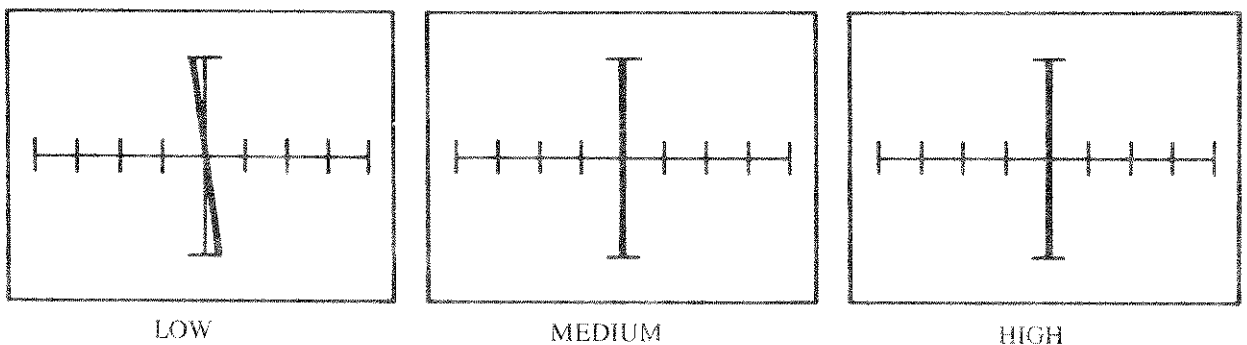

Figure 10-24. Patterns of a Defective 7905 - Input and Output

**NOTES:**

# SECTION 11

## SOLVING BUS PROBLEMS

### 11.1 INTRODUCTION

There are many different bus structures and it is not practical to analyze each one of them. The following paragraphs contain troubleshooting information for several types of bus-related problems.

### 11.2 STUCK WIRED-OR BUS

Occasionally an integrated circuit will develop an internal short on a lead that is connected to a common bus. This causes a portion of the bus to remain fixed at some voltage level. If you check the stuck bus line to ground or the positive voltage supply, with the tracker in the low range, the display will be a diagonal line indicating a short of four to ten ohms.

The shorted device is almost certain to have other pins that show serious flaws when connected to the tracker. To locate the defective device, switch the tracker to the medium range and check all the pins of the all devices connected to the bus. Be sure the other tracker lead is connected to ground or the positive voltage supply. The defective device will show up as having flaws on more than one pin: usually on several pins.

### 11.3 DEFECTIVE WAVESHAPES ON BUS

In this type of bus problem, the waveshape presented on the tracker does not indicate a short, but may show serious leakage current or other type of flaw. This type of problem is solved in the previously described stuck-bus. Connect one tracker lead to ground or the positive voltage supply and examine all the pins of all integrated circuits connected to the defective bus. Usually, the defective device will have more than one pin showing an internal defect. If the defect cannot be traced to a single device by this method, it is necessary to desolder pins connected to the bus in order to pinpoint the point of defect.

### 11.4 MEMORIES

Memory boards can be very difficult to troubleshoot if the system does not have built-in diagnostics to identify the section of memory where information cannot be stored or retrieved. The problem may be easily seen with the tracker on a bus line, but since memory devices have most of their pins connected in parallel, it is difficult to isolate the bus problem down to one device.

If the memory devices are in sockets it is a simple matter to locate the problem using the tracker. Merely locate the bus line that provides the defective waveform, then remove the memory devices one at a time until the waveform indicates a normal bus line.

If the memory devices are soldered in, fault isolation becomes more difficult. It should be noted that most memory failures are not due to failure of memory devices themselves, but more often to failures in the devices that access and control the memory section of the equipment. With this in mind, examine the memory control section of the equipment before spending much time on the actual memory devices.

If the failure is definitely in a memory device that is soldered to the PCB, find a pin that is not commonly-connected to the other memory devices. Then check this pin using the tracker in the alternate mode, with the common lead of the tracker tied to the defective bus line. Connect the channel A tracker lead to one non-bussed pin of one memory device, and the channel B probe on the same non-bussed pin of another memory device. Compare all the memory devices in this fashion, looking for a dc shift (the waveshape shifts to the left or right).

If more than one device shows a dc shift, suspect the one showing the greatest shift. The use of a schematic diagram is a definite help in making repairs of this type.

If none of the above troubleshooting methods provides a solution to the bus problem, unsolder one pin at a time from the defective bus line until its waveshape returns to normal.

**NOTES:**

# SECTION 12

## TROUBLE-SHOOTING TIPS

This section describes several tips that may be useful when using the tracker to test various types of devices and circuits. This information is provided as a supplement to all testing information provided thus far in this manual. It is recommended reading whether or not it appears to apply to an immediate troubleshooting situation or not. There is no logical order to the presentation of the troubleshooting tips presented below.

Nearly all testing is performed with either the medium or low range selected on the tracker. The high should only be used if testing at a high impedance point, or if higher test voltage is required, such as when is desired to examine the zener region of a 40-volt device. Sometimes component defects are more obvious in one range than another, so if a suspect device appears normal for one range, try the other ranges.

When testing a single bipolar junction, such as a diode, a base-emitter junction, or a base-collector junction, the low range usually offers the best tracker display. However, if checking the device for reverse bias leakage, then a higher range should be used.

Attempt to relate the failure mode of the circuit under test to the type of defect indicated by the tracker. For example, a catastrophic printed circuit board failure can be expected to be caused by a failed device with a dramatic pattern difference from that of a normal device of the same type. A marginally operating or intermittent board may have a failed component that indicates only a small pattern difference from normal.

Devices made by different manufacturers, especially digital integrated circuits, are likely to produce slightly different patterns on the tracker. This is normal and does not necessarily indicate a failed device.

When performing in-circuit testing, always do a direct comparison to a known good circuit of similar design, if at all possible, until a good skill level is acquired using the tracker.

If a failure symptom cannot be related to a specific area of the printed circuit board, begin by examining the patterns pro-

duced at the connector pins. This method of troubleshooting shows all the inputs and outputs and will often lead directly to the failing area of the board.

It should be kept in mind that leakage current doubles with a ten-degree Celsius rise in temperature. Leakage current shows up on the tracker as a rounded transition (where the pattern shows the change from zero current flow to current flow) or by causing curvature at other points in the pattern. Leakage current causes curvature due to non-linearity.

NEVER begin the testing of an integrated circuit using the low range. If the low range is initially used, confusion can result from the inability of this range to display the various junctions. Always begin testing using the medium range and, if the pattern is a vertical line, switch to the low range to check for a short or low impedance (less than 500 ohms). Switch to the low range if the device is suspect and appears normal in the medium range. (This will reveal a defective input protection diode not evident using the medium range.)

It should be noted that the tracker test leads are non-insulated at the tips. Be sure that good contact is made to the device(s) under test.

Bipolar integrated circuits containing internal shorts produce a resistive pattern (a straight line) in the ten o'clock to eleven o'clock position on the tracker display when using the low range. This type of pattern is always characteristic of a shorted integrated circuit, and results from a resistive value of four to ten ohms, typical of a shorted integrated circuit. A shorted diode, capacitor, transistor junction, etc. always produces a vertical (twelve o'clock) straight line on the tracker display when using the low range.

When testing an analog devices or circuits, the low range is used in most instances. Analog circuits contain many more single junctions, and any defects in these junctions show more easily when using the low range. Also, the 32-ohm internal impedance offered by the tracker in the low range makes it less likely that other components in parallel with the device under test will load the tracker sufficiently to alter the pattern.

When testing an op amp in-circuit, it is highly recommended that it be compared directly with a known good circuit. This is because the many different feedback paths associated with op amps can cause an almost infinite number of patterns on the tracker.

Often when checking a zener diode in-circuit, it will not be possible to examine the zener region due to circuit leakage. If it is necessary to observe the zener region under this condition, it is necessary to unsolder one side of the diode to eliminate the loading effects of the circuit.



## APPENDIX A

### HUNTRON TRACKER CMOS TESTS MTL Microtesting Limited Alton, Hampshire, England

#### REQUIREMENT

It was required to ascertain whether normal usage of various types of Huntron Tracker instruments on any, or all, of their ranges could cause damage or catastrophic failure of normal C-MOS devices.

#### Equipment used

Five Huntron Trackers were used to conduct five tests simultaneously. All had been checked as being to manufacturers standards prior to the test. Types were as follows:

Qty 1 Huntron Tracker Type HTR-1005-BE  
Qty 3 Huntron Tracker Type HTR-1005-B1  
Qty 1 Huntron Tracker Type HTR-1005-B1-S

The Compar-a-trace model was used in the Tracker mode (mode switch in "up" position) except during the actual Compar-a-trace Test.

60 C-MOS devices were obtained from three manufacturers as shown below. All were brand new devices and were delivered in protective packing. Half of the devices were retained as Reference devices and were kept in protective conductive foam except when removed for data-logging at the beginning and end of the test. Each device was numbered and retained the same number throughout the test.

Device No.	Manufacturer	Type No.	Type	Used for
1	Motorola	MC14071BC	Quadruple 2-input OR Gate	Test
2	Motorola	MC14071BC	Quadruple 2-input OR Gate	Test
3	Motorola	MC14071BC	Quadruple 2-input OR Gate	Test
4	Motorola	MC14071BC	Quadruple 2-input OR Gate	Test
5	Motorola	MC14071BC	Quadruple 2-input OR Gate	Test
6	Motorola	MC14071BC	Quadruple 2-input OR Gate	Reference
7	Motorola	MC14071BC	Quadruple 2-input OR Gate	Reference
8	Motorola	MC14071BC	Quadruple 2-input OR Gate	Reference
9	Motorola	MC14071BC	Quadruple 2-input OR Gate	Reference
10	Motorola	MC14071BC	Quadruple 2-input OR Gate	Reference
11	Motorola	MC14081BC	Quadruple 2-input AND Gate	Test
12	Motorola	MC14081BC	Quadruple 2-input AND Gate	Test
13	Motorola	MC14081BC	Quadruple 2-input AND Gate	Test
14	Motorola	MC14081BC	Quadruple 2-input AND Gate	Test
15	Motorola	MC14081BC	Quadruple 2-input AND Gate	Test
16	Motorola	MC14081BC	Quadruple 2-input AND Gate	Reference
17	Motorola	MC14081BC	Quadruple 2-input AND Gate	Reference
18	Motorola	MC14081BC	Quadruple 2-input AND Gate	Reference
19	Motorola	MC14081BC	Quadruple 2-input AND Gate	Reference
20	Motorola	MC14081BC	Quadruple 2-input AND Gate	Reference

21	N.S.C.	MC14071BCN	Quadruple 2-input OR Gate	Test
22	N.S.C.	MC14071BCN	Quadruple 2-input OR Gate	Test
23	N.S.C.	MC14071BCN	Quadruple 2-input OR Gate	Test
24	N.S.C.	MC14071BCN	Quadruple 2-input OR Gate	Test
25	N.S.C.	MC14071BCN	Quadruple 2-input OR Gate	Test
26	N.S.C.	MC14071BCN	Quadruple 2-input OR Gate	Reference
27	N.S.C.	MC14071BCN	Quadruple 2-input OR Gate	Reference
28	N.S.C.	MC14071BCN	Quadruple 2-input OR Gate	Reference
29	N.S.C.	MC14071BCN	Quadruple 2-input OR Gate	Reference
30	N.S.C.	MC14071BCN	Quadruple 2-input OR Gate	Reference
31	N.S.C.	MC14081BCN	Quadruple 2-input AND Gate	Test
32	N.S.C.	MC14081BCN	Quadruple 2-input AND Gate	Test
33	N.S.C.	MC14081BCN	Quadruple 2-input AND Gate	Test
34	N.S.C.	MC14081BCN	Quadruple 2-input AND Gate	Test
35	N.S.C.	MC14081BCN	Quadruple 2-input AND Gate	Test
36	N.S.C.	MC14081BCN	Quadruple 2-input AND Gate	Reference
37	N.S.C.	MC14081BCN	Quadruple 2-input AND Gate	Reference
38	N.S.C.	MC14081BCN	Quadruple 2-input AND Gate	Reference
39	N.S.C.	MC14081BCN	Quadruple 2-input AND Gate	Reference
40	N.S.C.	MC14081BCN	Quadruple 2-input AND Gate	Reference
41	R.C.A.	MC14071BE	Quadruple 2-input OR Gate	Test
42	R.C.A.	MC14071BE	Quadruple 2-input OR Gate	Test
43	R.C.A.	MC14071BE	Quadruple 2-input OR Gate	Test
44	R.C.A.	MC14071BE	Quadruple 2-input OR Gate	Test
45	R.C.A.	MC14071BE	Quadruple 2-input OR Gate	Test
46	R.C.A.	MC14071BE	Quadruple 2-input OR Gate	Reference
47	R.C.A.	MC14071BE	Quadruple 2-input OR Gate	Reference
48	R.C.A.	MC14071BE	Quadruple 2-input OR Gate	Reference
49	R.C.A.	MC14071BE	Quadruple 2-input OR Gate	Reference
50	R.C.A.	MC14071BE	Quadruple 2-input OR Gate	Reference
51	R.C.A.	MC14081BE	Quadruple 2-input AND Gate	Test
52	R.C.A.	MC14081BE	Quadruple 2-input AND Gate	Test
53	R.C.A.	MC14081BE	Quadruple 2-input AND Gate	Test
54	R.C.A.	MC14081BE	Quadruple 2-input AND Gate	Test
55	R.C.A.	MC14081BE	Quadruple 2-input AND Gate	Test
56	R.C.A.	MC14081BE	Quadruple 2-input AND Gate	Reference
57	R.C.A.	MC14081BE	Quadruple 2-input AND Gate	Reference
58	R.C.A.	MC14081BE	Quadruple 2-input AND Gate	Reference
59	R.C.A.	MC14081BE	Quadruple 2-input AND Gate	Reference
60	R.C.A.	MC14081BE	Quadruple 2-input AND Gate	Reference

A test jig was constructed using Vero-Board and high quality gold flashed 14-pin DIL sockets. Each socket was isolated from all others by track cutting in order to avoid any effects of circulating earth currents due to variations in the output levels of the various Huntron Test units. As each device contained four identical gates only one gate per device (pins 1, 2 and 3) was checked on each device, although data logging checked all gates.

#### PROTECTION

All devices were kept in conductive foam except when actually being tested. Devices were only handled when a wrist earth strap (connected to the Test House Silent Earth) was being worn. The bench on which the tests were carried out was surfaced with a conductive mat also connected to the Silent Earth.

## TEST SYSTEM

The five Huntron Trackers were connected to the five test sockets with the Huntron black socket connected to pin 7 which was made a common earthpoint for all untested gates, and an earth point for the unconnected inputs in the tested gate. The Huntrons were left connected for a period of one hour, and then switched off and the devices changed. The first check was carried out on the Huntron low range with connections to pin 1 and pin 7 with pin 2 earthed. Pin 3 was left open circuit. After all test devices had been checked on pin 1 of the Huntrons were then reconnected to pin 2 and pin 7 with pin 1 earthed and pin 3 open circuit. The final check per device was with the Huntrons connected to pins 3 with pins 1 and 2 earthed.

All devices (both reference and test) were data-logged on Imperial Technology IT200 equipment prior to the start of the tests. The test devices were then data-logged again after pin 1 tests were completed and again after the pin 2 tests. The final data-logging was completed when all tests on pins 1, 2 and 3 were complete with the Huntrons switched to the low range.

All test devices were then tested in a similar way using the Huntrons on medium range, except that the test devices were not data-logged after pins 1 and 2 were completed. Data-logging did take place when tests on pin 3 were complete.

Devices were then tested using the high range with data-logging again taking place on completion of tests on pin 3.

In order to check the effect (if any) of the Huntron Compare-a-trace action on the CMOS devices a sample device of each manufacturer was subjected to ten minutes Compare-a-trace action on the low range (2.53V) output at approx .9Hz cycle rate. (Nos 12, 32, 52, 2, 22 and 42). The six devices (3 x 4071 and 3 x 4081) were then data-logged.

In order to ascertain whether leads connecting the Huntrons to the devices under test could act as antennas in the region of weak fields of electro-magnetic radiation thus causing damage to the devices, the five Huntrons were left connected to five test devices (2 x Motorola - No 1, a 4071 and No 11, a 4081; 2 x NSC - No 21, a 4071 and No 31, a 4081; and 1 x RCA - No 41, a 4071).

The devices under test were then subjected to radiation from a battery driven, all solid-state frequency modulation type transmitter operating on 145MHz. The PA input power was approximately 2 watts and the antenna was a 1/4 whip vertical located approximately 19" (1/4) from the centre of the interconnecting wiring. Modulation was NOT applied but the carrier was switched at irregular intervals. Induction was evident by "jumping" of the Huntron traces, except on the type HTR-1005-BE. RF was radiated for approximately 15 minutes. The devices were then data-logged.

All sixty off devices were then loaded onto static burn-in boards with input and output pins terminated to Vcc by 47K pull up resistors and then loaded into a Ceetel burn-in chamber at 125 degrees Celsius.

After 48 hours at 125 degrees Celsius the devices were removed from the oven and all devices data-logged. The devices were then re-loaded into the burn-in chamber for a further 120 hours burn-in at 125 degrees Celsius. The devices were then finally data-logged to determine the long-term effect (if any) of the Huntron Trackers.

## ROTATIONAL TESTING

In order to ensure that any variations in output levels of the three types of Huntron instruments used did not affect part of the test series devices only, devices under test were "rotated" around the test instruments as shown in the Table below. The figures shown represent the Test Number followed by the Section Number, i.e. 9/2 = Test No. 9, the 2nd Part.

DEVICE NOS	HUNTRON INSTRUMENTS				
	1	2	3	4	5
1	1/1	3/1	5/1	9/1	7/1
2	7/2	1/2	3/2	5/2	9/2
3	9/2	7/2	1/3	3/2	5/2
4	5/3	9/3	7/3	1/3	3/3
5	3/3	5/3	9/3	7/3	1/3
11	2/1	4/1	6/1	10/1	8/1
12	8/2	2/2	4/2	6/2	10/2
13	10/2	8/1	2/2	4/2	6/2
14	6/3	10/3	8/1	2/3	4/3
15	4/3	6/3	10/3	8/3	2/3
21	7/1	1/1	3/1	5/1	9/1
22	9/2	7/2	1/2	3/2	5/2
23	5/2	9/1	7/2	1/2	3/2
24	3/2	5/2	9/2	7/2	1/2
25	1/3	3/3	5/3	9/3	7/3

31	8/1	2/1	4/1	6/1	10/1
32	10/1	8/1	2/1	4/1	6/1
33	6/2	10/2	8/1	2/2	4/2
34	4/2	6/2	8/2	10/2	2/2
35	2/3	4/3	6/3	10/3	8/3
41	5/1	9/1	7/1	1/1	3/1
42	3/1	5/1	9/1	7/1	1/1
43	1/2	3/2	5/1	9/2	7/2
44	7/3	1/3	3/3	5/3	9/3
45	9/3	7/3	1/3	3/3	5/3
51	6/1	10/1	8/1	2/1	4/1
52	4/1	6/1	10/1	8/1	2/1
53	2/2	4/2	6/1	10/2	8/2
54	8/3	2/3	4/3	6/3	10/3
55	10/3	8/3	2/3	4/3	6/3

### RESULTS SUMMARY

1. Motorola devices appeared to be more sensitive on the input pins when subject to the Tracker tests.
2. No change in functionality of dc parameters were exhibited on any device subjected to stimulae from the Huntron on all ranges prior to burn-in at 125 degrees Celsius.
3. Device No 1 (Motorola 14071) failed supply current after 48 hours burn-in. Device No 3 (Motorola 14071) failed supply current and functionality in gate No 4 (pins 11, 12 and 13) after 48 hours burn-in.
4. Device No 1 failed supply current and functionality in gate No 4 (pins 11, 12 and 13) after 168 hours burn-in. Device No 17 (Motorola 14081 Reference device) failed supply current after 168 hours burn-in.

### CONCLUSIONS

Although three devices failed during static burn-in it is felt that the failures cannot be contributed to any harmful affects due to stimulae from the Huntron Trackers as the failure modes were totally independent of pins 1, 2 or 3 which were pins stimulated by the trackers. Furthermore, one of the devcies which failed during burn-in was a Reference device which was not connected to a Tracker in any form.

It should be noted the the burn-in condition which were applied to the device is very extreme (viz 125 degrees) for plastic encapsulated devices and that the incident of failure is unlikely to be related to the test performed by the Huntron Tracker.

## APPENDIX B

### HUNTRON TRACKER TTL AND CMOS TESTS Component Concepts Everett, WA 98201

OBJECT: To determine the effect of the testing signals from a Huntron Tracker in-circuit component tester on performance of CMOS integrated circuits.

COMPONENT TESTED: Motorola MC 14011 and TI 74LS11

(1) Burn-in (100%) 180 pieces at 125 degrees Celsius = 48 hours

(2) Electrical (100%) to obtain 150 units to be labeled as follows:

Label 25 units as HH1, HH2, HH3 . . . . . HH25  
Label 25 units as HM1, HM2, HM3 . . . . . HM25  
Label 25 units as HL1, HL2, HL3 . . . . . HL25  
Label 25 units as VH1, VH2, VH3 . . . . . VH25  
Label 25 units as VM1, VM2, VM3 . . . . . VM25  
Label 25 units as VL1, VL2, VL3 . . . . . VL25M

(3) Electrical (100%) in the following sequence:

- (a) HH1, HH2 . . . . . HH25
- (b) HM1, HM2 . . . . . HM25
- (c) HL1, HL2 . . . . . HL25
- (d) VH1, VH2 . . . . . VH25
- (e) VM1, VM2 . . . . . VM25
- (f) VL1, VL2 . . . . . VL25

For DC Parametrics and function per the manufacturers specification, TA = 25 degrees Celsius. They are to be tested on HP5054 digital IC tester. All parameters data logged. Propagation delay tested per specification for pass/fail only.

(4) Connect Huntron tracker to sequencer (sequencer is a piece of equipment supplied by Huntron Instruments, Inc. which applies testing signals from Tracker and tester to device under test) to each piece of equipment and turn on power.

- (5) (a) Set Tracker range to HIGH.  
(b) Set Tester range to HIGH.  
(c) Insert HH1 in zero-insertion force socket marked "Huntron Tracker" located on top of sequencer.  
(d) Activate "start" button on sequencer. The red LED will come on when sequencing is completed. (it takes 90 seconds).  
(e) Remove devices under test.  
(f) Repeat steps (c), (d), (e), (f), for HH2, HH3 . . . . . HH25.

(6) Set tracker and tester range to medium and repeat steps (c), (d), (e) (f) described in (5) for HM1, HM2, . . . . . HM25, and VM1, VM2 . . . . . VM25.

(7) Set tracker and tester range to low and repeat steps (c), (d), (e) (f) described in (5) for HL1, HL2, . . . . . HL25, and VL1, VL2 . . . . . VL25.

(8) Electrical test (100%) in the following sequences:

HH1, HH2 . . . . . HH25  
HM1, HM2 . . . . . HM25  
HL1, HL2 . . . . . HL25  
VH1, VH2 . . . . . VH25  
VM1, VM2 . . . . . VM25  
VL1, VL2 . . . . . VL25

For DC parametrics and function. T=25 degrees Celsius. Propagation delay tested per specification for pass/fail only. All parameters data logged on HP5054 digital tester.

### TEST REPORT

Component Concepts, Inc., an independent test lab for active electronic components, performed testing on the effects of part exposure to the Huntron "Tracker". The Huntron "Tracker" is an in-circuit stand-alone component tester. Two types of parts were tested in pertinent data recorded prior to test with the "Tracker". The parts were then tested and datalogged after the "Tracker" test. The two sets of data, pre- and post-, were then compared for any possible effects that the "Tracker" might have upon the parts. Seventy-five pieces of 74LS11's and seventy-five of 4011's were tested. All parts passed after testing with the Huntron. The datalogged parameters were input and operating current, and output voltage. No discernible effects were observed upon analysis of the pre- and post- datalogs.

The exact test flow is as follows:

1. All parts before testing were subjected to 48 hours burn-in at 125 degrees Celsius.
2. 74LS11 and 4011 tested for pass/fail operation at 125 degrees Celsius.
3. 75 of each part tested for propagation delay, pass/fail.
4. Parts datalogged for specific parameters.
5. Parts subjected to test by the Huntron instrument.
6. Propagation delay tested.
7. Post-test datalog performed, same parameters recorded.
8. Datalogs analyzed to determine any effects of Huntron "Tracker" upon parts.

### TEST DISCUSSION

The testing procedures used can only validate the externally measurable parameters of the part and its function. The internal functioning of the part can be assumed to follow with the externally measurable parameters.

The lot of parts received from Huntron were uniform in date code and manufacture. All parts were 100% functional after a static burn-in of 48 hours. The TTL and CMOS parts were tested on a Hewlett Packard 5045 IC Tester (Ser. #1712A00222). The data was recorded on a companion HP 9825 Calculator. Huntron provided a "Tracker" and "Sequencing Unit". The Huntron "Tracker", (Ser. #21F01001), was connected to the sequence unit which, according to Huntron, automatically connected the leads of the part to the testers one lead at a time. The parts were divided into two lots. Part numbers 1-37 were tested by the Huntron unit. The actual functioning of the sequencer and the two test units are not the responsibility of Component Concepts other than the following of instructions provided by Huntron for proper operation. After burn-in the parts were tested pass/fail for propagation delay in a bench set-up using a pulse generator and a 100MHz HP oscilloscope. The parts were also datalogged. They were then tested on the sequencer with the two testers attached. After being tested with the sequencer the parts were again tested for propagation delay and data logged. At all times attention was paid to static ESD precautions.

## TEST RESULTS

At pre-test, after burn-in, all parts were functional for DC and AC parameters, seventy-five parts were datalogged from each part type, 74LS11 and 4011 BC. A comparison of data after testing showed no significant change in either input current or output voltage under load. The data printed out by the HP9825 Calculator was reduced to a more readable format which clearly shows the value recorded before and after the differences between the two values. The majority of differences between values are within the accuracy limits of the HP 5045 Tester. Points where there are differences greater than that value are not significant in number to produce any possible negative conclusions on tester interaction with the tested parts. Based on the collected data, the Huntron "Tracker" had no discernible impact on the parts they test.

**NOTES:**



**NOTES:**

**NOTES:**

**NOTES:**

**NOTES:**