

AVON INDUSTRIAL PARK/BODWELL STREET/AVON, MASS. 02322 USA

KROHN-HITE CORPORATION

071585



**OPERATING AND MAINTENANCE
MANUAL**

MODEL 3550 SERIAL NO. 5022

VARIABLE FILTER

2HZ to 200KHZ

CONTENTS

Section		Page
1	GENERAL DESCRIPTION	1
2	OPERATING INSTRUCTIONS	2
3	INCOMING ACCEPTANCE AND INSPECTION	4
4	CIRCUIT DESCRIPTION	11
5	MAINTENANCE	15
6	CALIBRATION AND ADJUSTMENT	20
		24

ILLUSTRATIONS

Figure		Page
1-1	Model 3550 Multifunction Filter	11
2-1	Front and Rear Panels	5
2-2	Pass Band Characteristics	8
2-3	Normalized Attenuation Characteristics	8
2-4	Square Wave Response	8
2-5	Phase Shift	9
4-1	Block Diagram	16
4-2	Response of Quadratic Amplifiers	17
5-1	Trims and Adjustments	21
Appendix		
	Schematic, Layout and Parts List	Inside Rear Cover

TABLES

Table		Page
3-1	Acceptance Checkout Procedure	12
5-1	Test Point vs Signal Voltage	22
6-1	Calibration Procedure	26

Figure 1-1. Model 3550 Multifunction Filter

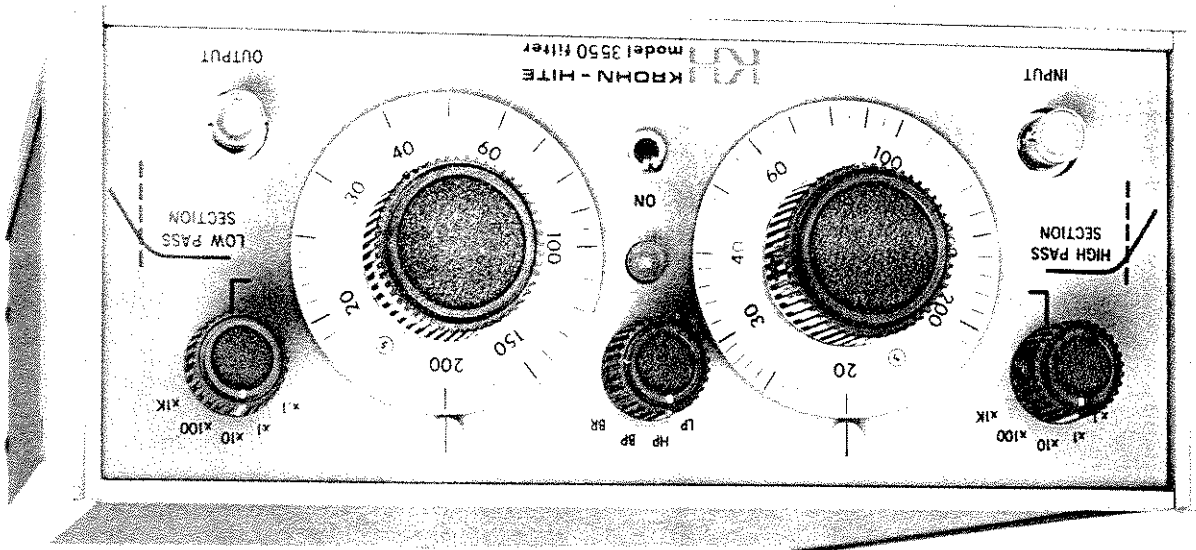

SECTION I GENERAL DESCRIPTION

1.1 INTRODUCTION

The Krohn-Hite Model 3550, shown in Figure 1-1, is a multifunction filter that operates in a high-pass, low-pass, band-pass, or band-reject mode. The cutoff frequencies are independently adjustable between 2 Hz and 200kHz. An optional rack-mounting kit (Part No. RK-38) is available from Krohn-Hite for installing the Model 3550 in a standard 19" rack spacing.

1.2 ELECTRICAL SPECIFICATIONS

Function
Low-pass, high-pass, band-pass, band-reject.

BAND	MULTIPLIER	FREQUENCY (Hz)
1	0.1	2-20
2	1	20-200
3	10	200-2000
4	100	2,000-20,000
5	1K	20,000-200,000

Frequency Control

Low-pass and high-pass functions each have one decade dial and a 5-position multiplier switch, effectively a 30 inch long scale for the 5 frequency bands.

Cutoff Frequency Calibration Accuracy

±5% bands 1 thru 4, ±10% band 5 with RESPONSE switch in MAX FLAT (Butterworth) position; less accurate in LOW Q position. Relative to mid-band level, the filter output is down 3dB at cutoff in MAX FLAT position and approximately 12dB in LOW Q position.

Bandwidth

Low-Pass Mode: From approximately 0.2 Hz to cutoff setting between 2.0 Hz to 200 kHz.

High-Pass Mode: From cutoff setting of 2.0 Hz to 200 kHz, to approximately 3 MHz.

Band-Pass: Both cutoffs adjustable from 2.0 Hz to 200 kHz. For minimum bandwidth (Butterworth response) both cutoff frequencies are set to coincide. This produces an insertion loss of 6 dB, with the 3dB points at 0.8 and 1.25 times the mid-band frequency.

Band-Reject: Both cutoff frequencies adjustable from 2.0 Hz to 200 kHz. Lower pass band to approximately 0.2 Hz, upper passband to approximately 3 MHz. A sharp null can be obtained by setting the High Pass section to about twice the null frequency, and the Low Pass section to half the null frequency, and alternately adjusting both dials for minimum response.

Response Characteristics

Choice of 4 pole Butterworth (Maximally flat response) for frequency domain operation and Low Q (damped response) for transient-free time domain operation, selected by means of a switch on the rear panel.

Attenuation Slope

Nominal 24 dB per octave in all modes of operation.

Pass Band Gain

Zero db \pm 1 db in pass band.

Maximum Attenuation

Greater than 60 dB

Input Characteristics

Max Voltage: \pm 7V peak to 2 MHz.

Max DC Component: \pm 100V.

Input Impedance: 10 Megohms in parallel with 50 pF.

Output Characteristics

Max Voltage: \pm 7V peak to 2 MHz.

Max Current: \pm 15 ma peak.

Internal Impedance: 50 ohms.

Hum and Noise

Less than 200 μ v, except 400 μ v in "BAND REJECT" mode.

Section I - General Description

Output DC Level Stability

± 1 mv/ $^{\circ}$ C, ± 1 mv/hr. Somewhat greater in BR mode.

Front Panel Controls

High Pass Section: Hz dial and multiplier switch.

Low Pass Section: Hz dial and multiplier switch.

Function Switch: LP, HP, BP, BR.

Power ON Switch

Rear Panel Controls

Response Switch: MAX FLAT, LOW Q.

Ground Switch: CHASSIS, FLOATING.

DC Level: Potentiometer.

Line Switch: 115V/230V.

Terminals

Front and rear panels, one BNC connector for INPUT, one for OUTPUT. AC power receptacle with detachable line cord. One rear terminal for chassis grounding.

Power Requirements

105-125 or 210-250 volts, single phase, 50-400 Hz, 10 watts.

Operating Temperature Range

0 $^{\circ}$ C to 50 $^{\circ}$ C.

Dimensions and Weights

Model	Overall Dimensions				Shipping Weight
	Width	Height	Depth	Net	
3550	8 1/2"	3 1/2"	13"	9 lb/4kg	14 lb/7kg

Optional Rack Mounting Kit

(Part No RK-38)



SECTION 2 OPERATING INSTRUCTIONS

2.1 INITIAL SETUP

The filter is adjusted and checked carefully in our test department to insure that it meets all specifications. It is then aged and tested again before shipment. The filter is shipped complete and after unpacking is ready for use.

The Model 3550 should be unpacked carefully and inspected for damage that may have occurred in shipping. Check all controls for freedom of operation.

The Filter may be operated from an AC power source of either 105-125 volts, 50-400 Hz, or 210-250 volts, 50-400 Hz. A 115/230V LINE switch, located on the rear panel, selects the filter's mode of operation. When the AC line is 115V, move the LINE switch to the 115V position. In this mode, a 1/8 ampere slow-blow fuse must be used. When the filter is to be operated from 230 VAC, move the LINE switch to the 230V position, and replace the fuse with a 1/16 ampere slow-blow type.

2.2 CONTROLS AND TERMINALS (Figure 2-2)

2.2.1 Front Panel

The function switch in the top center of the front panel selects one of four filtering functions: Low Pass (LP), High Pass (HP), Band Pass (BP), or Band Reject (BR).

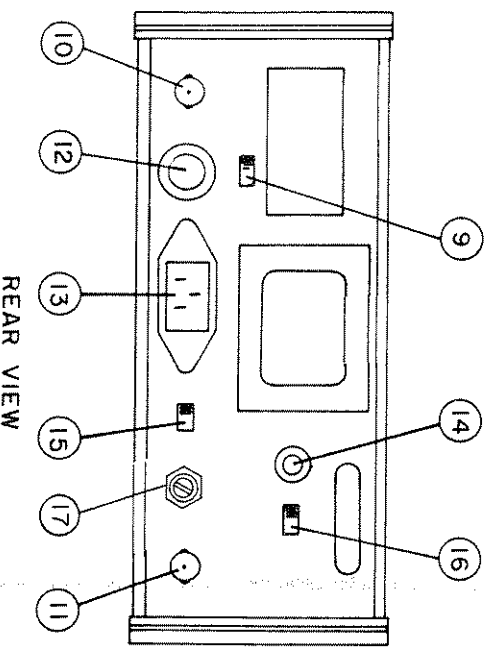
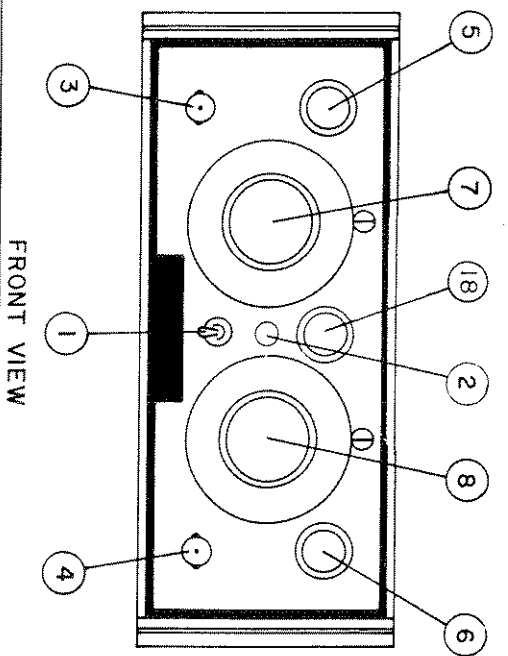

FIGURE 2-2. FRONT AND REAR PANELS

- ① POWER SWITCH (ON/OFF)
- ② INDICATOR LIGHT
- ③ INPUT CONNECTOR (BNC TYPE)
- ④ OUTPUT CONNECTOR (BNC TYPE)
- ⑤ MULTIPLIER SWITCH (HIGH PASS)
- ⑥ MULTIPLIER SWITCH (LOW PASS)
- ⑦ FREQUENCY DIAL (LOW CUTOFF)
- ⑧ FREQUENCY DIAL (HIGH CUTOFF)
- ⑨ 115/230V LINE SWITCH

- ⑩ OUTPUT CONNECTOR (BNC TYPE)
- ⑪ INPUT CONNECTOR (BNC TYPE)
- ⑫ FUSE
1/8A SLO-BLO 117V
1/16A SLO-BLO 234V
- ⑬ POWER RECEPTACLE
- ⑭ CHASSIS GROUND CONNECTOR (BINDING POST)
- ⑮ GROUND SWITCH (FLOATING / CHASSIS)
- ⑯ RESPONSE SWITCH (MAX FLAT/LOW Q)
- ⑰ DC LEVEL POTENTIOMETER
- ⑱ FUNCTION SWITCH (LP, HP, BP, BR)

Figure 2-2. Front and Rear Panels

Narrowest passband in the band-pass mode is obtained by setting both cutoff frequencies equal as shown in figure 2-2, curve C. The resulting insertion loss is

2.4.1 Narrow Bandpass

2.4 SPECIAL FUNCTIONS

If the input signal exceeds the maximum specified levels (7V peak, ±100 vdc) or if the output current exceeds ±15mA peak clipping will occur.

NOTE

2.3.4 Turn ON power.

2.3.3 Set the function switch to the desired mode and the High Pass and Low Pass section controls to the required frequency ranges.

2.3.2 Make connections to the INPUT and OUTPUT.

2.3.1 Connect the Model 3550 to the power line.

2.3 OPERATING PROCEDURE

The RESPONSE switch provides choice between MAX FLAT and LOW Q response of the Model 3550. The GROUND switch, recessed in the rear panel to prevent inadvertent operation, connects the chassis to circuit ground in the CHASSIS position and disconnects them in FLOATING. The DC LEVEL multiturn screwdriver - adjustable potentiometer permits setting of the output DC level. The LINE switch selects 115V or 230V AC operation. The INPUT and OUTPUT BNC connectors again occupy the corners and the CHASSIS binding post provides means for grounding the chassis. A fuse holder labeled with the required fuse rating, is also mounted on the rear panel.

2.2.2 Rear Panel

The cutoff frequencies are set by dials and multiplier switches, one for the High Pass and one for the Low Pass sections. The power ON switch and indicator light in the lower center complete the front panel controls. BNC Connectors for INPUT and OUTPUT are located in the lower corners.

6 dB, (at band center), and the 3 dB points are at about 0.8 and 1.25 times mid-band frequency.

2.4.2 Null

A sharp null can be obtained in the Band Reject mode by setting the Low Pass section to half the null frequency and the High Pass section to twice the null frequency and alternately adjusting both dials to minimize the output. Figure 2-2, Curve D.

2.4.3 Maximum Flat vs. Low Q Responses

In the MAX FLAT position of this rear-panel switch the filter response is a fourth order Butterworth function:

$$G_L = \frac{\sqrt{1 + S^8}}{1}$$

$$G_H = \frac{\sqrt{1 + S^8}}{S^4}$$

G = gain

$$S = \frac{f_0}{f}$$

f = frequency

f₀ = cutoff frequency setting

This response is plotted as the solid curves in Figure 2-2, curves A and B, and normalized on a larger scale as in Figure 2-3. It hugs the 0-dB line very closely with no ripples almost to the cutoff frequency, and then keeps close to the 24dB/octave asymptote, departing 1dB from these lines at f/f₀ = 0.8 and 1.25 respectively.

The limitations of this type of filter are apparent in Figure 2-4(a) which shows the step-function response of a fourth order Butterworth low pass. For applications where this eleven percent overshoot cannot be tolerated, the Model 3550 provides the LOW Q position of the RESPONSE switch. In this mode the sharpness of the cutoff is reduced just enough to eliminate the step-function overshoot (see Figure 2-4(b)). The frequency response of the LOW Q mode is shown by the dotted curves in Figure 2-2 (curves A and B). Obviously, the cutoff is much less sharp, the attenuation at the corner is approximately 12 dB and the 1 dB points are at 0.2 and 5 times the cutoff frequency.

This reduction of cutoff sharpness has no real meaning for a high-pass filter but was included in the Model 3550 high pass section to provide symmetrical band pass and band reject curves when the LOW Q mode is used.

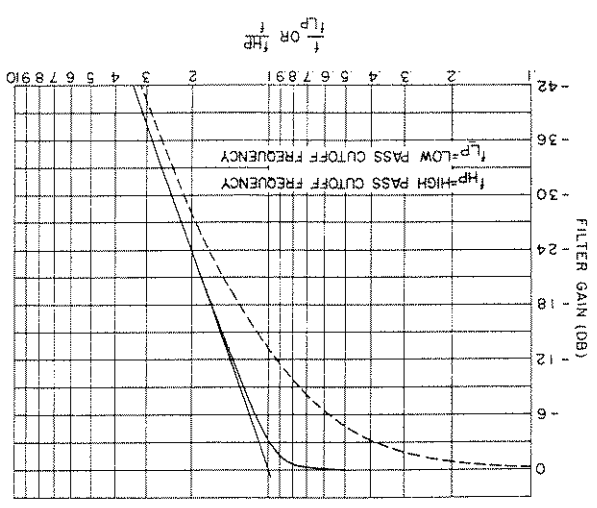

Figure 2-3.

Normalized Attenuation Characteristics

Figure 2-4. Square Wave Response

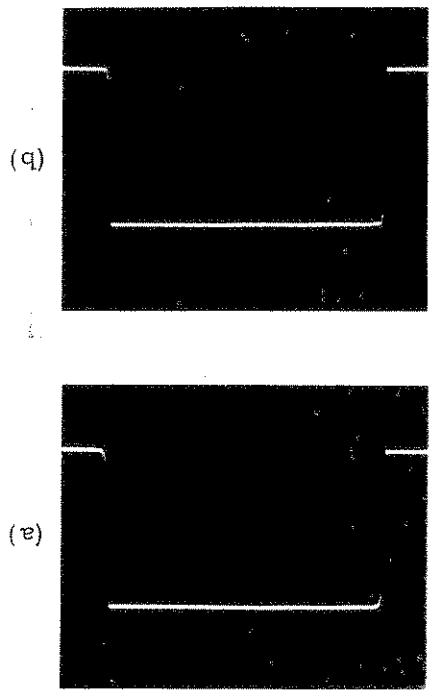
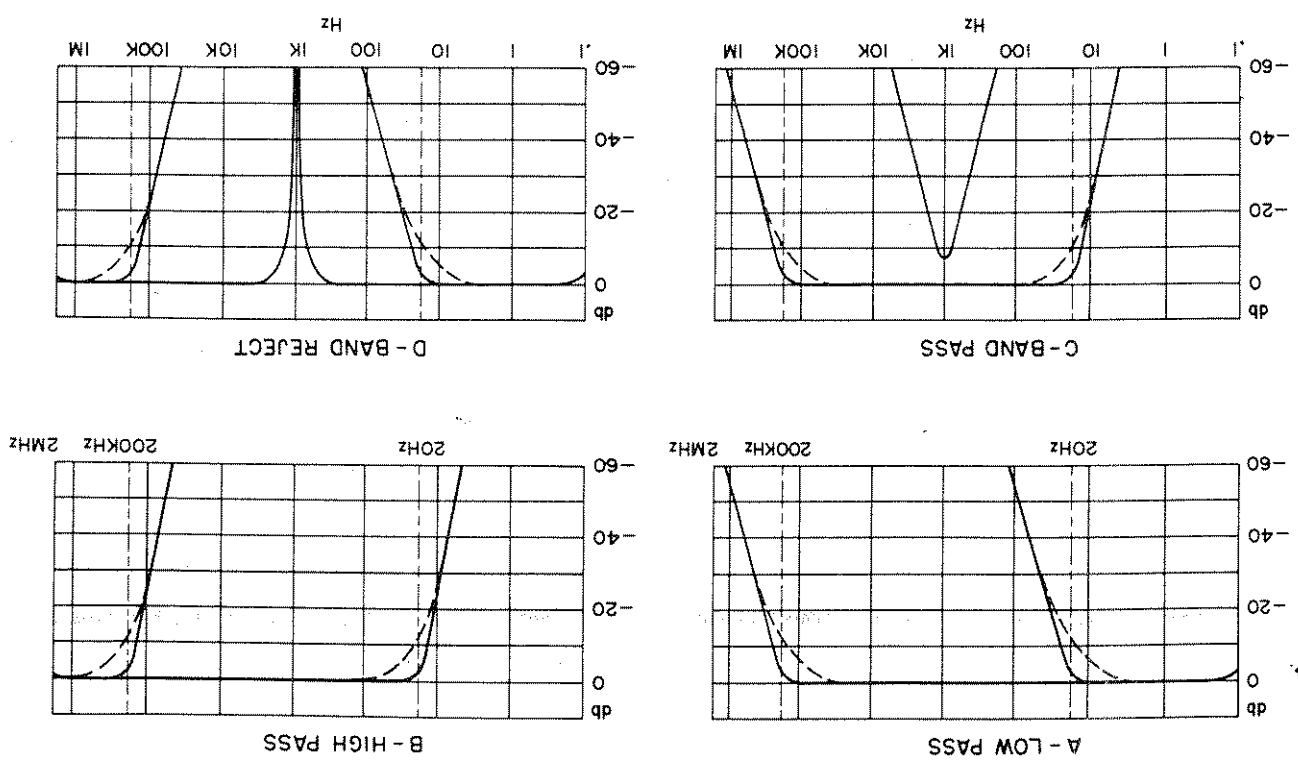

Figure 2-2. Pass Band Characteristics



2.4.4 Phase Response

The phase shift in each section of the filter is shown in Figure 2-5. In the drawing a positive angle means phase lead, i.e., the output voltage leads input voltage. The solid curve is for MAX FLAT mode, and the dotted curve for LOW Q mode. When the Model 3550 is used for bandpass, both sections are cascaded (see Section 4) and phase shifts add algebraically. Note that at pass band center frequency ($f = f_{HL}$) the phase shift is zero. An example of the computation of phase shift in the band pass mode follows:

Given: Pass band 100 Hz to 500 Hz (i.e. High Pass section set to 100 Hz and the Low Pass section set to 500 Hz.)

Find: Phase shift at 200 Hz MAX FLAT response

1. High pass relative frequency = $\frac{100 \text{ Hz}}{200 \text{ Hz}} = 2.0$
2. Low Pass relative frequency = $\frac{500 \text{ Hz}}{200 \text{ Hz}} = 0.4$

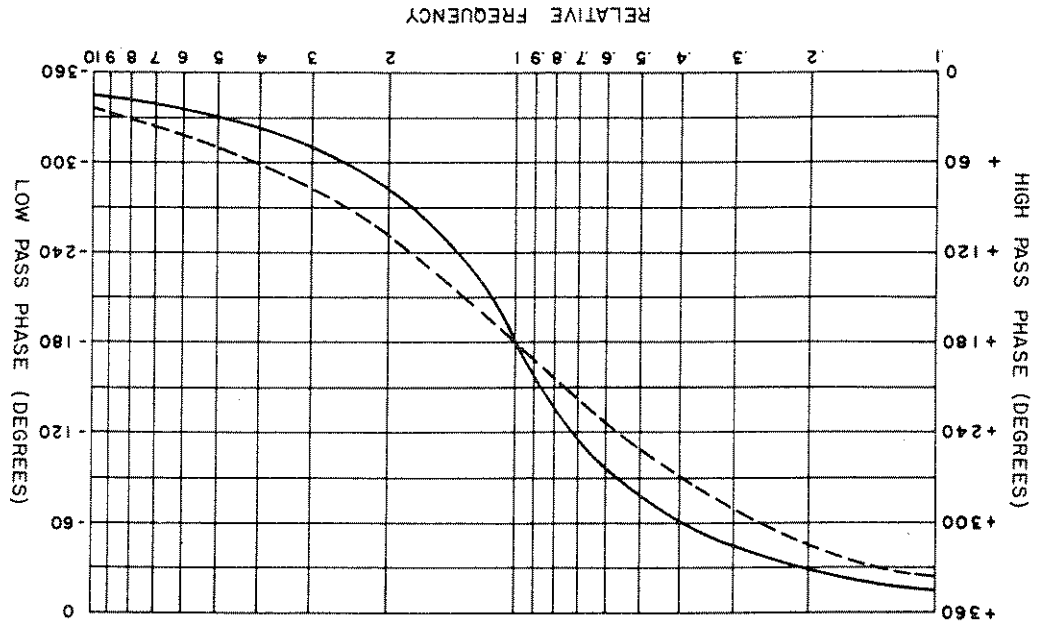

Figure 2-5. Phase Shift

3. Referring to Figure 2-5:

High pass phase shift = 80°
 Low pass phase shift = -60°

4. Resultant phase shift = 20°

In the band reject mode, the High Pass and Low Pass sections are connected in parallel (see Section 4). The phase shift is then determined vectorially adding the contributions of both filters. An example follows:

Given: Reject Band 100 Hz to 500 Hz (Low Pass section set to 100 Hz and High Pass section to 500 Hz).

Find: Attenuation and phase shift at 200 Hz.

1. High pass relative frequency $\frac{200 \text{ Hz}}{500 \text{ Hz}} = 0.4$

2. Low pass relative frequency $\frac{100 \text{ Hz}}{200 \text{ Hz}} = 2.0$

3. Referring to Figure 2-3:

High pass normalized frequency $\frac{200 \text{ Hz}}{500 \text{ Hz}} = 2.5 = 32 \text{ db}$

Low pass normalized frequency $\frac{100 \text{ Hz}}{200 \text{ Hz}} = 2.0 = 24 \text{ db}$

4. For filter voltage input E:

High pass section output

$$= .025E \angle +300^\circ = .0122E - j0.0216E$$

Low pass section output

$$= .0625E \angle -280^\circ = .0108E + j0.0615E$$

$$\text{Sum} = .0233E + j0.0399E = 0.0462E \angle 59.7^\circ$$

The attenuation is 26.7 dB and phase shift is 59.7° .

SECTION 3 INCOMING ACCEPTANCE AND INSPECTION

3.1 INTRODUCTION

The following procedure should be used to verify the Filter operation within specifications. These checks may be used for incoming inspection and periodic specifications checks. Tests must be made with all covers in place. If the instrument is not operating within specifications refer to Section 5 and 6 before attempting any detailed maintenance. Before testing, follow the initial setup and operating procedures given in Section 2.

3.2 TEST EQUIPMENT REQUIRED

The following test equipment is required to perform these tests:

- a. RC Oscillator, with frequency range 0.01 Hz to 1 MHz, frequency accuracy $\pm 0.5\%$ to 100 KHz, frequency response better than ± 0.05 dB and distortion less than 0.02%, Krohn-Hite Model 4100A or equivalent.
- b. Oscilloscope, with DC to 50 MHz bandwidth, vertical input sensitivity of 1 mv/cm, Tektronix type 544, with type 1A5 plug-in, or equivalent.
- c. AC Voltmeter, capable of measuring 100 microvolts to 10 volts RMS, Ballantine Model 314A or equivalent.
- d. DC Voltmeter, capable of measuring 1 millivolt to 20 volts, Fluke Model 8000A or equivalent.

3.3 TEST PROCEDURE AND CONDITIONS

Table 3-1 gives the conditions and setup for testing the various filter characteristics. Unless otherwise specified in the table, the RESPONSE switch is in the MAX FLAT position, and the output load is greater than 1000 ohms. In the table, voltages are rms unless otherwise specified.

Test	Func-tion	HP Section	LP Section	Input Frequency	Set Amplitude	
1. Low	LP	--	200 x 1000	60 kHz	1V at Output	
Pass	Operation	Measure osc. voltage at filter input. Limits are 0.9 to 1.1 volts. Follow same procedure with osc at 6 kHz, 600 Hz and 6 Hz. Limits are 0.9 to 1.1. Switch osc to 200 kHz. Limits are .63 to .77 volts at output.				
2. High	Pass	HP	200 x .1	60 Hz	1V at Output	
Operation	Pass	Measure osc voltage at filter input. Limits are 0.9 to 1.1 volts. Follow same procedure with osc at 600 kHz, and 60 kHz. Limits are 0.9 to 1.1 volts. Switch osc. to 20 Hz. Limits are .63 to .77 volt at output.				
3. Band	Pass	BP	200 x 1	200 x 10	600 Hz	
Operation	Pass	Measure osc voltage at filter input. Limits are 0.9 to 1.1 volts. Switch osc to 100 Hz. Output voltage should be 50 to 80 millivolts. Switch osc to 200 Hz. Output should be .63 to .77 volt. Switch osc to 2 kHz; output should be .63 to .77 volt. Switch osc to 4 kHz; output should be 50 to 80 millivolts.				
4. Band	Reject	BR	50 x 100	20 x 10	50 Hz	
Operation	Reject	Switch osc from 50 Hz to 200 Hz; output should be .63 to .77 volt. Switch osc to 1 kHz; output should be less than 5 millivolts. Switch osc to 5 kHz; output should be 0.9 to 1.1 volts.				
5. Atten-tion	Slope(HP)	HP	200 x .1	50 Hz	1V at Output	
Operation	Slope(HP)	Switch osc from 50 Hz to 10 Hz. Switch HP to 200 x 1 and osc to 100 Hz. Switch HP to 200 x 10 and osc to 1 kHz. Switch HP to 200 x 100 and osc to 10 kHz. Output should read between 50 millivolts and 80 millivolts at each HP section multiplier setting. Switch HP to 200 x 1000 and osc to 100 kHz. Output should read 45 millivolts to 100 millivolts.				
6. Atten-tion	Slope(LP)	LP	--	20 x 1000	1 kHz	
Operation	Slope(LP)	Switch osc 40 kHz. Output should read between 45 and 100 millivolts. Switch LP to 20 x 100 and osc to 4 kHz. Switch LP to 20 x 10 and osc to 400 Hz. Switch LP to 20 x 1 and osc to 40 Hz. Output at each LP multiplier setting should be between 50 and 80 millivolts.				
7. x.1 band	LP Cali- bration	LP	----	200 x .1	10 Hz	
Operation	LP Cali- bration	Change oscillator to 20 Hz. Read 0.63 to 0.77 volt at output.				

Table 3-1. Acceptance Checkout Procedure

Table 3-1. Acceptance Checkout Procedure (Contd.)

Test	Func-tion	HP Section	LP Section	Input Frequency	Set Amplitude
8. x1 LP	Calibration LP	----	60 x 1	20 Hz	1V at Output.
9. x10 band	LP Cali-	----	60 x 10	200 Hz	1V at Output
Change oscillator to 60 Hz. Read 0.63 to 0.77 volt at output.					
10. x100	Band LP	----	60 x 100	2 KHz	1V at output.
Change oscillator to 6 KHz. Read 0.63 to 0.77 volt at output.					
11. x1000	Band LP	----	60 x 1000	20 KHz	1V at Output
Change oscillator to 60 KHz. Read 0.56 to 0.84 volt at output.					
12. x1000	Band HP	HP	20 x 1000	60 KHz	1V at Output
Change oscillator to 20 KHz. Read 0.56 to 0.84 volt at output.					
13. x100	Band HP	HP	60 x 100	20 KHz	1V at Output
Switch oscillator to 6 KHz. Read 0.63 to 0.77 volt at output.					
14. x10 HP	Calibration HP	HP	60 x 10	6 KHz	1V at Output
Change oscillator to 600 Hz. Read 0.63 to 0.77 volt at output.					
15. x1 Band	HP Cali-	HP	60 x 1	600 Hz	1V at Output
Change oscillator to 60 Hz. Read 0.63 to 0.77 volt at output.					
16. x1	Band HP	HP	200 x .1	60 Hz	1V at Output
Change oscillator to 20 Hz. Read 0.63 to 0.77 volt at output.					
17. Maxi-	mm Volt-	BP	20 x 1	1 KHz	1V at filter input
Connect oscilloscope to output. Increase amplitude of osc signal until clipping is observed. Input voltage should reach 5 vrms before clipping occurs.					
18. Maxi-	mm Cur-	BP	20 x 1	1 KHz	0.5V at filter Output
Connect oscilloscope to output. Place 50-ohm load across output, and adjust osc amplitude so that output is .5 vrms. No clipping should occur.					

Test	Func-tion	HP Section Cutoff	LP Section Cutoff	Input Frequency	Set Amplitude
19. Impedance	BP	20 x 1	200 x 1000	2 kHz	0.1V at filter Output
Shunt output with 50 ohm resistor. Voltage at output should drop to .05 ± .01 volt.					
20. Hum and Noise	BP	20 x 1	200 x 1000		
Shield front and rear inputs. Output voltage should be less than 200 microvolts rms.					

Table 3-1. Acceptance Checkout Procedure (Contd.)

SECTION 4

CIRCUIT DESCRIPTION

4.1 GENERAL

Figure 4-1 shows the Model 3550 filter in block diagram presentation.

The incoming signal passes first through the unity-gain input amplifier and then is switched by the Function Switch either to the High Pass (HP) or the Low Pass (LP) section or both, depending on the filtering function selected. In the Band Pass position both sections are connected in series. In the Band Reject position both sections are in parallel with outputs added through a pair of 10k resistors.

The output amplifier is capacitor coupled, to eliminate dc drift from the previous stages, and provides low output impedance. It also has voltage gain to compensate for adding losses and to maintain zero insertion loss in the Band Reject (BR) function.

The following paragraphs describe each section of the Model 3550 filter more fully.

4.2 INPUT AMPLIFIER

Each of the INPUT connectors, front and rear, has a resistor in series. With the capacitance of the shielded front-to-rear cable these resistors act as low pass filters, attenuating frequencies above 2 MHz.

The input capacitor C101, blocks dc and with R101 provides a low frequency pass band down to 0.2 Hz. Resistor R102 protects the input FET Q101 from damage by high input voltages. C102 and R103 are high-frequency bypass for R102.

The drain of Q101 drives the base of Q102. The collector of Q102, through dissipation limiting resistor R110, provides the output signal, as well as feedback to the source of Q101. Resistor R104, capacitor C103 and the ferrite bead L101 are for loop stabilization.

4.3 HIGH PASS SECTION

Input to the High Pass Section comes from the input loop through the function switch. It goes directly to the first HP tuning network consisting of two potentiometers and two capacitors. The potentiometers are ganged, are operated by the tuning dial, and have series and parallel trimming resistors. The capacitors are selected by means of the bandswitch. The values of the two network

Figure 4-1. Block Diagram

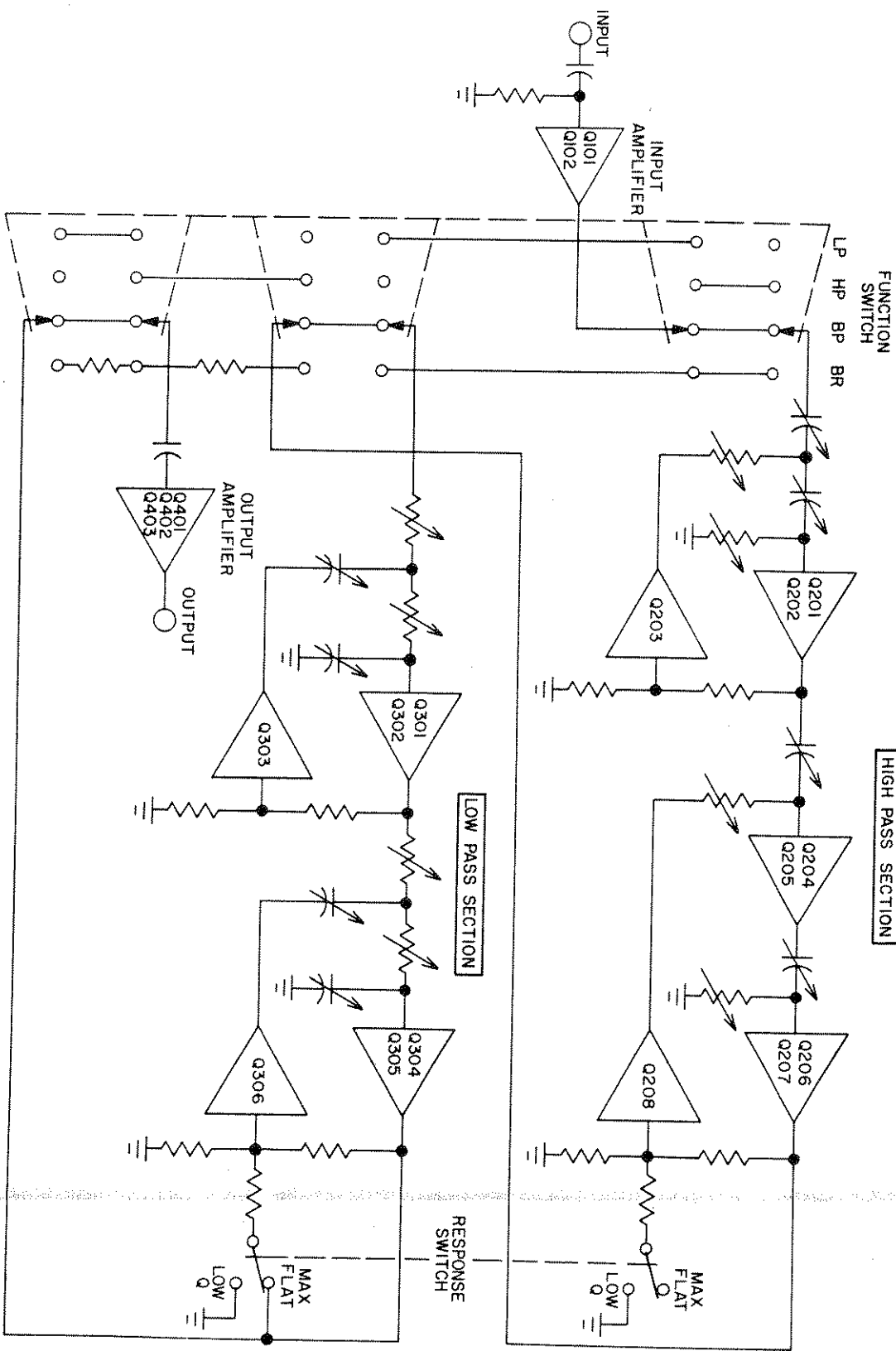

capacitors are in the ratio of 10 to 1, so that each capacitor can be used on two adjacent bands. A double emitter follower, Q201 and Q202 at the output of the network provides isolation and drives, through a voltage divider R205-R206, the feedback emitter follower Q203.

The circuit so far comprises the first "quadratic" of the HP section. The name "quadratic" is used here to denote a network with a second order transfer function, as in this case:

$$\frac{E_2}{S^2} = \frac{E_1}{1 + 2as + S^2}$$

where $s = j \frac{f_0}{f}$

f = frequency

$$f_0 = \frac{C_1 C_2 R_1 R_2}{1}$$

a = "peaking factor"

The "peaking factor" depends on the ratios of network resistors and capacitors and the amount of feedback. For the two values of "a" used in the Model 3550, frequency responses of the two quadratics would look like this:

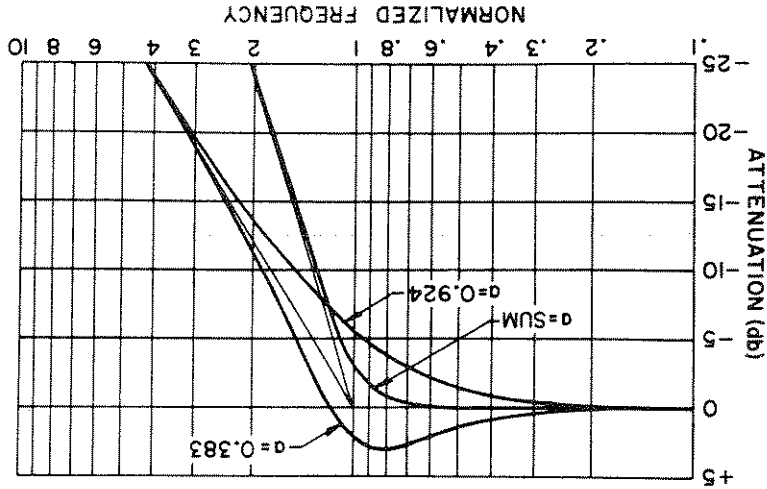

Figure 4-2. Response of Quadratic Amplifiers

The second HP quadratic is slightly different; an amplifier Q204 and Q205 feeds the second RC, which in turn feeds the EFT-input amplifier Q206, Q207. Resistors R218 and R226 and R219, connected as a voltage divider, determine the gain of the loop. Resistors R218 and R226 are paralleled on Band 4 with R701 and on band 5 with R702 to increase the amplifier gain.

The power supply provides +15 volt and -15 volt regulated voltages for the operation of the Model 3550. The unit can be operated either from 105 to 125 volt or a 210 to 250 volt ac source, 50 to 400 Hz. The two line voltages can be accommodated by

4.6 POWER SUPPLY

Output dc level is adjusted coarsely with P401 on the printed circuit board, and can be finely trimmed with P901 in the rear panel. In the BR mode only, the level can be set with P402.

Feedback to the source of the input FET comes directly from CR401 in the LP, HP, and BF modes. In the BR mode signals from the High Pass and the Low Pass sections are added through resistors R802 and R803, with a 6 dB loss of gain. To make up for the loss, a resistance divider R805 and R807 and R413 is inserted in the feedback, causing a 6 dB increase in the amplifier gain.

The output amplifier is capacitor coupled at the input (C401 and R404). The cutoff is at about 0.2 Hz---same as for the input amplifier. The first stage, Q401, an FET, drives the output stage Q403 through the emitter follower Q402. R412 in the collector of Q403 limits dissipation; C408 is a high frequency bypass. L401 and R410 in series with the output stabilize the loop for capacitive loads. CR401 is for temperature compensation of the output DC level.

4.5 OUTPUT AMPLIFIER

The amplifier for the second quadratic, Q304, Q305 and Q306 is similar to the first one. The higher peaking factor of this quadratic ($a = .383$, same as the High Pass second quadratic) requires more feedback so the divider R313-R318 has less attenuation.

RESPONSE switch S904B, when switched to the LOW Q position, changes the peaking factor of this quadratic from $a = .383$ to $a' = .97$ by switching R317 from shunting R313 to shunting R316.

4.4 LOW PASS SECTION

The Low Pass section consists of two quadratics, same as the High Pass section described in 4.3. The first amplifier consists of Q301 and Q302, connected as a double emitter follower. Inductor L302 and R319 in the emitter of Q302 prevent spurious high frequency oscillation. Voltage divider R305-R307 provides feedback amplifier Q303 with the proper gain to obtain a peaking factor of $a = .924$, as required for the first quadratic of a four-pole Butterworth filter.

The RESPONSE switch shunts R225 with R222 in the LOW Q position. This reduction of feedback changes the peaking factor of the second quadratic from $a = .383$ to about $a = .97$, changing the response of the High Pass section from a Butterworth to the damped, transient-free form discussed in Section 2.4.3.

The feedback emitter follower Q208 is fed from the loop output through divider R221-R225. On band 4 the feedback is modified by R704, and on band 5 by R705, C740, C741.

use of the 115V/230V LINE switch, located on the rear panel. A fuse, a power switch, and an indicator lamp with its series resistor complete the primary circuit of the power transformer. The center tapped secondary drives a dual fullwave rectifier, providing both positive and negative outputs. These are smoothed by filter capacitors C501 and C502, and then separately regulated. Each regulator incorporates a series transistor, an amplifier, and another transistor used as a Zener reference. To understand the operation of the regulators, consider the positive supply as follows:

Any virtual disturbance, say an increase in +15 regulated voltage, would be applied to the emitter of Q503 through the Zener Q502 and temperature compensating diodes CR502. The base of Q503 would also get a signal in the same direction but attenuated by the voltage divider R511 and R501-R506. As a result, Q503 would be turned off, reducing the base current of Q501, thus lowering the output voltage of the regulator. The operation of the negative power supply is analogous.

Capacitors C503 and C504 speed up the operation of the regulators by keeping bases of Q503 and Q504 steady when fast changes of regulator output are fed to their emitters. R508 and C508 in parallel feed some ripple from the unregulated supply into the regulator base, in the proper phase, to reduce ripple on the regulated negative output; R505 and C507 do the same for the positive power supply.

If the filter does not seem to be working properly, check the two power supplies first. If the positive and negative 15 volt supplies appear to be correct refer to signal tracing analysis, paragraph 5.3. Any malfunction of the power supplies will generally cause a large error in positive or negative 15 volt output. Small errors may be corrected by adjusting R506 and R509 respectively. If the -15 volt supply is correct and the +15 volt supply is incorrect, check the reference voltage from the emitter of Q503 to the collector of Q502. This reference voltage should be 8.4 \pm .5 volts. Normally, if the +15 volt supply is high, the base-emitter voltage of Q503 will be reduced, decreasing its collector current, lowering the emitter to base voltage and turning off Q501. This will increase the emitter to collector voltage of Q501, correcting the +15 volt supply. The failure will be found where this action is blocked. If the +15 volt supply is low, the current in Q503 will be increased, turning on Q501. If the supply voltage is low and Q503 and Q501 appear to be operating properly, the cause is most likely excessive current in the main filter section. An incorrect -15 volt supply may be traced in a similar manner.

5.2 POWER SUPPLY

First make a visual inspection; check the unit for such things as broken wires, burnt or loose components, or similar conditions which could cause trouble. Any troubleshooting of the Filter will be greatly simplified if you understand the operation of the circuit. Before attempting detailed troubleshooting refer to Circuit Description Section 4.

The general layout of major components, test points, screwdriver controls and adjustments are shown in Figure 5-1. A detailed component layout for the printed circuit card is included with the schematic diagram at the end of this book. Various check points and voltages are shown on the schematic diagram and are also marked on the printed circuit card.

If the Model 3550 is not functioning properly and requires service, follow this procedure to locate the source of trouble. To obtain access to the interior of the filter, remove the screws centered at the rear of each cover; sliding off the side covers will unlock the top and bottom covers.

5.1 INTRODUCTION

MAINTENANCE

SECTION 5

Figure 5-1. Trims and Adjustments

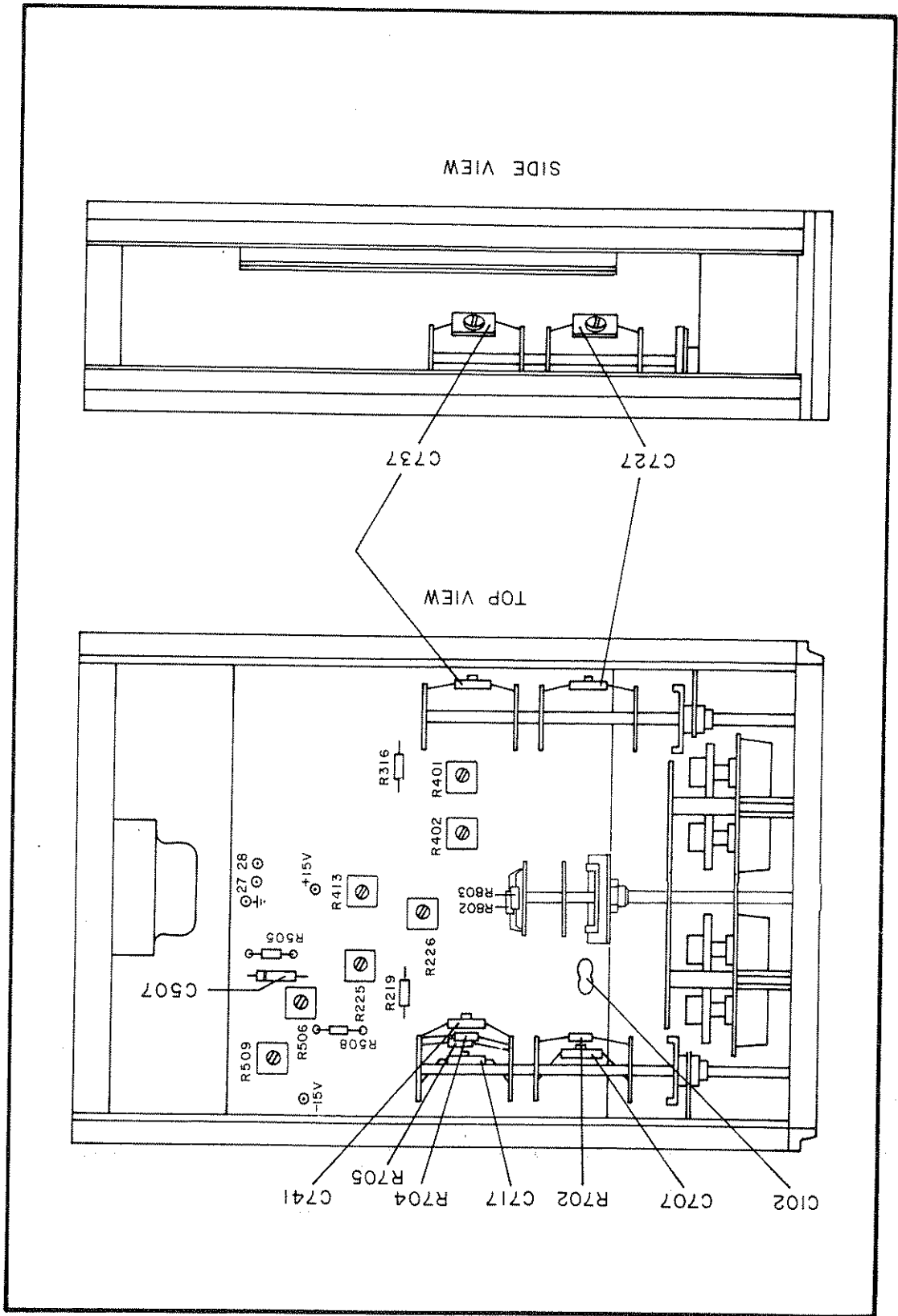

If signal tracing shows one of the tuning circuits to be faulty, it should be determined if the trouble is in the resistive or capacitive elements. If the trouble is in a capacitive element used only in the lowest or highest multiplier range, the malfunction will appear only on these positions. Each of the other tuning capacitors, if defective, will introduce an error in two adjacent bands. If there is a problem in a resistive element, the trouble will be of a general nature and will show up on all multiplier bands.

5.4 TUNING CIRCUITS

Input: 5 vrms, 200 Hz
 LP dial: 200 x 1
 HP dial: 200 x 1
 Function: BP
 RESPONSE: LOW Q

Table 5-1. Test point Signal Voltage

Test Point	Voltage (RMS)
Input	5.0
2	4.9
3	2.8
4	2.8
6	1.6
7	1.6
8	1.3
10	1.3
14	0.43
15	0.67
17	0.31
18	0.30
20	0.14
21	0.30
output	0.30

If the power supplies appear to be correct but the Model 3550 is not working, the following signal tracing analysis should help locate the area of malfunction. Set the Function Switch to BP; set the RESPONSE switch to LOW Q position. Set both the low and high cutoff frequencies to 200 Hz. Connect a 200 Hz 5-volt rms sine wave signal to the input terminals. If the test signal does not appear correctly at the output, the area of the malfunction may be localized by determining where in the filter the signal first deviates from the normal.

Table 5-1 shows various test points with their correct signal levels for band pass operation. If a test point is found whose signal level differs appreciably from the correct value, the circuitry immediately preceding that test point should be carefully checked.

5.3 SIGNAL TRACING ANALYSIS

The values of capacitance used on the highest band are selected to compensate for stray capacitance and are therefore not completely in decade ratios of those used on the lower bands.

Each of the variable resistance elements consists of four potentiometers ganged together with a gear assembly. Each potentiometer has series and shunt trims to insure proper tracking. The trims and the angular orientation of the potentiometers are carefully adjusted at the factory. If it becomes necessary to change one of these potentiometers in the field, it should be replaced only with a unit supplied by the factory complete with proper trims. The angular orientation should then be carefully adjusted following the procedure supplied with the parts.

- a. RC Oscillator, with frequency range 0.01 Hz to 1 MHz, frequency accuracy $\pm 0.5\%$ to 100 KHz, frequency response better than ± 0.5 db and distortion less than 0.02%, Krohn-Hite Model 4100A or equivalent.
- b. Oscilloscope, with DC to 50 MHz bandwidth, vertical input sensitivity of 1 mv/cm, Tektronix type 544, with type 1A5 plug-in, or equivalent.
- c. AC Voltmeter, capable of measuring 100 microvolts to 10 volts RMS, Ballantine Model 314A or equivalent.
- d. DC Voltmeter, capable of measuring 1 millivolt to 20 volts, Fluke Model 8000A or equivalent.

The following test equipment is required to perform these tests.

6.2 TEST EQUIPMENT REQUIRED

Access to the interior of the Model 3550 is gained by removing the screw centered at the rear of each cover; sliding off the side covers will unlock the top and bottom covers.

Before any adjustments the procedure in Section 3 should be followed to determine if adjustments are necessary. The following procedure is provided for the adjustment and calibration of the filter in the field, and adherence to this procedure should restore the filter to its original specifications. If any difficulties are encountered, please refer to Troubleshooting, Section 5. If any question arises which are not covered by this procedure, please contact our factory service department. The locations of trims and adjustments are shown in Figure 5-1. The test points are marked on the PC board.

6.1 INTRODUCTION

SECTION 6 CALIBRATION AND ADJUSTMENT

6.3 INITIAL SET-UP

- a. Set function switch to BP
- b. Set low pass dial to 60, multiplier to x10
- c. Set high pass dial to 60, multiplier to x10.

6.4 POWER SUPPLY

- a. Short filter input.
- b. Connect d-c voltmeter between ground and +15 volts (red lead on P901).
- c. Adjust R506 for 15 ± 0.2 volts.
- d. Connect d-c voltmeter between ground and -15 volts (gray lead on P901).
- e. Adjust R509 for -15 ± 0.2 volts.

6.5 OUTPUT DC LEVEL

- a. Connect d-c voltmeter to output. Set P901 to midrange.
- b. Adjust P401 for 0 volts on the filter output.
- c. Switch function switch to BR.
- d. Adjust P402 for 0 volts on filter output.
- e. Remove short from input.

6.6 CALIBRATION PROCEDURE

The calibration procedure is given in Table 6-1. In the table, the initial test setup is given in tabular form at the beginning of each test, and then follows a sequence of steps. It is important that the sequence be followed in order. Nominal oscillator output voltage at the beginning of all tests is 1 volt rms. Amplitude is then adjusted at the test point given. Unless otherwise specified, voltages are rms.



Test	Function	HP Section	LP Section	Input Freq.	Set Amplitude
1. LP Dial Set	LP	-----	60 x 10	50 Hz	1V at output
Switch osc to 1200 Hz. Adjust LP dial for reading of 63 millivolts on acvm. LP dial should read 60. If off, loosen dial set screws and set to 60. Tighten.					
2. LP Cutoff Response	LP	-----	60 x 10	200 Hz	1V at output
Switch osc from 200 Hz to 600 Hz. Output should read .63 to .77 volt.					
3. LP x 1000	LP	-----	60 x 1000	6 kHz	1V at TP18
Switch osc from 6 kHz to 48 kHz. Trim C727 for .96 volt at TP18. Switch osc to 60 kHz. Trim C737 for 0.7 volt at TP18. If any adjustments were made, repeat step 3.					
4. HP Dial Set	HP	60 x 10	-----	6 kHz	1V at output
Switch osc to 300 Hz. Adjust HP dial for reading of 63 millivolts on acvm. HP dial should indicate 60. If off, loosen dial set screws and set to 60. Tighten set screws.					
5. HP x 10 Unity Gain	HP	60 x 10	-----	2 kHz	1V at input
Connect acvm to output. Adjust R226 for .96 to 1.04 volts.					
6. HP Cutoff Response	HP	60 x 10	-----	2 kHz	1V at output
Switch osc from 2 kHz to 600 Hz. Output should read .63 to .77 volt. If out of limits, trim R225 for .7 ± .07 volt.					
7. HP x 1000 Capacitor Adjust	HP	20 x 1000	-----	100 kHz	1V at TP4
(7a) At 100 kHz set 1 volt at TP4. Switch osc from 100 kHz to 5 kHz. Voltage at TP4 should drop to 63 millivolts. If off trim C707. If C707 adjustment is necessary repeat step 7a. (7b) Connect acvm to output. Switch osc to 100 kHz. Adjust input for 1 volt at output. Switch osc to 10 kHz. Output should read 45 to 80 millivolts. If off adjust C717. If C717 adjustment is necessary, repeat step 7b.					
8. 200 kHz Calibration	HP	200 x 1000	-----	600 kHz	1V at output
Switch osc from 600 kHz to 200 kHz. Trim C741 for .63 to .77 volt at output.					
9. Band Reject	BR	100 x 10	100 x 1	3kHz	1V at input
Remove acvm from input and connect to output. Adjust R413 for .96 to 1.04 volts at output.					

Table 6-1. Calibration Procedure

1

2

3

11/23/82 CO # 42344

PC307

