

AS-61873
INSTRUCTION MANUAL
FOR
AQ-6310B OPTICAL
SPECTRUM ANALYZER

ANDO ELECTRIC CO., LTD.
Tokyo, Japan

The apparatus to which this manual is attached is designed to operate with any of AC 100 V to 120 V, 220 V to 240 V.

This apparatus has been set before shipment from the factory, to the operating voltage to be used. Before use, confirm that the operating voltage indication in the window of (AC LINE) connector at the rear conforms to the voltage of the AC power socket-outlet.

The line voltage AC ***V referred to in this manual should be read as the voltage of the operating voltage indication in the window described above.

If the operating voltage indication, however, does not conform to the voltage of the AC power socket-outlet, change the operating voltage by the procedure illustrated below.

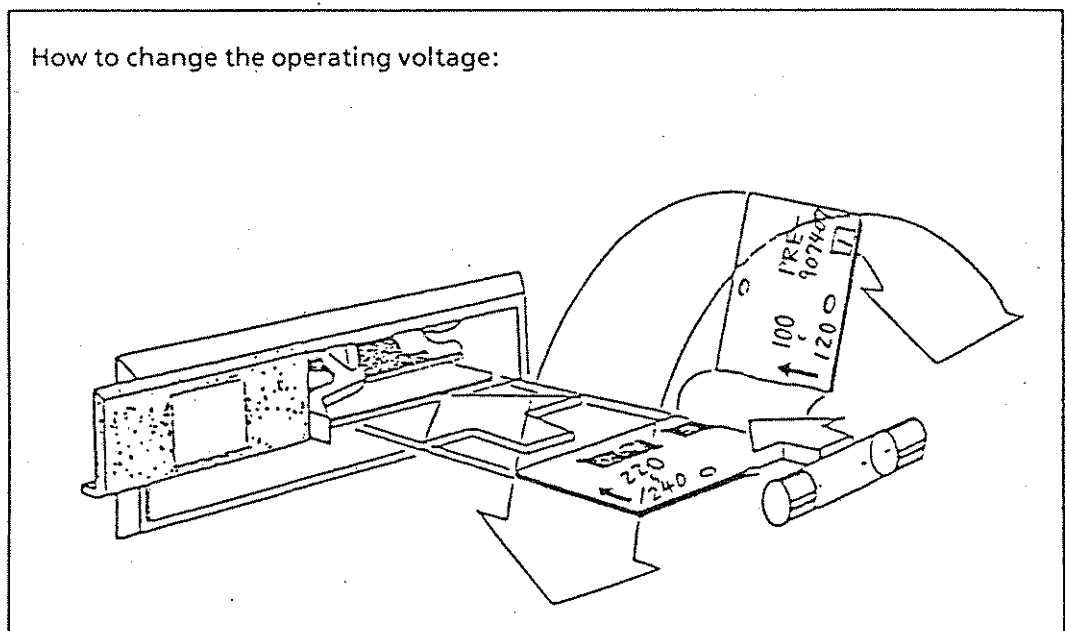
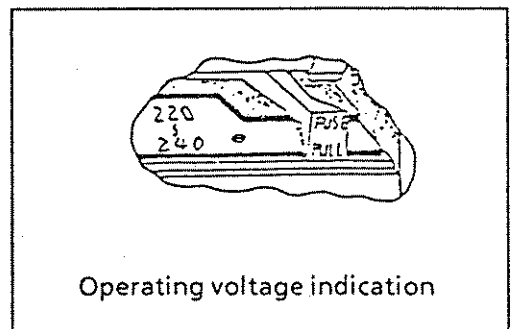

1. Open cover door. Pull [FUSE PULL] lever and rotate it to left. Remove the fuse.
2. Remove the operating voltage selection card. Position this card so that the same value as the voltage of the AC power socket-outlet appears at top-left corner, and

put it firmly into the slot.

3. Rotate [FUSE PULL] lever to normal position. Insert a fuse conforming to the operating voltage-fuse current chart provided above (AC LINE) connector in the holder. Close the cover.

CONTENTS

	PAGE
SECTION 1 GENERAL	
1.1 Introduction	1-1
1.2 General Description	1-1
1.3 Specifications	1-1
1.4 Options	1-2
1.5 Standard Accessories	1-2
1.6 Precautionary Concerns	1-6
SECTION 2 PREPARATIONS FOR USE	
2.1 Introduction	2-1
2.2 Unpacking and Acceptance Inspection	2-1
2.2.1 Mechanical Inspection	2-1
2.2.2 Performance Test	2-1
2.3 Damage or Fault	2-1
2.4 Repacking	2-2
SECTION 3 OPERATION	
3.1 Introduction	3-1
3.2 Operating Controls, Indicators, and Connectors	3-1
3.3 Soft Key Descriptions	3-8
3.4 Preoperational Preparations	3-18
3.5 Operating Procedures	3-18
3.5.1 Initialization	3-18
3.5.2 FUNCTION and MARKER Setup Procedure	3-20
3.5.3 CRT Display Screen Contents Descriptions	3-20
3.5.4 AUTO Measurement	3-22
3.5.5 Manual Measurement	3-24
3.5.6 Measurement Condition Setup	3-27
3.5.7 Sweep Mode Setup	3-37
3.5.8 Display Method Setup	3-42
3.5.9 Marker Usage	3-53
3.5.10 Level Difference Measurement	3-57
3.5.11 Wavelength Difference Measurement	3-60
3.5.12 Half-Width Measurement	3-62
3.5.13 Half-Width Algorithms	3-65

3.5.14	MEMORY and DATA MEMORY	3-71
3.5.15	Waveform Storage and Recall by MEMORY Functions ...	3-72
3.5.16	Data Overlap Display	3-75
3.5.17	Data Subtraction Display by DATA MEMORY Function ...	3-77
3.5.18	Printer Operating Procedure	3-85
3.5.19	Automatic Calibration by CALIBRATION Function	3-90
3.5.20	Comment Display by LABEL Function	3-91
3.5.21	Shutdown Procedure	3-93
3.6	GP-IB Control	3-93
3.6.1	Address Setup	3-93
3.6.2	Function Setup	3-94
3.6.3	Measurement Start	3-94
3.6.4	Measured Data Output	3-95
3.6.5	Other Remote Messages	3-95
3.6.6	SRQ Function	3-96
3.6.7	DC Function	3-96
3.6.8	DT Function	3-96
3.6.9	GP-IB Usage Precautions	3-96
3.7	ATTENTION Display Function	3-110
3.8	Video Interface	3-112
3.9	Abbreviations	3-115
3.10	Measuring Precautions	3-117
SECTION 4 CIRCUITRY AND CONSTRUCTION		
4.1	Introduction	4-1
4.2	Circuitry	4-1
4.2.1	Circuitry Overview	4-1
4.2.2	Individual Circuit Descriptions	4-1
4.3	Construction	4-2
SECTION 5 MAINTENANCE		
5.1	Introduction	5-1
5.2	Pre-operational Checkout	5-1
5.3	Mechanical Inspection	5-1

LIST OF DRAWINGS AND TABLES

Fig. 3-1	Front Panel	3-2
Fig. 3-2	Rear Panel	3-2
Fig. 3-3	CRT Display Screen on Initialization	3-19
Fig. 3-4	CRT Screen Example	3-20
Fig. 3-5	Soft Key Menu Screen (1)	3-21
Fig. 3-6	Soft Key Menu Screen (2)	3-21
Fig. 3-7	AUTO Measurement Example	3-22
Fig. 3-8	LD Light Source First Sweep Waveform	3-25
Fig. 3-9	LD Light Source Last Sweep Waveform	3-26
Fig. 3-10	LED Light Source First Sweep Waveform	3-26
Fig. 3-11	LED Light Source Last Sweep Waveform	3-27
Fig. 3-12	State Prevailing after [CENTER WAVELENGTH] Switch Activation	3-28
Fig. 3-13	State Prevailing after [SWEEP WIDTH] Switch Activation	3-30
Fig. 3-14	State Prevailing after <SWEEP TIME> Switch Activation	3-30
Fig. 3-15	State Prevailing after [$\Delta W \rightarrow$ SPAN] Switch Activation	3-31
Fig. 3-16	State Prevailing after [SENSITIVITY] Switch Activation	3-32
Fig. 3-17	State Prevailing after [RESOLUTION] Switch Activation	3-33
Fig. 3-18	State Prevailing after [REFERENCE LEVEL] Switch Activation	3-35
Fig. 3-19	State Prevailing after [AVERAGE TIMES] Switch Activation	3-36
Fig. 3-20	State Prevailing upon [REPEAT] Switch Activation	3-39
Fig. 3-21	State Prevailing upon <WAIT> Key Activation	3-39
Fig. 3-22	State Prevailing upon [SINGLE] Switch Activation	3-40
Fig. 3-23	State Prevailing upon [STOP] Switch Activation	3-41
Fig. 3-24	LOG Scale Screen	3-42
Fig. 3-25	LIN Scale Screen	3-43
Fig. 3-26	NORMALIZE Function Execution Examples (LOG Scale Mode)	3-45
Fig. 3-27	NORMALIZE Function Execution Examples (LIN Scale Mode)	3-46
Fig. 3-28	DOMINANT Function Execution Examples	3-48
Fig. 3-29	3-D Mode Initial Screen	3-49
Fig. 3-30	3-D Display Example	3-51
Fig. 3-31	Peak Level Measurement Example	3-54
Fig. 3-32	Peak Wavelength Measurement Example	3-56
Fig. 3-33	Level Difference Measurement Examples	3-59

Fig. 3-34	Wavelength Difference Measurement Examples	3-61
Fig. 3-35	Half-Width Measurement Examples	3-64
Fig. 3-36	Half-Width Determination Algorithm (ENV Method)	3-65
Fig. 3-37	Mode Determination	3-66
Fig. 3-38	3-66
Fig. 3-39	3-67
Fig. 3-40	3-67
Fig. 3-41	3-68
Fig. 3-42	3-69
Fig. 3-43	3-70
Fig. 3-44	MEMORY Function Execution Examples	3-74
Fig. 3-45	Overlap Display Function Execution Examples	3-76
Fig. 3-46	Loss Wavelength Characteristic Measurement Setup	3-79
Fig. 3-47	Loss Wavelength Characteristic Measurement Examples	3-81
Fig. 3-48	Manual Setup with <Y SCALE>	3-81
Fig. 3-49	Manual Setup with <Y OFFSET>	3-82
Fig. 3-50	Optical Filter Transmittance Measurement Setup	3-83
Fig. 3-51	Optical Filter Transmittance Measurement Examples	3-84
Fig. 3-52	[COPY ON] Switch Activated	3-87
Fig. 3-53	<PAUSE> Key Pressed after [COPY ON] Switch Activation	3-88
Fig. 3-54	Recording Paper Loading	3-88
Fig. 3-55	[COPY ON] Switch Activated with Head Lifted Up	3-89
Fig. 3-56	[COPY ON] Switch Activated with No Recording Paper Loaded	3-89
Fig. 3-57	LABEL Function Execution Example	3-92
Fig. 3-58	Bus Line Description and Connector Difference	3-109
Fig. 3-59	Output Video Signal	3-113
Fig. 3-60	Video Plotter Adjustment	3-114
Fig. 3-61	Fine Adjustment	3-115
Fig. 3-62	3-117
Fig. 3-63	3-119
Fig. 3-64	3-119
Fig. 3-65	3-120
Fig. 3-66	Principles of Czerny Turner Monochromator	3-121
Fig. 3-67	Grating	3-122

Table 1-1 Specifications	1-3
Table 1-2 Option List	1-5
Table 1-3 Standard Accessory List	1-6
Table 3-1 Switch Descriptions	3-5
Table 3-2 Function Codes	3-97
Table 3-3 Talker Formats	3-107
Table 3-4 STATUS Contents	3-108
Table 3-5 AQ-6310B Interface Construction	3-108
Table 3-6 ATTN Indications No. 0 to 10	3-110
Table 3-7 ATTN Indications No. 21 to 27	3-111
Table 3-8 ATTN Indications No. 31 to 37	3-112
Table 3-9 Abbreviation List	3-115

LIST OF ATTACHED DRAWINGS AND TABLES

AQ-6310B Optical Spectrum Analyzer External Drawing	ASD-61873-1-1/3
AQ-6310B Optical Spectrum Analyzer External Drawing (Front View)	ASD-61873-1-2/3
AQ-6310B Optical Spectrum Analyzer External Drawing (Rear View)	ASD-61873-1-3/3

SECTION 1

GENERAL

1.1 Introduction

This manual describes the operating, handling, and maintenance procedures for the AQ-6310B Optical Spectrum Analyzer.

1.2 General Description

The AQ-6310B is a general-purpose wavelength characteristic measuring instrument. It measures not only the LD, LED, and other light source spectrums, but also the loss wavelength and transmission characteristics of optical fiber cables, filters, and other devices.

The AQ-6310B has a wide wavelength measurement range of 400 to 1750 nm, a high sensitivity to permit measurement of light as weak as -70 dBm, a wavelength resolution of ± 1 nm, and a high sweep rate, thereby covering a wide scope of applications.

In addition to the basic functions such as the center wavelength, sweep width, resolution, and reference level setup functions, the AQ-6310B performs various other functions including the averaging, data memory, data subtraction, marker, peak search, half-width search, label, normalize, dominant, and 3-D display functions.

One major advantage offered by the AQ-6310B is the automatic function setup feature. This feature is provided for enhanced simplicity of operating steps; that is, the center wavelength, sweep width, resolution, and reference level are automatically set to the optimum values when a light source is connected via optical fiber to the AQ-6310B.

The AQ-6310B incorporates a printer so that on-screen image hard-copy printout is obtained with ease. Further, a GP-IB is standard on the AQ-6310B to permit automatic measurement.

1.3 Specifications

The product specifications for the AQ-6310B are presented in Table 1-1.

1.4 Options

The options available for use with the AQ-6310B are listed in Table 1-2.

1.5 Standard Accessories

The AQ-6310B is supplied with the standard accessories listed in Table 1-3.

Table 1-1 Specifications

Measurement wavelength range	400 to 1750 nm
Measurement level range	-80 to + 10 dBm/resolution (600 to 1600 nm) -70 to + 10 dBm/resolution (400 to 1750 nm) (See NOTE 1) Wavelength sensitivity automatic correction function provided.
Linearity	± 1 dB/60 dB ± 0.5 dB/20 dB ± 0.2 dB/10 dB
Level scale	0.2 to 10 dB/div and LINEAR
Wavelength accuracy	± 1 nm (5° to 40°C), ± 0.5 nm (25°C)
Wavelength sweep width	0.0 to 150 nm/div (see NOTE 2)
Resolution	0.1 to 10 nm (540 to 1750 nm) 0.1 to 5nm (400 to 540nm)
Sweep time	1 sec or less (span: 100 nm or less) 2 sec or less (span: 500 nm or less) 5 sec or less (span: 1500 nm or less) (See NOTE 3)
Functions	Automatic measurement, peak search, half-width search, data subtraction, averaging, labeling, normalization, dominant waveform display, three-dimensional display, wavelength calibration (optional calibration light source available), data/measurement condition memory (nonvolatile), etc.
CRT	System : electromagnetic deflection Size : 7-inch Resolution : 640 x 474 dots
Optical input connector	FC type (standard), D4 type (NEC Specification), OF2 type (Fujitsu Specification), W/E type, diamond type, etc.
Printer function	High-speed printer incorporated

Video output	Approx. 1 Vp-p, composite video signal, 75 Ω load, BNC connector
Analog output	0 to 5 V Load: 1 k Ω or more; BNC connector
GP-IB	Provided as a standard item
Option terminal	Connection terminal to the AQ-6002 (option)
Power requirements	100/115-120/220/230-240 VAC, 50/60 Hz, approx. 150 VA
Dimensions and weight	Approx. 266 H x 426 W x 450 mm D Approx. 30 kg

NOTE 1: The resolution is expressed by $\Delta\lambda$. Therefore, the power per resolution or the smallest measurable power approximates to the shaded area below.

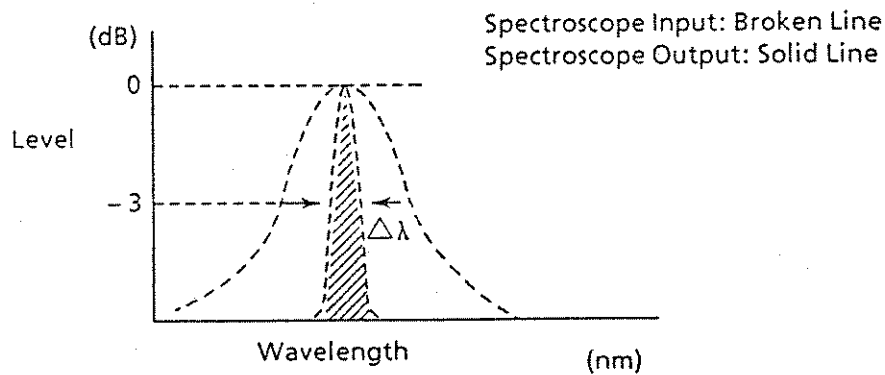

NOTE 2: The 0.0 nm sweep function is exercised to observe how the level changes with time at a certain wavelength. This function is useful for optical axis alignment.

NOTE 3: These values are obtained when the HIGH SENSITIVITY switch is OFF, the AVERAGE TIMES setting is 1, and the center wavelength setting is 1050 nm.

Table 1-2 Option List

AQ-6002 Side-Mode Measuring Unit

(For low level stray light measurement) This unit is used for DFB-LD side mode monitoring.

Measured wavelength range : 950 to 1750 nm

Stray light level specification : When a light source of He-Ne 1523.1 nm is launched, measurement of -60 dB or less can be possible referenced to the wavelength ± 1 nm apart from the peak wavelength of the launched light source.

AQ-4302 He-Ne Laser

(For automatic calibration)

Output light wavelength : 632.8 nm

Optical output level : -8 dBm or higher (For GI50/125 μ m fiber)
-15 dBm or higher (For SM10/125 μ m fiber)

AQ-4303B Light Source

(For wavelength loss characteristic measurement)

Output light wavelength : 400 to 1800 nm

Optical output level : -45 dBm or higher
(wavelength: 850 nm, 1300 nm; wavelength band: 10 nm; CW light)

Output waveform : CW light and 270 Hz chopped light

AQ-9313 Device Adaptor

(For LD/LED device characteristic measurement)

Output form : FC connector attached SM10/125 μ m fiber

Device DC power supply incorporated

AQ-9314 Parallel Beam Mount

(For transmission and loss characteristic measurements of optical filters and other devices)

Fiber used : core diameter, 800 μ m; large-aperture fiber

Large-diameter Optical Fiber Cable

Core diameter : 800 μ m, 400 μ m

Plotter

Produces the hard-copy printout of all CRT screen contents.

Table 1-3 Standard Accessory List

Name	Qty	Remarks
Power cord	1	Approx. 3 m (attached)
Fuse	1	* A (installed) NOTE
Instruction manual	1	
Recording paper	2 rolls	For built-in printer, TF50KS- E2 (Jujo Paper)

NOTE: The ampere is marked on the supply voltage rating indication above the rear panel AC LINE connector.

1.6 Precautionary Concerns

1.6.1 Operating Temperature Range

The operating temperature range within specifications is from +5 to +40°C.

1.6.2 Environmental Conditions

The AQ-6310B incorporates a precision spectroscope; therefore, when storing or transporting the AQ-6310B, use extreme caution to avoid undue temperature, shock, and vibration.

If the following conditions are not met, the AQ-6310B may fail to recover its expected performance.

(1) Storage temperature range: -20 to +50°C

(2) Vibration

Frequency	: 10 Hz
Complex amplitude	: 2 ± 0.5 mm
Direction of vibration	: vibration in all three planes
Vibration time	: 10 minutes in each plane

(3) Shock

The shock caused when one side of the apparatus resting still on a hard wooden floor is raised 2.5 cm and then let fall.

SECTION 2 PREPARATIONS FOR USE

2.1 Introduction

This section describes the procedures for unpacking, acceptance inspection, and repacking.

2.2 Unpacking and Acceptance Inspection

The AQ-6310B has been factory inspected, mechanically and electrically, prior to shipment to ensure that it gives satisfactory performance. When your order is received, promptly unpack it and check its contents for damage that may have been sustained in transit.

When unpacking the apparatus, save the wooden box, corrugated fiberboard box, cushions, and other packing materials so that they may be reused when the apparatus is to be packed again for shipment.

2.2.1 Mechanical Inspection

Visually check the apparatus for damage or faults. Also check its switches and knobs for faults or damage that may have been sustained in transit. Further, check to ensure that the specified number of correct accessories and spare parts are supplied.

2.2.2 Performance Test

If the apparatus is found by the mechanical inspection to be in good order, check its performance for compliance with the product specifications indicated in Table 1-1.

2.3 Damage or Fault

If the apparatus is found damaged or faulty in the acceptance inspection, immediately report the damage or fault to your nearest dealer.

2.4 Repacking

When repacking the apparatus for shipment, use the packing materials, if saved for later use. If they have not been saved, repack the apparatus using the procedure outlined below.

- (1) Wrap the apparatus in strong paper or vinyl sheeting. Protect all protrusions with cushions against damage.
- (2) Place the wrapped apparatus in a wooden or corrugated fiberboard box which is larger by about 5 to 10 cm than the apparatus on all sides.
- (3) Fill all open spaces between the apparatus and the box with polyurethane foam or any other suitable cushioning material. The apparatus may rattle and be damaged in transit if cushioning is insufficient.
- (4) Cover the box and brace it up with steel bands. If a corrugated fiberboard box is used, seal it with adhesive tape or the like.
- (5) Indicate the contents, shipping marks, and other relevant shipping information on the box in a legible and durable way.

SECTION 3 OPERATION

3.1 Introduction

This section describes the handling and operating procedures for the AQ-6310B.

3.2 Operating Controls, Indicators, and Connectors

The names of the operating controls, indicators, and connectors are indicated in Figs. 3-1 and 3-2, and their functions are described in Table 3-1.

The numbers enclosed in circles in the figures correlate to those indicated in the Remarks column of the tables.

The names presented in this section should be correctly remembered because they are used in the subsequent explanations of operating procedures.

The names enclosed within square brackets ([]) are the same as the enclosure panel markings (panel control name lettering, setting class marks, etc.).

The switches marked "Provided" in the Soft Key Option column have optional functions. For the information on the soft key functions, see section 3.3.

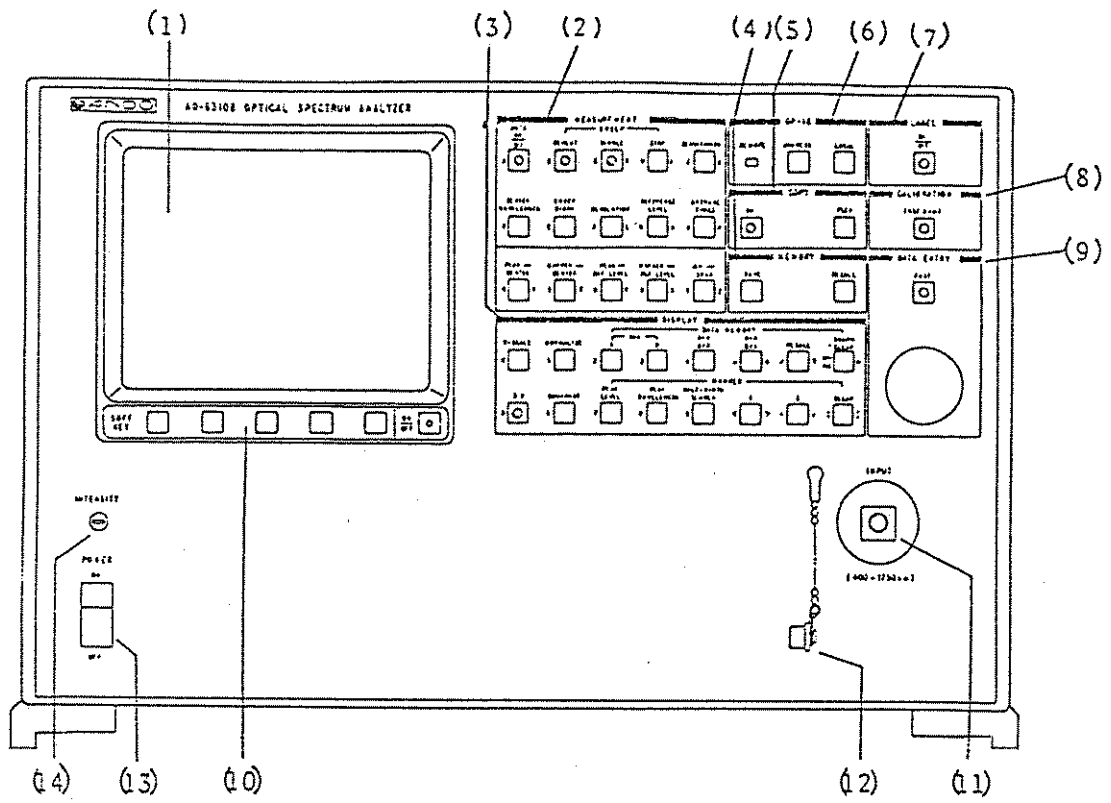

Fig. 3-1 Front Panel

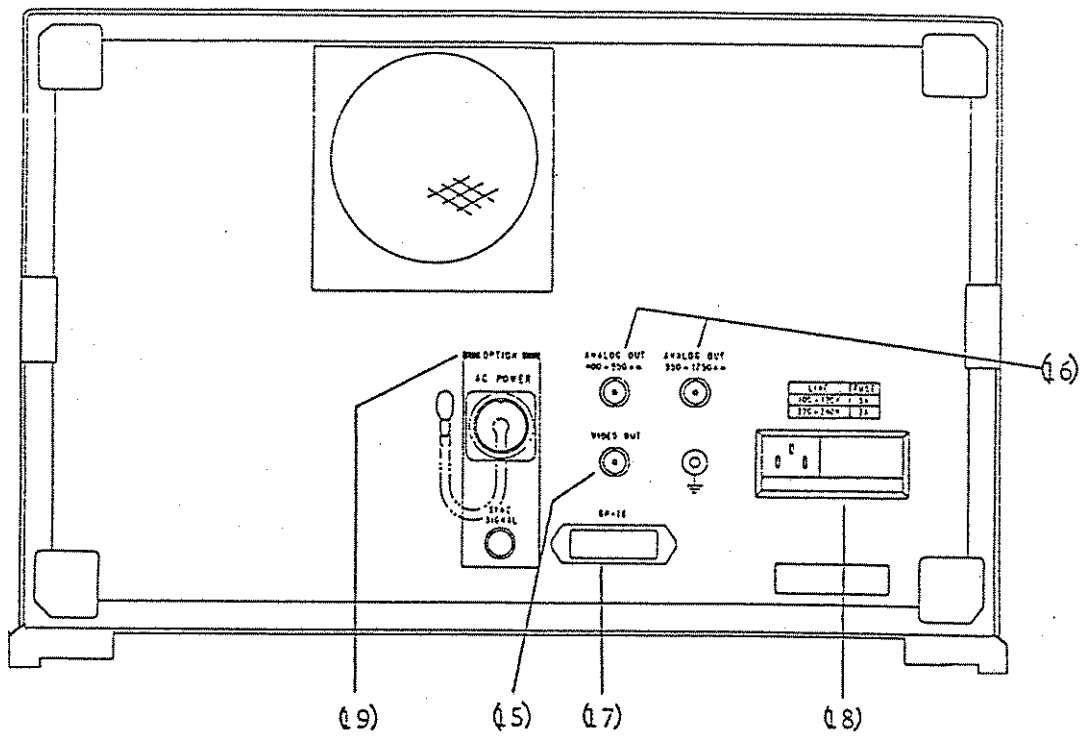

Fig. 3-2 Rear Panel

<Front Panel>

- (1) CRT Display
Shows the measurement conditions, measured waveforms and values, and others.
- (2) Measurement Switches
Used to set up the measurement method and conditions or start and stop measurements.
- (3) Display Switches
Used to change the screen Y scale, perform data subtraction, or manipulate the markers.
- (4) Memory Switches
Used to store waveforms and measurement conditions in the data memory or read such stored data.
- (5) Copying Switches
Used when, for instance, the built-in printer is to be set to produce the hard-copy printout of screen contents.
- (6) GP-IB Switches
Used to perform equipment address setup or return the apparatus to the local mode.
- (7) Label Switch
Used to enter a comment or the like onto the upper part of the CRT screen.
- (8) Calibration Switch
Used when automatic wavelength calibration is to be effected with He-Ne laser light entered.
- (9) Data Entry Rotary Knob
Used for the setup of measurement conditions and other data.
- (10) Soft Key Switches
Used when the optional functions provided for the above switches are to be exercised.
- (11) Optical Input Connector
- (12) Dustproof Cap
- (13) Power Switch
- (14) Brightness Adjustment Control

<Rear Panel>

(15) Composite Video Signal Output Terminal

(16) Analog Output Terminal

Used for measurement wavelength level external monitoring.

(17) GP-IB Connector

(18) AC Power Connector

Comprised of an AC power connector and a fuse unit.

(19) Option terminal

Used when the AQ-6002 (option) is connected to the apparatus.

Table 3-1 Switch Descriptions

Switch Marking		Function	Soft Key Option	Remarks	Ref. Page
MEASUREMENT				(2)	
AUTO	ON/OFF	Used to choose between automatic and manual function measurements. The lamp comes on when the switch is turned ON. This switch is effective during sweep stop periods only.			3-22
SWEEP	REPEAT	Repetitive sweep. The lamp lights during sweep.	Provided		3-37
	SINGLE	Single sweep. The lamp lights during sweep.	Provided		3-40
	STOP	Stops a sweep operation.	Provided		3-41
SENSITIVITY		Measurement sensitivity selector switch.			3-31
CENTER WAVELENGTH		Used for center wavelength selection.	Provided		3-27
SWEEP WIDTH		Used for sweep width selection.	Provided		3-28
RESOLUTION		Used for resolution setup.			3-33
REFERENCE LEVEL		Used for reference level setup.			3-34
AVERAGE TIMES		Used to select the number of averaging operations to be performed.			3-36
PEAK→ CENTER		Searches for the peak wavelength and sets its value as the central wavelength.			3-28
MARKER→ CENTER		Causes the wavelength value of the wavelength marker position to be set as the central wavelength.			3-28
PEAK→ REF LEVEL		Searches for the peak level and sets its value as the reference level.			3-34
MARKER→ REF LEVEL		Causes the level value of the level marker position to be set as the reference level.			3-34
△W→ SPAN		Searches for the half-width and sets its value as the measurement wavelength range.			3-29

Table 3-1 Switch Descriptions (Continued)

Switch Marking	Function	Soft Key Option	Remarks	Ref. Page
DISPLAY			(3)	
Y-SCALE	Sets up the Y-axis scale (including LOG→LIN)			3-42
NORMALIZE	Normalizes a displayed waveform. This switch is effective during sweep stop periods only.			3-44
3D	Provides a 3-D display of measured waveforms. Switching can be effected during sweep stop periods only.	Provided		3-49
DOMINANT	Subjects a displayed waveform to human visual sensitivity correction to provide a normalized waveform display. This switch is effective during sweep stop periods only.			3-47
DATA MEM- ORY	Acc A	Nonvolatile memory for storing waveforms and measurement conditions. This switch is effective during sweep stop periods only.		3-75
	Acc B	Nonvolatile memory for storing waveforms and measurement conditions. This switch is effective during sweep stop periods only.		3-75
	A-B A/B	Displays A-B (in the LOG mode) or A/B (in the LIN mode) after scaling. This switch is effective during sweep stop periods only.	Provided	3-77
	B-A B/A	Displays B-A (in the LOG mode) or B/A (in the LIN mode) after scaling. This switch is effective during sweep stop periods only.	Provided	3-77
	RECALL	Used for A and B memory recalling. This switch is effective during sweep stop periods only.		3-75
	GRAPH CLEAR	Clears a displayed waveform.		3-73
MARK- ER	PEAK LEVEL	Searches for the peak value power and places the movable level marker at the peak value power position.		3-53
	PEAK WAVE LENGTH	Searches for the peak value power and places the movable wavelength marker at the peak value power position.	Provided	3-54
	HALF-WIDTH SEARCH	Searches for the half-width points and places markers 1 and 2 at the half-width points.	Provided	3-62
	1	Sets up marker 1 at the current marker position.		3-57
	2	Sets up marker 2 at the current marker position.		3-57
	CLEAR	Clears the marker.		3-54

Table 3-1 Switch Descriptions (Continued)

Switch Marking	Function	Soft Key Option	Remarks	Ref. Page
MEMORY			(4)	
SAVE	When any one of label keys 0 through 9 or A through F is pressed after SAVE key activation, the associated waveform and measurement conditions are stored into memory. Only the measurement conditions are to be stored into nonvolatile memory. This switch is effective during sweep stop periods only.			3-72
RECALL	When any one of label keys 0 through 9 or A through F is pressed after RECALL key activation, the associated waveform and measurement conditions are recalled. This switch is effective during sweep stop periods only.			3-72
COPY			(5)	
ON	Starts screen contents printing. This switch is effective during sweep stop periods only.	Provided		3-85
FEED	While this switch is pressed, the paper is fed.			3-86
GP-IB			(6)	
ADDRESS	Performs equipment address setup.			3-93
LOCAL	Used to exit the REMOTE mode when the GP-IB is used. However, this switch is inoperative in the LLO state.			3-95
LABEL			(7)	
ON/ OFF	Used when labeling is conducted. When the LABEL switch lamp is lit, the key switch group green light indications take effect. This switch is effective during sweep stop periods only.	Provided		3-91
CALIBRATION			(8)	
(632.8 mm)	Wavelength automatic calibration function. (The option AQ-4302 is required.) This switch is effective during sweep stop periods only.	Provided		3-90
DATA ENTRY			(9)	
FAST	Places the rotary knob in the fast-forward mode.			3-20
(Rotary knob)	Used for function setup.			3-20

Table 3-1 Switch Descriptions (Continued)

Switch Marking	Function	Soft Key Option	Remarks	Ref. Page
— SOFT KEY —			(10)	
ON/ OFF	Turns on and off the soft key screen display feature. The switch lamp comes on when the switch is turned ON.			3-8
(Soft key switch)	Pressed when the associated optional switch function is to be exercised.			3-9

3.3 Soft Key Descriptions

When the switches indicated in Table 3-1 in section 3.2 are marked "Provided" in the Soft Key Option column, soft keys are displayed at the bottom of the CRT screen upon switch activation. The displayed soft key functions can be exercised by pressing the associated switches located at the lower side of the CRT body.

The soft keys are displayed only when the [SOFT KEY ON/OFF] switch is ON (with the LED illuminated). However, even if this [ON/OFF] switch is OFF, the optional functions can be performed by pressing the soft keys although they are not displayed on the CRT screen.

The following describes the soft keys displayed upon switch activation. Note that the name of the hard switches (the panel mounted pushbutton switches except the soft keys) are enclosed by square brackets ([***) while the soft key names are enclosed by angle brackets (<***>) for ease of explanation. Further, if the soft key name is marked "(Latch)", the press of such a soft key causes the display to appear in reverse field, the associated function to be executed, and the key to be stored. This ensures that when the same switch is pressed, such a stored soft key function is immediately executed. This condition will be retained until another latch function incorporated soft key is pressed. It should also be noted that latched information is nonvolatile and therefore does not change upon power turn-off.

(1) [REPEAT] Switch

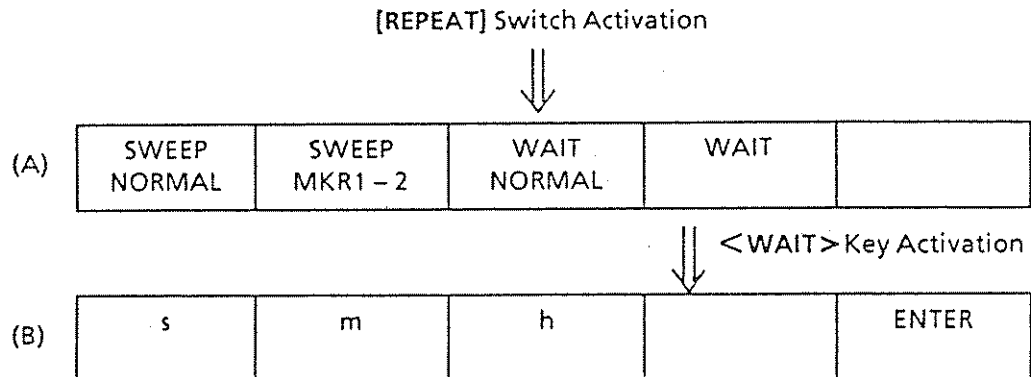

(a) <SWEEP NORMAL > (Latch)

Repeatedly makes measurement over the range from the left- to the right-end of the screen at the intervals preset by <WAIT NORMAL> or <WAIT>.

(b) <SWEEP MKR 1-2>(Latch)

Repeatedly conducts sweep between wavelength markers 1 and 2 only when such markers are set up on the screen.

However, there are some limitations on the sweep between markers 1 and 2. For the information on such limitations, see section 3.5.7-(1)-(a).

(c) <WAIT NORMAL > (Latch)

Selects the minimum WAIT time. When the key is pressed, the soft key contents return to the states indicated under (A), causing the measurement to start.

(d) <WAIT > (Latch)

This key is pressed to determine the measurement time intervals for repetitive measurement. When the key is pressed, the current setting appears in the interrupt display area and the soft key contents change as indicated under (B).

(e) <s> <m> <h>

Used to specify the unit for WAIT time selection. When the key is pressed, the setting is reset to 1. When the rotary knob is turned in this state, the

interrupt display area indication changes from 1 to 59 for "s" (second) and "m" (minute) or from 1 to 24 for "h" (hour).

(f) <ENTER>

When this key is pressed after the WAIT time values are set up with the rotary knob with the units specified as indicated in paragraph (e), the WAIT time is set up. Further, the soft key contents return to the state indicated under (A), causing measurement to start.

(2) [SINGLE] Switch

[SINGLE] Switch Activation



SWEEP NORMAL	SWEEP MKR1 - 2			
-----------------	-------------------	--	--	--

(a) <SWEEP NORMAL> (Latch)

Makes single measurement over the range from the left- to the right-end of the screen.

(b) <SWEEP MKR 1-2> (Latch)

Conducts single sweep between wavelength markers 1 and 2 only when such markers are set up on the screen.

However, there are some limitations on the sweep between markers 1 and 2. For the information on such limitations, see section 3.5.7-(1)-(a).

(3) [STOP] Switch

[STOP] Switch Activation



(A)

MANUAL SWEEP				
-----------------	--	--	--	--

(a) <MANUAL SWEEP>

This key is pressed when the rotary knob is turned to manually start measurement from the point at which sweep was stopped by [STOP] switch activation.

(4) [CENTER WAVELENGTH] Switch

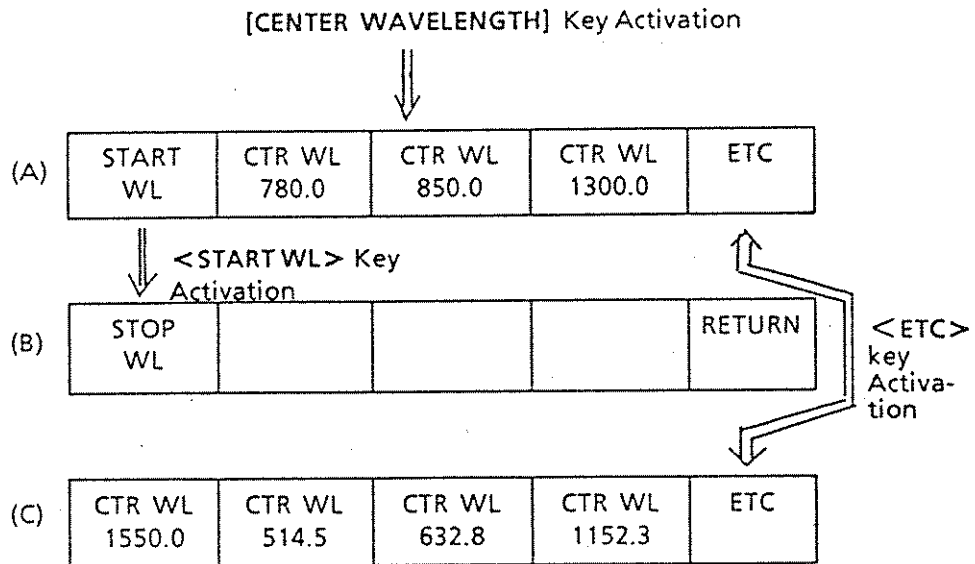

(a) <START WL>

This key is used when the measurement start wavelength is to be used as the measurement wavelength setting instead of the center wavelength. When the key is pressed, the soft key contents change so that the current measurement start wavelength appears in the interrupt display area. This displayed wavelength can be changed with the rotary knob.

(b) <STOP WL>

When this key is pressed after measurement start wavelength setup, the current stop wavelength appears in the interrupt display area. This displayed wavelength can be changed with the rotary knob. However, in contrast to start wavelength setup, the stop wavelength setting cannot be changed continuously. It can be changed stepwise in accordance with the selected sweep intervals (1, 2, or 5 nm).

(c) <RETURN>

Returns the soft key contents to the state indicated under (A).

(d) <CTR WL ****.*>

Sets the center wavelength to ****.* nm.

(e) <ETC>

Each time this key is pressed, the soft key contents alternate between (A) and (C).

(5) [SWEEP WIDTH] Switch

[SWEEP WIDTH] Switch Activation



/div	SPAN	INTVL NORMAL	MEAS WL INTVL	ETC
------	------	-----------------	------------------	-----

↕ <ETC> Key
Activation

200 – 1200 nm	1000 – 2000 nm	300 – 1800 nm	SWEEP TIME	ETC
------------------	-------------------	------------------	---------------	-----

(a) </div.> (Latch; Either (a) or (b))

Sets up the sweep width in terms of "/div".

(b) (Latch)

Sets up the sweep width by expressing its full span (measurement stop wavelength - start wavelength).

(c) <INTVL NORMAL> (Latch; Either (c) or (d))

Selects the standard data sampling interval [(measurement stop wavelength - measurement start wavelength) / 580] for measurement.

(d) <MEAS WL INTVL> (Latch)

Sets the data sampling interval to 0.1, 0.2, 0.5, 1, 2, 5, 10, or 20 nm.

However, the maximum acceptable setting is half the full span.

(e) <****- ****nm>

Sets up the center wavelength and sweep width so that the measurement wavelength range is from **** to **** nm.

(f) <SWEEP TIME>

This key is operative only when the sweep width is 0 nm with the [SENSITIVITY] switch OFF, and selects MINIMUM, 1, 2, 5, 10, 20, or 50 seconds as the time for left- to right- end screen sweep. Note, however, that this sweep time setting applies to an averaging times setting of 1.

(6) [3D] Switch

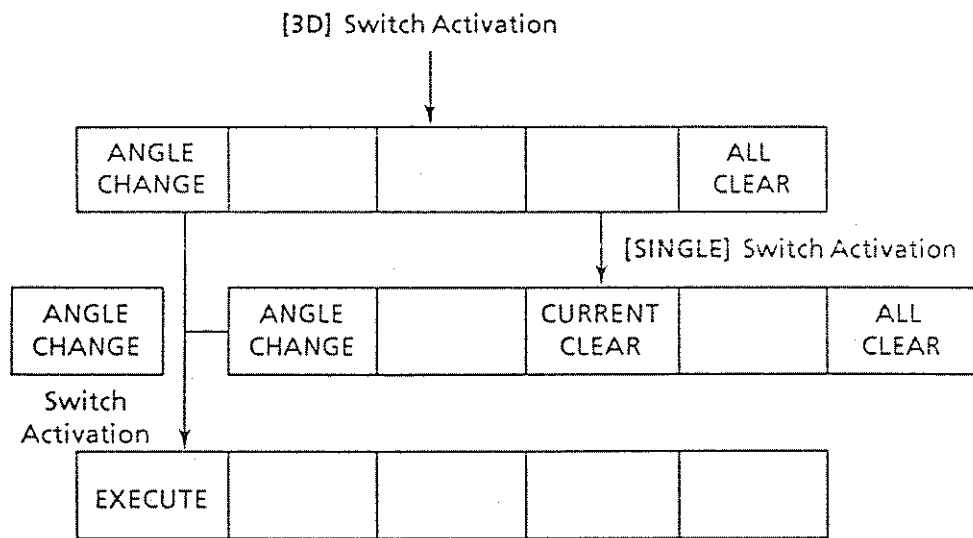

(a) <ANGLE CHANGE>

Changes the three-dimensional waveform display angle. When this key is pressed, the current angle setting appears in the interrupt display area. The rotary knob varies the angle setting in 10 degree steps from + 50 to - 50 degrees.

(b) <EXECUTE>

When this key is pressed with the angle setting changed with the rotary knob after <ANGLE CHANGE> key activation, the displayed waveform angle changes accordingly.

(c) <CURRENT CLEAR> (in the single sweep mode only)

Used to eliminate only the preceding (latest) waveform in the 3-D display mode.

(d) <ALL CLEAR>

Used to erase all waveforms in the 3-D display mode.

(7) [A-B A/B], [B-A B/A] Switch

[A-B A/B], [B-A B/A] Switch Activation



Y SCALE	Y OFFSET			
------------	-------------	--	--	--

(a) <Y SCALE>

When the [A-B A/B], [B-A B/A] switch is pressed, the memory A contents are subtracted from the memory B contents or vice versa, and the results are displayed after auto scaling. When the vertical axis is to be manually changed at this time, the <Y SCALE> key is pressed. When the current scale appears in the interrupt display area after <Y SCALE> key activation, turn the rotary knob to change the displayed scale value. This causes the vertical axis scale and displayed waveform to be updated accordingly.

(b) <Y OFFSET>

When the <Y OFFSET> key is pressed, the current OFFSET value appears in the interrupt display area. This value can be changed by turning the rotary knob. Note, however, that this function is inoperative with LIN displayed.

(8) <PEAK WAVELENGTH> Switch

[PEAK WAVELENGTH] Switch Activation



AUTO ON	AUTO OFF	CROSS ON	CROSS OFF	
------------	-------------	-------------	--------------	--

(a) <AUTO ON> (Latch; Either (a) or (b))

When this key is activated, the peak waveform is searched for to display a marker after each REPEAT sweep. This is performed without respect to [PEAK WAVELENGTH] switch activation.

(b) <AUTO ON> (Latch)

When this key is activated, the displayed peak waveform is searched for to display a marker only when the [PEAK WAVELENGTH] switch is pressed.

(c) <CROSS ON> (Latch; Either (c) or (d))

When this key is activated, the marker functions as a cross marker (the intersection of a wavelength marker and a level marker).

(d) <CROSS OFF> (Latch)

When this key is activated, only the wavelength marker function is exercised.

(9) [HALF-WIDTH SEARCH] switch

A press on [HALF-WIDTH SEARCH]



ENV	RMS × 1.00	RMS × 2.00	RMS × 2.35	THRESH
-----	---------------	---------------	---------------	--------

(a) <ENV> (Latch; any of (a), (b), (c), (d), and (e))

The half-value width is determined by the envelope method.

(b) <RMS × 1.00> (Latch)

The half-value width is determined by the RMS method.

(c) <RMS x 2.00> (Latch)

The half-value width calculated by the RMS method is multiplied by 2.00 and the value is determined as the half-value width.

(d) <RMS x 2.35> (Latch)

The half-value width calculated by the RMS method is multiplied by 2.35 and the value is determined as the half-value width.

(e) <THRESH> (Latch)

The half-value width is determined by the threshold method.

(10) [ON] Switch (COPY)

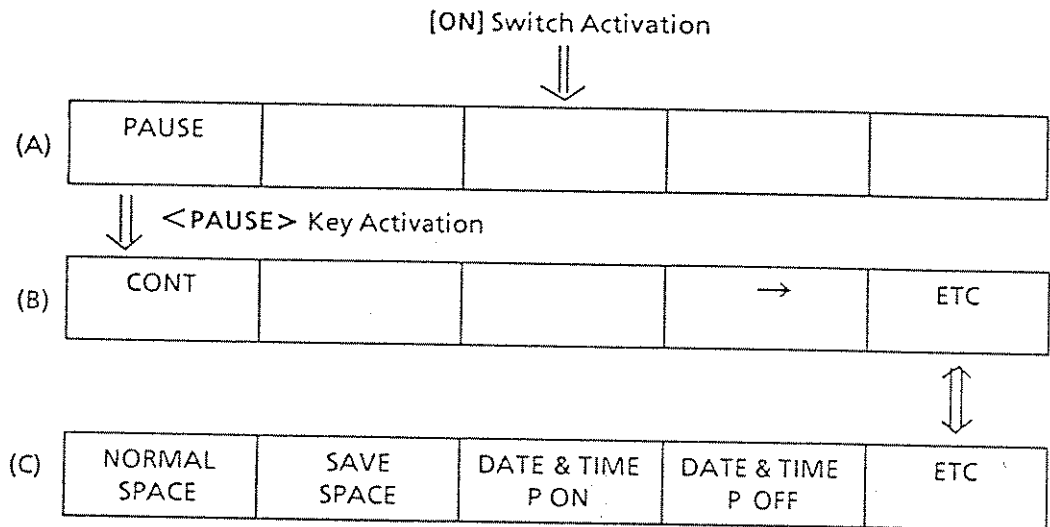

(a) <PAUSE>

When this key is pressed within 1 seconds after [ON] switch activation, date and time setting update is made possible. Upon <PAUSE> key activation, the soft key contents change as indicated under (B).

(b) <CONT>

When this key is pressed after date and time setup, printing starts.

(c) <→>

This key is used to move the cursor for date and time setup.

(d) <NORMAL SPACE> (Latch either (d) or (e))

Produces a printout with standard feed spacing.

(e) <SAVE SPACE> (Latch)

Produces a printout with narrower feed spacing.

(f) <DATE & TIME P ON> (Either One Is to Be Latched)

When the "P ON" key is pressed, the date and time are printed onto the printer.

When the "P OFF" key is pressed, the date and time are not printed onto the printer.

(11)[LABEL] Switch

[LABEL] Switch Activation

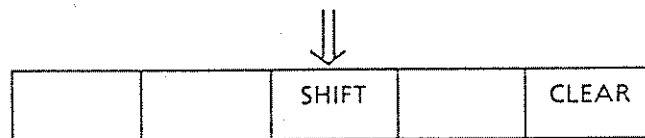

(a) <SHIFT>

When this key is pressed in message input into the screen label area, the display appears in reverse field, indicating that the right-hand side of the label character is effective. When the label character is pressed, the character located to the right of the pressed label character is entered and displayed back in normal field. This character also appears in normal field when the <SHIFT> key is pressed again.

(b) <CLEAR>

Clears the label area and places the cursor at the left end of the label area.

(12)[CALIBRATION] Switch

[CALIBRATION] Switch Activation



(a) <START>

When this key is pressed after the He-Ne laser light source (632.8 nm) is connected to the input connector, automatic waveform calibration starts.

3.4 Preoperational Preparations

Perform the following checks before connecting the AQ-6310B power cord to a commercial power source wall outlet.

- (1) Ensure that the [POWER] switch (13) is OFF.
- (2) Check whether the voltage supplied to the wall outlet agrees with the AQ-6310B operating voltage.

3.5 Operating Procedures

In the following subsections, the name of the hard switches (the panel mounted pushbutton switches except the soft keys) are enclosed by square brackets ([**]) while the soft key names are enclosed within a square (<***>). Further, the following explanations are given on the assumption that the [SOFT KEY ON/OFF] switch is ON.

3.5.1 Initialization

- (1) Turn ON the [POWER] switch.
- (2) The CRT screen then looks like Fig. 3-3 while the initial conditions are automatically set up with the automatic offset function executed. When initialization is entirely completed, the CRT screen display contents change.

The screen contents appearing first time after initialization are those which prevailed immediately before the last [POWER] switch turn-OFF. Not only the measurement conditions but also the waveform displayed at that time are reproduced on the screen.

- (3) As stated above, the AQ-6310B stores the measurement conditions, soft key latch status, displayed waveform, and other relevant data in nonvolatile memory. All these data stored in nonvolatile memory are retained even after power turn-off.

However, when all the stored conditions or soft key latch status are to be initialized, turn ON the [POWER] switch while the [AUTO ON/OFF] switch is held down. When this procedure is completed, all the stored conditions are initialized to the states prevailing just after apparatus shipment.

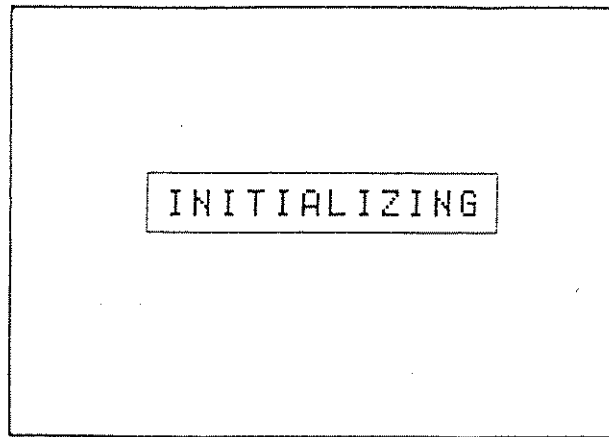
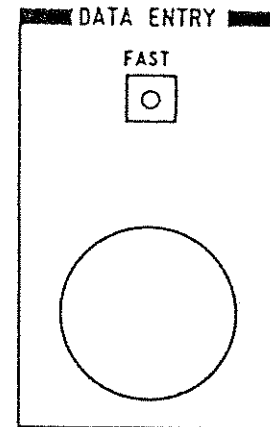

Fig. 3-3 CRT Display Screen on Initialization

3.5.2 FUNCTION and MARKER Setup Procedure

When the FUNCTION to be set up is pressed, the current setting is displayed at the upper right corner of the CRT screen. When the MARKER is pressed, the marker value is displayed at the bottom of the CRT screen. To change the displayed values, use the [DATA ENTRY] rotary knob.

When the [FAST] switch is pressed to ON (so that its LED lights), the fast forward mode prevails.



3.5.3 CRT Display Screen Contents Descriptions

(1) State Where Soft Key Menu Is Not Displayed

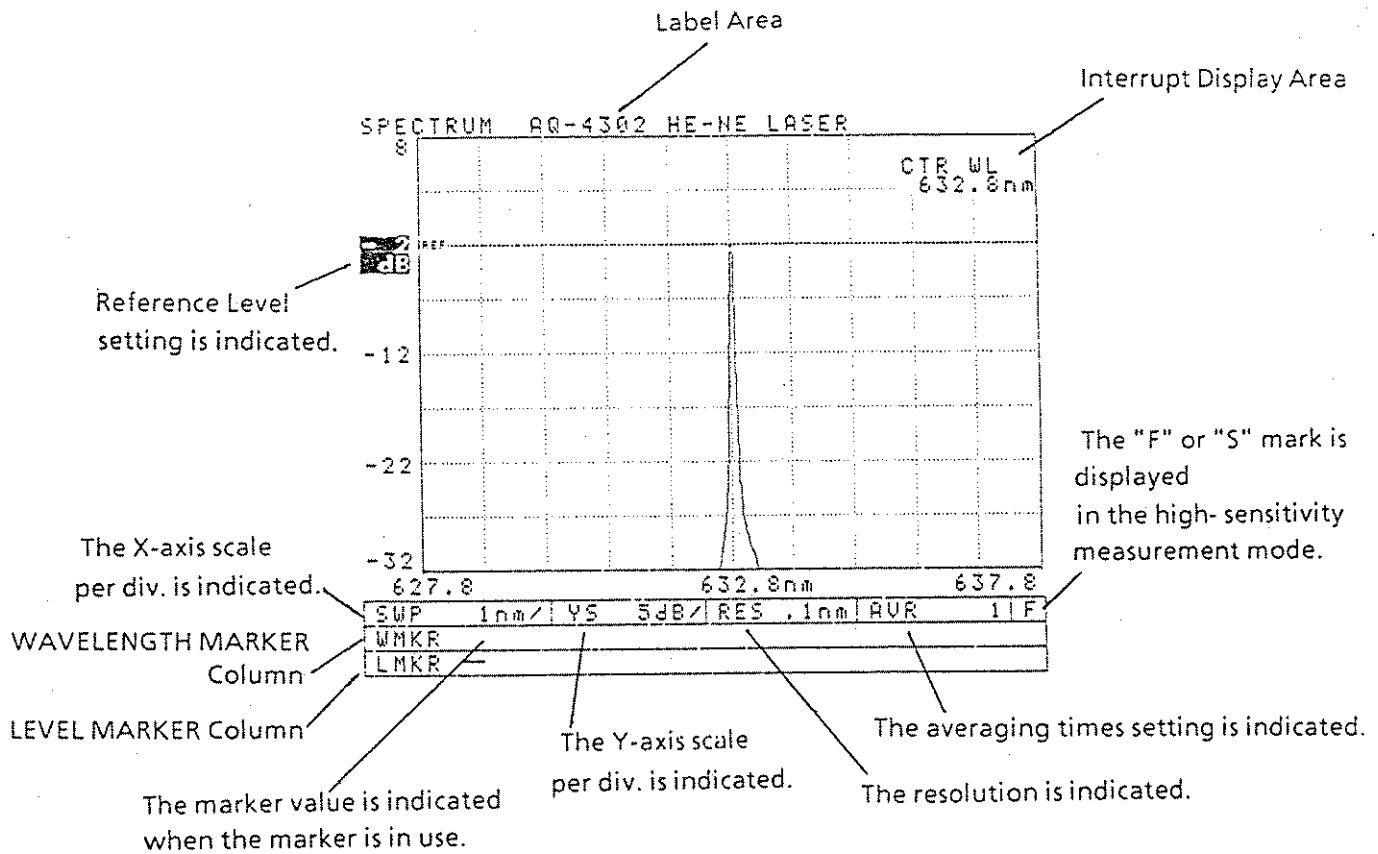
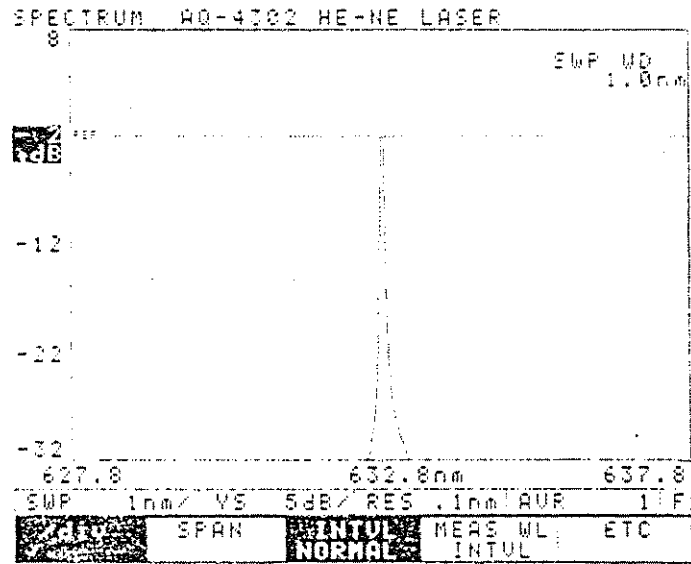

Fig. 3-4 CRT Screen Example

- (2) State Where Soft Key Menu (MARKER Excluded) Is Displayed
 The lower-end display area changes as shown below.



Soft Key Menu

Fig. 3-5 Soft Key Menu Screen (1)

- (3) State Where Soft Key Menu (MARKER) Is Displayed
 The lower-end display are changes as shown below.

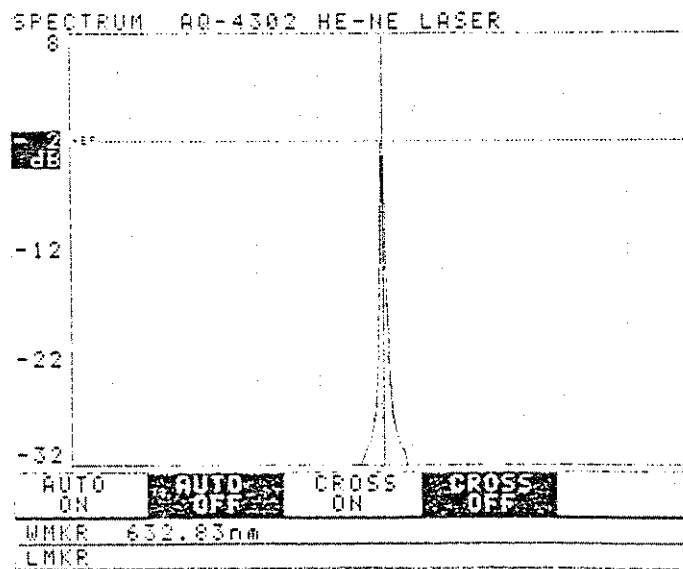

Soft Key Menu

Fig. 3-6 Soft Key Menu Screen (2)

3.5.4 AUTO Measurement

- (1) Connect to the [INPUT] connector the light source under test.
- (2) While sweep is not being effected, press the [AUTO ON/OFF] switch so that its switch lamp lights.
- (3) The appropriate center wavelength, sweep width, reference level, and resolution are automatically selected to suit the input signal spectrum. If the optimum condition is concluded, then the mode is changed from [AUTO] to [REPEAT] and the sweep is repeatedly conducted.
- (4) When the peak level is below -40 dBm or less in the [AUTO] mode, the conditions are not optimized and the [AUTO] sweep is terminated.

NOTE 1: The [AUTO] measurement wavelength range is 600 to 1750 nm.

NOTE 2: The following latch information is initialized by setting [AUTO] to ON.

- SWEEP MARKER 1-2 → SWEEP NORMAL
- WAIT → WAIT NORMAL
- SENSITIVITY → H-SENS OFF
- MEAS WL INTVL → INTVL NORMAL
- AVERAGE TIMES → 1
- SPAN → /div

The [AUTO] measurement examples are presented below.

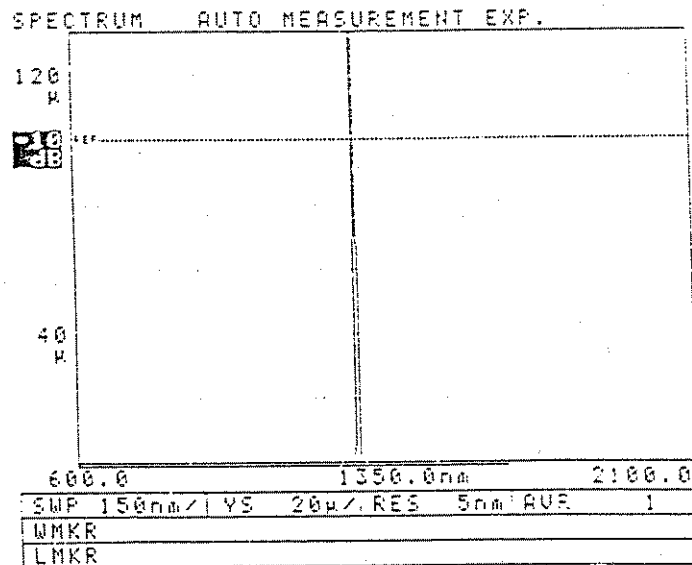

First Sweep

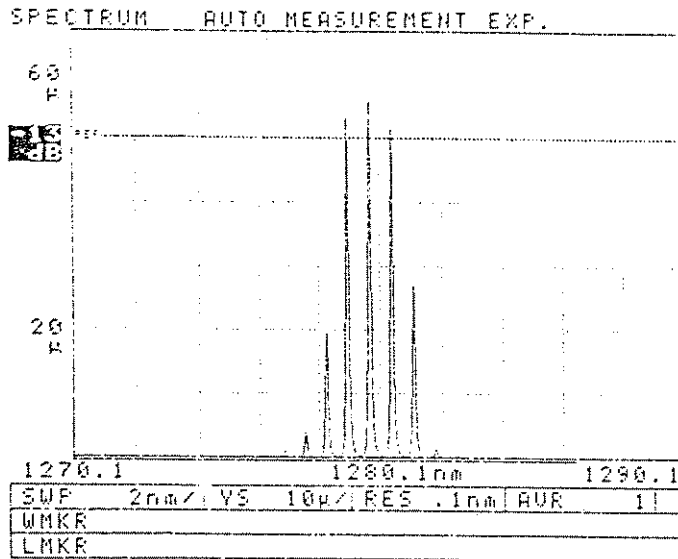

Second Sweep

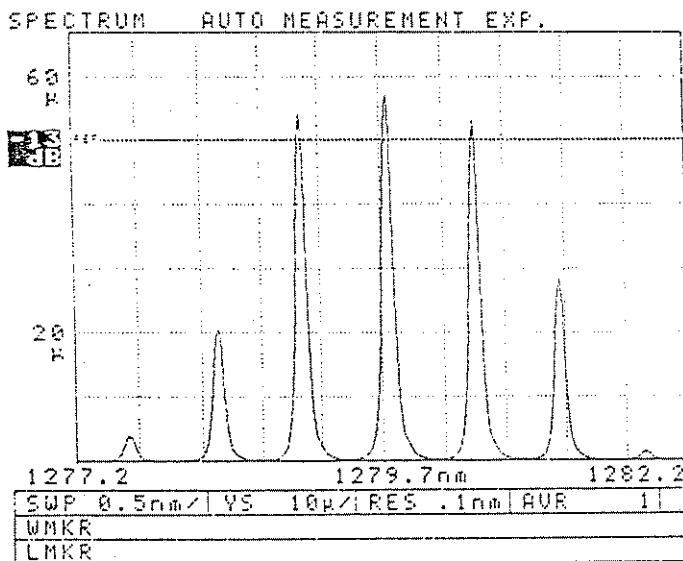

Sweep after Convergence

Fig. 3-7 [AUTO] Measurement Example

NOTE

In an [AUTO] mode measurement, the optimum convergence condition may not be achieved because of possible input signal (wavelength, level) variations, and the sweep in the [AUTO] mode may be terminated. If such is the case, turn off the [AUTO] function and make manual measurement. In an [AUTO] measurement, the number of sweep operations is not more than 10.

3.5.5 Manual Measurement

Typical LD light source (wavelength: approx. 1300 nm; level: approx. -10 dBm) and LED light source (wavelength: approx. 850 nm; level: approx. -30 dBm) measurement procedures are described below.

(1) LD Light Source Measurement

- (a) Connect the light source under test, to the optical input connector with optical fiber.
- (b) Turn OFF the [AUTO ON /OFF] switch (its lamp goes off).
- (c) Press the [Y-SCALE] switch and turn the rotary knob to set the Y-axis scale to 5 dB/div.
- (d) Press the [CENTER WAVELENGTH] switch and turn the rotary knob to set the center wavelength to 1300.0 nm.
- (e) Press the [RESOLUTION] switch and turn the rotary knob to set the resolution to 10 nm.
- (f) Press the [REFERENCE LEVEL] switch and turn the rotary knob to select a reference level of -10 dB.
- (g) Press the [SWEEP WIDTH] and turn the rotary knob to select a sweep width of 10 nm/div.
- (h) Press the [AVERAGE TIMES] switch and turn the rotary knob to set the averaging times to 1.
- (i) Press the [REPEAT] switch to start repetitive sweep.
- (j) While observing the measurement results (displayed waveform), adjust the measurement conditions set up in steps (d) through (h).
- (k) Press the [STOP] switch as needed to stop sweep operation, press the [LABEL] switch to carry out labeling, and press the [COPY ON] switch to produce a hard-copy printout.

(2) LED Light Source Measurement

(a)-(c) Perform the same steps as indicated in paragraph (1).

(d) Press the [CENTER WAVELENGTH] switch and turn the rotary knob to set the center wavelength to 850.0 nm.

(e) Perform the same step as indicated in paragraph (1).

(f) Press the [CENTER WAVELENGTH] switch and turn the rotary knob to set the reference level to -30 dB.

(g) Press the [SWEEP WIDTH] switch and turn the rotary knob to select a sweep width of 50 nm/div.

(h)-(k) Perform the same steps as indicated in paragraph (1).

Typical LD and LED light source measurement examples are presented in Figs. 3-8 through 3-11.

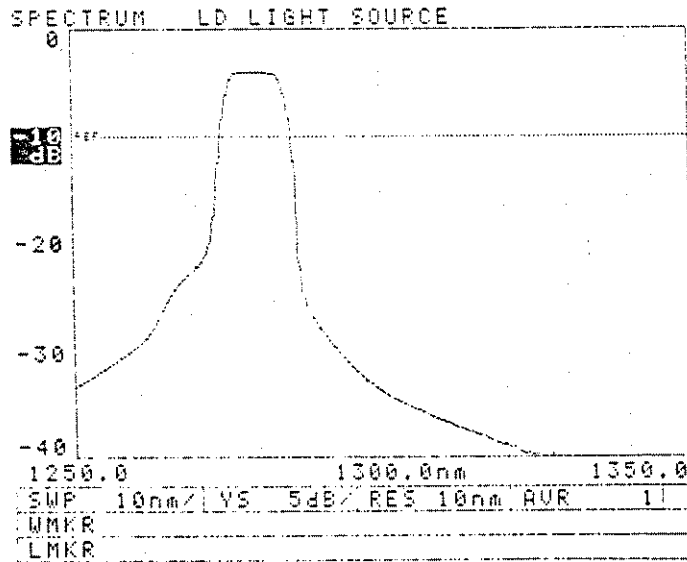

Fig. 3-8 LD Light Source First Sweep Waveform

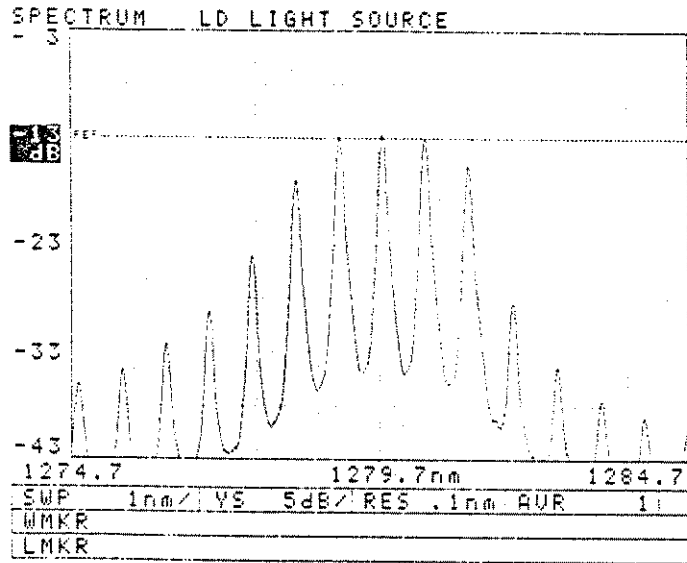

Fig. 3-9 LD Light Source Last Sweep Waveform

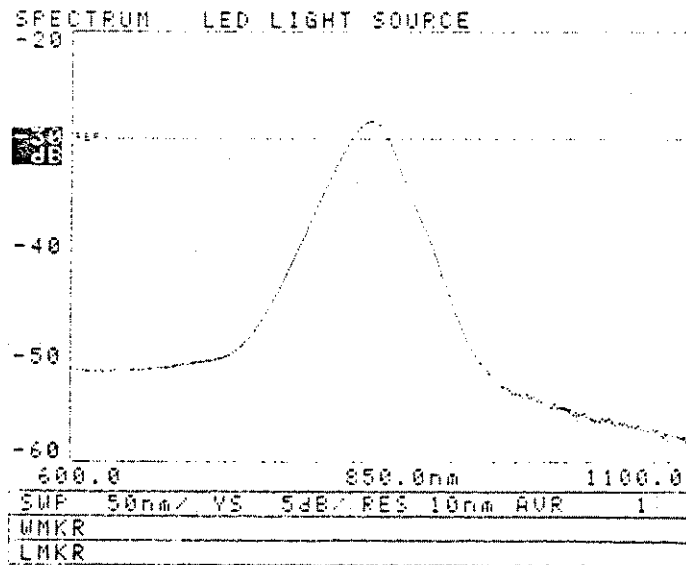

Fig. 3-10 LED Light Source First Sweep Waveform

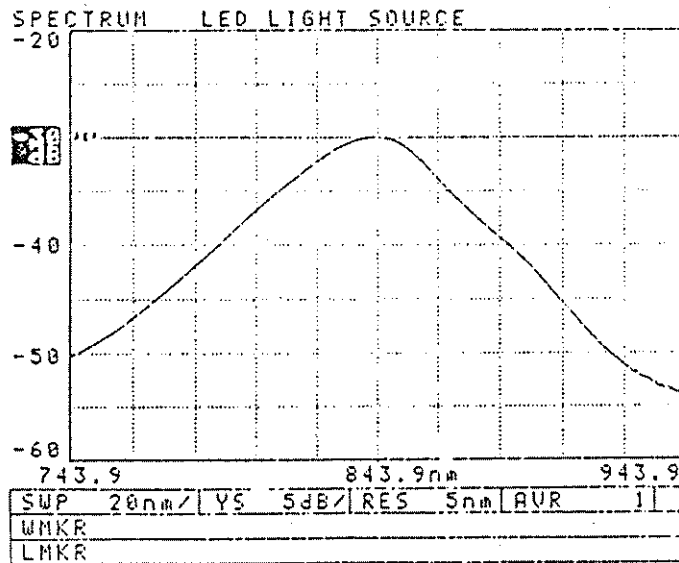

Fig. 3-11 LED Light Source Last Sweep Waveform

3.5.6 Measurement Condition Setup

(1) Center Wavelength

Center wavelength setup is performed by either the [CENTER WAVELENGTH] switch or [PEAK → CENTER/MARKER → CENTER] switch.

A) Center Wavelength Setup with [CENTER WAVELENGTH] Switch

- (a) Press the [CENTER WAVELENGTH] switch. The current center wavelength setting appears in the interrupt display area and the soft key menu appears on the CRT. While noting the CRT display, turn the rotary knob as required to select a desired value. (Refer to Fig. 3-12.)
- (b) When the desired value is equal to the value of soft key <CTR WL ****.*>, press that soft key. If the desired value is close to ****.*, press the soft key and then turn the rotary knob until the desired setting is obtained.
- (c) When performing setup on the basis of the measurement start and measurement stop wavelengths, press soft keys <START WL> and <STOP WL> and then turn the rotary knob as needed.

B) Center Wavelength Setup with [PEAK → CENTER/ MARKER→ CENTER] Switch

- (a) When the displayed waveform peak wavelength is to be employed as the center wavelength setting, press the [PEAK→CENTER] switch.
- (b) When the value indicated by the displayed wavelength marker is to be employed as the center wavelength setting, press the [MARKER→CENTER] switch.

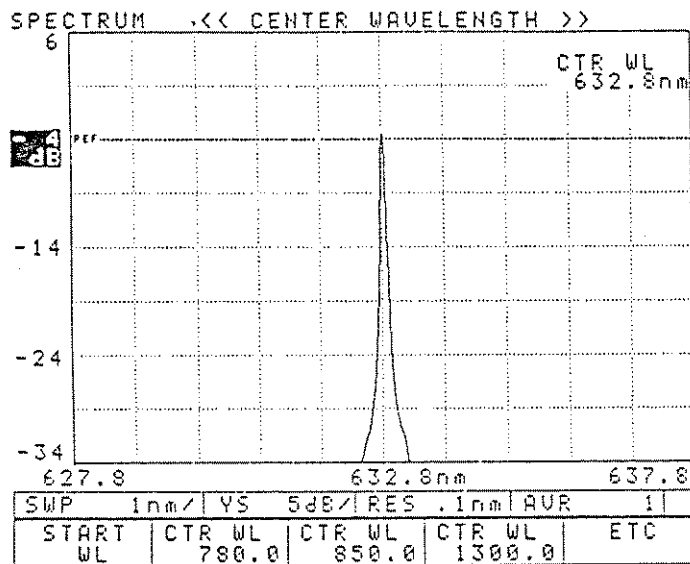

Fig. 3-12 State Prevailing after [CENTER WAVELENGTH] Switch Activation

(2) Sweep Width

Press the [SWEEP WIDTH] switch. The soft key menu then appears on the CRT. Further, the current sweep width setting appears in the interrupt display area. Perform any one of the following procedures to select a setting of 0.0, 0.1, 0.2, 0.5, 1, 2, 5, 10, 20, 50, 100, or 150 nm/div. (Refer to Fig. 3-13.)

- (a) When performing setup on the per-div. basis, press soft key For setup on the full-span basis, press soft key </div>. After such soft key activation, turn the rotary knob as needed to obtain a desired setting.

- (b) Press soft key <ETC> so that soft key <****-****nm> appears. When the sweep range indicated by the displayed soft key is to be employed, press that soft key. The sweep width and center wavelength are then set up to suit the displayed sweep range.
- (c) Press the [Δ W \rightarrow SPAN] to set a value twice the half-width as full-span (see Fig. 3-14).
The half-width is determined by the currently defined method. For more details see subsection 3.5 12 under "Half-Width Measurement."
- (d) When the sweep width is 0.0 nm with the [SENSITIVITY] switch OFF, press soft key <SWEEP TIME>. The time for left- to right-end screen sweep can then be set by rotary knob rotation to a value between 1 and 50 seconds. The selectable sweep time settings are MINIMUM, 1, 2, 5, 10, 20, and 50 seconds. Note, however, that this sweep time setting applies to an averaging times setting of 1. The sweep time is indicated in the interrupt display area during REPEAT sweep (see Fig. 3-15).
(In the case the sweep time is approx.)
- (e) Press soft key <MEAS WL INTVL> and then turn the rotary knob to set the sweep state data sampling interval to a value between 0.1 and 20 nm. The selectable settings are 0.1, 0.2, 0.5, 1, 2, 5, 10, and 20 nm. Note, however, that the setting must be smaller than half the full span (measurement stop wavelength - measurement start wavelength) and greater than (full span / 580) nm. This function is effective in monitoring quickly the outline of the waveform when the sweep rate is low as in the <H-SENS SLOW> mode. The standard data sampling interval is (full span / 580) nm, and this setting is selected when soft key <INTVL NORMAL> is pressed.

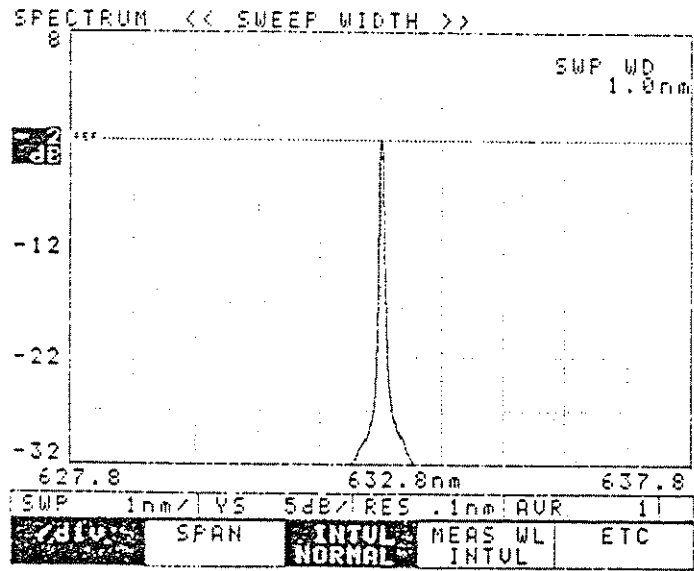

Fig. 3-13 State Prevailing after [SWEEP WIDTH] Switch Activation

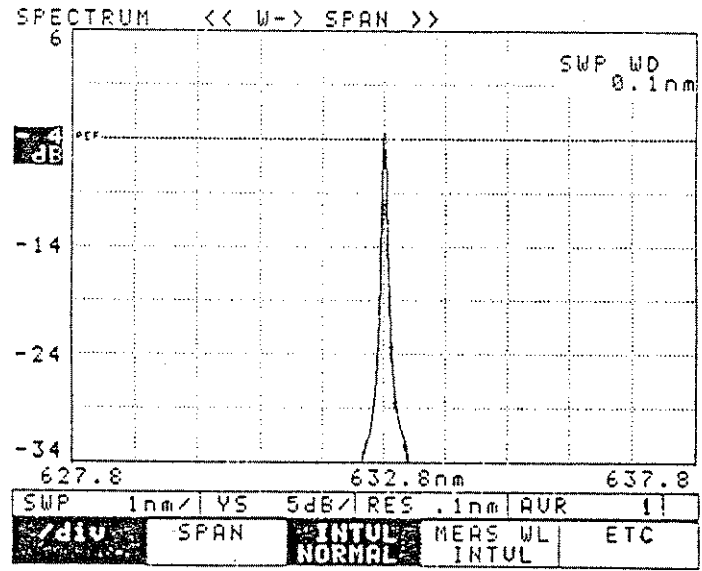

Fig. 3-14 State Prevailing after [$\Delta W \rightarrow$ SPAN] Switch Activation

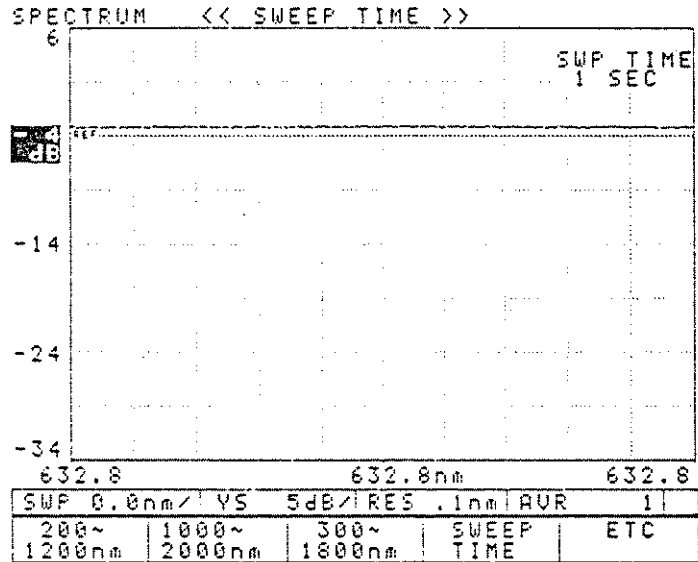

Fig. 3-15 State Prevailing after [SWEEP TIME] Switch Activation

(3) High-Sensitivity Measurement Mode Selection

When high-sensitivity measurement is to be made, press the [SENSITIVITY] switch. This causes the sensitivity setting currently latched to appear in the interrupt display area. The sensitivity settings are selectable for <H-SENS FAST>, <H-SENS SLOW>, and <H-SENS OFF> with the rotary knob (see Fig. 3-16).

(a) <H-SENS FAST>

Used for high-sensitivity measurement with reference levels settable up to -60 dB. This mode is suitable for high-level (higher than -60 dB) light source measurement. The measurement speed is slower than that in the <H-SENS OFF> mode.

(b) <H-SENS SLOW>

Used for extremely high-sensitivity measurement with reference levels settable up to -70 dB. Since signal amplification is restricted to narrow bandwidths, extremely low level (lower than -60 dBm) light sources can be measured with a satisfactory S/N ratio. Measurement of lower

than -60 dBm light sources will make the measurement speed slower considerably.

(c) <H-SENS OFF>

Used to turn off the high-sensitivity measurement for normal sensitivity measurement with reference levels settable up to -49 dB. The measurement speed is fastest in this mode.

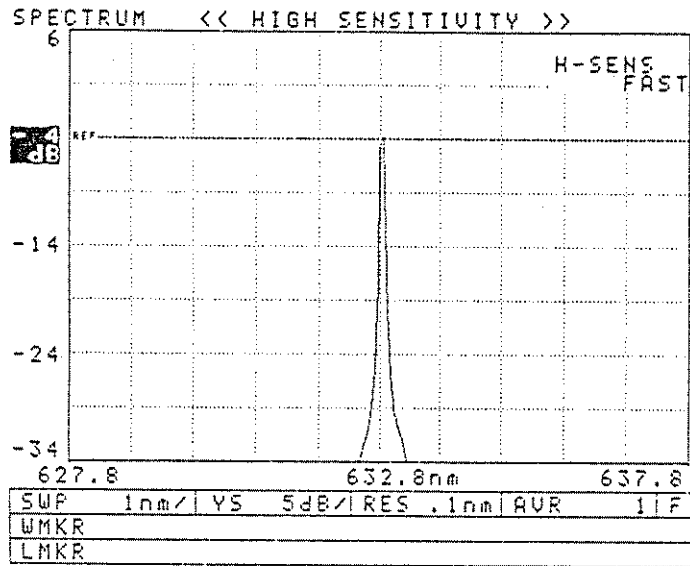

Fig. 3-16 State Prevailing after [SENSITIVITY] Switch Activation

(4) Resolution

Press the [RESOLUTION] switch. The current resolution setting then appears in the interrupt display area. Turn the rotary knob as required to set the resolution to 0.1, 0.2, 0.5, 1, 2, 5, or 10 nm. (However, if the measurement wavelength range includes a wavelength 539.9 nm or shorter, the selectable resolution setting is between 0.1 and 5 nm.) (Refer to Fig. 3-17.)

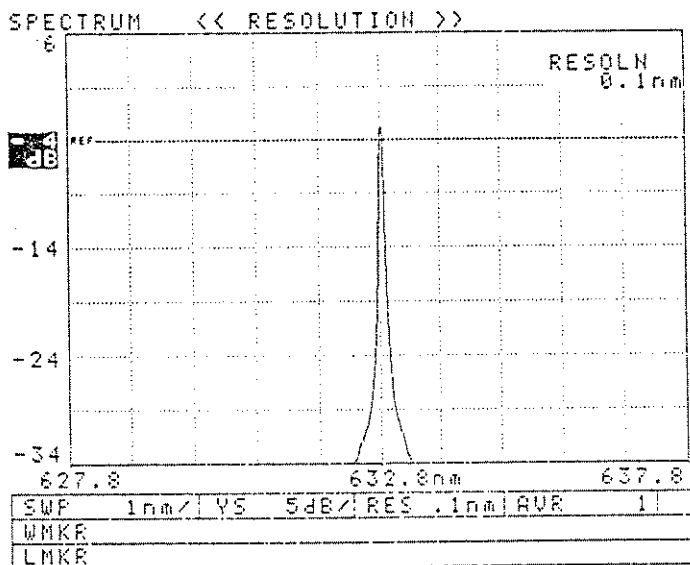

Fig. 3-17 State Prevailing after [RESOLUTION] Switch Activation

(5) Reference Level

Reference level setup is performed by either the [REFERENCE LEVEL] switch or [PEAK →REF LEVEL/ MARKER → REF LEVEL] switch.

A) Reference Level Setup with [REFERENCE LEVEL] Switch

(a) Press the [REFERENCE LEVEL] switch. The current reference level setting then appears in the interrupt display area. Turn the rotary knob to change the setting as desired. (Refer to Fig. 3-18.)

B) Reference Level Setup with [PEAK →REF LEVEL/ MARKER → REF LEVEL] Switch

(a) When the displayed waveform peak level is to be employed as the reference level, press the [PEAK →REF LEVEL] switch.

(b) When the value indicated by the level marker set up on the screen is to be used as the reference level, press the [MARKER →REF LEVEL] switch.

In either of the above cases, the acceptable reference level settings are as follows.

	HIGH-SENSITIVITY		
	OFF	ON	
		H-SENS FAST	H-SENS SLOW
REFERENCE LEVEL (dB)	0 to -49	0 to -60	0 to -70

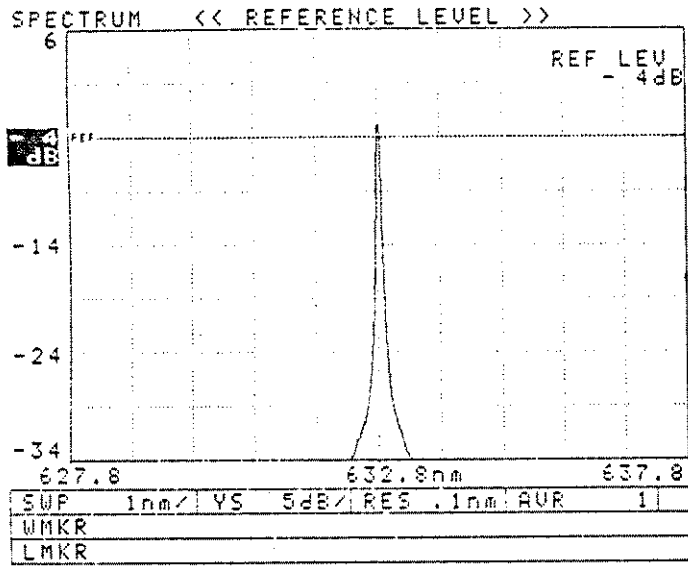

Fig. 3-18 State Prevailing after [REFERENCE LEVEL] Switch Activation

(6) Averaging Times

Press the [AVERAGE TIME] switch. The current averaging times setting then appears in the interrupt display area. Vary the displayed setting as desired with the rotary knob. The selectable averaging times settings are 1, 5, 10, 20, 50, 100, 200, 500, and 1000 for the cases where the [SENSITIVITY] is in H-SENS OFF mode, or 1, 2, 5, 10, 20, 50, and 100 for the cases where the [SENSITIVITY] switch is in H-SENS FAST or H-SENS SLOW mode. (Refer to Fig. 3-19.)

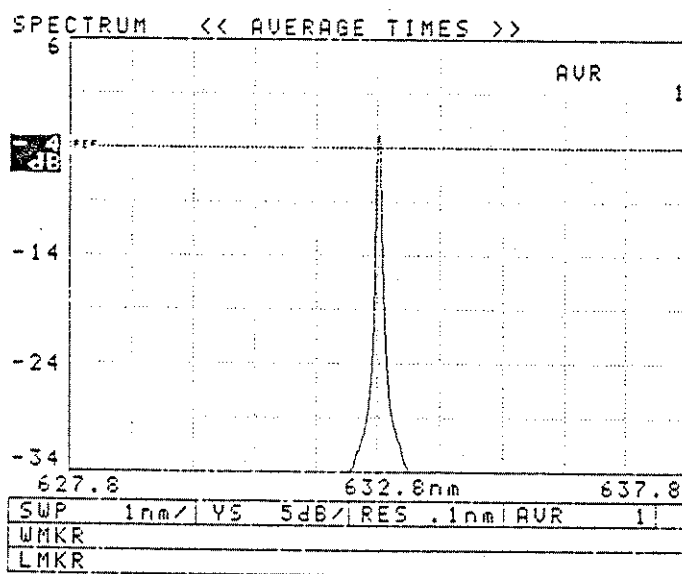

Fig. 3-19 State Prevailing after [AVERAGE TIMES] Switch Activation

3.5.7 Sweep Mode Setup

(1) REPEAT Sweep

To conduct repetitive sweep, press the [REPEAT] switch. This causes the switch lamp to come on and the soft key menu to appear on the CRT. Further, either soft key <SWEEP NORMAL> or <SWEEP MKR1-2> is latched and displayed in reverse field (white on black). Sweep is then conducted over the wavelength range indicated by the latched soft key (sweep takes place between the left and right ends of the screen when <SWEEP NORMAL> is latched or between markers 1 and 2 when <SWEEP MKR1-2> is latched). (Refer to Fig. 3-20.)

(a) Sweep between Markers 1 and 2

As long as wavelength markers 1 and 2 are set up on the screen, <SWEEP MKR1-2> key activation causes the system to sweep between markers 1 and 2. While sweep is being conducted between markers 1 and 2, the waveforms prevailing before marker 1-to-marker 2 sweep are displayed for the portions outside the sweep area.

While soft key <SWEEP MKR1-2> is latched, all switches except the following are inoperative. If an attempt is made to press such inoperative switches, the interrupt display area reads "ATTN 5".

[REPEAT] , [SINGLE] , [STOP] , [SENSITIVITY] , [RESOLUTION] , [AVERAGE TIMES] , [COPY ON] , [COPY FEED] , [GRAPH CLEAR] , [ADDRESS] , [LOCAL] , [FAST] , [LABEL ON/OFF] [REFERENCE LEVEL] .

The [LABEL ON/OFF] , [REFERENCE LEVEL] , and [COPY ON] switches are ineffective during sweep.

When soft key <AUTO ON> is latched by the [PEAK WAVELENGTH] switch, the auto peak search function is not executed during sweep between markers 1 and 2. However, this does not change the <AUTO ON> latch status; therefore, the auto peak search operation is resumed when sweep is effected after the latched soft key has been changed from <SWEEP MKR1-2> to <SWEEP NORMAL> .

The above-mentioned limitations on marker 1-to- marker 2 sweep also apply to the SINGLE sweep modes.

(b) WAIT Time Setup

The inter-sweep pause time (WAIT time) can be set up with soft key <WAIT>.

When the <WAIT> key is pressed, the soft key menu changes and the interrupt display area shows the current WAIT time. When no units of time are to be changed, just turn the rotary knob to obtain a desired value. When a certain unit is to be changed, press soft key <s> , <m>, or <h> and then turn the rotary knob to obtain a desired value.

The values selectable range from 1 to 59 for s (second) and m (minute) or from 1 to 24 for h (hour).

Only one unit may be set. A setting such as 00 h 00 m is not accepted.

When soft key <ENTER> is pressed after the WAIT time has been selected with the rotary knob, WAIT time setup takes place and measurement starts immediately.

To minimize the WAIT time setting, press soft key <WAIT NORMAL>.

The latch information for other soft keys remains unchanged even if power is turned off. For only WAIT time, however, the system is locked into <WAIT NORMAL> when power is turned off.

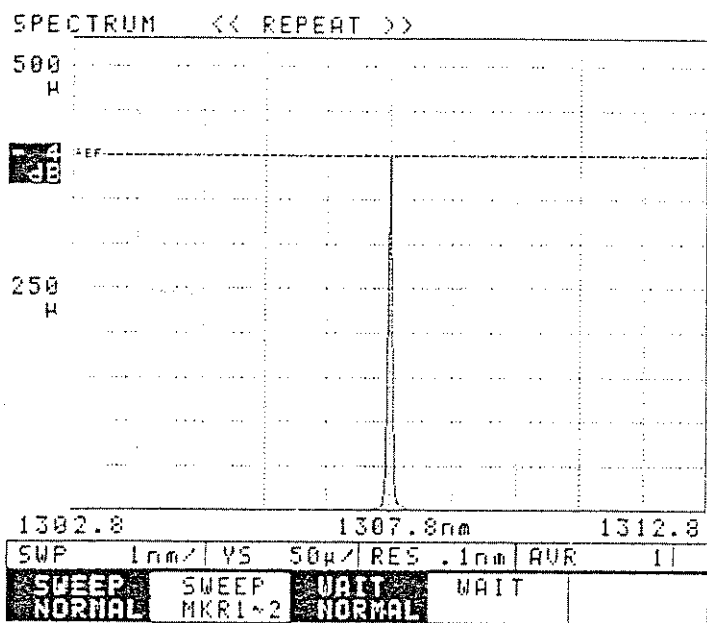

Fig. 3-20 State Prevailing upon [REPEAT] Switch Activation

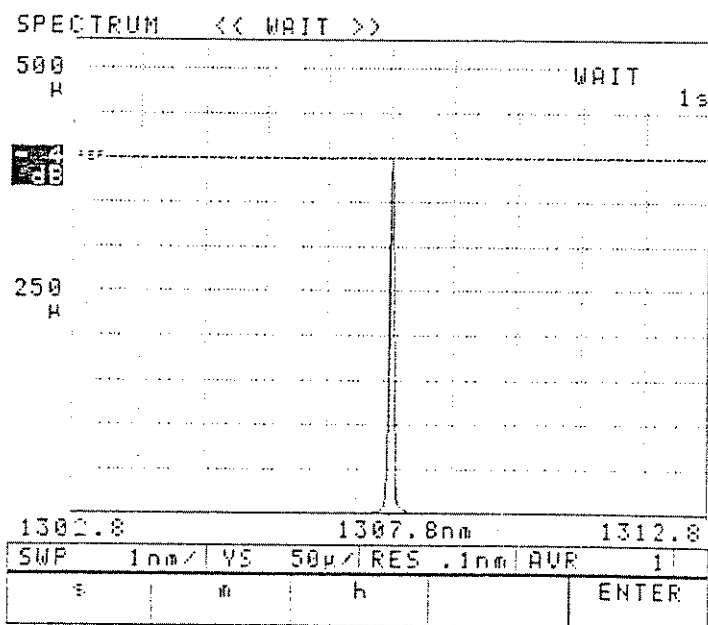

Fig. 3-21 State Prevailing upon <WAIT> Key Activation

(2) SINGLE Sweep

To conduct single sweep, press the [SINGLE] switch. This causes the switch lamp to come on and the soft key menu to appear on the CRT. Further, either soft key <SWEEP NORMAL> or <SWEEP MKR1-2> is latched and displayed in reverse field. Sweep is then conducted over the wavelength range indicated by the latched soft key. Sweep is then conducted over the wavelength range indicated by the latched soft key. The [SINGLE] switch lamp goes off upon completion of sweep. (Refer to Fig. 3-22.)

NOTE: There are some limitations on the sweep between markers 1 and 2. Therefore, reference should be made to paragraph (1)-(a).

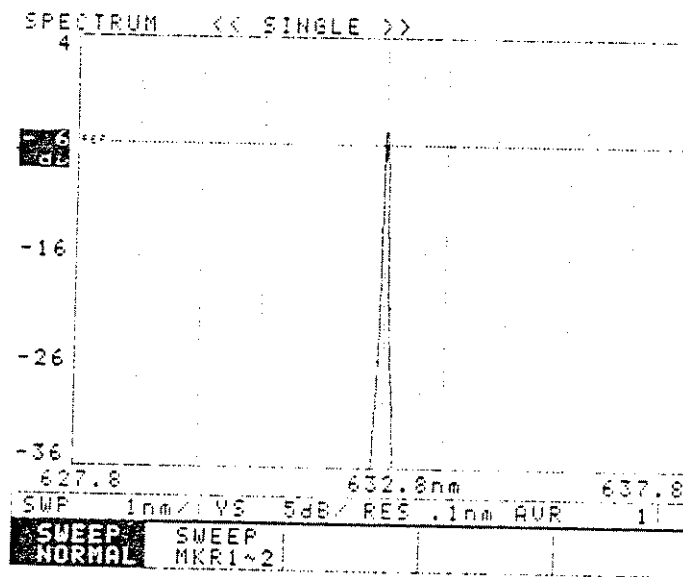

Fig. 3-22 State Prevailing upon [SINGLE] Switch Activation

(3) MANUAL Sweep

The term "MANUAL sweep" refers to the manual sweep operation that is performed only enough to cover the range indicated by rotary knob rotation. This function is provided as a soft key option for the [STOP] switch.

When the [STOP] switch is pressed while sweep is conducted or stopped, soft key <MANUAL SWEEP> appears on the CRT. To effect MANUAL sweep, press that soft key. (Refer to Fig. 3-23.)

When the rotary knob is turned after soft key activation, sweep starts. If the [STOP] switch is pressed during sweep and then the system is placed in the MANUAL sweep mode, sweep starts from the point at which the last sweep was terminated by [STOP] switch activation.

No MANUAL sweep can be performed when soft key <MEAS WL INTVL> or the marker-to-marker sweep mode is set.

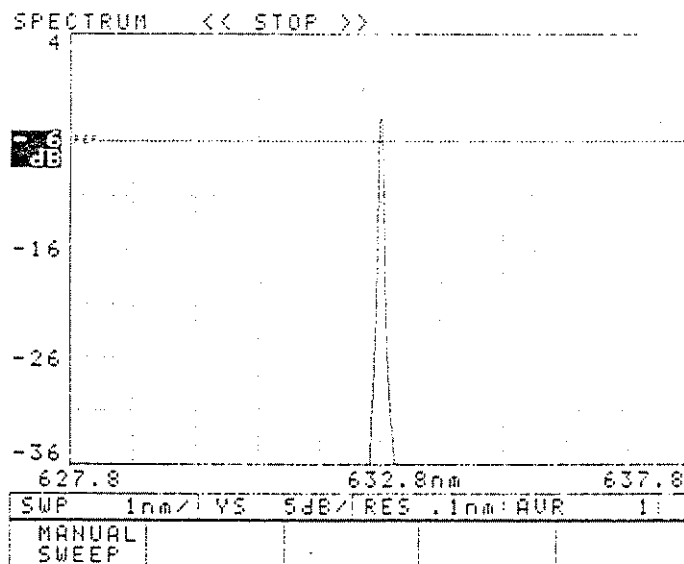

Fig. 3-23 State Prevailing upon [STOP] Switch Activation

3.5.8 Display Method Setup

(1) Y-SCALE

When the [Y-SCALE] switch is pressed, the Y-axis scale can be varied with the rotary knob.

The current Y-axis scale appears in the interrupt display area, and the Y-axis scale can be varied with the rotary knob as shown below.

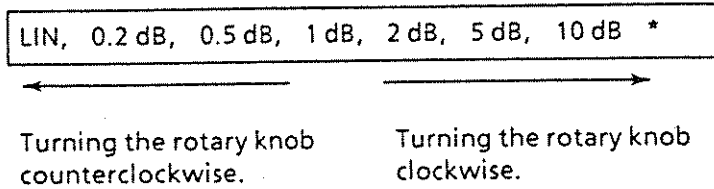

Turning the rotary knob caused the displayed waveform to be updated according to the scale setting. In the LIN mode, the Y-axis scale causes the waveform to be updated from the LOG indication to LIN (see Figs. 3-24 and 25).

* In the SENSITIVITY-OFF mode, the Y-axis scale 10 dB/div. indication cannot be effected.

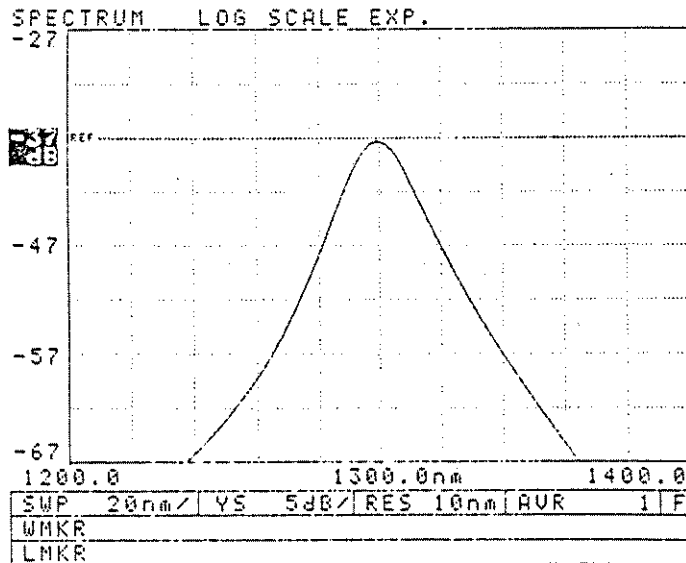

Fig. 3-24 LOG Scale Screen

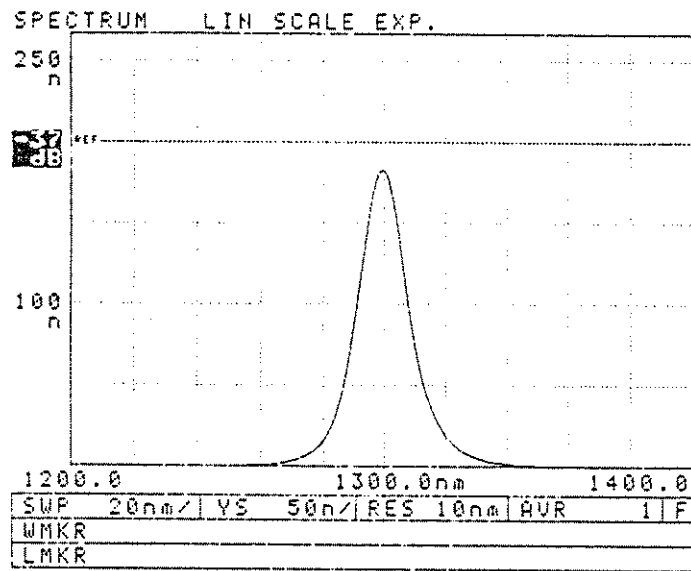

Fig. 3-25 LIN Scale Screen

(2) NORMALIZE

When the [NORMALIZE] switch is pressed, the indication "NORM" appears at the upper right corner of the screen. Further, normalization is effected with reference to the displayed waveform peak level value, and then the waveform is changed with the peak value considered to be 0 dB in the LOG scale mode or 1 in the LIN scale mode. (Refer to Figs. 3-26 and 3-27.)

However, if the waveform peak level value is extremely small, the associated ATTN number is displayed and waveform updating does not take place.

The NORMALIZE function can be exercised only while sweep is stopped with the [3D] switch OFF (see subsection (4)).

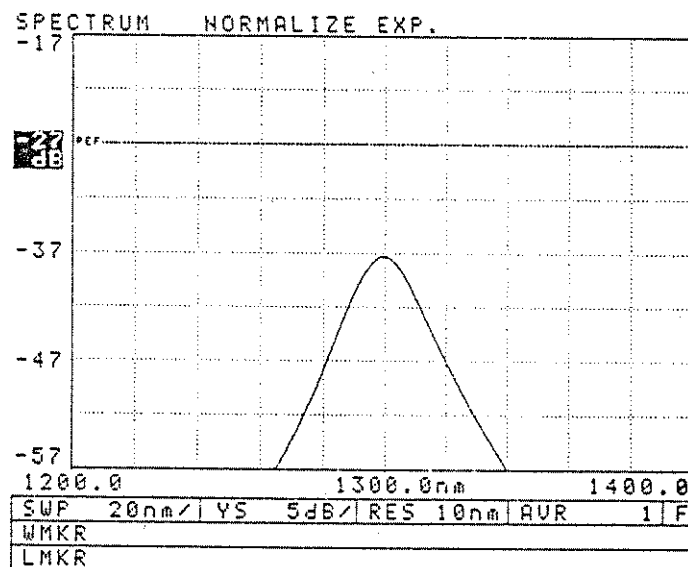

Before Execution

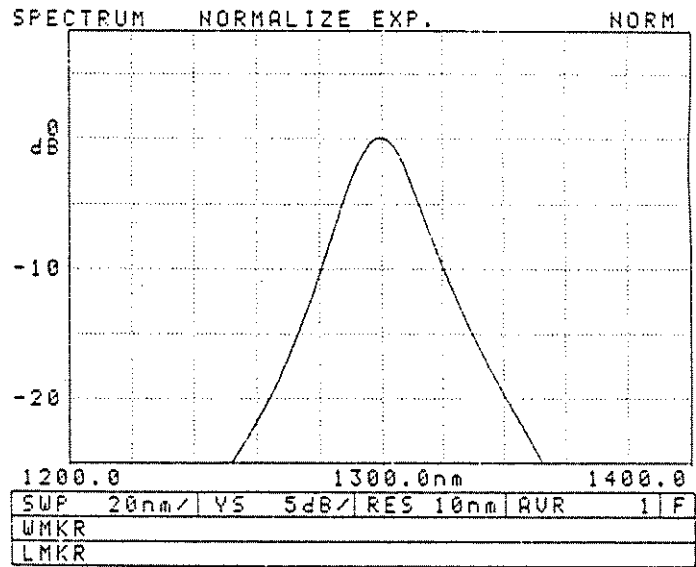

After Execution

Fig. 3-26 NORMALIZE Function Execution Examples (LOG Scale Mode)

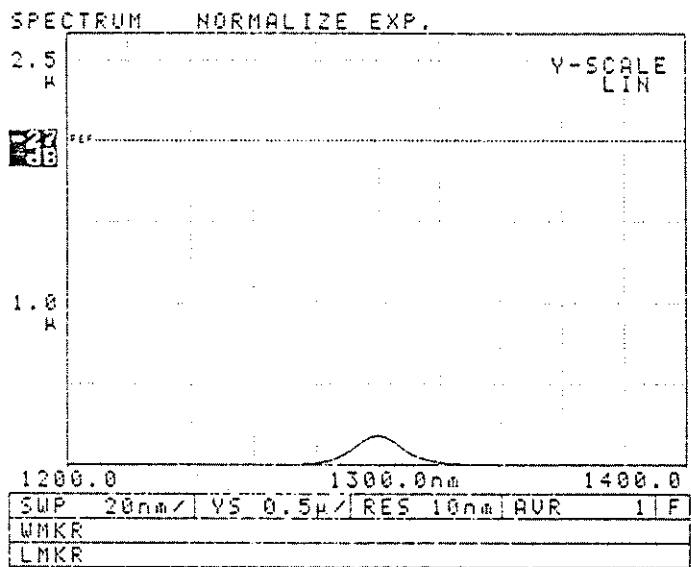

Before Execution

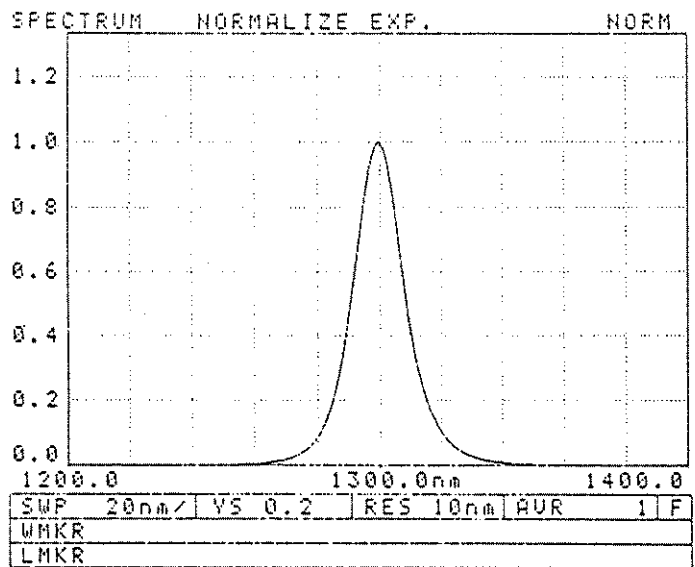

After Execution

Fig. 3-27 NORMALIZE Function Execution Examples (LIN Scale Mode)

(3) DOMINANT

When the [DOMINANT] switch is pressed, the indication "DOM" appears at the upper right corner of the screen. Further, the displayed waveform is subjected to human visual sensitivity correction and normalized. (Refer to Fig. 3-28.)

However, if the waveform wavelength range is not within the scope of human visual sensitivity, the associated ATTN number is displayed and waveform updating does not take place.

The DOMINANT function can be exercised only while sweep is stopped with the [3D] switch OFF (see subsection (4)).

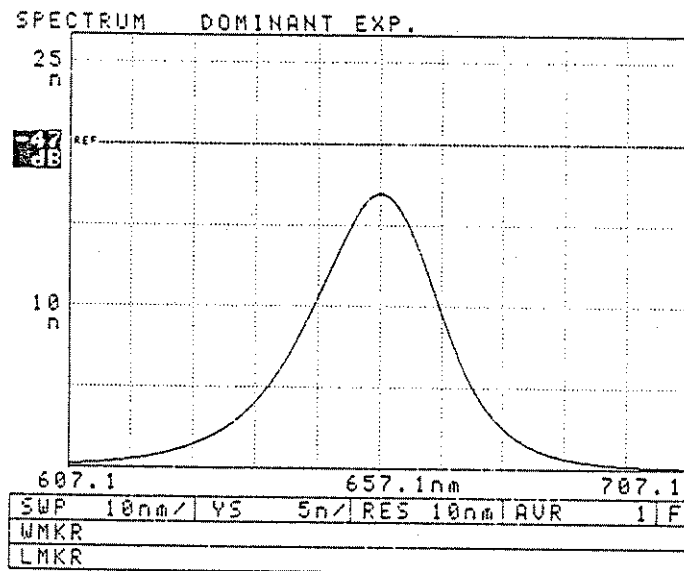

Before Execution

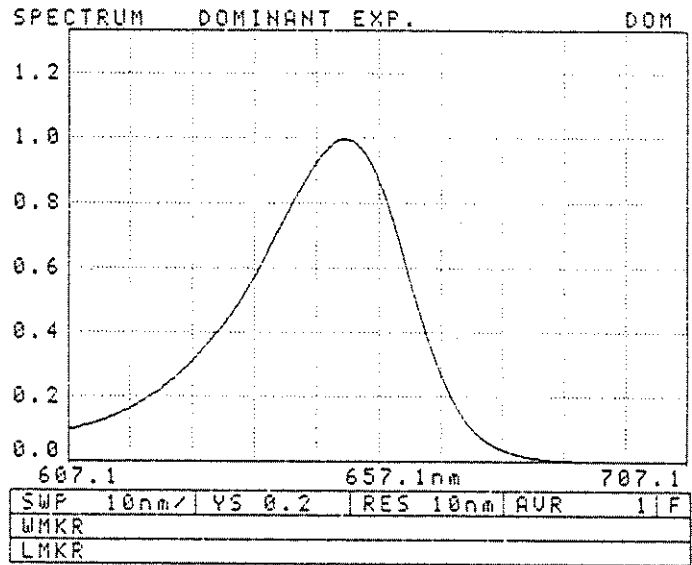

After Execution

Fig. 3-28 DOMINANT Function Execution Examples

(4) 3-D (Three-dimensional) Display

The 3-D display function is useful for observing measured waveform changes with time. Up to 16 waveforms can be measured at certain time intervals and displayed altogether on the CRT.

(a) When the [3D] switch is pressed while sweep is stopped, the switch lamp comes on and the system goes into the 3-D display mode, causing the CRT to show as indicated in Fig. 3-29.

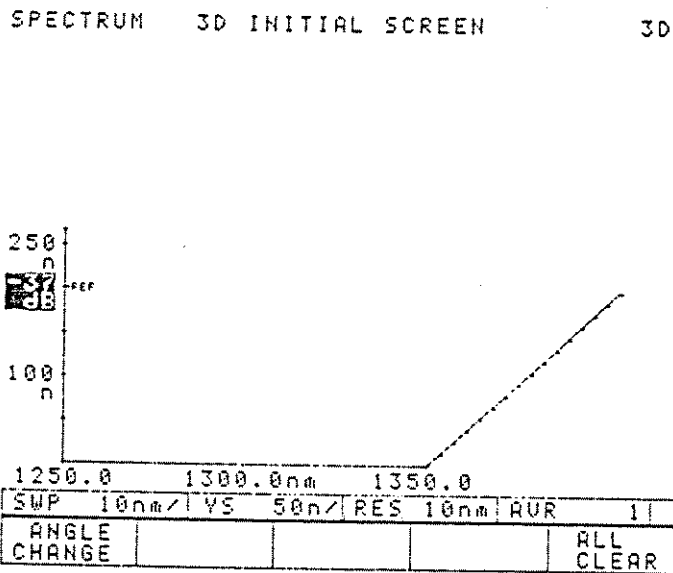

Fig. 3-29 3-D Mode Initial Screen

(b) Sweep starts when the [REPEAT] or [SINGLE] switch is pressed. In [REPEAT] sweep, the first swept waveform is displayed in the forefront row of the screen, with the number "00" attached to the Z-axis. The second swept waveform then appears in the forefront row of the screen, with the number "01" attached to the Z-axis. At this time, the first waveform and its number attached to the Z-axis are scrolled backward.

Whenever sweep is effected subsequently, the last- swept waveform is displayed in the forefront row of the screen, incrementing the Z-axis

number by 1 and scrolling the preceding waveform backward. The Z-axis number indicates the number of sweeps minus 1. This Z-axis count increases in hexadecimal notation from 00 to FF (up to the decimal equivalent of 255) and then resets itself back to 00. Also note that up to 16 waveforms are displayed on the screen at a time; therefore, when 17th and subsequent sweeps are performed, the old displayed waveforms go off one by one.

In [SINGLE] sweep, on the other hand, single sweep takes place. The swept waveform is displayed in the same manner as in [REPEAT] sweep. Whenever the switch is pressed, the measured waveform appears in the forefront row of the screen, scrolling older waveforms backward.

When sweep is resumed after the [STOP] switch has been pressed to halt an ongoing [REPEAT] or [SINGLE] sweep operation, newly swept waveforms are displayed subsequently to the previously swept ones. If new waveforms are to be displayed with previously swept waveforms deleted, clear such old waveforms by pressing the <ALL CLEAR> or [GRAPH CLEAR] switch while sweep is stopped.

- (c) Soft key <ANGLE CHANGE> is used to change the waveform display angle in 10 degree steps from +50 to -50 degrees. When the <ANGLE CHANGE> key is pressed, the current display angle setting appears in the interrupt display area and the soft key menu changes. Turn the rotary knob to select a desired angle, and then press the <EXECUTE> key to update the displayed waveform (see Fig. 3-30). Note that the soft key is displayed only when sweep operations are not performed.

SPECTRUM 3D EXP. ANGLE -30 DEG. 3D

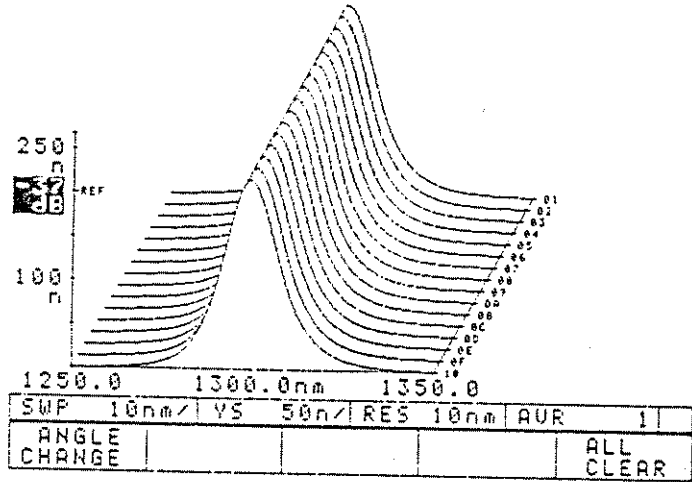

Angle: -30°

SPECTRUM 3D EXP. ANGLE +30 DEG. 3D

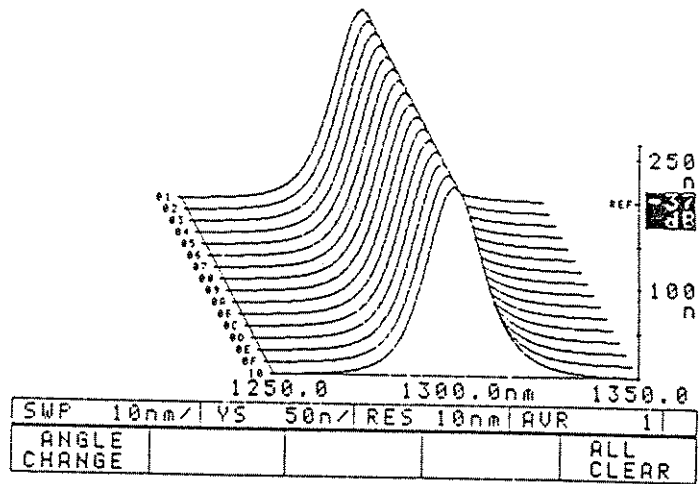

Angle: +30°

Fig. 3-30 3-D Display Example

- (d) In single sweep, soft key <CURRENT CLEAR> is displayed.
When this soft key is pressed, the preceding (latest) waveform only can be eliminated in the 3-D display mode.
This key cannot be activated in succession.
- (e) When soft key <ALL CLEAR> is used, all the waveforms are erased and the MEMORY number is reset to "0."
- (f) The 16 waveforms displayed on the screen are stored in memories 0 through F. The memory number correlates to the rightmost digit of the number attached to the Z- axis of each waveform. For instance, when the Z-axis number is 01, the associated waveform is stored in memory 1, or when the Z-axis number is 7F, the waveform is stored in memory F. When one of the 16 displayed waveforms is to be observed, press the [MEMORY], [RECALL], and [*] (*: any number between 0 and F) switches in sequence.
- (g) In contrast to the other display modes, the following restrictions are imposed on 3-D display.
- 1) In the 3-D display mode, it is impossible to change the center wavelength, sweep width, reference level, or other measurement conditions. Therefore, it is necessary that such conditions be optimized before the 3-D display mode is selected. If the measurement conditions are found in the 3-D mode to be in need of some changes, exit the 3-D display mode to return to a regular screen mode, change the measurement conditions, and then re-enter the 3- D display mode.
 - 2) The markers cannot be used.
 - 3) If either of the [REPEAT] or [SINGLE] switch is pressed during sweep, the system does not restart a sweep operation immediately after switch activation unlike in a regular screen mode. It should also be noted that the soft key options provided for the [REPEAT] or [SINGLE] switch cannot be used. Sweep is conducted in the NORMAL mode (sweep is conducted from the left- to the right-end of the screen). However, the WAIT time setting for REPEAT sweep is as specified with soft key <WAIT> in a regular screen mode.

- 4) Only the following switches are operative in the 3-D display mode (except while sweep is being performed).

[REPEAT], [SINGLE], [STOP], [ADDRESS], [LOCAL], [COPY ON]
[COPY FEED], [FAST], [LABEL ON/OFF], [Y-SCALE], [3D] ,
[GRAPH CLEAR] rotary knob, soft keys.

3.5.9 Marker Usage

Two types of markers are provided: level (horizontal line) markers and wavelength (vertical line) markers. Two fixed markers and one movable marker are provided each for the two marker types.

A marker appearing after [PEAK LEVEL] or [PEAK WAVELENGTH] switch activation is called the "movable marker." This marker moves in coordination with the lower-end display area marker value as the rotary knob is turned.

When the [MARKER 1] or [MARKER 2] switch is pressed with the movable marker placed in any desired position, the marker is fixed in that position. Such a marker is then called the "fixed marker." Both the level and wavelength markers can be designated as markers 1 and 2.

All these markers are used for wavelength and level difference measurements and peak wavelength, peak level, or half-width search.

(1) Level Marker

Press the [PEAK LEVEL] switch when the displayed waveform peak level is to be searched for or a level marker is to be displayed.

(a) When the [PEAK LEVEL] switch is pressed while a waveform is displayed, the system searches for the displayed waveform peak level value, places a level marker at the peak level value position, and displays the marker value in the LEVEL MARKER column (see Fig. 3-31).

(b) If no waveform is displayed when the [PEAK LEVEL] switch is pressed, the system places a level marker at the bottom of the screen and displays the marker value in the LEVEL MARKER column.

(c) When the rotary knob is turned clockwise after marker display, the marker moves upward. Counterclockwise rotary knob rotation causes the marker to move downward. The marker value indicated in the LEVEL MARKER column varies with the marker movement in real time.

(d) When the [MARKER CLEAR] switch is pressed, all displayed markers and the marker values in the WAVELENGTH MARKER and LEVEL MARKER columns are cleared.

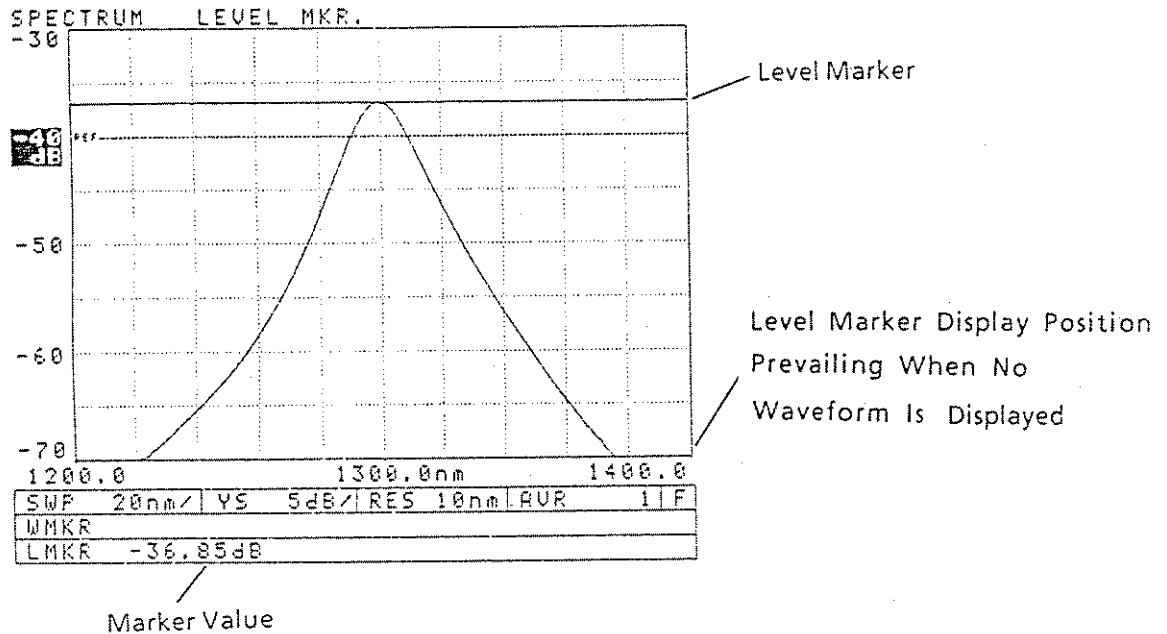

Fig. 3-31 Peak Level Measurement Example

(2) Wavelength Marker

Press the [PEAK WAVELENGTH] switch when the displayed waveform peak wavelength is to be searched for or a wavelength marker is to be displayed on the screen.

(a) When the [PEAK WAVELENGTH] switch is pressed, the system displays the soft key menu on the CRT, searches for the displayed waveform peak wavelength, places a marker at the peak wavelength position, and displays the marker value in the WAVELENGTH MARKER column (see Fig. 3-32).

- (b) If no waveform is displayed when the [PEAK WAVELENGTH] switch is pressed, the system places the marker at the right-hand end of the screen and displays the marker value in the WAVELENGTH MARKER column.
- (c) When soft key <CROSS ON> is activated, the displayed marker functions as the cross marker. When the key <CROSS OFF> is activated, on the other hand, the displayed marker serves as the wavelength marker (see Fig. 3-32).
- (d) When soft key <AUTO ON> is activated, the system searches for the peak wavelength in each REPEAT sweep and displays the marker. When the <AUTO OFF> key is activated, on the other hand, the system searches for the peak wavelength upon [PEAK WAVELENGTH] switch activation only, and not in every sweep. Note, however, that even if the < AUTO ON> key is activated, marker display does not take place while sweep is being conducted between markers 1 and 2.
- (e) When the rotary knob is turned clockwise after marker display, the marker moves to the right. Counterclockwise rotary knob rotation causes the marker to move to the left. The marker value indicated in the WAVELENGTH MARKER column (plus the value indicated in the WAVELENGTH MARKER column when the cross marker is used) varies with the marker movement in real time.

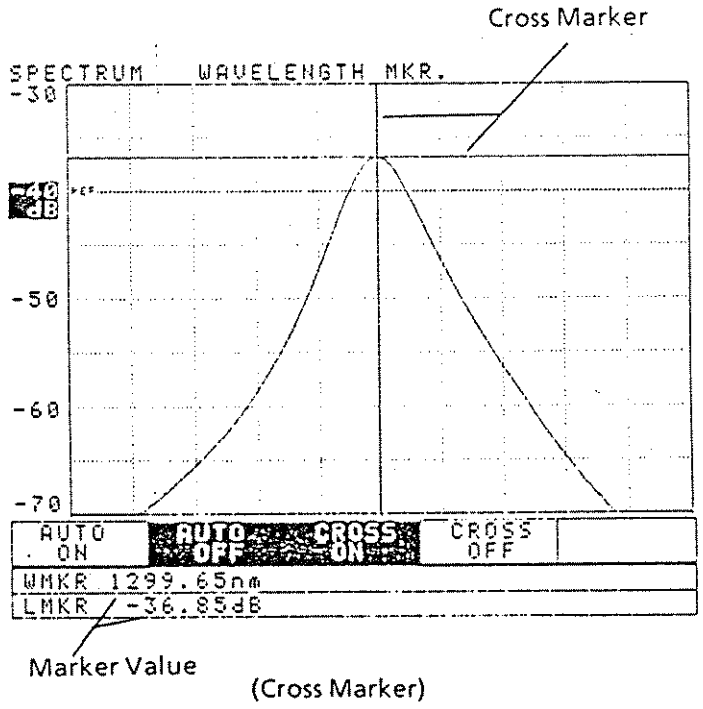
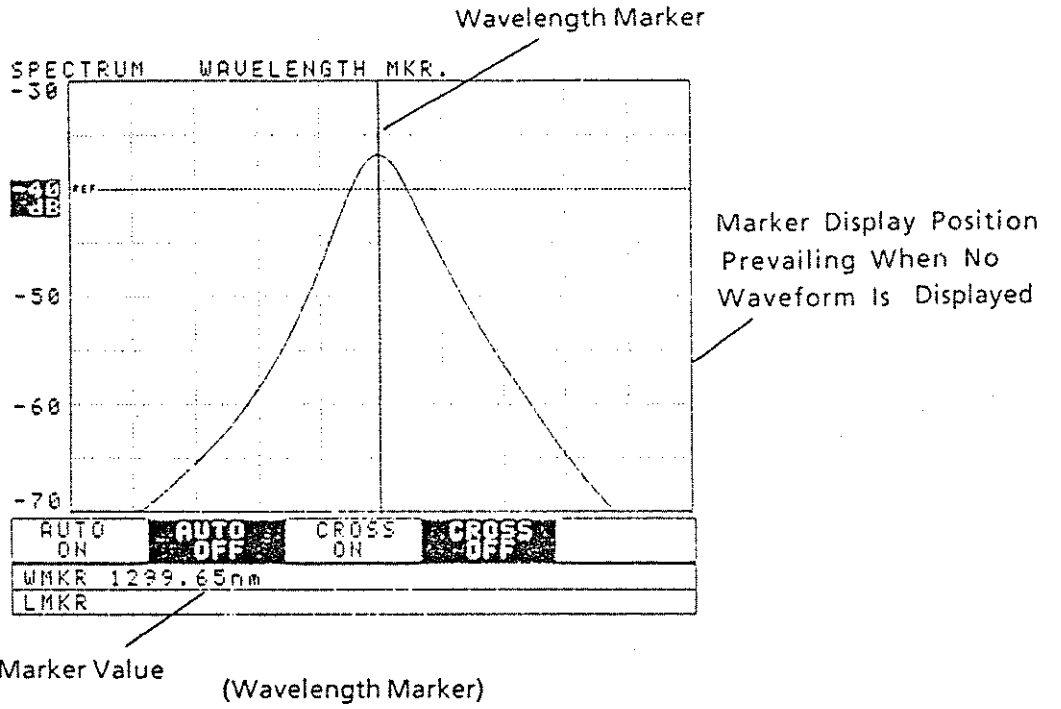

Fig. 3-32 Peak Wavelength Measurement Example

(3) Center Wavelength/Reference Level Setup by Markers

The displayed wavelength and level markers can be used to set up the center wavelength or reference level.

(a) When the [MARKER→CENTER] switch is pressed with a movable wavelength marker displayed on the CRT, the displayed marker value is selected as the center wavelength setting. If the marker value cannot be selected as the center wavelength, the associated ATTN number appears in the interrupt display area.

(b) When the [MARKER→REF LEVEL] switch is pressed with a movable level marker displayed on the CRT, the displayed marker value is selected as the reference level. If the marker value cannot be selected as the reference level, the associated ATTN number appears in the interrupt display area.

3.5.10 Level Difference Measurement

A marker appearing upon [PEAK LEVEL] or [PEAK WAVELENGTH] switch activation is called the "movable marker." This marker moves in coordination with the lower-end display area marker value as the rotary knob is turned.

When the [MARKER 1] or [MARKER 2] switch is pressed with the movable marker placed in any desired position, the marker is fixed in that position. Such a marker is then called the "fixed marker." Both the level and wavelength markers can be designated as markers 1 and 2.

The fixed marker function is exercised for level difference and wavelength difference (see the next section) measurements.

(1) Press the [PEAK LEVEL] switch to display level markers.

(2) When the [MARKER 1] (or [MARKER 2]) switch is pressed after appropriate rotary knob rotation, the system fixes marker 1 (or 2) in the current position and displays the fixed marker 1 (or 2) value in the LEVEL MARKER column. The movable marker value is then assigned to the unfixed marker (2 or 1), and the right-hand end of the LEVEL MARKER column shows the level difference between the fixed and movable markers.

- (3) When the rotary knob is turned, the level difference indicated in the LEVEL MARKER column varies in real time with the movable marker movement.
- (4) When the [MARKER 2] (or [MARKER 1]) switch is pressed to fix the marker that was not fixed in step (2), the level difference indicated in the LEVEL MARKER column is also fixed. (Refer to Fig. 3-33.)
- (5) The indicated level difference refers to the value "marker 2 - marker 1" when the Y-axis is in the LOG scale mode or the value "marker 2 / marker 1" when the Y-axis is in the LIN scale mode.

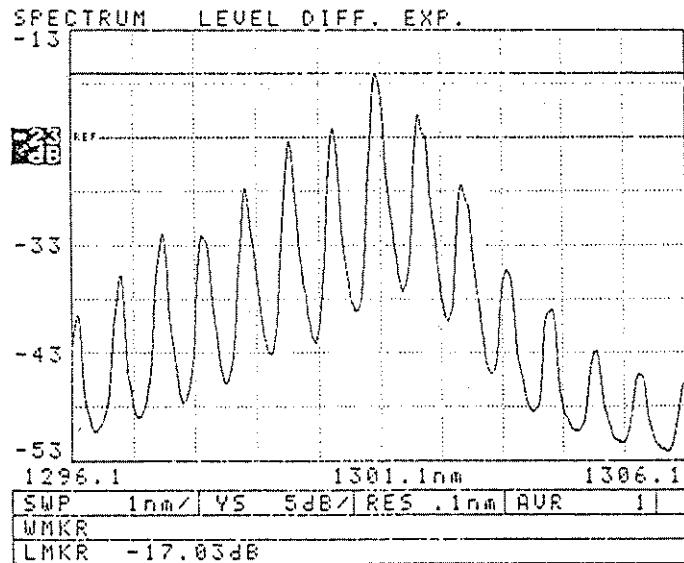

State Prevailing upon [PEAK LEVEL] Switch Activation

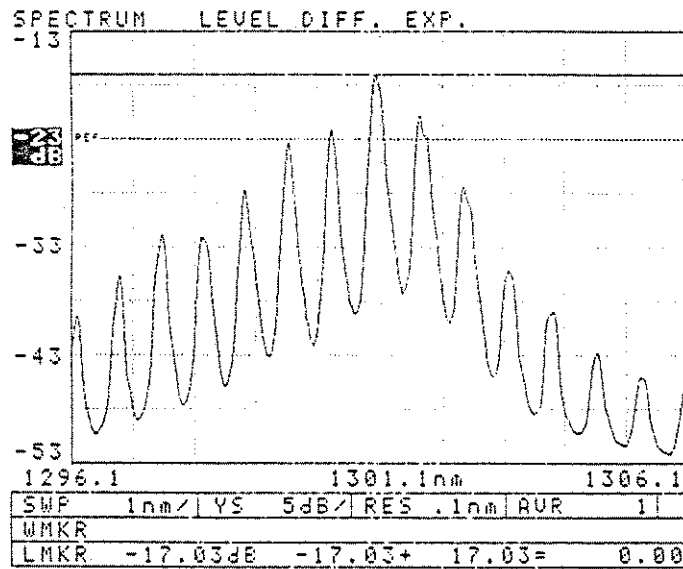

State Prevailing upon [MARKER 1] Switch Activation

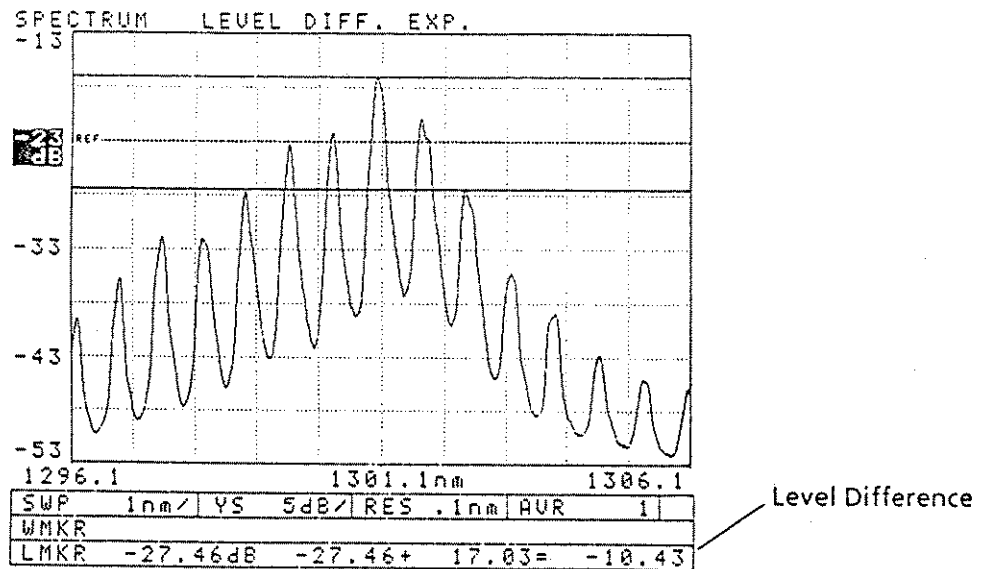

State Prevailing upon [MARKER 2] Switch Activation

Fig. 3-33 Level Difference Measurement Examples

3.5.11 Wavelength Difference Measurement

- (1) When the wavelength markers are used after [PEAK WAVELENGTH] switch and <CROSS OFF> key activation, the same display indications are given as described in section 3.5.10 except that the level markers are replaced by the wavelength markers.
- (2) When the <CROSS ON> key is activated to use a cross marker, [MARKER 1] (or [MARKER 2]) switch activation fixes both the wavelength marker and the level marker that is perpendicular to the wavelength marker. The movable marker value is then indicated in the unfixed marker value area of the MARKER column while the right-hand end of the same column shows the level and wavelength differences between the fixed and movable markers.
- (3) When the rotary knob is turned, the level and wavelength differences indicated in the MARKER column vary in real time with the movable marker movement.
- (4) When the [MARKER 2] (or [MARKER 1]) switch is pressed to fix the marker that was not fixed in step (2), the level and wavelength differences indicated in the MARKER column are also fixed. (Refer to Fig. 3-34.)

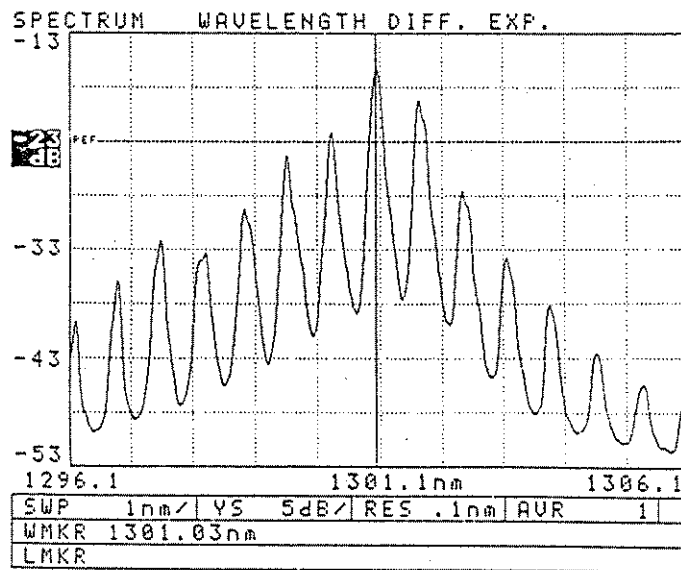

State Prevailing upon [PEAK WAVELENGTH] Switch Activation

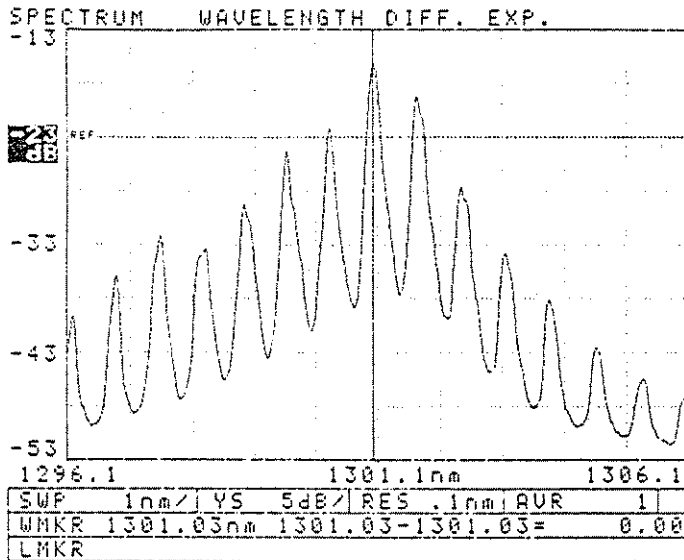

State Prevailing upon [MARKER 1] Switch Activation

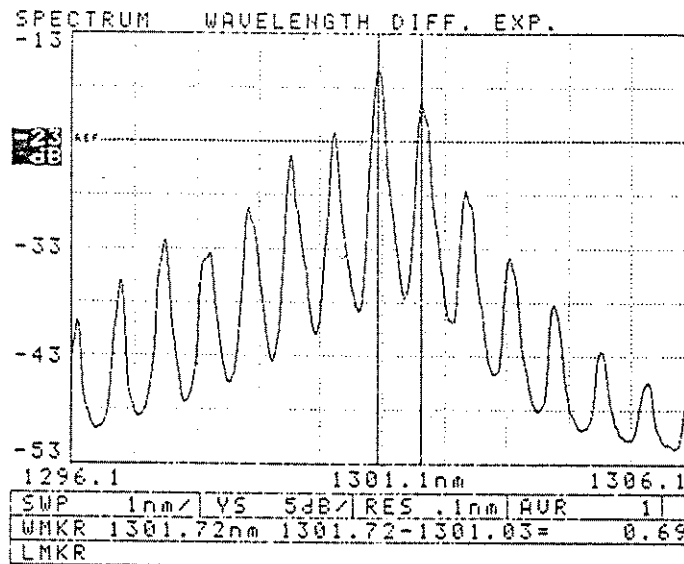

Wavelength Difference

State Prevailing upon [MARKER 2] Switch Activation

Fig. 3-34 Wavelength Difference Measurement Examples

3.5.12 Half-Width Measurement

There are several half-width definitions. The AQ-6310B makes half-width measurement by the envelope method, RMS (root-mean-square) method, or threshold method.

- (1) To measure the half-width of a waveform displayed on the CRT, press the [HALF-WIDTH SEARCH] switch.
- (2) The soft key menu then appears on the CRT, and the system calculates the half-width according to the latched algorithm and displays a wavelength marker.
- (3) Enter the threshold to be set using the rotary knob.
The settable threshold varies with the algorithm selected.
The settable threshold is shown in the table given below.

Algorithm	Settable Threshold
ENV method	3dB, 6dB
RMS × 1.00 method	10dB, 15dB, 20dB
RMS × 2.00 method	
RMS × 2.35 method	
THRESH method	3dB, 6dB, 10dB, 15dB, 20dB

- (4) The wavelength difference between markers 1 and 2 is indicated in the WAVELENGTH MARKER column. This indicated value represents the half-width.
- (5) When determining the half-width according to another algorithm, press the associated soft key. The system then performs calculations immediately, displays a wavelength marker, and indicates the half-width in the WAVELENGTH MARKER column.
- (6) Fig. 3-35 presents the examples of measurements made by various methods.

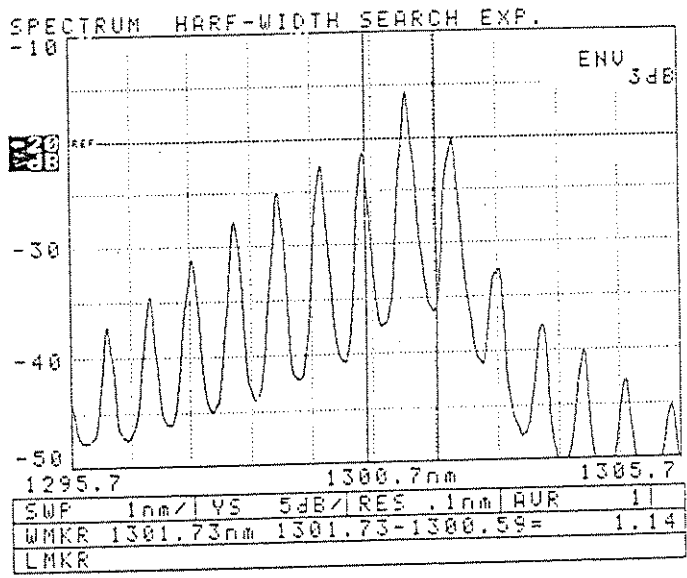

<ENV> Method

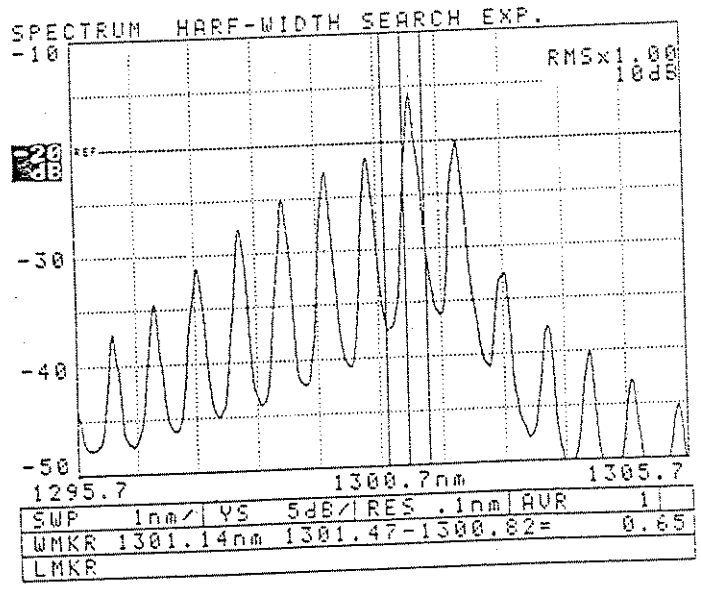

<RMS> Method

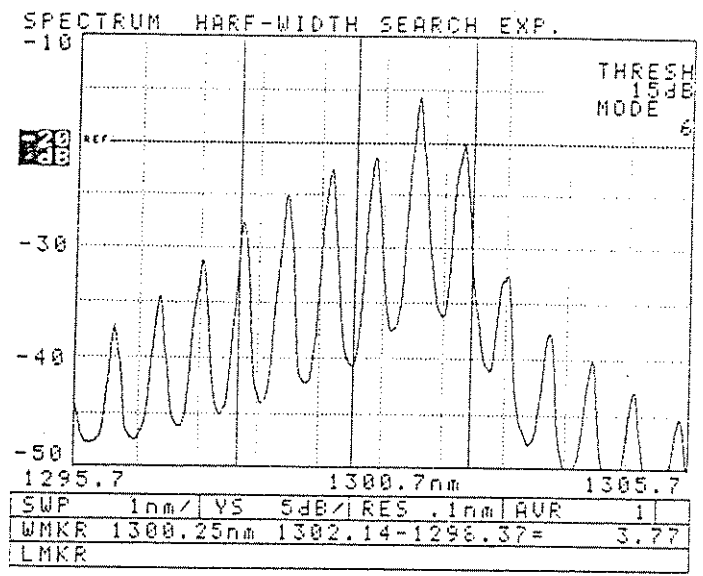

<THRESH> Method

Fig. 3-35 Half-Width Measurement Examples

3.5.13 Half-Width Algorithms

(1) Envelope Method

The half-width is determined according to the following algorithm after [HALF-WIDTH SEARCH] switch activation.

When the envelope method is used, the threshold can be set to 3 dB or 6 dB by the rotary encoder.

In the following description, read the set value for * dB.

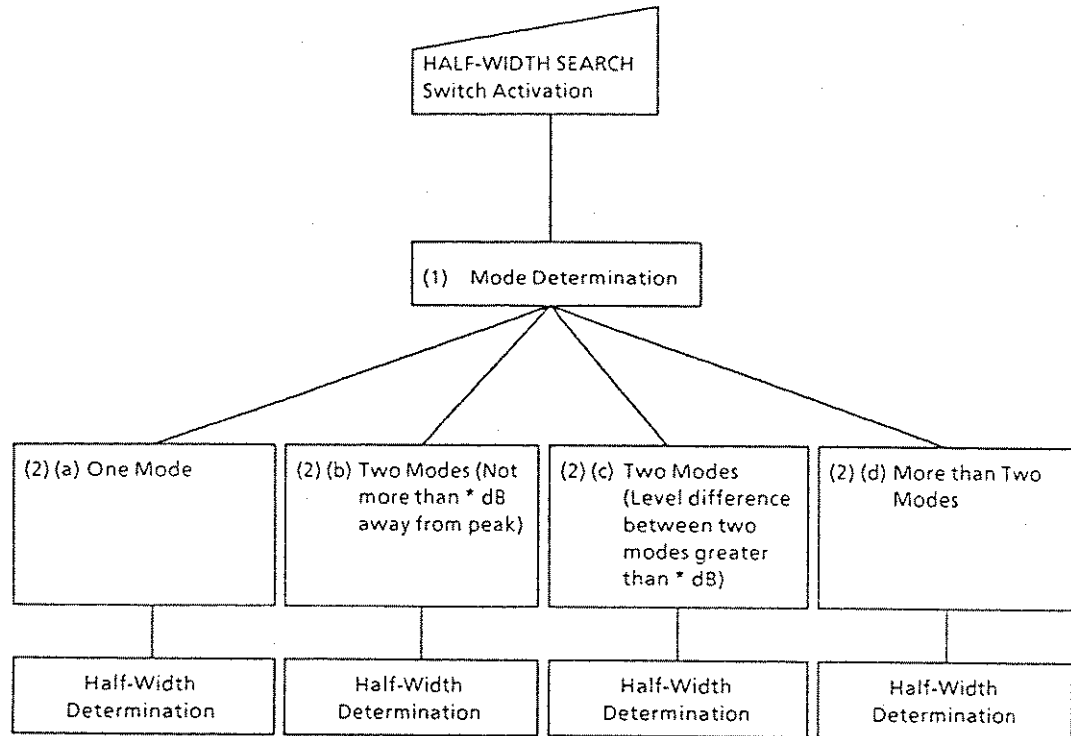

Fig. 3-36 Half-Width Determination Algorithm (ENV Method)

1) Mode Determination

The level 13 dB lower than the peak level is referred to as mode judgment level I and the level 10 dB lower than the peak level is called mode judgment level II (see Fig. 3-37). The portions above mode judgment level I are considered mode candidates, and when the peak level of an individual mode candidate is higher than mode judgment level II, such a mode candidate is treated as one mode.

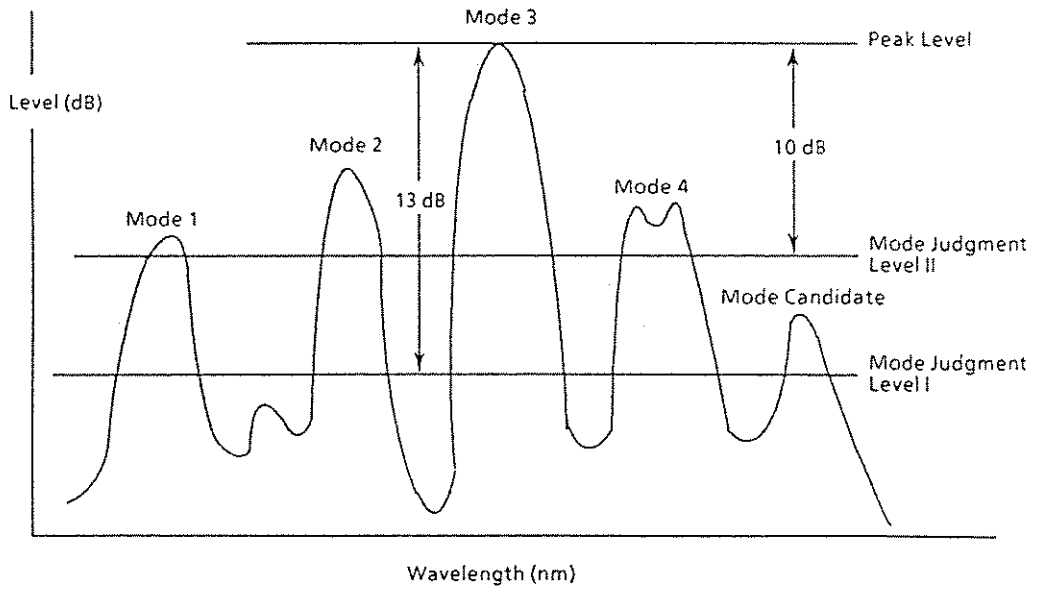
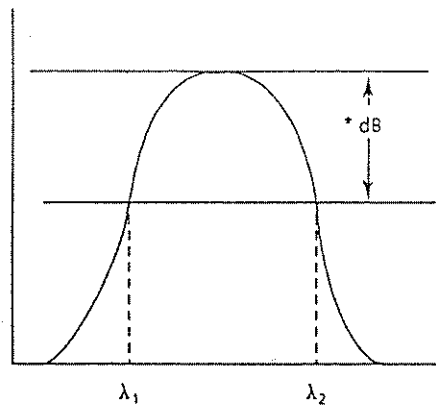

Fig. 3-37 Mode Determination

2) Half-Width Determination

(a) One Mode



The half-width must be determined at a level * dB lower than the peak.

$$\Delta\lambda = \lambda_2 - \lambda_1$$

Fig. 3-38

(b) Two Modes Not More than * dB away from Peak Level

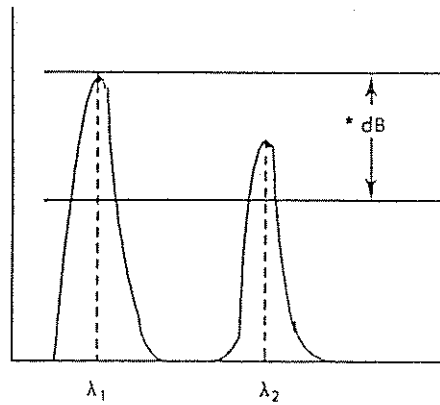

The distance between the peak positions of the two modes must be regarded as the half-width.

$$\Delta\lambda = \lambda_2 - \lambda_1$$

Fig. 3-39

(c) Two Modes Whose Levels Are More than * dB apart from Each Other

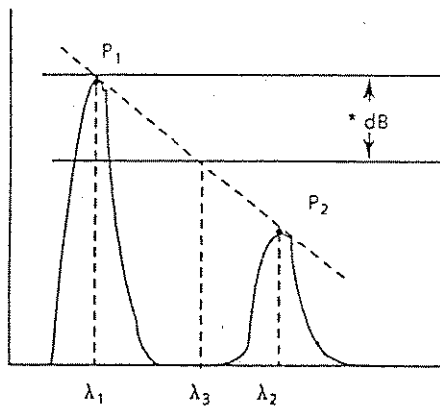

As indicated in Fig. 3-40, the distance between the peak position (λ_1) and $* \text{ dB}$ difference position (λ_3) must be regarded as the half-width.

$$\Delta\lambda = \lambda_2 - \lambda_1$$

$$\Delta\lambda = \lambda_3 - \lambda_1 = - * \times \frac{\lambda_2 - \lambda_1}{P_2 - P_1}$$

$$\lambda_3 = \lambda_1 - * \times \frac{\lambda_2 - \lambda_1}{P_2 - P_1}$$

Fig. 3-40

VII-44

(d) More than Two Modes

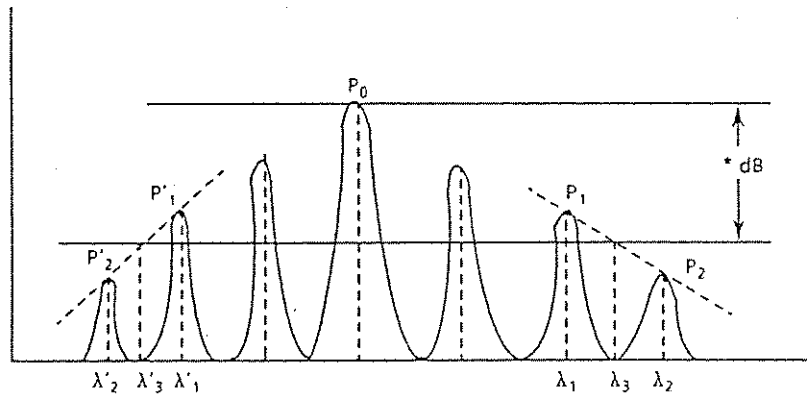

Fig. 3-41

- (i) Locate the rightmost and leftmost modes.
- (ii) When the rightmost and leftmost mode levels are less than * dB lower than the peak level, they are regarded as the half-width points (λ_3 and λ'_3).
- (iii) When the rightmost and leftmost mode levels are more than * dB lower than the peak level, check the inner modes until you encounter the mode levels less than * dB lower than the peak level.
- (iv) Draw straight lines so as to connect the modes more than * dB lower than the peak level, to the modes less than * dB lower than the peak level.
- (v) The intersections of the drawn straight lines and *-dB-lower-than-peak-level lines must be regarded as the half-width points (λ_3 and λ'_3), as indicated in Fig. 3-41.
- (vi) When all mode levels except the peak level are more than * dB lower than the peak level, draw straight lines so as to connect the right- and left-hand side highest modes to the peak level point. In this case, the intersections of the drawn straight lines and *-dB-lower-than-peak-level lines must be regarded as the half-width points.

$$\Delta\lambda = \lambda_3 - \lambda'_3$$

$$\lambda_3 = \frac{\lambda_2 - \lambda_1}{P_2 - P_1} (P_0 - * - P_1) + \lambda_1$$

(2) RMS (Root-Mean-Square) Method

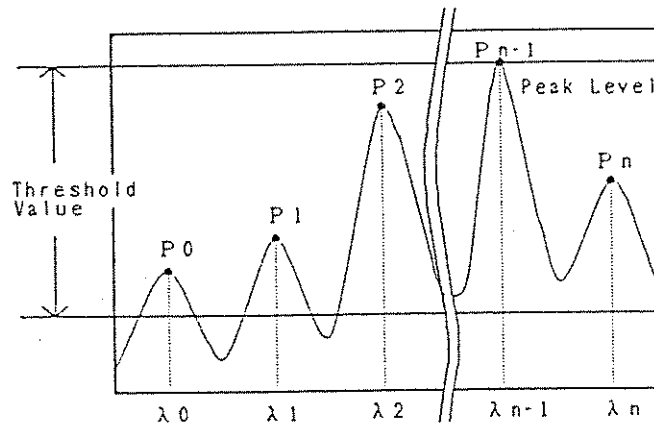

Fig. 3-42

- (a) Take out all sampling points above the specified value (selected by the rotary encoder among 10, 15, and 20 dB) from the displayed waveform; then determine the half-value width using the following formulas.
- (b) Center wavelength λ_0 can be calculated from wavelength λ_i at the peak position in each mode and level P_i at that point, as shown below.

$$\lambda_0 = \frac{\sum P_i \cdot \lambda_i}{\sum P_i}$$

- (c) Using center wavelength λ_0 determined in (b), calculate half-value width $\Delta\lambda$ as follow.

$$\Delta\lambda = \sqrt{\frac{\sum P_i \cdot (\lambda_i)^2}{\sum P_i} - \lambda_0^2}$$

(d) Set wavelength marker 1 to position $\lambda_0 - \Delta\lambda/2$, wavelength marker 2 to position $\lambda_0 + \Delta\lambda/2$, and the movement marker to the position of center wavelength λ_0 .

The half-value width is then equal to (marker 2) - (marker 1).

(e) For $\langle \text{RMS} \times 2.0 \rangle$ and $\langle \text{RMS} \times 2.35 \rangle$, the half-value width determined above is multiplied by 2.0 and 2.35, respectively, and these values are displayed as the half-value width.

NOTE

The RMS method should be used only when the resolution is 0.1 nm or less, and the sweep width is 5 nm, 1 div or less (when the wavelength range is 950 to 1750 nm) and 2 nm, 1 div or less (when the wavelength range is 400 to 950 nm). Unless these conditions are met, errors may be detected.

(3) Threshold Method

(a) Displayed spectrum waveforms that meet all the following conditions are treated as the modes.

(1) Level $P_j \geq P_{\max} - K_1$ ($K_1 = ** \text{dB}$)

(2) Difference between peak and trough $P_j - L_j \geq K_2$ ($K_2 = 3 \text{ dB}$)

Difference between peak and trough $P_j - L_{j-1} \geq K_2$ ($K_2 = 3 \text{ dB}$)

(3) Spectral width $L_j - L_{j-1} \geq K_3$ ($K_3 = 0.1 \text{ nm}$)

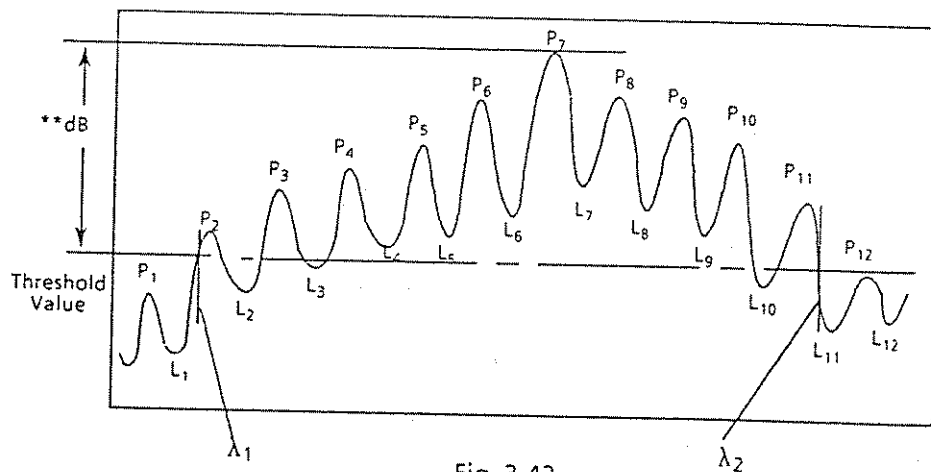

Fig. 3-43

(b) Locate the intersections of the rightmost and leftmost modes and threshold value (** dB) line. When these intersections are expressed as λ_1 and λ_2 , the half-width = $\lambda_2 - \lambda_1$.

- (c) When the threshold method is employed, the wavelength markers are placed in the positions of λ_1 , λ_2 , and $(\lambda_1 + \lambda_2) / 2$. Further, the number of displayed waveform modes is determined in accordance with the conditions indicated in paragraph (a) and displayed in the interrupt display area.

3.5.14 MEMORY and DATA MEMORY

The AQ-6310B has 18 memories which are used to store waveforms, measurement conditions, and other relevant data. As regards 16 out of the 18 memories, label character switch ([0] through [9] and [A] through [F]) activation after [MEMORY SAVE] or [MEMORY RECALL] switch depression effects data storage or recall. The measurement condition memories are nonvolatile and therefore retain their stored data even after power turn-off. However, the waveform data memories lose their stored data upon power off. For the remaining two memories, data storage takes place upon [DATA MEMORY Acc A] or [DATA MEMORY Acc B] switch activation, and data recall occurs when the [RECALL] and [Acc A] or [Acc B] switches are pressed in sequence. The [Acc A] and [Acc B] memories have an accumulator function. Therefore, it is possible to perform stored waveform data subtractions and display the results. These memories are nonvolatile and therefore do not lose their stored waveforms and measurement conditions upon power turn-off. Subtraction computations cannot be performed with [MEMORY 0] through [MEMORY F] contents alone. However, the [RECALL] and [*] (*: number between 0 and F) switches can be pressed to call up desired data onto the screen and then the [DATA MEMORY Acc A] or [DATA MEMORY Acc B] switch pressed so that the data is stored in the accumulator to carry out subtraction.

NOTE

The [MEMORY 0] through [MEMORY F] memories (16 in total) are used as the 3-D display buffers. Therefore, when measurement is made with 3-D display feature activated, the memories lose all previously saved waveforms.

3.5.15 Waveform Storage and Recall by MEMORY Functions

When a displayed waveform is to be stored into memory or a waveform stored in memory is to be displayed on the screen, perform the following procedure.

- (1) Make measurement so that a waveform to be stored is displayed on the screen, and be sure that sweep is stopped.
- (2) Press the [MEMORY SAVE] switch and then any one of label character switches [0] through [9] or [A] through [F] (numbers or alphabetical letters are printed in green). The waveform and measurement conditions are then stored into memory. Upon [MEMORY SAVE] switch activation, the upper right-hand corner of the screen reads "SAVE". Further, when any one of [0] through [F] switches is pressed subsequently to [MEMORY SAVE] switch activation, the screen reads "MEM *" (*: number between 0 and F) to indicate the name of the memory into which the data have been saved.
- (3) To recall a waveform stored in memory, press the [MEMORY RECALL] switch and then any one of label character switches [0] through [9] or [A] through [F]. Upon [MEMORY RECALL] switch activation, the upper right-hand corner of the screen reads "RCL". Further, when any one of the [0] through [F] switches is pressed subsequently to [MEMORY RECALL] switch activation, the screen reads "MEM *" (*: number between 0 and F) to indicate the name of the memory being recalled, and then shows the recalled waveform. (Refer to Fig. 3-44.)
- (4) If a switch other than label character switches [0] through [9] and [A] through [F] is pressed in step (2) or (3), the keying operation is aborted. When such a condition occurs, press the [SAVE] or [RECALL] switch again and proceed to the next keying operation.
If the specified memory stores no waveforms or measurement conditions when the [RECALL] operation is performed, the operation is aborted and the associated ATTN number appears on the screen.

- (5) In the [0] through [9] and [A] through [F] memories, the waveform storage areas are volatile and the measurement conditions storage areas, nonvolatile. Therefore, when the power is turned off, the waveform data are lost. However, the measurement condition data will be retained so that they can be recalled by pressing the [RECALL] and [*] (*: number between 0 and F) keys in sequence after power restoration.

- (6) When the [GRAPH CLEAR] switch is pressed, the displayed waveform is cleared. Note that only the waveform is cleared at this time, and that the scale marks, lower-end display area, or memory contents are not cleared.

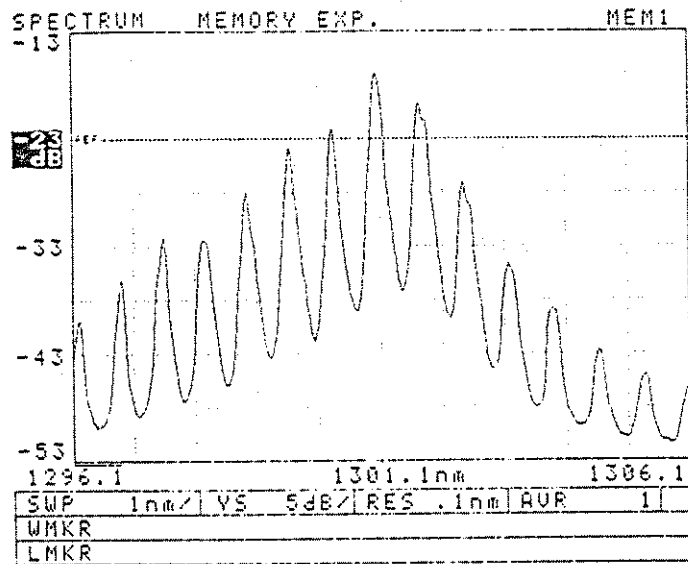

State Prevailing upon [MEMORY SAVE]-[1] Switch Activation

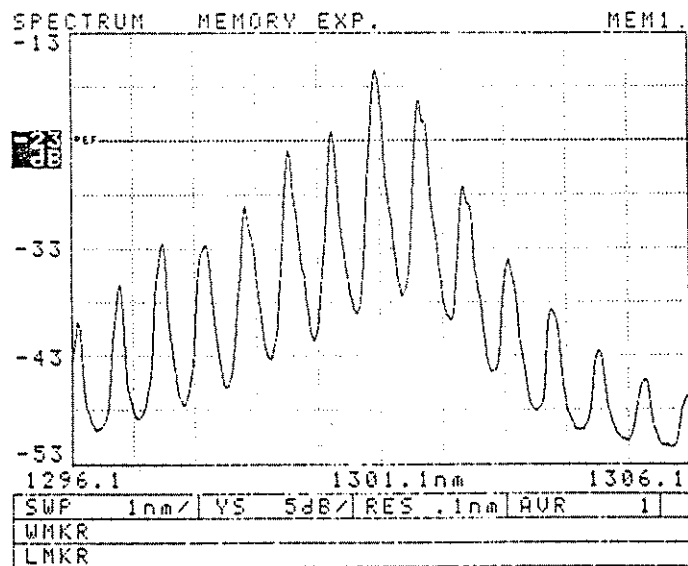

State Prevailing upon [MEMORY RECALL]-[1] Switch Activation

Fig. 3-44 MEMORY Function Execution Examples

3.5.16 Data Overlap Display

The following procedure is performed to display overlapping waveform data after they have been derived from accumulators A and B and memories 0 through F. The following explanation applies to the cases where accumulators A and B are used.

- (1) Make measurement so that a waveform is displayed on the screen. Be sure that sweep is stopped.
- (2) Press the [Acc A] or [Acc B] switch to store the displayed waveform into accumulator A (Acc A) or accumulator B (Acc B). At this time, the upper right-hand corner of the screen reads "Acc A" or "Acc B" to indicate which accumulator has stored the waveform.
- (3) Repeat steps (1) and (2) to store a waveform into the other accumulator.
- (4) Press the [DATA MEMORY RECALL] and [Acc A] switches in sequence so that the Acc A waveform is recalled and displayed again on the screen. Upon [DATA MEMORY RECALL] switch activation, the upper right-hand corner of the screen reads "ACC". Further, when [Acc A] switch is pressed subsequently to [DATA MEMORY RECALL] switch activation, the screen reads "Acc A" to indicate the recalled accumulator name.
- (5) Press the [DATA MEMORY RECALL] and [Acc B] switches in sequence. The Acc B waveform is then recalled and appears on the screen with the Acc A waveform continuously displayed. (Refer to Fig. 3-45.)
- (6) To provide overlap display, it is necessary that the Acc A and Acc B waveform measurement conditions coincide in center wavelength, sweep width, and resolution. However, if the measurement conditions differ in any one of them, overlap display does not take place so that the screen shows only the waveform recalled later.
If the Acc A and Acc B waveforms coincide in the above-mentioned measurement conditions but differ in other conditions, overlap display is provided with the "*" mark displayed along the Y-axis or in the associated lower-end display area column. In such a case, the waveform recalled later

is displayed after being adjusted to suit the measurement conditions for the previously recalled waveform.

- (7) The displayed waveforms are cleared when the [GRAPH CLEAR] switch is pressed.

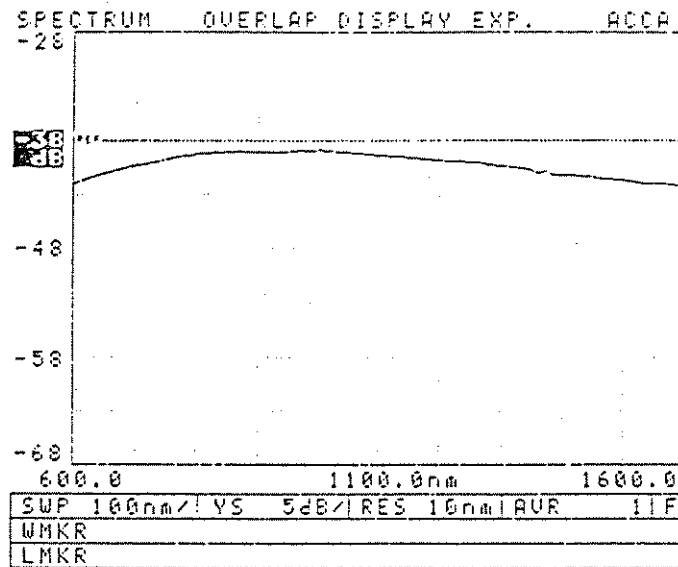

State Prevailing upon [DATA MEMORY RECALL]-[Acc A] Switch Activation

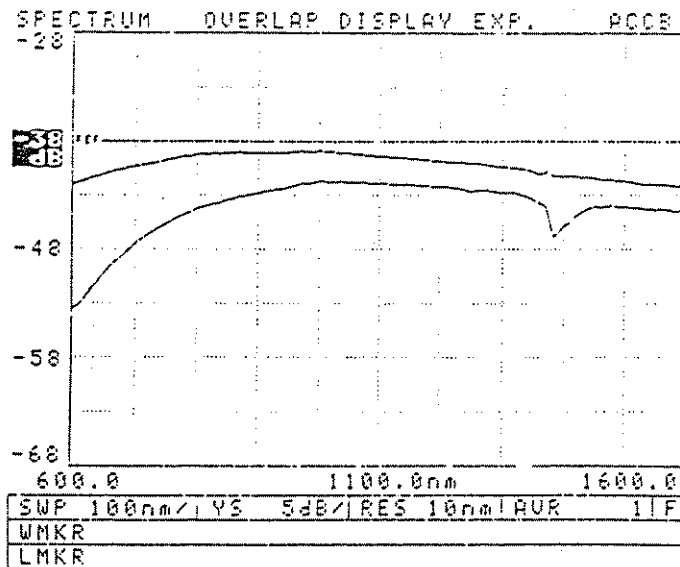

State Prevailing upon [DATA MEMORY RECALL]-[Acc B] Switch Activation

Fig. 3-45 Overlap Display Function Execution Examples

3.5.17 Data Subtraction Display by DATA MEMORY Function

The data stored in the Acc A and Acc B can be subjected to subtraction (A - B when the Y-axis is in the LOG scale mode or A / B when the Y-axis is in the LIN scale mode) and displayed, using the [DATA MEMORY A-B A/B] or [DATA MEMORY B-A B/A] switch.

The following subsections present the examples of optical fiber loss wavelength characteristic and optical filter transmittance measurements that are made using the DATA MEMORY data subtraction function.

(1) Optical Fiber Loss Wavelength Characteristic Measurement

(a) Set the AQ-6310B measurement conditions as follows.

[CENTER WAVELENGTH] <START WL>: 700nm, [CENTER WAVELENGTH] <STOP WL>: 1700 nm, [SWEEP WIDTH] <MEAS WL INTVL>: 10 nm, [RESOLUTION]: 10nm, [REFERENCE LEVEL]: -20 dB, [AVERAGE TIMES]: 1, [SENSITIVITY] <H-SENS SLOW>, [Y-SCALE]: 10 dB/div

(b) After set the wavelength 700 to 1000 nm with AQ-4303B White light source. (See Note 1)

(700 to 1750 nm, it is not possible to measure 700 nm or less.)

As indicated in Fig. 3-46, connect the AQ-6310B to a white light source with the reference (short) fiber. Press the [SWEEP SINGLE] switch to make reference spectrum measurement.

(c) Press the [Acc A] switch to store the reference spectrum into the Acc A.

(d) As shown in Fig. 3-46, replace the reference fiber with the fiber under test. Press the [SWEEP SINGLE] switch to make comparison spectrum measurement.

(e) Press the [Acc B] switch to store the comparison spectrum into the Acc B.

(f) To subtract the comparison value from the reference value, press the [A-B A/B] switch. The soft key menu then appears on the screen, and the value obtained by subtracting the Acc B data from the Acc A data is

subjected to automatic scaling and displayed. At this time, the upper right-hand corner of the screen reads "A-B" to indicate that the (A - B) data is displayed. The resultant displayed waveform shows the loss wavelength characteristic.

- (g) The automatic scaling display function exercised upon [A-B A/B] or [B-A B/A] switch activation is useful because the optimum scale is obtained at all times. However, when two or more data are to be compared against the reference data, the scale unexpectedly varies causing inconvenience to the measurement personnel. To avoid such inconvenience, the Y-axis scale should be manually changed after automatic scaling.

To effect such Y-axis scale change, press soft key <Y SCALE> or <Y OFFSET> after automatic scaling display. After <Y SCALE> key is pressed, the current Y-axis scale appears in the interrupt display area. Its function permits the Y-axis scale to be varied with the mean (the value equal to the inverted one) at the center. This value can be varied from 10 dB to 0.2 dB. At this time, the waveform, lower display area, and Y-axis scale vary on a real-time basis (see Fig. 3-48)

When <Y OFFSET> key is pressed, the current offset value (equal to the inverted one) appears in the interrupt display area.

When the rotary knob is turned to vary the value in 1 dB steps, the waveform and Y-axis scale are updated on a real-time basis (see Fig. 3-49). The variable range is from -50 dB to 50 dB. In LIN display mode, this function cannot be used.

- (h) The above data subtraction processing takes place only when the measurement conditions for the waveforms stored in the Acc A and Acc B coincide in center wavelength, sweep width, and resolution. If the Acc A and Acc B waveforms differ in any one of them, the system displays the associated ATTN number on the screen and does not execute the data subtraction display function.

If the Acc A and Acc B data coincide in the above-mentioned three conditions but differ in averaging times setting and HIGH-SENSITIVITY ON/OFF status, subtraction display is provided with the "*" mark

displayed in the associated lower-end display area column and the Acc B averaging times setting adjusted to agree with the Acc A value.

(Reference Value Measurement)

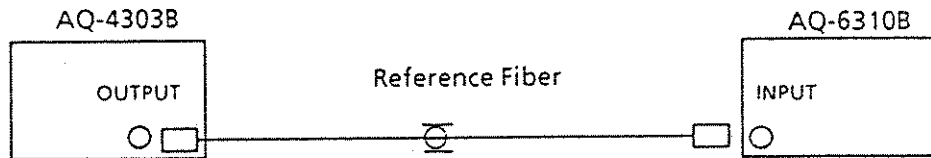

(Comparison Value Measurement)

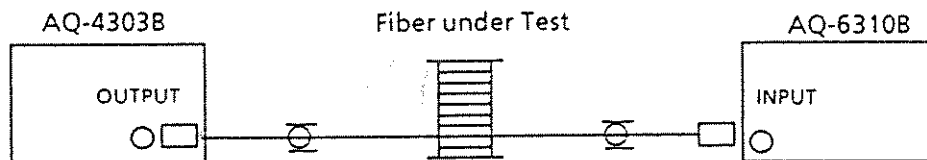
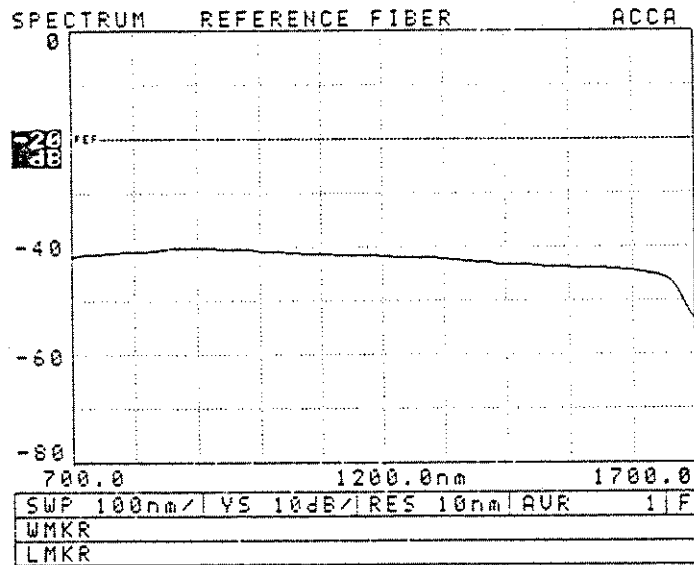

Fig. 3-46 Loss Wavelength Characteristic Measurement Setup

Note 1

This unit provides for measurement throughout a range of 700 to 1700 nm, using white light source wavelength over a 700 to 1000 nm range. This is because the AQ-4303B cuts the wavelength of 700 nm or less but passes the light of 1000 nm or longer wavelength. Conventional spectrosopes pass light of integral multiples of a certain wavelength so that when they are used over a wavelength range of 1000 nm or more, they must be set in the range of 1000 to 1800 nm. This unit, however, eliminates the need of such settings because it contains the filter to cut high-order light on the longer-wavelength side.

When 1700 nm or longer wavelength measurements are to be made, set the AQ-4303B for a wavelength range of 1000 to 1800 nm. When this wavelength range setting is employed, wavelengths of 1000 to 1750 nm can be covered.



[Acc A] Switch Activated after Reference Fiber Measurement

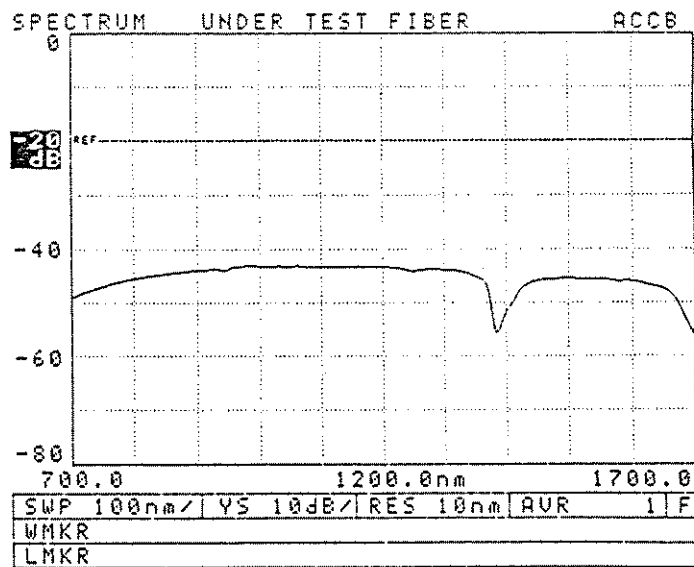

[Acc B] Switch Activated after Fiber-under-Test Measurement

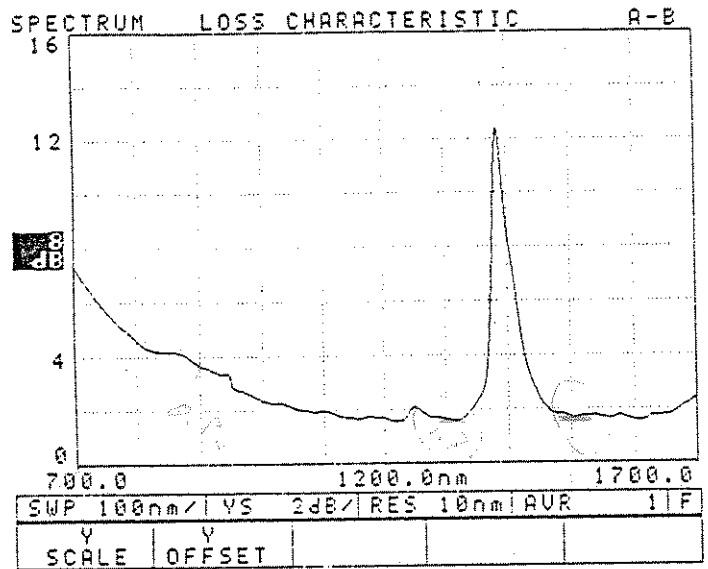

[A-B A/B] Switch Activated

Fig. 3-47 Loss Wavelength Characteristic Measurement Examples

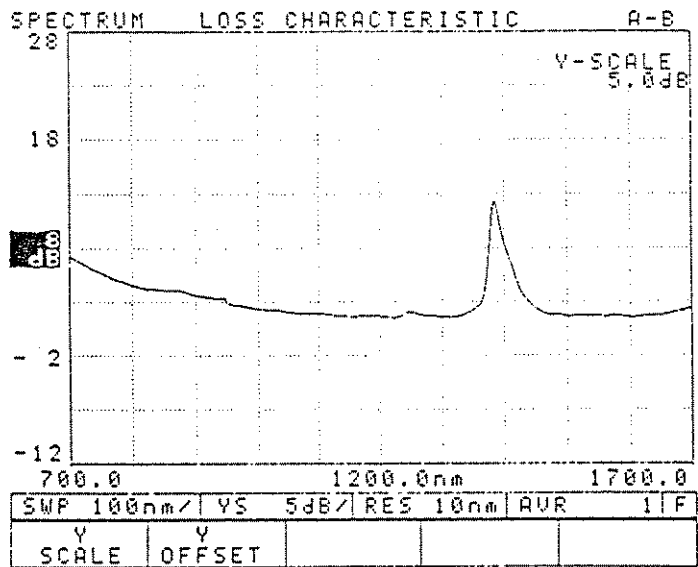

Fig. 3-48 Manual Setting with <Y SCALE>

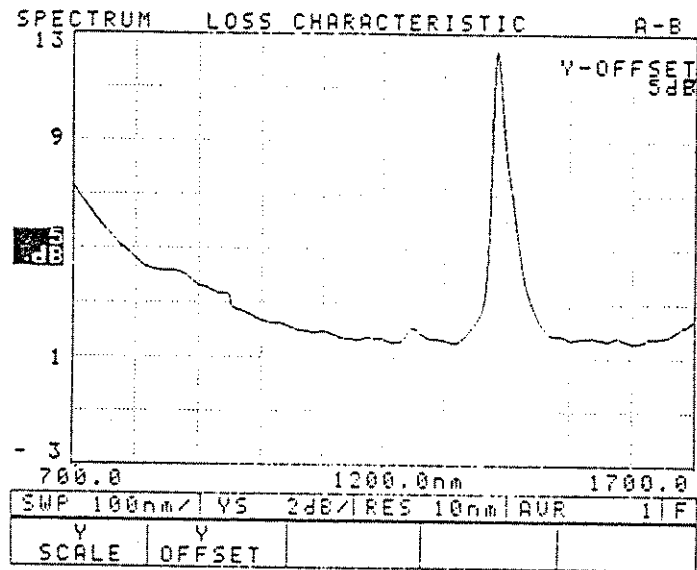
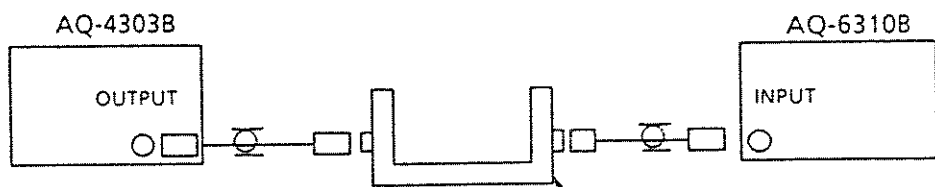

Fig. 3-49 Manual Setting with <Y OFFSET>

- (2) Optical Filter Transmittance Measurement (600 to 1700 nm)
 - (a) After set the wavelength 700 to 1000 nm with AQ-4303B White light source.
(700 to 1750 nm, it is not possible to measure 700 nm or less.)
As indicated in Fig. 3-50, measure the reference spectrum and store it into the Acc A.
 - (b) Insert the optical filter, as indicated in Fig. 3-50, and measure the comparison spectrum and store it into the Acc B.
 - (c) Press the [B- \bar{A} B/A] switch to subtract the reference value from the comparison value. The soft key menu then appears on the screen, and the value obtained by subtracting the Acc A data from the Acc B data is subjected to automatic scaling and displayed. At this time, the upper right-hand corner of the screen reads "B-A" to indicate that the (B - A) data is displayed. The resultant displayed waveform shows the transmittance.
 - (d) When the Y-axis scale is to be changed, perform the same procedure as indicated in step (1)-(f).

(Reference Value Measurement)



(Comparison Value Measurement)

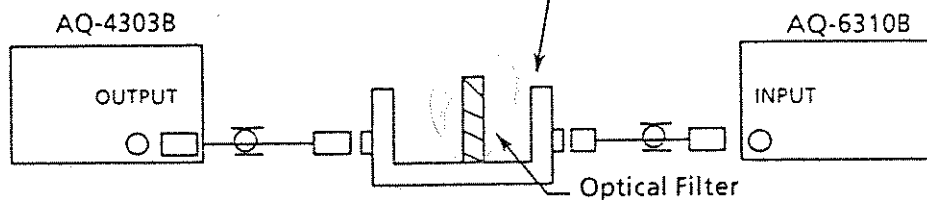
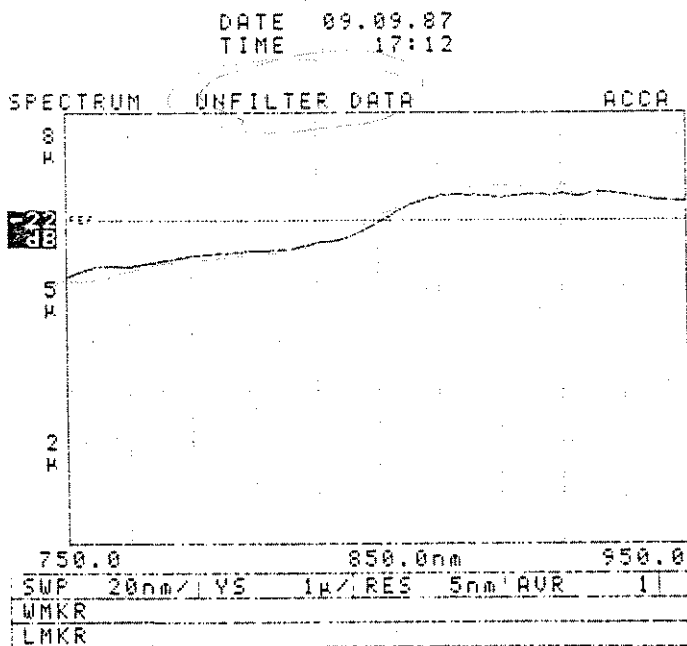
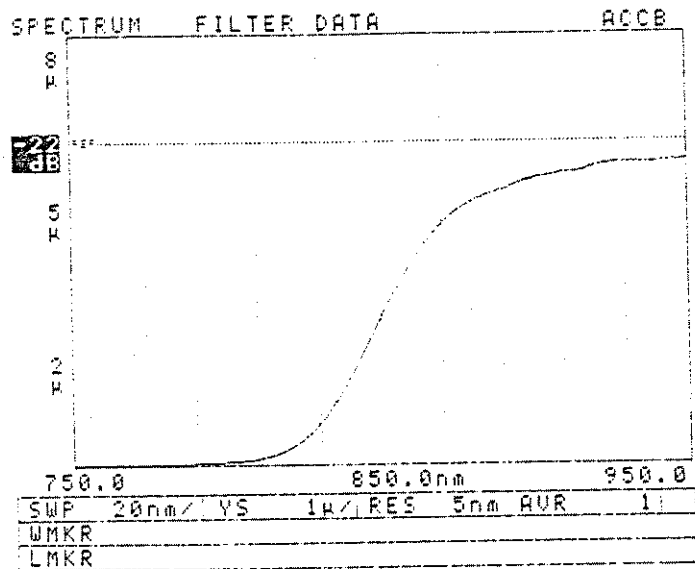

Fig. 3-50 Optical Filter Transmittance Measurement Setup



[Acc A] Switch Activated after Unfiltered Data Measurement

DATE 09.09.87
 TIME 17:12



[Acc B] Switch Activated after Filtered Data Measurement

DATE 09.09.87
 TIME 17:13

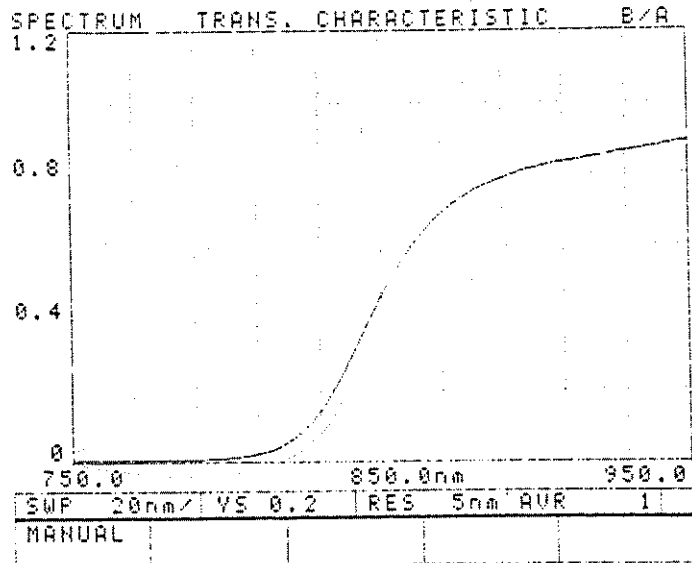

[B-A B/A] Switch Activated

Fig. 3-51 Optical Filter Transmittance Measurement Examples

3.5.18 Printer Operating Procedure

The AQ-6310B incorporates a printer that produces hard-copy printout of screen contents. Print mode selection (printer feed spacing) and date/time printing feature ON/OFF can be controlled with soft keys.

- (1) When the [COPY ON] switch is pressed during sweep stop periods, the currently displayed screen contents are printed onto the printer. That is, the screen contents prevailing upon switch activation are stored and printed out.
- (2) When the [COPY ON] switch is pressed, the screen display changes as indicated in Fig. 3-52. If the displayed date or time is to be changed at this time, press soft key <PAUSE> within about 1 second after [COPY ON] switch activation. When <PAUSE> is not pressed, the system concludes that there is no need of changing the data, starts printing about 1 second later, and, upon completion of printing, returns to the normal screen mode.
- (3) When the <PAUSE> key is pressed, the cursor appears on the screen as shown in Fig. 3-53 with the soft key menu changed. Move the cursor with the <←> key and turn the rotary knob to change the settings as desired.
- (4) When selecting the printing feed space or turning On or OFF the date/time printing feature, press the <ETC> key while the soft keys are conditioned as indicated in step (3). After soft key menu is changed, press the <NORMAL SPACE> key for printing of the standard feed space, and the <SAVE SPACE> key for printing of the narrower feed space, which is convenient for successive data acquisition.
Press the <DATE & TIME P ON> key for date/time printing feature ON, or the <DATE & TIME P OFF> key for date/time printing feature OFF. Note that either one of the two feed space keys and either one of the two date/time printing feature keys are latched and kept effective until their conditions are changed.

Fig 3.51 presents a date/time printout example.

- (5) When date/time change is completed in step (3), press soft key <CONT>. The system then starts printing, and returns to the regular screen mode upon completion of printing.
- (6) To halt an ongoing printing operation, press the [COPY ON] switch again.
- (7) The recording paper is fed while the [COPY FEED] switch is pressed.
- (8) When loading the recording paper, proceed as directed below.
 - (a) Open the cover located on the top plate of the AQ-6310B. Set the recording paper on the paper holder. Be sure to position the recording paper so that when its leading end is pulled outside, its outer side faces up.
 - (b) Place the head lift-up lever in the [FREE] position. Remove any residual paper from the head section. Thread the newly loaded (in step (a)) paper leading end between the paper guide and platen, and then advance the paper about 5 cm (see Fig. 3-54).
 - (c) Place the head lift-up lever in the [LOCK] position. Press the [FEED] switch until the recording paper leading end comes out of the top plate paper outlet.
 - (d) Close the top panel cover.
- (9) If the [COPY ON] switch is pressed with the head lift-up lever raised (it must be lowered after paper loading), the screen looks like Fig. 3-55. When such a condition occurs, open the top panel cover, lower the head lift-up lever, and press soft key <READY>. The system then returns to the state indicated in step (1). To return to the regular screen mode without lowering the head lift-up lever after the screen looks like Fig. 3-55, press the [COPY ON] switch again.
- (10) If the [COPY ON] switch is pressed with no recording paper remaining or the recording paper runs out during printing, the screen looks like Fig. 3-56 to prompt for recording paper loading. When such a condition exists, load new recording paper as directed in step (8) and press soft key <READY>. The system then returns to the state indicated in step (1). To

return to the regular screen mode without performing recording paper loading, press the [COPY ON] switch again.

NOTE: When the [COPY ON] switch is activated, battery backup is not provided for date/time display. Therefore, when the power is turned off, the date/time display system is deactivated, and when the power is turned back on, the date/time display system restarts. When accurate time information is needed, it is necessary to correct the displayed time after each power turn-on. It should also be noted that the date display operation is not controlled in perfect accordance with the calendar. Therefore, the displayed date needs to be corrected at the end of some months.

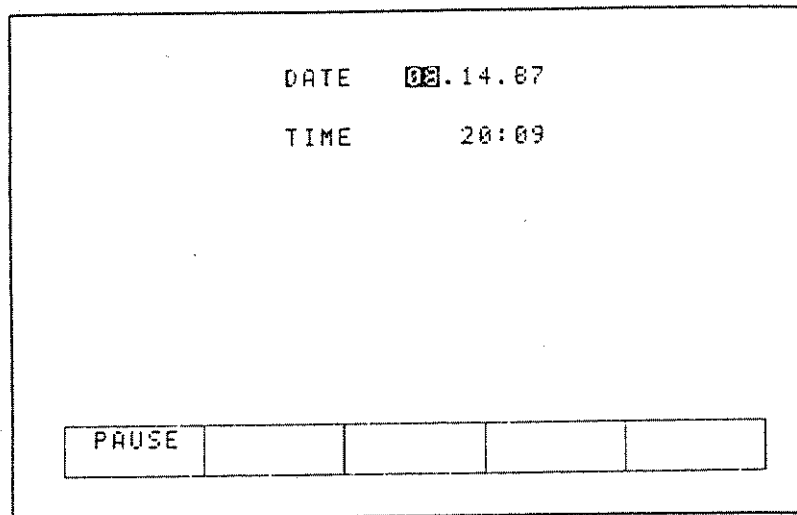

Fig. 3-52 [COPY ON] Switch Activated

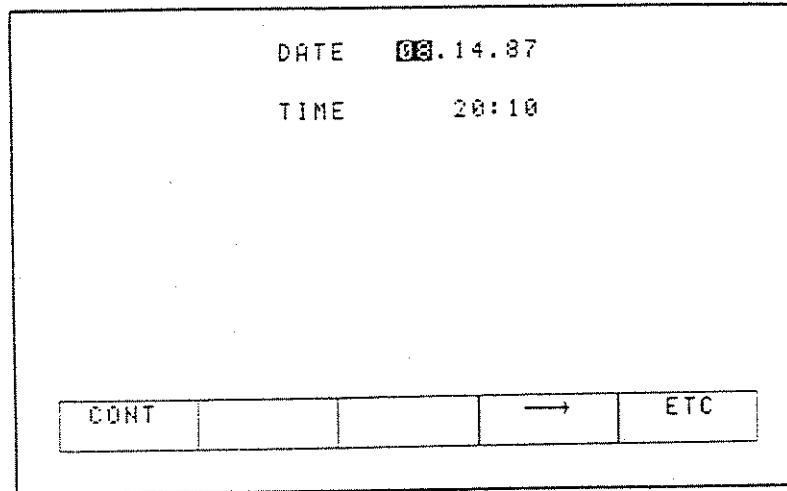

Fig. 3-53 <PAUSE> Key Pressed after [COPY ON] Switch Activation

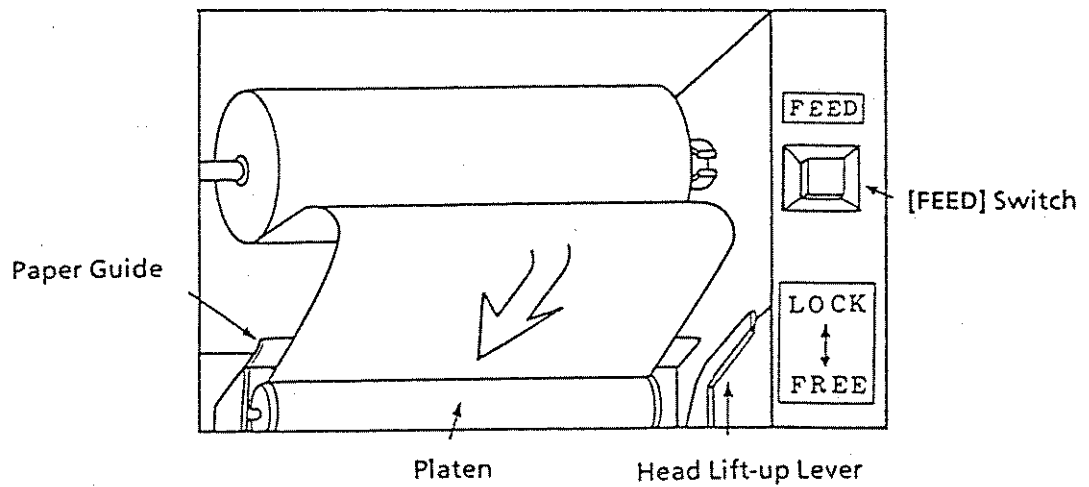

Fig. 3-54 Recording Paper Loading

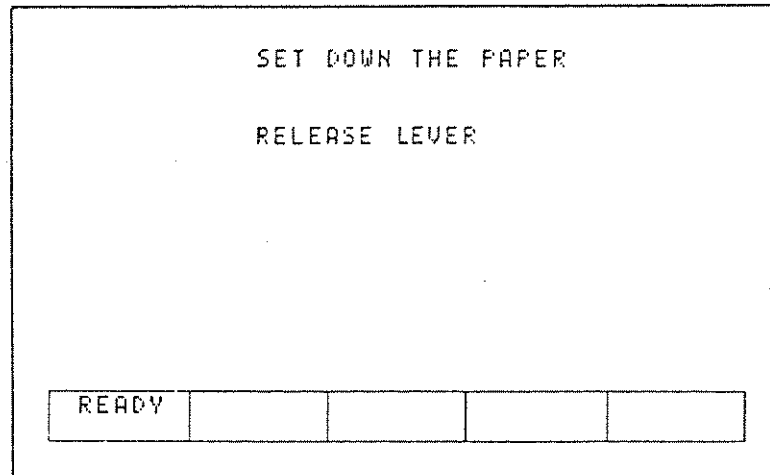

Fig. 3-55 [COPY ON] Switch Activated with Head Lifted Up

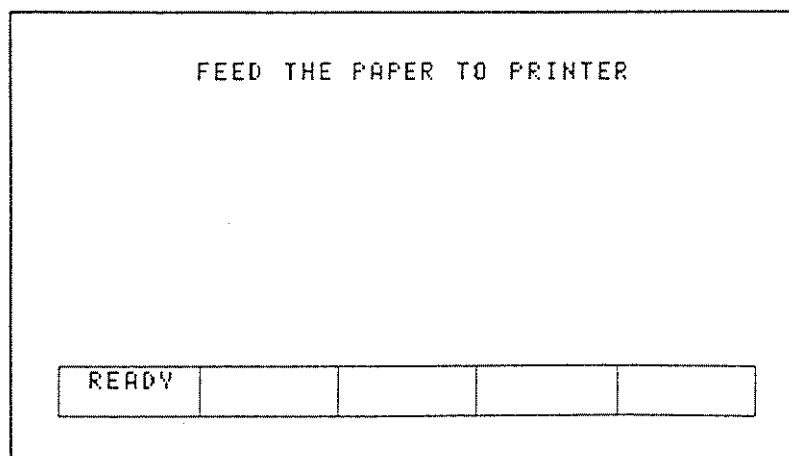
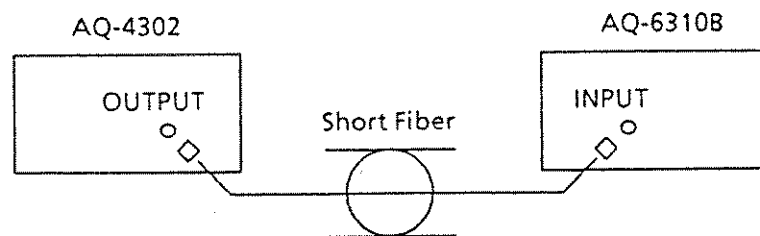

Fig. 3-56 [COPY ON] Switch Activated with No Recording Paper Loaded

3.5.19 Automatic Calibration by CALIBRATION Function

- (1) Connect the AQ-4302 He-Ne laser (option) to the AQ-6310B with a short fiber.
- (2) When the [CALIBRATION] (632.8 nm) switch is pressed during sweep stop periods, the switch lamp comes on and the following message and soft key menu appear on the CRT.
- (3) When soft key <START> is pressed, calibration is automatically effected to 632.8 nm. If the peak level is below -30 dBm, the associated ATTN number appears in the interrupt display area to indicate that the level is too low for calibration.
- (4) To stop an ongoing calibration, press the [CALIBRATION] (632.8 nm) switch again.
- (5) The calibration range is ± 5 nm. If the deviation is outside this range, calibration does not take place and the associated ATTN number appears on the CRT.
- (6) The CALIBRATION function can be executed only when no sweep operations are performed.



Automatic Calibration System

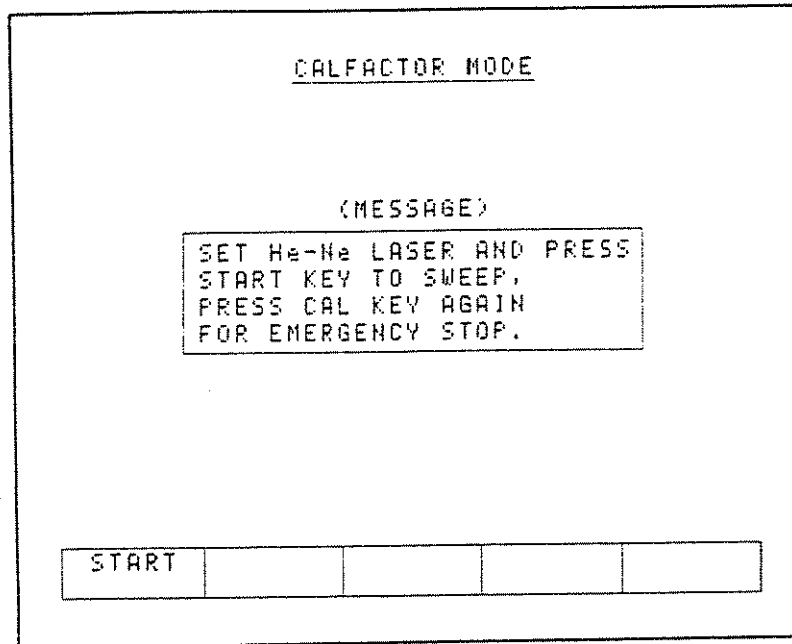

Screen Display Prevailing upon [CALIBRATION] (632.8 nm) Switch Activation

3.5.20 Comment Display by LABEL Function

- (1) When the [LABEL ON/OFF] switch is pressed during sweep stop periods, the switch lamp comes on, with the cursor and soft key menu appearing on the CRT.
- (2) Turn the rotary knob to move the cursor into a desired position within the label area.
- (3) Upon each switch activation, the green letter marking provided to the left of each switch appears in the uppermost area of the CRT. This letter marking indication position moves from left to right as the switches are pressed one by one.
- (4) When soft key <SHIFT> is pressed, the green letter marking indicated to the right of a switch takes effect only for the first switch pressed after <SHIFT> key activation.
- (5) For label deletion, press soft key <CLEAR>
- (6) When labeling is completed, press the [LABEL ON/OFF] switch, causing the switch lamp to go off. The system then returns to the normal mode.

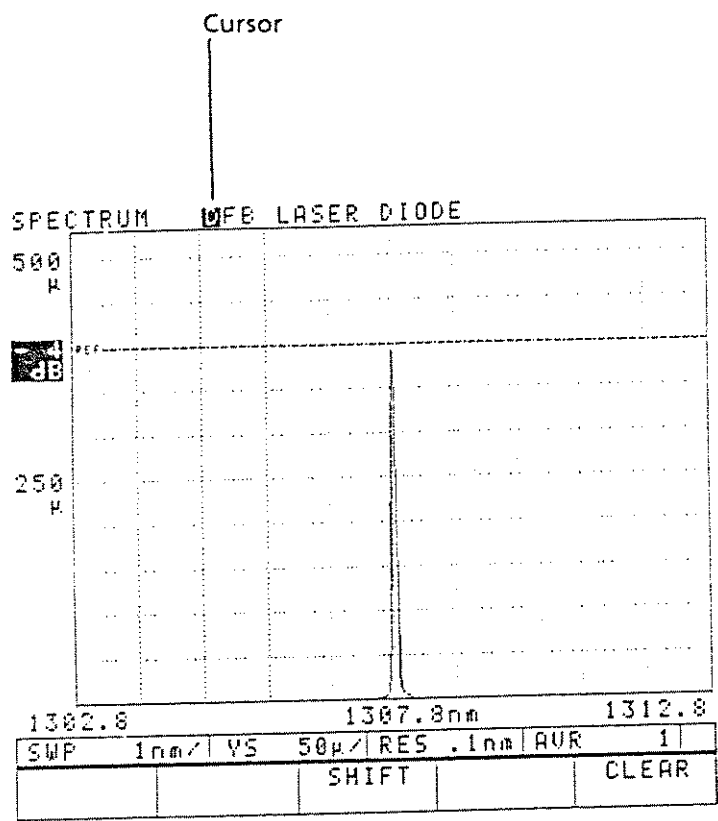

Fig. 3-57 LABEL Function Execution Example

3.5.21 Shutdown Procedure

- (1) Turn OFF the [POWER] switch.
- (2) Disconnect the [INPUT] connector and measurement cords from the apparatus.
- (3) Disconnect the power cord plug from the power source (wall outlet). Wind the power cord around the take-up foot on the rear side of the apparatus.

3.6 GP-IB Control

The AQ-6310B can be externally controlled using the GP-IB (conforming to the IEEE-488 bus standard). To exercise external control of the AQ-6310B, a controller is required. Connect a controller to the AQ-6310B with a GP-IB cord, and then turn ON the AQ-6310B [POWER] switch (13).

CAUTION

When connecting the GP-IB cord to the [GP-IB] connector (17), ensure that the [POWER] switch (13) is OFF, and that the bus system has completed handshaking.

3.6.1 Address Setup

- (1) For both the listen and talk address setup operations for the AQ-6310B, use the [GP-IB ADDRESS] switch. When this switch is pressed, the current address appears in the interrupt display area. Turn the rotary knob as required to obtain a desired address setting. Address settings of 0 through 30 are selectable.
- (2) When a listen address is transmitted from the controller to the AQ-6310B with REN and ATN set for "True", the AQ-6310B [GP-IB REMOTE] LED comes on.
- (3) When a talk address is transmitted to the AQ-6310B in the same manner, the AQ-6310B becomes a talker and transmits data. The latest measured data, marker values, and AQ-6310B current function information are to be transmitted. The data to be transmitted must be specified using the function codes listed in Table 3-2.

The talker formats are indicated in Table 3-3.

(4) The address setting is cleared when the following conditions exit.

Listener	IFC is "True".
		"Unlisten" command
		My talk address
Talker	IFC is "True".
		"Untalk" command
		My listen command
		Other talk address

3.6.2 Function Setup

(1) When data is transmitted in the formats indicated in Table 3-2 after the AQ-6310B has been designated as a listener by the controller, function or data setup can be achieved.

Example) To select a center wavelength of 1300 nm and a sweep width of 10 nm/div, the following procedure is performed.

CTR△WL1300, SWP△WD10 CR LF or EOI

(2) The function codes can be joined together using the symbol ",". The maximum acceptable number of characters except blanks is 512 (the CR, LF, and other control codes included). If this limit is exceeded, all transmitted codes are ignored.

(3) Blanks are all ignored so that they can be inserted as appropriate.

(4) Numerical value setup takes place when the values consist of no more than 8 digits (the decimal point excluded).

Example) RESOLN10 = RESOLN010 = RESOLN10. = RESOLN10.000

(5) The delimiter is either CR LF or EOI.

3.6.3 Measurement Start

Measurement starts when data transmission is effected in the formats indicated in Table 3-2 after the controller has designated the AQ-6310B as a listener.

Example) To make measurement by a single sweep, proceed as follows.

SGL CR LF or EOI

3.6.4 Measured Data Output

When the AQ-6310B is designated by the controller as a talker, measured data output takes place in the formats indicated in Table 3-3 immediately after completion of measurement.

Example) When the LOG scale is employed, proceed as follows.

DB△581, - 12.34, - 23.11,....., - 65.71 CR LF

(△: space)

3.6.5 Other Remote Messages

The following remote messages can be used with the AQ-6310B in addition to those presented in sections 3.6.1 through 3.6.4.

(1) GO TO LOCAL

When this command is received, the AQ-6310B can no longer be externally controlled, but can be controlled by the local front panel controls. When such a condition occurs, the AQ-6310B [GP-IB REMOTE] LED goes off.

Such a control status change can also be effected by setting REN to be "False".

This GO TO LOCAL function can also be executed with the [LOCAL] switch on the AQ-6310B.

NOTE

When the AQ-6310B is to be used in the remote mode after the [LOCAL] switch has been pressed to enter the local mode, designate the AQ-6310B as a listener and then follow the specified procedure.

(2) LOCAL LOCKOUT

When the [LOCAL] switch is pressed while the AQ-6310B is in the remote mode, the apparatus goes into the local mode. However, the [LOCAL] switch becomes inoperative after the apparatus has received the LOCAL LOCKOUT command. Once this command is received, it remains effective until REN is rendered "False" (the [LOCAL] switch does not take effect until REN becomes "False").

3.6.6 SRQ Function

The SRQ signal is transmitted when measurement is terminated or printer paper has run out. The STATUS byte is subsequently transmitted by controller serial polling. The STATUS byte contents are indicated in Table 3-4.

3.6.7 DC Function

When DCL or SDC is received, the AQ-6310B goes into the state that prevails immediately after power turn-on.

3.6.8 DT Function

Upon receipt of GET, the AQ-6310B performs the same operation as specified by function code SGL.

3.6.9 GP-IB Usage Precautions

- (1) When connecting the GP-IB cord to the [GP-IB] connector (17), be sure that the AQ-6310B is turned off, and that the bus system has completed handshaking.
- (2) After the system setup has been changed, clear the entire interface system before resuming operations.
- (3) When the AQ-6310B is connected to the GP-IB, the power must not be turned on or off unless handshaking is completed. This precaution must be observed whether the AQ-6310B is designated as a listener or talker. If this precaution is not followed, erroneous operations may occur because of noise generation, rendering the entire system inoperative.
- (4) The employed [GP-IB] connector (17) has 24 pins and conforms to the IEEE-488 bus standard. If an IEC-IB interface bus is to be employed, remember that it complies with the IEEE-488 bus standard, but requires the use of 25-pin connectors. The difference between the IEEE-488 and IEC-IB connectors is indicated in Fig. 3-58.

Table 3-2 Function Codes

No.	Category	Description	Data Format	Unit	Remarks
1	Center wavelength setup	400 to 1750	CENTER Δ WAVELENGTH ****.* or CTR Δ WL****.*	mm	(See note 1)
		Soft key <START WL> 400 to 1750	START Δ WAVELENGTH ****.* or STA Δ WL****.*		
		Soft key <STOP WL> 400 to 1750	STOP Δ WAVELENGTH ****.* or STP Δ WL****.*		
2	Sweep width setup	Setup on the /div basis 0.5, 1, 2, 5, 10, 20, 50, 100, 150	SWEEP Δ WIDTH****.* or SWP Δ WD****.*	mm	
		Setup on the SPAN basis 5, 10, 20, 50, 100, 200, 500, 1000, 1500	SWEEP:SPAN ****.* or SWP:SPAN****.*		
		Soft key <INTVL NORMAL>	SWEEP:INTVL Δ NORMAL or SWP:INTVL Δ NORM		
		Soft key <MEAS WL INTVL> 0.1, 0.2, 0.5, 1, 2, 5, 10, 20	SWEEP:INTVL*** or SWP:INTVL***		
		Soft key <SWEP TIME> SWP TIME MINIMUM, 1, 2, 5, 10, 20, 50	SWEEP: TIME** or SWP: T** In the case of SWP TIME MINIMUM, SWEEP: TIME Δ MINIMUM or SWP: T Δ MIN	sec	

Table 3-2 Function Codes (Continued)

No.	Category	Description		Data Format	Unit	Remarks	
3	Resolution setup	0.1, 0.2, 0.5, 1, 2, 5, 10		RESOLUTION **. * or RESOLN **. *	nm		
4	Reference level setup	HIGH SENSITIVITY		REFERENCE Δ LEVEL- ** or REF Δ LEV- **	dB		
		OFF	ON				
			H-SENS FAST				H-SENS SLOW
			0-49				0-60
5	Averaging times setup	1, 2, 5, 10, 20, 50, 100, 200, 500, 1000		AVERAGE **** or AVR ****	Number of averaging operations		
6	SENSITIVITY ON/OFF	ON	<H-SENS SLOW> The portion within square brackets ([]) can be omitted.	H-SENS:SLOW or HIGH			
			<H-SENS FAST>	H-SENS:FAST			
		OFF	<H-SENS OFF>	H-SENS:OFF or LOW			
7	AUTO sweep	AUTO ON The portion within square brackets ([]) can be omitted.		AUTO [:NORMAL]			
		AUTO OFF		AUTO:OFF			
8	REPEAT sweep	Soft key <SWEEP NORMAL> The portion within square brackets ([]) can be omitted.		REPEAT[:NORMAL] or RPT[:NORM]			
		Soft key <SWEEP MKR 1-2>		REPEAT:MARKER or RPT:MKR			

Table 3-2 Function Codes (Continued)

No.	Category	Description	Data Format	Unit	Remarks
8	REPEAT sweep	Soft key <WAIT> 1 to 59S, 1 to 59M 1 to 24H (Lower-case letters may be used for unit entry.)	REPEAT:WAIT Δ [***] or RPT:WAIT Δ [***]	sec, min, hr	
		Soft key <WAIT NORMAL>	REPEAT: WAIT Δ NORMAL or RPT:WAIT Δ NORM		
9	SINGLE sweep	Soft key <SWEEP NORMAL> The portion within square brackets ([]) can be omitted.	SINGLE[:NORMAL] or SGL[:NORM]		
		Soft key <SWEEP MKR1-2>	SINGLE:MARKER or SGL:MKR		
10	Sweep stop		STOP or STP		
11	Y-SCALE LOG setup	0.2, 0.5, 1, 2, 5, 10 (The value "10" is acceptable in the HIGH-SENSITIVITY- ON state only.)	YSCL**.*	dB	
12	Y-SCALE LIN setup		YSCL Δ LIN		
13	NORMALIZE setup		NORMALIZE or NORM		
14	DOMINANT setup		DOMINANT or DOMI		

Table 3-2 Function Codes (Continued)

No.	Category	Description	Data Format	Unit	Remarks
15	3D setup	-50, -40, -30, -20, -10, 0, +10, +20, +30, +40, +50, OFF When the portion within square brackets is omitted, a setting of -20 is automatically selected. If OFF is selected, the system returns to the normal screen mode.	3D[***]	deg	
		Soft key <CURRENT CLEAR>	3D: CURRENT Δ CLEAR or 3D: CUR Δ CLR		
		Soft key <ALL CLEAR>	3D: ALL Δ CLEAR or 3D: ALL Δ CLR		
16	Peak level search		PEAK Δ LEVEL or LPK Δ SRCH		
17	Peak wavelength search	*** = ON or OFF When the portion within square brackets is omitted, both the AUTO and CROSS operations are performed in the OFF state.	PEAK Δ WAVELENGTH (:AUTO***:CROSS***) or WPK Δ SRCH[:AUTO***: CROSS***]		
18	Half-width search	ENV method *: 3 or 6 When data in [] is omitted, 3 is set.	HALF-WIDTH Δ SEARCH[:ENV*] or HALF Δ SRCH[:ENV*]	dB	
		RMS method For ***, refer to NOTE 2. The data in [] may be omitted.	HALF-WIDTH Δ SEARCH:RMS[***] or HALF Δ SRCH:RMS[***]		NOTE 2
		Use soft key <THRESH **dB> **: 3, 6, 10, 15, or 20	HALF-WIDTH Δ SEARCH:THRESH** or HALF Δ SRCH:THRESH**	dB	

Table 3-2 Function Codes (Continued)

No.	Category	Description	Data Format	Unit	Remarks
19	Marker setup	Set the wavelength movement marker to the dot position *** on the wavelength axis. ***: 0 to 580	WMKR***		NOTE 3
		Set the level movement marker to the dot position *** on the level axis. ***: 0 to 368	LMKR***		
		Set the movement marker to marker 1.	MKRF		
		Set the movement marker to marker 2.	MKRS		
20	Marker clear		MARKER Δ CLEAR or MKR Δ CLR		
21	PEAK \rightarrow CENTER setup		CENTER = PEAK or CTR = PK		
22	MARKER \rightarrow CENTER setup		CENTER = MARKER or CTR = MKR		
23	PEAK \rightarrow REF LEVEL setup		REF Δ LEVEL = PEAK or REF Δ LEV = PK		
24	MARKER \rightarrow REF LEVEL setup		REF Δ LEVEL = MARKER or REF Δ LEV = MKR		
25	Δ W \rightarrow SPAN setup		SPAN = W		
26	DATA MEMORY selection	Acc A selection	MEMORY:A or MEM:A or REF		
		Acc B selection	MEMORY:B or MEM:B or MEAS		

Table 3-2 Function Codes (Continued)

No.	Category	Description	Data Format	Unit	Remarks
27	DATA MEMORY recall	Acc A recall	RECALL:ACCA or RCL:ACCA or RECALL Δ REF		
		Acc B recall	RECALL:ACCB or RCL:ACCB or RECALL Δ MEAS		
28	Data subtraction by DATA MEMORY	Acc A - Acc B in LOG scale mode	MEMORY:A-B or MEM:A-B or LOSS		
		Acc A / Acc B in LIN scale mode	MEMORY:A/B or MEM:A/B		
		Acc B - Acc A in LOG scale mode	MEMORY:B-A or MEM:B-A or TRANS.M		
		Acc B / Acc A in LIN scale mode	MEMORY:B/A or MEM:B/A or TRANS.M		
29	DATA MEMORY Y-axis scale setup	Executable after data subtraction AccA-AccB or AccB- AccA with the soft key <Y SCALE> in LOG scale mode 0.2, 0.5, 1, 2, 5, 10	MEMORY: YSCALE**.* or MEM: YSCL**.*	dB	
		Executable after data subtraction AccA/AccB or AccB/AccA with the soft key <Y SCALE> in LIN scale mode See (NOTE 3).	MEMORY: YSCALE** or MEM: YSCL**		NOTE 4
		Executable after data subtraction AccA-AccB or AccB- AccA with the soft key <Y OFFSET> in LOG scale mode Setup in 1 dB units	MEMORY: YOFFSET*** or MEM: YOFS***	dB	
30	Waveform clear		GRAPH Δ CLEAR or CLR		
31	MEMORY selection	* = 0 to 9, A to F	SAVEM:*		
32	MEMORY recall	* = 0 to 9, A to F	RECALL:* or RCL:*		

Table 3-2 Function Codes (Continued)

No.	Category	Description	Data Format	Unit	Remarks
33	Printer operation	Printing start	PRINTER△ON or PR△ON		
		Ongoing printing stop	PRINTER△OFF or PR△OFF		
		About 40 mm recording paper feed	PRINTER△FEED or PR△FEED		
		Printing with the printer space in NORMAL mode.	PRINTER △ ON: NORMAL △ SPACE or PR △ ON: NORM △ SP		
		Printing with the printer space in SAVE mode	PRINTER △ ON: SAVE △ SPACE or PR △ ON: SAVE △ SP		
		Printing with date/time printout	PR △ ON: DTPON		
		Printing without date/time printout	PR △ ON: DTPOFF		
34	Date/time setup	Date setup **,**,** = month/day/year	DATE**,**,**		
		Time setup **,** = hour/minute	TIME**,**		
35	Label setup	**...** = comment consisting of no more than 25 characters	LABEL '**...**' or LBL '**...**'		NOTE 5
36	Label clear		LABEL: CLEAR or LBL :CLR		
37	Request for service request output	ON	EI		NOTE 6
		OFF	DI		
38	Request for measured data output	** = measurement point The leftmost end of the graph is 1 and the rightmost end is 581. R1-R581 if the portion within square brackets is omitted	DDATA△[R***-R***]		NOTE 7 NOTE 8 NOTE 9

Table 3-2 Function Codes (Continued)

No.	Category	Description	Data Format	Unit	Remarks
39	Request for memory data output	Request for MEMORY (0 to 9 and A to F) data * = 0 to 9, A to F The portion within square brackets is the same as indicated under No. 36.	DMEM* Δ [R***-R***]		
		Request for Acc A data The portion within square brackets is the same as indicated under No. 36.	DMEM Δ ACCA Δ [R***-R***] or DREF Δ [R***-R***]		
		Request for Acc B data The portion within square brackets is the same as indicated under No. 36.	DMEM Δ ACCB Δ [R***-R***] or DMEAS Δ [R***-R***]		
40	Request for marker position data output	The marker value set up as indicated under Nos. 16 through 18 is transferred out.	MARKER or MKR		
41	Request for FUNCTION information output		STATE		

NOTE 1: As is the case with manual setup, the acceptable stop wavelength setting = start wavelength + sweep width (SPAN). If the specified wavelength value does not satisfy the above equation, the system ignores such a value.

NOTE 2: Selection of a value to be set in *** is made as follows.

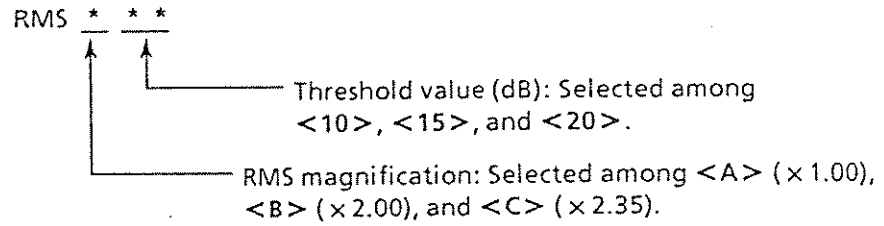

When *** is omitted, A20 is set.

When only the threshold value is omitted, 20 dB is set as the threshold.

NOTE 3: The dot arrangement on the CRT is as follows.

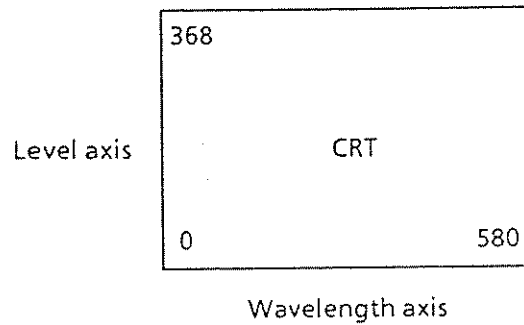

NOTE 4: In LIN mode, specify ** in accordance with the table shown below.

**	No. of div.	Scale per div.
△1	8	0.5
△2	6	0.5
△3	8	0.2
△4	6	0.2
△5	8	0.1
△6	6	0.1
△7	8	50E-3
△8	6	50E-3
△9	8	20E-3
10	6	20E-3
11	8	10E-3
12	6	10E-3

NOTE 5: Only the label characters (A-Z, 0-9, +, -, *, /, =, >, <, ., ,, : , ; , and space) are acceptable. The other characters are treated as blanks when displayed. Further, when the command is executed while a label is set up on the screen, the system deletes a previously displayed label and displays a newly selected label instead. When 25 or fewer characters are displayed, they are centered. However, if a space is put in front of a comment, the comment will not be centered but left-justified.

NOTE 6: When the power is turned on or the device clear signal is received, the setup is for DI.

NOTE 7: In the DDATA state, data transfer does not take place until measurement is terminated. Further, once data transfer has started, the system does not proceed to the next measurement until the transfer is completed. If ongoing transfer is to be stopped, execute IFC.

NOTE 8: The output data setup remains effective until it is updated. When the power is turned on, the setup is for DDATA.

NOTE 9: After DATA MEMORY data subtraction command execution (No. 27), the data derived from subtraction is to be transmitted.

Table 3-3 Talker Formats

No.	Category	Format	
1	DATA	LOG	DB Δ number of data, data,, data <u>CR</u> <u>LF</u> Number of data 1 to 581 Data format \pm ***.**
		LIN	AccA/AccB or AccB/AccA display state LN Δ number of data, data,, data <u>CR</u> <u>LF</u> Number of data 1 to 581 Data format *.**** Data 0 to 4
		Other display states	LN Δ number of data, data,, data <u>CR</u> <u>LF</u> Number of data 1 to 581 Data format **.*** Data 0 to 10
2	MARKER	Level marker LOG	MARKER Δ LOG Δ <u>data</u> , <u>data</u> , <u>data</u> <u>CR</u> <u>LF</u> Marker Marker 1 Marker 2 Data format \pm ***.**
		Level marker LIN	MARKER Δ LIN Δ <u>data</u> , <u>data</u> , <u>data</u> <u>CR</u> <u>LF</u> Marker Marker 1 Marker 2 Data format $0 \leq$ ***.** \leq 10 The data value is determined relative to a REF LEVEL of 1.
		Wave-length marker	MARKER Δ WAVE Δ <u>wavelength value, data point</u> , Marker <u>wavelength value, data point, wavelength value, data point</u> <u>CR</u> <u>LF</u> Marker 1 Marker 2 If the values are not specified, the associated portions are treated as blanks. Data format ****.**,**
3	STATE	STATE $\Delta\Delta$ CTR Δ WL****.**, SWP Δ WD****.**, RESOLN****.**, REF Δ LEV-**, AVR****.**, YSCL****.**, HIGH <u>CR</u> <u>LF</u> (YSCL Δ LIN)(LOW Δ)	

Table 3-4 STATUS Contents

Bit	Bit Contents Description
D8	0
D7	SRQ signal is transmitted.
D6	0
D5	0
D4	0
D3	Monochromator has become abnormal.
D2	Printer paper has run out.
D1	Measurement is terminated.

Table 3-5 AQ-6310B Interface Construction

Category	Code	Remarks
Source (transmission) handshake	SH1	All SH functions are provided.
Acceptor (reception) handshake	AH1	All AH functions are provided.
Talker	T6	Basic talker Serial polling Talker clear by MLA
Listener	L4	Basic listener Listener clear by MTA
Remote local	RL1	Local lockout function is provided.
Service request	SR1	All SR functions are provided.
Parallel polling	PP0	No PP function is provided.
Device clear	DC1	All DC functions are provided.
Device trigger	DT1	All DT functions are provided.
Controller	CO	No CO function is provided.

Connector Shape	Pin No.	Signal Name	Pin No.	Connector Shape
(Male)	1	DIO 1	1	(Female)
	2	DIO 2	2	
	3	DIO 3	3	
	4	DIO 4	4	
	5	REN	17	
	6	EOI	5	
	7	DAV	6	
	8	NRFD	7	
	9	NDAC	8	
	10	IFC	9	
	11	SRQ	10	
	12	ATN	11	
	13	Cable shield	12	
	14	DIO 5	13	
	15	DIO 6	14	
	16	DIO 7	15	
	17	DIO 8	16	
	18	Ground	18	
	25	Ground	24	
IEC-IB				IEEE-488

Fig. 3-58 Bus Line Description and Connector Difference

3.7 ATTENTION Display Function

The AQ-6310B causes the interrupt display area to give an indication in the form of "ATTN **" (** = any number between 0 and 37) when an inoperative switch is pressed during operation, forced setup condition change is effected by switch activation, or a switch-specified operation cannot be executed because of unacceptable conditions. Various numbers (0 through 37) are attached to the ATTN indication to show the cause of ATTN condition occurrence. These ATTN numbers are classified and defined in Tables 3-6 through 3-8.

(1) An Inoperative Switch Was Pressed

Table 3-6 ATTN Indications No. 0 to 10

No.	Cause
0	An inoperative switch was pressed during sweep operation.
1	An inoperative switch was pressed during 3-D display sweep operation.
2	An inoperative switch was pressed while 3-D display sweep operation was stopped.
3	The [MARKER→CENTER] or [MARKER→REF LEVEL] switch was pressed although marker setup was not performed.
4	Soft key <SWEEP MKR1-2> was pressed although wavelength markers 1 and 2 were set outside the preselected measurement range or not set up at all.
5	An inoperative switch was pressed while sweep was being conducted between markers 1 and 2.
8	A switch other than label character switches 0 through 9 or A through F was pressed after [SAVE] switch activation.
9	The [RECALL] and [*] switches were pressed when no waveform was stored in memory * (* = 0 through 9, A through F, Acc A, or Acc B).
10	The [PEAK→REF LEVEL] or [MARKER→REF LEVEL] switch was pressed after waveform update was implemented by [A-B A/B], [B-A B/A], [NORMALIZE], or [DOMINANT] switch activation.

(2) Setup Conditions Were Changed by Switch Activation

Table 3-7 ATTN Indications No. 21 to 27

No.	Cause
21	When the center wavelength or sweep width was changed at a resolution setting of 10 nm, the range of 400 to 539.9 nm was included in the sweep range so that the resolution was changed to 5 nm.
22	The Y scale is changed to 5 dB/div because the measurement sensitivity is changed to <H-SENS OFF> while the Y scale is being swept at 10 dB/div by <H-SENS SLOW> or <H-SENS FAST>.
23	The averaging times setting is changed to 1 because the measurement sensitivity is changed to <H-SENS OFF> during sweep at 2 by <H-SENS SLOW> or <H-SENS FAST>.
24	The reference level is changed to a acceptable value because the reference level becomes an unacceptable value in response to a change in measurement sensitivity during sweep.
25	The averaging times setting is changed to 100 because the measurement sensitivity is changed to <H-SENS SLOW> or <H-SENS FAST> during sweep at 200 or more by [H-SENS OFF].
26	Problems 23 and 24 above occur at the same time because the measurement sensitivity is changed from <H- SENS SLOW> or <H-SENS FAST> to <H-SENS OFF>.
27	The Y scale is changed because the lowest Y axis scale mark is smaller than -99 dB when the reference level is changed in the LOG scale.

(3) A Switch-specified Operation Could Not Be Executed because of Unacceptable Conditions

Table 3-8 ATTN Indications No. 31 to 37

No.	Cause
31	As the Acc A and Acc B did not agree in center wavelength, sweep width, and resolution for waveform measurement when the [A-B A/B] or [B-A B/A] switch was pressed, the data subtraction display function was not executed.
32	Half-width search was not conducted upon [Δ W→SAPAN] switch activation.
33	Although the [CALIBRATION (632.8 nm)] switch was pressed to start automatic wavelength calibration, the intended calibration was not effected because the input level was too low or the wavelength error was greater than ± 5 nm.
34	Although the [PEAK→CENTER] or [PEAK→REF LEVEL] switch was pressed, the peak value was not set as the center wavelength or reference level.
35	Although the [MARKER→CENTER] or [MARKER→REF LEVEL] switch was pressed, the marker value was not set as the center wavelength or reference level.
36	As the peak value was too small, normalization was not effected upon [NORMALIZE] switch activation.
37	Visual sensitivity correction was not made upon [DOMINANT] switch activation.
38	Although the [A-B A/B], [B-A B/A], [NORMALIZE], or [DOMINANT] switch was pressed to rewrite a waveform and then [HALF-WIDTH SEARCH] was pressed, the specified operation was not performed.
39	Although [HALF-WIDTH SEARCH] was pressed during sweep with the indication on the screen exceeding the measurement wavelength range (380 to 1770 nm), the specified operation was not performed.

NOTE: All the above-listed ATTN indications go off when the sweep or other function switch is pressed.

3.8 Video Interface

The composite video signal output is delivered to the [VIDEO OUT] terminal on the rear panel. This output signal is the same as that provided for CRT display purposes, as indicated in Fig. 3-59.

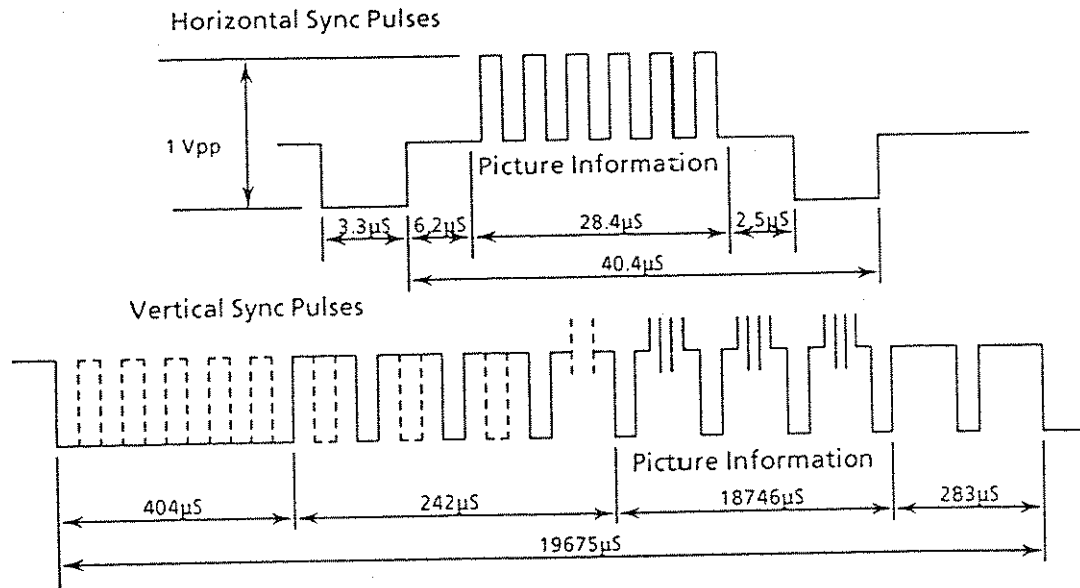

Fig. 3-59 Output Video Signal

When a video plotter matching the above indicated terminal and output video signal is hooked up to the AQ-6310B, it is easy to obtain hard-copy printout of CRT screen contents.

Video plotter recording examples are presented in Fig. 3-4 and other figures.

Further, when the AQ-6310B is connected to a monitor TV that is compatible with the above indicated output video signal, it is possible to watch the AQ-6310B CRT screen contents on the monitor TV. Note that the monitor TV to be used must have a video signal band of 25 MHz or higher frequencies.

Before producing hard-copy printout of AQ-6310B CRT screen contents, it is necessary to make video plotter adjustment as directed below.

Turn ON only switch 1 of the video plotter rear panel DIP switch; be sure that the other switches are OFF. Adjust trimmers VR1 through VR3 and slide switches 1 through 3 as indicated in Fig. 3-60. The adjustment must be nearly complete now. However, satisfactory image quality may still not result because there are inherent errors in individual plotters. If such a condition is encountered, make fine adjustment of trimmers VR1 to VR3 as indicated in Fig. 3-61.

The plotters supplied with the AQ-6310B have been optimally adjusted at factory prior to shipment; therefore, do not tamper with the trimmers on such plotters.

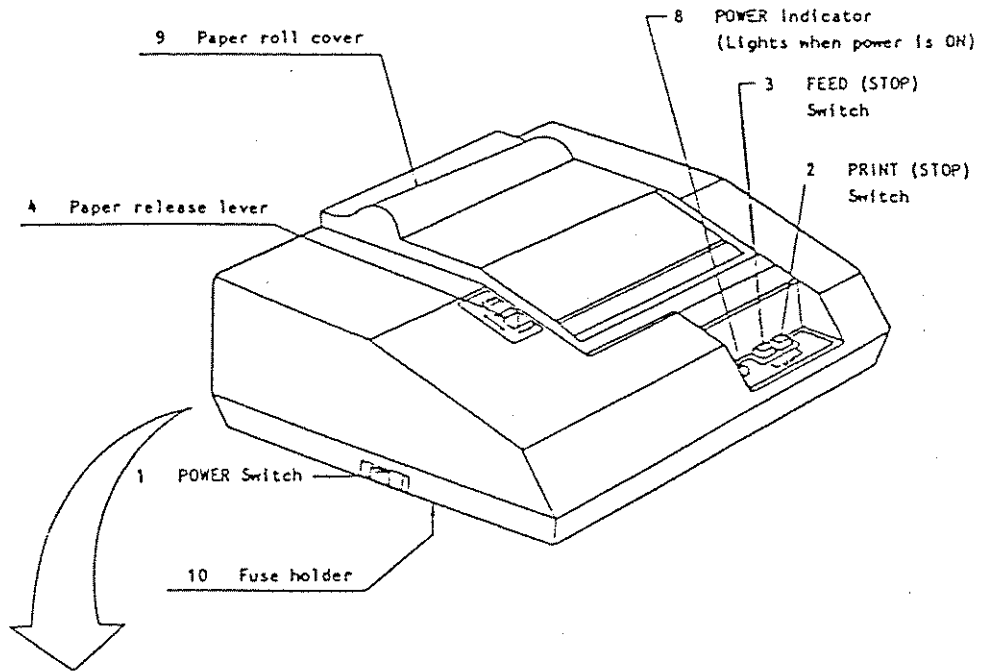

Rear Panel

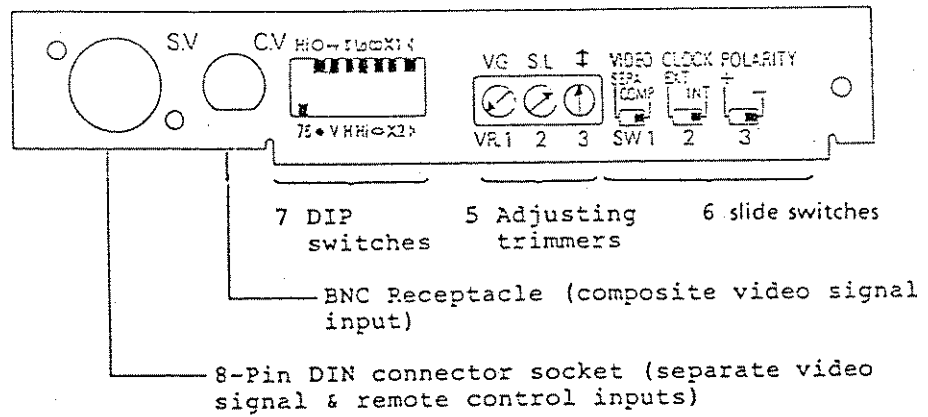

Fig. 3-60 Video Plotter Adjustment

VR1	Gain adjustment
VR2	Print image density adjustment
VR3	Print image aspect ratio adjustment

Fig. 3-61 Fine Adjustment

3.9 Abbreviations

The abbreviations displayed on the CRT have the following meanings.

Table 3-9 Abbreviation List

Abbreviation	Meaning
ACC	Accumulator
ATTN	Attention
AVR	Averaging Times
A-B	Accumulator A-Accumulator B
CAL	Calibration
CONT	Continue
CROSS	Cross Marker
CTR WL	Center Wavelength
DEG	Degree
DOM	Dominant
ENV	Envelope
F	High Sensitivity Fast
INTVL	Interval
LIN	Linear Scale
LMKR	Level Marker
MEAS	Measure
MEM	Memory
NORM	Normalize
P OFF	Printer Off
P ON	Printer On

Table 3-9 Abbreviation List (Continued)

Abbreviation	Meaning
RCL	Recall
REF	Reference Level
REF LEV	
RES	Resolution
RESOLN	
S	High Sensitivity Slow
SWP	Sweep Width
SWP WD	
THRESH	Threshold
WMKR	Wavelength Marker
YS	Y-Scale
3D	3-Dimension
m	10^{-3}
μ	10^{-6}
n	10^{-9}
p	10^{-12}

3.10 Measuring Precautions

3.10.1

Of lights diffracted by the grating only the primary light is usually used. Being designed to permit measurement with wider range, higher sensitivity, and finer resolution, this unit provides for selective use of the primary, secondary, or tertiary light according to the wavelength chosen. With this unit the spectrum therefore appears at particular points determined by wavelengths other than the actual source wavelength. For example, in cases where measurement is made with the secondary light the primary and tertiary light waveforms also appear with the secondary light waveform.

The division of light is shown in Fig. 3-62. This figure indicates at which wavelength the spectrum appear elsewhere than the actual source wavelength.

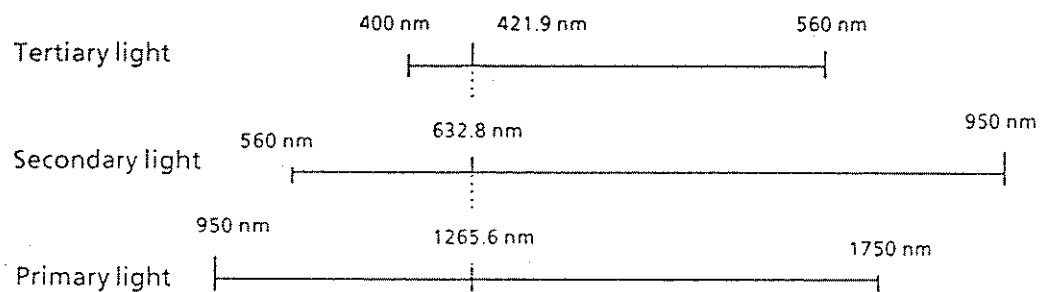

Fig. 3-62

For example, assume that He-Ne is launched at 632.8 nm. In this case while measurement is made with the secondary light as shown in Fig. 3-62, spectra also appear at 421.9 nm for the tertiary light and at 1265.6 nm for the primary light. Also when light is launched at 421.9 nm and 1265.6 nm, spectra appears at 421.9, 632.8, and 1265.6 nm.

However, when light is launched into the tertiary or secondary light the primary light is substantially reduced in level depending on the effect of cut filters, grating diffraction efficiency, and sensor response. Similarly, when the light is launched into the primary light, the secondary or tertiary light is reduced in level to a considerable extent.

It is possible to determine at which point a spectrum appears when each divided light is launched, using the data of (1), (2), and (3) shown below.

(1) 400 to 560 nm

$$\lambda, \frac{4}{3}\lambda, \frac{3}{2}\lambda, 2\lambda : (\text{When } \frac{4}{3}\lambda > 560 \text{ nm, however, no spectrum appears at } \frac{4}{3}\lambda)$$

(2) 560 to 950 nm

$$\frac{2}{3}\lambda, \lambda, \frac{3}{2}\lambda, 2\lambda : (\text{When } \frac{3}{2}\lambda > 950 \text{ nm, however, no spectrum appears at } \frac{3}{2}\lambda)$$

(3) 950 to 1750 nm

$$\frac{1}{3}\lambda, \frac{1}{2}\lambda, \lambda$$

To obtain best results it is well to remember the characteristics above of this unit.

When measurements for loss wavelength characteristics or transfer characteristics are made over a range of 700 to 1700 nm, the AQ-4303B is used with the white light source in the wavelength range of 700 to 1000 nm. The filter built in the white light source cuts the high-order light, thereby permitting accurate measurements without any problem. (See 3.5.17.)

This unit provides for measurement throughout a range of 700 to 1700 nm, using white light source wavelength over a 700 to 1000 nm range. This is because the AQ-4303B cuts the wavelength of 700 nm or less but passes the light of 1000 nm or longer wavelength. Conventional spectroscopes pass light of integral multiples of a certain wavelength so that when they are used over a wavelength range of 1000 nm or more, they must be set in the range of 1000 to 1800 nm. This unit, however, eliminates the need of such settings because it contains the filter to cut high-order light on the longer-wavelength side.

When 1700 nm or longer wavelength measurements are to be made, set the AQ-4303B for a wavelength range of 1000 to 1800 nm. When this wavelength range setting is employed, wavelengths of 1000 to 1750 nm can be covered.

Figs. 3-63 to 3-65 show how waveforms appear when light sources satisfying the above three conditions are measured.

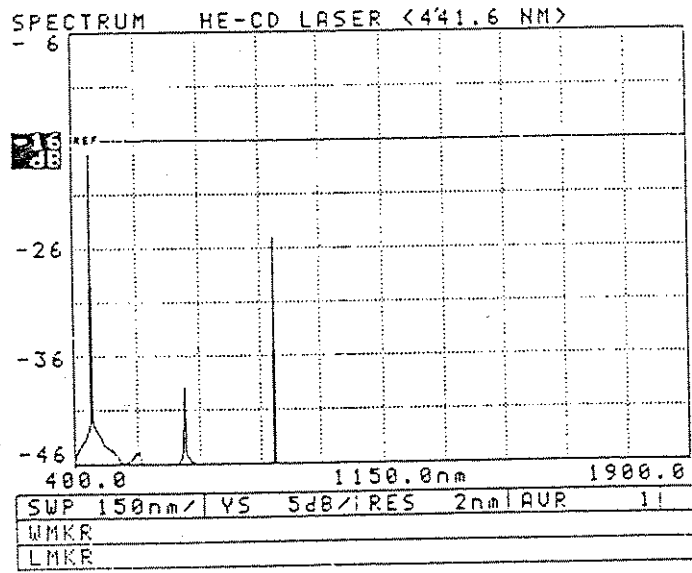

Fig. 3-63 $\lambda = 441.6 \text{ nm}$

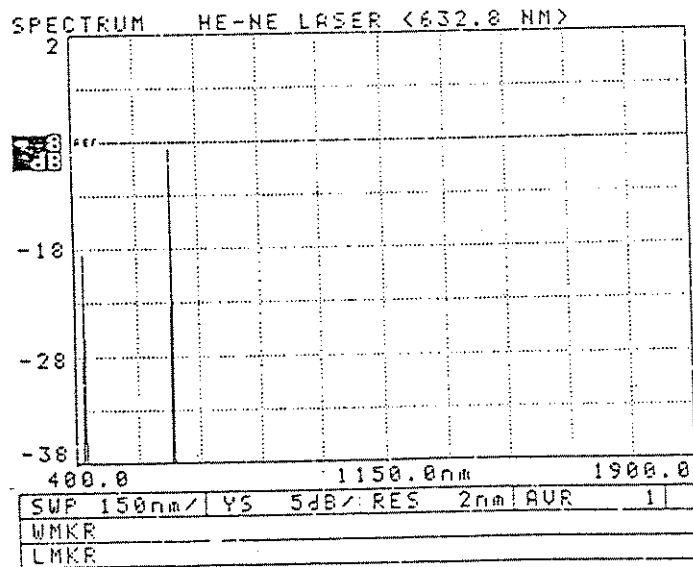

Fig. 3-64 $\lambda = 632.8 \text{ nm}$

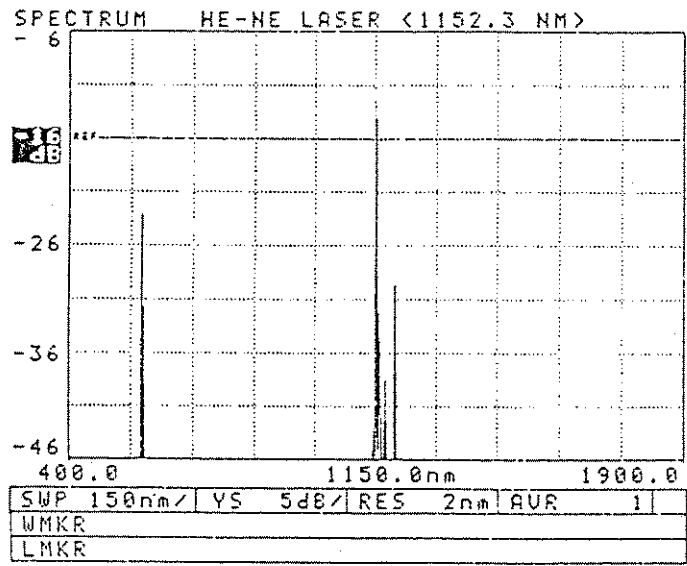

Fig. 3-65 $\lambda = 1152.3 \text{ nm}$

3.10.2 Spectroscope Construction and Principle

The construction and principle of the spectroscope and the reason why the phenomenon mentioned above occurs are described below.

- (1) The spectroscope of the apparatus is a Czerny Turner monochromator that employs a diffraction grating.

Fig. 3-66 shows the principle of operation of the Czerny Turner monochromator.

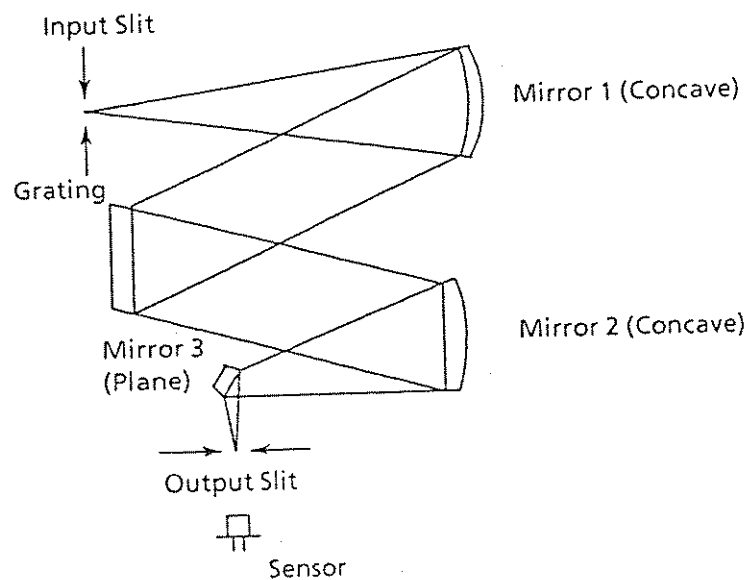

Fig. 3-66 Principle of Czerny Turner Monochromator

The light from the point light source at the input end is converted into parallel rays by mirror 1. These rays fall upon the grating which diffracts the rays of light according to their wavelength. The light diffracted by the grating is reflected by mirror 2 and mirror 3, passed through the output slit, and received by the sensor.

In general, only the primary light out of the diffracted rays from the grating is used for measurement. However, this apparatus uses the secondary and third in addition to the primary to widen the measurement band and speed up the measurement.

For this reason, when light to be measured with the secondary is injected, the primary and third appears at the output in addition to the secondary, so that waveforms for the primary and third appear besides the waveform at the actual wavelength.

However, waveforms appearing at wavelengths other than the actual wavelength can be easily distinguished as their levels are low because of the low grating diffraction efficiency and cut fiber action.

- (2) Principle of generation of primary, secondary, third, ... , and nth light by the grating

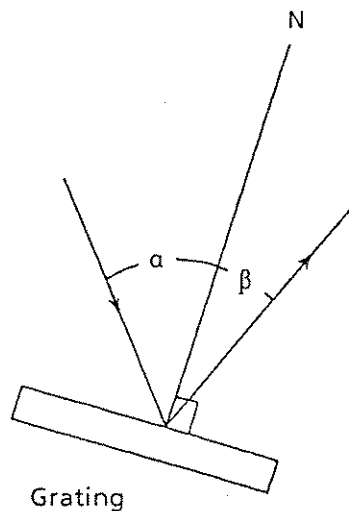

Fig. 3-67 Grating

As shown in Fig. 3-67, when light whose wavelength is λ falls upon the grating at an angle of α with respect to the normal, the relationship between the wavelength, incident angle, and outgoing angle is expressed by the following formula.

$$m\lambda = D(\sin\alpha \pm \sin\beta) \quad \text{--- Grating basic formula}$$

where $m = 0, 1, 2, 3, \dots$ (degree)

$\lambda =$ wavelength

$D =$ grating constant

$\alpha =$ incident angle

$\beta =$ outgoing angle

Setting the right hand side of the formula to λ_0 , we have

$$m\lambda = \lambda_0, \quad \lambda = \frac{\lambda_0}{m}$$

When a wavelength of λ_0 is injected, m th light appears at $\lambda = \lambda_0, \frac{\lambda_0}{2}, \frac{\lambda_0}{3}$ for $m = 1, 2, 3, \dots$

For example, at $\lambda_0 = 1500$ nm, secondary and third light appear at 750 nm and 500 nm, respectively.

Since this apparatus measures wavelengths lower than 560 nm with the third light, wavelengths between 560 nm and 950 nm with the secondary, and wavelengths higher than 950 nm with the primary, waveforms appear at the wavelengths shown in Section 3.10.1, according to the above formula.

SECTION 4 CIRCUITRY AND CONSTRUCTION

4.1 Introduction

This section outlines the circuitry and construction of the AQ-6310B.

4.2 Circuitry

4.2.1 Circuitry Overview

The AQ-6310B converts the monochromator output light (consisting of isolated narrow portions of the spectrum) to electrical signals, and amplifies such signals in the input amplifier circuit. The output voltage from this circuit is subjected to A/D conversion and transferred on the data bus. The CPU circuit receives, processes, and feeds the data to the image control circuit so that the data is used for CRT Y-axis display. In such processing sequences, the wavelength sensitivity characteristics of the sensor and other devices are corrected and multiplied to suit the scale. On the other hand, the wavelengths related to the X-axis are monitored by counting the pulses fed to the DC servomotor.

4.2.2 Individual Circuit Descriptions

(1) Input Amplifier Circuit (PRE-200784)

The input light is converted to electrical signals by the sensor mounted on the monochromator, and then amplified in accordance with the preselected reference level.

(2) CPU Circuit I (PRE-407698)

This circuit contains ROMs, RAMs, and 16-bit CPU to exercise control over the entire system and carry out data processing.

(3) CPU Circuit II (PRE-407699)

This circuit contains ROMs, RAMs, and 16-bit CPU, and mainly provides control over the monochromator section.

(4) CPU Circuit III (PRE-408586)

This circuit contains ROMs, RAMs, and 16-bit CPU, and mainly controls image processing operations.

- (5) A/D Conversion Circuit (PRE-906388)
This circuit is divided into a signal A/D converter and a high-sensitivity measurement circuit. The high-sensitivity measurement circuit consists of a synchronous detector and a low-pass filter.
- (6) A/D Conversion Control Circuit (PRE-407702)
This circuit generates the timing for A/D conversion.
- (7) Image Control Circuit (PRE-407701)
The CRT control LSI provides CRT display in accordance with the instructions from the CPU III.
- (8) Unit Drive Circuit (PRE-407703)
This circuit provides control of the monochromator section in accordance with the instructions from the CPU II.
- (9) KEY/GP-IB Circuit (PRE-407700)
This circuit monitors the panel switches and rotary encoder, and causes the panel LEDs to come on as needed. It also contains a GP-IB controller.
- (10) Keyboard Circuit (PRE-906389)
This circuit consists of the front panel switches, LEDs, and rotary encoder.
- (11) Soft Key Circuit (PRE-906396)
This circuit consists of the soft key switches and LEDs located on the lower end of the CRT.
- (12) Motor Drive Circuit (PRE-407705)
This circuit drives the resolution setup motor.
- (13) Printer Circuit (PRE-407704)
This circuit contains RAMs and 8-bit one-chip CPU to exercise control over the printer operations.
- (14) Printer Hookup Circuit (PRE-906506)
This is the junction circuit for connecting the printer to the printer circuit (13).
- (15) Motherboard Circuit (PRE-906395)
This circuit interconnects PC board terminals.

4.3 Construction

The AQ-6310B external views are presented in Attached Drawings ASD-61873-1 1/3 through 3/3.

SECTION 5 MAINTENANCE

5.1 Introduction

This section describes the pre-operational checkout and mechanical inspection which are performed to verify the normal operations of the AQ-6310B. If any abnormality is found, however, proceed as indicated in sections 2.3 and 2.4.

5.2 Pre-operational Checkout

The AQ-6310B performs internal memory checkout upon power turn-on. If any abnormality is detected, the system stops its operations and displays the message "***** CHECK ERROR" appears at the center of the CRT screen (***** = ROM, RAM, NVRAM, DROM, OROM, DPRAM1, or DPRAM2).

5.3 Mechanical Inspection

Visually check the operating controls, connectors, and other assembled parts exposed to view to ensure that they are free of damage and deformation. Also check them for looseness or rough movement to be sure that their mechanical performance is normal.

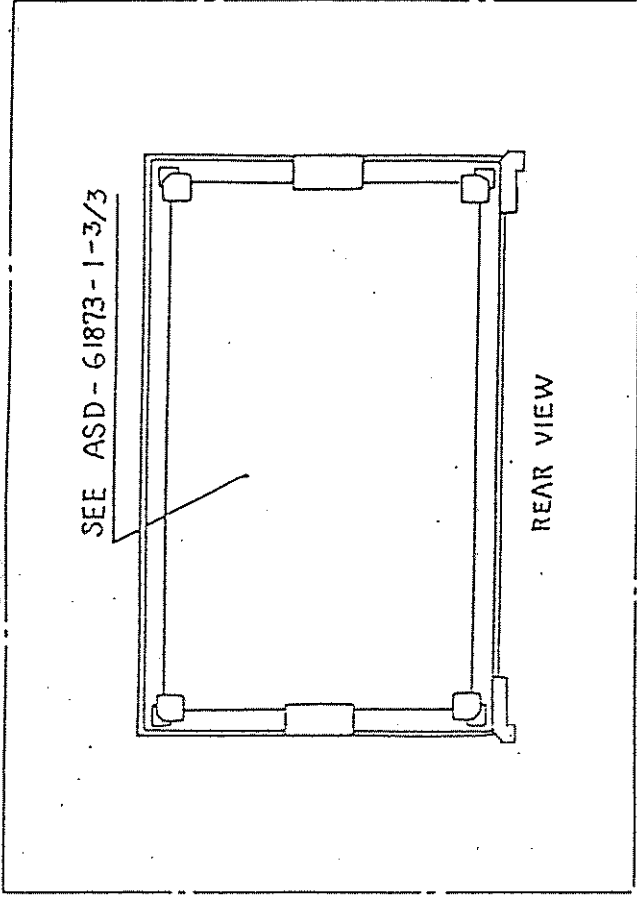
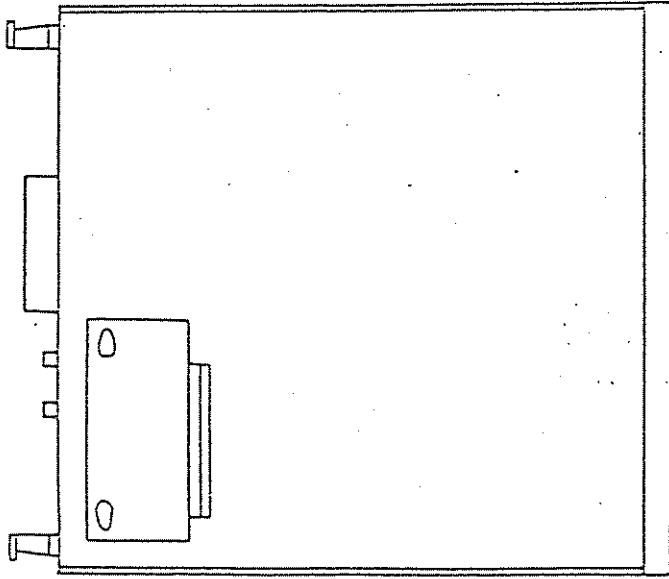

SEE ASD-61873-1-2/3

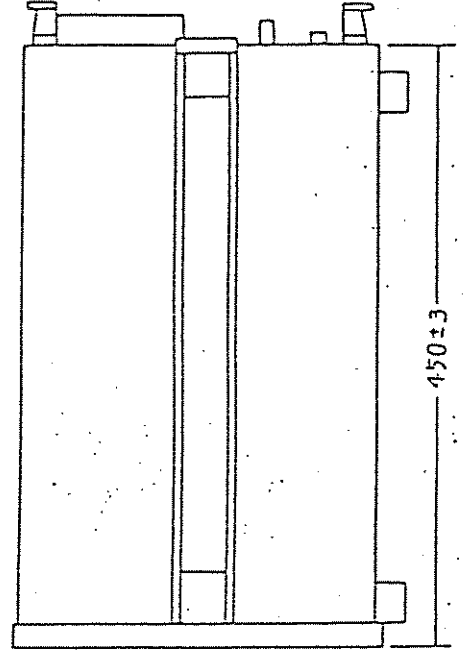
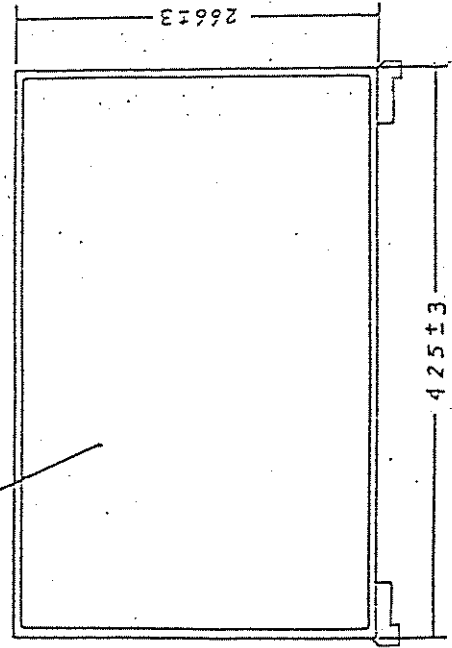

ASD-61873-1

UTSIDE VIEW OF AQ-6310B SPECTRUM ANALYZER (EXTERNAL VIEW)

OUTSIDE VIEW OF AQ-6310B SPECTRUM ANALYZER (FRONT VIEW)

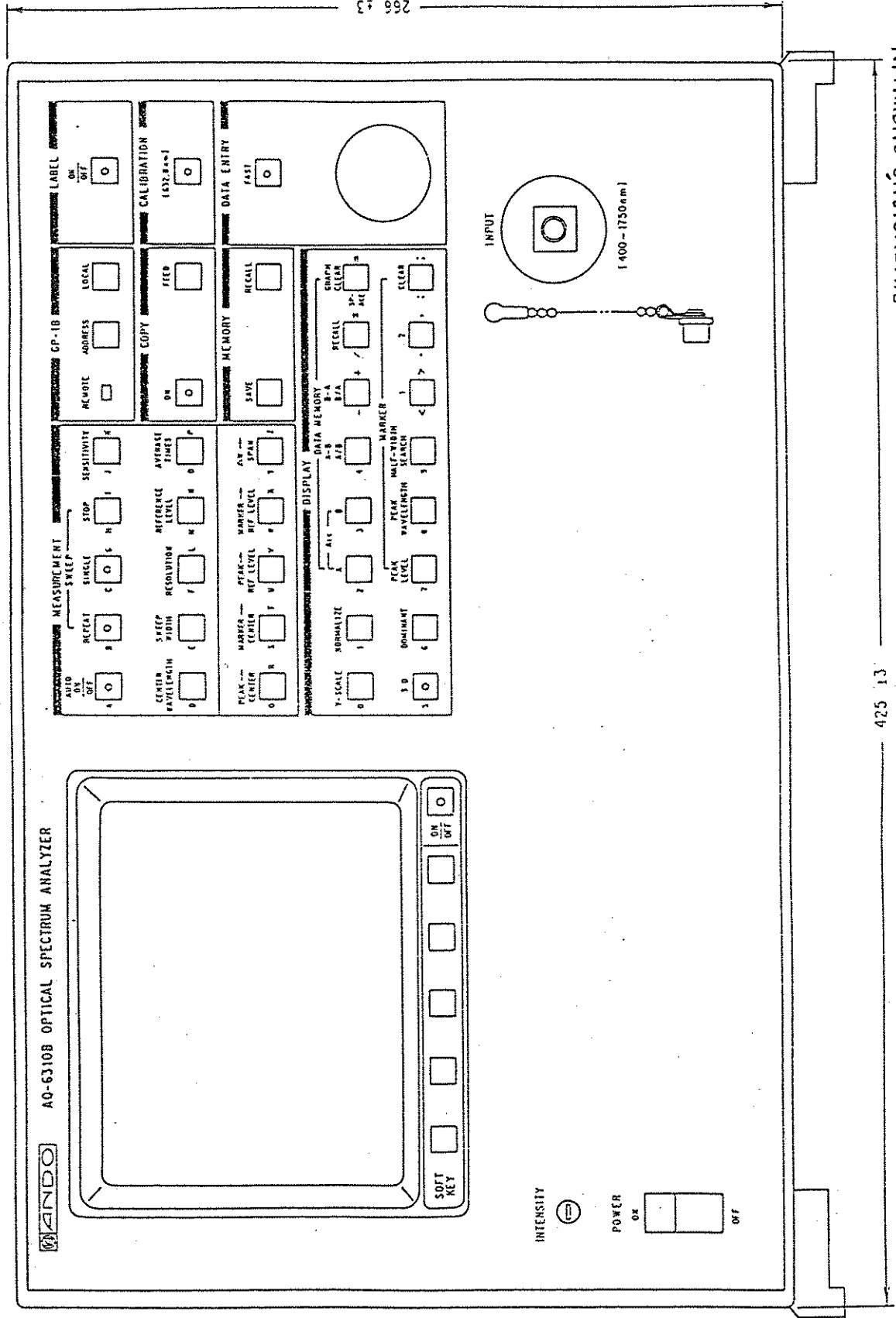

425 13

DIMENSIONS SHOWN IN mm

ASD-61873

OUTSIDE VIEW OF AQ- 6310B SPECTRUM ANALYZER (REAR VIEW)

