

HAMEG

Instruments

MANUAL

Oscilloscope HM 1005

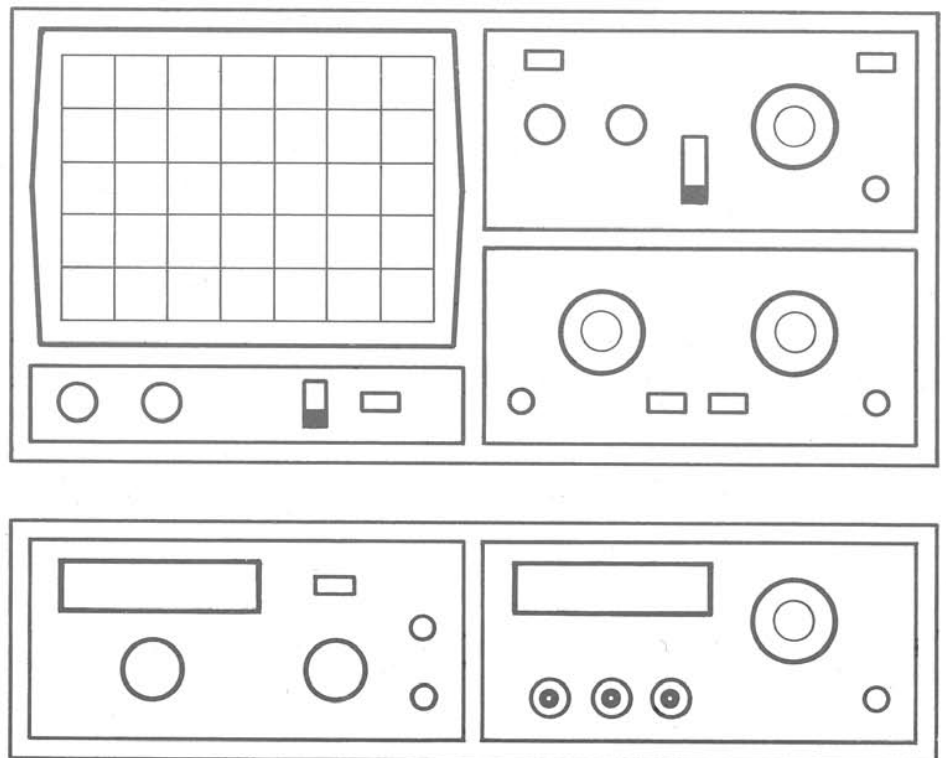

Technical Data P 1

Operating Instructions

General information M 1
 Use of tilt handle M 1
 Safety M 1
 Operating Conditions M 2
 Warranty M 2
 Maintenance M 2
 Mains/Line Voltage Change M 2
 Type of Signal M 3
 Amplitude Measurements M 3
 Time Measurements M 4
 Connection of Test Signal M 5
 Operating M 6
 First Time Operation M 7
 Trace Rotation TR M 7
 Use and Compensation of Probes M 7
 Operating Modes of the Y Amplifier M 9
 X-Y Operation M 9
 Y Overscanning Indication M 9
 Triggering and Timebase A M10
 Triggering of Video Signals M11
 Hold Off M11
 Single Sweep Operation M11
 Trigger Indicator M12
 Timebase B (DEL. TB) M12
 Miscellaneous
 (Sawtooth Output, Z Modulation) M13
 (Y Output, Scale Illumination) M13

Applications

Amplitude Measurement A 1
 Time Measurement A 1
 XY Phase Measurement A 1
 Dual Trace Phase Measurement A 2
 Measurement of an Amplitude Modulation A 2

Short Instruction K 1

Front Panel Elements

Folder with Front View K 2

Test Instructions

General T 1
 Cathode Ray Tube: Brightness, Focus,
 Linearity, Raster Distortions T 1
 Astigmatism Check T 1
 Symmetry and Drift of the Vertical Amplifier T 1
 Calibration of the Vertical Amplifier T 1
 Transmission Performance
 of the Vertical Amplifier T 2
 Operating Modes: CH I/II, DUAL, ADD,
 CHOP., INV. II, X-Y Operation T 2
 Triggering Checks T 3
 Timebase A T 3
 Timebase B T 4
 Trace Alignment T 4
 Miscellaneous T 4

Oscilloscope HM 1005

Service Instructions

General, Instrument Case Removal S 1
 Operating Voltages, Minimum Brightness S 1
 Astigmatism Control S 1
 Trouble-Shooting the Instrument S 2
 Replacement of Components and Parts S 2
 Replacement of the Power Transformer S 2
 Adjustments S 3

Circuit Diagrams

Block Diagram D 1
 Y Input, Attenuator, Preamplifier CH I/II D 2
 Y Input, Preamplifier CH III D 3
 Y Intermediate Amplifier, Trigger Amplifier D 4
 Trigger Logic, Y Channel Switching D 5
 Triggering D 6
 Y Final Amplifier D 7
 Timebase Generator D 8
 Trigger Comparators, Timebase D 9
 X Final Amplifier D10
 Delay Pos. (Digital Display) D11
 Power Supply, Calibrator D12
 CRT Circuit, Unblanking, HV Supply D13

Component Locations

Input Amplifier CH I/II D14
 SY-Board D14
 XY Board D15
 TB Board D16
 YF Board D17
 DEL Board D17
 Cal Board D17
 EY Board (Channel III) D17
 CRT Board D17
 Z Board D18
 FL Board D18
 TR Board D18

HM 1005

The 100 MHz Standard

for professionals

The **HM 1005** is a multi-function oscilloscope loaded with features such as true **3-channel** operation, a genuine **second time base**, and even a separate **second trigger facility**. Up to **6 traces** can be displayed for evaluating waveform relationships by using the alternating time base mode and all three input channels. In this configuration, the normal signal is displayed together with the expanded signal section. The second trigger facility, with its own separate slope and level control, provides for the stable viewing of normally troublesome asynchronous signal components. The main time base trigger circuit is designed to provide reliable triggering to greater than **130 MHz**, at signal levels as low as 1 division. A user-selectable **x10 magnifier** extends the maximum sweep range to **5 ns/division**. An active **TV Sync Separator** extracts clean field and line sync. pulses to ensure a high degree of display stability when viewing composite video signals.

The built-in **delay line** permits viewing of the trigger edge at all times. The **over-scan feature** indicates if any part of the trace passes beyond the vertical limits of the CRT screen. An **analog Y-output**, switchable to Channel I or II, allows further external processing of the signal. Another new feature on the **HM 1005** is the easy-to-read 3-digit LED delay time multiplier for accurate measurements.

As is the case with several **HAMEG** oscilloscopes, the **HM 1005** also has a built-in switchable **1 kHz / 1 MHz Calibrator** with a sharp <5 ns risetime output. This feature is necessary in high bandwidth oscilloscopes so that the probes can be correctly matched and compensated to ensure faithful reproduction of the input signals. This is especially true when viewing pulses and other high frequency signals. The calibrator is also useful for performing checks of the instrument's transient response characteristics **from probe tip to CRT screen**.

The **HM 1005** offers the right combination of triggering control, frequency response and time base versatility, to facilitate measurements in every environment from the laboratory to field service. It is yet another example of **HAMEG's** dedication to engineering excellence.

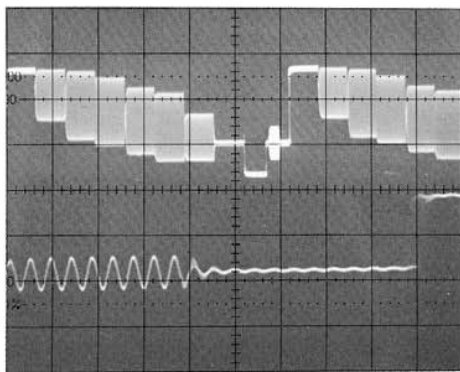

The photo shows a composite video signal displayed in the alternating timebase mode. The upper screen section shows approximately 1 1/2 lines of color bar signal. The lower half of the screen displays a stably triggered burst signal, expanded approximately 25 times.

Such displays can only be achieved with a separate trigger level control for the 2nd timebase.

Accessories supplied

Two 10:1 wideband probes, Line cord, Operators Manual.

Specification

Vertical Deflection

Operating modes: Channel I or Ch. II individually, Channel I and II: alternate or chopped. (Chopper frequency approx. 0.5 MHz). Ch. III can be displayed together with Ch. I and Ch. II.
Sum or difference from Ch. I and Ch. II, (with dedicated "Invert" control for Channel II).
X-Y Mode: via Channel I (X) and Channel II (Y).
Frequency range: 3x DC to 100 MHz (-3 dB).
 Risettime: < 3.5 ns. Overshoot: ≤ 1%.
Deflection coeff. Ch. I/Ch. II: 10 calibr. steps from 5 mV to 5 V/div ± 3% in 1-2-5 sequence, variable 2.5: 1 to min. **12.5 V/div**.
Y Mag. x5 (calibrated) to **1 mV/div ± 5%**. (Frequency range DC to 10 MHz (-3 dB).)
Deflection coefficient Ch. III: 50 mV/div, ± 3%, variable 5: 1 to min. 250 mV/div.
Input impedance Ch. I-III: 1 MΩ || 22 pF.
 Input coupling Ch. I-III.: DC-AC-GD (Ground)
 Input voltage: max. 400 V (DC + peak AC).
Y output from Ch. I or Ch. II ≈ 45 mV/div (50 Ω).
Delay Line: approx. 90 ns.

Triggering

With **automatic 10 Hz - 120 MHz** (≥ 5 mm height), normal, **DC - 130 MHz**, with LEVEL adjust (≥ 10 mm). Slope: positive or negative.
LED indicator for trigger action.
 Sources: Ch. I, Ch. II, altern. Ch. I/II, line, external.
 Coupling: **AC** (≥ 10 Hz - 40 MHz), **DC** (0 - 40 MHz), **HF** (15 kHz - 130 MHz), **LF** (0 - 1 kHz).
 Threshold: external ≥ 0.3 V.
TV-Sync-Separator for line and frame, pos., neg.
Triggering Timebase B: (internal only) with level control (AC coupling) slope positive or negative.

Horizontal Deflection

Timebase A: 23 calibrated steps from 50 ns to 1 s/div ± 3% in 1-2-5 sequence, variable 2.5: 1 to min. 2.5 s/div., with **X Mag. x10** to **5 ns/div ± 5%**. Hold-Off time: variable to approx. 10:1.
Timebase B: 21 calibrated steps from 50 ns to 0.2 s/div ± 3% in 1-2-5 sequence, with **X Mag. x10** to **5 ns/div ± 5%**. Delay Pos. 1000:1 with Digital Display ± 0.1%.
Single shot deflection: Single, reset, Ready-LED.
Operating Modes:
A = Display with main timebase A only.
ALT. altern. display with intensified A and delayed B.
B display with delayed timebase B only.
 Selectable: Delay time, untriggered or triggered start after delay, slope, trigger level, B intensity, vertical A to B trace separation.
Bandwidth X-Amplifier: DC-4 MHz (-3 dB).
 Input X-Amplifier via Channel I, sensitivity see Ch. I specification.
X-Y phase shift: < 3° below 120 kHz.
 Ramp output: approx. 5 V, positive going.

General Information

Cathode-ray tube: D14-372 P43/123, intern. gratic., **8 x 10 div.**
 Acceleration voltage: approx. 14 kV.
 Trace rotation: adjustable on front panel.
 Graticule illumination: 3 steps.
 Z modulation: TTL level, pos. going.
 3-digit delay position display.
Calibrator 1 kHz/1 MHz, 0.2 V (t, < 5 ns), and 2 V ± 1%
 Line voltage: 110, 125, 220, 240 V ~ ± 10%.
Power consumption: ≈ 44 Watt, 50/60 Hz.
Protective system: Safety Class I (IEC 348).
 Weight: approx. 8 kg. Colour: techno-brown.
 Cabinet: **W** 285, **H** 145, **D** 380 mm.
 Lockable tilt-bail/handle.

Subject to change without notice

Multi-Function Oscilloscope HM 1005

Screen

Rectangular screen 8x10 cm, Acceleration approx. 14kV. Internal graticule for parallax-free viewing.

Display

3-Digit Display for accurate Delay-Position

TV-Separator

for frame and line display

Timebase

1. Timebase: 1 s-0,05 μ s/div with X-Mag. to 5 ns/div
2. Timebase: 0,2 s-0,05 μ s/div with X-Mag. to 5 ns/div

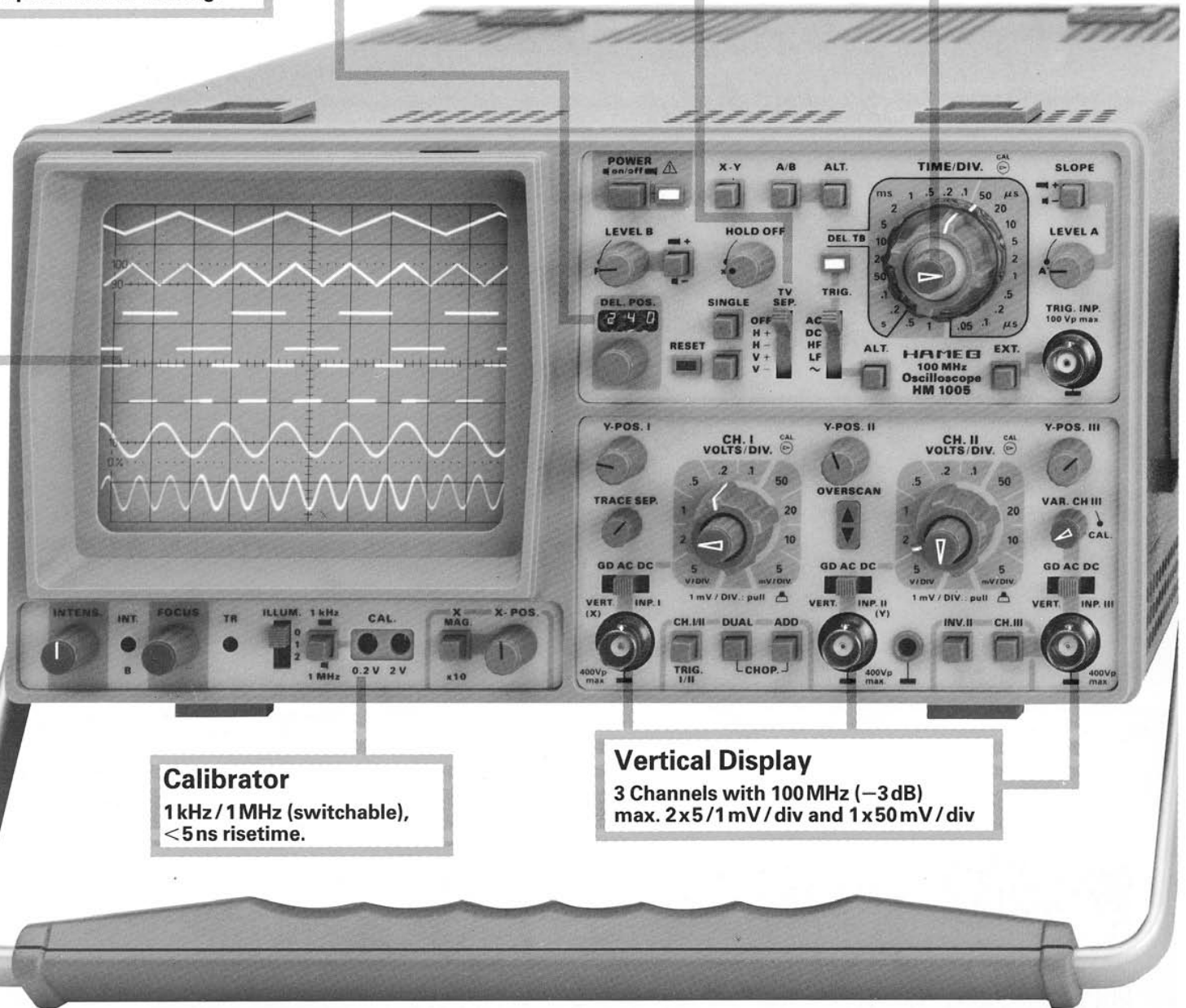

Calibrator

1 kHz / 1 MHz (switchable), <5 ns risetime.

Vertical Display

3 Channels with 100 MHz (-3 dB) max. 2x5/1 mV/div and 1x50 mV/div

Recommended Accessories:

HZ 34 Cable BNC-BNC, 50 Ω , length approx. 1 m, Cable RG58; colour: black.

HZ 53 100:1 Probe, bandwidth 150 MHz, max. 1200 V, impedance 100 M Ω || 6,5 pF.

HZ 38 Demodulator probe, bandwidth approx. 600 MHz, max. input voltage 200 V.

HZ 58 High voltage probe, max. 15 kV, bandwidth approx. 5 MHz, attenuation 1000:1.

HZ 22 50 Ω Through termination, for BNC cables, maximum sink: approx. 2 Watts.

HZ 24 Attenuators 3/6/10/20 dB, usable up to 1 GHz, 50 Ω -BNC connectors.

HZ 96 Carrying Case for HM 1005, HM 203-6, HM 205, HM 604 and HM 806.

HZ 44 Rackmount-Set for all HAMEG Scopes into 19"-systems.

Operating Instructions

General Information

This oscilloscope is easy to operate. The logical arrangement of the controls allows anyone to become familiar with the operation of the instrument after a short time, however, experienced users are also advised to read through these instructions so that all functions are understood.

Immediately after unpacking, the instrument should be checked for mechanical damage and loose parts in the interior. If there is transport damage, the supplier must be informed immediately. The instrument must then not be put into operation.

Check that the instrument is set to the correct mains/line voltage. If not, refer to instructions on page M2.

Use of tilt handle

To view the screen from the best angle, there are three different positions (C, D, E) for setting up the instrument. If the instrument is set down on the floor after being carried, the handle remains automatically in the upright carrying position (A).

In order to place the instrument onto a horizontal surface, the handle should be turned to the upper side of the oscilloscope (C). For the D position (10° inclination), the handle should be turned in the opposite direction out of the carrying position until it locks in place automatically underneath the instrument. For the E position (20° inclination), the handle should be pulled to release it from the D position and swing backwards until it locks once more.

The handle may also be set to a position for horizontal carrying by turning it to the upper side to lock in the B position. At the same time, the instrument must be moved upwards, because otherwise the handle will jump back.

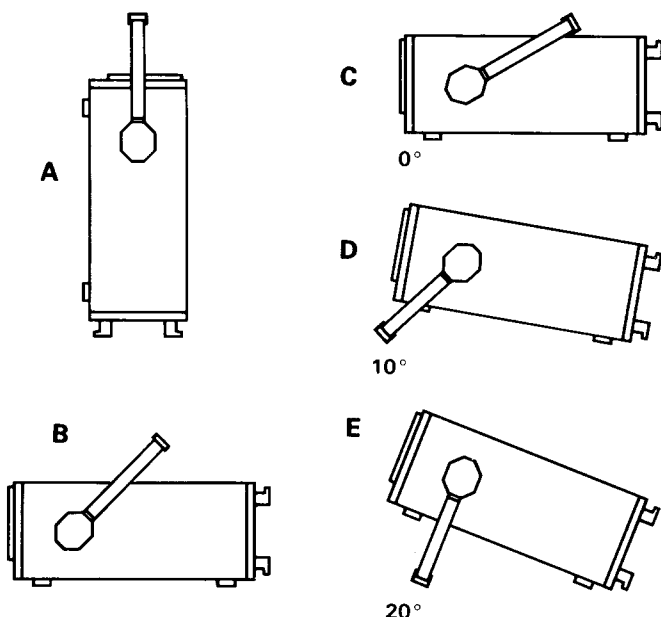

Safety

This instrument has been designed and tested in accordance with **IEC Publication 348, Safety Requirements for Electronic Measuring Apparatus**, and has left the factory in a safe condition. The present instruction manual contains important information and warnings which have to be followed by the user to ensure safe operation and to retain the oscilloscope in safe condition. The case, chassis and all measuring terminals are connected to the protective earth contact of the appliance inlet. The instrument operates according to **Safety Class I** (three-conductor power cord with protective earthing conductor and a plug with earthing contact). The mains/line plug shall only be inserted in a socket outlet provided with a protective earth contact. The protective action must not be negated by the use of an extension cord without a protective conductor.

Warning! Any interruption of the protective conductor inside or outside the instrument or disconnection of the protective earth terminal is likely to make the instrument dangerous. Intentional interruption of the protective earth connection is prohibited. The mains/line plug should be inserted before connections are made to measuring circuits.

The grounded accessible metal parts (case, sockets, jacks) and the mains/line supply contacts (line, neutral) of the instrument have been tested against insulation breakdown with **2000 Vr.m.s. (50 Hz)**.

Under certain conditions, 50 Hz or 60 Hz hum voltages can occur in the measuring circuit due to the interconnection with other mains/line powered equipment or instruments. This can be avoided by using an isolation transformer (Safety Class II) between the mains/line outlet and the power plug of the instrument. When displaying waveforms where the "low-level" side of the signal is at a high potential, even with the use of a protective isolation transformer, it should be noted that this potential is connected to the oscilloscope's case and other accessible metal parts. High voltages are dangerous. In this case, special safety precautions are to be taken, which must be supervised by qualified personnel if the voltage is higher than 42 V.

Most cathode-ray tubes develop X-rays. However, **the dose equivalent rate falls far below the maximum permissible value of 36 pA/kg (0.5 mR/h)**.

Whenever it is likely that protection has been impaired, the instrument shall be made inoperative and be secured against any unintended operation. The protection is likely to be impaired if, for example, the instrument

- shows visible damage,
- fails to perform the intended measurements,
- has been subjected to prolonged storage under unfavourable conditions (e.g. in the open or in moist environments),
- has been subject to severe transport stress (e.g. in poor packaging).

Operating conditions

The instrument has been designed for indoor use. The permissible ambient temperature range during operation is +15°C ... +30°C. It may occasionally be subjected to temperatures between +10°C and -10°C without degrading its safety. The permissible ambient temperature range for storage or transportation is -40°C ... +70°C.

The maximum operating altitude is up to 2200m (non-operating 15000m). The maximum relative humidity is up to 80%.

If condensed water exists in the instrument it should be acclimatized before switching on. In some cases (e.g. extremely cold oscilloscope) two hours should be allowed before the instrument is put into operation. The instrument should be kept in a clean and dry room and must not be operated in explosive, corrosive, dusty, or moist environments. The oscilloscope can be operated in any position, but the convection cooling must not be impaired. **The ventilation holes may not be covered.** For continuous operation the instrument should be used in the horizontal position, preferably tilted upwards, resting on the tilt handle.

The specifications stating tolerances are only valid if the instrument has warmed up for 30 minutes at an ambient temperature between +15°C and +30°C. Values not stating tolerances are typical for an average instrument.

Warranty

Each instrument runs through a quality test with 10 hour burn-in before leaving the production. Practically every early failure is detected in intermittent operation by this method. However, it is possible that a component fails only after a lengthy operating period. Therefore a **functional guarantee of 2 years** is given for all units. The condition for this is that no modifications have been made in the instrument. In the case of shipments by post, rail or carrier it is recommended that the original packing is carefully preserved. Transport damages and damage due to gross negligence are not covered by the guarantee.

In the case of a complaint, a label should be attached to the housing of the instrument which describes briefly the faults observed. If at the same time the name and telephone number (dialing code and telephone or direct number or department designation) is stated for possible queries, this helps towards speeding up the processing of guarantee claims.

Maintenance

Various important properties of the oscilloscope should be carefully checked at certain intervals. Only in this way is it largely certain that all signals are displayed with the accuracy on which the technical data are based. The test methods described in the test plan of this manual can be performed without great expenditure on measuring instruments. However, purchase of the new HAMEG scope tester HZ 60, which despite its low price is highly suitable for tasks of this type, is very much recommended.

The exterior of the oscilloscope should be cleaned regularly with a dusting brush. Dirt which is difficult to remove on the casing and handle, the plastic and aluminium parts, can be removed with a moistened cloth (99% water +1% mild detergent). Spirit or washing benzene (petroleum ether) can be used to remove greasy dirt. The screen may be cleaned with water or washing benzene (but not with spirit (alcohol) or solvents), it must then be wiped with a dry clean lint-free cloth. Under no circumstances may the cleaning fluid get into the instrument. The use of other cleaning agents can attack the plastic and paint surfaces.

Switching over the mains/line voltage

The instrument is set for 220V (240V U.K.) line voltage on delivery. It can be switched over to other voltages at the fuse holder combined with the 3-pole appliance inlet at the rear of the instrument. Firstly the fuse holder printed with the voltage values is removed using a small screw driver and - if required - provided with another fuse. Refer to the table below for the prescribed value of the fuse. Then replace the fuse holder so that the impressed white triangle points to the desired voltage. Here pay attention that the cover plate is also correctly engaged. The use of repaired fuses or short circuiting the fuse holder is not allowed. Damage arising because of this is not covered by the guarantee.

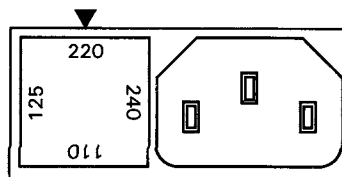

Fuse type: Size **5 x 20 mm**; 250 V~, C; IEC 127, Sheet III; DIN 41 662 (possibly DIN 41 571 sheet 3).

Cutoff: **time lag (T).**

Line voltage	Fuse rating
110 V ~ ±10 %	T0.63 A
125 V ~ ±10 %	T0.63 A
220 V ~ ±10 %	T0.315 A
240 V ~ ±10 %	T0.315 A

Type of Signal

All types of signals with a frequency spectrum below 100MHz can be displayed on the HM1005. The display of simple electrical processes such as sinusoidal RF and AF signals or ripple poses no problems. However, when square or pulse-shaped signals are displayed it must be remembered that their **harmonic content** must also be transmitted. In this case, the bandwidth of the vertical amplifier must be considerably higher than the repetition frequency of the signal. In view of this, accurate evaluation of such signals with the HM1005 is only possible up to a maximum repetition rate of 10MHz. Operating problems can sometimes occur when composite signals are to be displayed, especially if they do not contain any suitable level components and repetition frequency which can be used for triggering. This occurs, for example, with burst signals. To obtain a stably triggered display in these cases, it may be necessary to use Normal Triggering, **HOLD OFF** time control, and/or **TIME/DIV.** variable control.

Video signals are easily triggerable with the aid of the active TV sync separator (**TV-SEP.** switch).

For optional operation as a DC or AC voltage amplifier, each channel is provided with a **DC-AC** coupling switch. The **DC** position should only be used with an attenuator probe or at very low frequencies or if the determination of DC voltage content of the signal is absolutely necessary.

However, when investigating very low-frequency pulses, misleading ramp-offs may occur with **AC** coupling. In this case, **DC** operation is to be preferred if the signal voltage is not superimposed on a too high DC voltage level. Otherwise, a capacitor of adequate capacitance must be connected before the input of the vertical amplifier (switched to **DC** coupling). It should be remembered that this capacitor must have a sufficiently high breakdown voltage. **DC** operation is also recommended for the display of logic and pulse signals, particularly if their pulse duty factor changes permanently during operation. Otherwise, the display will move up and down with any change. DC voltages can only be measured in the **DC** position.

Amplitude Measurements

In general electrical engineering, alternating voltage data normally refers to effective values (rms = root-mean-square value). However, for signal magnitudes and voltage designations in oscilloscope measurements, the peak-to-peak voltage (V_{pp}) value is applied. The latter corresponds to the real potential difference between the most positive and most negative points of a signal waveform.

If a sinusoidal waveform, displayed on the oscilloscope screen, is to be converted into an effective (rms) value, the resulting peak-to-peak value must be divided by $2 \times \sqrt{2} = 2.83$.

Conversely, it should be observed that sinusoidal voltages indicated in V_{rms} (V_{eff}) have 2.83 times the potential difference in V_{pp} . The relationship between the different voltage magnitudes can be seen from the following figure.

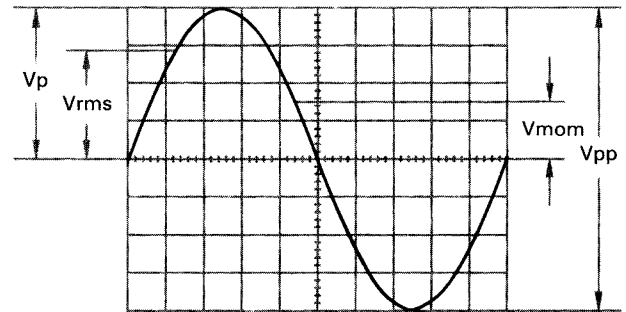

Voltage values of a sine curve

V_{rms} = effective value; V_p = simple peak or crest value;
 V_{pp} = peak-to-peak value; V_{mom} = momentary value.

The minimum signal voltage required at the vertical amplifier input for a display of 1 div is approximately **1 mV_{pp}**. This is achieved with the attenuator control set at **5 mV/div**, its **variable control in the fully clockwise position and pulled out**. However, smaller signals than this may also be displayed. The **deflection coefficients** on the input attenuators are indicated in **mV/div** or **V/div** (peak-to-peak value).

The magnitude of the applied voltage is ascertained by multiplying the selected deflection coefficient by the vertical display height in div.

If an attenuator probe x10 is used, a further multiplication by a factor of 10 is required to ascertain the correct voltage value.

For exact amplitude measurements the variable control on the attenuator switch must be set to its calibrated detent CAL. When turning the variable control ccw the sensitivity will be decreased by a factor of 2.5.

Therefore every intermediate value is possible within the 1-2-5 sequence.

With direct connection to the vertical input, **signals up to 100V_{pp}** may be displayed (attenuator set to **5V/div**, variable control ccw).

When pulling the variable control knob (**MAG x5**), the sensitivity is increased by a factor of 5. Hence follows a min. deflection coefficient of **1 mV/div** (bandwidth: DC to 15MHz).

The deflection coefficient for channel III is 50mV/div when the VAR. CH.III setting control is in the CAL. position. With the setting control turned ccw all the way the deflection is reduced to 250mV/div.

If the applied signal is superimposed on a DC (direct voltage) level the total value (DC + peak value of the alternating voltage) of the signal across the Y-input must not exceed $\pm 400\text{ V}$ (see figure).

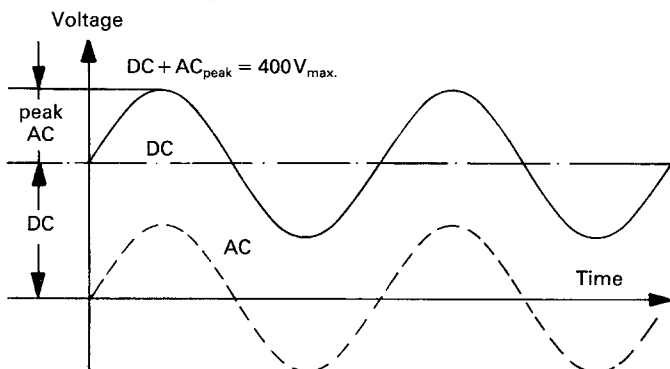

Total value of input voltage

The dotted line shows a voltage alternating at zero volt level. When superimposed a DC level, the addition of the positive peak on the DC voltage results in the max. voltage ($\text{DC} + \text{AC}_{\text{peak}}$).

This same limit applies to normal $\times 10$ attenuator probes, the attenuation ratio of which allows signal voltages up to approximately 600 V ($\text{DC} + \text{AC}$ peak) to be evaluated. Voltages of up to approximately 1200 V ($\text{DC} + \text{AC}$ peak) may be measured by using the HZ53 high voltage probe which has an attenuation ratio of 100:1. It should be noted that its AC_{peak} value is derated at higher frequencies. If a normal $\times 10$ probe is used to measure high voltages there is the risk that the compensation trimmer bridging the attenuator series resistor will break down causing damage to the input of the oscilloscope. However, if for example only the residual ripple of a high voltage is to be displayed on the oscilloscope, a normal $\times 10$ probe is sufficient. In this case, an appropriate high voltage capacitor (approx. $22\text{-}68\text{ nF}$) must be connected in series with the input tip of the probe.

It is very important that the oscilloscope input coupling is set to **DC**, if an attenuator probe is used for voltages higher than 400 V (see page M5: Connection of Test Signal).

Time Measurements

As a rule, all signals to be displayed are periodically repeating processes and can also be designated as periods. The number of periods per second is the recurrence frequency or repetition rate. One or more signal periods or even part of a period may be shown as a function of the adjustment of the **TIME/DIV.** switch. The time coefficients on the **TIME/DIV.** switch are indicated in **s/div**, **ms/div**, and **$\mu\text{s}/\text{div}$** . Accordingly, the dial is subdivided into three sectors.

The duration of a signal period or a portion of the waveform is ascertained by multiplying the relevant time (horizontal distance in div) by the time coefficient

selected on the TIME/DIV. switch. The time variable control (small knob on the TIME/DIV. switch) must be in its calibrated detent CAL. for accurate measurement (arrow horizontal and pointing to the right).

If the time is relatively short as compared with the complete signal period, an expanded time scale should always be applied (**X-MAG $\times 10$** button pushed). In this case, the ascertained time values have to be divided by **10**. Very small time intervals at optional points of the signal can be measured more exactly with the aid of the sweep delay. With it, the display and measurement of time intervals, which are smaller than 1% of the full signal period, are possible. The smallest measurable time interval is, on the whole, dependent on the obtainable brightness of the CRT. The limit is an expansion of approximately 1000 times. Using a Viewing Hood HZ47, more expansion is possible, provided that the time coefficient set on the **TIME/DIV.** switch is greater than **$5\mu\text{s}/\text{div}$** (and using the **X MAG $\times 10$** facility) for the signal's basic period. Otherwise, the fastest sweep speed determines the greatest possible expansion.

When investigating pulse or square waveforms, the critical feature is the **risetime of the voltage step**. To ensure that transients, ramp-offs, and bandwidth limits do not unduly influence the measuring accuracy, the risetime is generally measured between **10%** and **90%** of the vertical pulse height. For peak-to-peak signal amplitude of **5 div** height, which are symmetrically adjusted to the horizontal center line, the internal graticule of the CRT has two horizontal dotted lines $\pm 2.5\text{ div}$ from the center line. Adjust the **Y-POS.** control so that the pulse height is precisely aligned with these 0 and 100% lines. The 10% and 90% points of the signal will now coincide with the two lines, which have a distance of $\pm 2\text{ div}$ from the horizontal center line and an additional subdivision of 0.2 div . **The risetime is given by the product of the horizontal distance in div between these two coincidence points and the time coefficient setting.** If magnification is used, this product must be divided by 10. The **fall time** of a pulse can also be measured by using this method.

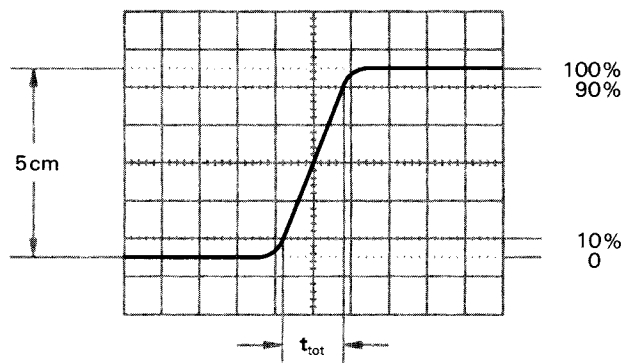

The above figure shows correct positioning of the oscilloscope trace for accurate risetime measurement.

With a time coefficient of **0.05 μs/cm** and pushed **X-MAG x10** button the example shown in the above figure results in a measured total risetime of

$$t_{\text{tot}} = 1.6 \text{ cm} \cdot 0.05 \mu\text{s/cm} : 10 = \mathbf{8 \text{ ns}}$$

When very fast risetimes are being measured, the risetimes of the oscilloscope amplifier and the attenuator probe have to be deducted from the measured time value. The risetime of the signal can be calculated using the following formula.

$$t_r = \sqrt{t_{\text{tot}}^2 - t_{\text{osc}}^2 - t_p^2}$$

In this t_{tot} is the total measured risetime, t_{osc} is the risetime of the oscilloscope amplifier (approx. 4.4 ns), and t_p the risetime of the probe (e.g. = 2 ns). If t_{tot} is greater than 34 ns, then t_{tot} can be taken as the risetime of the pulse, and calculation is unnecessary.

Calculation of the example in the figure above results in a signal risetime

$$t_r = \sqrt{8^2 - 3.5^2 - 2^2} = \mathbf{6.9 \text{ ns}}$$

Connection of Test Signal

Caution: When connecting unknown signals to the oscilloscope input, always use automatic triggering and set the **DC-AC** input coupling switch to **AC**. The attenuator switch should initially be set to **5V/cm**. Pay attention to the Y overscanning indication (see "Y Overscanning Indication").

Sometimes the trace will disappear after an input signal has been applied. The attenuator switch must then be turned back to the left, until the vertical signal height is only 3-8 cm. With a signal amplitude greater than $160V_{\text{pp}}$, an attenuator probe must be inserted before the oscilloscope's vertical input. If, after applying the signal, the trace is nearly blanked, the period of the signal is probably substantially longer than the set value on the **TIME/DIV.** switch. It should be turned to the left to an adequately greater time coefficient.

The signal to be displayed should be fed to the vertical input of the oscilloscope by means of a shielded test cable, e.g. the HZ32 or HZ34, or by a x10 or x100 attenuator probe. The use of these shielded cables with high impedance circuits is only recommended for relatively low frequencies (up to approx. 50 kHz). For higher frequencies, and when the signal source is of low impedance, a cable of matched characteristic impedance (usually 50Ω) is recommended. In addition, and especially when investigating square or pulse waveforms, a resistor equivalent to the characteristic impedance of the cable must also be connected to the cable directly at the input of the oscilloscope. When using a 50Ω

cable, such as the HZ34, a 50Ω through-termination type HZ22 is available from HAMEG. When investigating square or pulse waveforms with fast risetimes, transient phenomena on both the edge and top of the signal may become visible if the correct termination is not used. It must be remembered that the 50Ω through-termination will only dissipate a maximum of 2 watts. This power consumption is reached with $10V_{\text{rms}}$ or with $28V_{\text{pp}}$ sine signal.

If a x10 or x100 attenuator probe is used, no termination is necessary. In this case, the connecting cable is matched directly to the high impedance input of the oscilloscope. When using attenuator probes even high internal impedance sources are only slightly loaded by approximately $10M\Omega \parallel 16\text{pF}$ or $100M\Omega \parallel 7\text{pF}$ respectively. Therefore, when the voltage loss due to the attenuation of the probe can be compensated by a higher sensitivity setting on the HM1005, the probe should always be used. Also it should be remembered that the series impedance of the probe provides a certain amount of protection for the input of the oscilloscope amplifier. It should be noted that all attenuator probes must be compensated in conjunction with the oscilloscope (see: Probe Adjustment, page M7).

If a x10 or x100 attenuator probe is used at voltages higher than 400V, the DC input coupling must always be set. With **AC** coupling, the attenuation is frequency-dependent, the pulses displayed can exhibit ramp-off, DC-voltage contents are suppressed – but loads the respective input coupling capacitor of the oscilloscope. The electric strength of which is maximum 400V (DC + peak AC). For the suppression of unwanted DC voltages, a **capacitor** of adequate capacitance and electric strength **may be connected before the input tip of the probe** (e.g. for ripple measurements).

With the HZ53 x100 probe the permissible AC input voltage is frequency-dependent limited:

below 20kHz (TV line frequency!) up to

$$\mathbf{max. 1200 V_p \triangleq 2400 V_{pp} \triangleq 850 V_{rms}}$$

above 20kHz (with f in MHz) up to

$$\mathbf{\frac{212}{\sqrt{f}} V_p \triangleq \frac{424}{\sqrt{f}} V_{pp} \triangleq \frac{150}{\sqrt{f}} V_{rms}}$$

It is important to remember that when low voltage signals are being investigated the position of the ground point on the test circuit can be critical. This ground point should always be located as close as possible to the measuring point. If this is not done, serious signal deformation may result from any spurious currents through the ground leads or test chassis parts. This comment also applies to the ground leads on attenuator probes which ideally should be as short and as thick as possible. For connection of a probe to a BNC socket, a BNC-adaptor should be used. It forms often a part of the probe accessory. Grounding and matching problems are then eliminated.

Hum or interference voltage appearing in the measuring circuit (especially with a small deflection coefficient) is possi-

bly caused by multiple grounding, because equalizing currents can flow in the shielding of the measuring cables (voltage drop between non-fused earthed conductors of other line powered devices, which are connected to the oscilloscope or test object, e.g. signal generators with anti-interference capacitors).

Operating

For a better understanding of these Operating Instructions the front panel picture at the end of these instructions can be unfolded for reference alongside the text.

The front panel is subdivided into three sections according to the various functions.

Directly below the CRT screen are located (from left to right) the setting controls for intensity (**INTENS.**), intensity of timebase B (**INT. B**), focus (**FOCUS**) and trace rotation (**TR**). Continuing towards the right are the graticule illumination control (**ILLUM.**), the calibrator (**CAL.** 0.2V_{pp} and 2V_{pp}) and the frequency selector switch (**1 kHz** or **1 MHz**). To the right of these – marked so as to stand out – are the horizontal magnification button (**X MAG. x10**) and the horizontal position control (**X POS.**).

On the top, immediately to the right of the CRT screen, is the power switch (**POWER**). Also in this block are the setting controls for timebase A (**TIME/DIV.**) and B (**DEL. TB**), the knobs for triggering the timebases (**LEVEL A** and **LEVEL B**) with their corresponding trigger slope selection switches (**SLOPE +/–**), and the deflection delay adjustment control (**DEL POS.**) with 3 digit display. The timebase selection button **A/B** (released: A, depressed: B) and the button for alternate display of the two timebases (**ALT.**) are situated, together with the **X-Y** button (when pressed: X-Y mode), on the top left hand side of the timebase switch. The **ALT.** button is for alternate triggering in alternate timebase mode; it is grouped together with the trigger coupling switch (**TRIG.**), which has the positions **AC**, **DC**, **HF**, **LF**, and **~**. Above this switch is the trigger indicator LED. For external triggering, the **EXT.** button must be pressed and the triggering signal applied to the BNC jack **TRIG. INP.** The **TV SEP.** switch is for video signal triggering. The **HOLD OFF** dial can be used to vary the hold-off time which elapses before the sweep generator reacts to a triggering pulse. The **SINGLE** and **RESET** buttons (with LED) permit display of single shot events.

In the Y section on the lower righthand side of the control panel are located the vertical amplifier inputs for channels I, II, and III (**VERT INP. I**, **VERT INP. II**, **VERT INP. III**), together with their corresponding input selectors (for **GD**, **AC**, **DC**), as well as the volts/divisions controls for CH I and CH II and the amplifier gain control for channel III (**VAR. CHIII**). The trace separation control (**TRACE SEP.**) is used to sepa-

rate the trace positions when working with timebases A and B in alternate mode. The 5 pushbuttons in the Y section are for selecting the operating mode for the vertical amplifiers; they are explained in the section on “Operating modes of the vertical amplifiers”.

The instrument is so designed that even incorrect operation will not cause serious damage. The pushbuttons control only minor functions, and it is recommended that before commencement of operation all pushbuttons are in the “out” position. After this the pushbuttons can be operated depending upon the mode of operation required.

The HM 1005 accepts all signals from DC (direct voltage) up to a frequency of at least 100 MHz (-3 dB). For sinewave voltages the upper frequency limit will be 130 MHz. However, in this higher frequency range the vertical display height on the screen is limited to approx. 4-5 cm. The time resolution poses no problem. For example, with 100 MHz and the fastest adjustable sweep rate (5 ns/cm), one cycle will be displayed every 2 cm.

However, from approximately 40 MHz upwards the measuring error will increase as a result of loss of gain. At 60 MHz this reduction is about 10%. Thus, approximately 11% should be added to the measured voltage at this frequency. As the bandwidth of the amplifiers differ (normally between 110 and 130 MHz), the measured values in the upper limit range cannot be defined exactly. Additionally, as already mentioned, for frequencies above 100 MHz the dynamic range of the display height steadily decreases. The vertical amplifier is designed so that the transmission performance is not affected by its own overshoot.

First Time Operation

Check that the instrument is set to the correct mains/line voltage. (Refer to page M2).

Before applying power to the oscilloscope it is recommended that the following simple procedures are performed:

- Check that all pushbuttons are in the **out** position, i.e. released.
- Rotate the four variable controls with arrows, i.e. **TIME/DIV.** variable control, **HOLD-OFF** ccw, **CH.I**, **CH.II** and **CH.III** attenuator variable controls fully clockwise to their calibrated detent.
- Set the variable controls with marker lines to their midrange position (marker lines pointing vertically), except **LEVEL A** and **LEVEL B** in the X section.
- Both slide switches in the X-Section (**TRIG.** and **TV SEP.**) should be set to their uppermost position.
- All input coupling slide switches for **CH.I**, **CH.II**, and **CH.III** in the Y-Section should be set to the **GD** position.

Switch on the oscilloscope by depressing the red **POWER** pushbutton. An LED will illuminate to indicate working order. The trace, displaying one baseline, should be visible after a short warm-up period of 10 seconds. Adjust **Y-POS.** and **X-POS.** controls to center the baseline. Adjust **INTENS.** (intensity) and **FOCUS** controls for medium brightness and optimum sharpness of the trace. The oscilloscope is now ready for use.

If only a spot appears (**CAUTION!** CRT phosphor can be damaged.), reduce the intensity immediately and check that the **X-Y** pushbutton is in the released (out) position. If the trace is not visible, check the correct positions of all knobs and switches (particularly **LEVEL** knob ccw.)

To obtain the maximum life from the cathode-ray tube, the minimum intensity setting necessary for the measurement in hand and the ambient light conditions should be used. **Particular care is required when a single spot is displayed**, as a very high intensity setting may cause damage to the fluorescent screen of the CRT. Switching the oscilloscope off and on at short intervals stresses the cathode of the CRT and should therefore be avoided.

Trace Rotation TR

In spite of Mumetal-shielding of the CRT, effects of the earth's magnetic field on the horizontal trace position cannot be completely avoided. This is dependent upon the orientation of the oscilloscope on the place of work. A centred trace may not align exactly with the horizontal center line of the graticule. A few degrees of misalignment can be corrected by a potentiometer accessible through an opening on the front panel marked TR.

Use and Compensation of Probes

To display an undistorted waveform on an oscilloscope, the probe must be matched to the individual input impedance of the vertical amplifier.

The HM1005's built-in calibration generator provides a squarewave signal with a very low risetime (<5ns), and switch-selectable frequencies of approx. 1 kHz and 1 MHz at two output sockets below the CRT screen. One output provides **0.2V_{pp} ± 1%** for 10:1 probes, and **2V_{pp} ± 1%** are present at the other, for 100:1 probes.

When the attenuator switches are set to **5mV/div** vertical deflection coefficient, these calibration voltages correspond to a screen amplitude of **4 div.**

The output sockets have an internal diameter of 4.9mm to accommodate the internationally accepted shielding tube

diameter of modern **Modular Probes** and **F-series** slimline probes. Only this type of construction ensures the extremely short ground connections which are essential for an undistorted waveform reproduction of non-sinusoidal high frequency signals.

Adjustment at 1 kHz

The C-trimmer adjustment compensates the capacitive loading on the oscilloscope input (approx. 22pF with the HM1005). By this adjustment, the capacitive division assumes the same division ratio as the ohmic voltage divider to ensure an equal division ratio for high and low frequencies, as for DC. (For 1:1 probes or switchable probes set to 1:1, this adjustment is neither required nor possible). A baseline exactly parallel to the horizontal graticule lines is a major condition for accurate probe adjustments. (See also 'Trace Rotation **TR**', page M7.)

Connect the probes (Types HZ51, 52, 53, 54, or HZ36) to **CH.I** input. All pushbuttons should be released (in the 'out' position). Set the input coupling switch to **DC**, the attenuator switch to **5mV/div**, and the **TIME/DIV.** switch to **0.2ms/div**, and all variable controls to **CAL.** position. Plug the probe tip into the appropriate calibrator output socket, i.e. 10:1 probes into the **0.2V** socket, 100:1 probes into the **2.0V** socket.

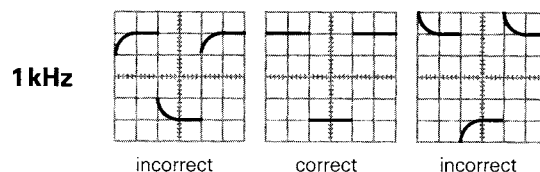

Approximately 2 complete waveform periods are displayed on the CRT screen. Now the compensation trimmer has to be adjusted. Normally, this trimmer is located in the probe head. On the 100:1 probe HZ53, however, it is located in the connecting box at the other end of the cable. Using a small insulated non-metallic screwdriver or trimming tool, the trimmer has to be adjusted slowly until the tops of the squarewave signal are exactly parallel to the horizontal graticule lines. (See Fig. above for 1 kHz.) The signal amplitude shown should be $4\text{ cm} \pm 1.2\text{ mm}$ (= 3%). During this adjustment, the signal edges will remain invisible.

Adjustment at 1 MHz

Probes HZ51, 52, 54 and HZ37 will also allow for HF-adjustments. They incorporate resonance deemphasizing networks (R-trimmer in conjunction with inductances and capacitors) which permit – for the first time – probe compensation in the range of the upper frequency limit of the vertical oscilloscope amplifier. Only this compensative adjustment ensures optimum utilisation of the full bandwidth, together with constant group delay at the high frequency end, thereby reducing characteristic transient distortion near the leading signal edge (e.g. overshoot, rounding, ringing, holes or bumps) to an absolute minimum.

Using the probes HZ51, 52, and 54, the full bandwidth of the HM 1005 can be utilized without risk of unwanted waveform distortion.

Prerequisite for this HF-adjustment is a squarewave generator with fast risetime (typical 4ns), and low output impedance (approx. 50Ω), providing 0.2V and 2V at a frequency of approx. 1MHz. The calibrator output of the HM 1005 meets these requirements when the pushbutton 1MHz is depressed.

Connect the probe to **CH.I** input. Depress the calibrator pushbutton **1MHz**. All other pushbuttons should be released ('out' position). Set the input coupling switch to **DC**, attenuator switch to **5mV/cm**, and **TIME/DIV.** switch to **0.1 μ s/cm**. Set all variable controls to **CAL.** position.

Insert the probe tip into the output socket marked **0.2V**. A waveform will be displayed on the CRT screen, with leading and trailing edges clearly visible. For the HF-adjustment now to be performed, it will be necessary to observe the rising edge as well as the upper left corner of the pulse top. To gain access to the HF-compensation trimmer, the plastic cover of the probe connecting box has to be slid off after unscrewing the probe cable. The connecting boxes of the HZ51, 54 and HZ37 contain one R-trimmer screw, each, while that of the HZ52 provides three. These R-trimmers have to be adjusted in such a manner that the beginning of the pulse top is as straight as possible. Overshoot or excessive rounding are unacceptable. This is relatively easy on the HZ51, 54 and HZ37, but slightly more difficult on the HZ52. The rising edge should be as steep as possible, with the pulse top remaining as straight and horizontal as possible.

On the HZ52, each of the three trimmers has a clearly defined area of influence on the waveform shape (see Fig.), offering the added advantage of being able to 'straighten out' waveform aberrations near the leading edge.

Adjustment points of the probes

HZ51, HZ54

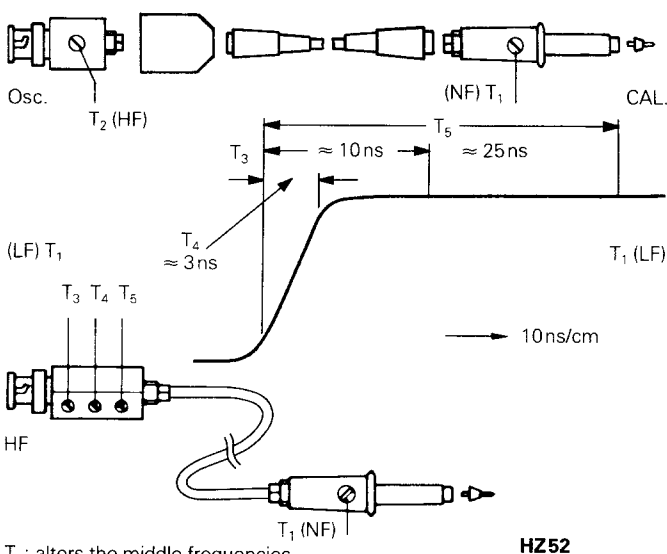

T_3 : alters the middle frequencies
 T_4 : alters the leading edge
 T_5 : alters the lower frequencies

HZ52

After completion of the HF-adjustment, the signal amplitude displayed on the CRT screen should have the same value as during the 1 kHz adjustment.

Probes other than those mentioned above, normally have a larger tip diameter and may not fit into the calibrator outputs. Whilst it is not difficult for an experienced operator to build a suitable adapter, it should be pointed out that most of these probes have a slower risetime with the effect that the total bandwidth of scope together with probe may fall far below that of the HM 1005. Furthermore, the HF-adjustment feature is nearly always missing so that waveform distortion can not be entirely excluded.

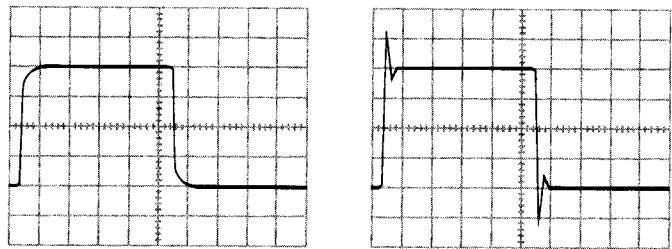

incorrect

incorrect

correct

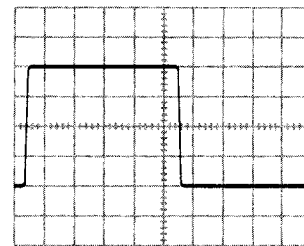

Adjustment 1MHz

The adjustment sequence must be followed in the order described, i.e. first at 1 kHz, then at 1 MHz. The calibrator frequencies should not be used for timebase calibrations. The pulse duty cycle deviates from 1:1 ratio.

Prerequisites for precise and easy probe adjustments, as well as checks of deflection coefficients, are straight horizontal pulse tops, calibrated pulse amplitude, and zero-potential at the pulse base. Frequency and duty cycle are relatively uncritical. For interpretations of transient response, fast pulse risetimes and low-impedance generator outputs are of particular importance.

Providing these essential features, as well as switch-selectable output-frequencies, the calibrator of the HM 1005 can, under certain conditions, replace expensive squarewave generators when testing or compensating wideband-attenuators or -amplifiers. In such a case, the input of an appropriate circuit will be connected to one of the **CAL.**-outputs via a suitable probe.

The voltage provided at a high-impedance input ($1\text{M}\Omega \parallel 15\text{-}50\text{pF}$) will correspond to the division ratio of the probe used ($10:1 = 20\text{mV}_{pp}$, $100:1 = \text{also } 20\text{mV}_{pp}$ from 2V output). Suitable probes are HZ51, 52, 53, and 54.

For low-impedance inputs (e.g. $50\ \Omega$), a 1:1 probe can be employed which, however, must be fully terminated with a $50\ \Omega$ through-termination. Suitable probe types are HZ50 and HZ54. The latter must be switched to the 1:1 position, and the HF-trimmer in the connecting box turned fully counterclockwise.

When connected to the **0.2V CAL.** socket, and using the HZ50, this arrangement will provide approx. 40mV_{pp} at $50\ \Omega$ circuit input, and approx. 24mV_{pp} if the HZ54 is used. The voltages given here will have larger tolerances than 1% since operation of a 1:1 probe together with a $50\ \Omega$ load is very uncommon.

Using the **2V CAL.** socket under similar conditions is only possible with the **HZ54** probe. The potential obtained at the $50\ \Omega$ input will then be approx. 190mV_{pp} , but with almost twice the risetime. Accurate readings of the available input voltage can be shown directly on the HM1005 when connecting a $50\ \Omega$ through-termination between the BNC plug of the probe and the input of the oscilloscope.

Operating Modes of the Y Amplifier

The required operating modes are selected on five pushbuttons located in the Y-Section. For **Mono** operation all pushbuttons should be in the out position, the instrument is then operating on **Channel I** only.

The desired operating mode for the vertical amplifiers is selected using the 5 pushbuttons in the Y section of the front control panel. For single channel operation of channel I, none of the buttons should be depressed.

For single channel operation of channel II, press the button **CH.I/II-TRIG.I/II**. It is also necessary to switch over to channel II for triggering.

If only the **DUAL** button is depressed, channels I and II are operational in alternate mode. If the CH.III button is depressed too, channel III is added. Alternate mode is not suited for display of slow events. Either the screen flicker is too great, or the traces appear to jump back and forth. If the **ADD** button is pressed additionally, fast switching between the channels is performed (chopped mode). In this case the display of slow events is flicker-free.

If only the **ADD** button is depressed, the signals of channels I and II are added ($I+II = \text{sum display}$). If channel II is inverted (**INV.II** depressed), the difference between the two channels is displayed ($+I - II$). In both of these operating modes the vertical position of the screen image is influenced by the Y POS. controls of both channels. It is not possible to add channel III as well.

Differential measurements techniques allow direct measurement of the voltage drop across floating components (both ends above ground). Two identical probes should be used for both vertical inputs. Using a separate ground connection and **not** connecting the probe or cable shields to the circuit under test avoid ground loops (hum, common-mode disturbances).

X-Y Operation

For **X-Y operation**, the pushbutton **XY** in the X-Section and **CH.I/II-TRIG.I/II** (in the Y section) must be depressed. The X signal is then derived from the **Channel I** input. **The calibration of the X signal during X-Y operation is determined by the setting of the Channel I input attenuator and variable control.** This means that the sensitivity ranges and input impedances are identical for both the X and Y axes. However, the **Y-POS.** control is disconnected in this mode. Its function is taken over by the **X-POS.** control. It is important to note that the **MAG. x10** facility, normally used for expanding the sweep, should not be operated in the X-Y mode. It should also be noted that the bandwidth of the X amplifier is approximately 4 MHz (-3dB), and therefore an increase in phase difference between both axes is noticeable from 50 kHz upwards.

The Y-Input signal may be inverted by using the **INV.II** facility.

Channel III cannot be operated when XY mode is selected.

Y Overscanning Indication

This indicating facility shows any overscanning of the usable screen dimensions **in the vertical direction**, if the baseline or signal portions are not within the graticule. The indication is achieved by 2 light-emitting diodes, marked **OVERSCAN**, which are located in the center between the attenuators. Should one LED illuminate without an input signal, this means that the respective vertical positioning control has been improperly adjusted. Because each LED correlates with one of both possible directions, it can be seen in which direction the trace has left the screen. With dual channel operation, misadjustment of both **Y-POS.** controls can occur. If both traces lie in the same direction, one LED illuminates likewise. If one trace is positioned above and the other below the graticule, both LEDs are illuminated. The indication of the Y position after crossing the graticule area occurs **in each operating mode**, also when, due to missing time deflection, no baseline is displayed, or when the oscilloscope is in the X-Y mode.

As previously written in the paragraph "First Time Operation", the **LEVEL A** control knob should be switched in **AT** position, as a baseline is then permanently displayed, also without any input signal. The trace disappears at times after applying an input signal. The LED indication shows, in which direction the trace has left the screen, above or below the graticule. Illumination of both LEDs at the same time after applying a signal means that the vertical deflection has overscanned the graticule edges in both vertical directions. With **DC** input coupling and an applied signal with a relatively high DC offset, smaller sizes also of displayed signals can overscan the raster edges, because the DC voltage causes a vertical position shift of the display height, which seemed correctly adjusted. In this case, a smaller display height must be accepted, or **AC** input coupling has to be selected.

Triggering and Timebase (A)

With the **LEVEL A** knob in locked position (turned ccw to **AT** position = automatic triggering), a baseline for timebase **A** is displayed continuously even when no signal is present. In this position it is possible to obtain stable displays of virtually all uncomplicated, periodically repeating signals above 30Hz. Adjustments of the timebase then are limited to timebase setting.

With normal triggering (**LEVEL A** knob not in **AT** position) and **LEVEL** adjustment, triggering of time/div. deflection in timebase **A** can be set in any point of a given signal. The triggering range which can be set with the **LEVEL** control depends greatly on the amplitude of the displayed signal. If it is less than 1 div, then the range is quite small and performance of settings requires a delicate touch.

If the **LEVEL** control is incorrectly set, no trace will be visible; this also applies to timebase **B**, which can only be triggered if timebase **A** has already been triggered, even when the triggering signal event has not been displayed (**A/B** button depressed).

In order to obtain a satisfactory stable display, the timebase must be triggered synchronously with the test signal. The trigger signal can be derived from the test signal itself, when internal triggering is selected, or from a frequency related signal applied to the external trigger input.

Triggering can be selected on either the rising or falling edge of the trigger signal depending on whether the **SLOPE +/-** pushbutton (next to **LEVEL A**) is in the out or in position. In the out position, triggering from the positive-going edge is selected. The correct slope setting is important in obtaining a display when only a portion of a cycle is being displayed.

With **internal triggering** in the **Mono channel mode** on the Y amplifier, the trigger signal is derived from the respec-

tive channel in use. In the **Dual channel mode**, the internal trigger signal may be selected from either **Channel I** or **Channel II** using the **CHI/II-TRIG.I/II** button; in the out position, the trigger signal is derived from Channel **I**. However, it is always preferable to trigger from the less complicated signal.

With **internal alternate triggering** (**ALT** pushbutton in the X-Section depressed) in the **DUAL** channel alternate mode of the Y amplifier, the trigger voltage is derived **alternately from Channel I and Channel II**. This trigger mode is particularly useful when **two asynchronous signals** are being investigated. Normal triggering should be preferable in this mode. The display of one signal only is not possible on the alternate trigger mode.

In 3 channel mode, channel **III** is triggered with channel **II**, and thus must be synchronized with it. Alternate triggering does not work in chopped mode (with **ADD** and **DUAL** buttons depressed).

For **external triggering**, the **EXT.** pushbutton in the X-Section must be depressed. The sync. signal ($0.2V_{pp}-2V_{pp}$) must then be fed to the **TRIG. INP.** input socket.

Coupling mode and frequency range of the trigger signal are selected with the **TRIG.** slide switch in the X-Section for internal and external triggering, provided that the **TV SEP.** switch is in off position. The HM1005 has 4 coupling modes: **AC**, **DC**, **HF**, **LF**. The **AC** coupling mode is mainly used. **DC** trigger coupling is only recommended, when very low frequency signals are being investigated and triggering at a particular value is necessary, or when pulses, which significantly change in duty cycle during observation time, have to be displayed. If **DC** coupling is selected, it is advisable to use the **normal triggering** mode. In the **HF** coupling mode, a **high pass filter** is switched into the trigger amplifier. This filter cuts off the DC content of the trigger signal and the lower frequency range.

In the **LF** coupling mode, a **low-pass filter** is switched into the trigger amplifier. This filter cuts off any amplifier noise and the frequency range of the trigger signal above 1 kHz.

For the purpose of **line triggering** (**TRIG.** slide switch in the X-Section to \sim (divided) secondary voltage of the power transformer is used as a trigger signal. This trigger mode is independent of the signal amplitude or display height and allows a display below the (internal) trigger threshold. Line triggering is recommended for all signals which are time-related (multiple or submultiple) to the mains/line frequency or when it is desirable to provide a stable display of a line-frequency component in complex waveforms. Therefore it is especially suited for the measurement of small ripple voltages from power supply rectifiers or of magnetic or static leakage fields in a circuit.

In some countries, the standard power plug has symmetrically arranged plugs (interchanging of **L**ine and **N**eutral is possible). In such cases, the **SLOPE +/-** pushbutton may indicate the wrong polarity compared with the display (triggering with falling edge instead of rising edge). For correction, the power plug of the instrument has to be turned.

Triggering of video signals

The built-in active **TV-Sync-Separator** separates the sync pulses from the video signal, permitting the display of distorted video signals either in line (**H** = horizontal) or in frame (**V** = vertical) trigger mode. The **TV** lever switch has five positions: the **OFF** position is for normal operation.

The **TV: H+** and **H-** positions (horizontal = line) and the **TV: V+** and **V-** (vertical = frame) positions are used for video triggering. In these four positions the **TRIG.** coupling switch and the **LEVEL** control (in **NORM.** trigger mode) are inoperative. In the **TV: V+** and **V-** positions (frame triggering), a low-pass filter or integrating network is connected into circuit, which forms a trigger pulse sequence with frame frequency from the vertical sync pulses (incl. pre- and postequalizing pulses).

For correct video triggering, the + and - positions at **V** and **H** must be selected corresponding to the video input signal. If the sync pulses are placed above the picture content, **H+** or **V+** should be in use. For sync pulses below the picture content of the input signal, correct triggering, without any influence from changing picture contents, will be possible only in **V-** or **H-** setting. The **INVERT** pushbutton only changes the display on the CRT, not the input signal.

In **TV: H** trigger mode, the trigger point lies on the starting edge of a sync pulse if **SLOPE A** button is in + position. As mentioned before, in **TV: V** mode an integrating network is additionally added to the sync separator which delays the formed trigger pulse by about 50 μ s.

Video signals are triggered in the automatic mode. Therefore the adjustment of the trigger point is superfluous. The internal triggering is virtually independent of the display height, which may differ from 0.8 to 8 div. As opposed to **AT** mode, when in **normal** mode, the screen is blanked without signal at the input (turning the **LEVEL** knob is ineffectual).

HOLD OFF

If it is found that a trigger point cannot be located on extremely complex signals even after repeated and careful adjustment of the **LEVEL** control (**Normal Triggering** mode), a stable display may be obtained using the **HOLD-OFF** control (in the X-Section). This facility varies the hold-off time between two sweep periods up to the ratio 10:1. Pulses or

other signal waveforms appearing during this off period cannot trigger the timebase. Particularly with burst signals or aperiodic pulse trains of the same amplitude, the start of the sweep can be shifted to the optimum or required moment. After specific use the **HOLD-OFF** control should be re-set into its calibration detent **x1**, otherwise the brightness of the display is reduced drastically.

Function of var. HOLD-OFF control

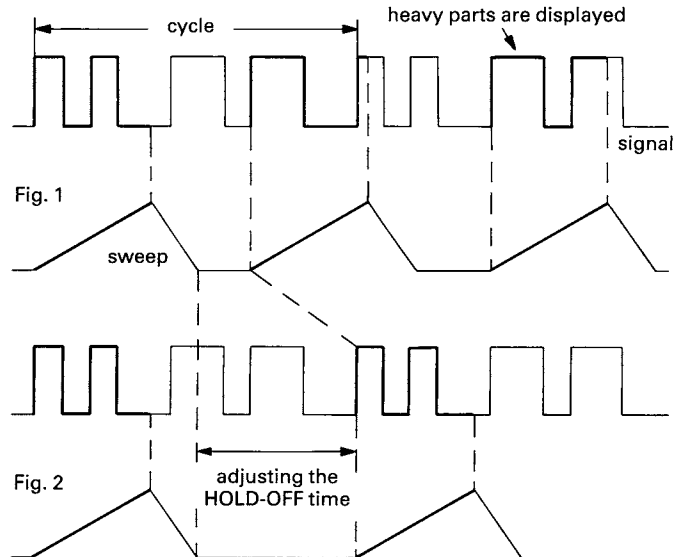

Fig. 1 shows a case where the **HOLD-OFF** knob is in the **x1** position and various different waveforms are overlapped on the screen, making the signal observation unsuccessful.

Fig. 2 shows a case where only the desired parts of the signal are stably displayed.

Single Sweep Operation

Single processes or events, e.g. current surge, voltage on contact breaking, or the display of the decay of a resonant circuit after pulse excitation can be represented with single sweep. For this, the **SINGLE** pushbutton in the X-Section has to be depressed. An LED marked **RESET** indicates the readiness of the sweep. If the **RESET** LED is not illuminated, this pushbutton must also be pressed. Indeed, it is possible in some cases to operate with Automatic Triggering (**AT**). The trace starts then approximately on the baseline level. This trigger mode is very sensitive: hence small unwanted signals can prematurely trigger a single sweep. For the triggering at higher or lower level values or with very slow frequencies the **Normal Triggering** is much more advantageous. It is favorable to previously determine the best setting of the **LEVEL A** control in normal timebase operation using a similar signal voltage. If it is correctly adjusted, the next suitable trigger pulse starts the single sweep. After its run the **RESET** LED goes out. For a repetition of the action, the **RESET** button must be pressed once more. With single shot, only relatively slow processes can be observed visually. Usually a photographic record is more advantageous.

The time coefficient settings on the **TIME/DIV.** switch are calibrated when the variable control (small knob on the **TIME/DIV.** switch) is set in the **CAL.** position. When this control is set fully counter-clockwise, the sweep speed is decreased by a factor of at least 2.5. This factor is not precisely calibrated. When the x10 expansion of the sweep (**X MAG. x10** button pressed) is operated, a maximum sweep speed of approximately 10ns/div is obtained (**TIME/DIV.** switch to **0.1 μs/div**). The choice of the optimum time coefficient depends on the repetition rate of the signal being measured. The number of cycles displayed will increase with the time coefficient (by turning the **TIME/DIV.** switch counter-clockwise).

Trigger Indicator

An LED on condition (above the **TRIG.** switch) indicates that the sweep generator is triggered. This is valid with automatic and normal triggering. The indication of trigger action facilitates a sensitive **LEVEL** adjustment, particularly at very low signal frequencies. The indication pulses are of only 100ms duration. Thus for fast signals the LED appears to glow continuously, for low repetition rate signals, the LED flashes at the repetition rate or – at the display of several signal periods – not only at the start of the sweep, but also at each signal period.

Timebase B (DEL. TB)

The **TIME/DIV.** field contains the controls for timebases **A** and **B**. From the inside towards the outside, these are: the fine adjustment knob for timebase **A** (turned clockwise all the way = calibrated), the time/division coefficient setting knob for time **A**, with settings from 1 s/div. to 0.05 μs/div., and the outer (transparent) dial for setting the time/division coefficient of timebase **B** (with settings from 0.2s/div. to 0.05 μs/div). The setting range for timebase **B** is marked by a black border.

Timebases **A** and **B** are alternately displayed when the **A/B** button is released and the **ALT.** button is depressed. The input signal is then displayed with timebases **A** and **B**, and the trace separator control (**TRACE SEP.**) in the Y section of the control panel can be used to adjust the vertical separation of the two traces by approx. ±3 div. A brightened section is superimposed onto the displayed trace for timebase **A**, the intensity of which can be adjusted with **INT. B**. In order to make this brightened section easily visible, **INT. B** should be turned clockwise all the way and **INTENS.** to an intermediate setting. In addition, timebase **B** should be set to a speed which is at least 10 times as fast as **A**.

If timebase **B** is 10 times as fast as **A**, the width of the bright section is 1 div. Consequently, the brightened section of the

A trace is displayed by the **B** trace magnified 10 times. At higher magnifications (by turning the timebase **B** time/div. control knob clockwise) the brightened section becomes narrower. By manipulating the **DEL. POS.** control any desired position on the **A** trace can be selected for display with **B**. The delay time adjustable with **DEL. POS.** is derived from the distance from the lefthand screen edge to the beginning of the brightened section in the trace for timebase **A**. Since timebase **A** must not be faster than timebase **B**, the knobs are mechanically linked in such a way as to prevent this.

At X-magnification factors above 1000x the intensity of the **B** trace drops off significantly, and jitter can also become detectable. To eliminate the jitter, timebase **B** should be triggered. To do so, turn the **LEVEL B** control away from the **FR** (=free-running) position to a suitable triggering setting; in addition, the corresponding slope selection switch (+/-) can be used to select the slope of the triggering signal edge. If the setting of **DEL. POS.** is now varied, the result is not continuous shifting of the brightened sector as before, but instead a "jumping" from signal edge to signal edge.

If the intensity of the **B** trace is excessively reduced at this point and the intensity of the **A** trace is too bright for comfortable viewing, press the **A/B** button. This results in only timebase **B** being displayed, and it is displayed at the location on the Y-axis previously occupied by the **A** trace. It is of course necessary to continue triggering timebase **A** even if it is not visible, since otherwise neither trace would be displayed.

The DELAY TIME display located above the **DEL.POS.** control is active when the alternate timebase mode is selected or pushbutton **A/B** is depressed (**B** Timebase only).

The values between 0 and 999 displayed, correspond to the starting position of the intensified sector which is visible during alternate timebase mode (pushbutton **ALT** depressed).

To calibrate the delay time display, the following steps should be taken:

1. Depress **ALT** pushbutton for alternate timebase mode.
2. Rotate Timebase Variable control fully clockwise to **CAL** position.
3. Set **LEVEL B** to **FR** position (Free Run).
4. Turn **DEL.POS.** control until "500" is displayed.
5. Reduce trace intensity until only the intensified sector remains visible.
6. Using **X-POS** control, move the beginning of the intensified sector to coincide with the vertical centre line of the graticule.

For very accurate results, it may be necessary to repeat this procedure for different timebase settings.

The relative delay time between timebase **A** and timebase **B** can be calculated by.

(Time coefficient Timebase A * display value 100).

Miscellaneous

Sawtooth Output

A positive-going **sawtooth voltage** of approximately $5V_{pp}$ originating from timebase A, coincident with display's sweep time is available at a BNC output connector on the rear panel. This ramp output is marked with a \mathcal{M} symbol. The load resistance should not be less than $100\text{ k}\Omega$ with a capacity load less than 30 pF . If the DC potential of the ramp output is not required, a capacitor should be connected in series with the output. The ramp output can be used for different measuring tasks in combination with the oscilloscope and other instruments, e.g. swept-frequency signal generators and so on.

Z Modulation

Blanking or intensity **Z-modulation** respectively of the CRT display is possible using the input connector marked **Z** on the rear panel. High TTL level (positive logic) effects blanking, low level gives unblanking. No higher voltages than $5V_{pp}$ are permitted. The sine- or square-wave generator, required for a blanking signal, must have an output impedance $< 600\ \Omega$. A square-wave generator with negative pulses to ground (chassis) is not suitable. Also an offset (DC) voltage is not allowed for periodic modulation. For setting the blanking duty factor, the output voltage of a sine-wave generator should be adjustable. The Z-modulation occurs in bright-dark steps. An analog Z-modulation with continuous gradation of tones is not possible. The modulating generator should have a sync input or – at least – an incremental frequency control, if an evaluation of the Z-modulation is necessary (blanking gaps as time markers). Generally, it is suitable to generate the Z-modulating frequency by multiplying the measuring frequency. Then the display shows stationary time markers.

Y Output

The oscilloscope also contains a **vertical output** with BNC connector marked **Y** on the rear panel. The output voltage is $45\text{ mV}_{pp}/\text{cm}$ display height (into $50\ \Omega$). It is picked off from the vertical amplifier like the trigger signal and it is similarly switchable. Channel **I** or **II** is selected with the **CH.I/II-TRIG.I/II** trigger pushbutton in the Y-Section. With alter-

nate channel switching (**DUAL** button in the Y-Section depressed) and alternate triggering (**ALT.** button in the X-Section depressed), the vertical output is consecutively driven (in time with the sweep period) from Channel I and Channel II. The vertical output is not dependent on the vertical trace position. It does not respond to the adjustment of the **Y-POS.I** and **Y-POS.II** controls and to the depressing of the **INVERT.II** button. The vertical output is DC coupled and has approximately zero level to ground. The bandwidth of the output is approx. 80 MHz (with $50\ \Omega$ termination).

Scale Illumination

Especially for the photographic recording of displays, the oscilloscope has a **raster illumination**. Normally, the raster, which is necessary for the point-by-point evaluation, is not visible without illumination. Variation of the brightness is possible on two steps with a slide switch marked **ILLUM.**, which is mounted below the screen. In the uppermost position, the illumination is switched off. The optimum setting depends on the camera and film exposure index used. Possibly some test pictures are required for a good representation of the graticule.

Accessories

Each HAMEG oscilloscope is supplied with an Instruction Manual and probes. However, a wide range of accessories, which include test cables and probes, are available and should be ordered according to the particular application.

Applications

Amplitude Measurements

With the designations

H = display height in div,

U = signal voltage in V_{pp} at the vertical input,

D = deflection coefficient in V/div at attenuator switch, the required quantity can be calculated from the two given quantities:

$$U = D \cdot H \qquad H = \frac{U}{D} \qquad D = \frac{U}{H}$$

However, these three values are not freely selectable. They have to be within the following limits (trigger threshold, accuracy of reading):

H between 0.5 and 8 div, if possible 3.2 to 8 div,

U between 1 mV_{pp} and 40V_{pp},

D between 5 mV/div and 5V/div in 1-2-5 sequence.

D between 1 mV/div and 1V/div in 1-2-5 sequence (*with pulled MAG x5 knob*).

Examples:

Set deflection coefficient **D** = 50 mV/div \triangleq 0.05 V/div, observed display height **H** = 4.6 div, **required voltage U** = 0.05 · 4.6 = **0.23 V_{pp}**.

Input voltage **U** = 5V_{pp},

set deflection coefficient **D** = 1V/div,

required display height H = 5:1 = **5 div**

Signal voltage $U = 220V_{rms} \cdot 2 \cdot \sqrt{2} = 622 V_{pp}$

(voltage > 160V_{pp}, with probe X100: **U** = 6.22 V_{pp}),

desired display height **H** = min. 3.2 div, max. 8 div,

max. deflection coefficient **D** = 6.22 : 3.2 = 1.94V/div,

min. deflection coefficient **D** = 6.22 : 8 = 0.78V/div,

adjusted deflection coefficient D = **1V/div**

Time Measurements

With the designations

L = displayed wave length in div of one period,

T = time in seconds for one period,

F = recurrence frequency in Hz of the signal,

T_c = time coefficient in s/div on timebase switch

and the relation **F** = 1/T, the following equations can be stated:

$$T = L \cdot T_c \qquad L = \frac{T}{T_c} \qquad T_c = \frac{T}{L}$$

$$F = \frac{1}{L \cdot T_c} \qquad L = \frac{1}{F \cdot T_c} \qquad T_c = \frac{1}{L \cdot F}$$

With X-MAG. x10 button pushed the T_c value must be divided by 10.

However, these four values are not freely selectable. They have to be within the following limits:

L between 0.2 and 10 div, if possible 4 to 10 div,

T between 5 ns and 10 s,

F between 0.1 Hz and 80 MHz,

T_c between 50 ns/div and 1 s/div in 1-2-5 sequence (with **X MAG. x10** in out position), and

T_c between 5 ns/div and 0.1 s/div in 1-2-5 sequence (with pushed **X MAG. x10** knob).

Examples:

Displayed wavelength **L** = 7 div,

set time coefficient **T_c** = 0.5 μs/div,

required period T = 7 · 0.5 · 10⁻⁶ = **3.5 μs**

required frequency F = 1 : (3.5 · 10⁻⁶) = **286 kHz**.

Signal period **T** = 0.5 s,

set time coefficient **T_c** = 0.2 s/div,

required wavelength L = 0.5 : 0.2 = **2.5 div**.

Displayed ripple wavelength **L** = 1 div,

set time coefficient **T_c** = 10 ms/div,

required ripple freq. F = 1 : (1 · 10 · 10⁻³) = **100 Hz**.

TV-line frequency **F** = 15 625 Hz,

set time coefficient **T_c** = 10 μs/div,

required wavelength L = 1 : (15 625 · 10⁻⁵) = **6.4 div**.

Sine wavelength **L** = min. 4 div, max. 10 div,

Frequency **F** = 1 kHz,

max. time coefficient **T_c** = 1 : (4 · 10³) = 0.25 ms/div,

min. time coefficient **T_c** = 1 : (10 · 10³) = 0.1 ms/div,

set time coefficient T_c = **0.2 ms/div**,

required wavelength L = 1 : (10³ · 0.2 · 10⁻³) = **5 div**.

Displayed wavelength **L** = 0.8 div,

set time coefficient **T_c** = 0.5 μs/div,

pressed X MAG x10 button: T_c = 0.05 μs/div,

required frequency F = 1 : (0.8 · 0.05 · 10⁻⁶) = **25 MHz**,

required period T = 1 : (25 · 10⁶) = **40 ns**.

X-Y Phase Measurements

The X-Y phase measurement method can be used to measure the phase difference between two signals of the same frequency. This provides a method of measurement for signal frequencies up to 120 kHz. However, above this frequency the inherent phase difference between the vertical and horizontal system makes accurate measurements difficult. In this mode, one of the sinewave signals provides horizontal deflection (X) while the other signal provides the vertical deflection (Y).

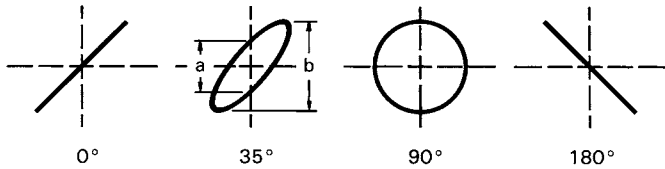

The phase angle between the two signals can be determined from the Lissajous pattern as follows:

$$\sin \varphi = \frac{a}{b}$$

$$\cos \varphi = \sqrt{1 - \left(\frac{a}{b}\right)^2}$$

$$\varphi = \arcsin \frac{a}{b}$$

This simple formula works for angles less than 90°, it is **independent** from both deflection amplitudes on the screen.

Caution!

If a single spot appears (both deflection voltages are missing) reduce the intensity immediately, as a high intensity setting may cause damage to the fluorescent screen of the CRT.

Dual-Trace Phase Difference Measurements

Phase comparison between two signals of the same frequency can be made using the dual-trace feature (**DUAL** button depressed). This method of phase difference measurement can be used up to the frequency limit of the vertical system. To make the comparison, use the following procedure:

Set the Input Coupling switches to the same position, and the **Trigger** pushbutton (**CHI/II-TRIG I/II**) to the channel where the reference signal (Phase 0°) is connected. Select **alternating** channel switching for frequencies above 1 kHz, and **chopping** for frequencies below 1 kHz. Use probes which have equal time delay to connect the signals to the input connectors. Set the Input Attenuator switches and the CHI and CHII variable controls so that the displays are approximately equal and about five divisions in amplitude. Set the **TIME/DIV.** switch to a sweep rate which displays about one cycle of the waveform. Move the waveforms to the center of the graticule with the **Y-POS.I** and **Y-POS.II** controls.

Turn the Variable Time Control until one cycle of the reference signal occupies exactly 10 divisions (see figure below). Each division represents 36° of the cycle.

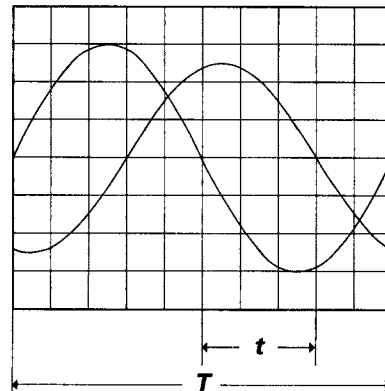

Dual-Trace Phase Difference Measurements

- T** = Horizontal distance **for one period** (cm).
- t** = Horizontal distance of zero-crossing points (cm).

Assume a horizontal difference of 3 divisions (**t** = 3 cm) and a period of 10 divisions (**T** = 10 cm), the phase difference φ can be calculated using the following formula:

$$\varphi^\circ = \frac{t}{T} \cdot 360^\circ = \frac{3}{10} \cdot 360^\circ = 108^\circ$$

or

$$\text{arc } \varphi = \frac{t}{T} \cdot 2\pi = \frac{3}{10} \cdot 2\pi = 1.885 \text{ rad}$$

respectively.

Measurement of an amplitude modulation

The momentary amplitude **u** at time **t** of a HF-carrier voltage, which is amplitude modulated without distortion by a sinusoidal AF voltage, is in accordance with the equation

$$u = U_T \cdot \sin \Omega t + 0,5m \cdot U_T \cdot \cos(\Omega - \omega)t - 0,5m \cdot U_T \cdot \cos(\Omega + \omega)t$$

- where **U_T** = unmodulated carrier amplitude
- Ω** = **2πF** = angular carrier frequency
- ω** = **2πf** = modulation angular frequency
- m** = modulation factor (≤ 1 ≙ 100%).

The lower side frequency **F-f** and the upper side frequency **F+f** arise because of the modulation apart from the carrier frequency **F**.

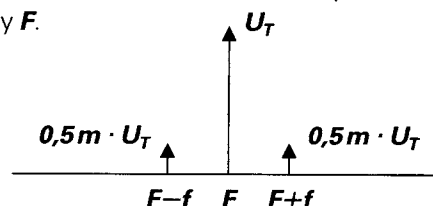

Figure 1
Amplitude and frequency spectrum for AM display (**m** = 50%)

The display of the amplitude-modulated HF oscillation can be evaluated with the oscilloscope provided the frequency spectrum is inside the oscilloscope bandwidth. The time base is set so that several cycles of the modulation frequency are visible. Strictly speaking, triggering should be external with modulation frequency (from the AF generator or a demodulator). However, internal triggering is frequently possible with normal triggering using a suitable **LEVEL** setting and possibly also using the time variable adjustment.

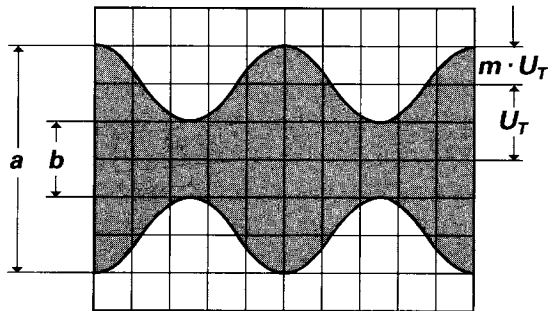

Figure 2
Amplitude modulated oscillation: $F = 1 \text{ MHz}$; $f = 1 \text{ kHz}$;
 $m = 50 \%$; $U_T = 28.3 \text{ mV}_{\text{rms}}$.

Oscilloscope setting for a signal according to figure 2:

Depress no buttons. **Y: CH. I; 20 mV/div; AC.**

TIME/DIV.: **0.2 ms/div.**

Triggering: **NORMAL** with **LEVEL**-setting; **internal (or external) triggering.**

If the two values **a** and **b** are read from the screen, the modulation factor is calculated from

$$m = \frac{a - b}{a + b} \quad \text{resp.} \quad m = \frac{a - b}{a + b} \cdot 100 [\%]$$

where $a = U_T (1+m)$ and $b = U_T (1-m)$.

The variable controls for amplitude and time can be set arbitrarily in the modulation factor measurement. Their position does not influence the result.

First Time Operation

Connect the instrument to power outlet. Switch on **POWER** pushbutton. No other button is pressed. LED indicates operating condition. **Case, chassis, and all measuring connectors are connected to the Safety Earth Conductor (Safety Class I).**

TRIG. selector switch to **AC**, **LEVEL** knob in to **AT** position.

HOLD-OFF control **x1**.

Adjust **INTENS.** control for average brightness.

Center trace on screen using **X-POS.** and **Y-POS.I** controls. Then focus trace using **FOCUS** control.

Operating Modes of the Vertical System

Channel **I**: All pushbuttons in out position.

Channel **II**: **CH I/II - TRIG. I/II** button pressed.

Channel **I and Channel II**: **DUAL** button only pressed = alternate channel switching.

Channel **I, II and Channel III**: **DUAL** and **CH III** buttons pressed.

Chopped channel switching: **DUAL** and **ADD.** buttons pressed. Signals < 1 kHz with **CHOP.**

Channel **I + II** (sum): **I + II ADD** button pressed only.

Channel **+ I – II** (difference): **I + II ADD and INV. II** buttons pressed.

Trigger Modes

Automatic Triggering: **LEVEL A** knob in **AT** position. Trace always visible.

Normal Triggering: **LEVEL** knob **not** in **AT** position: Trace visible when triggered.

Triggering from positive-going signal edge: **SLOPE A +/–** button is in out position.

Triggering from negative-going signal edge: **SLOPE +/– A** button pressed.

This facility is important when only a portion of a cycle is being displayed.

Internal triggering from Channel **I**: **CH I/II - TRIG. I/II** button in out position.

Internal triggering from Channel **II**: **CH I/II - TRIG. I/II** button pressed.

Both these internal trigger modes are valid also for dual and triple channel operation.

Internal alternate triggering: **ALT** button is pressed (only with alternate channel switching).

External triggering from **TRIG. INP.** connector: **EXT.** button pressed.

External trigger signal: 200 mV-2V_{pp}, time-related to vertical input signal.

Line triggering: **TRIG.** selector switch in \sim position.

Trigger coupling selected with **TRIG.** switch **AC-DC-HF-LF** (**DC** coupling needs normal triggering).

Trig. freq. range: **AC** and **DC** to 20 MHz, **HF** above 20 MHz, **LF** below 1 kHz.

Video signal mixtures with line freq.: **TV SEP.** switch to **H+** or **H–** position.

Video signal mixtures with frame freq.: **TV SEP.** switch to **V+** or **V–** position.

Pay attention to **TRIG.** indication LED!

Single sweep: with **SINGLE** and **RESET** buttons. Readiness: **RESET** LED is illuminated.

Measuring

Connect test signal to **CH.I** and/or **CH.II** and **CH.III** vertical input connector.

Compensate attenuator probe using **CAL.** square-wave signal.

Select **AC** or **DC** input coupling. **GD**: Y amplifier is disconnected from input and grounded.

Adjust required display height of signal with attenuator switch and variable control.

Pay attention to **OVERSCAN** indication!

Select sweep speed with **TIME/DIV. A** switch and variable control.

Adjust trigger point with **LEVEL A** control.

Calibrated amplitude measurement with attenuator variable control to **CAL.**

Calibrated time measurement with **TIME/DIV.** variable control to **CAL.**

Trigger complex or aperiodic signals using **HOLD-OFF** control in normal trigger mode.

Horizontal x10 expansion: **MAG. x10** button pressed.

External horizontal deflection: (**X-Y operation**) with **X-Y** and **CH I/II - TRIG I/II** buttons pressed (X input via **CH.I**).

Delayed Timebase Operation

Timebase **A** and **B** alternating: **A/B** not pressed, **ALT.** pressed.

Trace separation **A** opposite **B** by **TRACE SEP.** control.

Select the part to be displayed by timebase **B** by turning **DEL POS.** and observe intensified part on timebase **A**.

Trigger timebase **B** after delay using **LEVEL B** and **+/–** slope pushbutton.

To display timebase **B** only, press **A/B** pushbutton. Timebase **A** still has to be triggered.

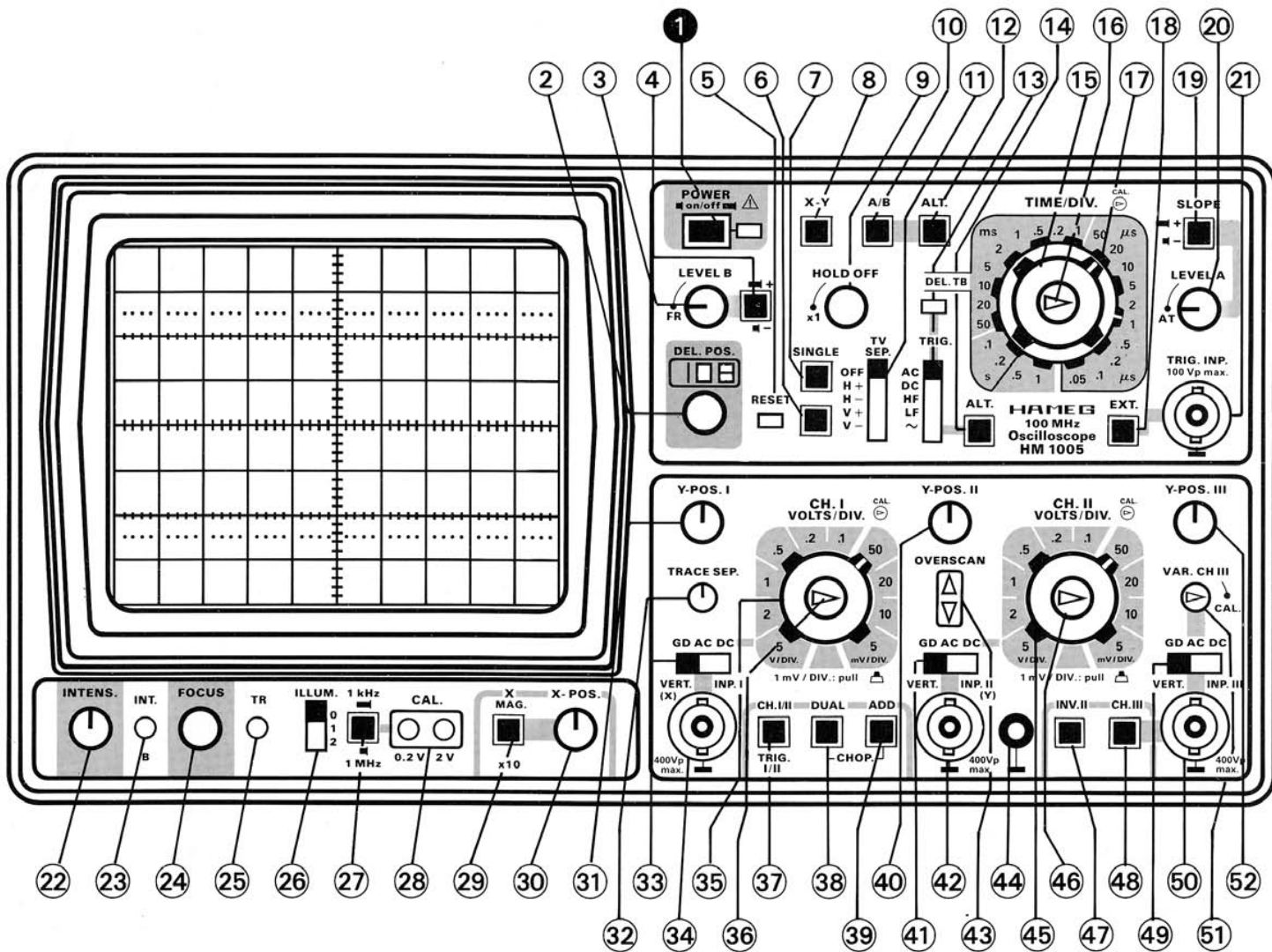

Element	Function	Element	Function
① POWER on/off (pushbutton + LED)	Turns scope on and off. LED indicates operating condition.	③① X-POS. (knob)	Controls horizontal position of trace.
② DEL. -POS. (knob)	Moves intensified part on trace A (delayed timebase B)	③② Y-POS. I (knob)	Controls vertical position of channel I display.
③ LEVEL B (knob)	Control for adjusting trigger level of timebase B	③③ TRACE SEP. (knob)	Moves trace of timebase B versus trace of timebase A vertically by at least ± 3 div.
④ +/- (pushbutton)	Selects trigger slope of timebase B.	③④ GD-AC-DC (slide switch)	Selects input coupling of the CH. I vertical amplifier. DC = direct coupling; AC = coupling via capacitor; GD = signal disconnected from input, Y amplifier input grounded.
⑤ RESET (LED)	Indicates arming for triggering (single).	③⑤ VERT. INP. I (BNC connector)	Channel I signal input. Input impedance $1\text{ M}\Omega \parallel 22\text{ pF}$. In XY mode: input for external horizontal deflection (⑧ pushed).
⑥ RESET (pushbutton)	Arms for single deflection LED (⑤) indicates readiness.	③⑥ CH. I-VOLTS/DIV. (10 position rotary switch)	Channel I input attenuator. Selects Y-input sensitivity in mV/div. or V/div. in 1-2-5 sequence.
⑦ SINGLE (pushbutton)	Single mode when pushed.	③⑦ Y-var. (knob and pull-push switch)	Increases Y attenuation factor min. by 2.5 (left hand stop). When pulled, increasing of sensitivity by a factor of 5 (max. 1 mV/div.)
⑧ X-Y (pushbutton)	Selects XY operation. X signal input via channel I. Attention! Phosphor burn-in without X signal.	③⑧ CH I/II-TRIG. I/II (pushbutton)	No button depressed: CH. I only and triggering from channel I. When depressed, channel II only and triggering from channel II. (Trigger selection in DUAL mode).
⑨ HOLD OFF (knob)	Controls holdoff time between sweeps. Normal position = fully ccw.	③⑨ DUAL (pushbutton)	<div style="display: flex; align-items: center;"> <div style="margin-right: 10px;"> <p>③⑩ ADD (pushbutton)</p> </div> <div style="border-left: 1px solid black; border-right: 1px solid black; padding: 0 5px; margin-right: 5px;"> <p>CHOP.</p> </div> <div style="margin-left: 10px;"> <p>③⑪ ADD (pushbutton)</p> </div> </div>
⑩ A/B (pushbutton)	When depressed = display of timebase B only.	③⑪ ADD (pushbutton)	
⑪ TV SEP. (lever switch)	Switch for TV-Sync.-Separator. OFF = normal operation. H+ / H- = trigg. of line (pos. or neg.) V+ / V- = trigg. of frame (pos. or neg.)	④① Y-POS. II (knob)	Controls vertical position of channel II display.
⑫ ALT. (pushbutton)	Alternating display of timebase A and timebase B when ⑩ not pushed.	④② GD-AC-DC (slide switch)	Selects input coupling of the channel II vertical amplifier. Similar to ③③.
⑬ TRIG. AC-DC-HF-LF~ (lever switch; LED indicator)	Trigger selector AC: 10 Hz to 40 MHz. DC: DC-40 MHz. HF: 1,5 kHz - 80 MHz. LF: DC - 1 kHz. ~: internal line triggering.	④③ VERT. INP. II (BNC connector)	Channel II input. Input impedance $1\text{ M}\Omega \parallel 22\text{ pF}$.
⑭ ALT. (pushbutton)	Alternating triggering in multichannel mode.	④④ OVERSCAN (LED indicators)	Direction indicators. Illuminated when trace passes vertical screen limits.
⑮ TIME/DIV. (23 step rotary switch)	Selects time coefficients (speeds) of timebase A from 1 s/div. to 0.05 μ s/div.	④⑤ Ground (4mm socket)	Separate ground jack.
⑯ Variable (center knob)	Variable adjustment of timebase A. Decreases X deflection speed at least 2.5 fold. Calibrated on right hand stop.	④⑥ CH. II-VOLTS/DIV. (10 position rotary switch)	Channel II input attenuator. Selects Y-input sensitivity in mV/div. or V/div. in 1-2-5 sequence.
⑰ TIME/DIV. (21 step rotary switch)	Selects time coefficients (speeds) of timebase B from 0.2 s/div to 0.05 μ s/div.	④⑦ Y-var. (knob and pull-push switch)	Increases Y attenuation factor min. by 2.5 (left hand stop). When pulled, increasing of sensitivity by a factor of 5 (max. 1 mV/div.)
⑱ EXT. (pushbutton)	Button depressed: external triggering. Trigger signal input via ⑳.	④⑧ INV. II (pushbutton)	Inversion of CH. II display. In combination with ADD button ③⑨ = difference CH. I - CH. II.
⑲ SLOPE +/- (pushbutton)	Selection of triggering on positive or negative going edge for timebase A.	④⑨ CH. III (pushbutton)	Adds CH. III when pushed.
⑳ LEVEL A (knob)	Adjustment of trigger level (timebase A) ccw = automatic triggering.	④⑩ GD-AC-DC (slide switch)	Selects input coupling of channel III vertical amplifier. Similar to ③③ and ④①.
㉑ TRIG. INP. (BNC connector)	Input for external trigger signal. (pushbutton ⑱ depressed.)	④⑪ VERT. INP. III (BNC connector)	Channel III input. Input impedance $1\text{ M}\Omega \parallel 22\text{ pF}$.
㉒ INTENS. (knob)	Intensity control for trace brightness.	④⑫ VAR. CH. III (knob)	Variable gain control for channel III. 50 mV/div. (right hand stop), min. 250 mV/div. (left hand stop).
㉓ INT. B (potentiometer; adjustment with screwdriver)	Intensity control for timebase B (A alternating B). Normal position = right hand stop.	④⑬ Y-POS. III (knob)	Controls vertical position of channel III display.
㉔ FOCUS (knob)	Focus control for trace sharpness.		
㉕ TR (potentiometer; adjustment with screwdriver)	Trace Rotation. To align trace with horizontal graticule line. Compensates influence of earth's magnetic field.		
㉖ ILLUM. 0,1,2 (3 pos. slide switch)	Graticule illumination. 0 = off; 1 = dim; 2 = bright.		
㉗ 1 kHz - 1 MHz (pushbutton)	Selects calibrator frequency. Button not depressed = 1 kHz; button depressed = 1 MHz.		
㉘ CALIBRATOR 0.2 V-2 V (test sockets)	Calibrator squarewave output, 0.2 V_{pp} or 2 V_{pp} resp. (frequ. adjust ㉗).		
㉙ X-MAG. x10 (pushbutton)	10 fold expansion in X direction. When depressed, max. resolution = 5 μ s/div.		

Test Instructions

General

These Test Instructions are intended as an aid for checking the most important characteristics of the HM 1005 at regular intervals without the need for expensive test equipment. Resulting corrections and readjustments inside the instrument, detected by the following tests, are described in the Service Instructions or on the Adjusting Plan. They should only be undertaken by qualified personnel.

As with the First Time Operation instructions, care should be taken that all knobs with arrows are set to their calibrated positions. None of the pushbuttons should be depressed. **LEVEL** knob in **AT** position, **TRIG.** selector switch A to **AC**, **TV SEP.** switch to **OFF.** It is recommended to switch on the instrument for about 30 minutes prior to the commencement of any check.

Cathode-Ray Tube: Brightness and Focus, Linearity, Raster Distortions

Normally, the CRT of the HM 1005 has very good brightness. Any reduction of this brightness can only be judged visually. However, decreased brightness may be the result of reduced high voltage. This is easily recognized by the greatly increased sensitivity of the vertical amplifier. The control range for maximum and minimum brightness (intensity) must be such that the beam just disappears before reaching the left hand stop of the **INTENS.** control (particularly when the **X-Y** button is depressed), while with the control at the right hand stop the focus and the line width are just acceptable.

With maximum intensity the timebase fly-back must on no account be visible. Visible display fault without input signal: Bright dot on the left side – **or** – decreasing brightness from left to right or shortening of the baseline. (Cause: incorrect Unblanking Pulse.) It should be noted that with wide variations in brightness, refocusing is always necessary. Moreover, with maximum brightness, no “pumping” of the display must occur. If pumping does occur, it is normally due to a fault in the regulation circuitry for the high voltage supply. The presetting pots for the high voltage circuit, minimum and maximum intensity, are only accessible inside the instrument (see Adjusting Plan and Service Instructions).

A certain out-of-focus condition in the edge zone of the screen must be accepted. It is limited by standards of the CRT manufacturer. The same is valid for tolerances of the orthogonality, the undeflected spot position, the non-linearity and the raster distortion in the marginal zone of the screen in accordance with international standards (see CRT data book). These limit values are strictly supervised by HAMEG. The selection of a cathode-ray tube without any tolerances is practically impossible.

Astigmatism Check

Check whether the horizontal and vertical sharpness of the display are equal. This is best seen by displaying a square-wave signal with the repetition rate of approximately 1 MHz. Focus the horizontal tops of the square-wave signal at normal intensity, then check the sharpness of the vertical edges. If it is possible to improve this vertical sharpness by turning the **FOCUS** control, then an adjustment of the astigmatism control is necessary. A potentiometer of 47 k Ω is provided inside the instrument for the correction of astigmatism. A certain loss of marginal sharpness of the CRT is unavoidable; this is due to the manufacturing process of the CRT.

Symmetry and Drift of the Vertical Amplifier

Both of these characteristics are substantially determined by the input stages of the amplifiers.

The symmetry of Channel II and the vertical final amplifier can be checked by inverting Channel II (depress **INV.II** pushbutton). The vertical position of the trace does not usually change by more than 5 mm. However, a change of 1 cm is just permissible. Larger deviations indicate that changes have occurred in the amplifier.

A further check of the vertical amplifier symmetry is possible by checking the control range of the **Y-POS.** controls. A sine-wave signal of 10-100 kHz is applied to the amplifier input. When the **Y-POS.** control is then turned fully in both directions from stop to stop with a display height of approximately **8 cm**, the upper and lower positions of the trace that are visible should be approximately of the same height. Differences of up to 1 cm are permissible (input coupling should be set to **AC**).

Checking the drift is relatively simple. **Thirty minutes after switching on the instrument**, set the baseline exactly on the horizontal center line of the graticule. The beam position must not change by more than **5 mm** during the following hour.

Calibration of the Vertical Amplifier

Two square-wave voltages of **0.2 mV_{pp}** and **2 V_{pp} ± 1 %** are present at the output sockets of the calibrator (**CAL.**). If a direct connection is made between the 0.2 mV output and the input of the vertical amplifier, the displayed signal in the **50 mV/cm** position (variable control to **CAL.**) should be **4 cm** high (**DC** input coupling). Maximum deviations of 1.2 mm (3 %) are permissible. If a **x 10 probe** is connected between the 2V-output socket and Y input, the same display height should result. With higher tolerances it should

first be investigated whether the cause lies, within the amplifier or in the amplitude of the square-wave signal. On occasions it is possible that the probe is faulty or incorrectly compensated. If necessary the measuring amplifier can be calibrated with an accurately known DC voltage (**DC** input coupling). The trace position should then vary in accordance with the deflection coefficient set.

With variable control at the attenuator switch fully counter-clockwise, the input sensitivity is decreased at least by the factor 2.5 in each position. In the **50 mV/div** position, the displayed calibrator signal height should vary from 4 div to at least 1.6 div.

When pulling the Y-expansion x5 knob (**MAG x5**), the sensitivity is increased by the factor 5. In the **0.2 V/div** position the displayed signal should change from 1 div to 5 div by pulling the **MAG x5** knob.

Transmission Performance of the Vertical Amplifier

The transient response and the delay distortion correction can only be checked with the aid of a square-wave generator with a fast risetime (**max. 5 ns**). The signal coaxial cable (e.g. HZ34) must be terminated at the vertical input of the oscilloscope with a resistor equal to the characteristic impedance of the cable (e.g. with HZ22). Checks should be made at 100 Hz, 1 kHz, 10 kHz, 100 kHz and 1 MHz, the deflection coefficient should be set at **5 mV/div** with **DC** input coupling (Y variable control in **CAL.** position). In so doing, the square pulses must have a flat top without ramp-off, spikes and glitches; no overshoot is permitted, especially at 1 MHz and a display height of **4-5 div**. At the same time, the leading top corner of the pulse must not be rounded. In general, no great changes occur after the instrument has left the factory, and it is left to the operator's discretion whether this test is undertaken or not.

Of course, the quality of the transmission performance is not only dependent on the vertical amplifier. **The input attenuators**, located in the front of the amplifier, **are frequency-compensated in each position**. Even small capacitive changes can reduce the transmission performance. Faults of this kind are as a rule most easily detected with a square-wave signal with a low repetition rate (e.g. 1 kHz). If a suitable generator with max. output of $40V_{pp}$ is available, it is advisable to check at regular intervals the deflection coefficients on all positions of the input attenuators and readjust them as necessary. A compensated **2:1 series attenuator** is also necessary, and this must be matched to the input impedance of the oscilloscope. This attenuator can be made up locally. It is important that this attenuator is shielded. For local manufacture, the electrical components required are a $1 M\Omega \pm 1\%$ resistor and, in parallel with it, a trimmer 3-15 pF in parallel with

approx. 15 pF. One side of this parallel circuit is connected directly to the input connector of the vertical amplifier and the other side is connected to the generator, if possible via a low-capacitance coaxial cable. The series attenuator must be matched to the input impedance of the oscilloscope in the **5 mV/div** position (variable control to **CAL.**, **DC** input coupling; square tops exactly horizontal; no ramp-off is permitted). This is achieved by adjusting the trimmer located in the 2:1 attenuator. **The shape of the square-wave should then be the same in each input attenuator position.**

Operating Modes: CH.I/II, DUAL, ADD, CHOP., INV.II and X-Y Operation

On depressing the **DUAL** pushbutton, two traces must appear immediately. If **CHIII** button is depressed too, three traces must be visible. On actuation of the **Y-POS.** controls, the trace positions should have no effect on each other. Nevertheless, this cannot be entirely avoided, even in fully serviceable instruments. When one trace is shifted vertically across the entire screen, the position of the other trace must not vary by more than 0.5 mm.

A criterion in chopped operation is trace widening and shadowing around and within the two traces in the upper or lower region of the screen. Set **TIME/DIV.** switch to **1 μ s/div**, depress the **DUAL** and **ADD** pushbutton to operate the oscilloscope in **CHOP.** mode, set input coupling of both channels to **GD** and advance the **INTENS.** control fully clockwise. Adjust **FOCUS** for a sharp display. With the **Y-POS.** controls shift one of the traces to a +2 div, the other to a -2 div vertical position from the horizontal center line of the graticule. Do not try to synchronize the chop frequency (1 MHz)! Then alternately release and depress the **ADD** pushbutton. Check for negligible trace widening and periodic shadowing in the chopped mode.

It is important to note that in the **I+II** add mode (only **ADD** depressed) or the **+I-II** difference mode (**INV.II** button depressed in addition) the vertical position of the trace can be adjusted by using **both** the Channel I and Channel II **Y-POS.** controls. If a trace is not visible in either these modes, the overscanning LEDs will indicate the position of the trace.

In X-Y Operation (**X-Y** pushbutton and **CH.I/II-TRIG.I/II** depressed), the sensitivity in both deflection directions will be the same. When the signal from the built-in square-wave generator is applied to the input of Channel II, then, as with Channel I in the vertical direction, there must be a horizontal deflection of **4 div** when the deflection coefficient is set to **50 mV/div** position (variable control set to its **CAL.** position, **X MAG. x10** depressed). The check of the mono channel display with the **CH.I/II** button is unnecessary; it is contained indirectly in the tests above stated.

Triggering Checks

The internal trigger threshold is important as it determines the display height from which a signal will be stably displayed. It should be approx. 5mm (frequency-dependent) for the HM1005. An increased trigger sensitivity creates the risk of response to the noise level in the trigger circuit, especially when the sensitivity of the vertical input is increased by pulling the **MAG. x5** knob. This can produce double-triggering with two out-of-phase traces. Alteration of the trigger threshold is only possible internally. Checks can be made with any **sine-wave voltage** between 50Hz and 1 MHz. The **LEVEL A** knob should be in **AT** position. Following this it should be ascertained whether the same trigger sensitivity is also present with Normal Triggering (**LEVEL A** knob in **NORMAL** position). In **NORMAL** trigger mode, a **LEVEL A** adjustment is necessary. The checks should show the same trigger threshold with the same frequency. On depressing the **SLOPE A +/-** button, the start of the sweep changes from the positive-going to the negative-going edge of the trigger signal. As described in the Operating Instructions, the trigger frequency range is dependent on the trigger coupling selected. For higher frequencies the **HF** coupling mode must be selected. In this mode, triggering up to at least 130MHz (sine-wave) is possible. Internally the HM1005 should trigger perfectly at a display height of approx. 5mm, when the appropriate trigger coupling mode is set.

For external triggering (**EXT.** button depressed), the **EXT. TRIG.** input connector requires a signal voltage of at least 200mV_{pp}, which is in synchronism with the Y input signal. The voltage value is dependent on the frequency and the trigger coupling mode (**AC-DC-HF-LF**).

Checking of the TV triggering is possible with a video signal of any given polarity. Use the **TV: H** positions of the **TV** switch for triggering on **line** or horizontal frequency (**TIME/DIV.** switch to 20 or 10µs/div). The **TV: V** positions are required for **frame** or vertical frequency (**TIME/DIV.** switch to 5 or 2ms/div). The + and - positions at V and H must correspond to the sync pulse.

Perfect TV triggering is achieved, when in both display modes the amplitude of the complete TV signal (from white level to the top of the line sync pulse) is limited between 0.8 and 8div.

The display should not shift horizontally during a change of the trigger coupling from **AC** to **DC** with a sine-wave signal without DC offset.

In the **dual channel mode** (**DUAL** button depressed) **with alternate channel switching and with alternate triggering** (**ALT.** button in the X-Section depressed), two non-frequency related signals (e.g. mains/line frequency signal and calibrator signal) should reliably be triggered.

If both vertical inputs are **AC** coupled to the same signal and both traces are brought to coincide exactly on the screen, when working in the **alternate dual channel mode**, then no change in display should be noticeable, when the **CH.I/II-TRIG.I/II** or the **ALT.** button are depressed or released.

Checking of the line/mains frequency triggering is possible, when the input signal is time-related (multiple or submultiple) to the power line frequency (**TRIG.** selector switch to \sim). In this trigger mode, there is no trigger threshold. Even very small input signals are triggered stably (e.g. ripple voltage). For this check, use an input of approx. 1V. The displayed signal height can then be varied by turning the respective input attenuator switch and its variable control.

Timebase A

Before checking the timebase it should be ascertained that the **trace length is 10div**. If not, it can be corrected with the potentiometer for sweep amplitude (see Adjusting Plan). This adjustment should be made with the **TIME/DIV. A** switch in a mid position (i.e. **5µs/div**). Prior to the commencement of any check set the time variable control to **CAL.** and the **HOLD-OFF** time control to **x1**. The **X MAG. x10** pushbutton should be released. This condition should be maintained until the variation ranges of these controls are checked.

Check that the **sweep runs from the left to the right side of the screen** (**TIME/DIV.** switch to **0.5s/div**; **X-POS.** control in mid-range). This check is only necessary after changing the cathode-ray tube.

If a precise marker signal is not available for checking the **Timebase** time coefficients, then an accurate sine-wave generator may be used. Its frequency tolerance should not be greater than $\pm 1\%$. The timebase accuracy of the HM1005 is given as $\pm 3\%$, but as a rule it is considerably better than this. For the simultaneous checking of timebase linearity and accuracy at least 10 oscillations, i.e. **1 cycle every div**, should always be displayed. For precise determination, set the peak of the first marker or cycle peak exactly behind the first vertical graticule line using the **X-POS.** control. Deviation tendencies can be noted after some of the marker or cycle peaks.

The **20** and **10ms/div** ranges of the **TIME/DIV.A** switch can be checked very precisely with line frequency (**50Hz** only). On the **20ms/div** range a cycle will be displayed every div, while on the **10ms/div** range it will be every 2 div.

If a precise Time Mark Generator is used for checking, normal Triggering (**LEVEL** knob turned cw) and **LEVEL** control adjustment is recommended.

The following table shows which frequencies are required for the particular ranges.

1	s/div	–	1	Hz	0.1	ms/div	–	10	kHz
0.5	s/div	–	2	Hz	50	μs/div	–	20	kHz
0.2	s/div	–	5	Hz	20	μs/div	–	50	kHz
0.1	s/div	–	10	Hz	10	μs/div	–	100	kHz
50	ms/div	–	20	Hz	5	μs/div	–	200	kHz
20	ms/div	–	50	Hz	2	μs/div	–	500	kHz
10	ms/div	–	100	Hz	1	μs/div	–	1	MHz
5	ms/div	–	200	Hz	0.5	μs/div	–	2	MHz
2	ms/div	–	500	Hz	0.2	μs/div	–	5	MHz
1	ms/div	–	1	kHz	0.1	μs/div	–	10	MHz
0.5	ms/div	–	2	kHz	0.05	μs/div	–	20	MHz
0.2	ms/div	–	5	kHz					

The **time variable control** range can also be checked. The sweep speed becomes slower by turning this variable control counter-clockwise to its left stop. 2.5 cycles at least every **div** should be displayed (with **X MAG. x10** pushbutton released; measurement in the **5 μs/div** range).

When the **X MAG. x10** button is depressed, a marker or cycle peak will be displayed every 10 div $\pm 5\%$ (with variable control in **CAL.** position; measurement in the **5 μs/div** range). The tolerance is better measurable in the **50 μs/div** range (one cycle every 1 div).

Check the ramp output voltage on rear panel (BNC connector marked by a sawtooth symbol) with a Test Oscilloscope.

Test Scope setting: 1V/div; Timebase to one step slower sweep speed than on the HM 1005 under test. The latter must have no input and no trigger voltage (free-running sweep; input coupling switch to **GD**). The sawtooth voltage is applied with a 50 Ω-BNC-BNC cable **without termination** from the ramp output connector to the input of the Test Scope. The Test Scope should show a positive-going linear sawtooth with an amplitude of approx. **5V_{pp}**. At the same time the function of the **HOLD-OFF** control can be checked. The hold-off time variation cannot be measured precisely with this method, because the unblanking pulse of the timebase generator is smaller than the ramp width.

Timebase B

If the **A/B** pushbutton is depressed timebase B is displayed only. Now it can be checked in the same way as in timebase A mode. To have 10 div trace length time in timebase B mode, it must be 10 times faster than timebase A, if maximum delay with **DEL. POS.** is set by rotating this control clockwise until the display shows the value of "999" ± 1 digit.

Trace Alignment

The CRT has an admissible angular deviation $\pm 5^\circ$ between the X deflection plane D1-D2 and the horizontal center line of the internal graticule. This deviation, due to tube production tolerances (and only important after changing the CRT), and also the influence of the earth's magnetic field, which is dependent on the instrument's North orientation, are cor-

rected by means of the **TR** potentiometer. In general, the trace rotation range is asymmetric. It should be checked, whether the baseline can be adjusted somewhat sloping **to both sides** round about the horizontal center line of the graticule. With the HM 1005 in its closed case, an angle of rotation $\pm 0.57^\circ$ (1 mm difference in elevation per 10 cm graticule length) is sufficient for the compensation of the earth's magnetic field.

Miscellaneous

Checking the blanking facility on the **Z** modulation connector (rear panel) is possible with a sine- or square-wave generator, which must have a relatively low output impedance (max. 600 Ω, max. 5V_{pp}). The sine-wave generator requires an output voltage control. The square-wave generator must deliver positive pulses to ground (chassis). Alternatively a small adjustable sine voltage from a (separate) power transformer may be used. For the latter set the **TIME/DIV.** range to e.g. **10ms/div**. With the TIMEBASE variable control, the gap in the baseline can be brought acceptably to a standstill. Line frequency triggering is better (**TRIG.** selector switch to \sim). The length ratio from bright to dark lines on the display is dependent on the sine voltage amplitude. Without a modulating generator, the function of the Z modulation can be checked coarsely by connecting 5V positive to ground at the Z input. Then the baseline is blanked completely.

A check of the **Y** output (rear panel) is possible on the screen using the dual channel mode by means of the calibrator signal. To this a connection is made from the calibrator socket (0.2V/1 kHz) to the **CH.I** input connector and – using a BNC-BNC cable and a 50 Ω through-termination – a second connection from the **Y** output to **CH.II** input connector. **Settings: CH.I** attenuator switch to **50mV/div**, **CH.II** attenuator switch to **0.1V/div**, **CH.I** input coupling to **DC**, **CH.II** input coupling to **GD**, **TIME/DIV. A** switch to **0.5ms/div**, automatic triggering (**LEVEL A** knob in **AT** position), **TRIG.** selector to **AC**, no button depressed. Now the square-wave signal is visible with **4div** display height. With **Y-POS.I** control, the tops of the square-wave are adjusted to ± 2 div from the horizontal center line of the graticule. Then the **DUAL** button has to be pressed. The appearing second trace (without signal) is adjusted to -2 div using the **Y-POS.II** control. Then the **CH.II** input coupling is set to **DC**. Now the signal across the **Y** output appears with the same phase position as the calibrator signal via Channel I. As well as the DC offset (e.g. $+0.8$ div \triangleq $+80$ mV) the amplitude (e.g. 1.8 div \triangleq 0.18 V_{pp}) of the **Y** output can be measured. In the example, the sensitivity of the **Y** output can be calculated as $0.18\text{V} : 4\text{div} = \mathbf{45\text{mV/div}}$.

If a variable mains/line transformer is available, the characteristics of the HM 1005 on power voltage fluctuations of $\pm 10\%$, referred to the voltage indicated by a triangle above the fuse holder (rear panel), should be checked. Under these conditions no variations should be detected on the display in either the vertical or horizontal axis.

HAMEG

Oscilloscopes

Multimeters

Counter Timers

Power Supplies

Calibrators

**Signal
Generators**

**Check Point
Testers**

West Germany

HAMEG GmbH

Kelsterbacher Str. 15-19
6000 FRANKFURT am Main 71
Tel. (069) 67805-0 · Telex 413866
Telefax (069) 6780513

France

HAMEG S.a.r.l.

5-9, av. de la République
94800-VILLEJUIF
Tél. (1) 46778151 · Télex 270705
Telefax (1) 47263544

Spain

HAMEG S.A.

Villarroel 172-174
08036 BARCELONA
Téléf. (93) 2301597 / 2301100
Telex 99816 · Telefax (93) 3212201

Great Britain

HAMEG LTD

74-78 Collingdon Street
LUTON, Bedfordshire LU1 1RX
Tel. (0582) 413174 · Telex 825484
Telefax (0582) 456416

United States of America

HAMEG, Inc.

88-90 Harbor Road
PORT WASHINGTON, NY 11050
Phone (516) 883-3837
Telex (023) 497-4606
Telefax (516) 883-3894

HAMEG, Inc.

Hancock Business Park
4790 Wesley Drive
ANAHEIM, CA 92807
Phone (714) 970-9575
Telefax (714) 970-0328