

INSTRUCTION AND MAINTENANCE MANUAL

ITHACO 4210 SERIES

VARIABLE ELECTRONIC FILTERS

JANUARY, 1979

7
I
T

 Instruments
233 CECIL A. MALONE DR.
ITHACA, NY 14850
607-277-8498

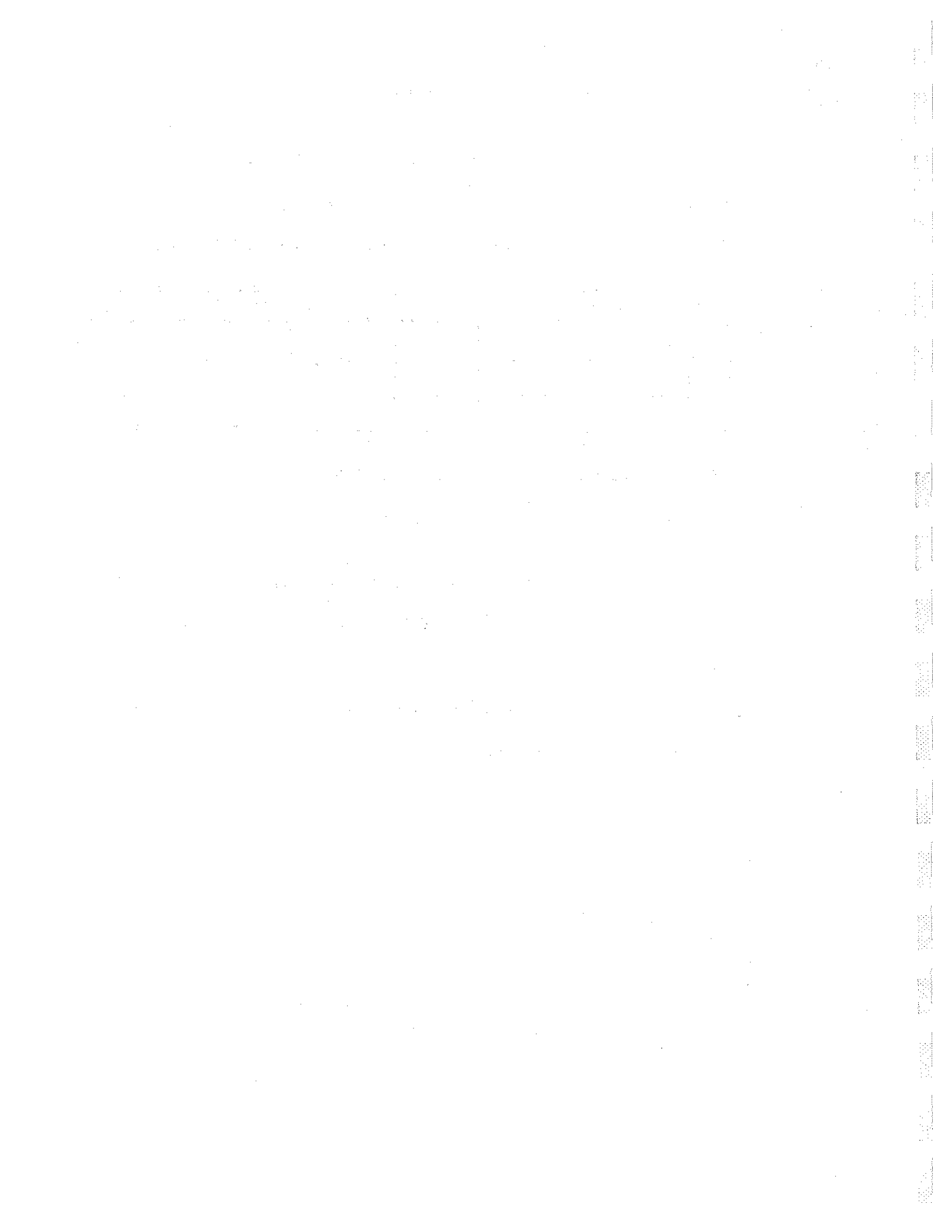



MANUAL CHANGES

ITHACO 4210 SERIES VARIABLE ELECTRONIC FILTERS

Date January 15, 1979

Supplement A

Make all changes in this manual according to the Errata below. Also check the following table for your instrument serial number and make the listed changes in your manual.

MODEL	SERIAL NO	MAKE MANUAL CHANGES	MODEL	SERIAL NO	MAKE MANUAL CHANGES
4210 Series	37854 up	1			

1. FILTER BROCHURE (Section 1) - 4210 SERIES SPECIFICATIONS - page 9

The following specifications should be changed:

Filter Drift

Delete the first line of copy.
Second line of copy should read:

$50\mu\text{V}/^\circ\text{C} + 250\mu\text{V}/\text{day}$ referred to the output 0 dB gain

Input - Impedance

should read:

$22\text{M}\Omega \pm 10\%$ // 100pF max.

Output - Offset and Drift

Delete all copy

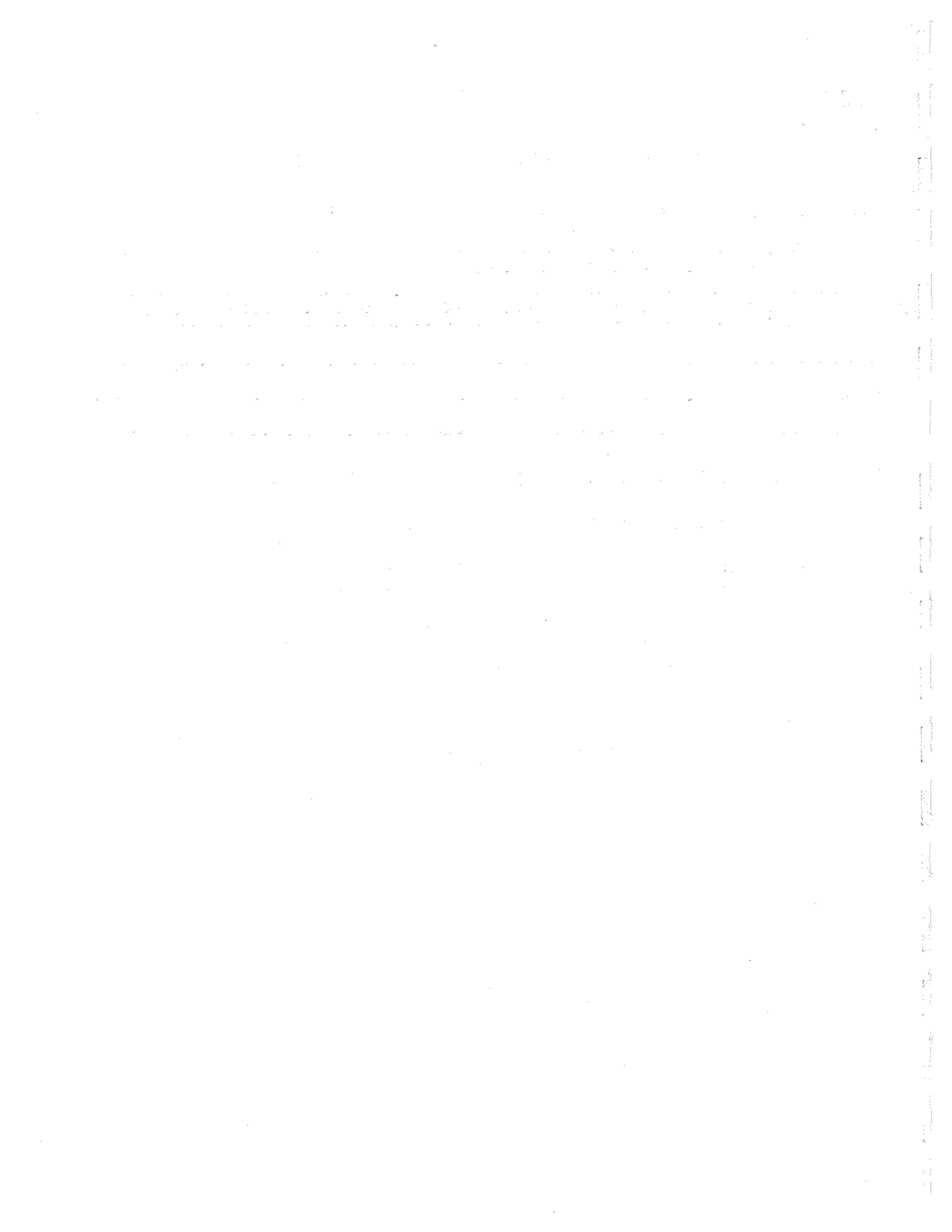

TABLE OF CONTENTS

<u>SECTION</u>	<u>DESCRIPTION</u>	<u>PAGE</u>
1.0	GENERAL DESCRIPTION	
1.1	Description	1 - 1
1.2	Options	1 - 1
1.2.1	Filter Amplifier Option - Option 02	1 - 1
1.2.2	Battery Option - Option 01	1 - 2
1.3	Specifications	1 - 2
1.3.1	High Frequency Maximum Input Signal	1 - 2
2.0	INSTALLATION	
2.1	Inspection	2 - 1
2.1.1	General	2 - 1
2.1.2	Visual Inspection	2 - 1
2.1.3	Electrical Inspection	2 - 1
2.2	System Grounds	2 - 1
3.0	OPERATION	
3.1	General	3 - 1
3.2	AC Coupled Input	3 - 1
3.3	Normal Mode Operation	3 - 2
3.3.1	Introduction	3 - 2
3.3.2	Normalized Filter Response	3 - 2
3.3.3	Operation as a High-Pass Filter	3 - 2
3.3.4	Operation as a Low-Pass Filter	3 - 2
3.3.5	Operation as a Band-Pass Filter	3 - 2
3.4	Pulse Mode Operation	3 - 3
3.4.1	Introduction	3 - 3
3.4.2	Operation as a Bessel Low-Pass Filter	3 - 3
3.5	Band-Reject Mode Operation	3 - 3
3.5.1	Introduction	3 - 3
3.5.2	Normalized Filter Response	3 - 4
3.5.3	Operation as a Band-Reject Filter	3 - 6
3.6	Optional Amplifier Operation	3 - 6
3.7	Battery Option	3 - 6
3.7.1	Battery Operation	3 - 6
3.7.2	Battery Recharging	3 - 6
3.7.3	Extended Battery Operation For Model 4213	3 - 7
4.0	THEORY OF OPERATION	
4.1	Filter Circuit	4 - 1
4.2	Amplifier Option - Option 02	4 - 2
4.3	Offset Correction for Input Bias Current	4 - 2

TABLE OF CONTENTS (Continued)

<u>SECTION</u>	<u>DESCRIPTION</u>	<u>PAGE</u>
5.0	TEST PROCEDURES	
	Recommended Test Procedure to make necessary adjustments and test filter performance	5 - 1
	Test Set-ups	5 - 15
	Recommended Test Procedure to calibrate the 0 to 40 dB amplifier stage	5 - 16
	Test Set-ups	5 - 19
6.0	REPLACEABLE PARTS	
6.1	Introduction	6 - 1
6.2	Ordering Information	6 - 1
	Reference Designations	6 - 1
6.4	Code List of Manufacturers	6 - 1
6.5	Amplifier Option	6 - 1
	Replaceable Parts	6 - 3
	Electronic Filter Card	6 - 3
	Power Supply Card	6 - 6
	Rear Panel	6 - 8
	Front Panel	6 - 8
	Current Source Card	6 - 9
7.0	DRAWINGS	
Figure 7.1	Filter Card Assembly Drawing	
Figure 7.2	Filter Card Elementary Diagram	
Figure 7.3	Power Card Assembly Drawing	
Figure 7.4	Power Card Elementary Diagram	
Figure 7.5	Amplifier Card Assembly Drawing	
Figure 7.6	Amplifier Card Elementary Diagram	
Figure 7.7	Current Source Assembly Drawing	
Figure 7.8	Current Source Elementary Diagram	
Figure 7.9	Final Assembly Drawing - Sheet 1	
Figure 7.10	Final Assembly Drawing - Sheet 2	
	Data Sheets	
	LM310	
	715	

LIST OF FIGURES

- Figure 1.1 Maximum Input Signal Swing VS Frequency
- Figure 3.1 Front Panel Controls and Connectors
- Figure 3.2 Rear Panel Controls and Connectors
- Figure 3.3 Phase and Amplitude Response of AC Coupled Input of 4210 Series Variable Electronic Filters
- Figure 3.4 Band Reject Normalized Family Centered at 1.0
- Figure 3.5 Band Reject Normalized Family Centered at 1.12
- Figure 3.6 Band Reject Sharp Notch Normalized Response
- Figure 3.7 Battery Charging Period VS AC Line Voltage
- Figure 4.1 Two Isolated RC Sections of a Low-Pass Filter Section
- Figure 4.2 Two Isolated RC Sections of a Low-Pass Filter Section with Positive Feedback
- Figure 4.3 Response Curve for Two Pole Low-Pass Filter Section
- Figure 4.4 Two Quadratic Sections Cascaded To Form A Four Pole Low-Pass Filter
- Figure 4.5 Two Isolated RC Sections of a High-Pass Section with Positive Feedback
- Figure 4.6 Response Curve for Two Pole, High-Pass Section
- Figure 4.7 Two Quadratic Sections Cascaded to Form a Four Pole High-Pass Filter
- Figure 4.8 1st and 2nd Quadratic Amplitude Response - Normal Mode
- Figure 4.9 Organization of the 4210 Series Variable Electronic Filter in the Normal or Pulse Mode
- Figure 4.10 Organization of the 4210 Series Variable Electronic Filter in the Band-Reject Mode
- Figure 4.11 High Frequency Amplitude Response for Amplifier
- Figure 4.12 High Frequency Phase Response for Amplifier
- Figure 4.13 DC Offset Voltage Resulting from Input Bias Current
- Figure 4.14 Current Source to Supply Input Bias Current for AR8, AR9 and AR10

LIST OF TABLES AND APPLICATION NOTES

Table 3.1	Band-Reject Mode -- Cutoff Frequency Settings for the Variable Notch
Table 3.2	Band-Reject Mode -- Cutoff Frequency Settings for the Variable Notch
Table 6.1	Reference Designations
Table 6.2	Code List of Manufacturers
IAN-101	"PHASE AND AMPLITUDE RESPONSE OF A VARIABLE ELECTRONIC FILTER"
IAN-102	"MEASURING NOISE SPECTRA WITH VARIABLE ELECTRONIC FILTERS"

SECTION 1

1.0 GENERAL DESCRIPTION

1.1 DESCRIPTION

The 4210 Series Variable Electronic Filters have three modes of operation: Normal, Pulse and Band-Reject.

In the Normal mode, a filter can operate as a DC coupled low-pass, a high-pass, or a band-pass filter. One third (1/3) octave frequency steps can be selected for the independently tuned high-pass and low-pass sections. These sections are cascaded to form the band-pass filter. Each section possesses a maximally flat amplitude response using a 4 pole Butterworth filter giving a 24 dB/octave (80 dB/decade) attenuation slope.

In the Pulse mode, the DC coupled low-pass section uses a Bessel characteristic to provide a maximally flat time delay (linear phase response) for superior transient response.

In the Band-Reject mode, the high-pass and low-pass sections are operated in parallel with the high-pass cutoff frequency set above the low-pass cutoff frequency, thus providing a variable notch in the filter response. The center frequency, width, and depth of this notch are controlled by the frequency settings selected. Both a sharp notch and a variable width notch can be selected.

Precision filter characteristics permit phase and amplitude tracking between filters with the same setting. The -3 dB frequencies, center frequency, -3 dB bandwidth, noise bandwidth, and filter gain for all band-pass filter settings in the Normal mode are printed on the instrument top. The one third (1/3) octave filter settings provide 10 equally spaced cutoff frequency settings in each decade, on a logarithmic scale.

The filters have high input impedance and low output impedance with a high dynamic range (up to 7 volts rms allowable at the input).

1.2 OPTIONS

1.2.1 FILTER AMPLIFIER OPTION - OPTION 02

The filter amplifier provides from 0 to 40 dB gain in 10 dB steps (± 0.1 dB). It is DC coupled and its high frequency response is 3 dB down at 2.5 MHz. In the Band-Reject mode, the amplifier must be set for 0 dB gain.

1.2.2 BATTERY OPTION - OPTION 01

The Battery Option permits the filter to be operated for periods up to 7 hours without recharging, using internal NiCd batteries. Filters with the Amplifier Option can be operated for 5.5 hours on battery power. Model 4213 runs for 4.5 hours (3.5 hours with Amplifier Option) unless modified to operate with a maximum input level of 3V rms. Then this model can be operated for 7 hours on battery power. Nominal charging time for completely discharged batteries is 14 hours.

1.3 SPECIFICATIONS (See Filter Brochure, page 9)

1.3.1 HIGH FREQUENCY MAXIMUM INPUT SIGNAL

Due to slew rate limiting in the 310 operational amplifiers, the maximum input signal must be reduced at frequencies above 200 kHz to maintain linear operation. This restriction affects the Model 4213 which has high frequency capabilities to 1 MHz. Figure 1.1 shows the typical maximum input swing which can be used above 100 kHz.

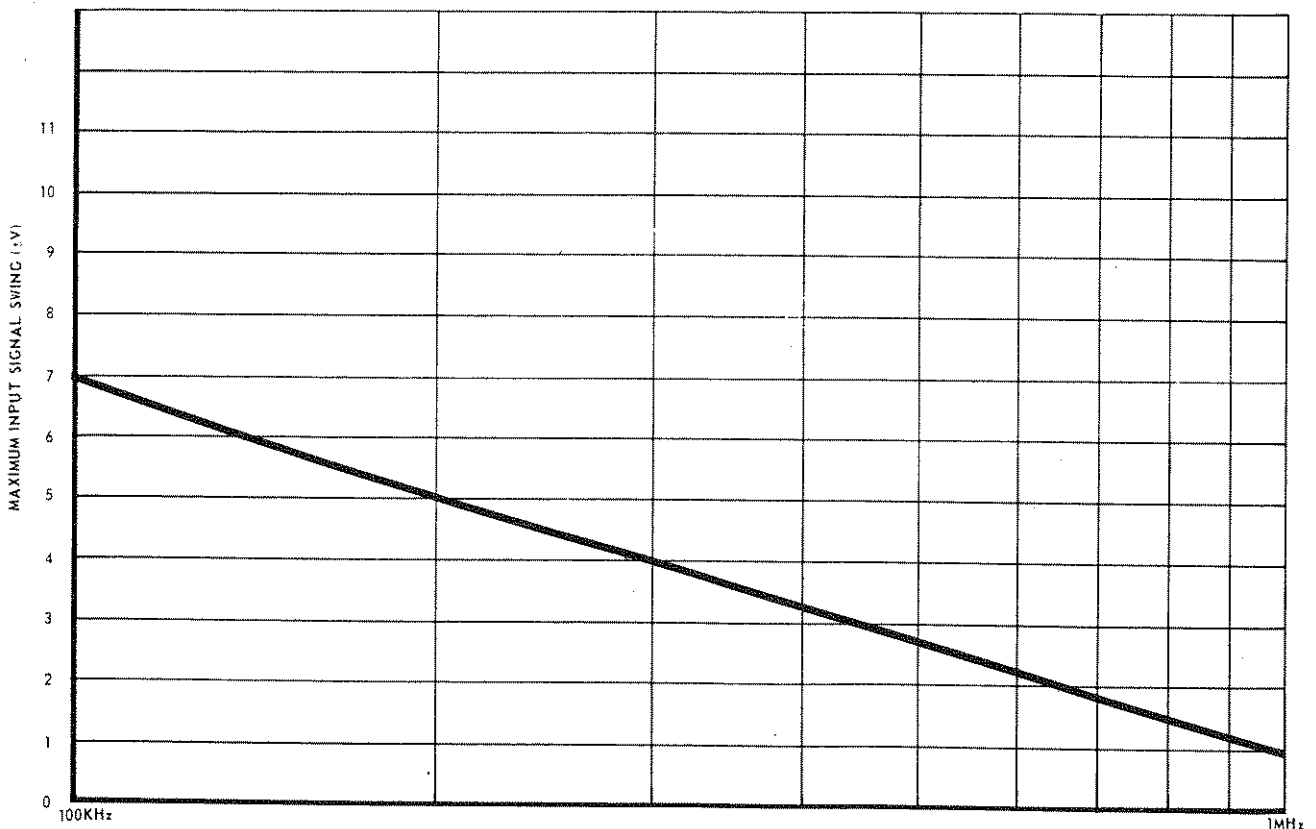

FIGURE 1.1 MAXIMUM INPUT SIGNAL SWING VS FREQUENCY

SECTION 2

2.0 INSTALLATION

2.1 INSPECTION

2.1.1 GENERAL

Before shipment, this unit was found to be free of electrical and mechanical defects. As soon as the instrument is unpacked, inspect for any damage that may have occurred in transit. Save all packing materials until the inspection is complete. If damaged in any way, a claim should be filed with the carrier and a copy forwarded to ITHACO. ITHACO will then advise you as to the disposition of the equipment and will arrange for repair or replacement without waiting for a settlement of a claim against the carrier.

2.1.2 VISUAL INSPECTION

A visual check should be made to confirm that there are no broken knobs or connectors, and that the case and panel surfaces are free of dents and scratches.

2.1.3 ELECTRICAL INSPECTION

The instrument should be checked against its electrical specifications (see Section 5).

2.2 SYSTEM GROUNDS

Switch S7 on the rear panel permits the circuit ground to be isolated from the power line ground. The instrument case is always tied to the power line ground.

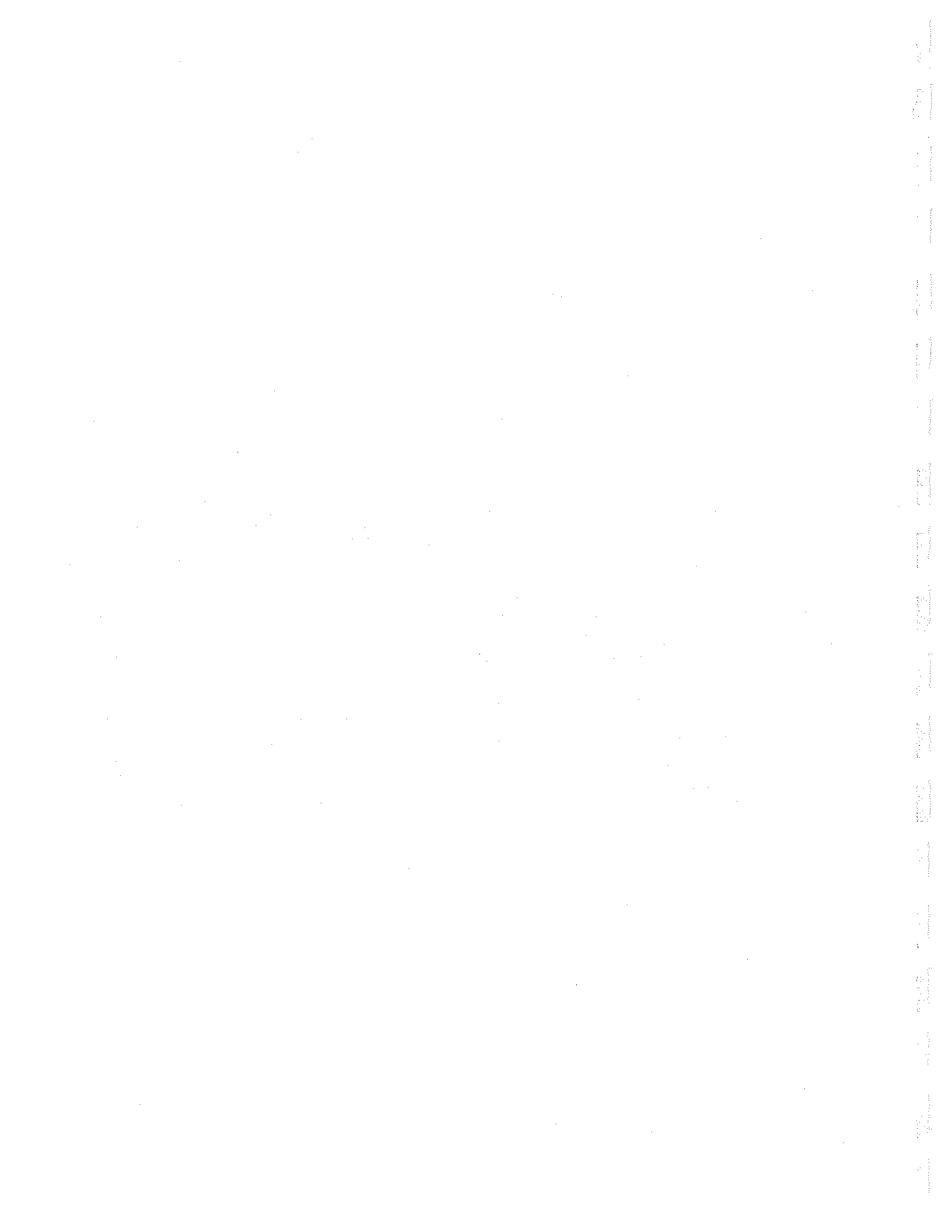

FRONT PANEL CONTROLS AND CONNECTORS

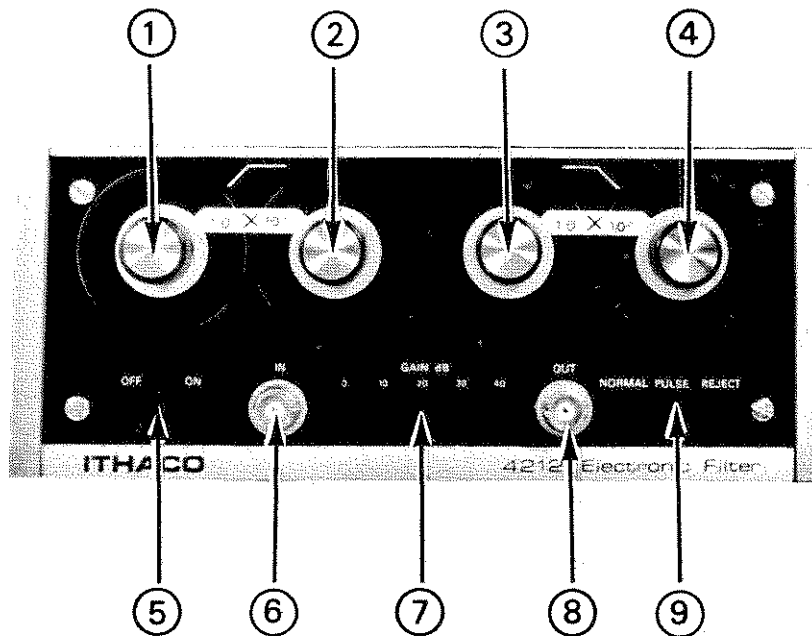

- ① Frequency setting for high-pass filter (low frequency cutoff) S1
- ② Frequency multiplier for high-pass filter (multiplies frequency setting) S2
High-pass filter cutoff frequency = ① X ②
- ③ Frequency setting for low-pass filter (High frequency cutoff) S3
- ④ Frequency multiplier for low-pass filter (multiplies frequency setting) S4
Low-pass filter cutoff frequency = ③ X ④
- ⑤ ON/OFF switch S5
- ⑥ Input BNC connector (UG-1094/U)
- ⑦ Variable 0 - 40 dB gain selector (available with amplifier option only)
- ⑧ Output BNC connector (UG-1094/U)
- ⑨ Mode switch S6 (selects Normal, Pulse, or Reject mode)

FIGURE 3.1

REAR PANEL CONTROLS AND CONNECTORS

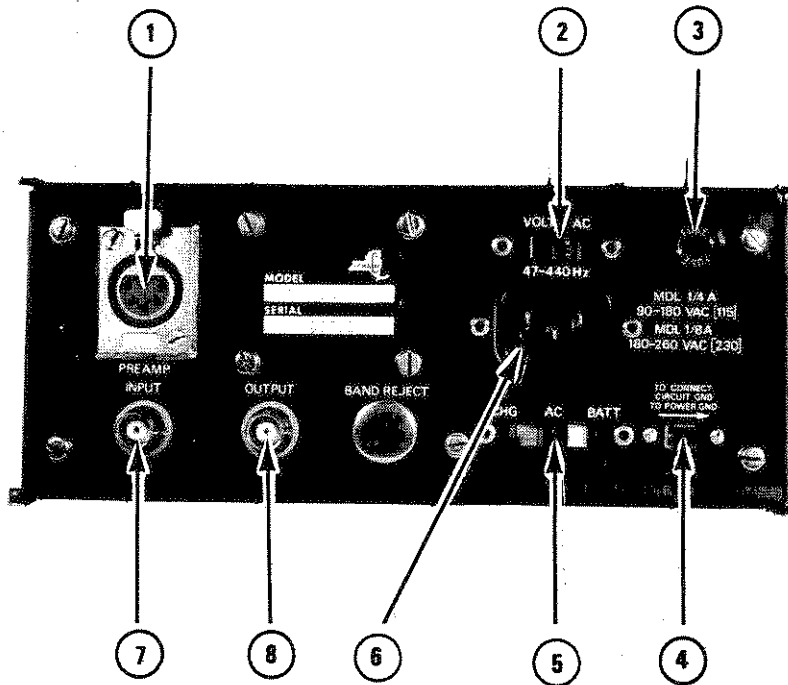

- ① XLR Connector (XLR5-31); Mating Connector (XLR5-12C). Used to connect remote preamplifier

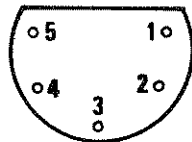

- 1 Preamp In
- 2 -15 Volts
- 3 Preamp Ground
- 4 +15 Volts
- 5 Supply Ground

(Pins 3 and 5 are wired together on the XLR5-31)

- ② Line voltage selector switch S8 (Selects 90 - 130 or 180 - 260 volts AC, single phase 50 - 400 Hz)
- ③ Power fuse (1/4A SB or 1/8A SB for 220V)
- ④ Ground selector switch S7
- ⑤ Power mode switch S9 (selects AC, battery or battery charge mode)
- ⑥ Power cord receptacle (3 wire power cord)
- ⑦ Signal Input
- ⑧ Signal Output

FIGURE 3.2

SECTION 3

3.0 OPERATION

3.1 GENERAL

The ITHACO 4210 Series Variable Electronic Filters operate in three modes: Normal, Pulse and Band-Reject. Operation in these three modes is detailed below. Operating controls of the 4210 Series are described in Figures 3.1 and 3.2.

3.2 AC COUPLED INPUT

When operating with the high-pass multiplier switch set to the OUT position, the 4210 Series Filters are DC coupled. When operating with the high-pass multiplier switch to a position other than the OUT position, the 4210 Series Filters have an AC coupled input stage in addition to the 4 pole Butterworth high-pass filter. This permits the input to operate from signal sources which possess a DC component as high as 200 volts. The AC coupled input consists of a 2 μ f capacitor coupled into a 22 Megohm resistor so the -3 dB frequency for this network is .004 Hz and should have little effect in most applications. The phase and amplitude response of the AC coupled input network is plotted in Figure 3.3.

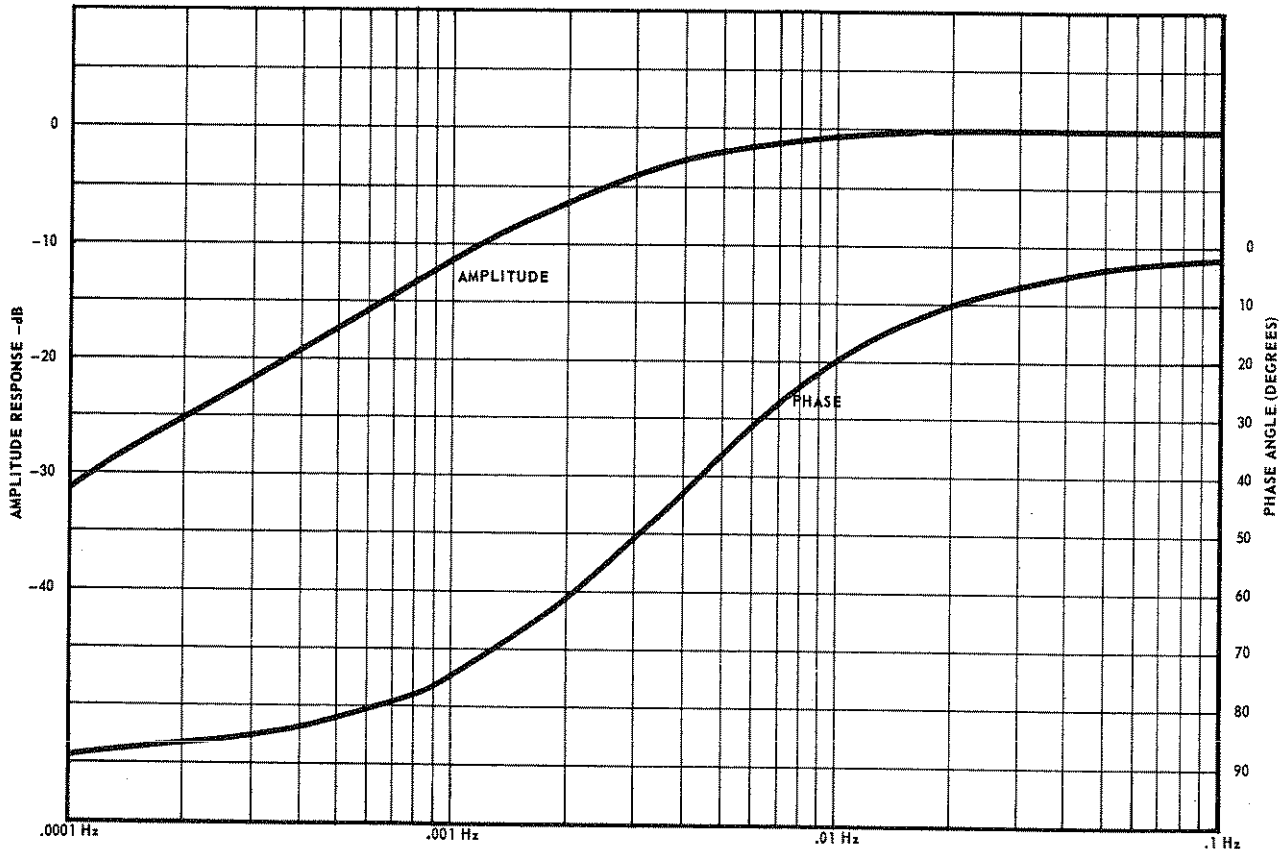

FIGURE 3.3 PHASE AND AMPLITUDE RESPONSE OF AC COUPLED INPUT OF 4210 SERIES VARIABLE ELECTRONIC FILTERS

3.3 NORMAL MODE OPERATION

3.3.1 INTRODUCTION

When the Normal mode of operation is selected by S6, both the high-pass and low-pass filter sections operate as 4 pole Butterworth filters giving maximally flat amplitude response with 24 dB/octave rolloff from the selected cutoff frequency. In this mode, the cutoff frequency is the -3 dB frequency. The frequency response for the high-pass and low-pass filter sections can be determined by scaling a normalized filter plot. Figure 1 of the enclosed ITHACO Application Note, IAN-101 shows the normalized amplitude response for all ranges of the Normal mode. Figure 2 of IAN-101 shows the normalized phase response for the Normal mode.

3.3.2 NORMALIZED FILTER RESPONSE

Referring to Figures 1 and 2 of IAN-101, the frequency scale has been normalized so that the filter cutoff frequency (Frequency Setting x Frequency Multiplier on the front panel) is indicated by unity on this scale. To determine the frequency response for a particular setting, the scale on the graph is multiplied by the filter cutoff frequency. For example: if the filter cutoff frequency is set to 2 KHz, then "1" on the normalized frequency scale will indicate 2 KHz. "2" on the normalized scale will indicate 4 KHz, ".5" on the normalized scale will indicate 1 KHz, etc. In this manner, a single curve can specify the response for all filter settings.

3.3.3 OPERATION AS A HIGH-PASS FILTER

To operate as a high-pass filter only, simply select the desired cutoff frequency using S1 and S2. In this mode, the high frequency rolloff will be determined by the low-pass filter setting since the two filter sections are cascaded. Normally the low-pass section would be set to its highest frequency setting (dependent on the model) when the 4210 is used as a high-pass filter.

3.3.4 OPERATION AS A LOW-PASS FILTER

To operate as a low-pass filter, set the high-pass multiplier switch S2 to the OUT position. This DC couples the input. Using S3 and S4, select the desired cutoff frequency.

3.3.5 OPERATION AS A BAND-PASS FILTER

The filter is operated as a band-pass filter by using the high-pass setting switches S1 and S2 to select the low frequency

ABSTRACT

The phase and amplitude response of a 4 pole Butterworth low-pass, 4 pole Butterworth high-pass and 4 pole Bessel low-pass filters are provided. Also, the phase and amplitude response of a band-pass filter formed by cascaded 4 pole Butterworth high and low-pass filters are provided for cut-off separations of 0/10, 1/10, 2/10, 3/10 decade. A simple general method is described for obtaining the phase and amplitude response of cascaded 4 pole Butterworth high and low-pass filters for any filter separation in 1/10 decade steps. The -3 dB frequencies, center frequency, -3 dB bandwidth, noise bandwidth and filter gain are tabulated for ITHACO Variable Electronic Filters such that this information can be obtained for any filter setting.

INTRODUCTION

A Variable Electronic Filter as described in this paper is comprised of independently tuned high-pass and low-pass filter sections with provisions to operate as a low-pass, high-pass and band-pass filter. It also may have a transfer function which can be selected according to the application. For normal filtering in the frequency domain four pole Butterworth high-pass and low-pass filters are used. For use in the time domain a four pole Bessel low-pass filter is ideal inasmuch as it has a linear-phase characteristic which preserves the pulse wave shape.

The phase and amplitude response of the Variable Electronic Filter will vary with each filter function (HP, LP, BP), with each filter characteristic (Butterworth, Bessel), and each filter cut-off frequency; so an exhaustive tabulation of amplitude and phase is not practical. However, with tabulation of the phase and amplitude response of a 4 pole Butterworth high-pass filter, a 4 pole Butterworth low-pass filter, and a 4 pole Bessel low-pass filter in 1/20 decade frequency steps, it is possible to obtain the amplitude and phase response for any filter function with cut-off frequencies in 1/10 decade steps. Further, many of the ITHACO Variable Electronic Filters have frequency cut-off steps of 1/10 decade (1/3 octave) so the resultant tabulations are directly applicable.

PHASE & AMPLITUDE RESPONSE OF 4 POLE BUTTERWORTH AND BESSEL FILTERS

The phase and amplitude response for a four pole Butterworth high-pass, 4 pole Butterworth low-pass, and 4 pole Bessel low-pass filter are tabulated in Chart I, II and III respectively. Referring to Chart I, the frequency is tabulated in the first eleven columns - each column corresponding to a 1/10 decade step in cut-off frequency - and the amplitude and phase in the last two columns.

If the filter cut-off frequency is one of the 1/10 decade increments listed at the top of the columns (1.0000, 1.2589, 1.5849, 1.9952, 2.5119, 3.1622, 3.9810, 5.0118, 6.3095, 7.9432, 10.000) or sufficiently close to these numbers such as the internationally preferred set of numbers used on the ITHACO Variable Electronic Filters (1.00, 1.25, 1.60, 2.00, 2.50, 3.15, 4.00, 5.00, 6.30, 8.00, 10.0), the phase and amplitude response can be determined directly from the charts. If the filter cut-off frequency is very different from these listed, the phase and amplitude response can be determined by multiplying each of the frequencies in Column 1 by the cut-off frequency and thereby obtaining a column of frequencies for the phase and amplitude response listed.

The normalized amplitude response for a 4 pole Butterworth high-pass, 4 pole Butterworth low-pass, and 4 pole Bessel low-pass filter is plotted in Figures 1 and 3 respectively and the normalized phase response is plotted in Figures 2 and 4 respectively. To determine the response for a particular cut-off frequency, the normalized frequency scale on the graph is multiplied by the filter cut-off frequency. For example, if the filter cut-off frequency is set to 2 KHz, "1" on the normalized frequency scale will indicate 2 KHz, "2" on the normalized frequency scale will indicate 4 KHz, "5" on the normalized frequency scale will indicate 10 KHz, "0.5" on the normalized frequency scale will indicate 1 KHz, etc. In this manner a single curve can specify all filter settings.

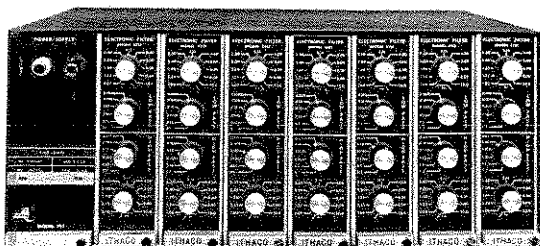

TYPICAL ITHACO VARIABLE ELECTRONIC FILTERS

BAND-PASS FILTERS FORMED BY CASCADING HIGH-PASS AND LOW-PASS FILTERS

A band-pass filter can be formed by cascading a high-pass filter with a low-pass filter, and the resultant phase and amplitude response can be obtained from the individual filter responses by adding the amplitude in dB and the phase in degrees at the SAME frequency.

It is the requirement that the phase and amplitude response be added at the same frequency which dictated that the cut-off frequencies and the frequency increments be in compatible logarithmic steps. Referring to Chart I and Chart II, note each column contains the same frequencies (except at the extremes which are least significant). So the phase and amplitude response can be obtained by adding the response in Chart I to that in Chart II for any of the given filter settings.

EXAMPLE: For a Variable Electronic Filter set to:

High-Pass Setting, $F_{HP} = 1.2589$ KHz

Low-Pass Setting, $F_{LP} = 3.1622$ KHz

Band-Pass Center Freq., $F_0 = \sqrt{(1.2589)(3.1622)}$ KHz
= 1.9952 KHz

Refer to Chart I, column 2 for the frequencies for a high-pass filter setting of 1.2589 KHz. Refer to Chart II, column 6 for the frequencies for a low-pass filter setting of 3.1622 KHz. The amplitude and phase information in Chart I is added to the amplitude and phase information in Chart II for the same frequency. Some of the information in Chart I and Chart II are tabulated below. Note, for 1.2589 KHz the high-pass amplitude response is -3.01 dB and the low-pass amplitude response is 0.0 dB so the resulting band-pass filter amplitude response is -3.01 dB. Similarly, for 1.2589 KHz, the high-pass phase response is 180.0 degrees and the low-pass phase response is -58.4 degrees, so the band-pass filter phase response is 121.6 degrees.

Chart IV, for example, is the overall response of a 4 pole Butterworth high-pass and low-pass filter cascaded with equal cut-off frequencies. This chart was obtained by assuming that the cut-off frequency for both filter sections was 1.0000 so the phase and amplitude response

for each frequency in column 1 of Chart I was added to the corresponding phase and amplitude response for the same frequency in column 1 of Chart II.

Similarly Chart V is the overall response for a 4 pole Butterworth high-pass cascaded with a 4 pole Butterworth low-pass with the cut-off frequency separated by 1/10 decade. To obtain this tabulation the high-pass filter was assumed to have a cut-off frequency of 1.000 (column 1 of Chart I) and the low-pass filter was assumed to have a cut-off frequency of 1.2589 (column 2 of Chart II) and the resultant tabulation was obtained by looking up the amplitude and phase response for each frequency in column 1 of Chart I and adding it to the corresponding amplitude and phase response for the same frequency in column 2 of Chart II.

Similarly Chart VI and VII were obtained from Chart I and Chart II for 2/10 decade and 3/10 decade separation of the high and low-pass filters.

Figures 5 and 6 show the normalized amplitude and phase response of a band-pass filter formed by cascading 4 pole Butterworth filters for 0/10, 1/10, 2/10, 3/10 decade separation. Figure 7 shows the variation in filter gain (insertion loss) as the cut-off frequency of the high-pass and low-pass filters are separated. Figure 8 shows the normalized amplitude response with the insertion loss removed so the filter characteristics can be compared for different cut-off separations. Note that the filter response for no separation is only slightly different from those with 1/10 and 2/10 decade separation, but the insertion loss is quite different which suggests that for many applications 2/10 decade separation is preferable. Figures 9 through 12 show families of band-pass filters with 1/10 decade steps in cut-off frequencies.

Chart VIII is an exact tabulation of -3dB frequencies center frequency, bandwidth, noise bandwidth, and filter gain for the internationally preferred set of frequency settings (1.00, 1.25, 1.60, 2.00, 2.50, 3.15, 4.00, 5.00, 6.30, 8.00) used in the ITHACO Variable Electronic Filter. This information is tabulated in a manner which permits it to be used for any combination of filter settings.

HIGH-PASS $F_{HP} = 1.2589$
CHART I

②	⑫	⑬
FREQ.	AMPLITUDE	PHASE
Hz	dB	DEGREES
1.2589	-3.01	180.0
1.4125	-1.46	153.5
1.5849	-.64	130.6
1.7783	-.27	112.1
1.9952	-.11	97.3
2.2387	-.04	85.1
2.5119	-.02	74.8
2.8183	-.01	66.0
3.1622	.00	58.4

LOW-PASS $F_{LP} = 3.1622$
CHART II

⑥	⑫	⑬
FREQ.	AMPLITUDE	PHASE
Hz	dB	DEGREES
1.2589	.00	-58.4
1.4125	-.01	-66.0
1.5849	-.02	-74.8
1.7783	-.04	-85.0
1.9952	-.11	-97.3
2.2387	-.27	-112.1
2.5119	-.64	-130.6
2.8183	-1.46	-153.5
3.1622	-3.01	-180.0

BAND-PASS $F_0 = 1.9952$
NEW CHART

FREQ.	AMPLITUDE	PHASE
Hz	dB	DEGREES
1.2589	-3.01	121.6
1.4125	-1.47	87.5
1.5849	-.66	55.8
1.7783	-.31	27.1
1.9952	-.22	0.0
2.2387	-.31	-27.0
2.5119	-.66	-55.8
2.8183	-1.47	-87.5
3.1622	-3.01	-121.6

NORMALIZED AMPLITUDE RESPONSE OF A 4 POLE BUTTERWORTH FILTER

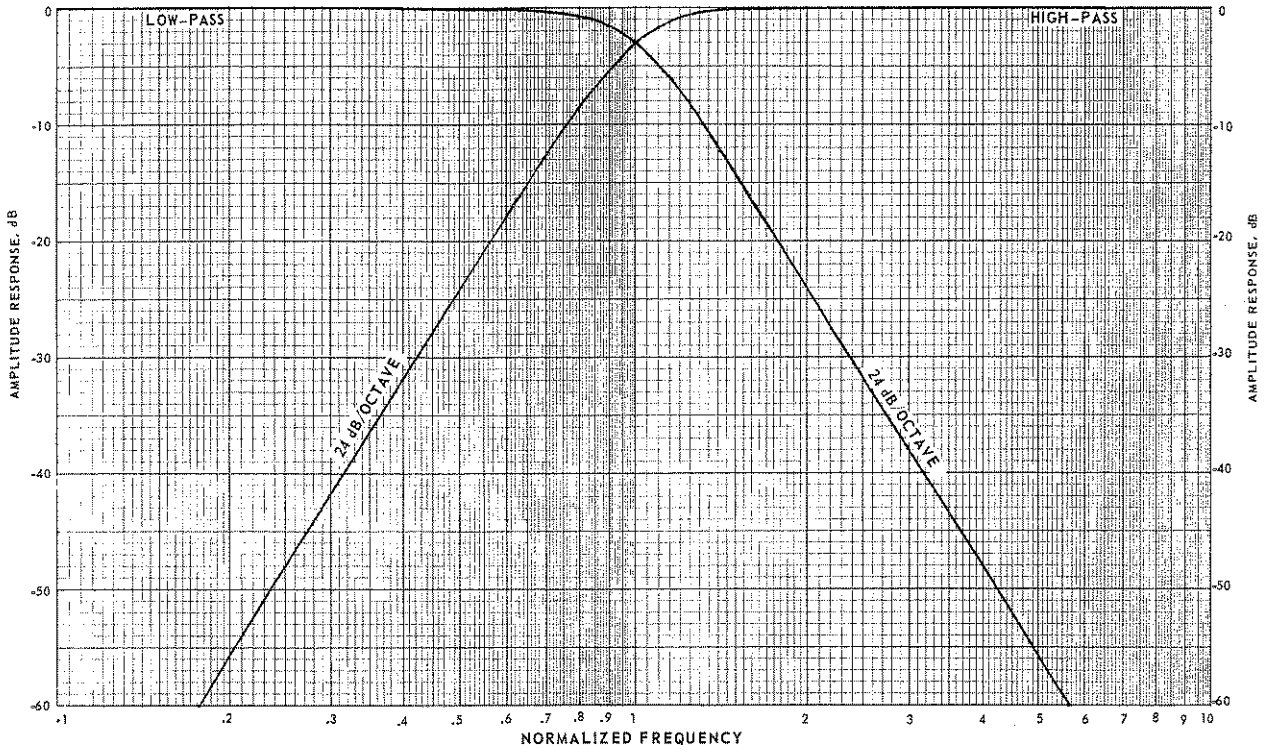

FIGURE 1 AMPLITUDE RESPONSE OF 4 POLE BUTTERWORTH FILTER

NORMALIZED PHASE RESPONSE OF A 4 POLE BUTTERWORTH FILTER

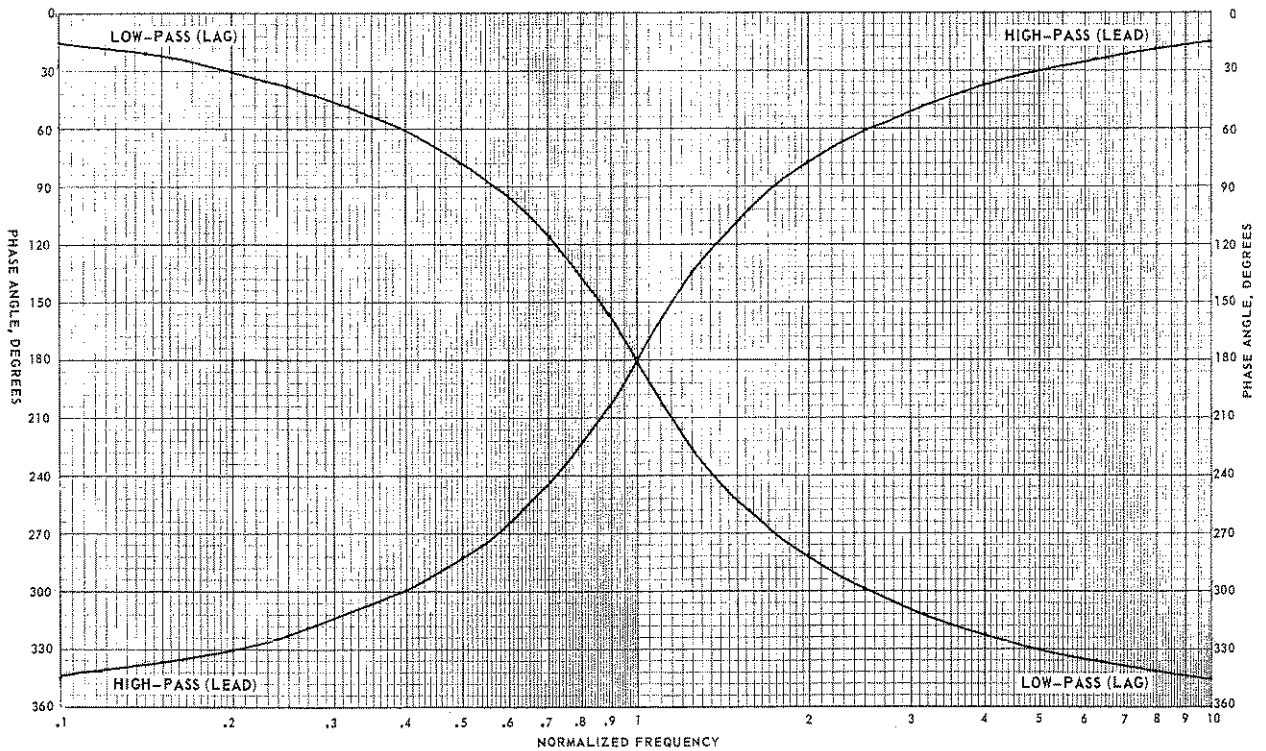

FIGURE 2 PHASE RESPONSE OF 4 POLE BUTTERWORTH FILTER

NORMALIZED AMPLITUDE RESPONSE OF A 4 POLE BESSEL LOW-PASS FILTER

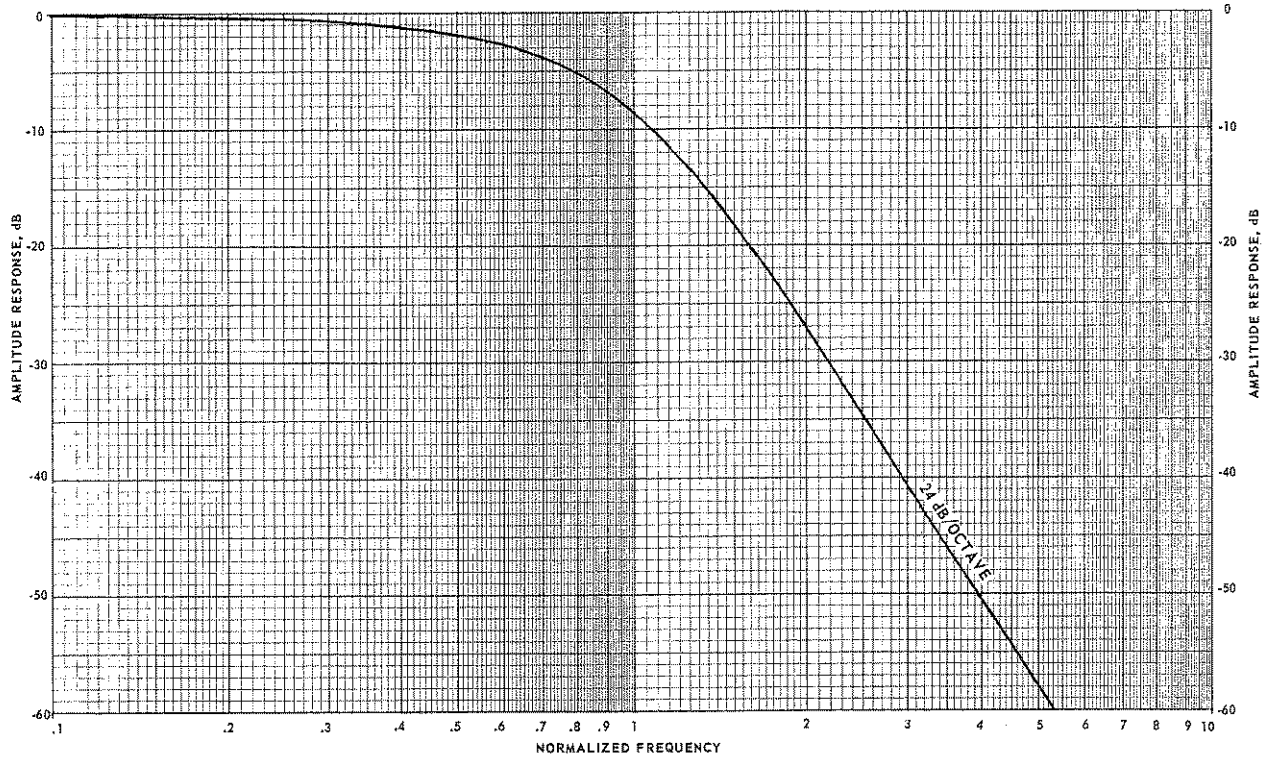

FIGURE 3 AMPLITUDE RESPONSE OF 4 POLE BESSEL FILTER

NORMALIZED PHASE RESPONSE OF A 4 POLE BESSEL LOW-PASS FILTER

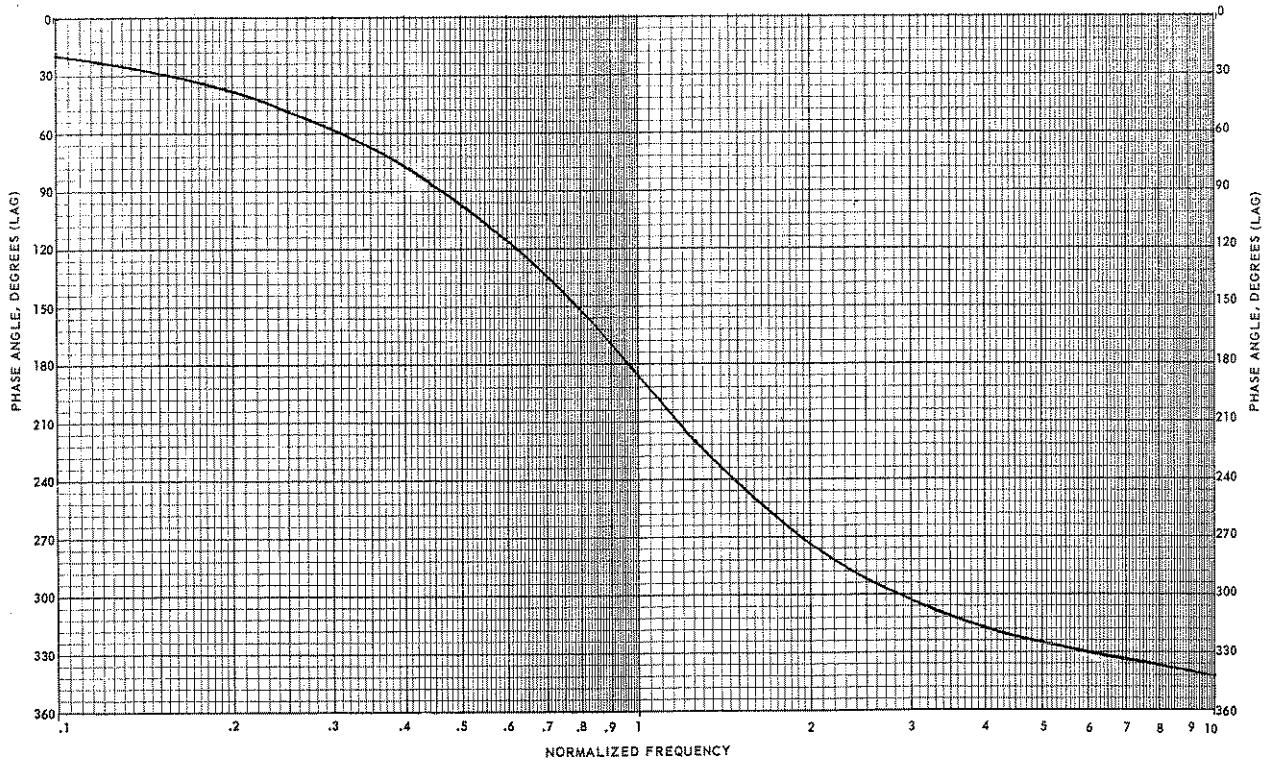

FIGURE 4 PHASE RESPONSE OF 4 POLE BESSEL FILTER

NORMALIZED AMPLITUDE RESPONSE

BAND-PASS FILTERS FORMED BY CASCADING 4 POLE BUTTERWORTH LOW-PASS AND HIGH-PASS FILTERS

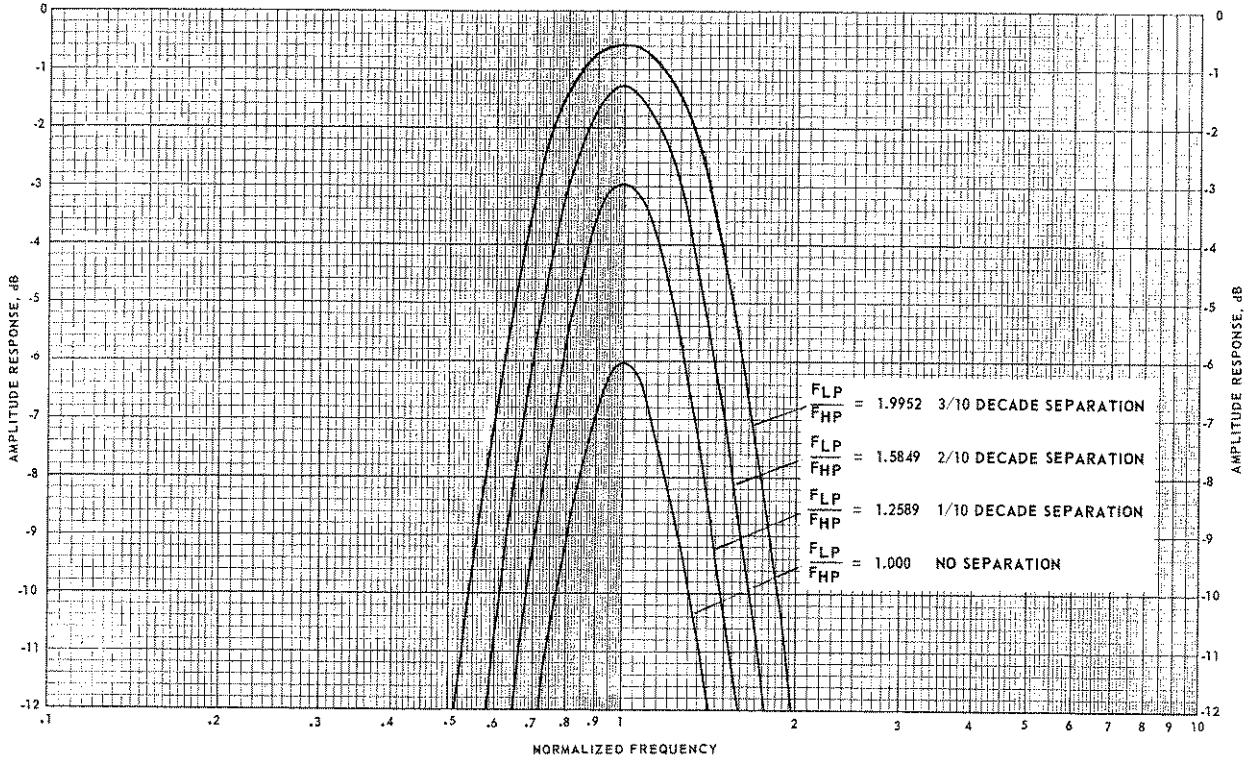

FIGURE 5 AMPLITUDE RESPONSE OF BAND-PASS FILTERS FORMED BY CASCADING 4 POLE BUTTERWORTH FILTERS

NORMALIZED PHASE RESPONSE

BAND-PASS FILTERS FORMED BY CASCADING 4 POLE BUTTERWORTH LOW-PASS AND HIGH-PASS FILTERS

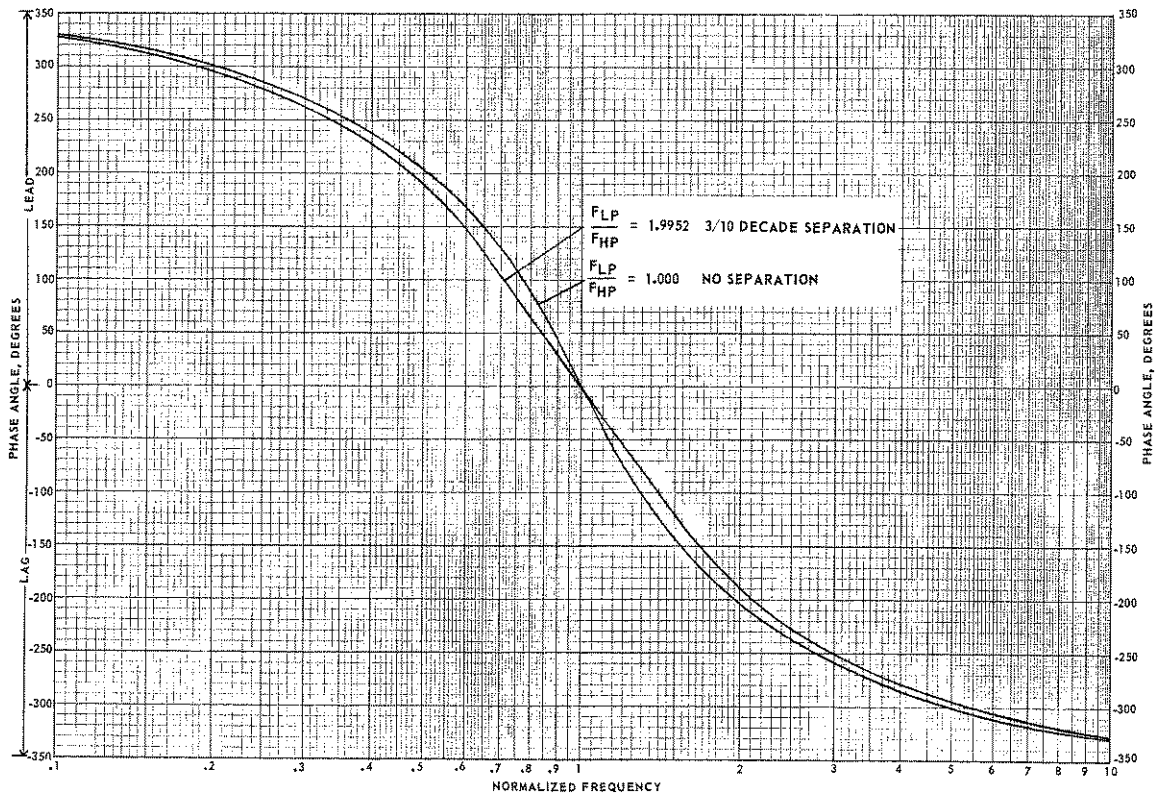

FIGURE 6 PHASE RESPONSE OF BAND-PASS FILTERS FORMED BY CASCADING 4 POLE BUTTERWORTH FILTERS

FILTER GAIN VS SEPARATION OF HIGH-PASS & LOW-PASS FILTERS

BAND-PASS FILTER FORMED BY CASCADING 4 POLE BUTTERWORTH LOW-PASS AND HIGH-PASS FILTERS



FIGURE 7 BAND-PASS FILTER GAIN VS SEPARATION OF HIGH & LOW-PASS FILTERS

NORMALIZED AMPLITUDE RESPONSE WITHOUT INSERTION LOSS

BAND-PASS FILTERS FORMED BY CASCADING 4 POLE BUTTERWORTH LOW-PASS AND HIGH-PASS FILTERS

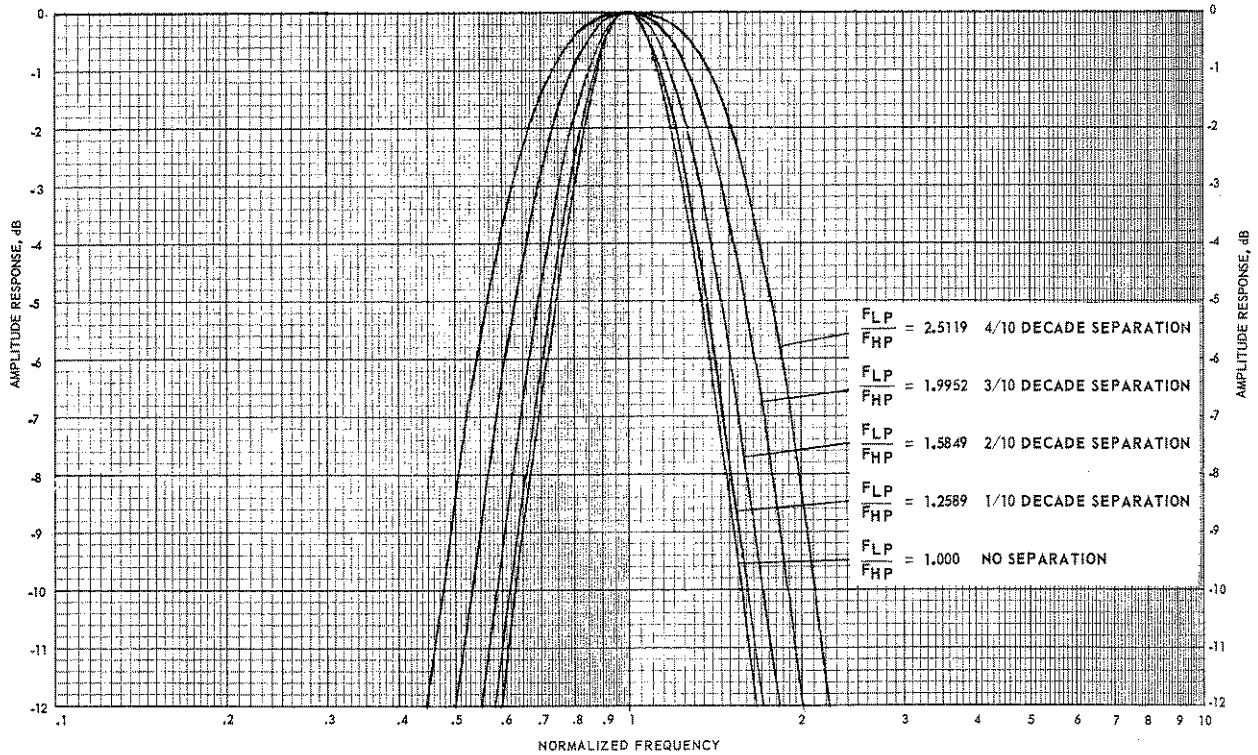

FIGURE 8 AMPLITUDE RESPONSE OF BAND-PASS FILTER WITHOUT INSERTION LOSS

BAND-PASS FILTERS

FAMILY OF BAND-PASS FILTERS FORMED BY CASCADING 4 POLE BUTTERWORTH HIGH-PASS AND LOW-PASS FILTERS
 NO SEPARATION - $F_{LP} = F_{HP}$ - 0 OCTAVE SEPARATION

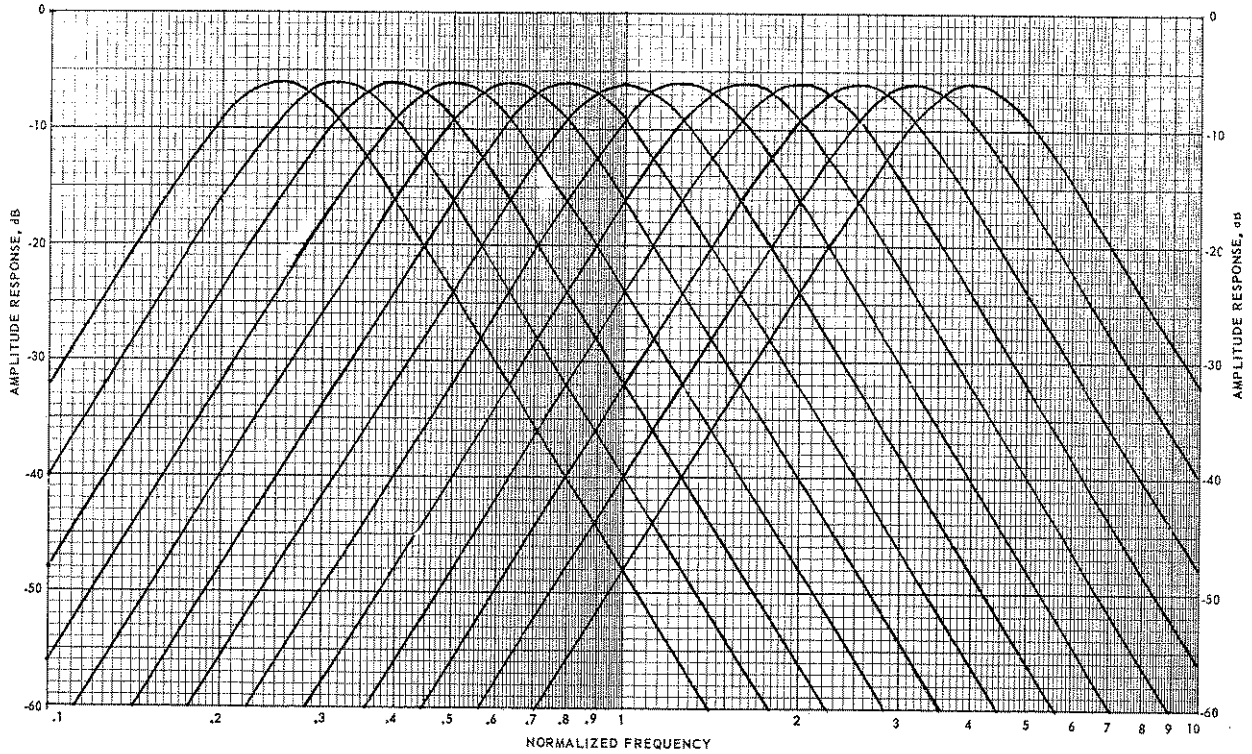

FIGURE 9 FAMILY OF BAND-PASS FILTERS WITH NO SEPARATION

BAND-PASS FILTERS

FAMILY OF BAND-PASS FILTERS FORMED BY CASCADING 4 POLE BUTTERWORTH HIGH-PASS AND LOW-PASS FILTERS
 1/10 DECADE SEPARATION - $\frac{F_{LP}}{F_{HP}} = 1.2589$ - 1/3 OCTAVE SEPARATION

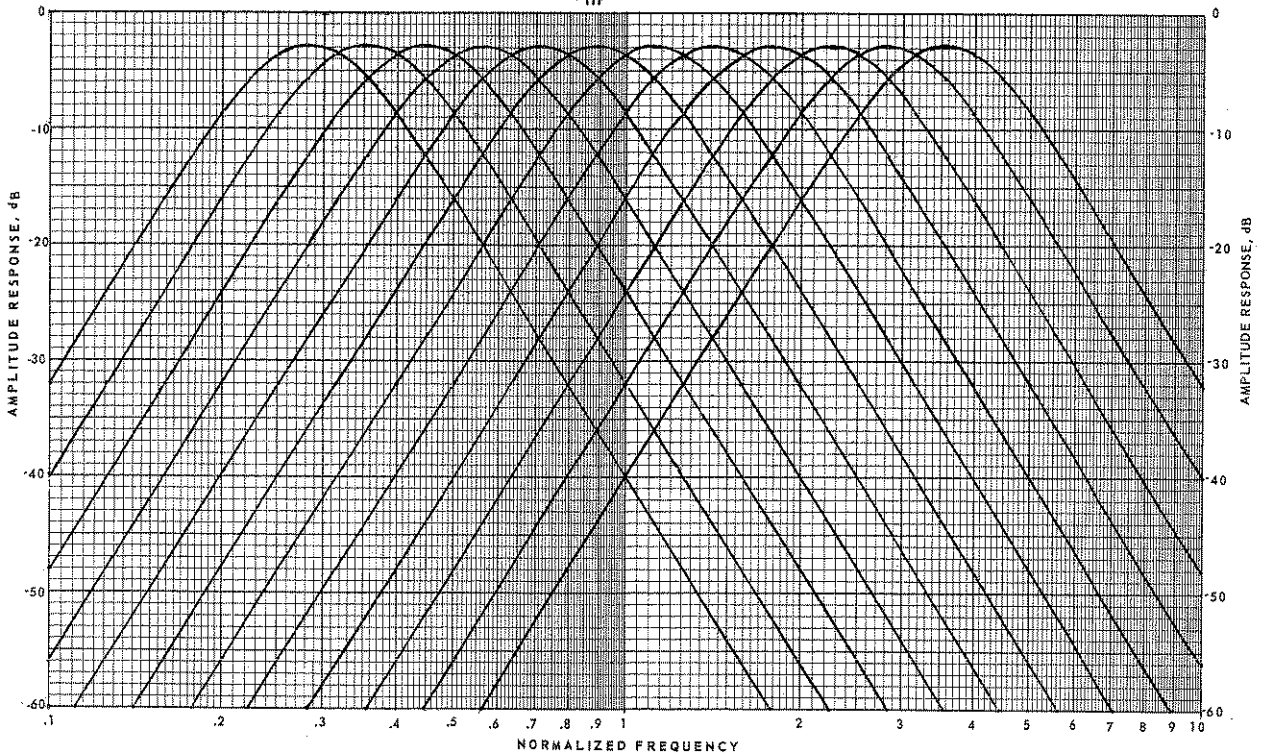

FIGURE 10 FAMILY OF BAND-PASS FILTERS WITH 1/10 DECADE SEPARATION

BAND-PASS FILTERS

FAMILY OF BAND-PASS FILTERS FORMED BY CASCADING 4 POLE BUTTERWORTH HIGH-PASS AND LOW-PASS FILTERS

2/10 DECADE SEPARATION - $\frac{F_{LP}}{F_{HP}} = 1.5849$ - 2/3 OCTAVE SEPARATION

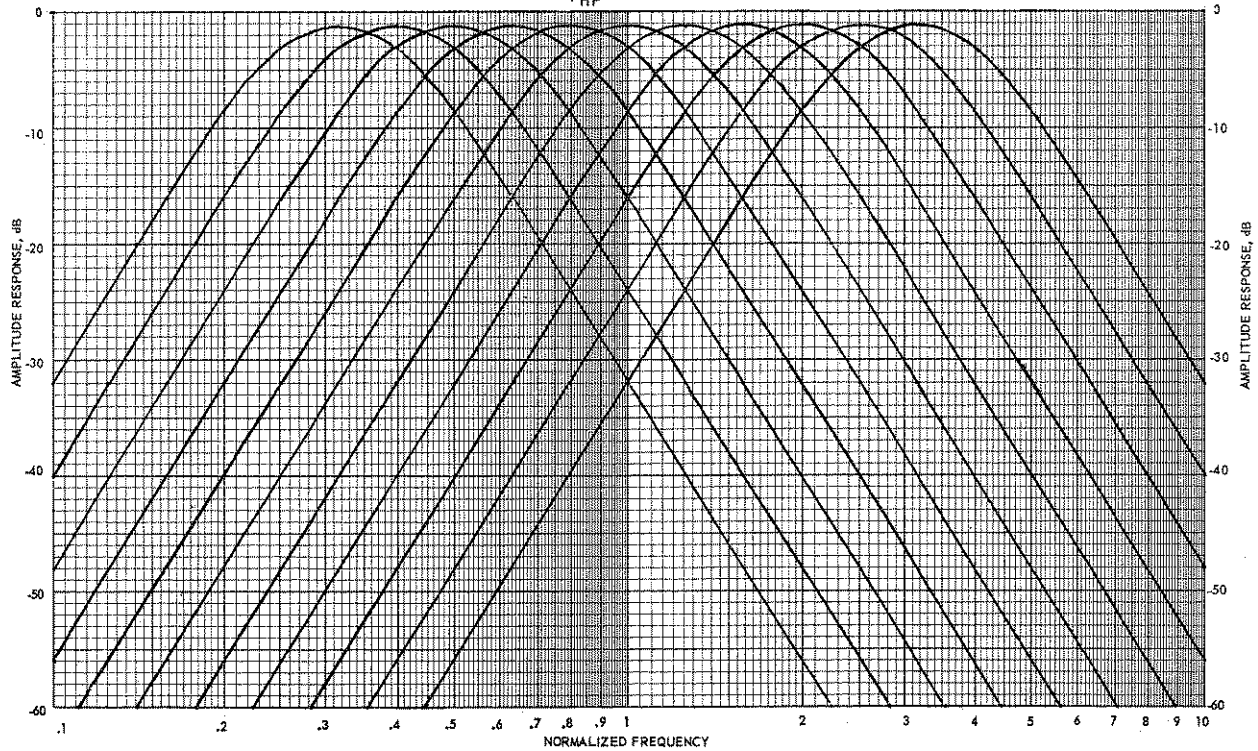

FIGURE 11 FAMILY OF BAND-PASS FILTERS WITH 2/10 DECADE SEPARATION

BAND-PASS FILTERS

FAMILY OF BAND-PASS FILTERS FORMED BY CASCADING 4 POLE BUTTERWORTH HIGH-PASS AND LOW-PASS FILTERS

3/10 DECADE SEPARATION - $\frac{F_{LP}}{F_{HP}} = 1.9952$ - 1 OCTAVE SEPARATION

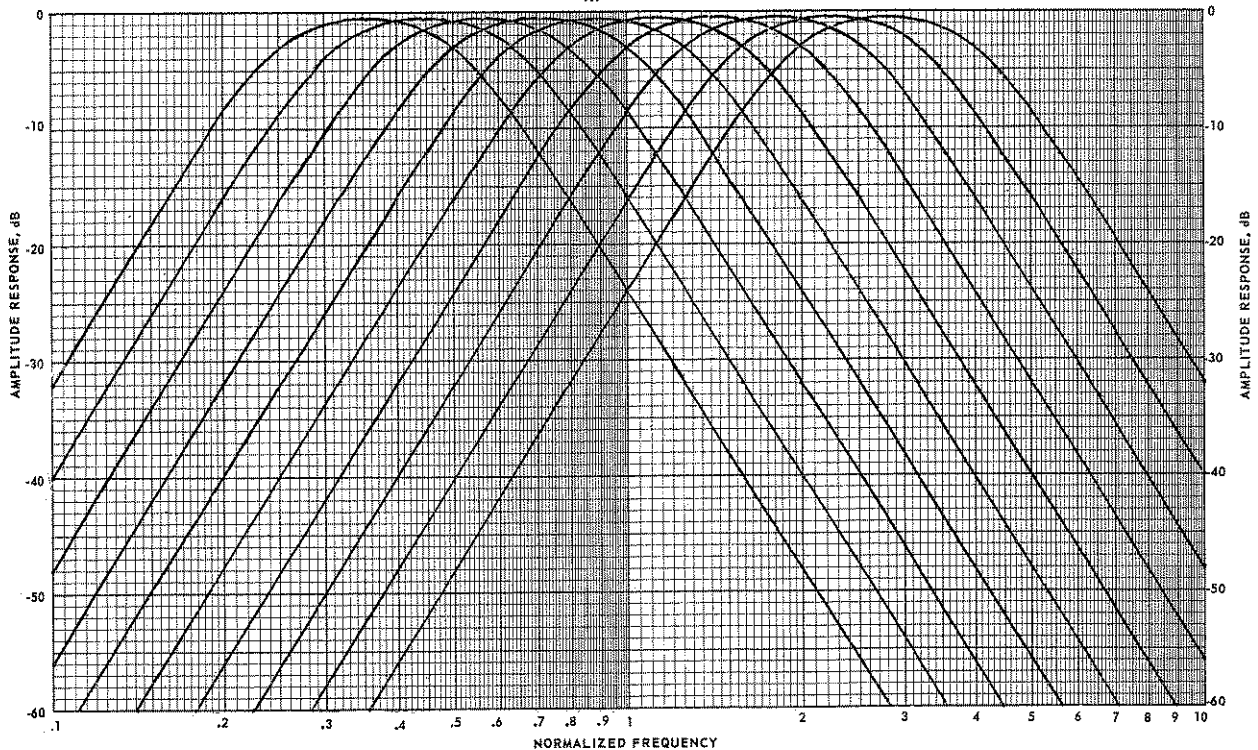

FIGURE 12 FAMILY OF BAND-PASS FILTERS WITH 3/10 DECADE SEPARATION

BAND-PASS FILTER

3/10 DECADE SEPARATION

F_{LP} / F_{HP} = 1.9952

1 OCTAVE SEPARATION

CHART VII

BAND-PASS FILTERS FORMED BY CASCADING 4 POLE BUTTERWORTH HIGH-PASS & LOW-PASS FILTERS

Table with 12 columns and multiple rows. Columns include center frequency (F0), L.P. setting (FLP), H.P. setting (FHP), and a 2xN grid of Amplitude Response (dB) and Phase Response (Degrees) values for various frequencies.

cutoff desired and by using the low-pass setting switches S3 and S4 to select the high frequency cutoff.

The enclosed ITHACO Application Note IAN-101 contains tables and graphs of the frequency and phase response for band-pass filters with varying degrees of separation between the high-pass and low-pass sections. In addition, the table on the top of the instrument case provides the necessary information for determining the upper and lower -3 dB frequencies, the center frequency, the -3 dB bandwidth, the noise bandwidth, and the filter gain for the 4210 Series filters when used as band-pass filters.

The enclosed Application Note IAN-102 details how a variable electronic filter can be used to measure noise spectra.

3.4 PULSE MODE OPERATION

3.4.1 INTRODUCTION

In order to provide superior transient response for pulse filtering in the time domain, the 4210 Series Filters use a 4 pole Bessel characteristic in the low-pass section when the Pulse mode is selected. This characteristic gives a maximally flat time delay (linear phase response). At the cutoff frequency selected by S3 and S4, the amplitude response will be -8.6 dB and the phase angle will be -187° . Figures 3 and 4 of IAN-101 show the normalized response for the Bessel low-pass section.

3.4.2 OPERATION AS A BESSEL LOW-PASS FILTER

To operate in the Pulse mode, set S6 to PULSE, the high-pass multiplier switch S2 to the OUT position and select the desired cutoff for the Bessel low-pass section using S3 and S4.

3.5 BAND-REJECT MODE OPERATION

3.5.1 INTRODUCTION

In the band-reject mode, the high-pass and low-pass sections are operated in parallel and their outputs are added. Thus, if the high-pass section cutoff frequency is set above the low-pass cutoff frequency, a band of frequencies between the two settings will be attenuated. In this mode, the low-pass response extends down to .004 Hz and the high-pass response extends up to 3 MHz. The filter gain is -6 dB in this mode. In the discussion that follows, all notch depths are referred to 0 dB, so it is important to recall that the filter gain in its pass-band is -6 dB.

In this mode, the high-pass frequency cutoff setting will determine the upper -3 dB frequency of the notch, and the low-pass cutoff frequency setting will determine the lower -3 dB frequency of the notch. There is little interaction between the two sections for any available notch and the -3 dB frequencies will be equal to the cutoff frequencies selected. The notch center frequency will be the geometric mean of the cutoff frequencies. That is:

$$\text{NOTCH CENTER FREQUENCY, } F_0 = \sqrt{F_{HP} \cdot F_{LP}}$$

$$\text{UPPER -3 dB FREQUENCY} = F_{HP}$$

$$\text{LOWER -3 dB FREQUENCY} = F_{LP}$$

$$\text{-3 dB BANDWIDTH} = F_{HP} - F_{LP}$$

Both a sharp notch and a wide band variable notch can be selected in the band-reject mode. The sharp notch provides greater than 50 dB attenuation and its -3dB bandwidth is $1.2 \times f_c$, where f_c is the notch center frequency. For the wide-band notch, the depths and widths are variable, depending on the spacing between the high-pass and low-pass cutoff frequencies.

Due to the discreet number of cutoff frequencies that can be selected, there are a discreet number of notch center frequencies. Within any decade it is possible to select 20 different notch frequencies for the wide-band variable notch. On a normalized basis, these frequencies are 1.0, 1.12, 1.25, 1.4, 1.6, 1.8, 2.0, 2.25, 2.5, 2.8, 3.15, 3.55, 4.0, 4.5, 5.0, 5.6, 6.3, 7.1, 8.0 and 8.9. For the sharp notch, 10 different center frequencies within any decade can be chosen; they are 1.12, 1.4, 1.8, 2.25, 2.8, 3.55, 4.5, 5.6, 7.1 and 8.9.

3.5.2 NORMALIZED FILTER RESPONSE

Figure 3.4 shows the normalized filter response for the variable width notch centered at 1.0. This family of curves is valid for any notch centered at the 1/3 octave frequency steps of 1.0, 1.25, 1.6, 2.0, 2.5, 3.15, 4.0, 5.0, 6.3, and 8.0. To make a notch at one of these frequencies, multiply the settings shown on Figure 3.4 by the desired center frequency. For convenience, Table 3.1 lists these frequencies and the notch depth and the -3 dB widths on a normalized basis for all these settings.

For example, assume a notch at 125 Hz is desired. In Table 3.1 look under the 1.25 center frequency column and choose the desired notch depth. Suppose the 57 dB notch is selected.



MEASURING NOISE SPECTRA WITH VARIABLE ELECTRONIC FILTERS

ABSTRACT

A simple general method of measuring a noise spectrum with variable electronic filters is described, and all the necessary information for measuring a noise spectrum with an ITHACO Variable Electronic Filter is provided. Errors associated with making noise measurements are discussed in the appendices.

INTRODUCTION

Although random signals occur in many forms such as voltage, current, charge, force, velocity, acceleration, temperature, etc., measuring the spectrum of a random signal is usually accomplished by converting the signal to a signal voltage, and then measuring the spectrum of the signal voltage. The spectrum of a signal voltage can be described in terms of the spectral density functions: power spectral density (mean-square voltage per unit bandwidth) and amplitude spectral density (RMS voltage per $\sqrt{\text{Hz}}$). Since the converted signal is a voltage, it is convenient to deal with the amplitude spectral density from which the power spectral density can be obtained by squaring.

A number of noise spectra are shown in figure 1. White noise (curve a) has a constant spectral density for all frequencies. Band-limited white noise (curve b) has a constant spectral density up to some frequency above which the spectral density rolls off. $1/f$ noise (curve c) has a spectral density which increases below some frequency. A typical amplifier noise spectrum (curve d) might possess $1/f$ noise at low frequencies, constant spectral density at mid frequencies, slightly increasing spectral density at higher frequencies, and band-limiting of the noise at the highest frequencies.

A measurement of the spectral density of a noise signal can be obtained at one frequency by converting the noise signal to a signal voltage; passing the signal voltage through an ideal band-pass filter with one hertz bandwidth; and measuring the filter output with a true RMS voltmeter as in figure 2. The voltmeter reading is the amplitude spectral density of the signal voltage at the filter frequency inasmuch as the meter reading is the voltage per $\sqrt{\text{Hz}}$. To obtain the complete spectrum of the noise, the measurement must be repeated at each frequency. To obtain the original noise spectrum the readings can be divided by the converter sensitivity.

There are a number of practical limitations associated with measuring a noise spectrum. The spectral density must be constant over the filter pass-band so that a one hertz band-pass filter may be too coarse at the lowest frequencies and unnecessarily fine at high frequencies. Ideal band-pass filters are not available, and for practical filters the -3 dB bandwidth and noise bandwidth may be significantly different so the noise bandwidth of the filter must be determined (appendix I). Noise introduced by the measuring instruments may alter the reading enough to require correction (see appendix II). Noise signals have larger peak factors than sinusoidal signals and failure to allow for larger peak factors will result in measurement (RMS error) of a single measurement of the spectral density of a random signal is dependent on filter bandwidth and sampling time so it is likely that measurements of spectral noise at low frequencies will require a compromise between filter bandwidth (frequency resolution), sampling time (time required to obtain a measurement), and measurement error (see appendix IV).

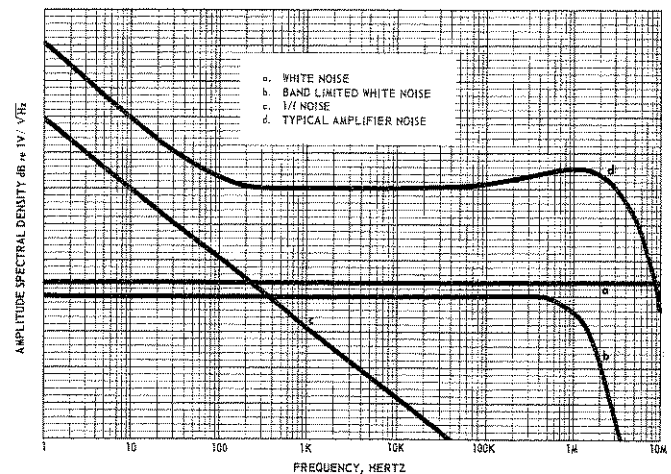

FIGURE 1 TYPICAL NOISE SPECTRA

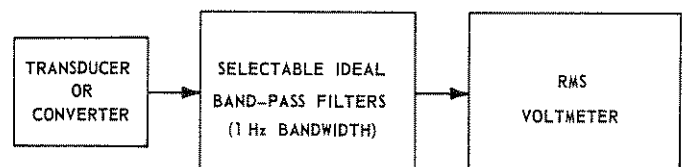

FIGURE 2 MEASURING A NOISE SPECTRUM

Finally, measurements made with other than a true RMS meter, such as a meter measuring the average absolute value but calibrated to read the RMS of a sine wave, will require corrections to obtain the true spectral density. Even so, these corrections are available for only a few types of noise signals (see appendix V).

A METHOD OF MEASURING A NOISE SPECTRUM

A method of measuring the spectral density of a noise signal is shown in figure 3. The preamplifier raises the signal level so that it is well above the filter noise. The bandpass filter selects a portion of the spectrum to measure, and for the measurement to be accurate it is necessary that the spectral density be constant over the filter pass-band. The post amp raises the signal to a level which the RMS meter can measure, and a true RMS voltmeter is used so that the spectral density measurements obtained can be used without further qualification.

The amplitude spectral density at a frequency f_o is given by formula 2 in figure 3:

$$\xi_n(f_o) = \frac{e_o}{A_1 A_2 A_3 \sqrt{B_n}} \quad (V/\sqrt{Hz})$$

If the RMS meter reading, amplifier gain, filter gain, and filter noise bandwidth are known, the amplitude spectral

density can be computed. For example if:

$$\begin{aligned} e_o &= .01 \text{ volts} & A_1 &= 10 \\ f_o &= 1,000 \text{ Hz} & A_2 &= 1 \\ B_n &= 100 \text{ Hz} & A_3 &= 1,000 \end{aligned}$$

Then the amplitude spectral density is given by

$$\xi_n(1,000 \text{ Hz}) = \frac{.01}{(10)(1)(1,000) \sqrt{100}} = 10^{-7} V/\sqrt{Hz}$$

It is often easier to compute the amplitude spectral density in terms of decibels referred to $1V/\sqrt{Hz}$ as given by formula 3 in figure 3.

Amplitude Spectral Density (dB re $1V/\sqrt{Hz}$) =

$$e'_o - [A'_1 + A'_2 + A'_3] - 10 \log_{10} B_n$$

where the RMS meter reading is given in dB V (dB re 1 V) and amplifier and filter gains are given in dB. For example:

$$\begin{aligned} e'_o &= -40 \text{ dBV} & A'_1 &= 20 \text{ dB} \\ 10 \log_{10} B_n &= 20 & A'_2 &= 0 \text{ dB} \\ f_o &= 1,000 \text{ Hz} & A'_3 &= 60 \text{ dB} \end{aligned}$$

Amplitude spectral density at 1000 Hz = $-40 - [80] - 20 = -140$ [dB re $1V/\sqrt{Hz}$]

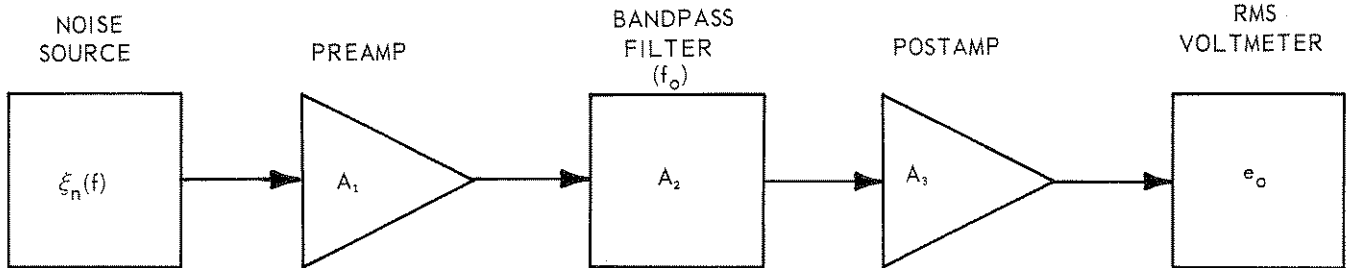

IF THE SPECTRAL DENSITY IS CONSTANT OVER THE FILTER PASS-BAND:

$$1 \quad e_o = A_1 A_2 A_3 \xi_n(f_o) \sqrt{B_n}$$

AMPLITUDE SPECTRAL DENSITY AT f_o , $\xi_n(f_o)$ in V/\sqrt{Hz}

$$2 \quad \xi_n(f_o) = \frac{e_o}{A_1 A_2 A_3 \sqrt{B_n}}$$

3 AMPLITUDE SPECTRAL DENSITY, dB re $1V/\sqrt{Hz}$ at f_o

$$\begin{aligned} &= 20 \log_{10} \xi_n(f_o) \\ &= 20 \log_{10} e_o - 20 \log_{10} A_1 A_2 A_3 - 10 \log_{10} B_n \\ &= e'_o - [A'_1 + A'_2 + A'_3] - 10 \log_{10} B_n \end{aligned}$$

WHERE A_1 = PREAMP GAIN
 A_2 = FILTER GAIN
 A_3 = POSTAMP GAIN
 B_n = FILTER NOISE BANDWIDTH
 e_o = RMS VOLTMETER READING
 $\xi_n(f_o)$ = AMPLITUDE SPECTRAL DENSITY AT f_o IN V/\sqrt{Hz}

WHERE e'_o = RMS READING IN dBV
 A'_1 = PREAMP GAIN IN dB
 A'_2 = FILTER GAIN IN dB
 A'_3 = POSTAMP GAIN IN dB
 f_o = FILTER CENTER FREQUENCY

FIGURE 3 A METHOD OF MEASURING AMPLITUDE SPECTRAL DENSITY

Chart I is a simple form for recording data and computing the amplitude spectral density. Column 1 is the frequency of the measurement (center frequency of the filter). Columns 2 and 3 are the high-pass and low-pass filter settings if a variable electronic filter is used. Column 4 is the filter gain (insertion loss) in decibels. Column 5 is $10 \log_{10} B_n$ where B_n is the noise bandwidth. Columns 6 and 7 are the preamp and postamp gain in decibels. Column 8 is the RMS meter reading in dB V (decibels referred to 1 Volt). Column 9 is the amplitude spectral density in dB re $1V/\sqrt{\text{Hz}}$. Column 10 is the amplitude spectral density in Volts/ $\sqrt{\text{Hz}}$. For example:

- ① Center frequency, Hz = 1,000
- ② High-pass setting, Hz = 800
- ③ Low-pass setting, Hz = 1,250
- ④ Filter gain, dB = -1.28
- ⑤ $10 \log_{10} B_n$ = 28.32
- ⑥ Preamp gain, dB = 40.00
- ⑦ Postamp gain, dB = 40.00
- ④+⑤+⑥+⑦ = 107.04
- ⑧ RMS meter reading, dB V = -33.0
- ⑨ Amplitude Spectral Density at 1000 Hz (dB) re $1V/\sqrt{\text{Hz}}$ = ⑧ - [④+⑤+⑥+⑦] = -140
- ⑩ Amplitude Spectral Density at 1,000 Hz (Volt/ $\sqrt{\text{Hz}}$) = Anti \log_{10} ⑨ = 10^{-7}

MEASURING A NOISE SPECTRUM WITH A VARIABLE ELECTRONIC FILTER

A variable electronic filter, as defined in this note, consists of cascaded high-pass and low-pass filters with independent control of the cut-off frequencies. The cut-off frequency is determined by a frequency setting switch (or dial) and a frequency multiplier switch. If the frequency setting switches are not changed, changing the multiplier switches by a factor of ten will change the cut-off frequencies, center frequency, bandwidth, and noise bandwidth by a factor of ten. It is convenient therefore, to tabulate the filter characteristics for various filter settings with the high-pass multiplier set to unity and consider the effects of the high-pass multiplier separately.

Chart II lists the -3 dB frequencies, center frequency, bandwidth, noise bandwidth, and filter gain for ITHACO Variable Electronic Filters with the high-pass multiplier set to unity and the low-pass setting less than a decade above the high-pass setting.

For filter separation greater than ten:

$$\frac{F_{LP}}{F_{HP}} \geq 10 \quad \text{Noise bandwidth, Hz} = 1.023 (F_{LP} - F_{HP})$$

$$\text{Filter Gain, dB} = 0.00$$

For high-pass multiplier settings other than unity all frequencies in Chart II are multiplied by the high-pass multiplier.

Chart III provides a means of obtaining $10 \log_{10} B_n$ for ITHACO Variable Electronic Filters with 0, 1/3, 2/3 and 1 octave separation of the high-pass and low-pass filters. Again the tables show $10 \log_{10} B_n'$ where B_n' is the noise bandwidth for that setting with the high-pass multiplier set to unity:

Noise Bandwidth, $B_n = (B_n')$ (H.P. Multiplier) so that,

$$10 \log_{10}(B_n) = 10 \log_{10} [B_n' \text{ (H.P. Mult)}]$$

$$= 10 \log_{10} B_n' + 10 \log_{10}(\text{H.P. Mult})$$

For example:

High-Pass cut-off frequency, $F_{HP} = 1.00 \times 10^3 \text{ Hz}$

Low-Pass cut-off frequency, $F_{LP} = 2.00 \times 10^3 \text{ Hz}$

$$\text{Separation } \frac{F_{LP}}{F_{HP}} = \frac{2.00 \times 10^3}{1.00 \times 10^3} = 2.00 \quad (1 \text{ octave})$$

④ (Column 4 in table for 1 octave separation)

$$10 \log_{10} B_n' = .66$$

⑥ (Column 6 in table for H.P. Multiplier)

$$10 \log_{10}(\text{H.P. Mult}) = 10 \log_{10} 10^3 = 30.00$$

$$10 \log_{10} B_n = \text{④} + \text{⑥} = 30.66$$

Similarly:

High-Pass cut-off frequency, $F_{HP} = 2.00 \times 10^2 \text{ Hz}$

Low-Pass cut-off frequency, $F_{LP} = 2.50 \times 10^2 \text{ Hz}$

$$\text{Separation } \frac{F_{LP}}{F_{HP}} = \frac{2.50 \times 10^2}{2.00 \times 10^2} = 1.25 \quad (1/3 \text{ octave})$$

④ (Column 4 in table for 1/3 octave separation)

$$10 \log_{10} B_n' = .88$$

⑥ (Column 6 in table for H.P. Multiplier)

$$10 \log_{10}(\text{H.P. Mult}) = 10 \log_{10}(10^3) = 20.00$$

$$10 \log_{10} B_n = \text{④} + \text{⑥} = 20.88$$

The procedure for measuring a noise spectrum with a variable electronic filter is identical to that described above if the noise bandwidth and filter gain are known. The noise bandwidth and filter gain for ITHACO Variable Electronic Filters can be obtained from Chart II or Chart III. The measurements can then be recorded, and the amplitude spectral density computed on Chart I.

A special case worthy of discussion is the measurement of spectral noise in one octave frequency steps. Such

**CHART I
AMPLITUDE SPECTRAL DENSITY**

MEASUREMENTS OF _____

DATE _____

MEASUREMENT BY _____

①	②	③	④	⑤	⑥	⑦	⑧ *	⑨ **	⑩ ***
CENTER FREQUENCY Hz	HIGH-PASS SETTING Hz	LOW-PASS SETTING Hz	FILTER GAIN dB	$10 \log_{10} B_n$	PREAMP GAIN dB	POSTAMP GAIN dB	RMS VOLTAGE dBV	AMPLITUDE SPECTRAL DENSITY dB **	AMPLITUDE SPECTRAL DENSITY V/√Hz

* RMS VOLTAGE, dBV (dB REFERRED TO 1 VOLT)
 ** AMPLITUDE SPECTRAL DENSITY, dB re 1V/√Hz = ⑧ - [④ + ⑤ + ⑥ + ⑦]
 *** AMPLITUDE SPECTRAL DENSITY, V/√Hz = ANTILOG ⑨

CHART III

LOGARITHM OF THE NOISE BANDWIDTH, $10 \log_{10}$ (NOISE BANDWIDTH), FOR BAND-PASS FILTERS FORMED BY CASCADED 4 POLE BUTTERWORTH FILTERS

HIGH-PASS
FREQUENCY
MULTIPLIER

$$\frac{F_{LP}}{F_{HP}} \approx 2.00$$

$$\frac{F_{LP}}{F_{HP}} \approx 1.6$$

$$\frac{F_{LP}}{F_{HP}} \approx 1.25$$

$$F_{HP} = F_{LP}$$

1 OCTAVE SEPARATION

2/3 OCTAVE SEPARATION

1/3 OCTAVE SEPARATION

NO SEPARATION

(1)	(2)	(3)	(4)	(5)	(6)
H. P. SETTING Hz	L. P. SETTING Hz	CENTER FREQ Hz	*	H. P. MULT	**
1.00	2.00	1.41	.66	X.001	-30
1.25	2.50	1.77	1.62	X.01	-20
1.60	3.15	2.24	2.70	X.1	-10
2.00	4.00	2.83	3.67	X1	0
2.50	5.00	3.54	4.64	X10	10
3.15	6.30	4.45	5.64	X100	20
4.00	8.00	5.66	6.68	X1K	30
5.00	10.0	7.07	7.65	X10K	40
6.30	12.5	8.87	8.65	X100K	50

(1)	(2)	(3)	(4)	(5)	(6)
H. P. SETTING Hz	L. P. SETTING Hz	CENTER FREQ Hz	*		
1.00	1.60	1.26	-.72		
1.25	2.00	1.58	.25		
1.60	2.50	2.00	1.33		
2.00	3.15	2.51	2.30		
2.50	4.00	3.16	3.52		
3.15	5.00	3.97	4.27		
4.00	6.30	5.02	5.31		
5.00	8.00	6.32	6.28		
6.30	10.0	7.94	7.28		
8.00	12.5	10.00	8.32		
10.0	16.0	12.65	9.29		
FILTER GAIN, = -1.28 dB					

(1)	(2)	(3)	(4)	(5)	(6)
H. P. SETTING Hz	L. P. SETTING Hz	CENTER FREQ Hz	*		
1.00	1.25	1.12	-2.13		
1.25	1.60	1.41	-1.16		
1.60	2.00	1.79	-.09		
2.00	2.50	2.24	.88		
2.50	3.15	2.81	1.85		
3.15	4.00	3.55	2.86		
4.00	5.00	4.47	3.89		
5.00	6.30	5.61	4.86		
6.30	8.00	7.10	5.87		
8.00	10.0	8.94	6.90		
10.0	12.5	11.18	7.87		
FILTER GAIN, = -2.92 dB					

(1)	(2)	(3)	(4)	(5)	(6)
H. P. SETTING Hz	L. P. SETTING Hz	CENTER FREQ Hz	*		
1.00	1.00	1.00	-2.90		
1.25	1.25	1.25	-1.93		
1.60	1.60	1.60	-.86		
2.00	2.00	2.00	.11		
2.50	2.50	2.50	1.08		
3.15	3.15	3.15	2.09		
4.00	4.00	4.00	3.12		
5.00	5.00	5.00	4.09		
6.30	6.30	6.30	5.10		
8.00	8.00	8.00	6.13		
10.0	10.0	10.0	7.10		
FILTER GAIN, = -6.02 dB					

* $10 \log_{10} B'_n$ WHERE B'_n = NOISE BANDWIDTH WITH X1 H.P. MULTIPLIER

** $10 \log_{10}$ (HIGH-PASS MULTIPLIER) = $10 \log_{10}$ (5)

NOISE BANDWIDTH, $B_n = (B'_n) \times$ (HIGH-PASS MULTIPLIER)

$10 \log_{10} B_n = 10 \log_{10} [(B'_n) \times (H.P. MULTIPLIER)] = 10 \log_{10} B'_n + 10 \log_{10} (H.P. MULTIPLIER) = (4) + (6)$

CHART IV
 AMPLITUDE SPECTRAL DENSITY IN OCTAVE STEPS WITH ITHACO VARIABLE ELECTRONIC FILTERS
 MEASUREMENT OF _____ DATE _____
 MEASUREMENT BY _____

①	②	③	④	⑤	⑥	⑦	⑧ *	⑨ **	⑩ ***
CENTER FREQUENCY Hz	HIGH-PASS SETTING Hz	LOW-PASS SETTING Hz	FILTER GAIN dB	$10 \log_{10} B_n$	PREAMP GAIN dB	POSTAMP GAIN dB	RMS VOLTAGE dBV	AMPLITUDE SPECTRAL DENSITY dB **	AMPLITUDE SPECTRAL DENSITY V/ $\sqrt{\text{Hz}}$
1.0	1.00	1.00	-6.0	-2.9					
2.0	2.00	2.00	-6.0	+1.1					
4.0	4.00	4.00	-6.0	+3.1					
8.0	8.00	8.00	-6.0	+6.1					
16.0	16.0	16.0	-6.0	+9.1					
31.5	31.5	31.5	-6.0	+12.1					
63.0	63.0	63.0	-6.0	+15.1					
125	125	125	-6.0	+18.1					
250	250	250	-6.0	+21.1					
500	500	500	-6.0	+24.1					
1,000	1,000	1,000	-6.0	+27.1					
2,000	2,000	2,000	-6.0	+30.1					
4,000	4,000	4,000	-6.0	+33.1					
8,000	8,000	8,000	-6.0	+36.1					
16,000	16,000	16,000	-6.0	+39.1					
31,500	31,500	31,500	-6.0	+42.1					
63,000	63,000	63,000	-6.0	+45.1					

* RMS VOLTAGE, dBV (dB REFERRED TO 1 VOLT)

** AMPLITUDE SPECTRAL DENSITY, dB re 1V/ $\sqrt{\text{Hz}}$ = ⑧ - [④ + ⑤ + ⑥ + ⑦]

*** AMPLITUDE SPECTRAL DENSITY, V/ $\sqrt{\text{Hz}}$ = ANTILOG ⑨

spectral noise measurements will provide adequate resolution for practically all noise spectra. The suggested method is the simplest, most direct way of setting a variable electronic filter, since the high-pass frequency setting, low-pass frequency setting, and center frequency are identical, and the filter gain is -6.0 dB. Chart IV is a simple form for recording the measurements and computing the amplitude spectral density. Chart IV is identical to Chart I except that the filter settings, noise bandwidth, and filter gain are tabulated for the internationally preferred octave frequencies used in ITHACO Variable Electronic Filters.

APPENDIX I

NOISE BANDWIDTH

An ideal band-pass filter is defined as a filter with no attenuation in the pass-band and infinite attenuation outside the pass-band. The noise bandwidth of a filter is defined as the bandwidth of an ideal filter which has the same value of absolute transmittance in its pass-band as the maximum absolute transmittance of the filter and delivers the same mean square output voltage from a white noise source as the filter. This definition can be stated mathematically:

<u>IDEAL FILTER</u>	<u>MEAN SQUARE OUTPUT</u>	<u>PRACTICAL FILTER</u>
$\int_0^{\infty} \xi_n^2 Y_o^2 df$	$= e_o^2$	$= \int_0^{\infty} \xi_n^2 Y(f) ^2 df$
$\xi_n^2 Y_o^2 \int_{f_1}^{f_2} df$	$= e_o^2$	$= \xi_n^2 \int_0^{\infty} Y(f) ^2 df$
$\xi_n^2 Y_o^2 B_n$	$= e_o^2$	$= \xi_n^2 \int_0^{\infty} Y(f) ^2 df$

Solving for B_n :

$$\text{Noise Bandwidth, } B_n = \frac{1}{Y_o^2} \int_0^{\infty} |Y(f)|^2 df$$

where $B_n = (f_2 - f_1) =$ filter noise bandwidth

$\xi_n =$ amplitude spectral density of the white noise source $V/\sqrt{\text{Hz}}$

$Y(f) =$ filter transmittance function

$Y_o =$ Maximum absolute value of $Y(f)$

It follows that if the amplitude spectral density is constant across the filter pass-band, the amplitude spectral density at the filter frequency is given by:

$$\xi_n(f_o), V/\sqrt{\text{Hz}} = \frac{e_o}{Y_o \sqrt{B_n}}$$

The ratio of noise bandwidth to -3 dB bandwidth is 1.57, 1.11, 1.05, 1.025, 1.02, 1.01, --- 1.00 for a 1,2,3,4,5,6, --- ∞ pole low-pass Butterworth filter. The noise bandwidths of cascaded 4 pole Butterworth high-pass and low-pass filters are tabulated in Chart II.

APPENDIX II

ADDITION AND SUBTRACTION OF NOISE LEVEL IN DECIBELS

ADDITION

If two non coherent noise signals are combined, the resulting noise level in dB can be calculated from the dB values of the separate noise signals as follows:

1. Calculate the difference (in dB) between the two noise signals $L_2 - L_1$.
2. Find ΔL in the graph below.
3. Add ΔL to the highest of the two signals. The result is the noise level in dB of the combined signals.

EXAMPLE:

Two non coherent noise signals, -80 dB V and -85 dB V are to be combined.

1. $L_2 - L_1 = (-80 \text{ dBV}) - (-85 \text{ dBV}) = 5 \text{ dB}$
2. From the graph below, $\Delta L = 1.2 \text{ dB}$
3. Combined signal level $= (-80 \text{ dBV}) + 1.2 \text{ dB} = -78.8 \text{ dBV}$

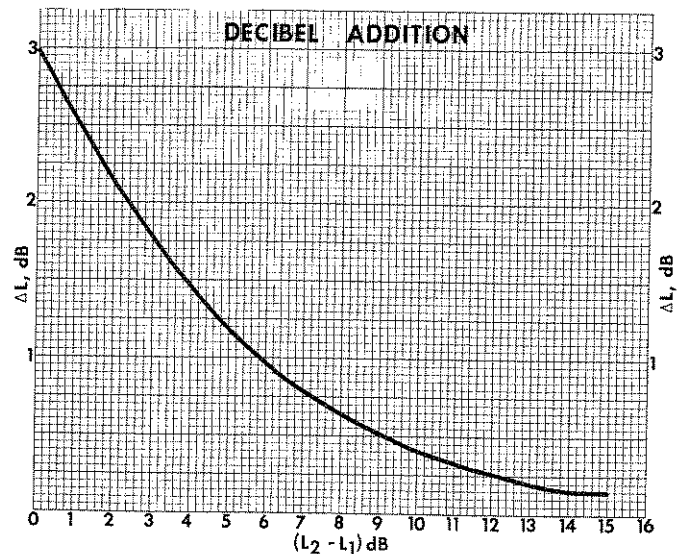

SUBTRACTION

Measurements made in the presence of instrument noise can be corrected by decibel subtraction. If the signal to noise ratio is greater than 20 dB the effect of the interfering noise can be ignored. Specifically when the spectral noise to be measured is not 20 dB larger than the preamplifier input noise, corrections must be made to obtain the true spectral noise level.

1. Calculate the difference (in dB) between the signal plus noise, L_{S+N} and noise level, L_N :

$$(L_{S+N} - L_N)$$
2. Find ΔL in the graph below.
3. Subtract ΔL from the signal plus noise ($L_{S+N} - \Delta L$).
 The result is the signal level in dB.

EXAMPLE:

Given: $L_{S+N} = -85$ dBV
 $L_N = -90$ dBV

1. $L_{S+N} - L_N = (-85 \text{ dBV}) - (-90 \text{ dBV})$
 $= 5$ dB
2. $\Delta L = 1.7$ dB
3. $L_N = L_{S+N} - \Delta L$
 $= -85 - 1.7$
 $= -86.7$ dB V

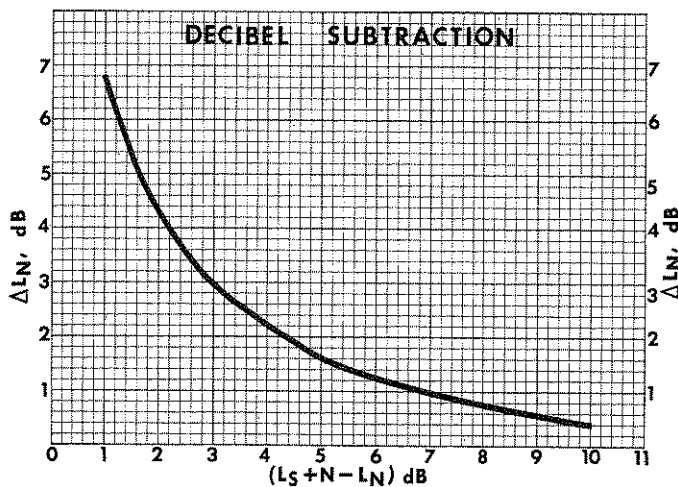

APPENDIX III

QUALIFIED PEAK FACTORS AND CLIPPING ERRORS

Gaussian noise has a probability greater than zero of exceeding any finite magnitude, no matter how large with the probability falling off rapidly for large values. In practical experiments, however, large values are limited by non-linearities in either the noise source or the measuring instruments, so it is important to know how a measurement would be affected by limiting the noise peaks.

A fixed peak factor (ratio of PEAK to RMS) cannot be assigned to a Gaussian noise, since, if sufficient time is allowed and the measuring system doesn't limit the measurement, any value can be expected. A qualified peak factor can be assigned for a specified probability that the corresponding peak will be exceeded. A table of qualified peak factors is given below for Gaussian and Rayleigh noise. Rayleigh noise occurs when Gaussian noise is passed through a filter with narrow bandwidth compared with the filter center frequency. The resultant noise possesses a low-frequency envelope which has a Rayleigh distribution (for more information, reader is referred to *Electrical Noise*, W.R. Bennett, McGraw-Hill).

$$\text{QUALIFIED PEAK FACTOR} = \frac{\text{PEAK}}{\text{RMS}}$$

PERCENT OF TIME PEAK IS EXCEEDED	GAUSSIAN NOISE		RAYLEIGH NOISE	
	$\frac{\text{PEAK}}{\text{RMS}}$	$\left(\frac{\text{PEAK}}{\text{RMS}}\right) \text{ dB}$	$\frac{\text{PEAK}}{\text{RMS}}$	$\left(\frac{\text{PEAK}}{\text{RMS}}\right) \text{ dB}$
10	1.65	4.3	1.52	3.6
1	2.58	8.2	2.15	6.6
.1	3.29	10.4	2.56	8.4
.01	3.89	11.8	3.03	9.6
.001	4.42	12.9	3.39	10.6
.0001	4.89	13.8	3.68	11.3

Errors associated with limiting in the measuring instruments will vary according to whether the limiting is "hard" or "soft" as well as the distribution of the noise being measured. It is not usually practical to attempt to correct for limiting error, but a bench mark can be provided by tabulating the errors associated with measuring the mean-square, RMS, and average absolute value of a Gaussian noise process with various clipping levels.

CLIPPING LEVEL σ	PERCENT ERROR		
	AVERAGE ABSOLUTE VALUE	RMS VALUE	MEAN-SQUARE VALUE
1.9	2.3	5.1	9.9
2.1	1.6	3.2	6.3
2.3	.92	1.9	3.8
2.5	.50	1.1	2.2
2.7	.27	.63	1.3
2.9	.14	.35	.69
3.1	.07	.18	.36
3.3	.03	.09	.18
3.5	<.01	.04	.09
3.7	<.01	.02	.01
3.9	<.01	.01	.02
4.1	<.01	<.01	.01

The most common method of determining the RMS value is to compute the time integral, but the infinite time interval in the definition is replaced with a finite time interval, and the computation is then an estimate of true mean-squared value. If samples of the signal are taken of duration T, and the RMS value of the samples calculated, the calculated values will vary around the true RMS value. The deviation of the sampled values around the true RMS value will vary with the bandwidth and sampling time. If the noise is squared and sampled over periods of time T and if the product $B_n T \gg 1$ where B_n is the noise bandwidth, the standard deviation of the energy fluctuation is:

$$\textcircled{4} \quad \frac{\sigma}{(e_{rms})^2} = \frac{1}{\sqrt{B_n T}} \text{ where } \sigma = \text{standard deviation}$$

When the sampling process is replaced by continuous averaging process such as an RC network:

$$\textcircled{5} \quad \frac{\sigma}{(e_{rms})^2} = \frac{1}{\sqrt{2B_n RC}}$$

The effective sampling time of the RC network is twice the RC time constant.

Formulas $\textcircled{4}$ and $\textcircled{5}$ were derived for energy fluctuations so they are valid for energy fluctuation. For small energy fluctuations:

$$\textcircled{6} \quad \frac{1}{\sqrt{B_n T}} = \frac{1}{\sqrt{B_n 2RC}} = \frac{\sigma}{(e_{rms})^2} \approx \frac{2\sigma'}{e_{rms}} \approx \frac{2\sigma''}{e_{ave}}$$

where B_n = Noise bandwidth of the measurement

e_{rms} = True RMS value of the noise

σ = Standard deviation around the true mean-square value

σ' = Standard deviation around the true RMS value

σ'' = Standard deviation around the average absolute value

The practical aspects of formula 6 become more apparent when the averaging time constant required to keep the RMS value to less than 1% of the true RMS value is considered:

$$\textcircled{7} \quad \frac{\sigma'}{e_{rms}} \leq .01$$

The time constant required is 1,250, 125 and 12.5 seconds for noise bandwidths of 1, 10 and 100 Hertz. Even with these time constants there is no guarantee that a single measurement will be less than 1% of the true RMS measurement. It is only more probable that it will be

APPENDIX IV

SAMPLING ERRORS ASSOCIATED WITH MEASURING A RANDOM PROCESS

The RMS value of a continuous ergodic random process can be determined from the power spectral density:

$$\textcircled{1} \quad (e_{rms})^2 = \int_0^{\infty} P_{SD}(f) df,$$

where P_{SD} = power spectral density,
from the probability density function:

$$\textcircled{2} \quad (e_{rms})^2 = \int_{-\infty}^{+\infty} V^2 p(v) dv,$$

where $p(v)$ = probability density function

V = signal level,

or from the time integral:

$$\textcircled{3} \quad (e_{rms})^2 = \lim_{T \rightarrow \infty} \frac{1}{T} \int_0^T e^2(t) dt,$$

where $e(t)$ = time function of the random process.

less than 1% deviation from the true RMS value. The Chart below gives the RC time constant required to keep the standard deviation to less than 1%, 2%, 3%, 5% and 10% of the true RMS value for noise bandwidths of 1,3, 10,30 and 100 Hz.

$\left(\frac{\sigma}{\sigma_{RMS}}\right)$	RC B_n	RC, SECONDS				
		$B_n = 1 \text{ Hz}$	$B_n = 3$	$B_n = 10 \text{ Hz}$	$B_n = 30$	$B_n = 100$
.01	1.25×10^3	1,250	417	125	41.7	12.5
.02	3.13×10^2	313	104	31.3	10.4	3.1
.03	1.4×10^2	140	46.7	14	4.7	1.4
.05	50	50	16.7	5	1.7	.5
.1	125	12.5	4.2	12.5	.4	.1

SAMPLING ERRORS

APPENDIX V

ERRORS ASSOCIATED WITH MEASURING A RANDOM PROCESS WITH AN INSTRUMENT MEASURING THE AVERAGE ABSOLUTE VALUE AND CALIBRATED TO READ RMS FOR A SINEWAVE

The spectral density measurements described in this paper require RMS or Mean-Square values of the noise, and these can be obtained by using a true RMS meter.

The RMS value of a random process can also be obtained from measurements made by an instrument measuring the average absolute value and calibrated to read the RMS of a sine wave if the form factor of the noise is known:

$$\text{FORM FACTOR} = \frac{\text{RMS}}{\text{AVE, ABSOLUTE VALUE}}$$

The form factor and the measurement error of an instrument which measures the average absolute value but calibrated to the RMS value of a sine wave are tabulated below for a sine wave, Gaussian noise, and Rayleigh noise.

In many cases the noise signal cannot be classified and the form factor is not known. Use of a true RMS meter would eliminate these corrections and the measurement need not be limited to a particular type of noise.

USEFUL FACTS FOR METERS WHICH MEASURE AVERAGE ABSOLUTE VALUE BUT ARE CALIBRATED TO READ RMS VALUE OF A SINE WAVE

	* FORM FACTOR = $\frac{\text{RMS}}{\text{AVE ABS}}$		** ERROR OF AVERAGE READING INSTRUMENT	
	PER UNIT	dB	PERCENT	dB
SINE WAVE	1.111	.91	0	0
GAUSSIAN NOISE	1.253	1.96	-11.3	-1.05
RAYLEIGH NOISE	1.128	1.04	-1.5	-1.13

* FORM FACTOR = RATIO RMS TO THE AVERAGE ABSOLUTE VALUE

** ERROR OF AN AVERAGE READING INSTRUMENT CALIBRATED TO READ THE RMS VALUE OF A SINE WAVE

ITHACO PRODUCTS INCLUDE:

scientific and engineering

lock-in amplifiers, light beam choppers, ratiometers, low noise preamplifiers, electronic filters

data acquisition

instrumentation amplifiers, seismic amplifiers, auto-ranging amplifiers, voltage-controlled amplifiers, compression amplifiers, computer-controlled amplifiers, charge amplifiers, dynamic strain amplifiers, low noise preamplifiers, multiple channel electronic filters, anti alias filters, hydrophones

agricultural and food processing

ultrasonic instruments for live animal evaluation

spacecraft

horizon scanners and attitude control system components



735 W CLINTON ST ITHACA NEW YORK 14850 PHONE 607-272-7640 TWX 510-255-9307

**BAND-REJECT MODE -- CUTOFF FREQUENCY SETTINGS FOR THE VARIABLE NOTCH
CENTER FREQUENCY**

NOTCH DEPTH -dB		1.0	1.25	1.6	2.0	2.5	3.15	4.0	5.0	6.3	8.0	10.0
11.0	HIGH-PASS	1.25	1.6	2.0	2.5	3.15	4.0	5.0	6.3	8.0	10.0	12.5
	LOW-PASS	0.8	1.0	1.25	1.6	2.0	2.5	3.15	4.0	5.0	6.3	8.0
	-3 dB WIDTH	.45	.6	.75	.9	1.15	1.5	1.85	2.3	3.0	3.7	4.5
30.0	HIGH-PASS	1.6	2.0	2.5	3.15	4.0	5.0	6.3	8.0	10.0	12.5	16.0
	LOW-PASS	0.63	0.8	1.0	1.25	1.6	2.0	2.5	3.15	4.0	5.0	6.3
	-3 dB WIDTH	.97	1.2	1.5	1.9	2.4	3.0	3.8	4.85	6.0	7.5	9.7
37.0	HIGH-PASS	2.0	2.5	3.15	4.0	5.0	6.3	8.0	10.0	12.5	16.0	20.0
	LOW-PASS	0.5	0.63	0.8	1.0	1.25	1.6	2.0	2.5	3.15	4.0	5.0
	-3 dB WIDTH	1.5	1.87	2.35	3.0	3.75	4.7	6.0	7.5	9.35	12.0	15.0
38.0	HIGH-PASS	2.5	3.15	4.0	5.0	6.3	8.0	10.0	12.5	16.0	20.0	25.0
	LOW-PASS	0.4	0.5	0.63	0.8	1.0	1.25	1.6	2.0	2.5	3.15	4.0
	-3 dB WIDTH	2.1	2.65	3.37	4.2	5.3	6.75	8.4	10.5	13.5	16.85	21.0
44.0	HIGH-PASS	3.15	4.0	5.0	6.3	8.0	10.0	12.5	16.0	20.0	25.0	31.5
	LOW-PASS	0.315	0.4	0.5	0.63	0.8	1.0	1.25	1.6	2.0	2.5	3.15
	-3 dB WIDTH	2.84	3.6	4.5	5.67	7.2	9.0	11.25	14.4	18.0	22.5	28.35
50.0	HIGH-PASS	4.0	5.0	6.3	8.0	10.0	12.5	16.0	20.0	25.0	31.5	40.0
	LOW-PASS	0.25	0.315	0.4	0.5	0.63	0.8	1.0	1.25	1.6	2.0	2.5
	-3 dB WIDTH	3.75	4.69	5.9	7.5	9.37	11.7	15.0	18.75	23.4	29.5	37.5
57.0	HIGH-PASS	5.0	6.3	8.0	10.0	12.5	16.0	20.0	25.0	31.5	40.0	50.0
	LOW-PASS	0.2	0.25	0.315	0.4	0.5	0.63	0.8	1.0	1.25	1.6	2.0
	-3 dB WIDTH	4.8	6.05	7.69	9.6	12.0	15.37	19.2	24.0	30.25	38.4	48.0
64.0	HIGH-PASS	6.3	8.0	10.0	12.5	16.0	20.0	25.0	31.5	40.0	50.0	63.0
	LOW-PASS	0.16	0.2	0.25	0.315	0.4	0.5	0.63	0.8	1.0	1.25	1.6
	-3 dB WIDTH	6.14	7.8	9.75	12.19	15.6	19.5	24.37	30.7	39.0	48.75	61.4
71.0	HIGH-PASS	8.0	10.0	12.5	16.0	20.0	25.0	31.5	40.0	50.0	63.0	80.0
	LOW-PASS	0.125	0.16	0.2	0.25	0.315	0.4	0.5	0.63	0.8	1.0	1.25
	-3 dB WIDTH	7.88	9.84	12.3	15.75	19.69	24.6	31.0	39.37	49.2	62.0	78.75
75.0	HIGH-PASS	10.0	12.5	16.0	20.0	25.0	31.5	40.0	50.0	63.0	80.0	100.0
	LOW-PASS	0.1	0.125	0.16	0.2	0.25	0.315	0.4	0.5	0.63	0.8	1.0
	-3 dB WIDTH	9.9	12.38	15.84	19.8	24.75	31.19	39.6	49.5	62.37	79.2	99.0

NOTCH CENTER FREQUENCY, $F_o = \sqrt{F_{HP} \cdot F_{LP}}$
 UPPER -3 dB FREQUENCY = F_{HP}
 LOWER -3 dB FREQUENCY = F_{LP}
 -3 dB BANDWIDTH = $F_{HP} - F_{LP}$

TABLE 3.1

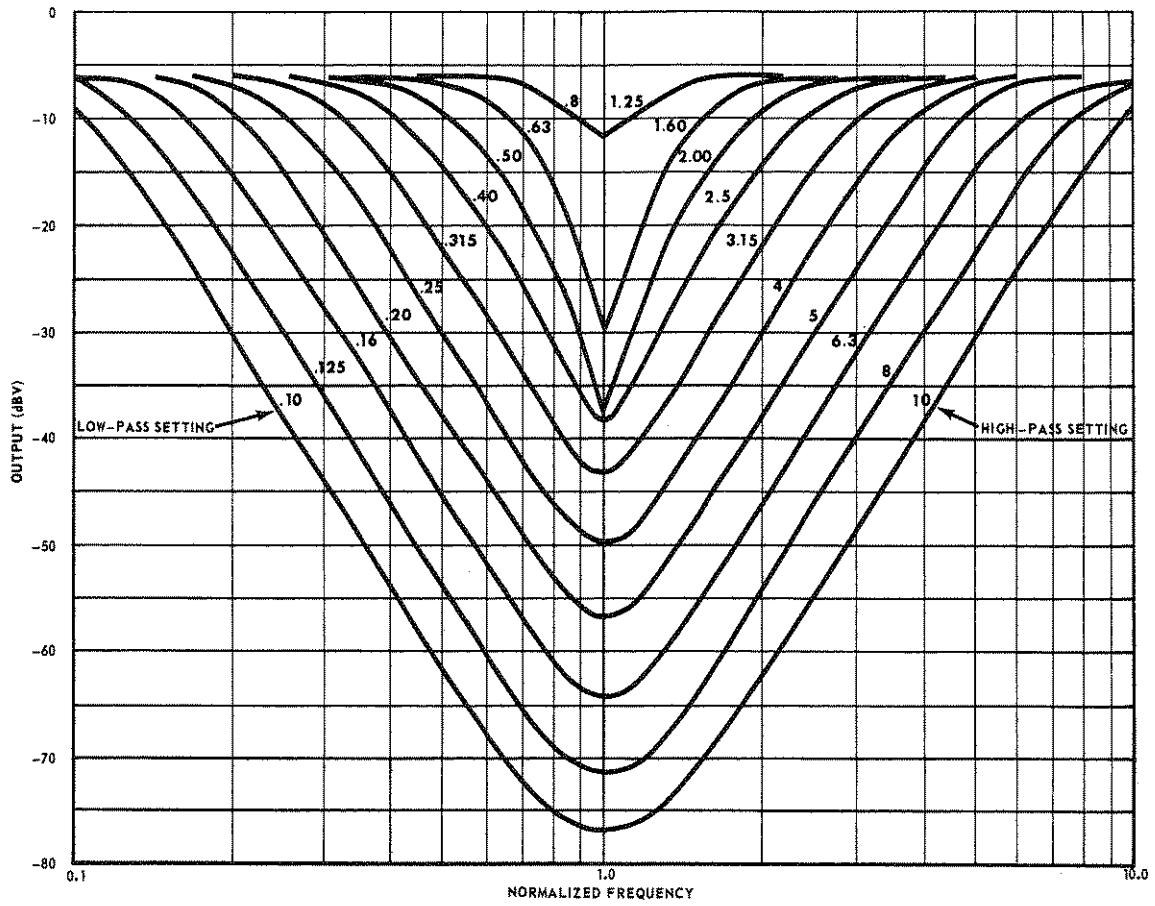

FIGURE 3.4 BAND REJECT NORMALIZED FAMILY CENTERED AT 1.0

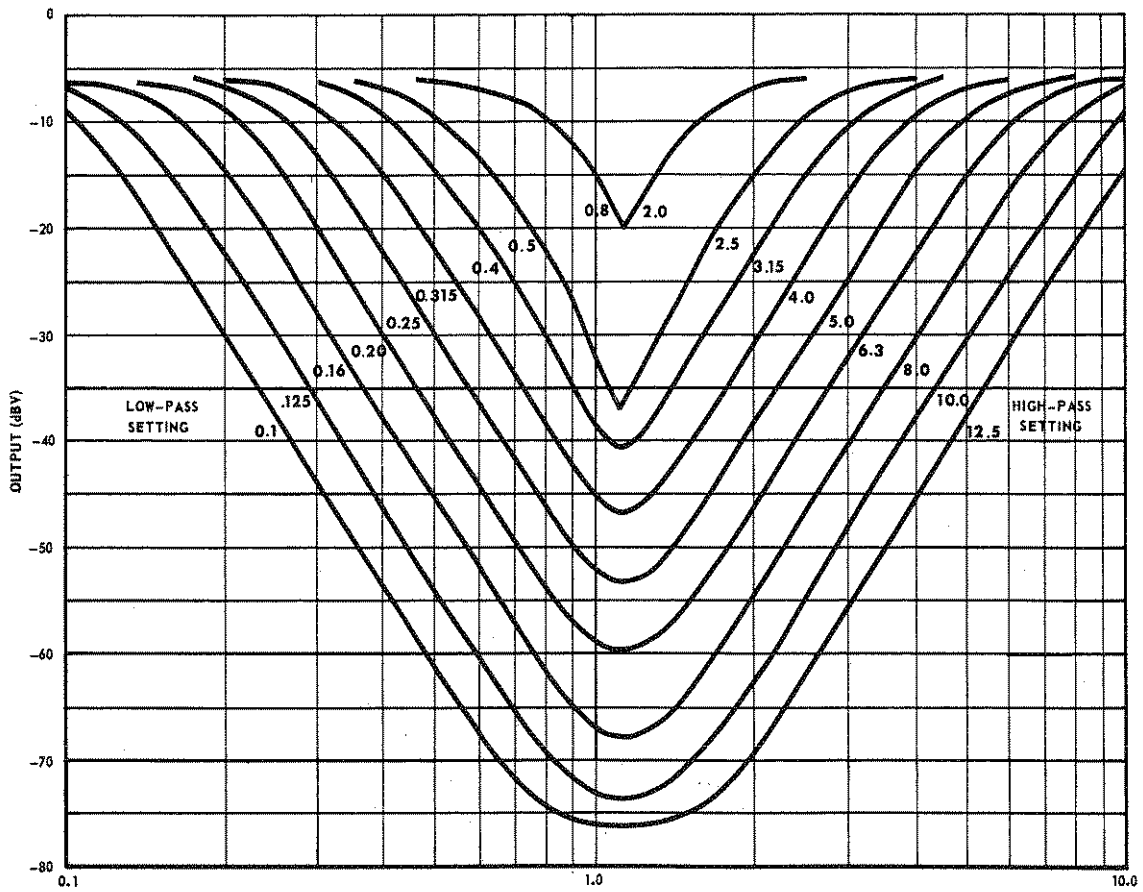

FIGURE 3.5 BAND REJECT NORMALIZED FAMILY CENTERED AT 1.12

The settings shown must be multiplied by 100 $\left(\frac{125}{1.25} = 100\right)$ to center the notch at 125 Hz. So the high-pass frequency cutoff should be set for 630 Hz and the low-pass frequency cutoff should be set for 25 Hz. The upper -3 dB frequency is 630 Hz and the lower -3 dB frequency is 25 Hz so the -3 dB bandwidth is 605 Hz.

Figure 3.5 shows the normalized filter response for the variable width notch centered at 1.12. Table 3.2 provides the necessary setting information for producing these notches at frequencies of 1.12, 1.4, 1.8, 2.25, 2.8, 3.55, 4.5, 5.6, 7.1 and 8.9.

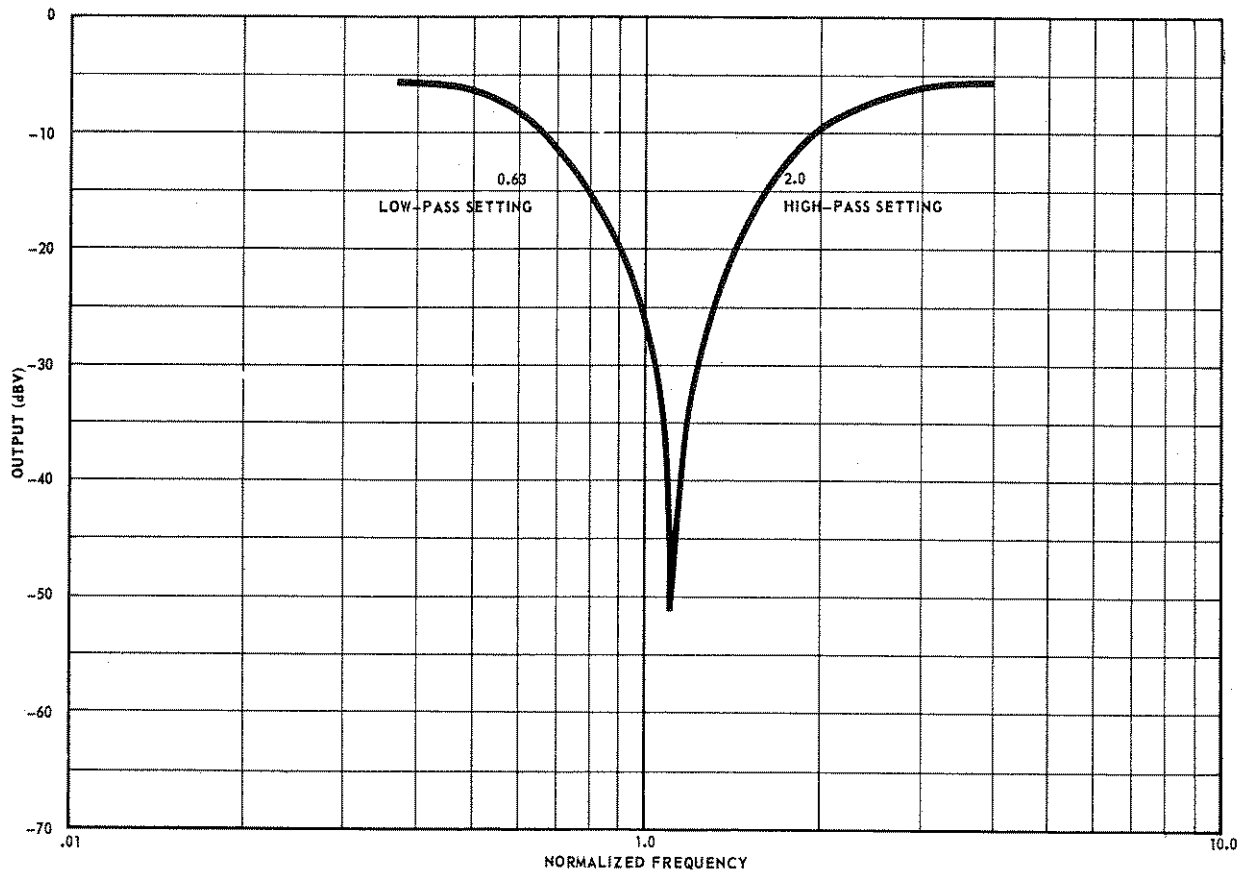

FIGURE 3.6 BAND REJECT SHARP NOTCH NORMALIZED RESPONSE

Figure 3.6 shows the normalized response for the sharp notch that can be centered at 1.12, 1.4, 1.8, 2.25, 2.8, 3.55, 4.5, 5.6, 7.1 and 8.9. This is a special case of the variable width notch discussed above. When the high-pass and low-pass cutoff frequencies are a factor of 1.8 above and below the center frequency, the phase difference between the high-pass and low-pass sections is almost 180° at the center frequency, producing a large cancellation in the output summer. This sharp notch will give in excess of 50 dB attenuation with a

-3 dB bandwidth of $1.2 \times f_c$. For convenience, the bottom line of Table 3.2 lists the settings to produce this sharp notch at the ten available center frequencies.

3.5.3 OPERATION AS A BAND-REJECT FILTER

Set the mode switch to REJECT and using Table 3.1 or 3.2 find the available notch center frequency nearest the desired notch frequency and select the high-pass and low-pass settings giving the desired notch depth and shape. Set these cutoff frequencies using S1 through S4.

IMPORTANT: If the filter has the optional amplifier, its gain **MUST** be set to 0 dB for proper operation in the band-reject mode. The high-pass cutoff setting must be at a higher frequency than the low-pass cutoff setting for proper operation in this mode. The notch depths referred to on Tables 3.1 and 3.2 are referenced to 0 dB; the pass-band gain of the 4210 Series in the band-reject mode is -6 dB.

3.6 OPTIONAL AMPLIFIER OPERATION - OPTION 02

The Amplifier Option provides 0 to 40 dB gain in 10 dB steps. The amplifier is DC coupled and its high frequency response is typically -3 dB at 2.5 MHz. In use, the high frequency response of the unit will be determined by the low-pass filter section setting. The maximum output from the amplifier is 7.0 V rms; when using 10 - 40 dB gain, the input signal level should be reduced to remain within this rating.

IMPORTANT: When operating the filter in the REJECT mode, the amplifier gain **MUST** be set to 0 dB for proper operation.

3.7 BATTERY OPERATION - OPTION 01

3.7.1 BATTERY OPERATION

The battery option provides internal NiCd batteries to allow operation away from the AC power sources. Operation for up to 7 hours is possible. Models containing the Amplifier Option can be operated for 5.5 hours on batteries. (Model 4213 can be operated for 4.5 hours on batteries. With a reduction in the maximum input specification from 7.0 V rms to 3.0 V rms this model can also operate for up to 7 hours, see below.)

3.7.2 BATTERY RECHARGING

When the filter is used on AC power, the batteries receive a trickle charge if the unit is ON or OFF providing the line cord is connected to an AC power source. This trickle charge maintains the batteries at full charge. When the batteries have

been fully or partially discharged, fast charging is possible by placing S9 in the CHARGE position and connecting the line cord to an AC power source. IMPORTANT: The filter is inoperable when S9 is in the CHARGE position. The position of the front panel ON/OFF switch does not matter when S9 is in the CHARGE position. Figure 3.7 shows the necessary charging period vs AC line voltage for fully discharged batteries. For partially discharged batteries, the time period should be reduced, although occasional overcharging will not adversely affect battery performance.

3.7.3 EXTENDED BATTERY OPERATION FOR MODEL 4213

Booster resistors R35 - R42 are added to the circuit of Model 4213 to enable the 310H I.C.'s to drive -10V peak into the impedance levels encountered in this model. These resistors increase the current drain and lower the battery operating period to 4.5 hours. If a longer battery operating period is desired, resistors R35 - R42 may be removed from the circuit. The maximum input signal in this case is 3.0 V rms for the 4213, but the full 7 hour period of battery operation can be achieved.

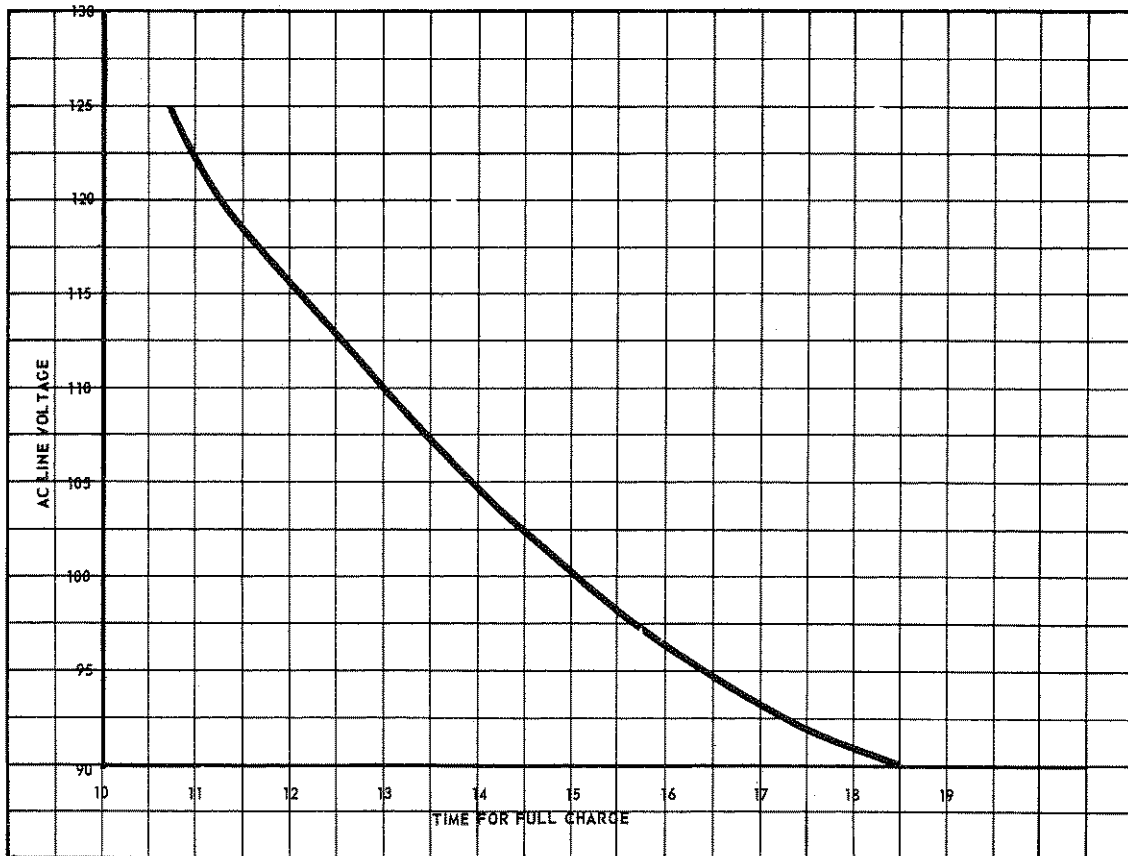

FIGURE 3.7 BATTERY CHARGING PERIOD VS AC LINE VOLTAGE

BAND-REJECT MODE -- CUTOFF FREQUENCY SETTINGS FOR VARIABLE NOTCH

(Bottom Line For Sharp Notch)

CENTER FREQUENCY

NOTCH DEPTH -dB		1.12	1.4	1.8	2.25	2.8	3.55	4.5	5.6	7.1	8.9
18.0	HIGH-PASS	1.6	2.0	2.5	3.15	4.0	5.0	6.3	8.0	10.0	12.5
	LOW-PASS	0.8	1.0	1.25	1.6	2.0	2.5	3.15	4.0	5.0	6.3
	-3 dB WIDTH	0.8	1.0	1.25	1.55	2.0	2.5	3.15	4.0	5.0	6.2
37.0	HIGH-PASS	2.5	3.15	4.0	5.0	6.3	8.0	10.0	12.5	16.0	20.0
	LOW-PASS	0.5	0.63	0.8	1.0	1.25	1.6	2.0	2.5	3.15	4.0
	-3 dB WIDTH	2.0	2.52	3.2	4.0	5.05	6.4	8.0	10.0	12.85	16.0
40.0	HIGH-PASS	3.15	4.0	5.0	6.3	8.0	10.0	12.5	16.0	20.0	25.0
	LOW-PASS	0.4	0.5	0.63	0.8	1.0	1.25	1.6	2.0	2.5	3.15
	-3 dB WIDTH	2.75	3.5	4.37	5.5	7.0	8.75	10.9	14.0	17.5	21.85
46.0	HIGH-PASS	4.0	5.0	6.3	8.0	10.0	12.5	16.0	20.0	25.0	31.5
	LOW-PASS	0.315	0.4	0.5	0.63	0.8	1.0	1.25	1.6	2.0	2.5
	-3 dB WIDTH	3.69	4.6	5.8	7.37	9.2	11.5	14.75	18.4	23.0	29.0
53.0	HIGH-PASS	5.0	6.3	8.0	10.0	12.5	16.0	20.0	25.0	31.5	40.0
	LOW-PASS	0.25	0.315	0.4	0.5	0.63	0.8	1.0	1.25	1.6	2.0
	-3 dB WIDTH	4.75	5.99	7.6	9.5	11.87	15.2	19.0	23.75	29.9	38.0
60.0	HIGH-PASS	6.3	8.0	10.0	12.5	16.0	20.0	25.0	31.5	40.0	50.0
	LOW-PASS	0.2	0.25	0.315	0.4	0.5	0.63	0.8	1.0	1.25	1.6
	-3 dB WIDTH	6.1	7.75	9.69	12.1	15.0	19.37	24.2	30.5	38.75	48.4
67.0	HIGH-PASS	8.0	10.0	12.5	16.0	20.0	25.0	31.5	40.0	50.0	63.0
	LOW-PASS	0.16	0.2	0.25	0.315	0.4	0.5	0.63	0.8	1.0	1.25
	-3 dB WIDTH	7.84	9.8	12.25	15.69	19.6	24.5	30.87	39.2	49.0	61.75
73.0	HIGH-PASS	10.0	12.5	16.0	20.0	25.0	31.5	40.0	50.0	63.0	80.0
	LOW-PASS	0.125	0.16	0.2	0.25	0.315	0.4	0.5	0.63	0.8	1.5
	-3 dB WIDTH	9.88	12.34	15.8	19.75	24.69	31.1	39.5	49.37	62.2	79.0
75.0	HIGH-PASS	12.5	16.0	20.0	25.0	31.5	40.0	50.0	63.0	80.0	100.0
	LOW-PASS	0.1	0.125	0.16	0.2	0.25	0.315	0.4	0.5	0.63	0.8
	-3 dB WIDTH	12.4	15.88	19.84	24.8	31.25	39.69	49.6	62.5	79.37	99.2
51.0	HIGH-PASS	2.0	2.5	3.15	4.0	5.0	6.3	8.0	10.0	12.5	16.0
	LOW-PASS	0.63	0.8	1.0	1.25	1.6	2.0	2.5	3.15	4.0	5.0
	-3 dB WIDTH	1.37	1.7	2.15	2.75	3.4	4.3	5.5	6.85	8.5	11.0

NOTCH CENTER FREQUENCY, $F_0 = \sqrt{F_{HP} \cdot F_{LP}}$

UPPER -3 dB FREQUENCY = F_{HP}

LOWER -3 dB FREQUENCY = F_{LP}

-3 dB BANDWIDTH = $F_{HP} - F_{LP}$

TABLE 3.2

SECTION 4

4.0 THEORY OF OPERATION

4.1 FILTER CIRCUIT

The circuit shown in Figure 4.1 will have a low-pass response characteristic such as that represented in Figure 4.3. The cutoff frequency, (where $R = X_C$) will be at -6 dB on the response curve.

The network will pass all signals below this cutoff frequency with little attenuation. Above the cutoff frequency, the network attenuation will increase with frequency and the rate of attenuation will approach 12 dB/octave. The isolation amplifier prevents the second RC section from loading the preceding RC section. One objection to this network is that the response in the region of the cutoff frequency does not change as rapidly as desired.

The rate of attenuation can be improved by applying positive feedback such as is illustrated in Figure 4.2. The amount of feedback will control the amount of peaking in the vicinity of the cutoff frequency. (see the upper curve of Figure 4.3.) The two networks in Figure 4.1 and 4.2 have similar pass-band and stop-band attenuation, but the transition region around the cutoff frequency can be controlled by positive feedback. When two filter sections similar to those in Figure 4.2 are cascaded, the overall response is that of a four pole low-pass filter. Figure 4.4 shows this configuration. The feedback gains A_1 and A_2 can be set for a maximally flat response producing a four pole Butterworth low-pass filter. The rate of attenuation is 24 dB/octave above the cutoff frequency. At the cutoff frequency the response is -3 dB.

Interchanging the RC elements in the circuit of Figure 4.2 to the configuration shown in Figure 4.5, changes the filter response from a low-pass to high-pass filter with the response illustrated in Figure 4.6. Again the positive feedback causes the response to peak in the vicinity of the cutoff frequency, giving more rapid attenuation below the cutoff frequency. Cascading two sections similar to those of Figure 4.5, produces a four pole Butterworth high-pass filter as shown in Figure 4.7. The feedback gains A_1 and A_2 can be set to give a maximally flat response, thus producing a four pole Butterworth high-pass filter. Figure 4.8 shows the amplitude response for both quadratic sections of the low-pass and high-pass filter sections used in the 4210 Series Filters in the NORMAL mode. The overall response of the low-pass and high-pass filters is the sum of the first and second quadratic responses for each section.

The organization of these sections when the filter is used in the NORMAL or PULSE mode is depicted in Figure 4.9. When the high-pass multiplier switch S2 is in the OUT position, the high-pass filter is bypassed and

the filter response is that of a DC coupled low-pass filter. If the Amplifier Option is used, it is located between the first and second low-pass sections. Figure 4.10 details the filter organization in the BAND-REJECT mode. The low-pass and high-pass sections are operated in parallel and their outputs added.

4.2 AMPLIFIER OPTION - OPTION 02

The optional 0 - 40 dB amplifier employs two cascaded stages each running at a fixed gain of 20 dB. Attenuators are used to switch the gain in 10 dB steps. In the 0 dB position, the amplifier stage is bypassed. The amplifier is DC coupled and the high frequency response is determined by capacitors C6 and C7 and inductors L1 and L2. (Refer to schematic diagram in Section 7.) Figure 4.11 shows the high frequency amplitude response for the amplifier. Capacitors C6 and C7 are factory adjusted to produce the rolloff shown. Since the amplifier is located between the first and second quadratic sections of the low-pass filter, the overall high frequency response will be determined primarily by the filter. Normally the low-pass filter cutoff will be sufficiently lower in frequency to completely determine the high frequency filter response whereas Model 4213 is a possible exception if its low-pass cutoffs are set in the highest decade. Figure 4.12 shows the high frequency phase response of the amplifier stage.

4.3 OFFSET CORRECTION FOR INPUT BIAS CURRENT

An input bias current, which is temperature dependent, flows in the 310 integrated circuits used in the 4210 Series Filters. This current is typically 2nA. In the filter Model 4211 the resistance through which this current flows is as high as 2.251M ohm. This produces a -4.5mV offset voltage at the input of the 310 which is coupled through the low-pass section. Since the input resistance varies with the cutoff setting switches S1 and S3, this offset would vary with the cutoff setting. In filters with the amplifier option, this offset could be as great as 1.3 volts at the output when 40 dB of gain is selected. Figure 4.13 details this situation. The offset adjustments in the filter enable one to zero this offset at one particular setting of S1 and S3, but as resistors B, C, and D of Figure 4.13 are varied, the voltage drop across them will vary and the offset will no longer be zeroed.

An external current source is used on these three stages, AR7, AR8, and AR10 to alleviate this problem. The input bias current is supplied through 1500 M ohm resistors connected to a temperature compensated source. Thus the variations of the frequency setting resistors cause no offset since no current flows in them. (see Figure 4.14) To compensate for the variation of the 310 input bias current with temperature, the temperature compensated source uses a 310 with a 1500 M ohm resistor in its input to generate a voltage of $i_b \times 1500$ M ohm. Thus this voltage has the same temperature variation as the 310 input bias current. This voltage is amplified and inverted and supplied to the 1500 M ohm resistors at the input of AR7, AR8, and AR10. (See schematic in Section 7.0)

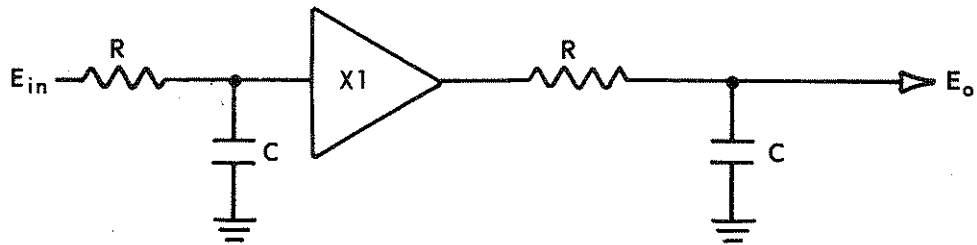

FIGURE 4.1 TWO ISOLATED RC SECTIONS OF A LOW-PASS FILTER SECTION

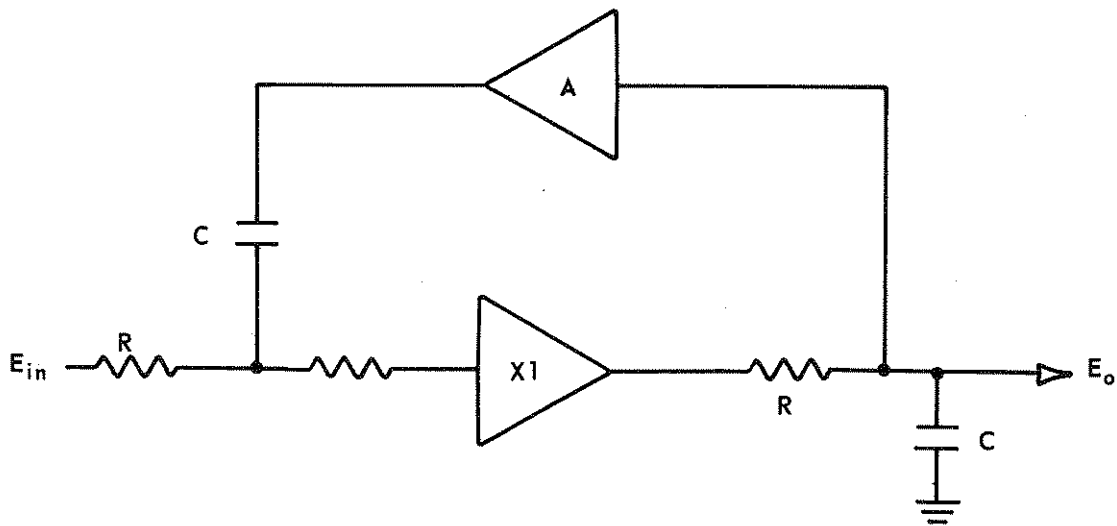

FIGURE 4.2 TWO ISOLATED RC SECTIONS OF A LOW-PASS FILTER SECTION WITH POSITIVE FEEDBACK

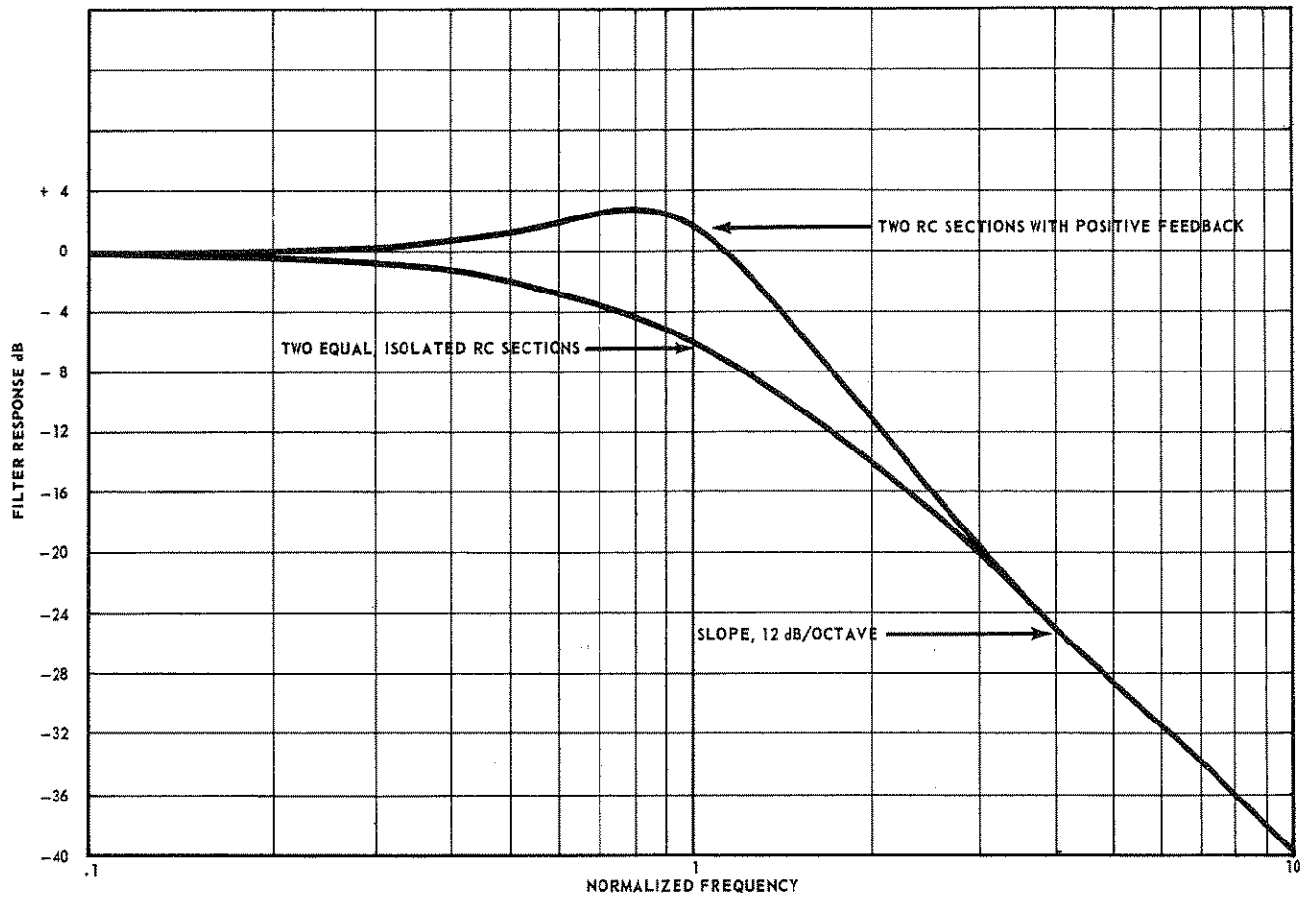

FIGURE 4.3 RESPONSE CURVE FOR TWO POLE LOW-PASS FILTER SECTION

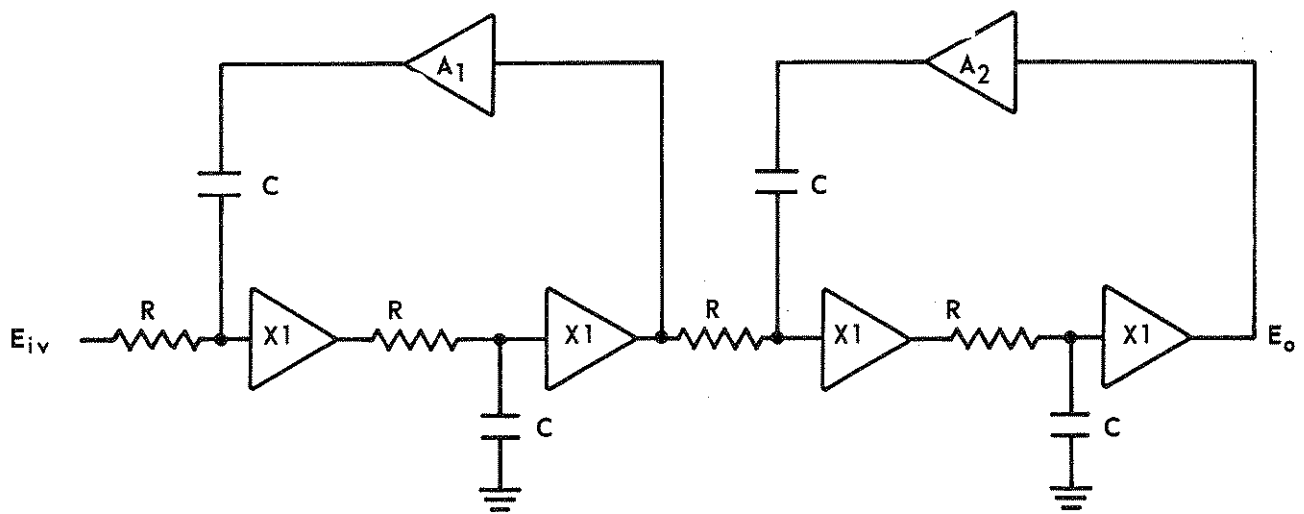

FIGURE 4.4 TWO QUADRATIC SECTIONS CASCADED TO FORM A FOUR POLE LOW-PASS FILTER

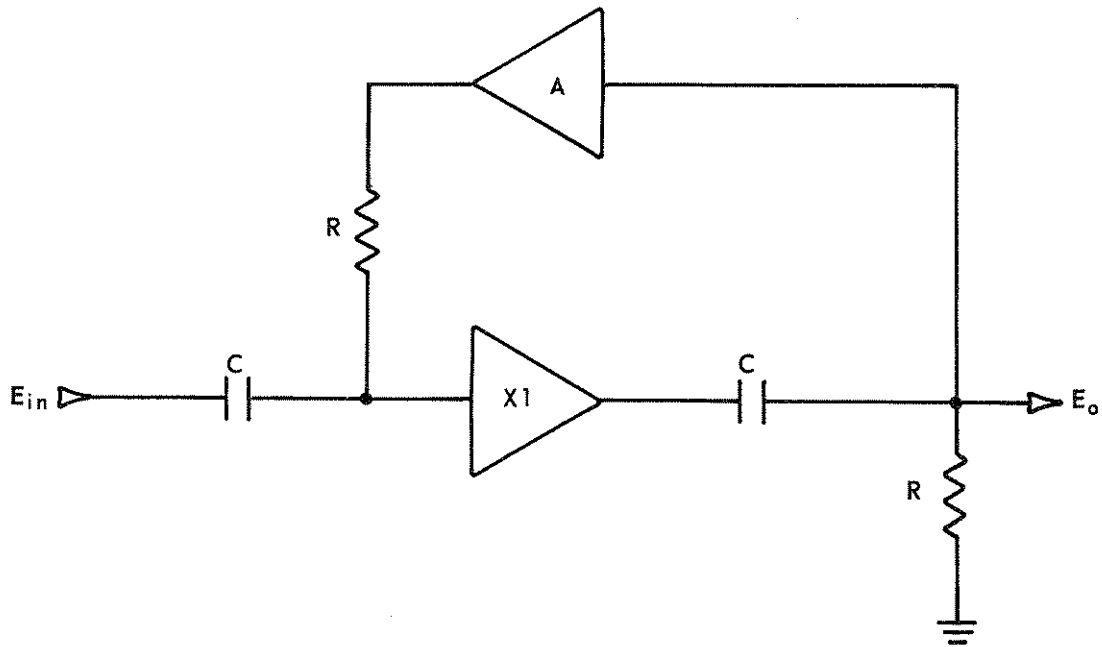

FIGURE 4.5 TWO ISOLATED RC SECTIONS OF A HIGH-PASS SECTION WITH POSITIVE FEEDBACK

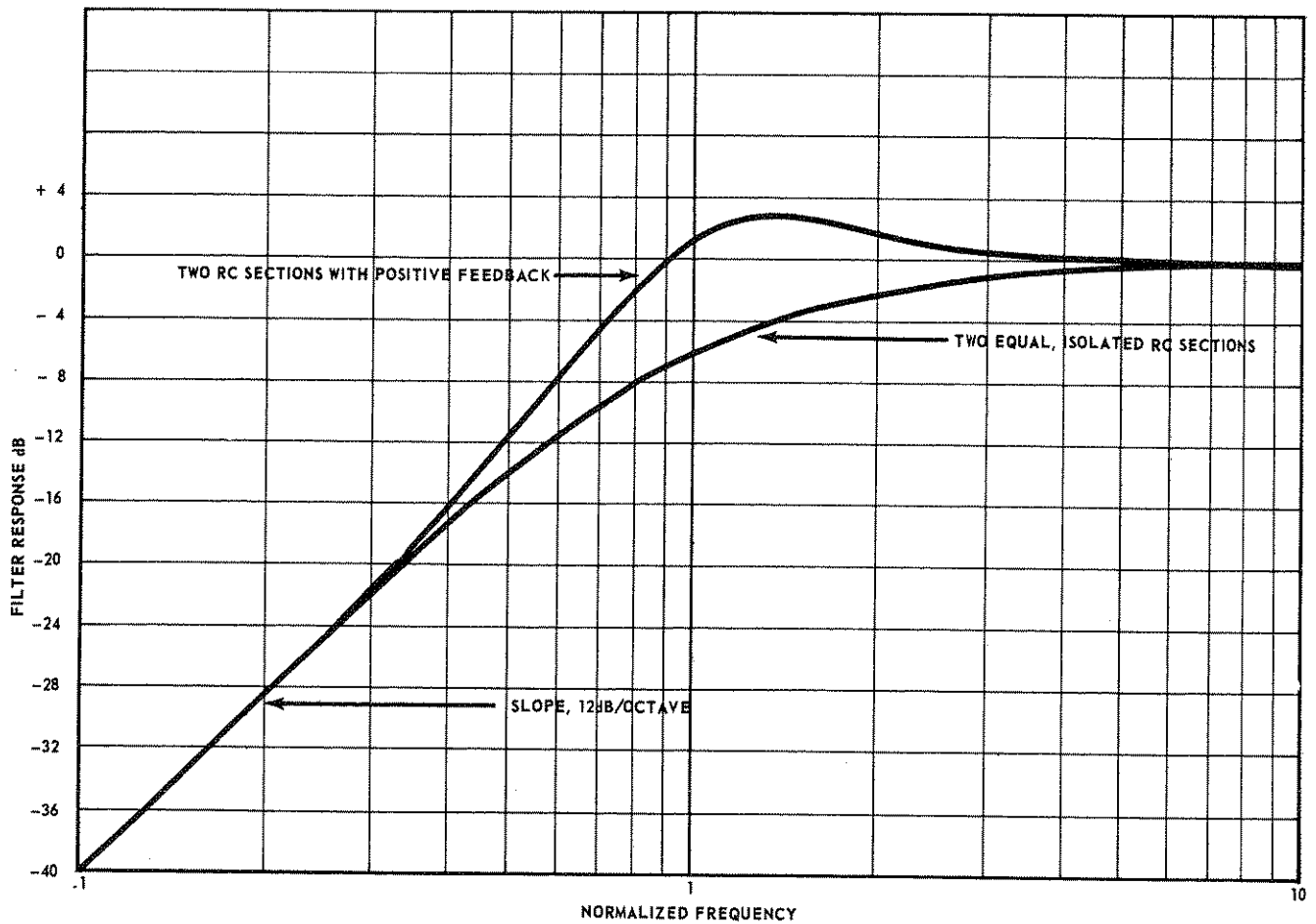

FIGURE 4.6 RESPONSE CURVE FOR TWO POLE, HIGH-PASS SECTION

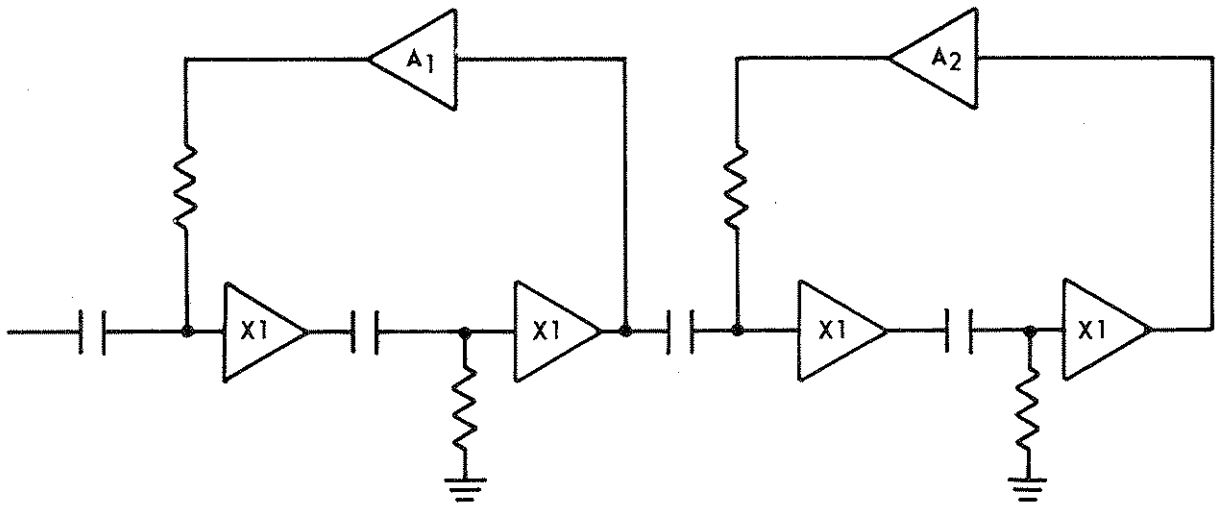

FIGURE 4.7 TWO QUADRATIC SECTIONS CASCADED TO FORM A FOUR POLE HIGH-PASS FILTER

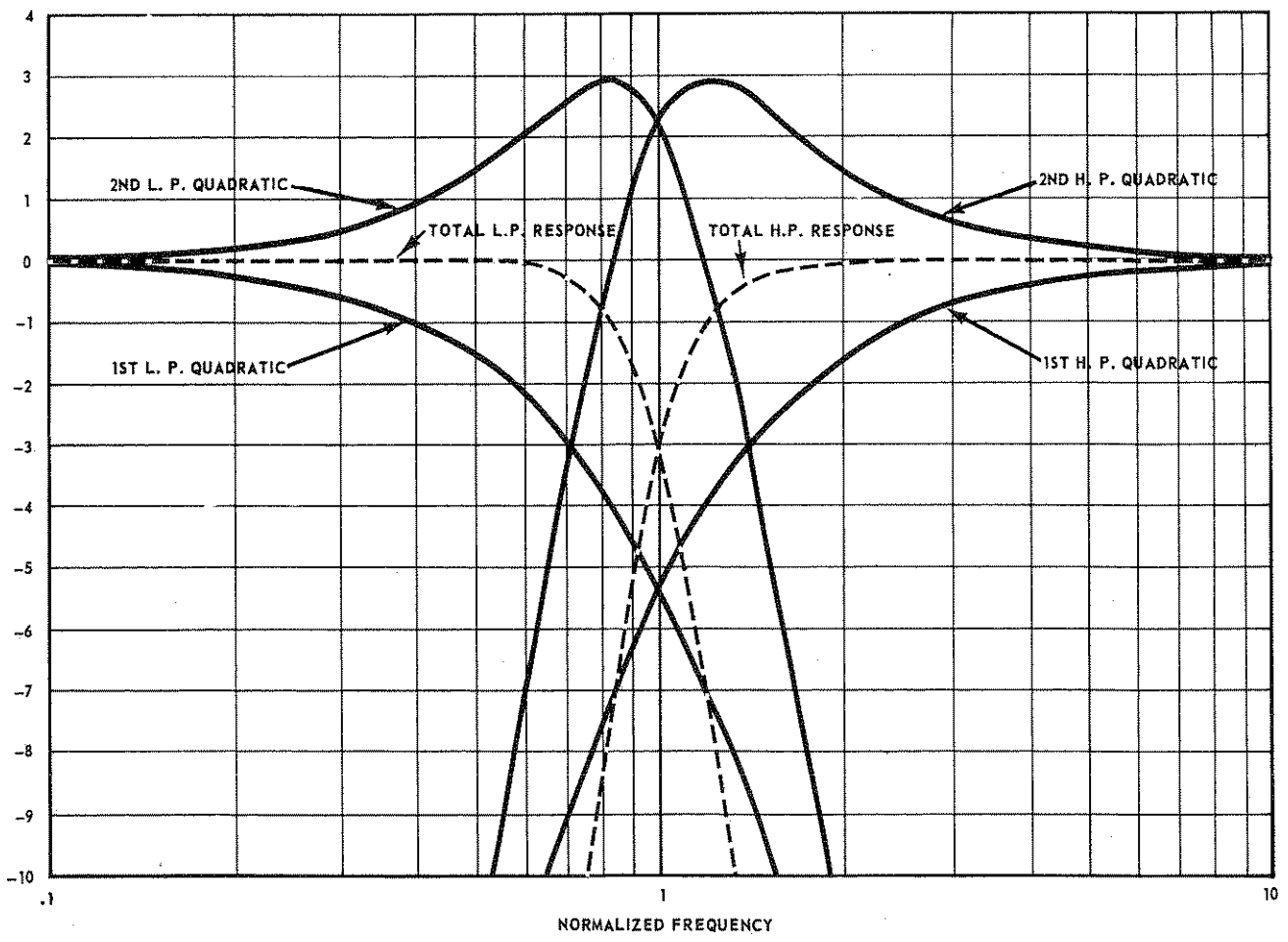

FIGURE 4.8 1ST AND 2ND QUADRATIC AMPLITUDE RESPONSE - NORMAL MODE

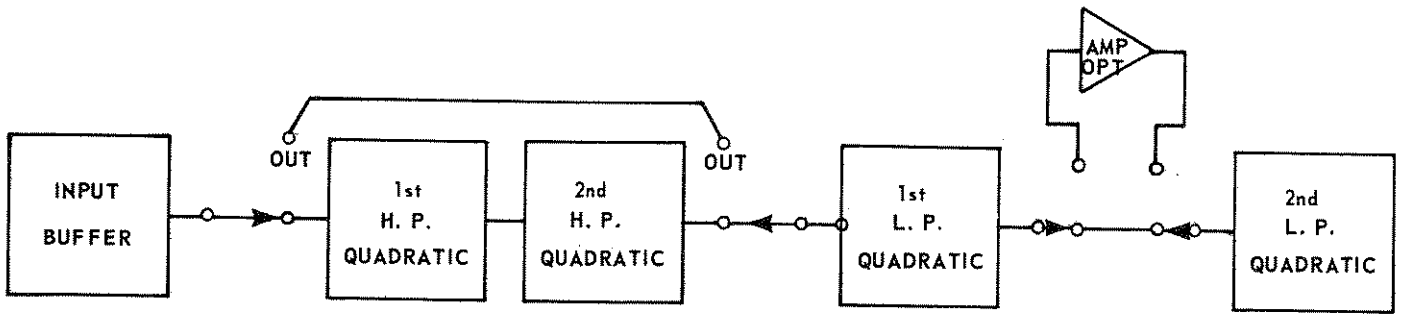

FIGURE 4.9 ORGANIZATION OF THE 4210 SERIES VARIABLE ELECTRONIC FILTER IN THE NORMAL OR PULSE MODE

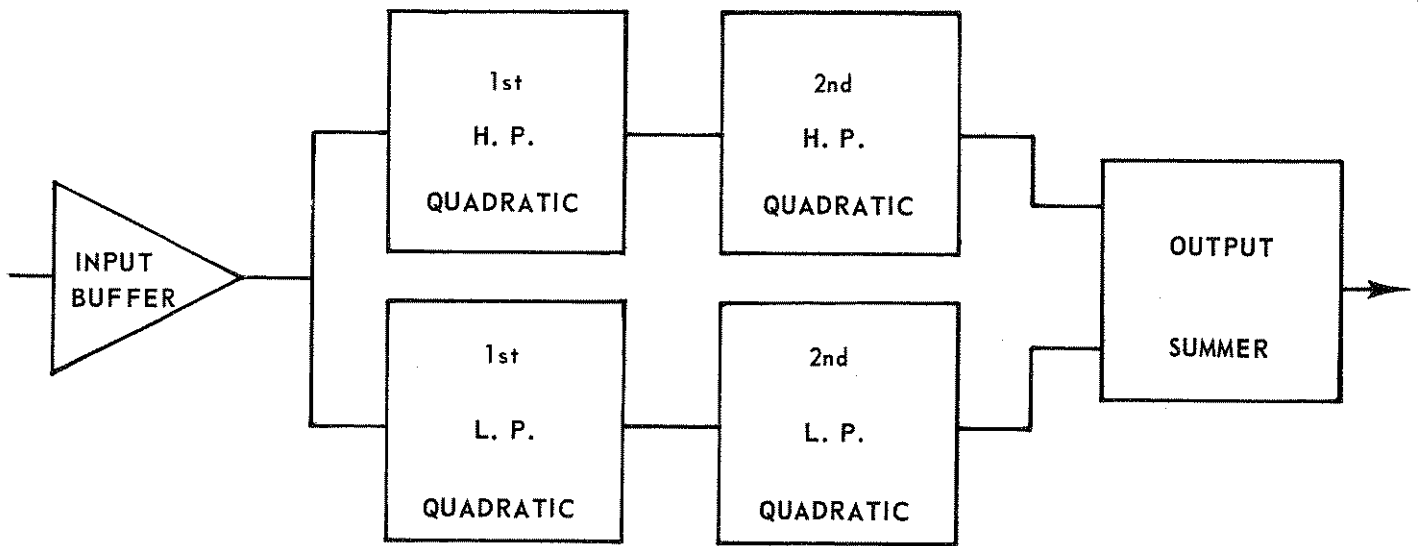

FIGURE 4.10 ORGANIZATION OF THE 4210 SERIES VARIABLE ELECTRONIC FILTER IN THE BAND-REJECT MODE

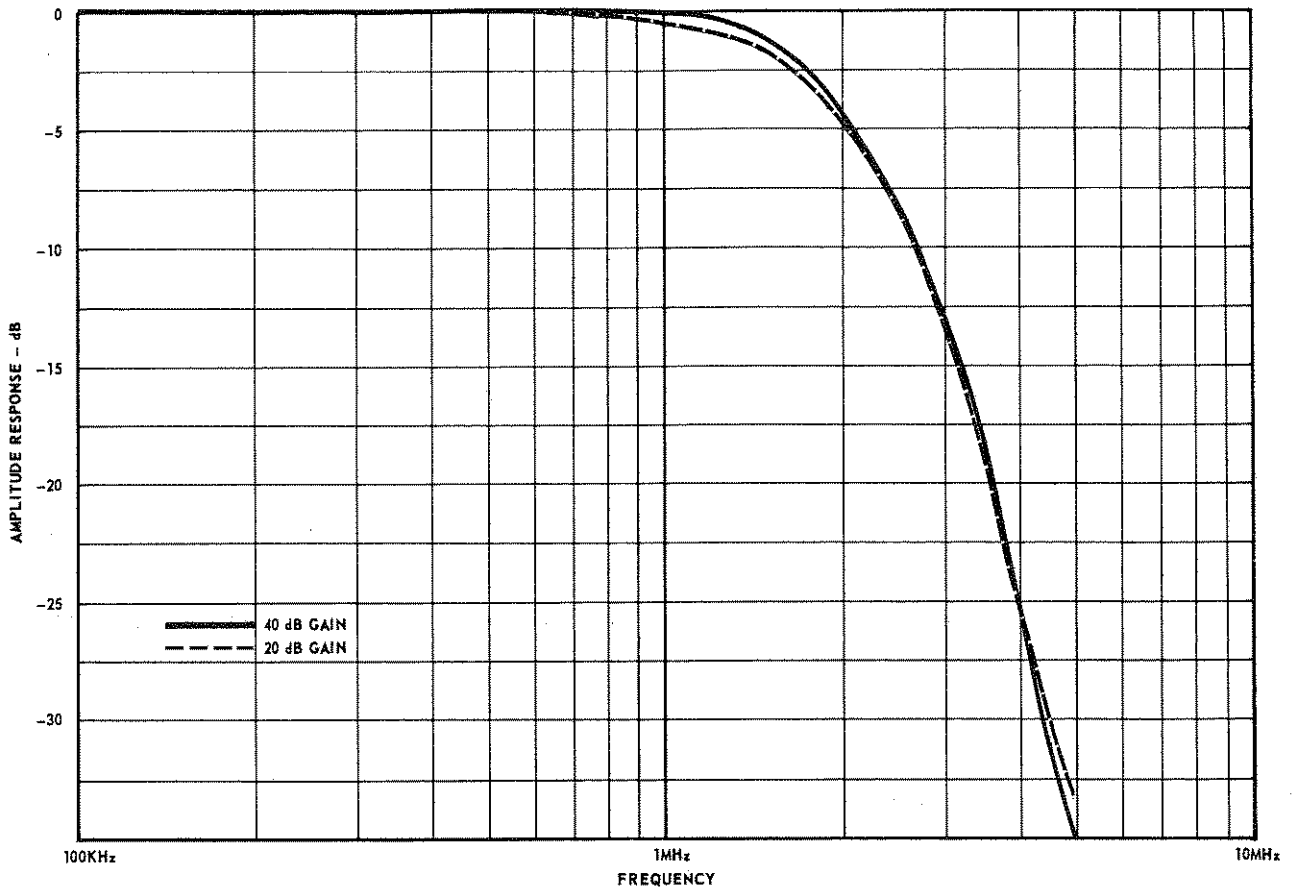

FIGURE 4.11 HIGH FREQUENCY AMPLITUDE RESPONSE FOR AMPLIFIER

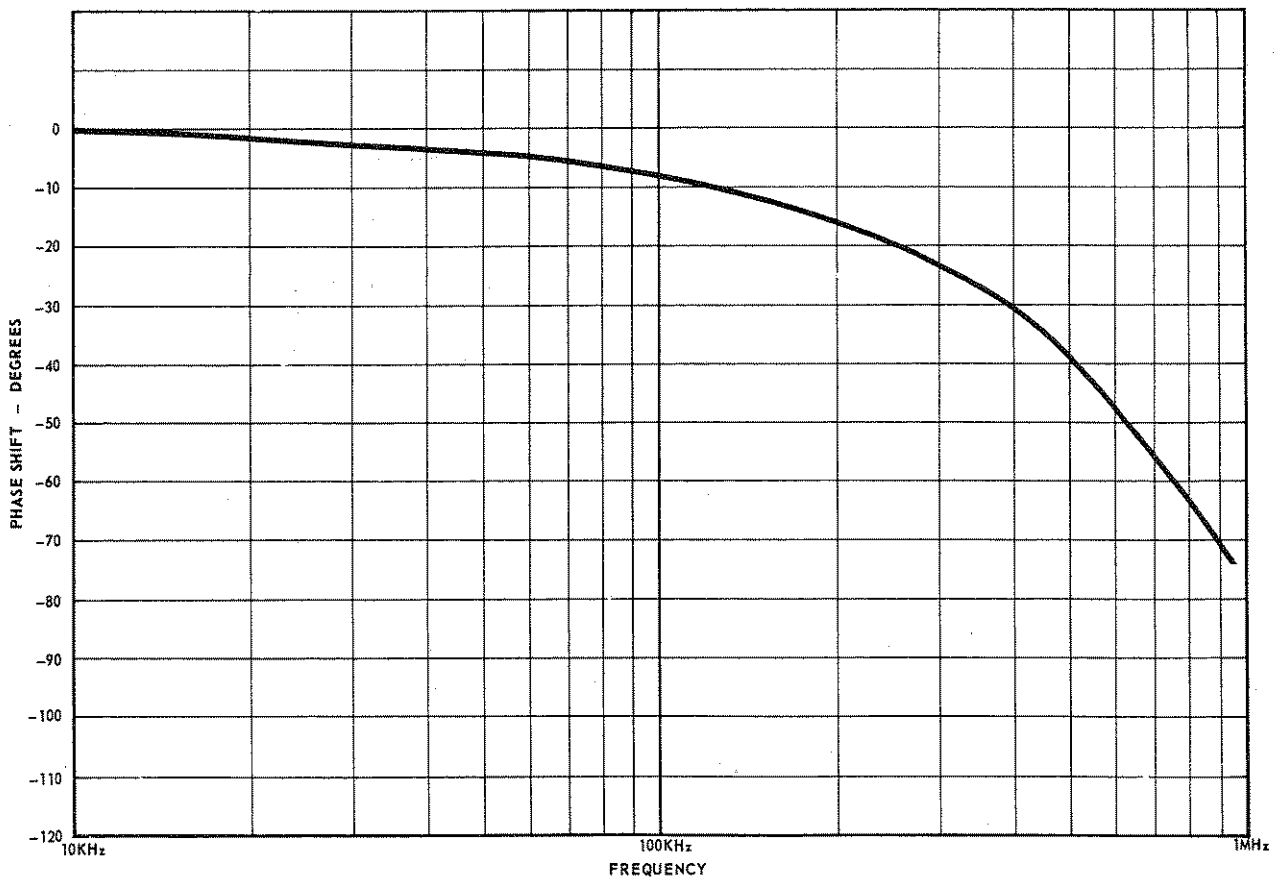

FIGURE 4.12 HIGH FREQUENCY PHASE RESPONSE FOR AMPLIFIER

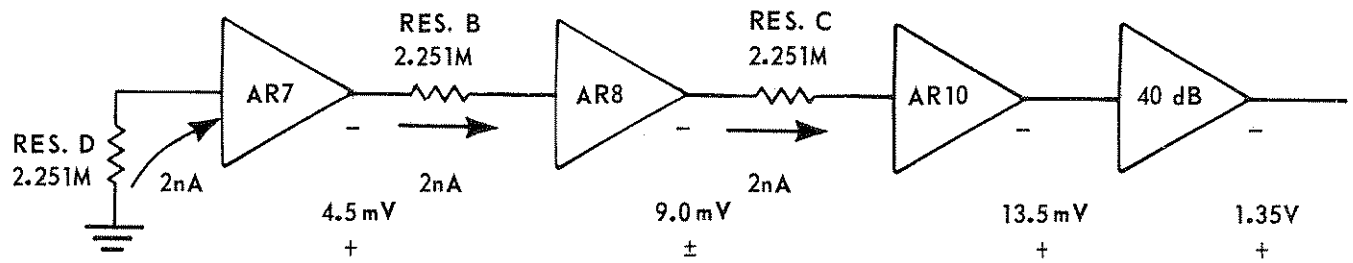

FIGURE 4.13 DC OFFSET VOLTAGE RESULTING FROM INPUT BIAS CURRENT

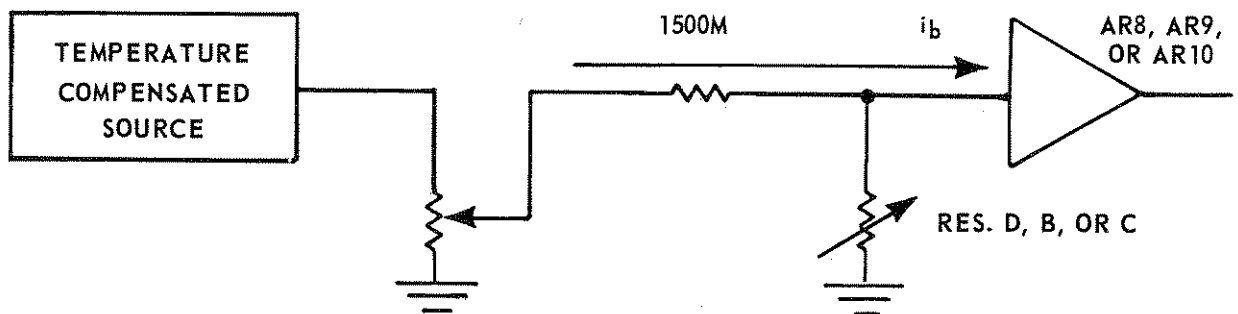

FIGURE 4.14 CURRENT SOURCE TO SUPPLY INPUT BIAS CURRENT FOR AR8, AR9, AND AR10

1
2
3
4
5
6
7
8
9
10
11
12
13
14
15
16
17
18
19
20
21
22
23
24
25
26
27
28
29
30
31
32
33
34
35
36
37
38
39
40
41
42
43
44
45
46
47
48
49
50
51
52
53
54
55
56
57
58
59
60
61
62
63
64
65
66
67
68
69
70
71
72
73
74
75
76
77
78
79
80
81
82
83
84
85
86
87
88
89
90
91
92
93
94
95
96
97
98
99
100

SECTION 5

RECOMMENDED TEST PROCEDURE

4210 SERIES VARIABLE ELECTRONIC FILTERS

1.0 OBJECTIVE

This recommended test procedure's objective is to make necessary adjustments and to test filter performance.

2.0 EQUIPMENT RECOMMENDED

- 2.1 Frequency Counter - HP 5326C
- 2.2 Digital Voltmeter - Dana 5230
- 2.3 Oscillator - HP 209A
- 2.4 600 ohm attenuator - GR1450TA, and termination resistor, 600 ohm 1%
- 2.5 RMS Meter - Ballantine 320A
- 2.6 ITHACO Model 451 Postamplifier
- 2.7 ITHACO Model 4113 Filter
- 2.8 Oscilloscope
- 2.9 Distortion Analyzer - HP 331A
- 2.10 Switch Box - J89 (Shielded single pole double throw switch for comparing two signals)
- 2.11 Ohmmeter, Simpson 260 or Weston Multimeter

3.0 PRELIMINARY CHECKS

- 3.1 Set back panel switches as follows:

CHG/AC/BATT - To AC

115/230 - To 115

CKT GND Switch - Circuit ground to power ground off.

Check with an ohmmeter for a short between the line cord ground pin and a case screw. Check for an open circuit from the input BNC shell to the AC line ground.

CKT GND Switch - Circuit ground to power ground on.

Check for short from input BNC shell to AC line ground.

CKT GND Switch - Circuit ground to power ground off.

3.2 Set front panel switches as follows:

S5 to off
Gain switch (if so equipped) to 0dB
S6 to normal

3.3 Plug unit in and turn it on.

3.4 Verify following DC voltages: (use low-pass multiplier switch S4 shield as reference)

Filter Board E	+14.25V ± .25V
Filter Board G	-14.25V ± .25V
Pin 4 of XLR connector	+14.25V ± .25V
Pin 2 of XLR connector	-14.25V ± .25V

3.5 If supplied with battery option, switch CHG/AC/BATT (rear panel) to BATT and verify pin E and pin G voltages as in 3.4. Return to AC position of S9.

3.6 Power Supply and Battery Charger Checks (POWER ON)

- 1) Measure DC voltage at C2 positive end (approx. +27V). Switch 115/230 volt switch (rear panel) to 230V. Voltage should drop to half its original value. Return 115/230 switch to 115V. (Multimeter is OK for this section).
- 2) Float DC voltmeter signal return terminal for following test by disconnecting shorting link or interrupting the AC third wire lead. Disconnect both batteries. Connect voltmeter across one set of battery terminals on the PC board. Read voltage under the following conditions:

Power switch off, CHG/AC/BATT switch set to AC.
Read approximately 33 volts.

Power switch off, CHG/AC/BATT switch set to CHARGE.
Read twice first voltage.

Power switch off, CHG/AC/BATT switch set to BATT.
Read approximately the first voltage.

Power switch ON, CHG/AC/BATT switch set to BATT.
Read approximately 3 volts.

Return CHG/AC/BATT to AC.

- 3) Repeat 2 above with voltmeter connected across second set of battery terminals.

4.0 MAXIMUM INPUT LEVEL (SET-UP #1)

- 4.1 Set attenuator to 0dB and remove the 600Ω termination.
4.2 If filter has amplifier option, switch it to 0dB gain.
4.3 Place 5kΩ load on output.
4.4 Set High Pass and Low Pass sections according to the table below:

<u>MODEL</u>	<u>HIGH PASS</u>		<u>LOW PASS</u>		<u>FREQUENCY</u>
	<u>SETTING</u>	<u>MULTI.</u>	<u>SETTING</u>	<u>MULTI.</u>	<u>Hz</u>
4211	10	10	10	10 ³	7k
4212	10	10	10	10 ⁴	70k
4213	10	10	10	10 ⁵	100k
4213	10	10	10	10 ²	1k*

- 4.5 Verify that an input signal level of 7.0V RMS at the frequency in the table produces an output free of noticeable distortion.

*For this test only the output should be approximately 3dB down with no visible clipping or distortion.

5.0 DISTORTION (SET-UP #1)

- 5.1 Put 5kΩ load on filter output.
5.2 Adjust oscillator for 7.0V RMS at 1kHz.
5.3 Set High Pass to 1.0 x OUT.
Set Low Pass to 10 x 10³.
5.4 Distortion should be less than 0.2%.

6.0 OFFSET ADJUSTMENTS (Setup #1)

6.1 Input Offset Current

Adjustments for 4211 and all units with Amplifier Option 02. (These units contain the current source card mounted on the rear of the low-pass multiplier switch, S4.)

6.1.1 With DVM, measure the voltage at pin 6 of AR2 on the current source card. It should be less than +12.0 volts. If it is less than +3.0 volts, remove both R2 and R3 to increase the gain of AR2. If the voltage at AR2 pin 6 is greater than +3 volts but less than +7 volts, remove R2 from the circuit board. The voltage should now be between +6 and +10 volts.

6.2 Filter Offset

- 6.2.1 Set high pass to 10X highest range (not out) and low pass to 10×10^2 . Set to normal mode and 40 dB gain if filter has Option 02. Place a shorting cap on input.
- 6.2.2 Short pad 40 (white/red wire on S4) to ground and adjust R26 for 0 VDC at output BNC.
- 6.2.3 Remove short from pad 40 and adjust R32 for 0 VDC at output. Leave gain at 40 dB until otherwise specified.
- 6.2.4 Rotate S1 from 10 to 1 and adjust R6 on the current source card (pot closest to rail) so that the offset at the output BNC doesn't change from one setting to the other.
- 6.2.5 Short pad 50 (white/black wire on S4) to ground and adjust R8 on the current source card (pot furthest from the rail) so that there is no change in the offset at the output BNC when S3 is changed from 10 to 1.
- 6.2.6 Remove the short from pad 50 and adjust R7 on the current source card for no change in offset when S3 is changed from 10 to 1.
- 6.2.7 Readjust R32 for 0 VDC at output BNC.
- 6.2.8 Set high pass switch S2 to out position and adjust R13 for 0 VDC at output BNC.
- 6.2.9 Check all positions of S1 and S3 to make sure offset doesn't change more than 2 mV.
- 6.2.10 Switch gain from 40 dB to 0 dB. Offset should not change more than 10 mV. If it does, the amplifier offset pots need to be readjusted.

6.3 Amplifier Offset

6.3.1 If the amplifier pots need to be readjusted, proceed as follows:

short input BNC, set high pass to 10X highest range, set low pass to 10×10^2 , short output of AR10 to ground, switch to 40 dB gain.

6.3.2 Adjust R1 of amplifier card for 0.000V on output BNC.

6.3.3 Switch to 20 dB gain and adjust R10 for 0.000V on output BNC.

6.3.4 Repeat steps 6.3.2 and 6.3.3 until both positions are 0.000V.

6.3.5 Remove short from AR10 and switch to 40 dB gain. Readjust R32 for 0.000V on output BNC.

6.4 Input Buffer Offset Current Check (All 4200 Filters)

6.4.1 Short filter input with shorting cap.

6.4.2 Set filter gain to 0 dB if so equipped.

6.4.3 Set filter to high pass out, low pass 10×10^3 .

6.4.4 Read shorted input offset. Remove shorting cap from input. Allow instrument to settle. Read DC voltage at output. Offset should not increase more than 5 mV due to Q1 input current.

7.0 FILTER GAIN CHECK (SET-UP #1)

- 7.1 Return 600Ω termination to attenuator and set attenuator to 0dB.
- 7.2 Set mode switch to NORMAL.
- 7.3 Set filter gain switch to 0dB if filter has amplifier option.
- 7.4 Set oscillator output to approximately 1.0V RMS.
- 7.5 Follow settings below and measure filter gain by comparing input and output.

MODEL	HIGH PASS		LOW PASS		FREQ. Hz	GAIN PASS LIMIT dB
	SETTING	MULT.	SETTING	MULT.		
4211	1.0	10 ²	10	10 ³	1k	0 ± 0.1
4212	1.0	10 ³	10	10 ⁴	10k	0 ± 0.1
4213	1.0	10 ⁴	10	10 ⁵	100k	0 ± 0.1

8.0 AMPLIFIER OPTION GAIN CHECK (SET-UP #1)

- 8.1 Set High Pass to 10 x OUT.
- 8.2 Set Low Pass to 10 x 10³.
- 8.3 Set oscillator to 1.0V RMS at 1kHz.
- 8.4 Follow settings below and measure amplifier gain.

ATTENUATION dB	FILTER GAIN dB	FILTER GAIN ERROR dB	GAIN ERROR PASS LIMIT dB
0	0	_____	±0.1
10	10	_____	±0.1
20	20	_____	±0.1
30	30	_____	±0.1
40	40	_____	±0.1

9.0 LOW PASS MULTIPLIER ACCURACY (SET-UP #2)

When testing the range multiplier of the Models 4211, and 4212, 2.25k \pm 0.1% resistors are shorted across resistors B, C, D and E on the low pass setting switch, S3 to increase the cut-off frequency so that it can be measured accurately. Tests requiring these resistors are indicated by an asterisk () next to the setting.

9.1 Set attenuator to 3dB.

MODEL 4211 - Resistors B, C, D, E on the low pass setting switch are at 11 o'clock when viewed from the front and are 900.3k ohms.

HIGH PASS		LOW PASS		FREQUENCY-Hz (Period-Millisecond)		
<u>SETTING</u>	<u>MULTI.</u>	<u>SETTING</u>	<u>MULTI.</u>	<u>NOMINAL</u>	<u>PASS LIMIT</u>	<u>MEASURED</u>
10	OUT	2.5*	.01	(100)	(99-101)	_____
10	OUT	2.5*	.1	(10)	(9.9-10.1)	_____
10	OUT	10.0	1.0	(100)	(99-101)	_____
10	OUT	10.0	10.0	(10)	(9.9-10.1)	_____
10	OUT	10.0	10.0 ²	1000	990-1010	_____
10	OUT	1.0	10.0 ³	1000	950-1050	_____

MODEL 4212 - Resistors B, C, D, E on the low pass setting switch are at 11 o'clock when viewed from the front and are 90.03k ohms.

HIGH PASS		LOW PASS		FREQUENCY-Hz (Period-Millisecond)		
<u>SETTING</u>	<u>MULTI.</u>	<u>SETTING</u>	<u>MULTI.</u>	<u>NOMINAL</u>	<u>PASS LIMIT</u>	<u>MEASURED</u>
10	OUT	2.5*	0.1	(98)	(97-99)	_____
10	OUT	2.5*	1.0	(9.8)	(9.7-9.9)	_____
10	OUT	10.0	10.0	(10)	(9.9-10.1)	_____
10	OUT	10.0	10.0 ²	1000	990-1010	_____
10	OUT	1.0	10.0 ³	1000	990-1010	_____
10	OUT	1.0	10.0 ⁴	10k	9.5k-10.5k	_____

MODEL 4213

HIGH PASS		LOW PASS		FREQUENCY-Hz (Period-Millisecond)		
<u>SETTING</u>	<u>MULTI.</u>	<u>SETTING</u>	<u>MULTI.</u>	<u>NOMINAL</u>	<u>PASS LIMIT</u>	<u>MEASURED</u>
10	OUT	10.0	1.0	(100)	(99-101)	_____
10	OUT	10.0	10.0	(10)	(9.9-10.1)	_____
10	OUT	10.0	10.0 ²	1000	990-1010	_____
10	OUT	1.0	10.0 ³	1000	990-1010	_____
10	OUT	1.0	10.0 ⁴	10k	9.9k-10.1k	_____
10	OUT	1.0	10.0 ⁵	100k	95k-105k	_____

10.0 HIGH PASS MULTIPLIER ACCURACY (SET-UP #2)

When testing the range multiplier accuracy of the Models 4211 and 4212, 2.251K ± 0.1% resistors are shorted across resistors A, B, C, and D on the high pass setting switch, S1, to increase the cutoff frequency so that it can be measured accurately with a counter. Tests requiring these resistors are indicated by an asterick () next to the setting.

MODEL 4211 - Resistors A, B, C, D on the high pass setting switch are at 11 o'clock when viewed from the front and are 900.3K ohms.

HIGH PASS		LOW PASS		FREQUENCY-Hz (Period-Millisecond)		
<u>Setting</u>	<u>Multi.</u>	<u>Setting</u>	<u>Multi.</u>	<u>Nominal</u>	<u>Pass Limit</u>	<u>Measured</u>
2.5*	.01	10	10 ³	(100)	(99-101)	_____
2.5*	0.1	10	10 ³	(10)	(9.9-10.1)	_____
10	1.0	10	10 ³	(100)	(99-101)	_____
10	10 ₂	10	10 ³	(10)	(9.9-10.1)	_____
10	10 ²	10	10 ³	1000	990-1010	_____

MODEL 4212 - Resistors A, B, C, D on the high pass setting switch are at 11 o'clock when viewed from the front and are 90.03K ohms.

HIGH PASS		LOW PASS		FREQUENCY-Hz (Period-Millisecond)		
<u>Setting</u>	<u>Multi.</u>	<u>Setting</u>	<u>Multi.</u>	<u>Nominal</u>	<u>Pass Limit</u>	<u>Measured</u>
2.5*	0.1	10	10 ⁴	(98)	(97-99)	_____
2.5*	1.0	10	10 ⁴	(9.8)	(9.7-9.9)	_____
10	10 ₂	10	10 ⁴	(10)	(9.9-10.1)	_____
10	10 ²	10	10 ⁴	1000	990-1010	_____
1.0	10 ³	10	10 ⁴	1000	990-1010	_____

MODEL 4213

HIGH PASS		LOW PASS		FREQUENCY-Hz (Period-Millisecond)		
<u>Setting</u>	<u>Multi.</u>	<u>Setting</u>	<u>Multi.</u>	<u>Nominal</u>	<u>Pass Limit</u>	<u>Measured</u>
10	1.0	10	10 ⁵	(100)	(99-101)	_____
10	10 ₂	10	10 ⁵	(10)	(9.9-10.1)	_____
10	10 ²	10	10 ⁵	1000	990-1010	_____
1.0	10 ³	10	10 ⁵	1000	990-1010	_____
1.0	10 ⁴	10	10 ⁵	10K	9.9K-10.1K	_____

11.0 FREQUENCY SETTING ACCURACY (SET-UP #2)

Note: To remove the range multiplier error while checking the frequency setting:

- 11.1 Set the oscillator frequency to 1000 Hz \pm 1Hz (100 Hz \pm 0.1 Hz) for the 4211 and record the attenuation to within \pm 0.02dB.
- 11.2 All subsequent readings of frequency will be taken at the same output attenuation recorded in step 11.1.

MODEL 4211 - Low Pass Setting Test (Measure Period)

HIGH PASS		LOW PASS		PASS LIMIT	Note Att: _____
SETTING	MULT.	SETTING	MULT.	(PERIOD-MILLISEC)	
10	OUT	1.0	10 ²	(10 \pm 0.01)	
10	OUT	1.25	10 ²	(7.962-8.039)	
10	OUT	1.6	10 ²	(6.219-6.281)	
10	OUT	2.0	10 ²	(4.975-5.025)	
10	OUT	2.5	10 ²	(3.979-4.019)	
10	OUT	3.15	10 ²	(3.159-3.191)	
10	OUT	4.0	10 ²	(2.488-2.513)	
10	OUT	5.0	10 ²	(1.990-2.010)	
10	OUT	6.3	10 ²	(1.579-1.595)	
10	OUT	8.0	10 ²	(1.244-1.256)	
10	OUT	10.0	10 ²	(0.995-1.005)	

MODELS 4212, 4213 - Low Pass Setting Test

HIGH PASS		LOW PASS		PASS LIMIT	Note Att: _____
SETTING	MULT.	SETTING	MULT.	FREQUENCY - Hz	
10	OUT	1.0	10 ³	1000 \pm 1	
10	OUT	1.25	10 ³	1244-1256	
10	OUT	1.6	10 ³	1592-1608	
10	OUT	2.0	10 ³	1990-2010	
10	OUT	2.5	10 ³	2488-2513	
10	OUT	3.15	10 ³	3134-3166	
10	OUT	4.0	10 ³	3980-4020	
10	OUT	5.0	10 ³	4975-5025	
10	OUT	6.3	10 ³	6269-6332	
10	OUT	8.0	10 ³	7960-8040	
10	OUT	10.0	10 ³	9950-10050	

MODELS 4211 - High Pass Setting Test (Measure Period)

HIGH PASS		LOW PASS		PASS LIMIT	Note Att: _____
<u>SETTING</u>	<u>MULT.</u>	<u>SETTING</u>	<u>MULT.</u>	<u>(PERIOD-MILLISEC)</u>	
1.0	10 ²	10	10 ³	(10.0 ± 0.01)	
1.25	10 ²	10	10 ³	(7.962-8.039)	
1.6	10 ²	10	10 ³	(6.219-6.281)	
2.0	10 ²	10	10 ³	(4.975-5.025)	
2.5	10 ²	10	10 ³	(3.979-4.019)	
3.15	10 ²	10	10 ³	(3.159-3.191)	
4.0	10 ²	10	10 ³	(2.488-2.513)	
5.0	10 ²	10	10 ³	(1.990-2.010)	
6.3	10 ²	10	10 ³	(1.579-1.595)	
8.0	10 ²	10	10 ³	(1.244-1.256)	
10.0	10 ²	10	10 ³	(0.995-1.005)	

MODELS 4212, 4213 - High Pass Setting Test

HIGH PASS		LOW PASS		PASS LIMIT	Note Att: _____
<u>SETTING</u>	<u>MULT.</u>	<u>SETTING</u>	<u>MULT.</u>	<u>FREQUENCY - Hz.</u>	
1.0	10 ³	10	10 ⁴	1000 ± 1	
1.25	10 ³	10	10 ⁴	1244 - 1256	
1.6	10 ³	10	10 ⁴	1592 - 1608	
2.0	10 ³	10	10 ⁴	1990 - 2010	
2.5	10 ³	10	10 ⁴	2488 - 2513	
3.15	10 ³	10	10 ⁴	3134 - 3166	
4.0	10 ³	10	10 ⁴	3980 - 4020	
5.0	10 ³	10	10 ⁴	4975 - 5025	
6.3	10 ³	10	10 ⁴	6269 - 6332	
8.0	10 ³	10	10 ⁴	7960 - 8040	
10.0	10 ³	10	10 ⁴	9950 - 10050	

12.0 PULSE MODE ACCURACY (SET-UP #2)

- 12.1 Set attenuator to 8dB.
- 12.2 Set mode switch to PULSE.
- 12.3 Set High Pass to 10 x OUT.
- 12.4 Set oscillator to 1000 Hz \pm 1.0 Hz (100 Hz \pm 0.1 Hz for 4211) and record the output attenuation to within \pm 0.02dB.
- 12.5 All subsequent readings of frequency will be taken at the same output attenuation recorded in step 12.4.

MODEL 4211 - Measure Period

LOW PASS		PASS LIMIT	
<u>SETTING</u>	<u>MULT.</u>	<u>(PERIOD-MILLISEC)</u>	
1.0	10^2	(10.0 \pm 0.01)	Note Att: _____
1.25	10^2	(7.962-8.039)	
1.6	10^2	(6.219-6.281)	
2.0	10^2	(4.975-5.025)	
2.5	10^2	(3.979-4.019)	
3.15	10^2	(3.159-3.191)	
4.0	10^2	(2.488-2.513)	
5.0	10^2	(1.990-2.010)	
6.3	10^2	(1.579-1.595)	
8.0	10^2	(1.244-1.256)	
10.0	10^2	(0.995-1.005)	

MODELS 4212, 4213,

LOW PASS		PASS LIMIT	
<u>SETTING</u>	<u>MULT.</u>	<u>FREQUENCY - Hz</u>	
1.0	10^3	1000 \pm 1.0	Note Att: _____
1.25	10^3	1244-1256	
1.6	10^3	1592-1608	
2.0	10^3	1990-2010	
2.5	10^3	2488-2513	
3.15	10^3	3134-3166	
4.0	10^3	3980-4020	
5.0	10^3	4975-5025	
6.3	10^3	6269-6332	
8.0	10^3	7960-8040	
10.0	10^3	9950-10050	

13.0 BAND REJECT MODE TEST (SET-UP #2)

13.1 Set filter mode switch to REJECT.

13.2 Set oscillator for 1V RMS.

13.3 Set attenuator for 50dB.

13.4 Set oscillator and switch settings as in table below and verify rejection of at least 50dB by comparing attenuated input signal with the output. Tune the oscillator frequency slightly to achieve maximum rejection.

MODEL 4211

<u>OSC. FREQUENCY</u> Hz	<u>HIGH PASS</u>		<u>LOW PASS</u>	
	<u>Setting</u>	<u>Mult.</u>	<u>Setting</u>	<u>Mult.</u>
563	10	10^2	3.15	10^2

MODELS 4212, 4213

<u>OSC. FREQUENCY</u> Hz	<u>HIGH PASS</u>		<u>LOW PASS</u>	
	<u>Setting</u>	<u>Mult.</u>	<u>Setting</u>	<u>Mult.</u>
5630	10	10^3	3.15	10^3

14.0 STOP BAND ATTENUATION (SET-UP #3)

Note: When testing the low pass section, the high pass section is set to 500 Hz to reject line related components in the oscillator. When testing the high pass section, the low pass section is set to twice the test frequency to reject higher order harmonics of the test oscillator.

14.1 Set the input signal level to 3.16 V RMS (+10dB).

14.2 Put a top and bottom cover on the filter (not necessary to secure it with screws).

14.3 Set 451 postamplifier gain for 40dB gain, 1Hz low frequency cutoff, 4113 for DC to 100kHz.

14.4 If filter has amplifier option, set filter gain for 0dB.

LOW PASS TEST

MODEL	HIGH PASS		LOW PASS		FREQ.	ATTEN. PASS
	<u>Setting</u>	<u>Mult.</u>	<u>Setting</u>	<u>Mult.</u>	<u>Hz</u>	<u>Limit--dB</u>
4211	5.0	10 ²	10.0	10	2k	90
	5.0	10 ²	10.0	10 ²	20k	90
4212	5.0	10 ²	10.0	10 ²	20k	90
	5.0	10 ²	1.0	10 ³	20k	90
4213	5.0	10 ²	1.0	10 ³	20k	90
	5.0	10 ²	1.0	10 ⁴	200k*	90

*Set input signal to 2.0V RMS (+6dB) and measure gain of 451 separately to find its roll-off, set 4113 low pass cutoff for 500 kHz, and high pass cutoff for 63 kHz. Avoid ground loops in test setup.

HIGH PASS TEST

MODEL	HIGH PASS		LOW PASS		FREQ.	ATTEN. PASS
	<u>Setting</u>	<u>Mult.</u>	<u>Setting</u>	<u>Mult.</u>	<u>Hz</u>	<u>Limit--dB</u>
4211	10	10	10	1.0	5	90
	10	10 ²	10	10	50	90
4212	10	10 ²	10	10	50	90
	10	10 ³	10	10 ²	500	90
4213	10	10 ³	10	10 ²	500	90
	10	10 ⁴	10	10 ³	5k	90

15.0 BROADBAND NOISE (SET-UP #3)

- 15.1 Place shorting cap on input.
- 15.2 Set 4113 bandwidth for DC to 100 kHz.
- 15.3 If filter under test has amplifier option, set its gain for 40 dB and remove the 451 post-amplifier from setup.
- 15.4 If filter does not have amplifier option, set 451 gain for 40dB, low frequency roll-off for 1 Hz.

MODEL	HIGH PASS		LOW PASS		NOISE-PASS LIMIT <u>μ Volts Ref. to Input</u>
	<u>Setting</u>	<u>Mult.</u>	<u>Setting</u>	<u>Mult.</u>	
4211	1.0	.01	10.0	10 ³	70
	1.0	.01	1.0	10 ²	70
4212	1.0	0.1	1.0	10 ⁴	70
	1.0	0.1	1.0	10 ³	70
4213	1.0	1.0	1.0	10 ⁵	70
	1.0	1.0	1.0	10 ⁴	70

16.0 POPCORN NOISE (SET-UP #3)

- 16.1 Place shorting cap on input. Set test filter to 1 x1 high pass and 10 x 1k low pass.
- 16.2 Set 4113 post filter to high pass out and 1 x 1k low pass.
- 16.3 If filter has amplifier option, set its gain to 0dB.
- 16.4 Set 451 post amplifier to 70dB gain, low frequency rolloff at 1 Hz.
- 16.5 Replace RMS meter with scope; set to 100 mV/cm vertical sensitivity and 20 mS/cm horizontal sweep (free running).
- 16.6 Observe for rectangular noise pulses as shown on the waveform photo below, rejecting units exhibiting noise pulses.

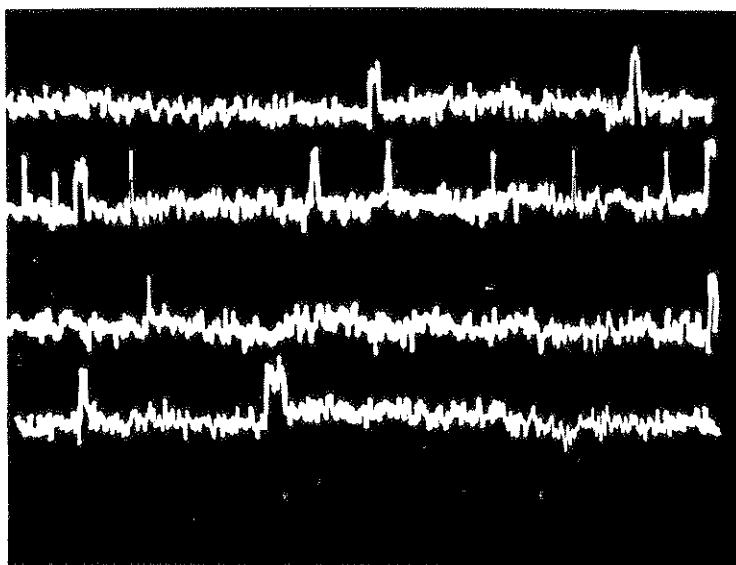

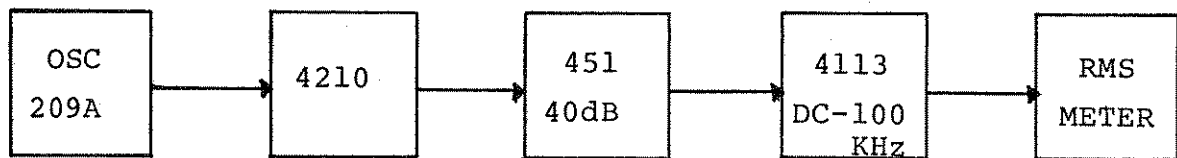
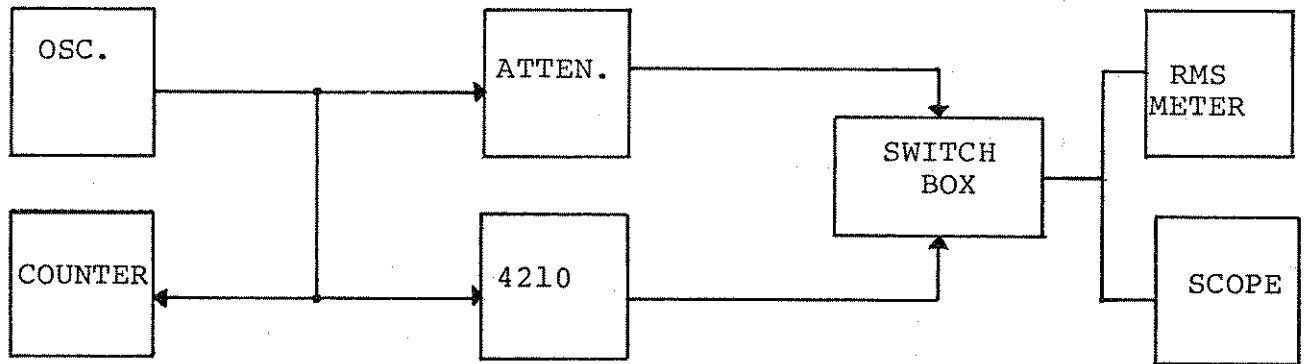
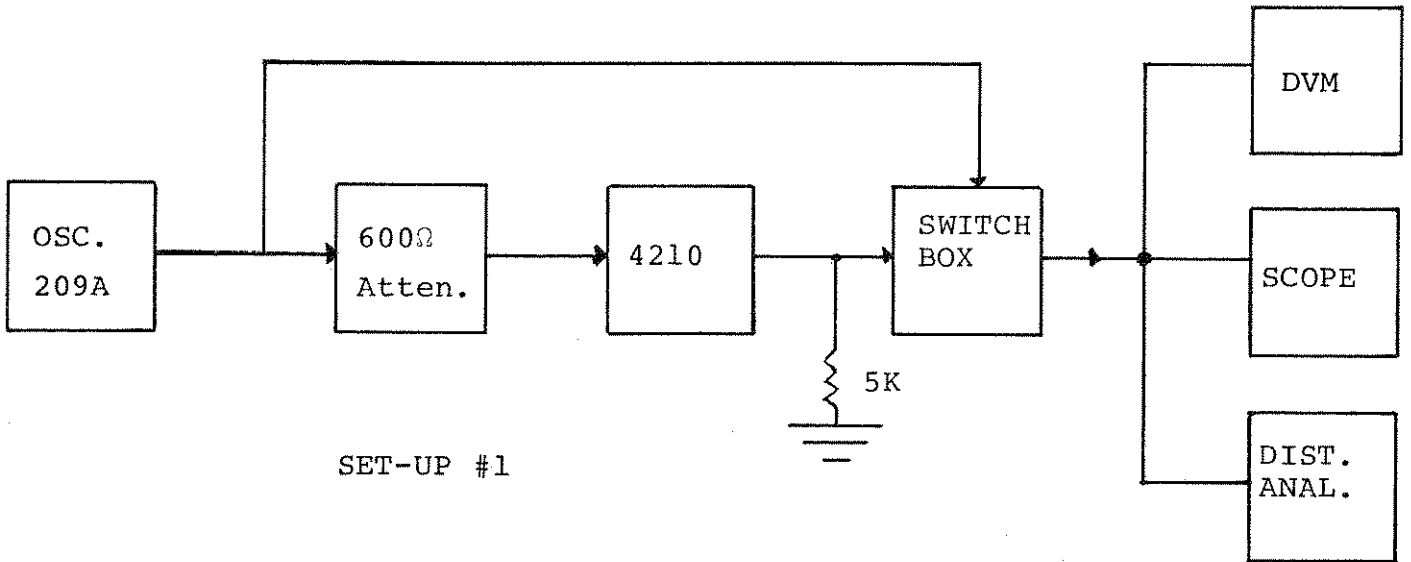

1.0 OBJECTIVE

To test and calibrate the 4200 0 to 40dB amplifier stage before assembly in the 4210 Series filters.

2.0 EQUIPMENT NEEDED

1. Digital Voltmeter - Dana 5230
2. Oscillator, 50 ohm, 10MHz -HP651A
3. 50 ohm attenuator - HP 355D
4. Distortion Analyzer - HP 331A
5. RMS meter - Ballantine 323
6. 4113 Filter
7. 451 Postamplifier
8. Oscilloscope
9. Test Jig #J121
10. Power Supplies \pm 14 volts

3.0 INITIAL CONNECTIONS

1. Adjust power supplies for \pm 14.1 volts before connecting to test jig.
2. Turn supplies off and plug them into test jig. Make certain polarities are correct.
3. Plug amplifier card into test jig. The center pin at each end of the switch assembly fits into the outermost gold terminal at each end of the test jig. Do not force card into place.
4. Keep all input and output cables shorter than 1.5 feet.
5. Turn on power supplies; Current drain should be approximately 15 ma.

4.0 D.C. OFFSET ADJUSTMENT (Set-up #1)

1. Place shorting cap on attenuator input of J121
2. Set amplifier for 20 dB gain
3. Place S1 in OUT 1 position, S2 to OUTPUT
4. Adjust R1 for 0.0.volts (\pm 0.2mv) offset
5. Switch S1 to OUT 2

6. Adjust R10 for 0.0 Volts ($\pm 0.2\text{mv}$) offset.
7. Switch amplifier to 40dB gain.
8. If offset is greater than $\pm 1.0\text{mv}$, readjust R1 to lower it.
9. Offset should now be less than $\pm 1.5\text{mv}$ at all gain settings.

5.0 MAXIMUM OUTPUT (SET-UP #2)

1. Set amplifier to 40dB gain
2. Switch S1 to OUT 2, S2 to OUTPUT.
3. With oscillator at 1 KHz, reduce attenuator to 10dB position.
4. Verify that an output of at least 22 volts peak-to-peak can be obtained with no clipping (Readjust oscillator amplitude if necessary).

6.0 GAIN ADJUST (SET-UP #2)

Be sure amplifier has warmed up for 3 minutes before attempting this adjustment.

1. Set-up as above but replace oscilloscope with RMS meter.
2. Place S2 to INPUT position.
3. Set attenuator for 40dB.
4. Set oscillator frequency for 1 KHz and adjust oscillator amplitude for RMS meter reading of 316mv with meter on 300mv range (+10dB mark).
5. Set amplifier for 40dB gain.
6. Switch S1 to OUT 2, S2 to OUTPUT.
7. Adjust R12 so meter indicates exactly +10dB on 300mv scale (no change in meter reading when S2 is switched between INPUT and OUTPUT).
8. Check gain on other ranges by switching attenuator and gain switch and comparing input and output with S2.
9. Gain errors should be less than $\pm 0.05\text{dB}$.

7.0 HIGH FREQUENCY ROLLOFF ADJUSTMENT (SET-UP #2)

Be sure amplifier has warmed up for 3 minutes before attempting this adjustment.

1. Set amplifier gain and attenuator for 40dB.
2. Set S1 to OUT1, S2 to INPUT.
3. Set oscillator at 2MHz and adjust oscillator amplitude to give 316 mv reading on RMS meter (+10dB).
4. Switch S2 to OUTPUT and switch RMS meter to 30mv range.
5. Use insulated screwdriver to adjust C6 so output is down 0.8dB from +10dB point.
6. Change frequency to 1 MHz.
7. Switch RMS meter to 300mV range and switch S1 to OUT 2.
8. Adjust C7 so output is equal to input.

8.0 DISTORTION

1. Set up as in figure 2, but replace scope with distortion analyzer.
2. Set amplifier for 40dB gain
3. Place S1 to OUT 2, S2 to OUTPUT, oscillator frequency to 1 KHz.
4. Adjust attenuator and oscillator amplitude so amplifier output is 7.0 volts RMS.
5. Measured distortion should be less than 0.25%.

9.0 BROADBAND NOISE (SET-UP #3)

1. Place shorting cap on attenuator input of J121.
2. Set amplifier for 40 dB gain.
3. Switch S1 to OUT 2, S2 to OUTPUT.
4. Set 4113 filter low pass section to 100KHz, high pass section to OUT.
5. Set 451 postamp gain to 20dB.
6. Noise voltage should be less than 5mv RMS (5, μ volts referred to amplifier input).

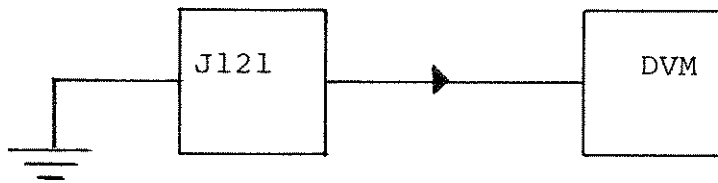

SET UP #1

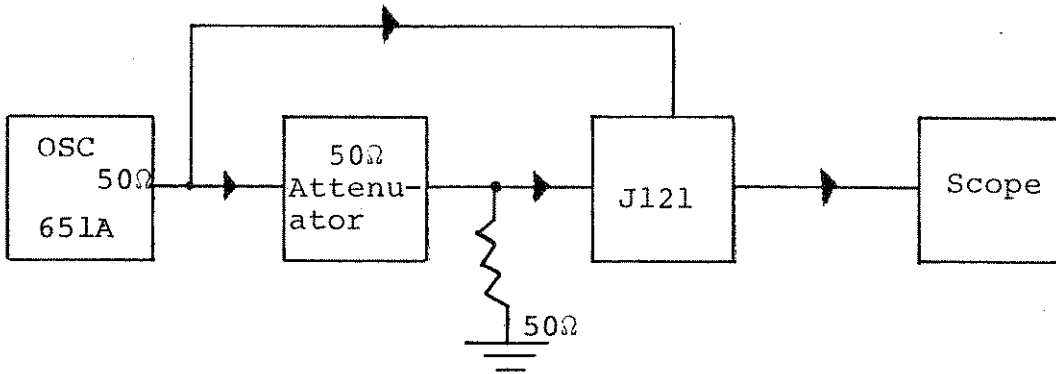

Note 1: Use 50Ω output of oscillator

Note 2: Be sure attenuator terminated with 50Ω

SET UP #2

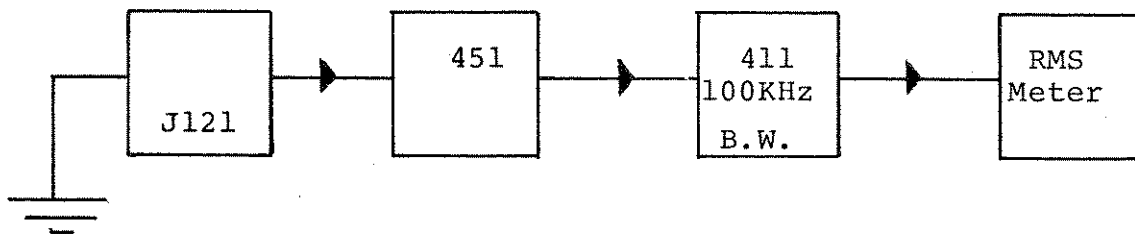

SET UP #3

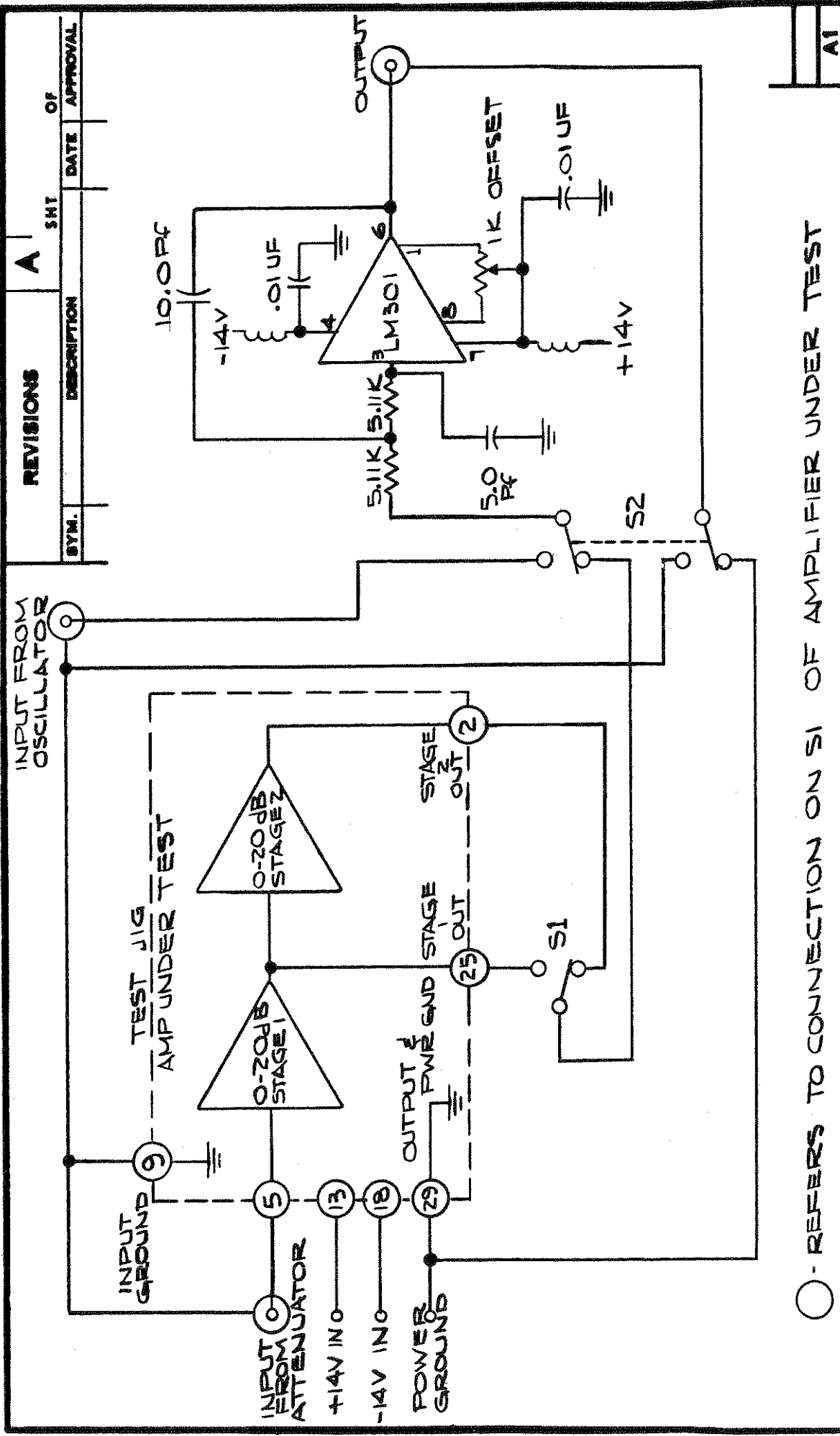

TEST JIG - J121
 4210 SERIES VARIABLE ELECTRONIC FILTERS

SECTION 6

6.0 REPLACEABLE PARTS

6.1 INTRODUCTION

This section contains information for ordering replacement parts. Tables list parts in alphabetical order of their reference designation and indicates the description and ITHACO part number for each part. When applicable, a typical manufacturer of a part is indicated.

6.2 ORDERING INFORMATION

To order a replacement part, address order or inquiry to an authorized ITHACO Representative or to:

Customer Service
ITHACO Inc.
735 West Clinton Street
Ithaca, New York 14850

Specify the following information for each part:

- a) Model and complete serial number of instrument
- b) ITHACO stock number
- c) Circuit Reference Designation
- d) Description

6.3 REFERENCE DESIGNATIONS

Table 6.1 is a list of reference designations

6.4 CODE LIST OF MANUFACTURERS

Table 6.3 is a Code List of Manufacturers. The manufacturer's code is given with each part. If a code number is missing, the part is of ITHACO manufacture and can be ordered by the ITHACO part number.

6.5 AMPLIFIER OPTION

Due to the placement of the optional post amplifier, it is quite difficult to replace parts on its circuit board. If trouble is encountered on the amplifier board, it is suggested the entire filter be returned to ITHACO for repair.

REFERENCE DESIGNATIONS

A	assembly subassembly, separable or repairable	H	hardware		plug, electrical (connector, movable portion)
AR	amplifier	HR	heater lamp, infrared	PS	power supply
AT	attenuator pad termination	HS	handset	Q	transistor
B	blower motor synchro	HY	network, hybrid circuit	R	potentiometer resistor
BT	battery	J	connector, receptacle, electrical disconnecting device jack receptacle (connector, stationary portion)	RT	lamp, resistance resistor, current regulating resistor, thermal thermistor
C	capacitor	K	relay	RV	resistor, voltage sensitive varistor, symmetrical
CB	circuit breaker	L	coil (all not classified as transformers) inductor	S	switch thermostat
CP	adapter, connector coupling (aperture, loop or probe) junction (coaxial or waveguide)	M	clock counter, electrical meter oscilloscope oscilloscope recorder, elapsed time register, message strain gage thermometer timer, electric	T	transformer
CR	diode rectifier	MK	microphone	TB	strip, terminal terminal board
DS	alarm indicator (excluding meter)	MP	frame gyroscope interlock, mechanical mechanical part mounting (not electrical circuit, not a socket) part, miscellaneous mechanical (bearing, coupling, gear, shaft) part, structural reed, vibration tuning fork	TC	thermocouple
E	antenna arrester, lightning bimetallic strip cell, aluminum or electrolytic contact core, inductor core, memory core, transformer Hall effect device insulator loop antenna magnet, permanent part, miscellaneous electrical post, binding shield, electrical terminal (individual)	MT	transducer transducer, mode	TP	test point
F	fuse	P	connector, plug, electrical disconnecting device (connector, plug)	U	integrated circuit package
FL	filter			V	cell, light-sensitive, photo- emissive electron tube
G	chopper, electronic generator			W	cable cable assembly (with connectors) wire
				WT	tiepoint, wiring
				X	fuseholder lampholder socket
				Y	crystal unit, piezoelectric

ABBREVIATIONS

A	ampere	GE	germanium	N	nano (10^{-9})	RF	radio frequency
AC	alternating current	GL	glass	N/C	normally closed	RMS	root-means-square
ALUM	aluminum	GND	ground	NE	neon	S-B	slow-blow
AMPL	amplifier	H	henries	N/O	normally open	SCR	screw
ASSY	assembly	HPF	high-pass filter	NPO	negative positive zero	SE	selenium
BP	bandpass	HR	hour	NSR	not separately replaceable	SEC	second
CAL	calibration	Hz	hertz	OSC	oscillator	SECT	section(s)
CAR	carbon	IF	intermediate frequency	OP	operational	SEMICON	semiconductor
CCW	counterclockwise	INS	insulation(ed)	PC	printed circuit internal	SI	silicon
CER	ceramic	INT	internal	PF	picofarads 10^{-12} farads	SIL	silver
CKT	circuit	K	kilo = 1000	PIV	peak inverse volt voltage	SL	slide
COMP	composition	LED	light emitting diode	P/P	part of	SOL	solid
CRT	cathode-ray tube	LIN	linear taper	PPM	parts per million	SPL	special
CW	clockwise	LOG	logarithmic taper	POLY	polystyrene	TA	tantalum
dB	decibel	LPF	low-pass filter	POLYCARB	poly carbonate	TGL	toggle
DC	direct current	M	Millo 10^{-3}	POS	position(s)	TOL	tolerance
DET	detector	MEG	meg 10^6	POT	potentiometer	TRIM	trimmer
DVM	digital voltmeter	METFLM	metal film	P-P	peak-to-peak	μ	micro 10^{-6}
ELECT	electrolytic	MFR	manufacturer	RC	resistor capacitor network	V	volt
ENCAP	encapsulated	MINAT	miniature	RECT	rectifier	VAR	variable
EXT	external	MOM	momentary	REF	reference	VDCW	dc working volts
F	farads	MTG	mounting			VCO	voltage controlled oscillator
FET	field effect transistor	MYFLM	"mylar" film			W/	with
FREQ	frequency					W	watts
FXD	fixed					WW	wirewound
						W/O	without

TABLE 6.1 LIST OF REFERENCE DESIGNATIONS AND ABBREVIATIONS

4210 SERIES FILTERS - ELECTRONIC FILTER CARD D41319

REFERENCE DESIGNATION	DESCRIPTION	PART NUMBER	MANUFACTURER	
			CODE	PART NUMBER
A1				
AR1	Op Amp, LM310	816400018	36	LM310H
AR2	Op Amp, LM310	816400018	36	LM310H
AR3	Op Amp, LM310	816400018	36	LM310H
AR4	Op Amp, LM310	816400018	36	LM310H
AR5	Op Amp, LM310	816400018	36	LM310H
AR6	Op Amp, LM310	816400018	36	LM310H
AR7	Op Amp	A86092P1	31	A86092P1
AR8	Op Amp	A86092P1	31	A86092P1
AR9	Op Amp, LM310	816400018	36	LM310H
AR10	Op Amp	A86092P1	31	A86092P1
AR11	Op Amp	A86092P1	31	A86092P1
AR12	Op Amp, LM310	816400018	36	LM310H
AR13	Op Amp	A86092P1	31	A86092P1
AR14	Op Amp, LM310	816400018	36	LM310H
AR15	Op Amp, LM310	816400018	36	LM310H
CAPACITORS				
C1	2 μ F, 200V, \pm 10%, Myfilm	811553013	22	230B1C205K
C2	220pF, 500V, 5%, Mica	811581032	23	DM15D221J
C3	.01 μ F, 500V, \pm 20%, Cer	811570019	48	5GAS-S10
C4	.01 μ F, 500V, \pm 20%, Cer	811570019	48	5GAS-S10
C5	.01 μ F, 500V, \pm 20%, Cer	811570019	48	5GAS-S10
C6	.01 μ F, 500V, \pm 20%, Cer	811570019	48	5GAS-S10
C7	.01 μ F, 500V, \pm 20%, Cer	811570019	48	5GAS-S10
C8	10pF, 500V, \pm 5%, Mica	811581056	23	DM15D100J
C9	.5pF, 500V, Mica	811581038	23	DM15C050D
C10	.01 μ F, 500V, \pm 20%, Cer	811570019	48	5GAS-S10
C11	.01 μ F, 500V, \pm 20%, Cer	811570019	48	5GAS-S10
C12	.01 μ F, 500V, \pm 20%, Cer	811570019	48	5GAS-S10
C13	.01 μ F, 500V, \pm 20%, Cer	811570019	48	5GAS-S10
CR1	Diode, Low Noise	A86003P1	26	FD300
CR2	Diode, Low Noise	A86003P1	26	FD300
CR3	Diode, Silicon	818100003		IN4148

TABLE 6.2 REPLACEABLE PARTS

4210 SERIES FILTERS - ELECTRONIC FILTER CARD D41319

REFERENCE DESIGNATION	DESCRIPTION	PART NUMBER	MANUFACTURER	
			CODE	PART NUMBER
A1				
L1	Ferrite Bead	811800014	51	1568
L2	Ferrite Bead	811800014	51	1568
L3	Ferrite Bead	811800014	51	1568
L4	Ferrite Bead	811800014	51	1568
	TRANSISTORS			
Q1	TSTR	A86021P1	31	A86021P1
Q2	TSTR	818203904		2N3904
Q3	TSTR	818203906		2N3906
	RESISTORS			
R1	330 ohm, 1/4W, 5%, Comp	817007331		RC07
R2	22M, 1/4W, 5%, Comp	817007226		RC07
R3	22 ohm, 1/4W, 5%, Comp	817007220		RC07
R4	825 ohm, 1/8W, 1%, Metflm	817210825		RN55D
R5	909 ohm, 1/8W, 1%, Metflm	817210909		RN55D
R6	7.5K, 1/8W, 1%, Metflm	817211750		RN55D
R7	511 ohm, 1/8W, 1%, Metflm	817210511		RN55D
R8	7.5K, 1/8W, 1%, Metflm	817211750		RN55D
R9	51.1 ohm, 1/8W, 1%, Metflm	817219511		RN55D
R10	464 ohm, 1/8W, 1%, Metflm	817210464		RN55D
R11	75 ohm, 1/8W, 1%, Metflm	817219750		RN55D
R12	10K, 1/8W, 1%, Metflm	817212100		RN55D
R13	200 ohm (POT)	817801018	29	66WR200
R14	13.3K, 1/8W, 1%, Metflm	817212133		RN55D
R15	3.16K, 1/8W, 1%, Metflm	817211316		RN55D
R16	13.3K, 1/8W, 1%, Metflm	817212133		RN55D
R17	13.3K, 1/8W, 1%, Metflm	817212133		RN55D
R18	13.3K, 1/8W, 1%, Metflm	817212133		RN55D
R19	19.6K, 1/8W, 1%, Metflm	817212196		RN55D
R20	13.3K, 1/8W, 1%, Metflm	817212133		RN55D
R21	750 ohm, 1/8W, 1%, Metflm	817210750		RN55D
R22	13.3K, 1/8W, 1%, Metflm	817212133		RN55D
R23	3.16K, 1/8W, 1%, Metflm	817211316		RN55D
R24	3.16K, 1/8W, 1%, Metflm	817211316		RN55D
R25	1.78K, 1/8W, 1%, Metflm	817211178		RN55D

TABLE 6.2 REPLACEABLE PARTS

4210 SERIES FILTERS - ELECTRONIC FILTER CARD D41319 (continued)

REFERENCE DESIGNATION	DESCRIPTION	PART NUMBER	MANUFACTURER	
			CODE	PART NUMBER
A1	RESISTORS (continued)			
R26	1K (POT)	817801019	29	66WR1K
R27	196 ohm, 1/8W, 1%, Metflm	817210196		RN55D
R28	100 ohm, 1/4W, 5%, Comp	817007101		RC07
R29	10K, 1/8W, 1%, Metflm	817212100		RN55D
R30	10K, 1/8W, 1%, Metflm	817261048		RN55D
R31	10K, 1/8W, 1%, Metflm	817261048		RN55D
R32	1K (POT)	817801019	29	66WR1K
R33	150 ohm, 1/4W, 5%, Comp	817007151		RC07
R34	5.11K, 1/8W, 1%, Metflm	817211511		RN55D
R35	150 ohm, 1/4W, 5%, Comp	817007151		RC07
R36	150 ohm, 1/4W, 5%, Comp	817007151		RC07
R37	150 ohm, 1/4W, 5%, Comp	817007151		RC07
R38	150 ohm, 1/4W, 5%, Comp	817007151		RC07
R39	150 ohm, 1/4W, 5%, Comp	817007151		RC07
R40	150 ohm, 1/4W, 5%, Comp	817007151		RC07
R41	150 ohm, 1/4W, 5%, Comp	817007151		RC07
R42	150 ohm, 1/4W, 5%, Comp	817007151		RC07
R44	1500M, 1/4W, 5%, Comp	817000015		RC07
R45	1500M, 1/4W, 5%, Comp	817000015		RC07
R46	1500M, 1/4W, 5%, Comp	817000015		RC07
R47	51.1K, 1/8W, 1%, Metflm	817212511		RN55D
R48	4.22K, 1/8W, 1%, Metflm	817211422		RN55D
R49	12K, 1/4W, 5%, Comp	817007123		RC07
R50	12K, 1/4W, 5%, Comp	817007123		RC07
S5	Switch DPDT	B88165P1	31	B88185P1
S6	Switch	B88301P1	31	B88301P1

TABLE 6.2 REPLACEABLE PARTS

REFERENCE DESIGNATION	DESCRIPTION	PART NUMBER	MANUFACTURER	
			CODE	PART NUMBER
A2				
AR1	Op Amp, LM301	A86050P4	36	LM301
AR2	Op Amp, LM301	A86050P4	36	LM301
CAPACITORS				
C1	500 μ F, 50V, -10% +75% Alum Elect	811530006	48	39D507G050GL4
C2	500 μ F, 50V, -10% +75%, Alum Elect	811530006	48	39D507G050GL4
C3	.01 μ F, 500V, \pm 20%, Cer	811570019	48	5GAS-S10
C4	.01 μ F, 500V, \pm 20%, Cer	811570019	48	5GAS-S10
C5	46 μ F, 20V, Solid Ta	811501162	48	150D476X9020R2
C6	46 μ F, 20V, Solid Ta	811501162	48	150D476X9020R2
C7	100pF, 5%, Sil Mica	811581008	17	CD15FD101J03
C8	100pF, 5%, Sil Mica	811581008	17	CD15FD101J03
DIODES				
CR1	Rectifier	818100007		IN4005
CR2	Rectifier	818100007		IN4005
CR3	Rectifier	818100007		IN4005
CR4	Rectifier	818100007		IN4005
CR5	Silicon	818100003		IN4148
CR6	Silicon	818100003		IN4148
CR7	Silicon	818100003		IN4148
CR8	Silicon	818100003		IN4148
CR9	Zener 10V, \pm 10%	818150032		IN5340A
CR10	Zener 10V, \pm 10%	818150032		IN5340A
CR11	6.5V \pm 1%	818150015	46	SZ6.5
CR12	Rectifier	818100007		IN4005
CR13	Rectifier	818100007		IN4005
TRANSISTORS				
Q1	XSTR	818205717		2N5717
Q2	XSTR	818700025	35	MJE800
Q3	XSTR	818203904		2N3904
Q4	XSTR	818205717		2N5717

TABLE 6.2 REPLACEABLE PARTS

REFERENCE DESIGNATION	DESCRIPTION	PART NUMBER	MANUFACTURER	
			CODE	PART NUMBER
A2	TRANSISTORS (continued)			
Q5	XSTR	818700024	35	MJE700
Q6	XSTR	818203906		2N3906
	RESISTORS			
R1	600 ohm, 3W, Wire wound	817002019		
R4	600 ohm, 3W, Wire wound	817002019		
R5	3.3 ohm, 1/4W, 5%, Carbon	817007339		RC07
R6	3.3 ohm, 1/4W, 5%, Carbon	817007339		RC07
R7	1.47K, 1/8W, 1%, Metflm	817211147		RN55D
R8	7.50K, 1/8W, 1%, Metflm	817211750		RN55D
R9	6.19K, 1/8W, 1%, Metflm	817211619		RN55D
R10	10.0K, 1/8W, 1%, Metflm	817212100		RN55D
R11	10.0K, 1/8W, 1%, Metflm	817212100		RN55D

TABLE 6.2 REPLACEABLE PARTS

REFERENCE DESIGNATION	DESCRIPTION	PART NUMBER	MANUFACTURER	
			CODE	PART NUMBER
1	Rear Panel	C31936G1		
F1	Fuse (1/4A, Slo/blo)	815183014	9	MDL
J4	Connector, 5 Pin	812123006	11	XLR-5-31
J5	Connector	812120007	52	EAC-301
J7	Connector, BNC	812130110	19	30355-1
J8	Connector, BNC	812130110	19	30355-1
R100	Resistor, 47 ohm, 1/8W, 5%	817000027		RCR05
S7	Switch, Slide STE Circuit	815188006	2	MSS534OR
S8	Switch, Slide 2 pst	815188002	52	46206LFR
S9	Switch, Slide 4P3 pos	815188008	52	49331L
T1	Transformer (Special)	B88130P1	31	B88130P1
XF1	Fuse Holder	815182005	9	HTL
2	Front Panel			
S1	Resistor Switch	C31445		
S2	Capacitor Switch	C31453		
S3	Resistor Switch	C31446		
S4	Capacitor Switch	C31447		

TABLE 6.2 REPLACEABLE PARTS

REFERENCE DESIGNATION	DESCRIPTION	ITHACO PART NUMBER	MANUFACTURER	
			CODE	PART NUMBER
A3				
AR1	Op Amp	A86092P2	31	A86092P2
AR2	Op Amp, 741	806400019	5	AD741
	CAPACITORS			
C1	1000pF, 500V, ±5%, Mica	811581030	23	DM19D102J
C2	1000pF, 500V, ±5%, Mica	811581030	23	DM19D102J
	RESISTORS			
R1	1500M, 1/4W, 20%, Comp	817000015	3	CB1582
R2	82K, 1/4W, 5%, Comp	817007823		RC07
R3	82K, 1/4W, 5%, Comp	817007823		RC07
R4	82K, 1/4W, 5%, Comp	817007823		RC07
R5	10K, 1/4W, 5%, Comp	817007103		RC07
R6	50K, 10%, (POT)	817801026	29	66XR50K
R7	50K, 10%, (POT)	817801026	29	66XR50K
R8	50K, 10%, (POT)	817801026	29	66XR50K
R9	12K, 1/4W, 5%, Comp	817007123		RC07
1	Card, P.C.	B22087P1		
2	Terminal, Bif	812126001		
3	Terminal	812126027		
BT1	Battery	814000005	68	402783
BT2	Battery	814000005	68	402783

TABLE 6.2 REPLACEABLE PARTS

CODE LIST OF MANUFACTURERS

1	Aerovox	51	D M Steward Mfg
2	Alco Electronic Prod	52	Switchcraft
3	Allen Bradley		
4	Amphenol Connector	53	Teledyne Semiconductor
5	Analog Devices	54	Teledyne Western Wire and Cable
		55	Texas Instruments
6	Belden	56	Thermalloy
7	Bourns	57	TRW
8	Buckeye Stamping		
9	Bussman Mfg	58	United Transformer
		59	Useco
10	Cambion		
11	Cannon, ITT	60	Vactec
12	Centralab		
13	Cinch Mfg	61	Winchester Electronic
14	C & K Components		
15	Continental- Wirt Elec	62	Vishay
16	Corcom	63	ACI
17	Cornell Dubilier Elec	64	IRC
18	CTS	65	EAL
		66	AMP
19	Dage Electric	67	Clarostat Mfg
20	Delevan Electronics	68	Gould Inc
21	Dresser Systems	69	Littlefuse Inc
22	Electracube	70	General Illumination
23	Electro Motive Mfg		
24	Electronics Applications	71	Signetrix
25	Erie Technological Products	72	Semiconductor Cir
		73	Statek
26	Fairchild Semiconductor	74	Bendix
27	Federal Screw Prod	75	Burndy
		76	American Handle Sales
28	General Electric	77	Varo Semiconductor
		78	Dialco
29	Helipot	79	Elmenco
30	Heyman Mfg	80	Amp Incorporated
31	ITHACO	81	Berg
		82	Comp Corp
32	E F Johnson	83	Hewlett-Packard
		84	Beckman Helipot
33	Litronix	85	Raytheon
		86	Intersil
34	Marco-Oak Industries	87	A H & H
35	Motorola Semiconductor Prod	88	ADC Products
		89	Scanbe
36	National Semiconductor	90	Drake
		91	Victoreen
37	Ohmite Mfg	92	Frost
		93	Sigma
38	Paktron	94	Becon
39	Panduit	95	Microswitch
40	Pomona Electronics	96	Wavetek
41	Product Components	97	Electronic Concepts
42	Pyrofilm	98	Amelco
		99	Mepco
43	RCL Electronics	100	RCA
44	Rembrandt	101	Circuit Assm Corp
45	Rogan	102	Monsanto
		103	Ainsley
46	Schauer Mfg		
47	H H Smith		
48	Sprague Electric		
49	Spectrol Electronics		
50	Stancor		

TABLE 6.3 CODE LIST OF MANUFACTURERS

