

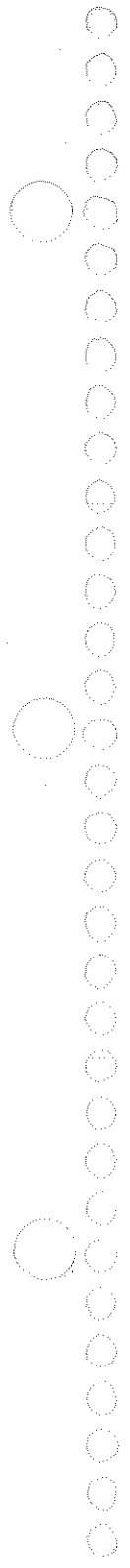

Document 50-16348-01, Rev. E
December 2000

**2000 Test Pad™
2310 SONET Field Services Module
User's Guide**



Notice
Every effort was made to ensure that the information in this document was accurate at the time of printing. However, information is subject to change without notice, and Acterna, formerly TTC and WWG, reserves the right to provide an addendum to this document with information not available at the time that this document was created.

Copyright
Copyright 2000 Dynatech, LLC, doing business as Acterna. All rights reserved. No part of this guide may be reproduced or transmitted electronically or otherwise without written permission of the publisher.

Trademarks
Acterna and 2000 Test Pad are trademarks or registered trademarks of Acterna in the United States and/or other countries. Microsoft, Windows, Windows CE, and Windows NT are either trademarks or registered trademarks of Microsoft Corporation in the United States and/or other countries.

Specifications, terms, and conditions are subject to change without notice. All trademarks and registered trademarks are the property of their respective companies.

Ordering Information
This guide is a product of Acterna's Technical Publications Department, issued as part of the TTC 2000 Platform. The ordering number for this document is 80-16348-01, Rev G.



20400 Observation Drive, Germantown, Maryland 20876-4023
USA 1-800-638-2049 • + 1-301-353-1550 • FAX + 1-301-353-9216
Canada 1-888-689-2165 • + 1-905-812-7471 • FAX + 1-905-812-3892
www.acterna.com

Federal Communications Commission (FCC) Notice
This product was tested and found to comply with the limits for a Class A digital device, pursuant to Part 15 of the FCC Rules. For units equipped up to OC-48, the 2310 complies to Part 15 of the FCC Rules. For units equipped up to OC-48, the 2310 complies to Part 15 of the FCC Rules. These limits are designed to provide reasonable protection against harmful interference when the equipment is operated in a commercial environment. This product generates, uses, and can radiate radio frequency energy and, if not installed and used in accordance with the instruction manual, may cause harmful interference to radio communications. Operation of this product in a residential area is likely to cause harmful interference, in which case you will be required to correct the interference at your own expense.

The authority to operate this product is conditioned by the requirements that no modifications be made to the equipment unless the changes or modifications are expressly approved by Acterna.

Industry Canada Requirements

This Class A digital apparatus complies with Canadian ICES-003. For units equipped up to OC-48, the 2310 complies to Canadian ICES-003 up to 1 GHz.

Cet appareil numérique de la classe A est conforme à la norme NMB-003 du Canada.

EMC Directive Compliance

This product was tested and conforms to the EMC Directive, 89/336/EEC as amended by 92/31/EEC and 93/68/EEC for electromagnetic compatibility. A copy of the Declaration of Conformity is provided in this manual.

Low Voltage Directive Compliance

This product was tested and conforms to the Low Voltage Directive, 73/23/EEC as amended by 93/68/EEC. Conformity with this directive is based upon compliance with the harmonized safety standard, EN60950. A copy of the Declaration of Conformity is provided in this manual.

WARNING: This is a Class A product. In a domestic environment, this product may cause radio interference, in which case, the user may be required to take adequate measures.

Important Safety Instructions

When using the product, basic safety precautions should always be followed to reduce the risk of fire, shock, and injury to persons, including the following:

- 1 Read and follow all warning notices and instructions marked on the product and included in the manual.
- 2 Use only the AC Adapter/Charger supplied with the product.
- 3 Do not use AC Adapter/Charger outdoors or in wet or damp locations.
- 4 Connect the AC Adapter/Charger to the correct mains voltage, as indicated on the ratings label.
- 5 Do not allow anything to rest on the power cord, and do not locate the product where persons can walk on the power cord.
- 6 Avoid using this product during an electrical storm. There may be a remote risk of electric shock from lightning.
- 7 Do not use this product in the vicinity of a gas leak or in any explosive environment.
- 8 Do not attempt to service this product yourself, as opening or removing covers may expose you to dangerous, high voltage points and other hazards. Refer all servicing to qualified service personnel.
- 9 **CAUTION:** Danger of explosion if battery is incorrectly replaced. Dispose of used batteries according to the manufacturer's instructions.
- 10 **CAUTION:** Never look into the optic transmitters when the unit is ON.

Declaration of Conformity



Application of Council Directive(s):

LVD: 73/23/EEC as amended by 93/68/EEC
EMC: 89/336/EEC as amended by 92/31/EEC and 93/68/EEC

Standard(s) to which Conformity is Declared:

EN60950 (A1-A4 & A11), EN55022:1994 (A1 & A2), EN50082-1:1992, EN61000-4-2,
EN61000-4-3, ENV50204, EN61000-4-4, EN61000-3-2, EN61000-3-3

Manufacturer: Acterna
20400 Observation Drive
Germantown, MD 20876
USA

subsidary at:
Portland House
Aldermaston Park
Aldermaston
Berkshire
RG7 4HR
United Kingdom

Product Description:

User Interface Module with
Applications Module

Model No.:

TTC2000 with
T-Berd 2310

*I, the undersigned, hereby declare that the equipment specified above
conforms to the above Directive(s) and Standard(s).*

Germantown, MD USA

4 December, 2000

Date

John Paul Williams

signature

Director, Corporate Quality and Customer Satisfaction

Print Name

Acterna Doc. No. 50-17316-01 Rev. B

Print Title

Contents

About This Guide	xvii
Purpose and scope	xvii
Assumptions	xvii
Getting technical assistance	xviii
Using this guide	xix
Conventions	xx
Chapter 1—Introduction	1
About the 2310	2
Features and capabilities	3
Options	4
System requirements	6
Hardware requirements	6
Physical description	8
Front-panel features	8
Bottom-panel features	9
Top-panel features	10
Interface connector layouts	11
Chapter 2—Operation	13
About operating the 2310	14

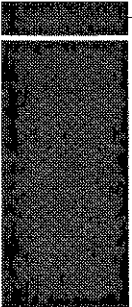
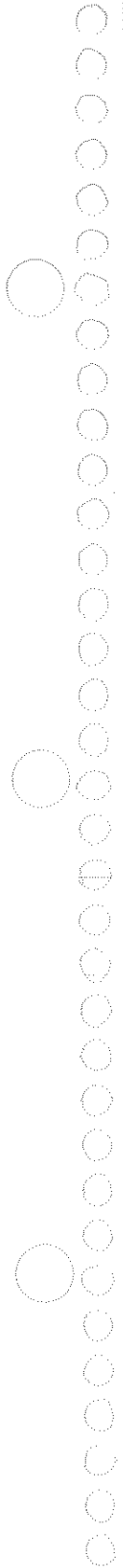

Using the front panel 14

LCD functional description 14

LCD features 14

Extended permanent softkeys 14

Color display 15

Transflective-monochrome display 16

LED display panel 17

Working with the 2310 user interface 21

Working with application setup property sheets 28

Operating the printer 31

Setting up the printer 31

Connecting the printer 31

Settings 31

Using the PRINTOUTS property sheet 32

Using the EVENTS property sheet 34

Using the Printer Settings property sheet 35

Getting started 36

Basic test setup 36

Error LEDs 39

Recharging the battery 39

Battery replacement 40

Chapter 3—Common Applications 41

Using the T1 option 43

Monitoring T1 performance 43

Configuring the 2310 43

Connecting the 2310 to the circuit 44

Connecting the 2310 to the circuit diagram 45

T1 BERT Termination setup 46

Configuring the 2310 46

Connecting the 2310 to the circuit 47

Connecting the 2310 to the circuit diagram 48

T1 Loopback BER Testing 49

Configuring the 2310 49

51 Connecting the 2310 to the circuit.....

52 Connecting the 2310 to the circuit diagram.....

52 T1 Timing Slip Analysis.....

52 Configuring the 2310.....

55 Connecting the 2310 to the circuit.....

56 Connecting the 2310 to the circuit diagram.....

57 Using the Fractional T1 (FT1) option.....

57 FT1 Loopback BER testing.....

57 Configuring the 2310.....

59 Connecting the 2310 to the circuit.....

61 Connecting the 2310 to the circuit diagram.....

61 FT1 Drop and Insert testing.....

61 Configuring the 2310.....

62 Connecting the 2310.....

63 Connecting the 2310 to the circuit.....

66 Connecting the 2310 to the circuit diagram.....

67 Using the DDS option.....

67 DDS Loopback BER testing.....

67 Configuring the 2310.....

69 Connecting the 2310 to the circuit.....

70 Connecting the 2310 to the circuit diagram.....

70 DDS Drop and Insert Testing.....

71 Configuring the T-BERD 2310.....

71 Connecting the 2310 to the circuit.....

73 Connecting the 2310 to the circuit diagram.....

76 Connecting the 2310 to the circuit.....

77 Using the Signaling option.....

77 Monitoring A/B/C/D signaling bits.....

77 Configuring the 2310.....

78 Connecting the 2310 to the circuit.....

79 Signaling Monitor (Call Capture).....

79 Configuring the 2310.....

79 Connecting the 2310 to the circuit.....

82 PBX/Switch Emulation (originating a call).....

83 Configuring the 2310.....

83 Connecting the 2310 to the circuit.....

84 Connecting the 2310 to the circuit.....

85 PBX/Switch Emulation (terminating a call).....

Configuring the 2310	85
Connecting the 2310 to the circuit	87
T1 Drop and Insert (Place Call)	87
Configuring the 2310	87
Connecting the 2310 to the circuit	89
Using the VF option	91
VF Channel Drop/Monitoring from DS1	91
Configuring the 2310	91
Connecting the 2310 to the circuit	92
Connecting the 2310 to the circuit diagram	94
Transmitting VF Tones	95
Configuring the 2310	95
Connecting the 2310 to the circuit	97
Connecting the 2310 to the circuit diagram	98
Using the Intelligent Repeater Span option	99
Configuring the 2310	100
Connecting the 2310 to the circuit	102
Connecting the 2310 to the circuit diagram	103
Using the DS3 option	105
Monitoring DS3 performance	105
Configuring the 2310	105
Connecting the 2310 to the circuit	107
Connecting the 2310 to the circuit diagram	107
DS3 BER testing	108
Configuring the 2310	108
Connecting the 2310 to the circuit	110
Connecting the 2310 to the circuit diagram	111
Using the STS-1 option	113
Monitoring STS-1 performance	113
Configuring the 2310	113
Connecting the 2310 to the circuit	115
Connecting the 2310 to the circuit diagram	116
STS-1 BER testing	117
Configuring the 2310	117
Connecting the 2310 to the circuit	118

120 Connecting the 2310 to the circuit diagram.....

121 VT1.5 Drop/Monitoring from STS-1.....

121 Configuring the 2310.....

122 Connecting the 2310 to the circuit.....

123 Connecting the 2310 to the circuit diagram.....

125 Using the OC-3/OC-12/OC-48 option.....

126 Monitoring OC-3/OC-12/OC-48 performance.....

126 Configuring the 2310.....

128 Connecting the 2310 to the circuit.....

129 Connecting the 2310 to the circuit diagram.....

130 OC-3/OC-12/OC-48 BER testing.....

130 Configuring the 2310.....

132 Connecting the 2310 to the circuit.....

133 Connecting the 2310 to the circuit diagram.....

134 Optical Power measurement.....

134 Configuring the 2310.....

135 Connecting the 2310 to the circuit.....

136 Connecting the 2310 to the circuit diagram.....

137 Using the VT100 Emulation option.....

137 Configuring the 2310.....

141 Using the OC-3c/12c ATM option.....

142 Profiling with the Search Mode.....

143 Monitoring ATM payloads.....

143 Configuring the 2310.....

145 Connecting the 2310 to the circuit.....

146 Connecting the 2310 to the circuit diagram.....

147 Terminating ATM payloads.....

147 Configuring the 2310.....

150 Connecting the 2310 to the circuit.....

151 Connecting the 2310 to the circuit diagram.....

153 Using the GR-303 option.....

154 Level 3 call statistics.....

155 Monitoring GR-303 performance.....

155 Configuring the 2310.....

158 Connecting the 2310 to the circuit.....

159 Connecting the 2310 to the circuit diagram.....

161 Using the ISDN PRI option.....

161 Monitoring ISDN PRI calls.....

162 Configuring the 2310.....

165 Connecting the 2310 to the circuit.....

166 Connecting the 2310 to the circuit diagram.....

167 Using PRI ISDN in Terminate mode.....

167 Placing a call.....

168 Configuring the 2310.....

171 Connecting the 2310 to the circuit.....

173 Receiving a call.....

173 Configuring the 2310.....

174 Connecting the 2310 to the circuit.....

175 Connecting the 2310 to the circuit diagram.....

175 NFA5 and D channel backup testing.....

175 Configuring the 2310.....

Chapter 4—Test Results

181 Results Categories.....

181 Summary Category.....

181 DS1 Summary Category test results.....

182 DS3 Summary Category test results.....

182 SONET Summary Category test results.....

183 LED Category.....

184 DS1 LED Category test results.....

185 DS3 LED Category test results.....

186 SONET LED test results.....

188 Signal Category.....

188 DS1 Signal test results.....

189 DS3 Signal test results.....

190 SONET Signal test results.....

192 BPV Category.....

192 DS1 BPV test results.....

DS3 BPV test results 193

Frame Category 193

DS1 Frame test results 194

DS3 Frame test results 195

Parity Category 197

DS3 Parity test results 197

SONET Section Category 199

SONET Section test results 199

SONET Line Category 200

SONET Line test results 201

SONET Path Category 204

SONET Path test results 205

SONET Path Trace Category 206

SONET Path Trace test results 207

SONET VT Category 207

SONET VT test results 208

SONET ATM Category 210

SONET ATM VP/VC test results 210

Channel Category 212

Channel VF and DDS test results 212

Reportable DS0 Control Codes 214

Call Signal Category 215

Call Signal test results 216

Traffic Category 217

Traffic Category test results 217

Logic Category 218

DS1, DS3, and SONET Logic test results 218

Time Category 220

Time Category test results 220

GR-303 Category 221

GR-303 Level-2 test results 221

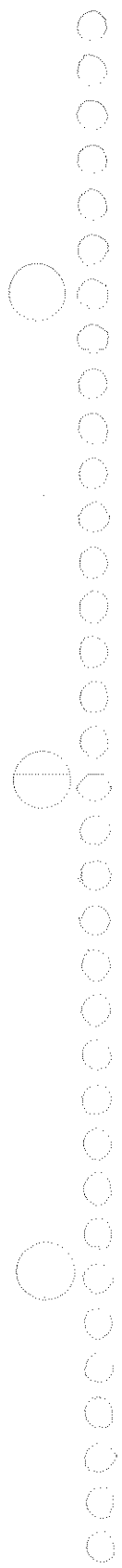

GR-303 Level-3 test results 223

GR-303 Cause Codes 223

PRI ISDN Category 225

PRI ISDN test results 225

PRI ISDN Cause Codes 227

National-specific Cause Codes 229

Quad Results 230

Quad customized test results 230

Using Quad results 231

Configuring the 2310 for Quad results 231

Chapter 5—Customer Services 235

About our services 236

Customer service locations 236

Instrument services 237

Product Enhancement Group 238

Test systems field engineering and installation 238

Technical training 239

Warranty information 240

Equipment return instructions 242

Appendix A—Specifications 245

Physical specifications 246

Environmental specifications 246

Electrical specifications 247

DS1 input specifications 248

DS1 output specifications 249

DS3 and STS-1 input specifications 250

DS3 and STS-1 output specifications 251

Optical specifications for OC-3/12/48 252

ISDN PRI specifications 254

ISDN PRI characteristics 254

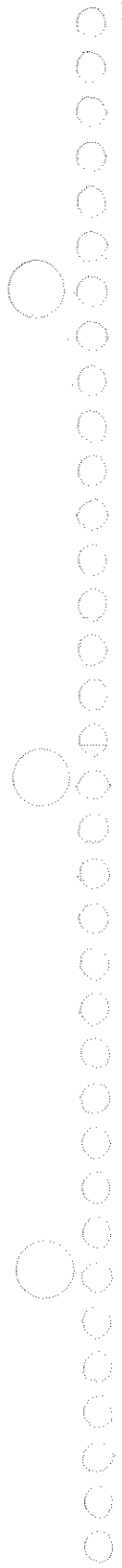

ISDN PRI status messages 254

ATM specifications 255

GR-303 specifications 255



Figures

Figure 1 — The 2000 Platform 2310 module 2

Figure 2 — 2000 Test Pad and 2310 module 7

Figure 3 — 2310 front panel 9

Figure 4 — The 2310 bottom panel 10

Figure 5 — The 2310 top panel 12

Figure 6 — Available interface connectors 17

Figure 7 — LED display for Current/History signal alarm 21

Figure 8 — Main screen and extended softkeys 22

Figure 9 — Application icons with pull-down lists 23

Figure 10 — Results Group selection on main menu screen 26

Figure 11 — Pull-down list in Results Category 27

Figure 12 — Quick Configuration/Action buttons 28

Figure 13 — Sample Configuration/Action button usage 28

Figure 14 — Dual-Test Results display (labeled) 28

Figure 15 — Setup Summary property sheet 29

Figure 16 — Property sheet tabs set test parameters 30

Figure 17 — PRINTOUTS property sheet 32

Figure 18 — Preview screen of files within print buffer 33

Figure 19 — EVENTS property sheet 34

Figure 20 — Printer Settings property sheet 35

Figure 21 — T1 Monitor test setup 45

Figure 22 — T1 Termination test setup 48

Figure 23 — T1 Loopback test setup 52

Figure 24 — DS1 Timing Slips test setup 56

Figure 25 — FT1 Loopback test setup 61

Figure 26 — FT1 Drop and Insert test setup 66

Figure 27 — DDS Loopback BER test setup 70

Figure 28 — DDS Drop and Insert test setup 76

Figure 29 — Drop and Insert test setup 89

Figure 30 — DS0 (VF) Drop/Monitor test setup 94

Figure 31 — VF Tone Insertion test setup 98

Figure 32 — Intelligent Repeater loop code test setup 103

Figure 33 — DS3 Monitor test setup 107

Figure 34 — DS3 Termination test setup 111

Figure 35 — STS-1 Monitor test setup 116

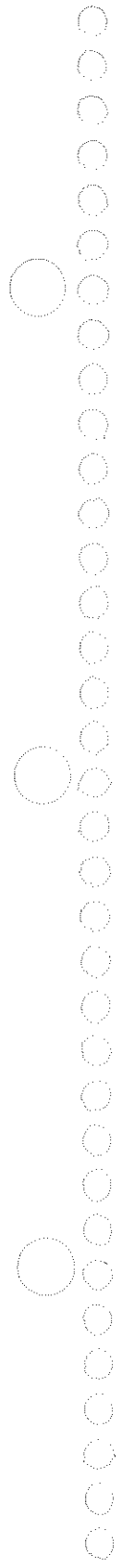

Figure 36 — STS-1 BER test setup120

Figure 37 — STS-1/VT 1.5 Drop/Monitor test setup123

Figure 38 — MON/THRU Mode Error/Alarm Insert test setup129

Figure 39 — SONE1 Termination BER test setup133

Figure 40 — OC-3/12/48 Power Measurement setup136

Figure 41 — TTC ATM Test Cell #1142

Figure 42 — Monitoring OC-3c/12c ATM test setup146

Figure 43 — Terminating OC-3c/12c ATM test setup151

Figure 44 — GR-303 test setup159

Figure 45 — Monitor ISDN PRI test setup166

Figure 46 — Terminate ISDN PRI Test Setup175

Figure 47 — Sample Quad Results screen on 2310232

Figure 48 — Custom Results property sheet233

Figure 49 — Custom Results enable/disable property sheets234

Tables

Table 1 — Front-panel features	8
Table 2 — Bottom-panel features	10
Table 3 — Top-panel features	11
Table 4 — Color extended softkey icons	15
Table 5 — Transflective-monochrome extended softkey icons	16
Table 6 — Green Status LEDs	18
Table 7 — Red Alarm LEDs	19
Table 8 — DATA Category Red Alarm LEDs	20
Table 9 — Description of PRINTOUTS action buttons	32
Table 10 — Description of <i>EVENTS</i> property sheet	34
Table 11 — Description of Printer Setting property sheet	35
Table 12 — OC-3c/12c ATM TX and RX Profile setup fields	142
Table 13 — D channel states and descriptions	178
Table 14 — DS1 LED test results	184

Table 15 — DS3 LED test results 185

Table 16 — SONET LED test results 186

Table 17 — DS1 Signal test results 188

Table 18 — DS3 Signal test results 189

Table 19 — SONET Signal test results 190

Table 20 — DS1 BPV test results 192

Table 21 — DS3 BPV test results 193

Table 22 — DS1 Frame test results 194

Table 23 — DS3 Frame test results 195

Table 24 — DS3 Parity test results 197

Table 25 — SONET Section test results 199

Table 26 — SONET Line test results 201

Table 27 — SONET Path test results 205

Table 28 — SONET Path Trace test results 207

Table 29 — SONET Virtual Tributary Overhead test results 208

Table 30 — ATM VP/VC Stats, Cell, and Cell Type Category results
210

Table 31 — Channel VF and DDS Category test results 212

Table 32 — Reportable DS0 Control Codes 214

Table 33 — Call Signal Category test results 216

Table 34 — Traffic Category test results 217

Table 35 — DS1, DS3, and SONET Logic test results 218

Table 36 — Time Category test results.....220

Table 37 — GR-303 Level-2 Protocol Link test results.....221

Table 38 — GR-303 Level-3 call statistical test results.....223

Table 39 — GR-303 Cause Codes.....223

Table 40 — ISDN PRI category descriptions.....225

Table 41 — Cause Codes descriptions.....227

Table 42 — National-specific Cause Codes.....229

Table 43 — Custom Results for DS0, T1, DS3, and SONET.....230

Table 44 — Physical characteristics for 2310.....246

Table 45 — Electrical characteristics for 2310.....246

Table 46 — Electrical characteristics.....247

Table 47 — Input specifications for DS1.....248

Table 48 — Output specifications for DS1.....249

Table 49 — Input specifications for DS3 and STS-1.....250

Table 50 — Output specifications for DS3 and STS-1.....251

Table 51 — Optical specifications for OC-3/12/48.....253

Table 52 — ISDN option characteristics.....254

Table 53 — ISDN PRI status messages.....254

About This Guide

Purpose and scope

The purpose of this guide is to help you successfully use the 2310 features and capabilities. This guide includes task-based instructions that describe how to operate and use the 2310. Additionally, this guide provides a complete description of Acterna's warranty, services, and repair information, including terms and conditions of the licensing agreement.

Assumptions

This guide is intended for novice, intermediate, and experienced users who want to use the 2310 effectively and efficiently. We are assuming that you have basic computer and mouse/track ball experience and are familiar with basic telecommunication concepts and terminology.

During off hours, you can leave a voice mail message; send an email to tac@acterna.com (in Europe, eurotac@acterna.com); or submit your question using our online Technical Assistance Request form at www.acterna.com.

Region	Phone Number	Hours of Operation
Americas	1-800-638-2049	M-F, 8:00 a.m. to 8:00 p.m., EST
Europe, Africa, and Mid-East	+800 882 85822	M-F, 8:30 a.m. to 5:00 p.m., GMT
	+44 (0) 118 940-9200	(Acterna UK)
	+49 (0) 6172 59 11 00	(Acterna Germany)
	+33 (0) 1 39 30 24 24	(Acterna France)
Asia and the Pacific	+852 2892 0990	M-F, 9:00 a.m. to 5:30 p.m., (Hong Kong)
	+8610 6833 7477	(Beijing-China)

Technical assistance centers

If you need assistance or have questions related to the use of this product, call or email Acterna's Technical Assistance Center (TAC) for customer support.

Getting technical assistance

Using this guide

The following table is a roadmap to using this guide efficiently; however, all chapters in this guide can be used for reference purposes:

Locating information

To	Refer to
Become familiar with the 2310	Chapter 1 "Introduction"
Perform basic and general operations of the 2310	Chapter 2 "Operation"
Learn to use and apply features in a field environment	Chapter 3 "Common Applications"
Access and understand test results	Chapter 4 "Test Results"
Learn about the warranty	Chapter 5 "Customer Services"
Identify specifications	Appendix A "Specifications"

Conventions

This guide uses naming conventions and symbols, as described in the following tables:

Typographical conventions

Description	Example
Commands appear in this typeface . On the Status bar, click Start .	
Switches that you press on a unit appear in this TYPEFACE . Press the AUX switch.	
Variables such as names or arguments appear in this <i>typeface</i> . Enter new <i>hostname</i> .	
Computer code and output messages appear in this <i>typeface</i> . All results okay	
Text you must enter exactly as shown appear in this <i>typeface</i> . Type: a: \set .exe in the dialog box	
Directories, websites, and filenames appear in this <i>typeface</i> . filename.txt	
Square brackets [] indicate an optional argument. login [platform name]	
A vertical bar means "or"; only one option can appear in a single command. platform [a b e]	
Slanted brackets < > are used to group required arguments. <Enter your name>	
Brackets { } indicate a set of choices from which you must choose one. {file1 file2 file3}	



Keyboard and menu conventions

Description	Example
A plus sign + indicates simultaneous keystrokes	Press Ctrl+s
A comma indicates consecutive key strokes	Press Alt+f,s
A slanted bracket indicates choosing a submenu from menu	Click Start>Program Files

Warnings, cautions, and notes

Icon	Description
	WARNING: Action results in a serious injury or death.
	CAUTION: Action could cause minor or moderate injury and damage to you or equipment.
	NOTE: Provides related information or tip.

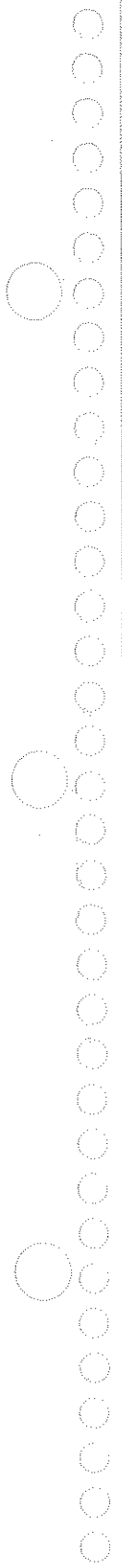





Introduction

This chapter provides a general description of the 2310. Topics discussed in this chapter include the following:

- “About the 2310” on page 2
- “Features and capabilities” on page 3
- “Options” on page 4
- “System requirements” on page 6
- “Physical description” on page 8

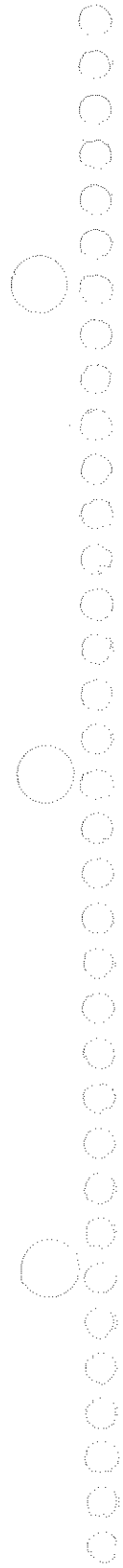

About the 2310

The 2310 Communication Analyzer is the perfect telecommunications installation and maintenance tool for a mobile workforce. A hand-held tester, its ease-of-use, flexibility, and functionality have established it as the next generation in test instruments. The 2310 is the *smallest* OC-48, battery-powered, integrated tester available. As a member of the 2000 Test Pad family of products, it combines a graphical user interface with a touch-sensitive screen to simplify test setup and reduce test configuration time. The “smart tester,” icon-driven interface is easy to learn, and the large display screen provides ample space for displaying test results. Figure 1 shows the 2310.

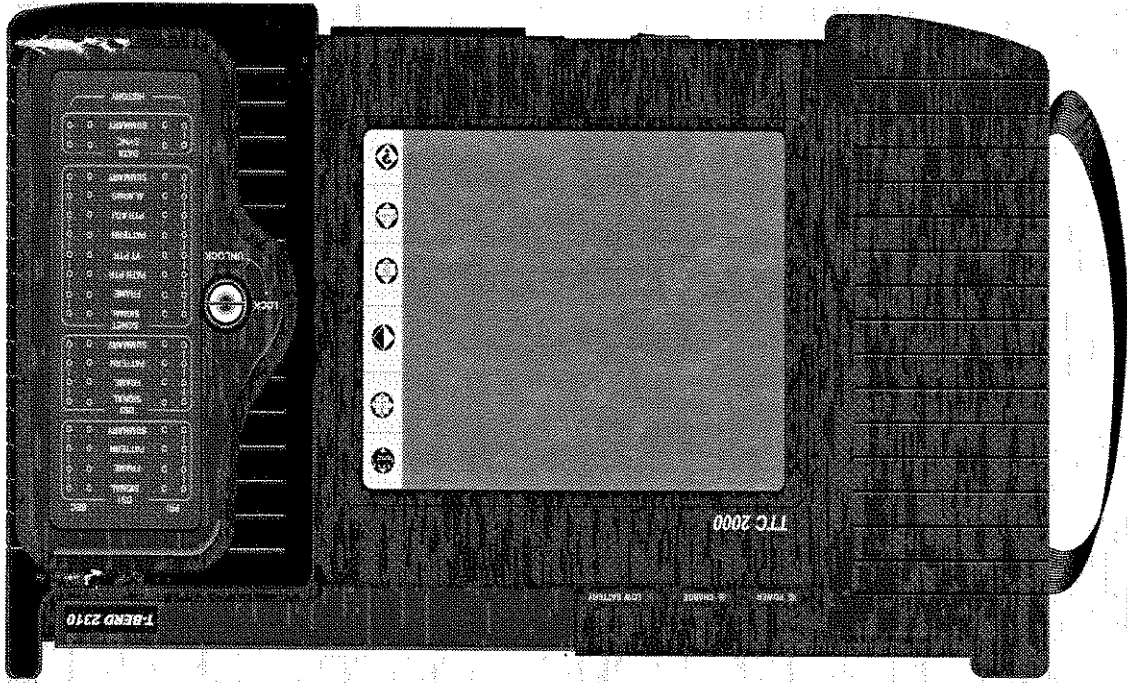

Figure 1 — The 2000 Platform 2310 module

Features and capabilities

Even though the 2310 weighs only 5 pounds, it provides integrated test capabilities:

- DS1, DS3, and SONET interfaces
- Standard Dual Receive for DS1
- Dual Receive for DS3, and STS-1 (optional)
- OC-3, OC-12, and OC-48 interfaces (optional)
- DS0, DS1, Muxed DS3, and VT1.5 in SONET testing
- Controls and Results Print capability
- Monitor/Thru and Terminate applications for DS1, DS3, STS-1, OC-3/OC-12/OC-48 interfaces
- DS1, DS3, and SONET (OC-3/3c, OC-12/12c, OC-48/48c) BERT patterns
- DS1 Unframed, D4, ESF and SLC 96 framing, T1 BERT, VF tone testing, and insertion of frame, BPVs, and logic errors
- DS3 Unframed, M13, C-bit BERT or Muxed DS3 testing, internal or recovered timing, RX/TX at HIGH, DSX, and LOW levels, insertion of frame, BPVs, and logic errors, as well as, FEBE and yellow alarm emulation
- SONET SPE Payloads (Async DS1 mapping, DS3 mapping, full SPE BERT), SPE pointer manipulation, K-byte manipulation, STS-1 RX/TX at HIGH, DSX, and LOW levels, insertion of Line and Path AIS alarms, FEBE, LOP, and BIP errors, as well as frame, logic, and BPV (STS-1 only) errors, and TX/RX path trace for viewing
- On-Line Help

Options

The touch-screen user interface enables these test capabilities in an easy, step-by-step manner:

- Primary Rate ISDN analysis: part number TB2310-PRI

This option adds Primary Rate ISDN testing capabilities for DS1, DS3, and STS-1. It enables the ability to place and receive multiple voice/data calls, perform D channel backup, support NFAS, and monitor the circuit via D channel decodes. It also supports AT&T SESS, NT DMS100 and NI-2 call controls, as well as, supports multiple call types such as voice, 56K, 64K, Nx64, Nx56, and H0.

- GR-303 analysis: part number TB2310-GR303

This option includes the ability to verify the connectivity of the TMC/CSC and EOC management channels. It also verifies report-call setup and teardown information.

- Advanced stress patterns: part number TB2310-ASP

This option adds the ability to transmit and receive fixed, long patterns beyond the standard patterns offered in the test set. The seven T1 stress patterns that are added to the 2310 are designed to stress test the timing recovery circuits and span-time repeater ALBO circuitry. The seven patterns include: T1-DALY, 55 octet, 2-96, 3-54, 4-120, 5-53, and MIN/MAX.

- Fractional T1 analysis: part number TB2310-FT1

This option provides fractional T1 modes for contiguous and noncontiguous, 56KxN and 64KxN, and FT1 testing capabilities. This option enables complete qualification and testing of new FT1 circuits before connecting customer premises equipment. The V.54 FT1 loop code is also added to the features list and allows for single-set testing of FT1 circuits from a convenient T1, DS3 or STS-1 access point.

- **DDS Analysis:** part number TB2310-DDS
This option provides TI DDS modes for 56K and 64K DDS circuits. It enables complete qualification and testing of new DDS circuits using the DDS1-6, 63, 511 and 2047 stress patterns. The OCU, DSO-DP, CSU, and Channel loop codes allow for single-set testing of DDS circuits from a convenient TI access point.
- **Signaling Analysis:** part number TB2310-SIG
This option enables you to test the ability of a switch/PBX to handle incoming calls and allows you to emulate switch-to-switch communications. You can place, receive and monitor calls over several trunk types. Features include the ability to send and receive DTMF/MF/DP digits to and from switches and PBXs, as well as the ability to measure inter-digit delay and digit/tone duration.
- **VF PCM TMS Analysis:** part number TB2310-VF
This option enables the 2310 to perform a frequency sweep test to quality VF circuits. Features such as noise measurements including SNR, C-Message, C-Notch, 3k-Flat, and 3k-Notch are also part of this option. Voice Drop, variable tone, level insertion, and level frequency results are standard with the 2310.
- **VT100 Emulation:** part number TB2310-VT100
This option enables the 2310 to emulate a VT100 terminal. The option includes an RS-232 interconnect cable.
- **Intelligent Line Equipment Analysis:** part number TB2310-ILE
This option provides the ability to loop up and loop down individual TI addressable office repeaters, line repeaters, and to transmit maintenance switch commands. Additionally, you can loop up and loop down HDSL line units, doublers, and remote units. Supported TI equipment include units by Telrad, Westell, and XEL. Supported HDSL equipment include units by Adtran and PatGain.

- OC-3c and OC-12c ATM Analysis: part numbers TB2310-ATM-OC3 and TB2310-ATM-OC12

This option provides OC-3c and OC-12c ATM test functionality for the 2310. This option enables the 2310 to transmit and receive ATM cell streams with different VPI/VCI addresses, measure ATM QoS parameters like dropped cells, mis-inserted cells, and out-of-sequence cells. It automatically identifies multiple cell streams on an ATM circuit, allowing complete qualification and testing of new ATM circuits before connecting customer premises equipment and/or Network Elements.

System requirements

The 2310 is a hand-held tester that is designed around a powerful and flexible 2000 Test Pad architecture, which includes a touch-sensitive screen that supports various application modules. The modular design enables the 2000 Test Pad to easily convert from one test technology to another.

The modular design includes a 2000 Test Pad for simple release and swapping of application modules (see Figure 2). The 2310 also comes with a hand strap that can be mounted on the left side of the test pad.

Hardware requirements

The LED display for Primary and Secondary DS1/DSS3/SONET signals in both current and history is also depicted.

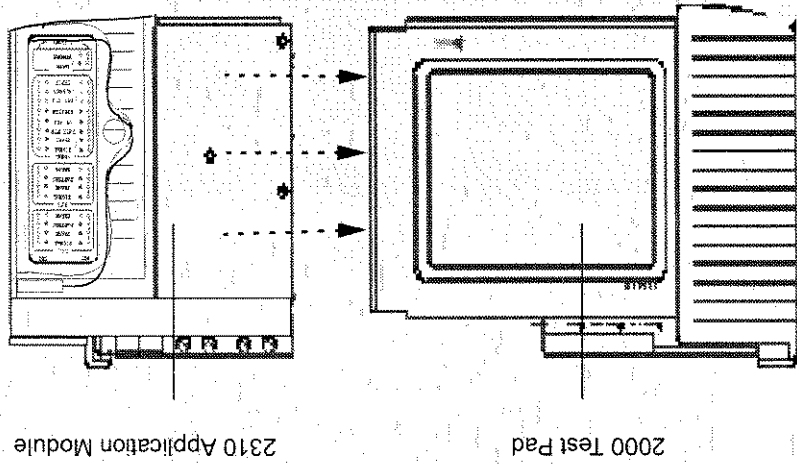

Figure 2 — 2000 Test Pad and 2310 module

Physical description

Front-panel features
 The 2310 provides transmitters and receivers for DS1/DS3/SONET circuit analysis and offers a touch-sensitive liquid crystal display (LCD) for test configuration and results selection (see Figure 3).

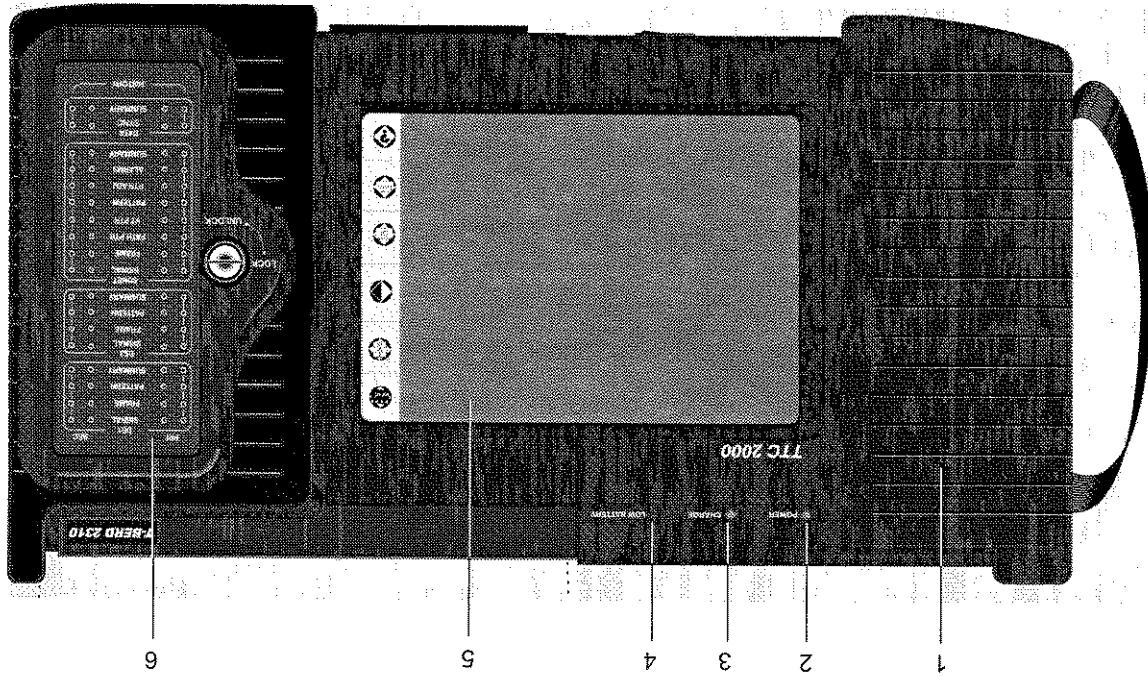

Figure 3 — 2310 front panel

Callouts in Figure 3 are described in Table 1.

Table 1 — Front-panel features

#	Item	Description
1	Speaker	Provides audio output for active voice calls.
2	Power LED	Illuminates when power is supplied either from the battery or the AC power adaptor.

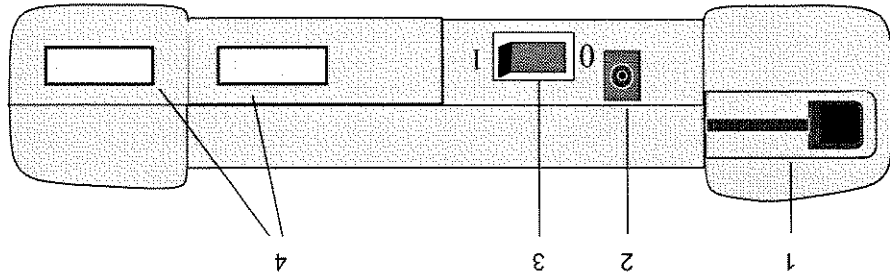

Figure 4 — The 2310 bottom panel

Bottom-panel features

The 2310 bottom panel provides the power switch, AC adaptor plug, and battery access panel (see Figure 4).

a. The charging LED is not always on when plugged into the AC adapter. If the battery is above 85% charged, the charging LED blinks. If the battery is above 95%, the charging LED does not illuminate.

#	Item	Description
3	Charging LED ^a	Illuminates when the battery is charging. The battery charges when AC power is connected to the unit. However, if performing an optical test, the battery does not recharge.
4	Low Battery LED	Illuminates when only 25% or less of battery power remains. Use the AC power adaptor to recharge the battery and continue testing.
5	LCD	Divides into two, touch-sensitive screen areas for test configuration and test results display. Refer to Section 2 for a detailed description of the LCD and how it works.
6	LED display panel	Illuminates whenever physical errors from the signal, frame, or pattern appear in the Summary Result Window of the LCD for DS1, DS3, and/or SONET signals.

Table 1 — Front-panel features (continued)

Physical description

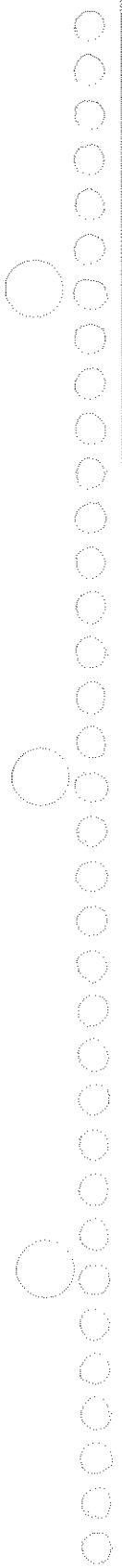
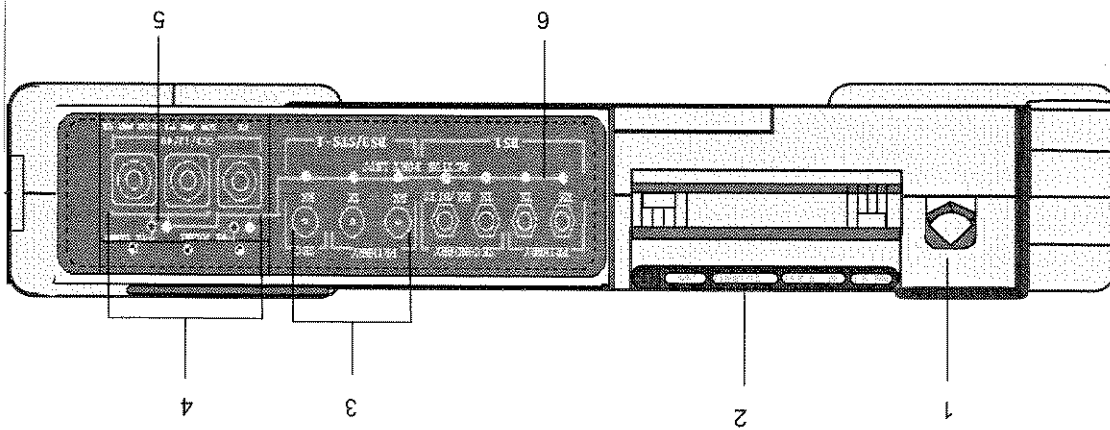

Figure 5 — The 2310 top panel



The 2310 top panel provides the printer connector, Dual-PCMCIA card slot, and DS1/DS3/SONET connections (see Figure 5).

Top-panel features

#	Item	Description
1	Battery Access Door	Provides access to the rechargeable battery compartment.
2	Adaptor Plug	Connects an 18 VDC connector to the AC Power Adaptor.
3	Power Switch	Turns the test set on or off.
4	Bottom Vent	Allows air to circulate through the module to the side-mounted fan.

Table 2 — Bottom-panel features

Callouts in Figure 4 are described in Table 2.

Table 3 describes the top panel of the test unit.

Table 3 — Top-panel features

#	Item	Description
1	Printer Connector	Provides the connection for a serial printer (PR-40A/B) for printing the test configuration and test results.
2	Dual-PCMCIA Card Door/Slot	Allows for software upgrades via two Type II PCMCIA cards or one Type III PCMCIA card.
3	DS1/DS3/STS-1 Primary and Secondary RX & TX Jacks	Supplies the DS1 and DS3/STS-1 connections to the Primary and Secondary Receiver and Transmitter.
4	OC-3/OC-12/OC-48 RX & TX Jacks	Connects the OC-3, OC-12, and OC-48 connectors to the SONET Receiver/Transmitter via the FC, SC, or ST jacks.
5	Active Port LEDs	Illuminates yellow to indicate which specific jack is active as designated by the test setup.
6	RX Pulse and TX Laser LEDs	Illuminates red when RX Pulse LED optical power is received. TX Laser LED illuminates red when the 2310 laser transmits an optical signal.

Interface connector layouts

The 2310 top panel provides six external interface connector layouts:

- Dual DS1 RX
- Dual DS1/DS3 RX or Single DS1/DS3 RX
- Dual DS1/DS3/STS-1 RX or Single DS1/DS3/STS-1 RX
- Single OC-3 with Dual DS1/DS3/STS-1 RX or with Single DS1/DS3/STS-1 RX
- Single OC-3/OC-12 with Dual DS1/DS3/STS-1 RX or with Single DS1/DS3/STS-1 RX
- Single OC-3/OC-12/OC-48 with Dual DS1/DS3/STS-1 RX or with Single DS1/DS3/STS-1 RX

Figure 6 depicts the external interface connector layouts for the 2310.

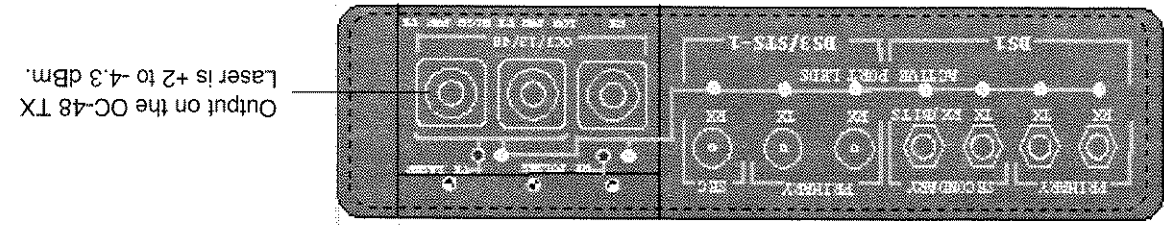
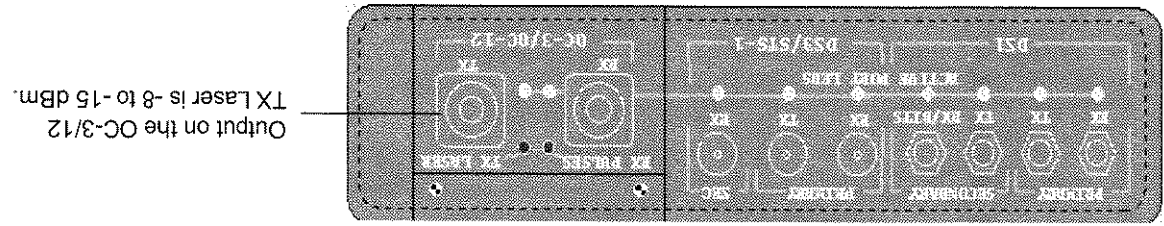
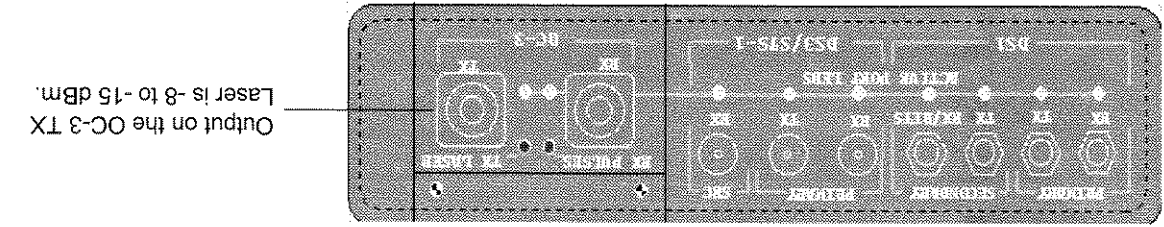
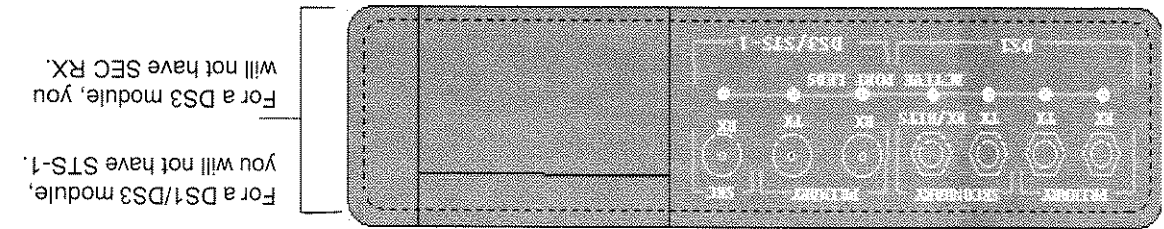

Figure 6 — Available interface connectors

3/OC-12/OC-48 with Dual DS1/DS3/STS-1 RX or with Single DS1/DS3/STS-1 RX

Single OC-3/OC-12 with Dual DS1/DS3/STS-1 RX or with Single DS1/DS3/STS-1 RX

Single OC-3 with Dual DS1/DS3/STS-1RX or with Single DS1/DS3/STS-1 RX

Dual DS1/DS3/STS-1 RX or Single DS1/DS3/STS-1 RX

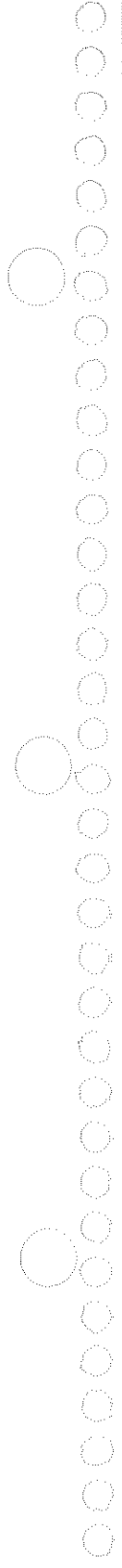

Operation

2

This chapter describes the 2310 instrument and graphical user interface (GUI) functionality. Topics discussed in this chapter include the following:

- "About operating the 2310" on page 14
- "Using the front panel" on page 14
- "Working with the 2310 user interface" on page 21
- "Working with application setup property sheets" on page 28
- "Operating the printer" on page 31
- "Getting started" on page 36

2

Chapter

About operating the 2310

As a member of the 2000 Test Pad™ family of products, the 2310 combines a GUI with a touch-sensitive screen to simplify test setup and reduce test configuration time. The “smart tester,” icon-driven interface is easy to learn, and the large display screen provides ample space for displaying test results. When you activate the 2310, it displays the main screen (see Figure 8 on page 21), which is the application configuration area.

Using the front panel

LCD functional description

There are two LCD types:

- Active-Transmissive Color LCD (on P/N TTC 2000-C)
- Transflective-Monochrome LCD (on P/N TTC 2000-XF)

The active-transmissive color display gives improved viewing angle, brightness, and clarity. We recommend the transflective-monochrome display if you frequently use the test pad in high-ambient lighting conditions, such as full sunlight.

LCD features

2000 color and transflective-monochrome LCD features include the following:

- Brightness-control extended softkey for the color display
- Contrast-control extended softkey for the transflective-monochrome display
- Two gradients of brightness

Extended permanent softkeys



There are six permanent softkeys located off the right side of the main screen that provide housekeeping functions for the 2310. Depending on the application module option, one of the sets of softkeys displays. These softkeys are shown in Table 4 and Table 5 with accompanying

descriptions of their functions. You can also see the softkeys in relation to the main screen as callout number 4 in Figure 8 on 21.

Table 4 shows the extended softkeys for the color display.

Color display

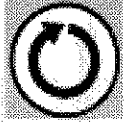
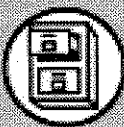
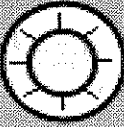
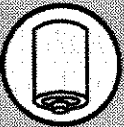
Table 4 — Color extended softkey icons

Icon	Description
	Restart — Performs the test restart function, including resetting the current test result totals and clearing any errors and/or alarms.
	File — Activates the Auxiliary Functions screen, which allows you to view the software revision level and installed options and to set the volume, time and date, and brightness. It also provides access to the VT100 Emulator when the VT100 option is installed.
	Brightness — Adjusts the brightness on the color screen display. There are two gradients of brightness: Low brightness (maximizes battery life) High brightness (enhances viewing)
	Battery Status — Activates the Battery Status screen, which displays the current battery strength.
	Printer Setup — Activates the Printer Setup screen, which enables you to select the printer interface parameters (Baud Rate and Parity), clear the print buffer, print results, or abort printout.
	Help (?) — Launches the Help system.

**Transflective-
monochrome display**

Table 5 shows the extended softkeys for the transflective-
monochrome display:

Table 5 — Transflective-monochrome extended softkey icons





Icon	Description
	Restart — Performs the test restart function, including resetting the current test result totals and clearing any errors and/or alarms.
	File — Activates the Auxiliary Functions screen, which allows you to view the Software Revision Level and Installed Options, and set the Speaker Volume, Time and Date, and Brightness. It also provides access to the VT100 Emulator when the VT100 option is installed.
	Contrast — Adjusts the level of detail on the screen display. Pressing the left side lightens images, and pressing the right side darkens images.
	Battery Status — Activates the Battery Status screen, which displays the current battery strength.
	Printer Setup — Activates the Printer Setup screen, which enables you to select the printer interface parameters (Baud Rate and Parity), clear the print buffer, print results, or abort printout.
	Help (?) — Launches the Help system.

Figure 7 — LED display for Current/History signal alarm

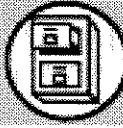

LED display panel

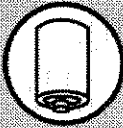
The Current/History error LED display panel illuminates to visually display the performance of the test being performed. Figure 7 depicts the LED display panel.

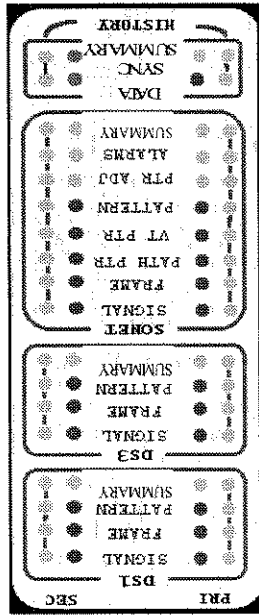
NOTE:

The only difference between the extended softkeys of the two touch-screens is the Contrast (transflective-monochrome) and Brightness (active-transmissive color) icons.

NOTE:

Your LED panel may be a subset of the one in Figure 7, depending on what option-equipped 2310 module is purchased. For example, a DS1 Module will not have SONET LEDs.

The red alarm LEDs provide information about the current and historical alarm conditions related to the received signal. These LEDs are divided into two columns (Current and History). When the current alarm condition is cleared (e.g., pattern sync reestablished), its History LED illuminates. The History LEDs are located on the outside column and indicate past occurrences of the alarm and remain illuminated until a test restart occurs.

The inside "green" LEDs for Signal, Frame, Pattern, and Path/VT PTR (SONET only) are key to knowing the Current status of the test, and you need to wait to see if they illuminate when performing a test. If any one of these conditions is lost while performing the specified test, a History red LED illuminates and the green Current LED light extinguishes. The remaining Current LED lights are red (ERRORS, ALARMS, PTR ADJ) and illuminate when errors are present in the Current test, then change to History when error alarm is removed. Table 6 describes the green status LEDs.

Table 6 — Green Status LEDs

LED	Description
SIGNAL	Recognizes a signal is present.
FRAME	Establishes synchronization with the framing of a signal.
PATTERN	Establishes synchronization with the pattern of a signal.
PATH & VT	Receives a valid pointer with SONET pointer bytes and VT pointer bytes.
SYNC	Receives six consecutive ATM cells with an unerrored HEC field.

Table 7 describes the Red Alarm LEDs.

Table 7 — Red Alarm LEDs

LED	Description
DS1	
SIGNAL	Displays an alarm if DS1 signal is lost.
FRAME	Displays an alarm if DS1 frame synchronization is lost.
PATTERN	Displays an alarm if DS1 pattern synchronization is lost.
SUMMARY	Displays an alarm if an error has been recorded by the unit, as shown in the DS1 Results Summary window.
DS3	
SIGNAL	Displays an alarm if DS3 signal is lost.
FRAME	Displays an alarm if DS3 frame synchronization is lost.
PATTERN	Displays an alarm if pattern synchronization is lost.
SUMMARY	Displays an alarm if an error has been recorded by the unit, as shown in the DS3 Results Summary window.
SONET	
SIGNAL	Displays an alarm if SONET signal is lost.
FRAME	Displays an alarm if SONET frame synchronization is lost.
PATH PTR	Displays an alarm when the path pointer byte is lost after initial synchronization.
VT PTR	Displays an alarm when the virtual tributary overhead path pointer byte changes after initial synchronization.
PATTERN	Displays an alarm if pattern synchronization is lost.
PTR ADJ	Displays an alarm if overhead path pointer byte pointer adjustments are recorded.
ALARMS	Displays an alarm when an AIS (blue alarm) or RDI (yellow alarm) is detected since the last test restart or history reset.
SUMMARY	Displays an alarm if an error has been recorded by the unit, as shown in the SONET Results Summary window.

LED	Description
SYNC	Displays an alarm if ATM synchronization has been lost. Synchronization loss is characterized by reception of at least seven consecutive errored HECs after cell synchronization.
SUMMARY	Illuminates when an ATM error has been recorded by the unit, as shown in the ATM Results Summary Window.

Table 8 — DATA Category Red Alarm LEDs

Table 8 describes the Red Alarm LEDs for the DATA Category.

LED	Description
SYNC FAILURE	Indicates synchronization loss is present for 2.5 seconds. This clears when cell synchronization is regained and loss of synchronization has not occurred in 10 seconds. This is equivalent to a loss of cell delineation failure (LCD failure) indication.

Table 7 — Red Alarm LEDs (continued)

Working with the 2310 user interface

The main screen is divided into eight areas (see Figure 8). The main screen is used to provide setup and configuration data and to display test-specific action buttons.

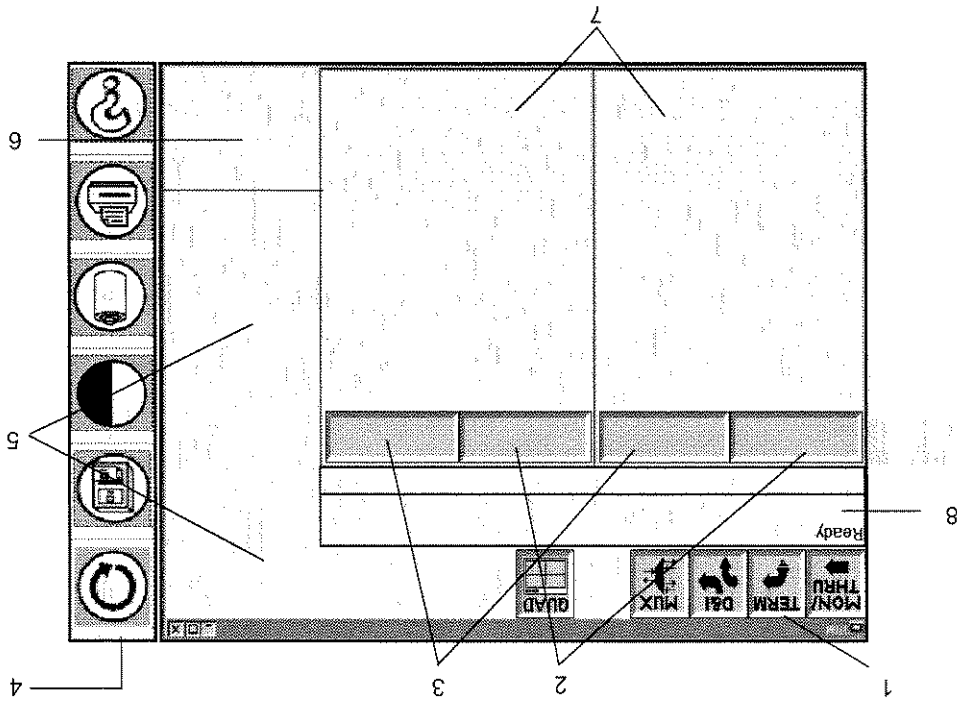

Figure 8 — Main screen and extended softkeys

Each area has a function, as described in the following paragraphs:

- 1 **Application icon selection** — This area displays the **MON/THRU** (Monitor and Through), **TERM** (Terminate), **D&I** (Drop and Insert), **MUX** (Multiplexer), and **QUAD** (Quadrate Split Screens) icon buttons used to select a test application. Refer to Figure 9 for a display of the icons and their associated pull-down menus.
- For **MON/THRU** modes, the timing of the interface is set to recovered and the data is passed from the primary receiver to

the primary transmitter, unchanged, except for automatically correcting BPs and SONET BIPs.

THRU mode allows error and alarm insertion to be performed. Outside of changing test applications for output levels, the transmit data stream does not fluctuate when you change setups or restarts. If installed and applicable to the test, the secondary receiver is active and collects results.

For **TERM** mode, unless otherwise noted by special test operations (such as loop backs), the transmitter and receiver are entirely independent except for setup. If a secondary receiver is activated (for DS1, DS3/STS-1), results are collected on that receiver.

DS1 mode allows for in-service testing of one channel (DS0) from a higher rate signal (DS1). Example: Place a call on one channel while allowing the T1 to remain operational.

MUX mode allows for simultaneous testing of two signals. Example: Transmit a T1 signal and Receive an OC-3 signal.

QUAD results is a results function that displays up to four embedded signal rates at once in the Results Window of the 2310. For example, by pressing the Quad Results icon, you could monitor a STS-1 signal with a DS3 mapped payload, a T1 signal, and measure the VF tone within a specific DS0, in both the primary and secondary directions (if the dual Rx option is installed).

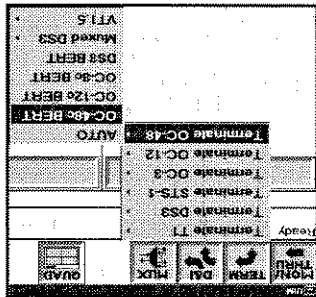

Figure 9 — Application icons with pull-down lists

2 Result Group display — The first button in this dual-feature display depicts a pull-down list of the current test results, and lets you change the *source* between the Primary and Secondary receivers, such as T1 Pri (T1 Primary), T1 Sec (T1 Secondary), DS3 Pri, DS3 Sec, SONET Pri, and SONET Sec (see Figure 10).

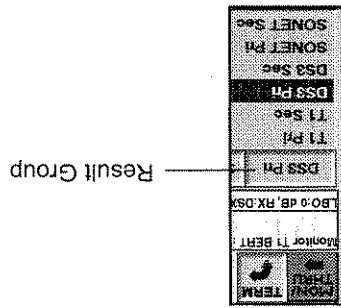

Figure 10 — Results Group selection on main menu screen

3 Results Category display — The second button in this dual-feature display offers a pull-down list allowing you to choose test results in numerous *categories*. Categories change according to the application selected. Figure 11 shows an example of categories listed for SONET applications.

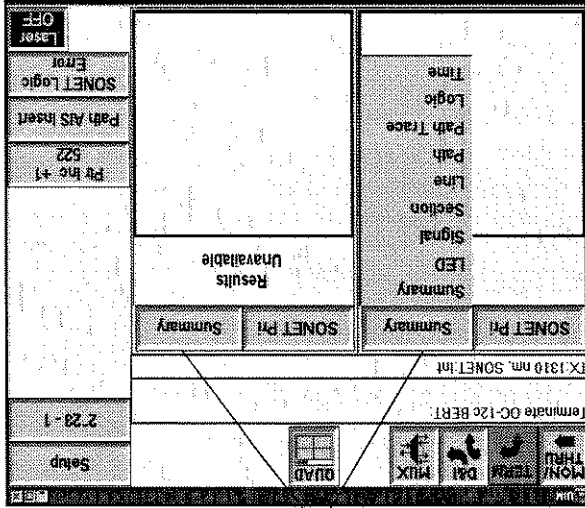

Figure 11 — Pull-down list in Results Category

Descriptions of the categories available are as follows:

- **Summary** — This is the default category that automatically displays results that are non-zero or out-of-specification.
- **LED** — Selection of this category activates the Signal Alarm LEDs display. Two columns of LEDs reflect the current and history condition for each alarm. When an alarm first occurs, the appropriate current LED illuminates and remains illuminated until the condition clears. If the condition clears, the History LED for that alarm illuminates and the current LED is extinguished. If the condition occurs again, the current LED illuminates and the History LED remains illuminated to show the condition also occurred in the past.
- **Signal** — The Signal category results include signal losses, frequency, level, and power measurements. Timing slips, as well as BPVs for STS-1 applications, are also recorded in this category.
- **BPV** — Bipolar Violations are caused by successive pulses with the same polarity being detected (except those pulses that are part of the B8ZS encoding). Bipolar violation results are accumulated when the signal is present.
- **Frame** — Frame errors are based on counting framing bits and identifying frame errors in the incoming signal after initial frame synchronization. The results are available whenever the receiver detects a valid framed signal, regardless of the transmitter framing mode. For DS3 analysis, DS2 frame errors and FEAC history are recorded here. CRC errors found in DS1 analysis are also recorded in this category.
- **Logic** — Logic errors are based on discrepancies between the transmitted and received bit stream. The accumulation of logic errors is dependent on frame synchronization (if in a framed mode) and pattern synchronization. During loss of frame or pattern synchronization, the accumulation of errors halts. Pattern losses and slips are also recorded under this category.

- **Channel** — The Channel category displays the result associated with the DS0 channel under test.
 - **Parity** — Parity errors are based on detecting whether bits of data have been altered during transmission of that data. Parity errors, C-bit errors, and FEBEs are recorded in this category.
 - **Section** — The Section category is only available when performing SONENT testing. Frame errors and Section BIP errors are recorded in this category.
 - **Line** — The Line category is only available when performing SONENT testing. Here, APS and Pointer analyses are recorded, as well as Line BIP errors and Line FEBEs. These measurements are available once SONENT frame synchronization has occurred.
 - **Path** — The Path category is present when performing SONENT testing. Path BIP errors and FEBEs, as well as viewing the Path Trace, are recorded in this category. SONENT frame synchronization is required before results can be obtained.
 - **VT** — The VT category is active when performing VT analysis. VT BIP errors and FEBEs are recorded here as well as VT pointer analysis. SONENT frame synchronization must be established prior to recording these results.
 - **Path Trace** — SONENT Path Trace displays the path trace byte (J1) of the STS-1 signal under test.
 - **Traffic** — The Traffic category displays results for all 24 DS0 time slot or channel signaling bits and channel assignments.
 - **Call Sig** — The Call Signal category is active when placing, receiving, and monitoring a call. It displays supervisory events, digits, and their associate parameters.
 - **Time** — The Time category shows elapsed time of the test, current date, and time.
- 4 **Permanent softkeys** — This area includes six permanent softkeys that provide housekeeping functions for the 2310 (see “Transflective-monochrome display”, on page 16).

- 5 **Quick Configuration softkeys** — These multiple configuration buttons display setups based upon the type of test initiated. Only those pertaining to the specific test display, depending on what test application you choose. The following figures show two depictions; Figure 12 is a diagram showing various possible configurations, while Figure 13 shows real-time usage. Refer to “Working with application setup property sheets” on page 28 for information on how these buttons apply to the property sheets.
- 6 **Action softkeys** — These action buttons are designed to take specific action during a test to initiate and measure the test (see Figure 12 and Figure 13).

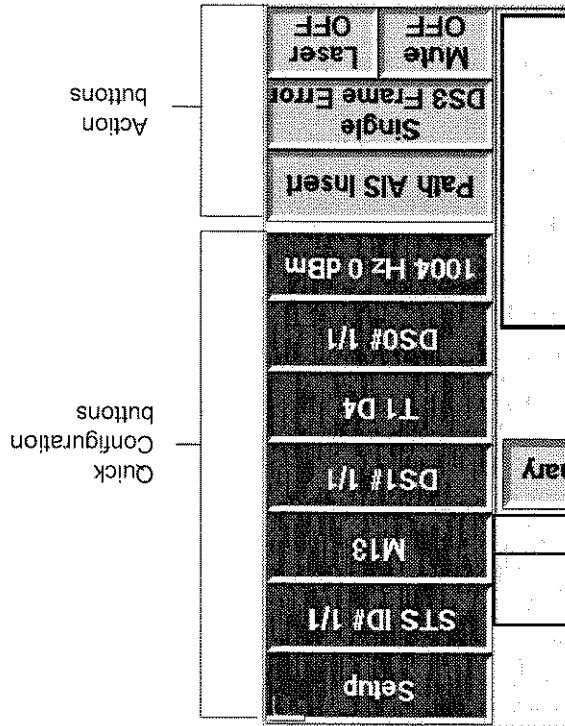
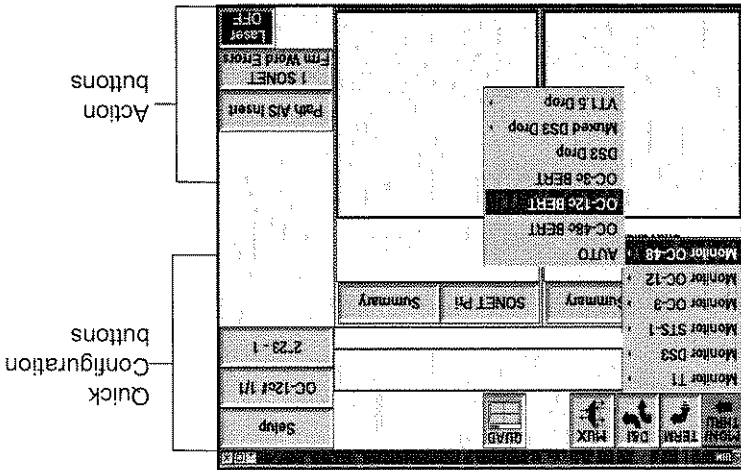

Figure 12 — Quick Configuration/Action buttons

7 **Dual-Test Results display** — This area (see Figure 14) displays two test results windows associated with the current test application. Each window has a button for selecting the Result Group and a button for selecting the Result Category. Figure 14 shows a sample depiction of the Dual-Test Results display.

Figure 13 — Sample Configuration/Action button usage



Working with application setup property sheets

When any of the Quick Configuration buttons are pressed, setup property sheets (which are tabulated for subsequent choices) appear on the LCD. These property sheets consist of a Setup Summary (see

In the example above (see Figure 14), the Message Display indicates that the test pad is in Terminate OC-12c BERT state, set up to test SONE1 Internal Timing, using the SONE1 Primary receiver as its source for results. The bit errors and BIP errors in the Result Value window appear after you choose that selection from the Result List.

- **Setup** — Shows what part of the segment is being tested.
 - **Test State/Status** — Shows the current test application.
- displays messages regarding activity associated with the current test application. The message display is comprised of:
- 8 **Message display** — This area (see Figure 8 and Figure 14)

Figure 14 — Dual-Test Results display (labeled)

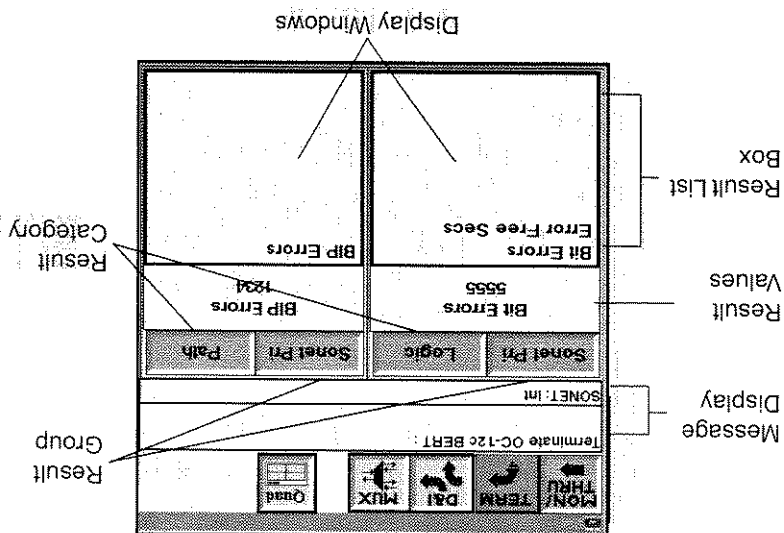

When pressed, the Setup configuration key prompts a Summary sheet that allows you to confirm the configuration of the test set matches the test to be performed. Behind the Summary sheet, there are tabs of additional setup sheets that prompt you to set additional parameters for the test application. Figure 16 shows a random sampling of property tabs within the property sheets.

Figure 15 — Setup Summary property sheet

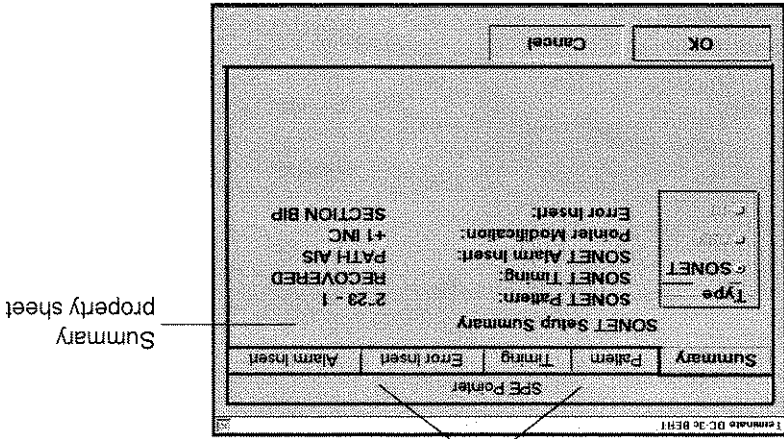

Property sheet tabs for setting additional test parameters

Figure 15) and tabulated property sheets (see Figure 16) that provide the parameters for all test settings not already determined by the test application (default settings).

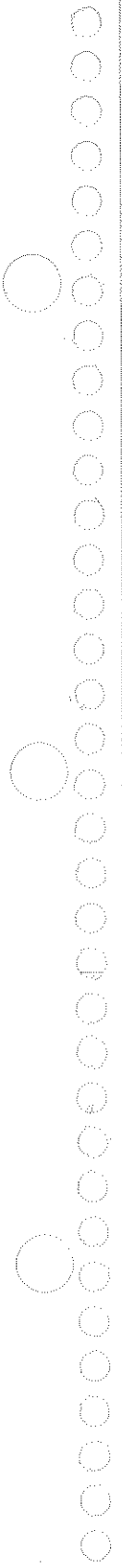

Remember to press **OK** on the property sheet to set the value. You can also cancel the settings by pressing **CANCEL**. If you have multiple property sheets to set, it is not necessary to press **OK** until the last parameter is set.

NOTE: Using the Setup property sheets disables the extended digitized soft-keys (**RESTART**, **PRINT**, **FILE**, **BATTERY**, **CONTRAST**, and **HELP**).

Figure 16 — Property sheet tabs set test parameters

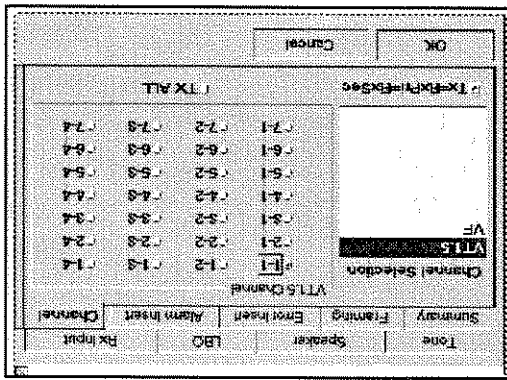

The Channel property sheet tab displays after selecting the Setup configuration button (for Monitor VT1.5 VF in OC-3).

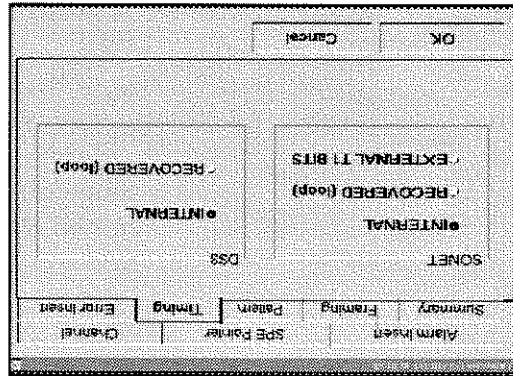

The Internal Timing property sheet tab displays after selecting the Setup configuration button (for Terminate DS3 Bert in OC-3).

Operating the printer

The 2310 provides print capability for both test configuration (Controls Print) and test results (Results Print). This section describes each of the printouts and how to generate them using the Print feature. The 2310 can generate a printout manually or automatically (via timed and errored event prints). When a results printout is initiated either manually or automatically, the test results are dumped to the print buffer.

Setting up the printer

The following connections and controls are used to set up the printer and the 2310.

Connecting the printer

The printer connector on the top of the mainframe is an 8-pin connector used to connect the 2310 to a serial printer like the Acterna PR-40A/B. The connector is configured as a Data Communications Equipment (DCE) connection, which allows you to connect the 2310 to Data Terminal Equipment (DTE).

Settings

The 2310 printout generation is controlled through the Printer Screen (see Figure 17), which is activated by pressing the Printer permanent softkey on the right side of the main display.



The print function displays three property sheets:

- **PRINTOUTS** — Enables you to generate and print current results, print the configuration of controls that generated the test results, and to preview the printout.

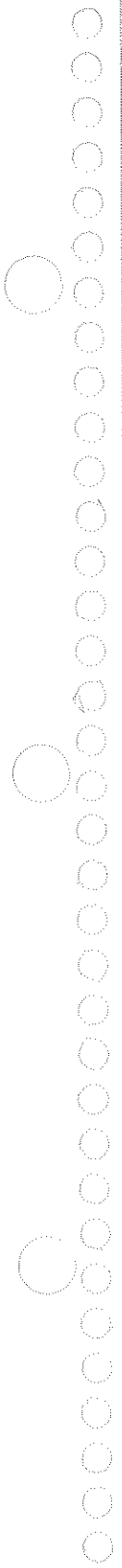

- **EVENTS** — Enables you to set timed result printouts, automatically create a Print File when an error is detected, and allows you to specify a test duration.
- **Printer Settings** — Enables you to select the baud rate and parity for the printer interface.

Using the PRINTOUTS
To use the Printouts property sheet, press the **Printer permanent** softkey. It is the first tab (see Figure 17) to exhibit.

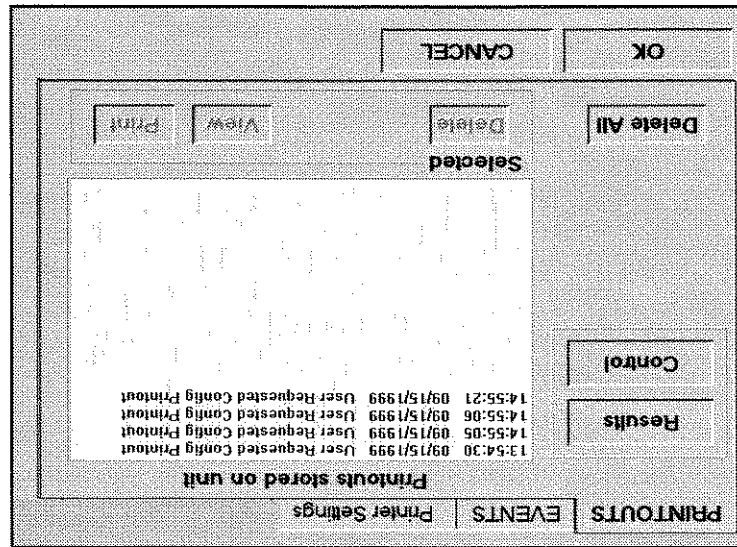

The Printouts tab displays all printouts that are currently stored on the 2310. The print buffer stores up to 20 printouts. After storing 20 printouts, the oldest printout is deleted if a new printout is added.

Figure 17 — PRINTOUTS property sheet

Table 9 describes the functions of the PRINTOUTS tab buttons.

Table 9 — Description of PRINTOUTS action buttons

Item	Description
Results	Generates a date-and-time, stamped printout of current test results. Test results become available only after the 2310 has received a valid signal.
Control	Generates a date-and-time, stamped printout of the current test configuration. This printout includes the test application and parameters associated with the test setup.

Table 9 — Description of PRINTOUTS action buttons (continued)

Item	Description
Delete All	Deletes all print files contained in the print buffer of the 2310.
Delete	Deletes a selected print file contained in the print buffer of the 2310.
View	Previews each print file as it would be printed.
Print	Sends the selected print file contained in the print buffer to the 2310 external printer port. Select the appropriate file and press Print to send the file to the printer port.

To select a file in the Print Buffer, use your stylus and press the view button to review it (see Figure 18).

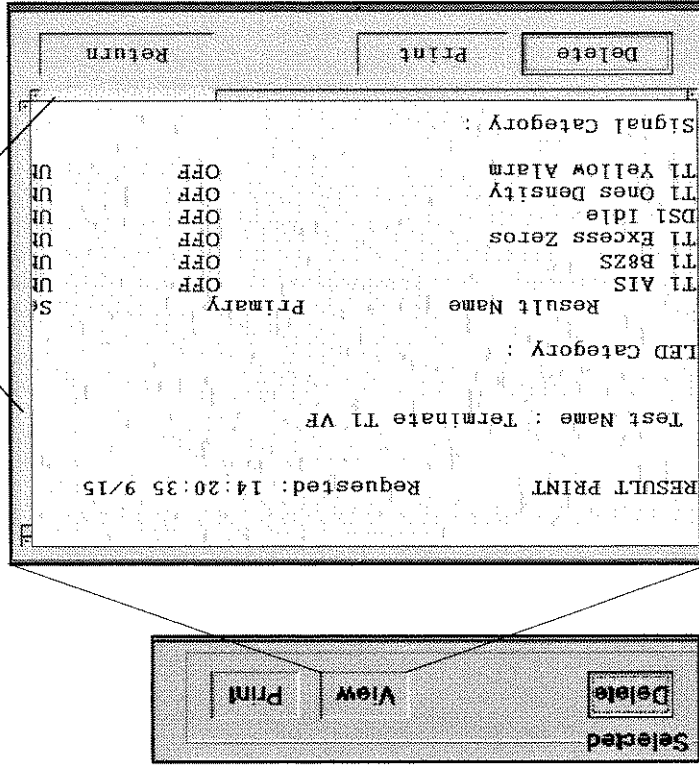

Figure 18 — Preview screen of files within print buffer

**Using the EVENTS
property sheet**

To use the EVENTS property sheet, press the **Printer** permanent softkey. Selecting EVENTS (see Figure 19) allows you to set timed result printouts, automatically create a print file when an error is detected, and allows you to specify a test duration before the 2310 creates a Results print file.

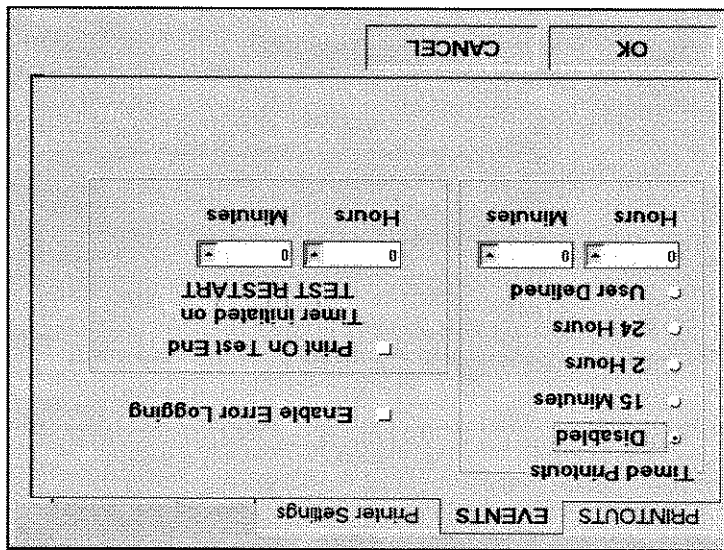

Figure 19 — EVENTS property sheet

Table 10 describes the choices on the Events property sheet.

Table 10 — Description of EVENTS property sheet

Item	Description
Timed Printouts	Allows results to be printed every 15 minutes, every 2 hours, every 24 hours, or at user-defined timed intervals. ^a
Enable Error Logging	Automatically creates a print file when an error is detected. The file will contain a time/date stamp and the type of error detected.
Print on Test End	Allows you to specify a test duration before the 2310 creates a Results print file.

a. If you select Disabled, printouts are performed manually only if you press Results or Control on the Printouts tab.

Using the Printer Settings property sheet
To use the Printer Settings property sheet, press the **Printer** permanent softkey. It allows you to select the baud rate and parity for the printer interface (see Figure 20).

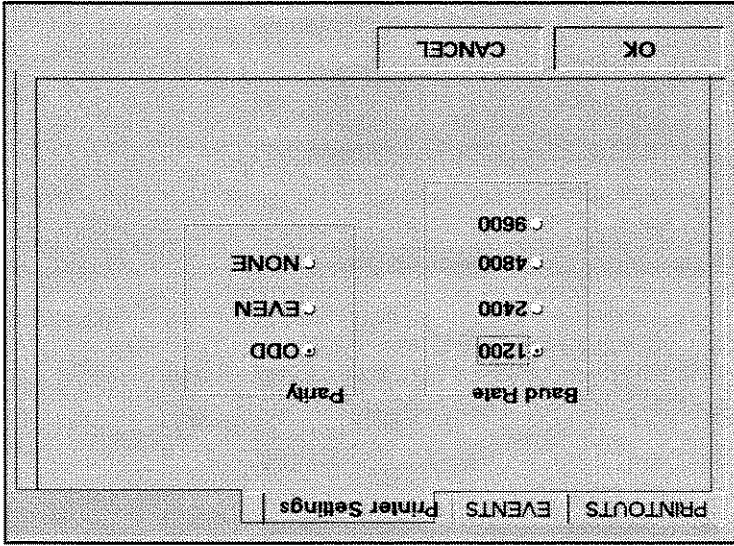

Figure 20 — Printer Settings property sheet

Table 11 describes the choices on the **Printer Setting** property sheet.

Table 11 — Description of Printer Setting property sheet

Item	Description
Baud Rate	Allows you to specify which baud rate (transmission speed) to set when printing a file.
Parity	Allows you to specify odd, even, or no parity before the 2310 creates a Results print file.

Getting started

Basic test setup

To operate the 2310, turn on the test set, wait for the main screen to appear, and then perform the following steps:

NOTE:

We recommend using the stylus supplied with the 2310 to activate functions on the touch-sensitive screen. However, any blunt device, including your finger, can be used.

- 1 Select an application icon, the first step of any test.

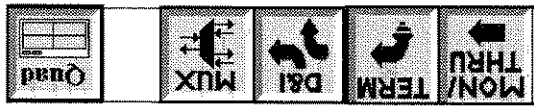

- 2 Select an application from the list of applications in the pull-down menu that appears when the icon is selected (you can choose up to three levels deep).

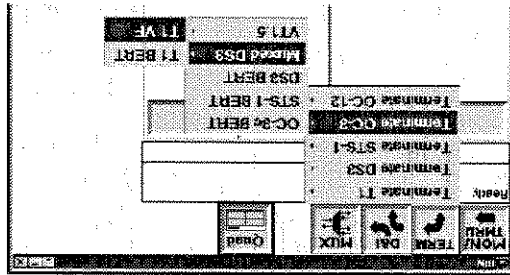

When you have reached the desired level of test setup, the unit automatically configures to a default starting point for testing.

- 3 The buttons below **Setup** in the configuration section show the current settings. To change a setting, press the appropriate button to go to the corresponding property sheet. (Remember, you can press **Setup** or any of the Quick Configuration buttons.)
- To check or change the configuration, press **Setup**, which replaces the main screen with the property sheets (which are tabulated for subsequent choices). These setup sheets consist of a setup Summary (see Figure 15 on page 29) and property sheets (see Figure 30) that provide the parameters for all test settings not already determined by a default test setup.
 - By pressing any of the tabs, you can immediately bring up the desired screen to set parameters. To change a parameter, press

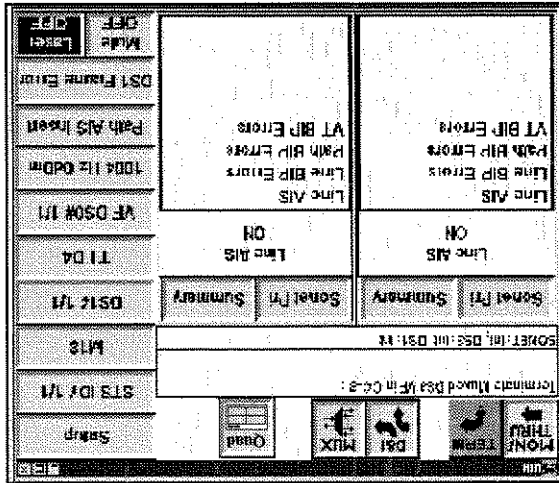

or click on the appropriate tab folder to move it to the front. Set the desired parameters accordingly.

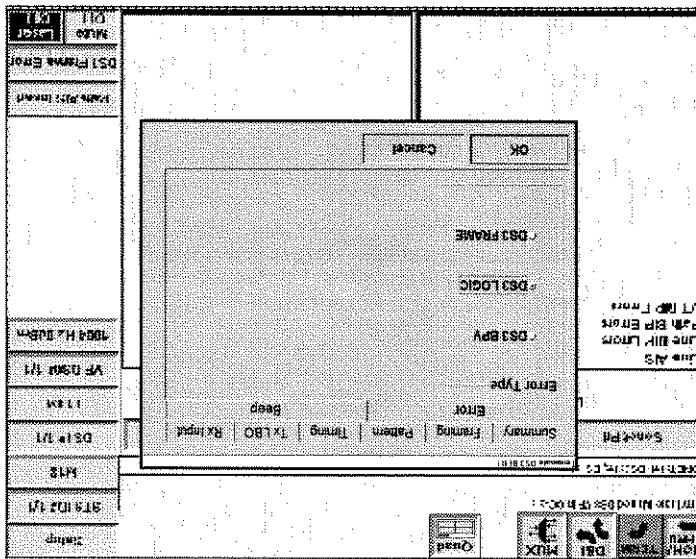

4 When all parameters are correct, connect to the circuit being tested using the Primary and/or Secondary TX and RX jacks. For instrument safety, we recommend connecting the cables to the 2310 first, then the circuit. Test results begin accumulating automatically.

5 For several applications, secondary action buttons appear in the Quick Configuration area. Press the appropriate button to perform the labeled function.

6 To clear alarms and begin testing, press the **RESTART** permanent softkey.



7 Observe the test results in the Dual-Test Results display. To observe specific test results, select the source receiver using the Result Group button, then press the Result Category button to reveal the list of categories. Press the desired category. The Test

Results List immediately shows all the test results in that category.

8 All available results are listed in the Test Results List, while the currently selected result is shown in the Test Result display above the list. Press a specific test result in the Test Results List to see it in the Test Result display.



NOTE:

The Dual Test Results display enables selection of two different categories to show on the screen.

Errored LEDs are illuminated by specific errored events that show up in the Summary Category (see Figure 11 on page 23). Refer to Table 14 on page 184 for the first of several tables describing LED results.

Some summary items illuminate a red error LED on the front panel when they appear in Summary. The possible error LEDs are DS1, DS3, and SONET. An LED that is not illuminated indicates that the result does not cause the error LED to light when present in Summary (see Figure 7 on page 17).

The 2310 comes equipped with a rechargeable Nickel-Metal Hydride (NiMH) battery. A fully-charged battery is good for about 1.5 hours of continuous use for electrical testing and 0.5 hours for optical testing. The recharge time is approximately 1.5 hours with the unit turned OFF. The recharge period begins as soon as an external AC or DC power supply is connected to the unit. Overcharge protection is provided, so continuous operation from an AC power supply is possible.

The Low Battery LED illuminates when the battery is at 25% of full charge to indicate the battery needs to be recharged.

Recharging the battery

Error LEDs

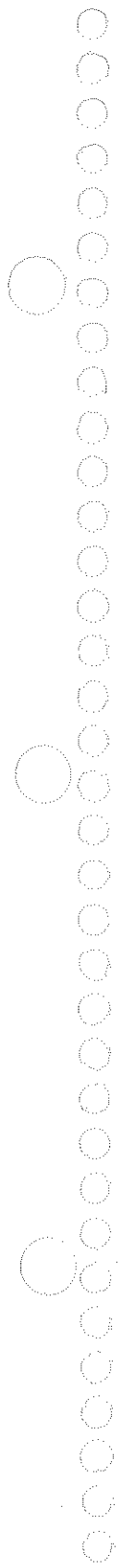

To fully charge the battery quickly, turn the unit off, connect the AC adaptor from the power adaptor plug to a 120 VAC power supply and let the 2310 sit for about 1.25 hours. The battery can also be charged by using the optional car adapter.

Battery replacement

The Nickel-Metal Hydride (NiMH) battery is easy to replace.

- 1 Turn off the 2310.
- 2 Tilt the unit onto the back panel. (The bottom panel faces you.)
- 3 Lift up the latch on the battery cover. Pull the battery out of the battery compartment. With newer 2000 UIMs, you will need to use a screwdriver to unscrew the battery cover latch.
- 4 Install the replacement battery by lining up the contacts and snapping it into place.
- 5 Secure the battery cover.
- 6 Turn on the 2310 and continue testing.

NOTE:

After 100 charge/discharge cycles, the battery performance may degrade.

Common Applications

Chapter 3

This chapter includes task-based instructions using the 23 10 options. Topics discussed in this chapter include the following:

- “Using the T1 option” on page 43
- “Using the Fractional T1 (FT1) option” on page 57
- “Using the DDS option” on page 67
- “Using the Signaling option” on page 77
- “Using the VF option” on page 91
- “Using the Intelligent Repeater Span option” on page 99
- “Using the DS3 option” on page 105
- “Using the STS-1 option” on page 113
- “Using the OC-3/OC-12/OC-48 option” on page 125
- “Using the VT100 Emulation option” on page 137
- “Using the OC-3c/12c ATM option” on page 141
- “Using the GR-303 option” on page 153
- “Using the ISDN PRI option” on page 161

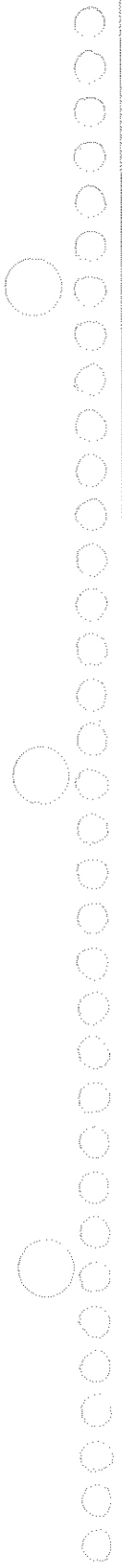

These setup procedures are the most commonly used tests for the 2310. As in any test, always configure the 2310 before connecting the test set to the circuit.

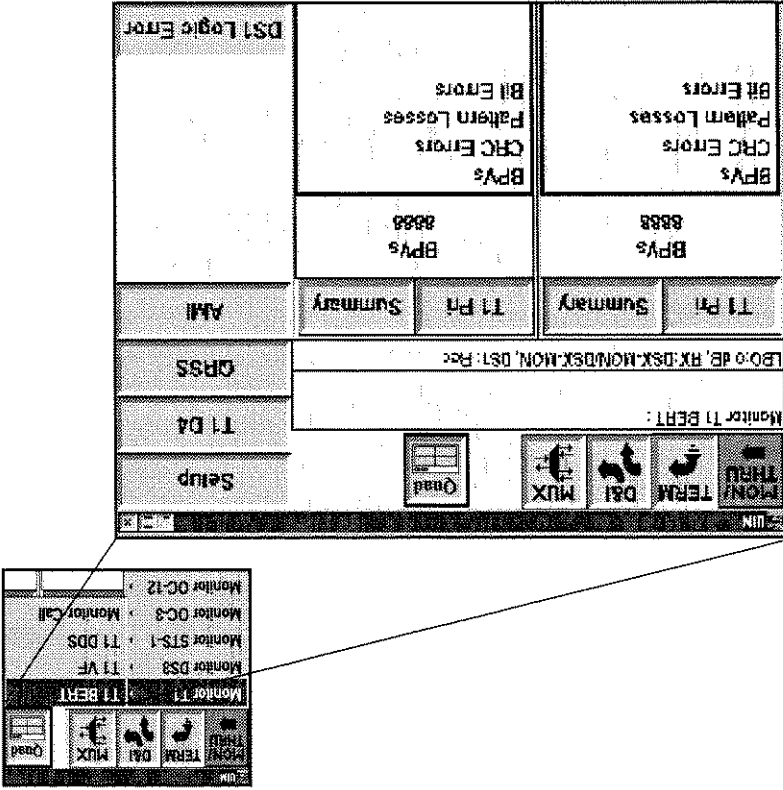

Monitoring T1 performance

This test allows you to monitor errors on a T1 circuit.

This option allows you to qualify T1 circuit error performance by testing for logic errors, BPVs, frame errors, and CRC errors (if applicable) on T1 lines.

Configuring the 2310

To perform monitor T1 BER testing

- 1 On the menu bar, press MON/THRU > Monitor T1 > T1 BERT. The unit automatically configures to a default setup.



- 2 Press **Setup**. Ensure the characteristics shown in the Summary setup screen match the network characteristics (such as T1D4, etc.).
To change the settings, select the desired tabs in the property setup sheets.

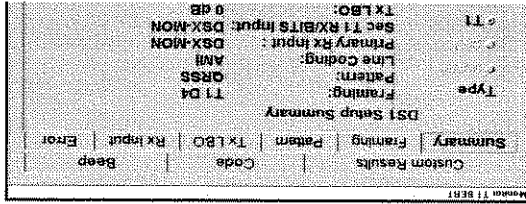

- 3 Press **OK**. If monitoring a second signal, press one of the buttons labeled **T1 PRI** in the Results Group window and select **T1 Sec** from the pull-down menu. Set both Results Category buttons to **Summary**.

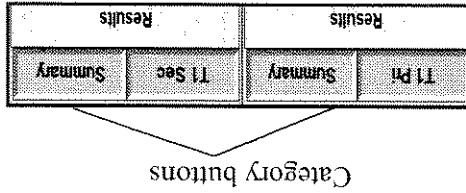

- 4 Verify the yellow active port LEDs next to the DS1 PRIMARY RX and SECONDARY RX jack are illuminated.

Connecting the 2310 to the circuit

- To connect the 2310 to the circuit
- 1 Connect a cable from the PRIMARY RX jack to the DSX-1 A-Side MON jack.
 - 2 Connect a cable from the SECONDARY RX jack to the DSX-1 Z-Side MON jack.

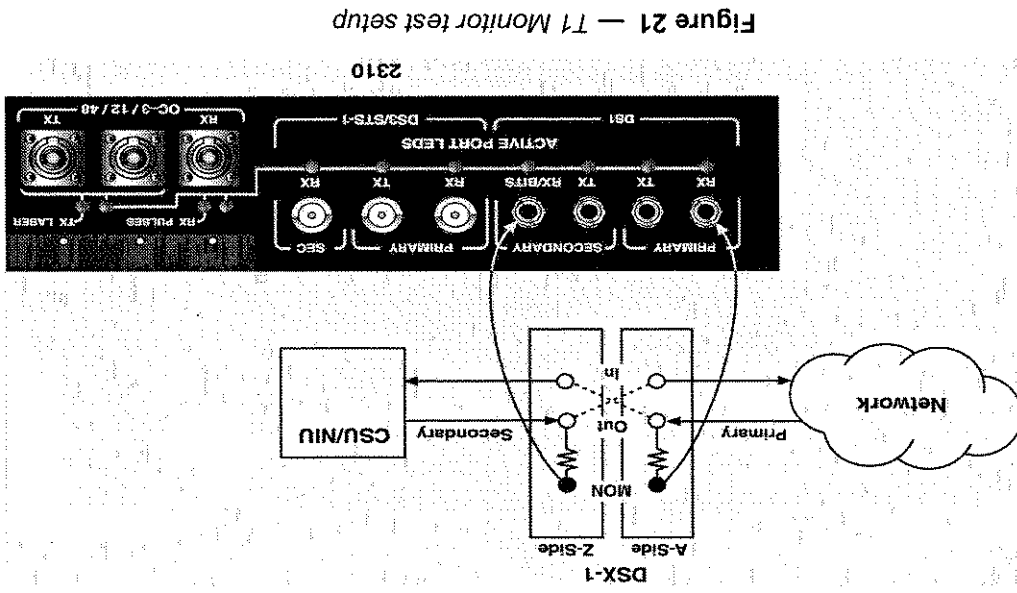
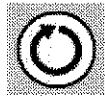

Figure 21 — T1 Monitor test setup

Connecting the 2310 to the circuit diagram

Figure 21 diagram is a sample depiction of cable connections from the DSX-1 panel to the inputs on the 2310 for T1 monitoring.

4 Verify the green SIGNAL and FRAME LEDs are illuminated and the Primary and Secondary Results Displays show Results OK.



3 Press the **RESTART** permanent softkey to clear alarms and begin the test.

T1 BERT Termination setup

This test allows you to test a T1 circuit for logic errors, BPVs, frame errors, and CRC errors (if applicable) on T1 lines.

Configuring the 2310

To perform terminate T1 BER testing

- 1 On the menu bar, press **TERM > Terminate T1 > T1 BERT**. The unit automatically configures to a default setup.

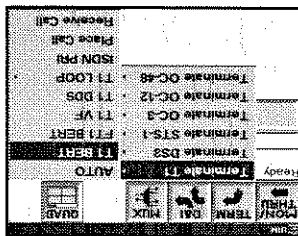

- 2 Press **Setup**. The Summary property sheet displays. Ensure the characteristics shown in the Summary setup screen match the network characteristics (such as T1D4, etc.).

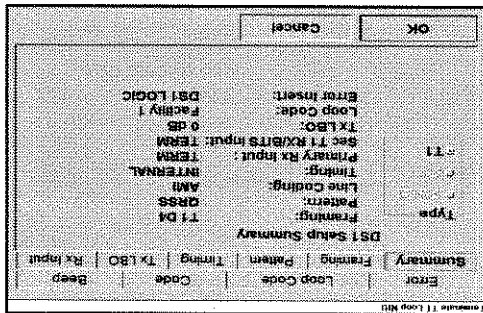

**Connecting the 2310
to the circuit**

- 1 Connect a cable from the DSI PRIMARY TX jack to the appropriate DSX-1 TX (IN) jack.
- 2 Connect a cable from the DSI PRIMARY RX jack to the appropriate DSX-1 RX (OUT) jack.
- 3 Loop the Far-end DSX-1.

- 9 Verify the yellow DSI PRIMARY RX and TX active port LEDs are illuminated.

Results		Results	
T1 Pn	Summary	T1 Sec	Summary

Category buttons

- 8 Ensure Results Category is set to **Summary**.
- 7 Press **OK**.
- 6 Press the **Timing** tab and select the appropriate timing.
- 5 Press the **Error Insert** tab and select **DS1 Logic**.
- 4 Press the **LBO** tab and select appropriate dB level.

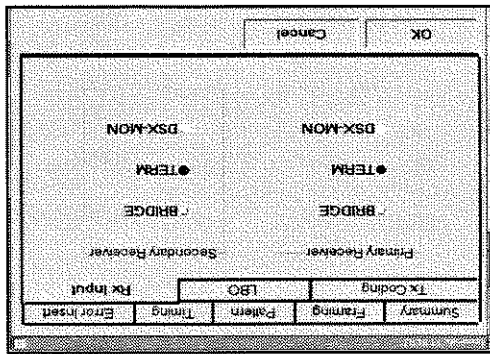

- 3 Press the **RX Input** tab and select **TERM**.

- 4 Press the **RESTART** permanent softkey to clear alarms and begin the test.

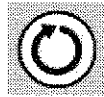

- 5 Verify the green **PRI DS1 SIGNAL**, **FRAME**, and **PATTERN** LEDs are illuminated, and the **SUMMARY Results** displays Results OK.

- 6 Press **DS1 Logic Error** five times. Verify five logic errors are received in the Results Display windows.

Figure 22 is a sample depiction of cable connections from the DSX-1 panel to the inputs on the 2310 for T1 termination testing.

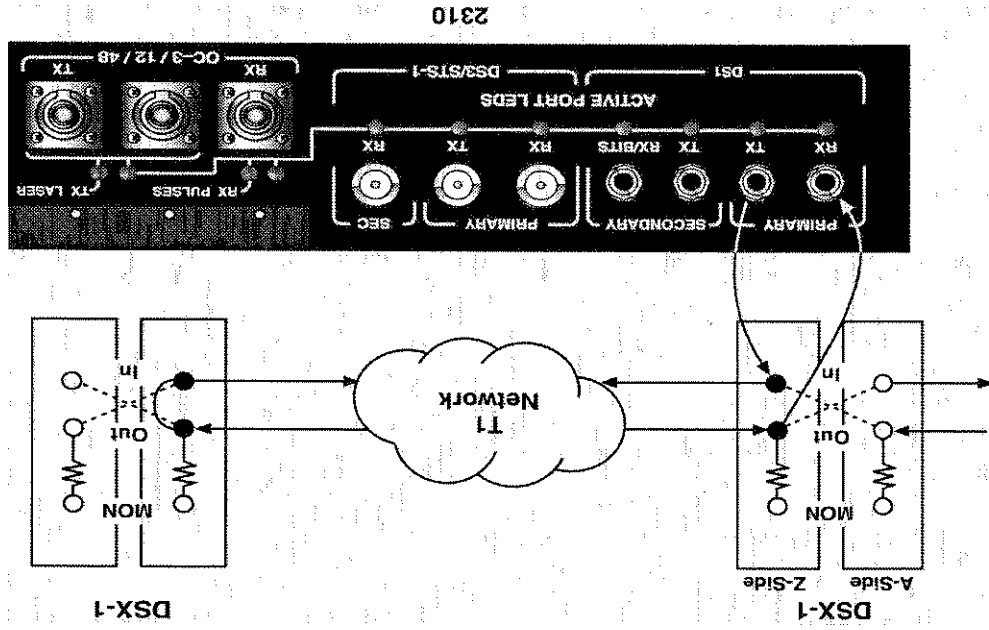

Figure 22 — T1 Termination test setup

T1 Loopback BER Testing

This test allows you to qualify T1 circuit error performance by testing for logic errors, BPVs, frame errors, and CRC errors (if applicable) on T1 lines.

Configuring the 2310

- 1 To perform terminate T1 Loopback BER testing
On the menu bar, press **TERM > Terminate T1 > T1 LOOP**, followed by the appropriate T1 loop code (such as **NIU**). The unit automatically configures to a default setup screen.

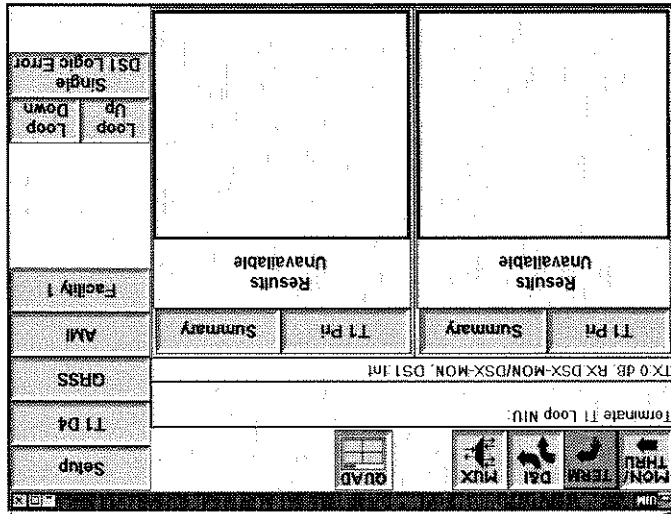
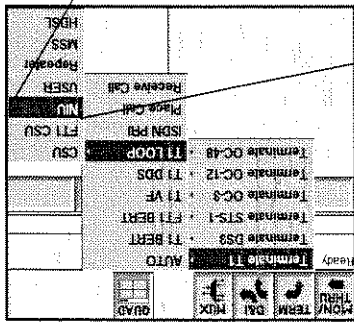

- 2 Press **Setup**. Ensure the characteristics shown in the Summary setup screen match the network characteristics (such as T1D4,

etc.). To change the settings, select the desired tabs in the property setup sheets.

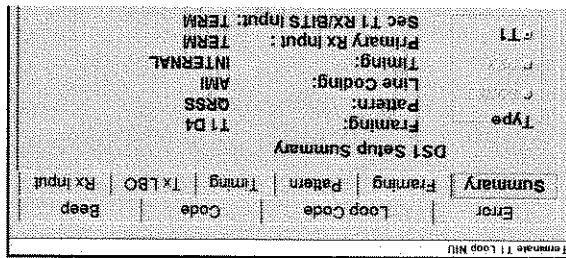

3 Select the **Loop Code** tab. Select the appropriate Loop Code.

Depending upon your choice in the third pull-down menu during Setup, the Loop Code tab displays the possible selections which pertain to that menu selection. In this case, NIU was selected during the setup process.

4 Select the proper setting in the **Pattern** tab.

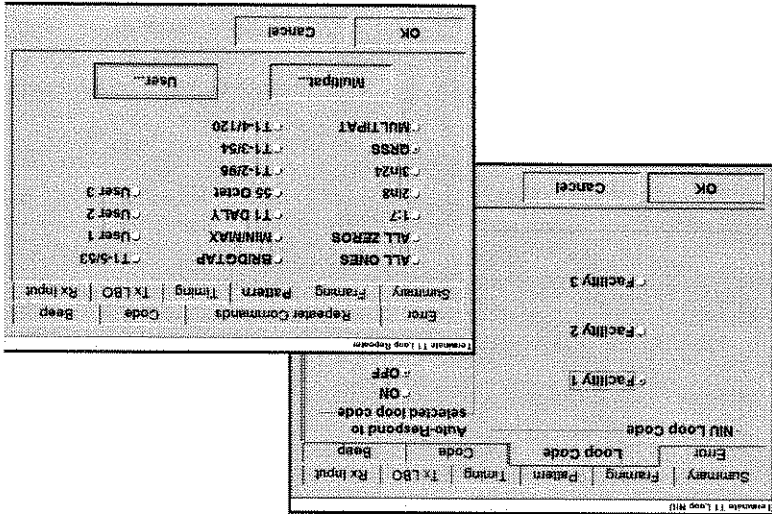

5 Press **OK**. Set the Results Category buttons to **Summary**.

Connecting the 2310 to the circuit

- 1 Connect a cable from the DS1 PRIMARY TX jack to the appropriate DSX-1 TX (IN) jack.
- 2 Connect a cable from the PRIMARY RX jack to the appropriate DSX-1 RX (OUT) jack.
- 3 Press **Loop Up**. Verify the green SIGNAL, FRAME, and PATTERN LEDs are illuminated, and the SUMMARY Results displays results OK.



- 6 Press the **RESTART** permanent softkey to clear alarms and begin connecting to the circuit.

Results		Results	
T1 Pn	Summary	T1 Pn	Summary

Category buttons

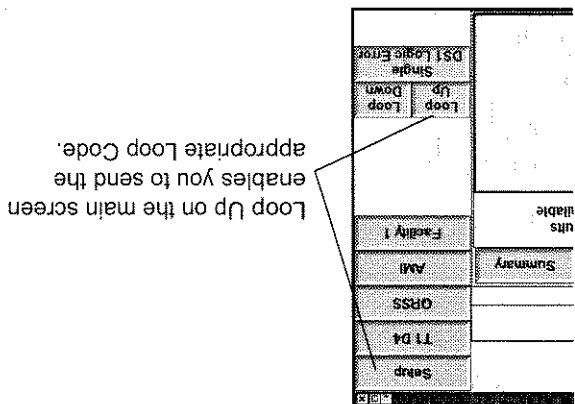

- 4 Send bit errors to verify the loop.

- 1 On the menu bar, press **MON/THRU**. Select the appropriate signal to be tested. Then select the mapping for the DSI within the signal (VT1.5 or DS3 Muxed until T1 BERT is available).
- To perform T1 timing slip analysis

Configuring the 2310

T1 Timing Slip Analysis

This test allows you to qualify T1 circuit timing slips by testing elapsed time since the test started, as well as the date and time, on T1 lines.

Figure 23 — T1 Loopback test setup

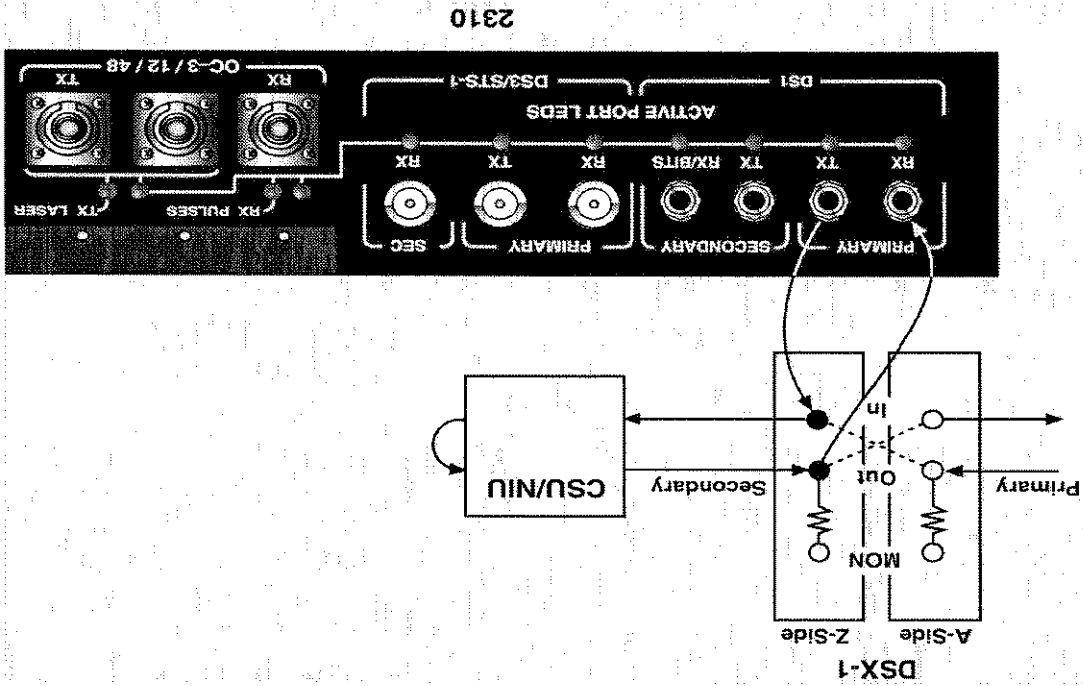

Connecting the 2310 to the circuit diagram
 Figure 23 diagram is a sample depiction of cable connections from the DSX-1 panel to the inputs on the 2310 for T1 Loopback BER testing.

- 4 Press **Rx Input**. For DS1, DS3, or STS-1 access, select the appropriate Rx Input level (DSX for DS3/STS-1 and DSX MON, BRIDGE, or TERM for DS1).
- 5 Press **Framing**. Select the T1 framing (D4, ESF, unframed) and the appropriate DS3 framing (M13/C-BIT).

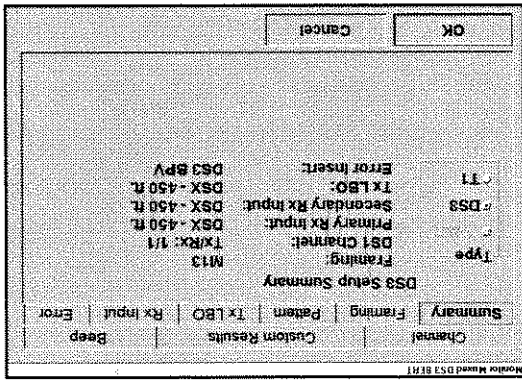

- 3 Press **Setup**. The Summary property sheet displays.

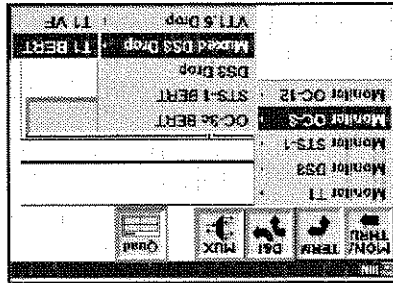

- 2 Select **T1 BERT**. The unit automatically configures to a default setup.

- 6 Press **Channel**. Select the appropriate SONET, DSI, and VT 1.5 channel.
- 7 Press **OK**.
- 8 Verify the yellow DSI SECONDARY RX/BITS and appropriate signal level RX active port LEDs are illuminated.

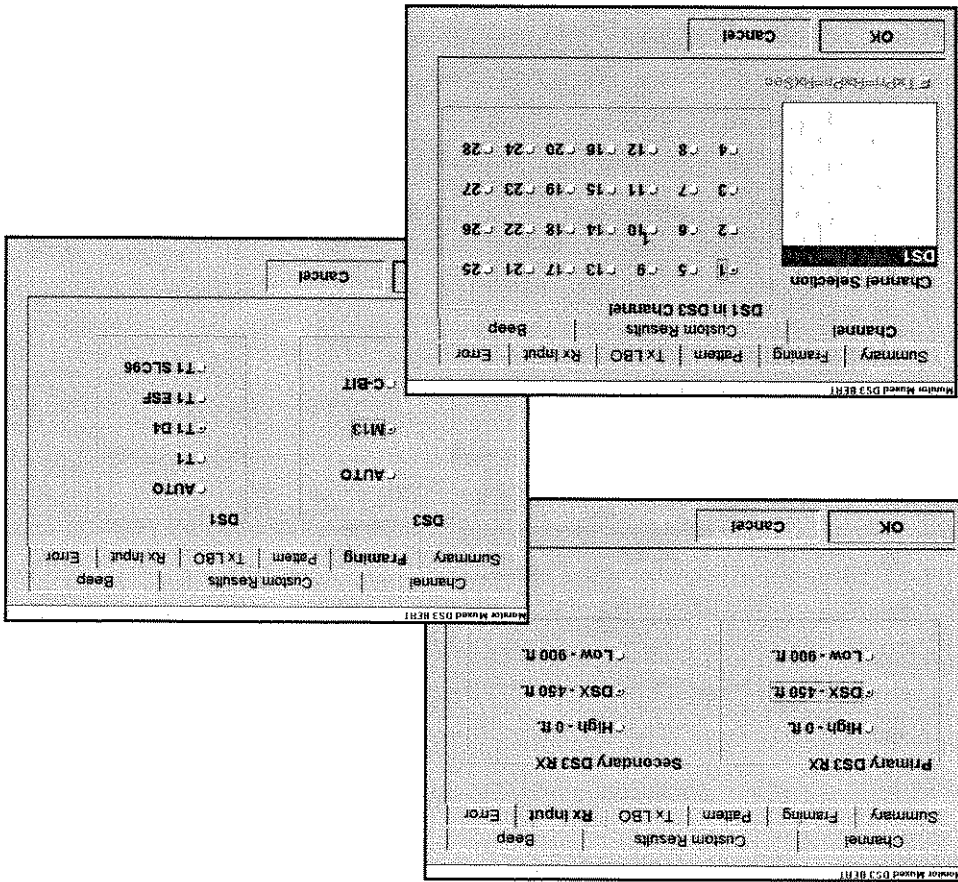

Connecting the 2310 to the circuit

- 1 To connect the 2310 to the circuit
- 2 Connect a cable from the SECONDARY RX/BITS jack to the DS1 BITS Clock or a known good reference signal (see Figure 24).
- 3 Connect a cable from the DSX RX jack to the signal to be tested (see Figure 24).
- 4 Press the **RESTART** permanent softkey to clear alarms and begin the test.

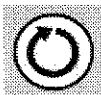

- 4 Verify the appropriate green signal LEDs are illuminated for the tested signal (DS3 or SONET) and DS1.
- 5 To display timing calculations, press one of the Results Group buttons and select **T1 Pri**. Press the Results Category button and select **Signal > Timing Slips** as the result.

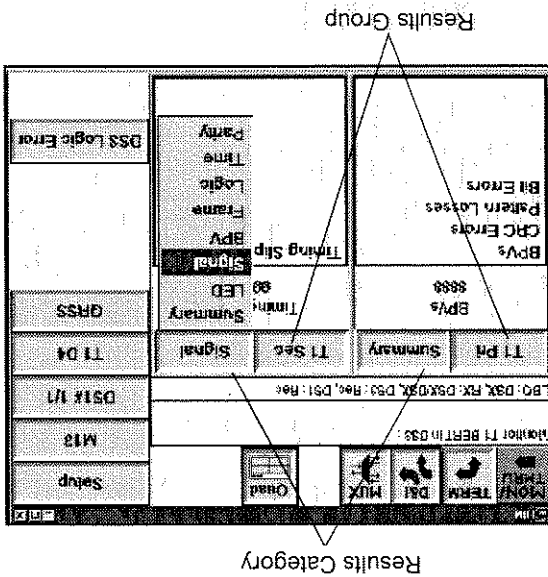

- 6 Verify test results in the Results display windows. If the signal is error free, results are displayed in the Summary Category and/or 0 is displayed under the Timing Slip result.

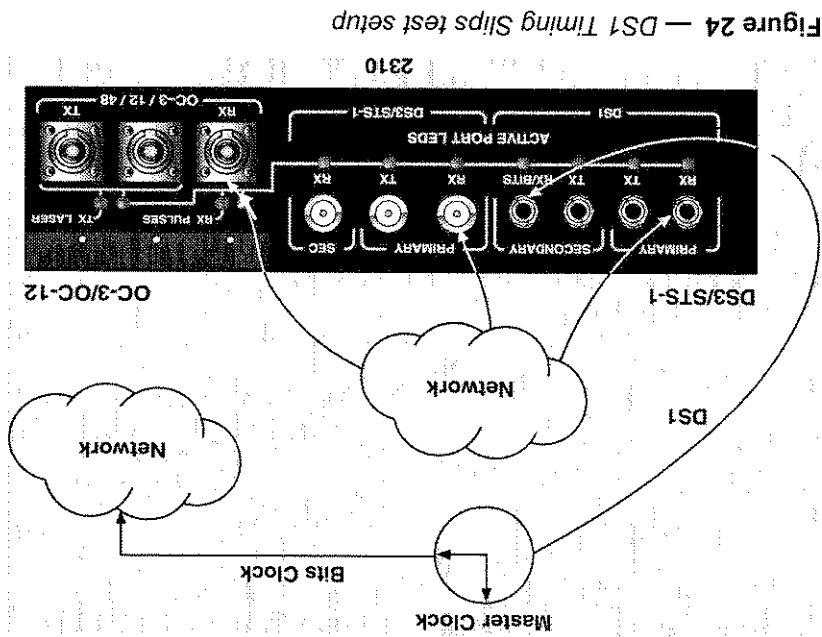

Figure 24 — DS1 Timing Slips test setup

Connecting the 2310 to the circuit diagram
Figure 24 is a sample depiction of cable connections from the Master Clock to the inputs on the 2310 for DS1 Timing Slips testing.



FT1 Loopback BER testing

Configuring the 2310

To perform terminate FT1 Loopback BER testing

- 1 On the menu bar, press **TERM > Terminate T1 > T1 LOOP > FT1** CSU. The unit automatically configures to a default setup screen.

This test allows you to qualify T1 circuit error performance by testing for logic errors, BPs, frame errors, and CRC errors (if applicable) on Fractional T1 lines.

- Test aggregate bandwidths on contiguous/non-contiguous channels in 56xN or 64xN format.
 - Test Fractional T1 circuits bandwidths and measure the round trip path delay of any group of channels.
 - Confirm that the Fractional T1 signal is properly received by the network equipment.
- FT1 circuits from a convenient T1 access point. These tests can also be added to the feature list and allow for single test testing of connecting customer premises equipment. The V.54 FT1 loop code is enables complete qualification and testing of new FT1 circuits before non contiguous, 56KxN and 64KxN, channel formats. This option This option provides Fractional-T1 (FT1) modes for contiguous and

Using the Fractional T1 (FT1) option

Connecting the 2310 to the circuit

- 1 Connect a cable from the DS1 PRIMARY TX jack to the appropriate DSX-1 TX (IN) jack.
 - 2 Connect a cable from the DS1 PRIMARY RX jack to the appropriate DSX-1 RX (OUT) jack. Verify T1 Frame SYNC.
- To connect the 2310 to the circuit
- 10 Verify the yellow DS1 PRIMARY RX and TX active port LEDs are illuminated.

Results		Results	
T1 Pt	Summary	T1 Pt	Summary

Category buttons

- 9 Ensure Results Category is set to **Summary**.
- 8 Press **OK**.

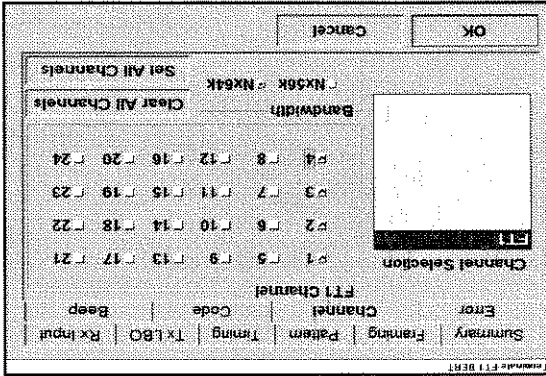

- 7 Press the **Channel** tab and select the appropriate FT1 channels and bandwidth (Nx56 or Nx64k).
- 6 Press the **Timing** tab and select the appropriate timing selection for the T1 under test.
- 5 Press the **Error Insert** tab and select DS1 LOGIC.
- 4 Press the **LBO** tab and select appropriate dB level.

3 Press the **Loop Up** action button.

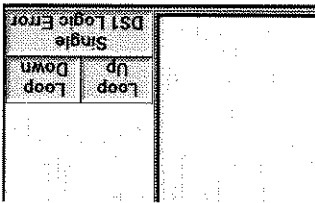

4 Press the **RESTART** permanent softkey to clear alarms and begin the test.

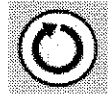

5 Verify the green **PRI DST SIGNAL**, **FRAME**, and **PATTERN** LEDs are illuminated and the **Primary** and **Secondary Results** Displays show **Results OK**.

6 Send **Bit Errors** to verify loop.

FT1 Drop and Insert testing

This test allows you to qualify FT1 circuit error performance by demultiplexing (dropping) at an intermediate point and entering (inserting) different information on the specific FT1 channels under test on the T1 circuit.

Figure 25 — FT1 Loopback test setup

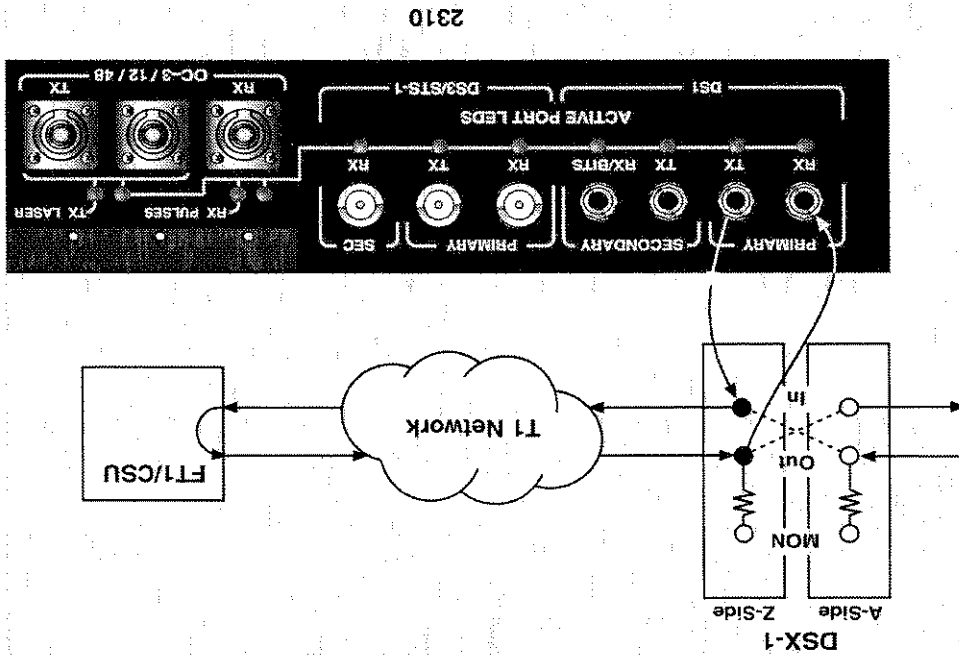

Connecting the 2310 to the circuit diagram

Figure 25 diagram is a sample depiction of cable connections from the DSX-1 panel to the inputs on the 2310 for T1 Loopback BER testing.

Configuring the 2310

- 1 On the menu bar, press **D&I > D&I Loop FT1 CSU**. The 2310 configures to a default setup.

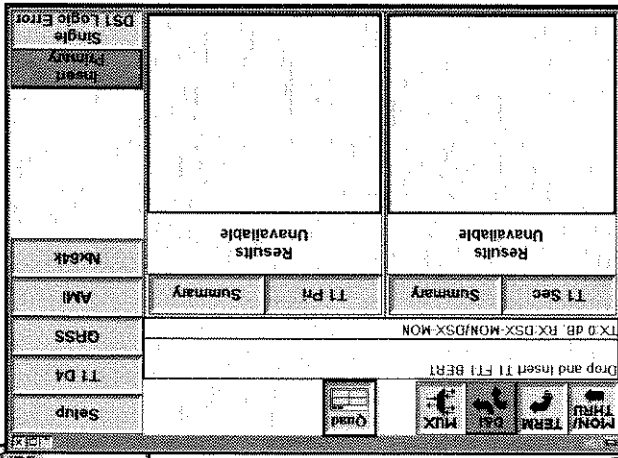
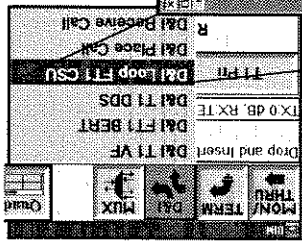

- 2 Press **Setup**. Ensure the characteristics shown in the Summary property sheet match the network characteristics (such as T1 DA, etc.). To change the settings, select the desired tabs in the property setup sheets.

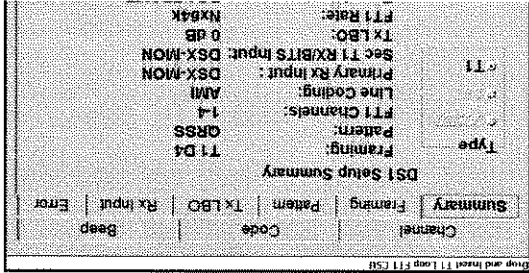

Connecting the 2310 to the circuit

- 1 To connect the 2310 to the circuit
 Connect a cable from the DSI PRIMARY and SECONDARY RX jack to the appropriate DSX-1 MON jacks.
- 9 Verify the yellow DSI PRIMARY TX/RX active port LEDs and SECONDARY TX/RX LED are illuminated.

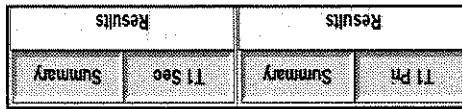

- 8 Press one of the buttons labeled **T1 Pn** in the Results Group and select **T1 Sec** from the pull-down menu. Set both Results Category buttons to **Summary**.
 Category buttons
- 7 Press **OK**.

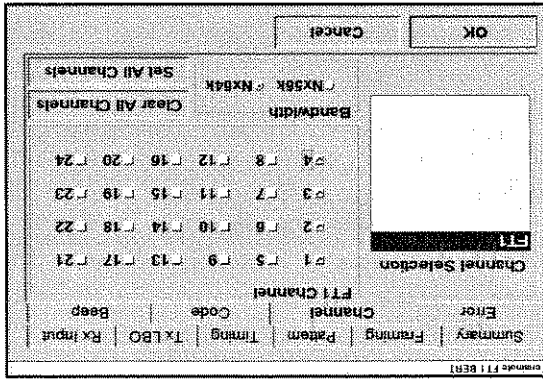

- 6 Press the **Channel** tab and select the appropriate FT1 channels and bandwidth (Nx56 or Nx64k).
- 5 Press the **Timing** tab and select **RECOVERED**.
- 4 Press the **Error** tab and select **DS1 LOGIC**.
- 3 Press the **Rx Input** tab and select **MON** (select **BRIDGE** if you are bridging on the circuit).

NOTE:

The PRIMARY RX needs to be connected to the DSX-1 MON point facing the direction of the test (see Figure 26 on page 66).

- 2 Check that the SIGNAL and FRAME SYNC LEDs illuminate, as well as the message Results OK displays before patching into the TX jacks.

- 3 Connect a cable from the PRIMARY TX jack to the appropriate DSX-1 A-Side (IN) jack. The PRIMARY TX must be cabled to the same side as the PRIMARY RX (see Figure 26 on page 66). Immediately insert a 100 ohm terminating plug into the Z-Side (OUT) jack, on the opposite side of the DSX.

NOTE:

The PRIMARY TX should face the direction of the device under test.

- 4 Connect a cable from the SECONDARY TX jack to the appropriate DSX-1, Z-Side (IN) jack (the SECONDARY TX must be cabled to the same side as the SECONDARY RX (see Figure 26 on page 66)). Immediately insert a 100 ohm terminating plug into the Z-Side jack, on the opposite side of the DSX.
- 6 Press **OK**.
- 7 Press the **RESTART** permanent softkey to clear alarms and begin the test.

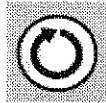

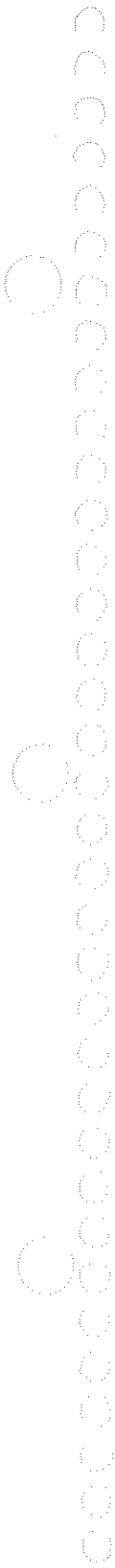

- 10 Press the **DS1 Logic Error** action button five times. Verify five logic errors are received in the Results Display windows.
- 9 Verify the green **PRI DS1 SIGNAL, FRAME, and PATTERN** LEDs are illuminated and the Primary and Secondary Results Displays show Results OK.

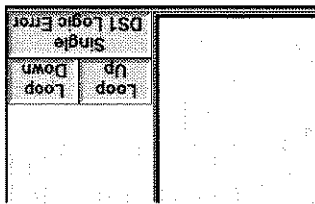

- 8 Press the **Loop Up** action button.

Figure 26 — FT1 Drop and Insert setup

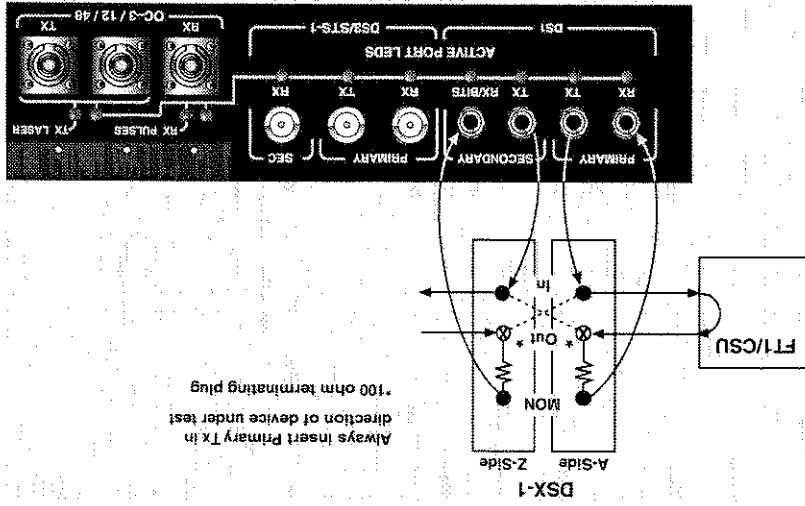

Figure 26 diagram is a sample depiction of cable connections from the DSX-1 panel to the inputs on the 2310 for FT1 Drop and Insert testing.

Connecting the 2310 to the circuit diagram

Using the DDS option

DDS Loopback BER testing

This test allows you to test Digital Data System (DDS) circuits and generate alternating/latching DDS loop codes for sectionalizing and troubleshooting DDS circuits.

Configuring the 2310

- 1 On the menu bar, press **TERM > Terminate T1 > T1 DDS**. The unit automatically configures to a default setup screen.

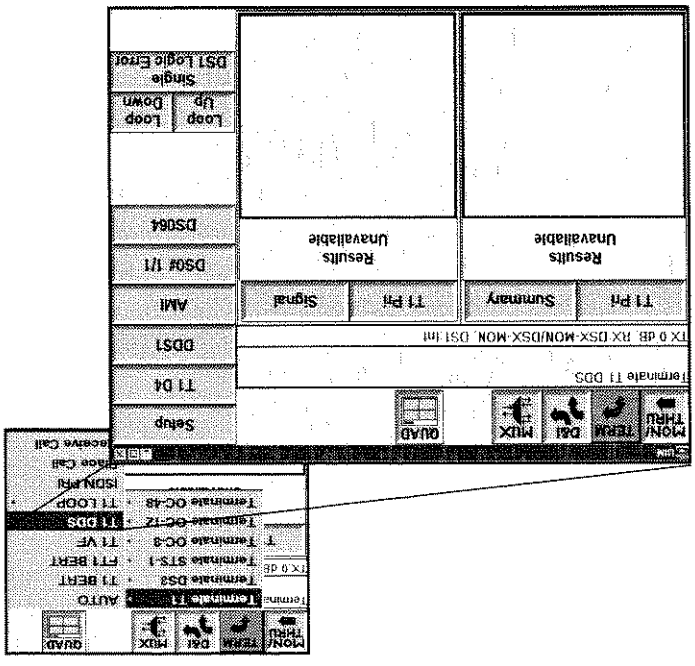

- 2 Press **Setup**. Ensure the characteristics shown in the Summary setup screen match the network characteristics (such as T1D4, etc.). To change the settings, select the desired tabs in the property setup sheets.

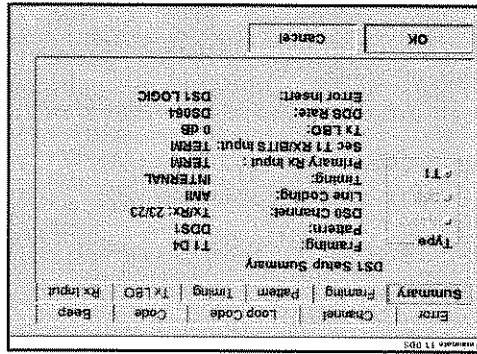

- 3 Press the **Rx Input** tab and select TERM.
- 4 Press the **Tx LBO** tab and select appropriate dB level.
- 5 Press the **Error** tab and select DS1 LOGIC and the appropriate Insertion Type.
- 6 Press the **Timing** tab and select the appropriate timing selection for the T1 under test.
- 7 Press the **Channel** tab and select appropriate DS channel and bandwidth (DS0A56 or DS064).

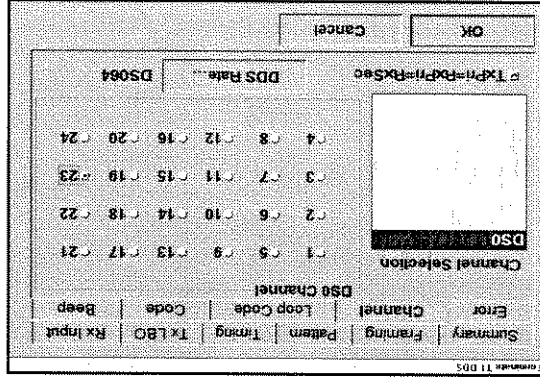

Connecting the 2310 to the circuit

- To connect the 2310 to the circuit
- 1 Connect a cable from the DSI PRIMARY RX jack to the appropriate DSX-1 RX (OUT) jack.
- 2 Connect a cable from the DSI PRIMARY TX jack to the appropriate DSX-1 TX (IN) jack.

- 11 Verify the yellow DSI PRIMARY RX and TX active port LEDs are illuminated.

Results		Results	
Summary	T1 Pn	Summary	T1 Pn

Category buttons

- 10 Ensure Results Category is set to **Summary**.
- 9 Press **OK**.

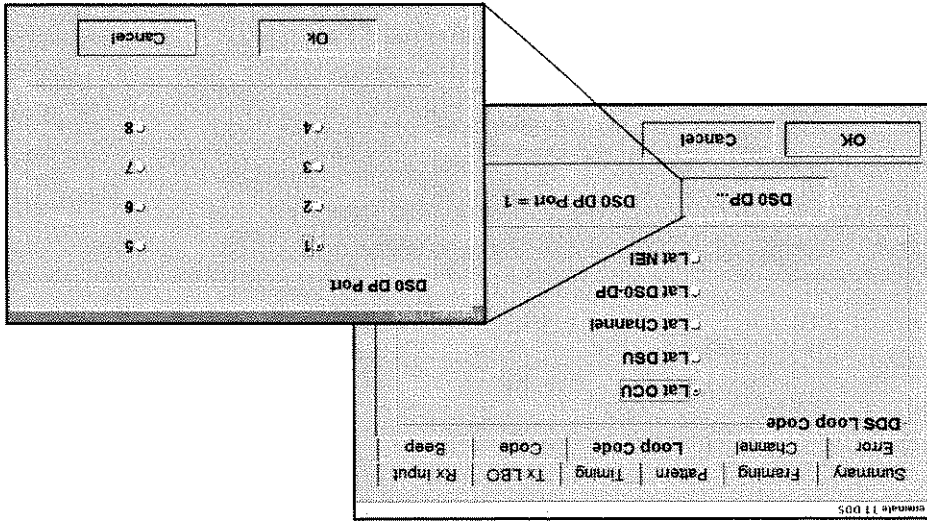

- 8 Press the **Loop Code** tab and select appropriate **DPS Loop Code**. If the **DS0-DP Loop Code** is selected, press the **DS0-DP** button to select the desired **DS0-DP Port** address.

3 Verify SIGNAL and FRAME SYNC.

4 Press the Loop Up action button.

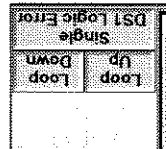

5 Press the **RESTART** permanent softkey to clear alarms and begin the test.



6 Verify the green PRI DSI SIGNAL, FRAME, and PATTERN LEDs are illuminated and the Primary Summary Results displays Results OK.

7 Send Bit Errors to verify loop.

Connecting the 2310 to the circuit diagram

Figure 27 diagram is a sample depiction of cable connections from the DSX-1 panel to the inputs on the 2310 for DDS Loopback BER testing.

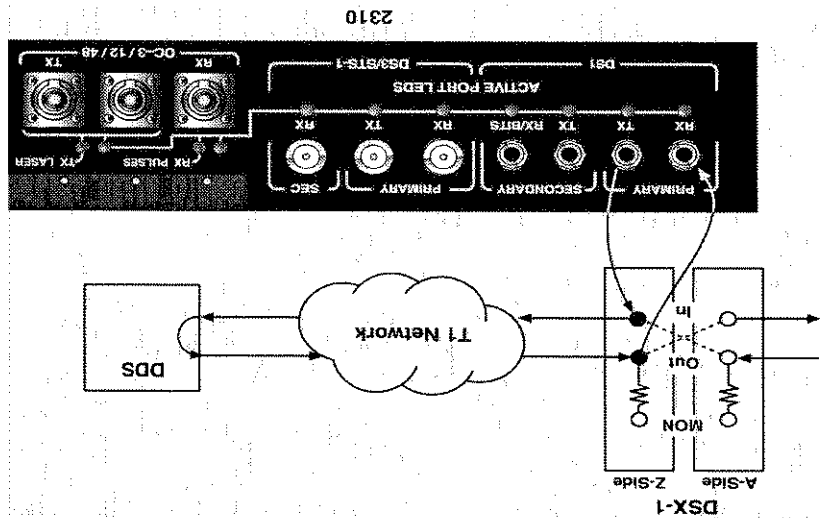

Figure 27 — DDS Loopback BER test setup

DDS Drop and Insert Testing

Configuring the T-BERD 2310

- To perform DDS Drop and Insert testing
- 1 On the menu bar, press **D&I > D&I T1 DDS**. The 2310 configures to a default setup.

This tests allow you to test DDS circuits from a T1 access point and generate alternating/latching DDS loop codes without removing the other T1 channels from service.

- 2 Press Setup. Ensure the characteristics shown in the Summary property sheet match the network characteristics (such as T1D4).

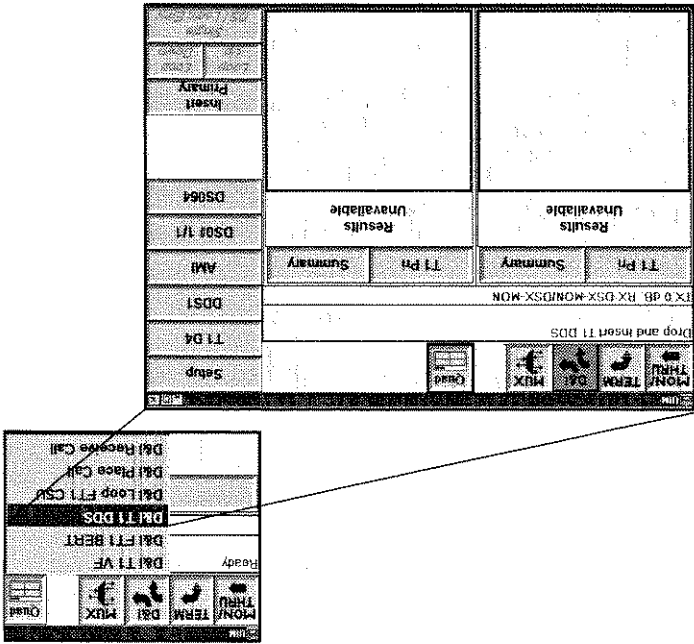

To change the settings, select the desired tabs in the property setup sheets.

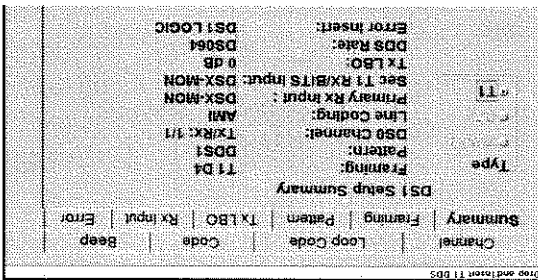

- 3 Press the **Rx Input** tab and select the appropriate Rx input, MON or BRIDGE.
- 4 Press the **Error** tab and select DS1 LOGIC.
- 5 Press the **Channel** tab and select the appropriate DDS channels and rate (DS0A56 or DS064).

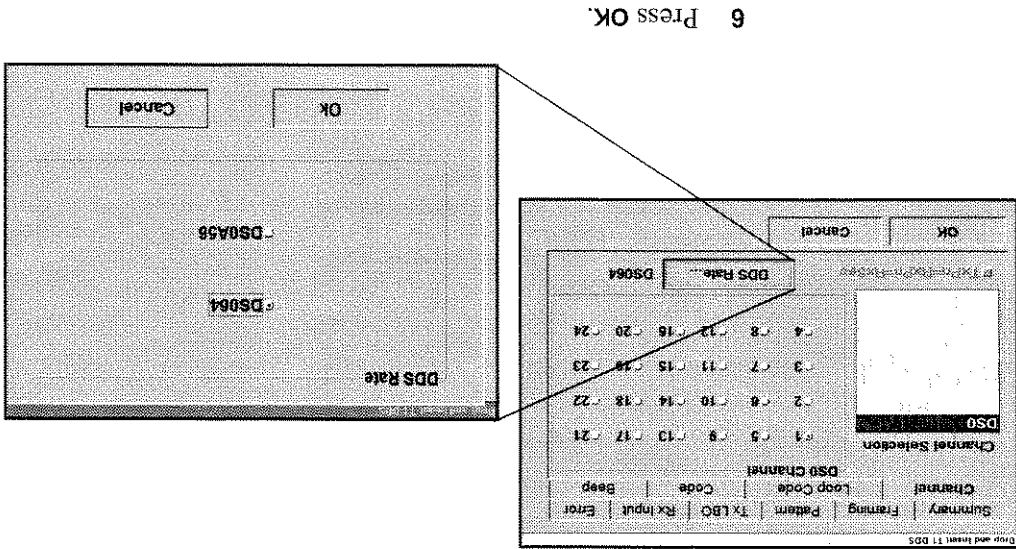

6 Press **OK**.



NOTE: The PRIMARY RX must be in the DSX facing the direction of the device under test.

Connecting the 2310 to the circuit

- 1 Connect a cable from the DS1 PRIMARY and SECONDARY RX jack to the appropriate DSX-1 MON jacks.
- To connect the 2310 to the circuit
- 10 Verify the yellow DS1 PRIMARY TX/RX active port LEDs and SECONDARY TX/RX LED are illuminated.

Results		Results	
T1 Pri	Summary	T1 Sec	Channel

Category buttons

- 9 Press **T1 Pri** in the Results Category window. Set the left Results Category button to **Summary** and right to **Channel**.
- 8 Press **OK**.

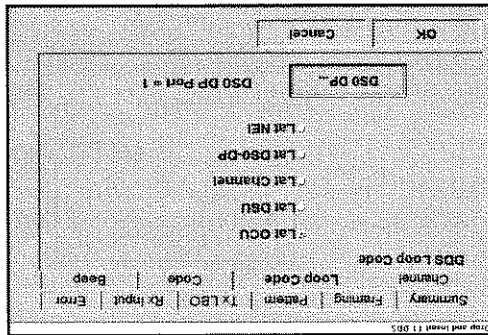

- 7 Press the **Loop Code** tab and select the appropriate DDS piece of equipment to be looped. If DS0-DP is selected, press the **DS0-DP** button to select the DS0-DP address.

2 Check for good SIGNAL and FRAME SYNC before transmitting into the circuit.

3 Connect a cable from the PRIMARY TX jack to the appropriate DSX-1 A-Side (IN) jack, which is the same side of the DSX as the PRIMARY RX (see Figure 28 on page 76).

4 Immediately insert a 100 ohm terminating plug into the Z-Side (OUT) jack on the opposite side of the DSX.

NOTE:

Never insert the terminating plug first and the PRIMARY TX should face the direction of the device under test.

5 Connect a cable from the SECONDARY TX jack to the appropriate DSX-1 Z-Side (IN) jack on the same side of the DSX-1 as the SECONDARY RX (see Figure 28 on page 76).

6 Immediately insert a 100 ohm terminating plug into the Z-Side jack, which is the OUT Jack on the opposite side of the DSX. *Never insert the terminating plug first.*

7 Press the **RESTART** permanent softkey to clear alarms and begin the test.

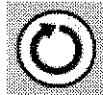

Check for SIGNAL and FRAME SYNC before proceeding to the next step.

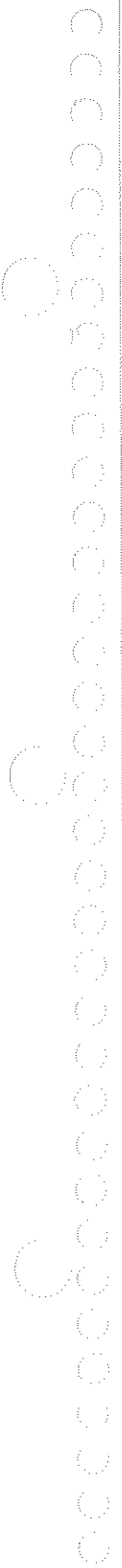

- 9 Verify the green PRI DSI SIGNAL, FRAME, and PATTERN LEDs are illuminated and the Primary and Secondary Results Displays show Results OK.
- 10 Press **DS1 Logic Error** five times. Verify five logic errors are received in the Results Display windows.

8 Press **Insert Primary > Loop Up**.

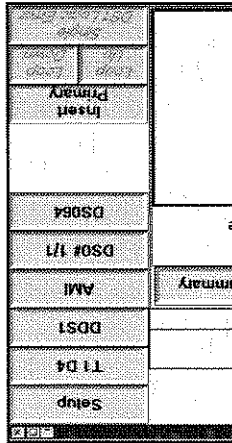

Connecting the 2310 to the circuit diagram

Figure 28 diagram is a sample depiction of cable connections from the DSX-1 panel to the inputs on the 2310 for DDS Drop and Insert testing.

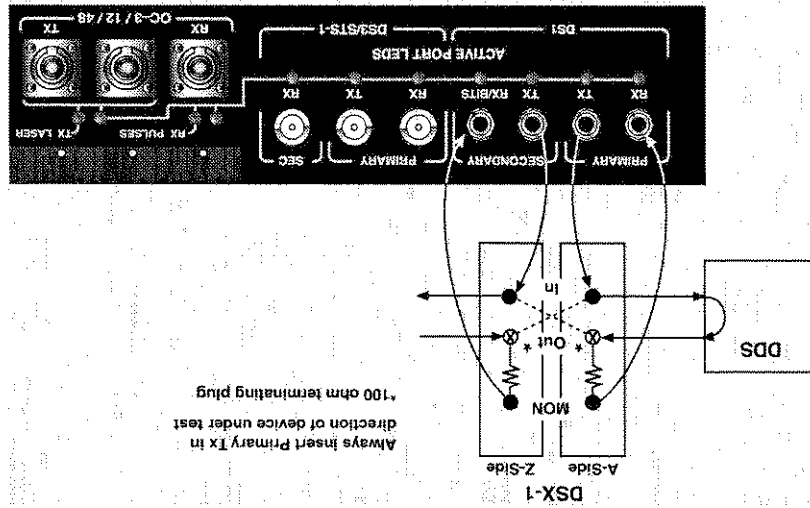

Figure 28 — DDS Drop and Insert setup

Using the Signaling option

This option enables you to test the ability of a switch/PBX to handle incoming calls and allows you to emulate switch-to-switch communications. You can place, receive and monitor calls over several trunk types. Features include: Send/Receive DP, DTMF, and MF digits to/from switches and PBXs. You can also measure inter-digit delay and digit/tone duration.

This tests allow you to view the signaling bits for all of the 24 channels for both the Primary and Secondary lines, simultaneously.

Monitoring A/B/C/D signaling bits

- 1 On the menu bar, press **Mon/Thru > Monitor T1 > T1 VF**. The unit automatically configures to a default setup screen.

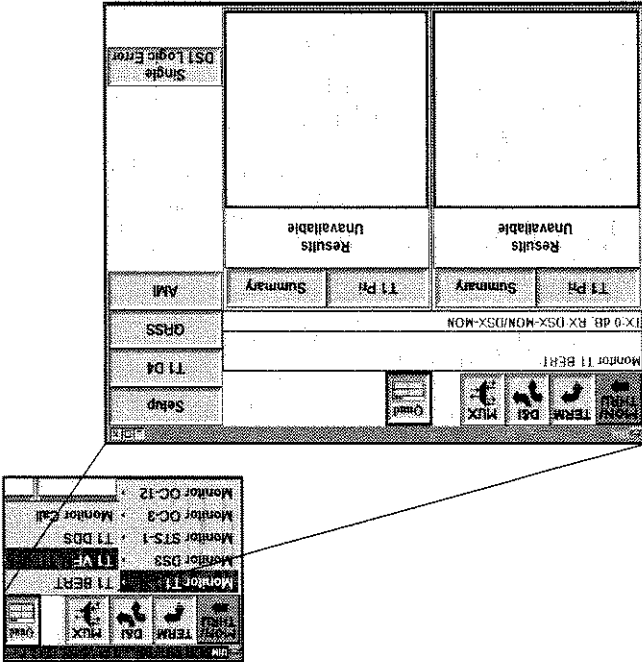

- 2 Press **Setup**. Ensure the characteristics shown in the Summary setup screen match the network characteristics (such as T1D4). To change settings, select the desired property sheet tabs in the property setup sheets.

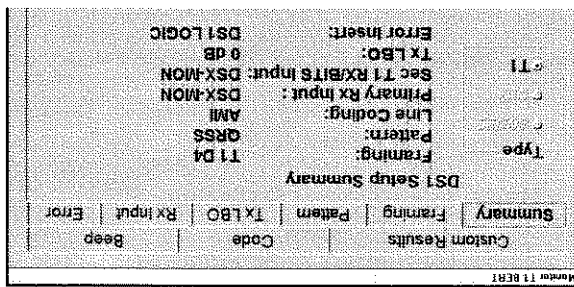

- 3 Exit the configuration setup screen by pressing **OK**.
- 4 Set Result Group buttons to **T1 Pri** (left) and **T1 Sec** (right).

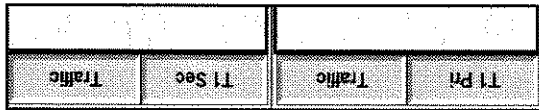

- 5 Set Result Category buttons to **Traffic**.

Connecting the 2310 to the circuit

- 1 Connect two cables, one from the **PRIMARY** RX jack, and the other from the **SECONDARY** RX jack to the DSX-1 MON access point.
- 2 Press the **RESTART** permanent softkey to clear alarms and begin the test.
- 3 Verify the **SIGNAL** and **FRAME** LEDs are illuminated. Observe all 24 channels for Primary and Secondary.



Signaling Monitor (Call Capture)

This test allows you to perform Call Capture.

Configuring the 2310

- 1 On the menu bar, press **MON > Monitor T1 > Monitor Call**. The unit automatically configures to a default setup screen.

Selecting choices from the menu bar always gives you a default setup screen.

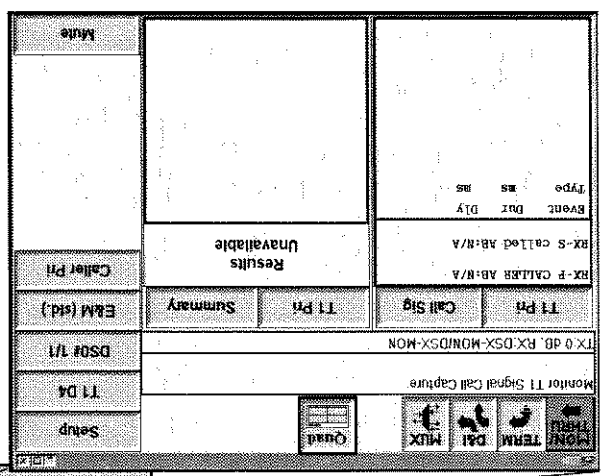
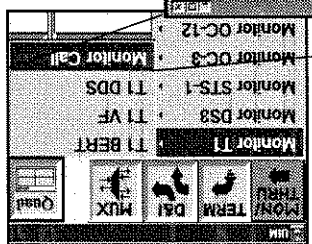

- 2 Press **Setup**. Ensure the characteristics shown in the Summary property setup screen match the network characteristics. To

- 3 Press the **Trunk** tab and select the appropriate trunk type (e.g., Loop Start, Ground Start, or E&M).
- 4 Select the type of circuit equipment (e.g., SLC office, SLC station, FXO, or FXS) of the source of the call. Select the side from which the call is originating using the **Call Source** button.

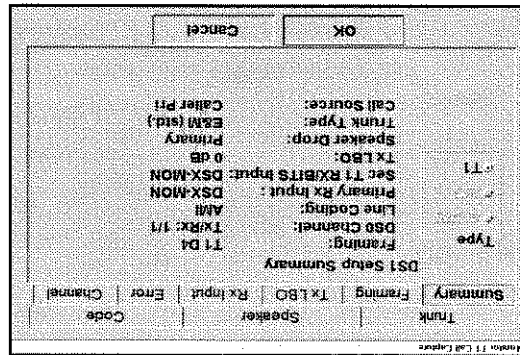

change the settings, select the desired tabs in the property setup sheets.

6 Set both Result Group buttons to Primary.

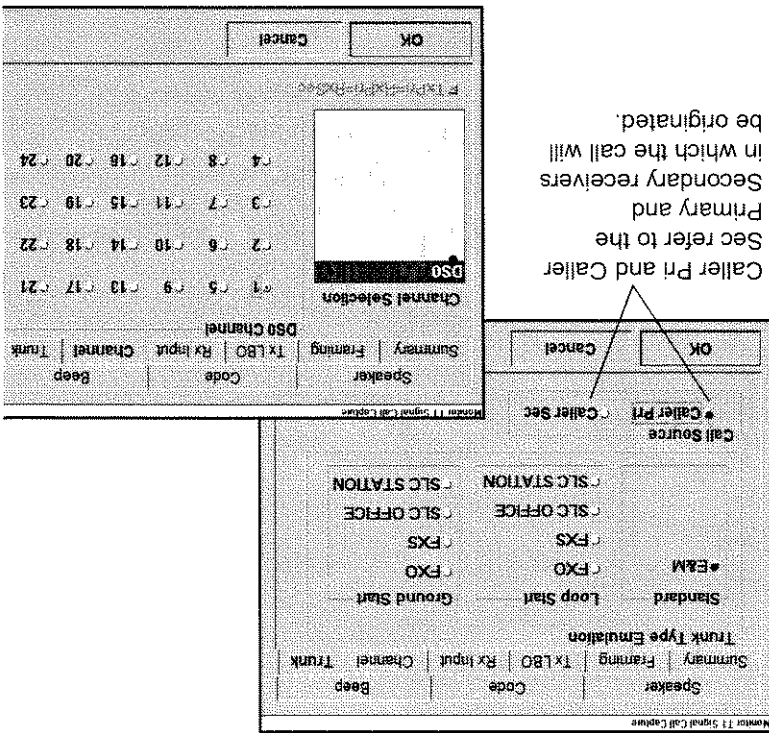

5 Select the **Channel** tab and select the DS0 that you want to monitor. Press **OK**.

Connecting the 2310 to the circuit

- 1 Connect two cables, one from the PRIMARY T1 interface, and the other from the SECONDARY T1 interface to the DSI test access point (DSX-1 patch panel).
- 2 Press the **RESTART** permanent softkey to clear alarms and begin the test.
- 3 Verify the **SIGNAL** and **FRAME** LEDs are illuminated (green).
- 4 Observe the signaling activities in the results display.



Monitor T1 Signal Call Capture		TX 0 dB, RX DSX-MON/DSX-MON		Call Sig	T1 Pri	T1 Pri	T1 Pri	T1 Pri	Summary	LED	Signal	BPV	Frame	Traffic	Call Sig	Channel	Time											
KX-P CALLER ABN/A		RX-S called ABN/A		Event: DLT - DLY		Type: NO NO		762531 N		Summary		LED		Signal		BPV		Frame		Traffic		Call Sig		Channel		Time		
Setup	T1 DA	DSOF III	EKM (Std)	Caller Pri	Call Sig	T1 Pri	T1 Pri	T1 Pri	T1 Pri	T1 Pri	T1 Pri	T1 Pri	T1 Pri	T1 Pri	T1 Pri	T1 Pri	T1 Pri	T1 Pri	T1 Pri	T1 Pri	T1 Pri	T1 Pri	T1 Pri	T1 Pri	T1 Pri	T1 Pri	T1 Pri	T1 Pri

- 7 Set Result Category buttons to **Call Sig** on the left and **Traffic** on the right.

- 2 Press **Setup**. Ensure characteristics shown in the setup Summary screen match the network characteristics. To change settings, select the desired property sheet tabs in the property setup sheets.
- 3 Select the **Channel** tab in property sheet to choose the T1 channel (DS0) on which to transmit the call.
- 4 Select the appropriate trunk type (e.g., Standard E&M, Loop Start, or Ground Start) using the **Trunk** tab. If Loop Start or Ground Start is selected, choose FX or SLC as circuit type. Select the Tone (MF, DP, or DTMF) from the Trunk property sheet.

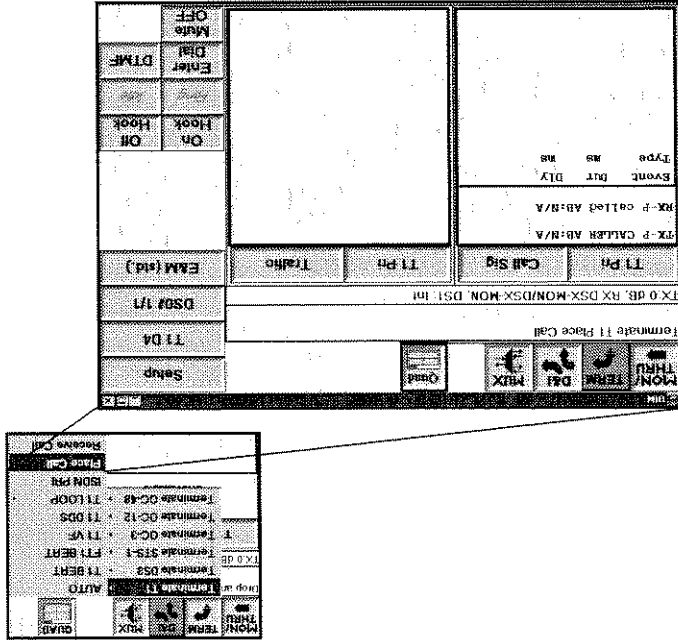

- 1 On the menu bar, press **TERM > Terminate T1 > Place Call**. The unit automatically configures to a default setup screen.

Configuring the 2310

To perform PBX/Switch Emulation to originate a call

PBX/Switch Emulation (originating a call)

circuit.

This test allows you to originate a call while terminating the T1

- To connect the 2310 to the circuit
- 1 Connect a cable from the PRIMARY RX jack to the OUT jack of the DSX-1. Connect a cable from the PRIMARY TX jack to the IN jack of the DSX-1.
 - 2 Press the **RESTART** permanent softkey to clear alarms. Verify the SIGNAL and FRAME LEDs are illuminated (green).
 - a Select **Call Sig Results Category**.
 - b Verify that **On Hook** is observed in the **Call Sig Results Category**.
 - c Press **Off Hook**. Verify that **Off Hook** appears in the Results display, followed by either a **WINK** (on standard E&M trunks) or **Dial Tone** (on Loop and Ground Start trunks).
 - d Press **Enter Dial** to display the signaling keypad.

Connecting the 2310 to the circuit

5 Press **OK**.

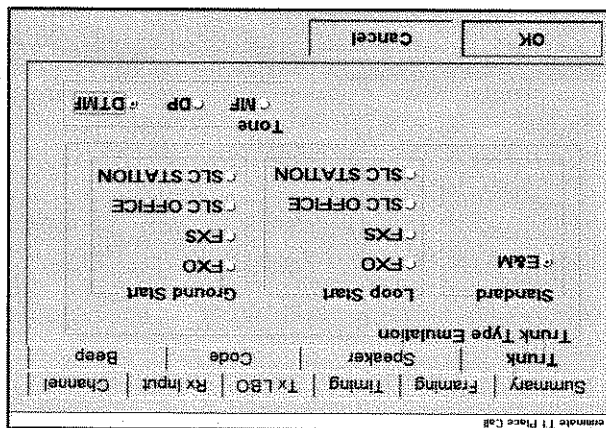

Configuring the 2310

- To perform PBX/Switch Emulation to terminate a call
- 1 On the menu bar, press **TERM > Terminate T1 > Receive Call**. The unit automatically configures to a default setup screen.
 - 2 Press **Setup**. Ensure characteristics shown in the setup Summary screen match the network characteristics. To change settings, select the desired property sheet tabs in the property setup sheets.

PBX/Switch Emulation (terminating a call)

- The following test enables the 2310 to terminate a call while terminating the T1 under test.
- 3 Dial the test number on the numeric keypad. Press **Push 2 Talk** or use the handset when you want to talk into the 2310 (keep button pressed while talking).
 - 4 Press **On Hook** to complete the call.
 - 5 Press **DS0# X/X** to select another DS0 channel to test.

Enter Dial becomes Exit Dial after the DTMF keypad displays.

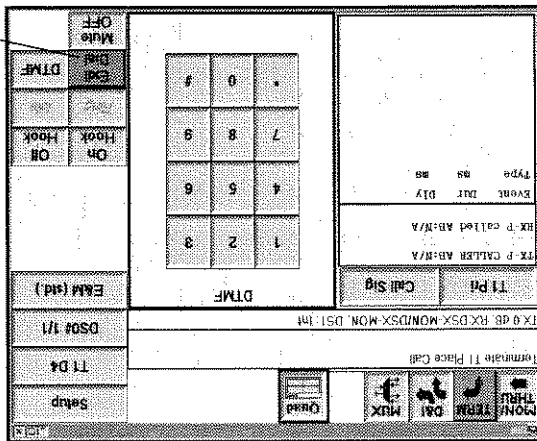

You can also dial on the MF keypad, if chosen on the Trunk tab.

MF	1	2	3
	4	5	6
	7	8	9
	0	*	#
	sp	slzp	sltp

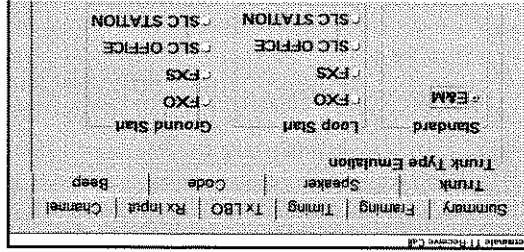

- 3 Select the **Channel** tab in property sheet to choose the T1 channel (DS0) on which to receive the call.
- 4 Select the appropriate trunk type (e.g., Standard, Loop Start, or Ground Start) using the **Trunk** tab. If Loop Start or Ground Start is selected, choose FX or SLC as circuit type. Press **OK**.

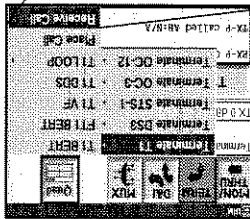
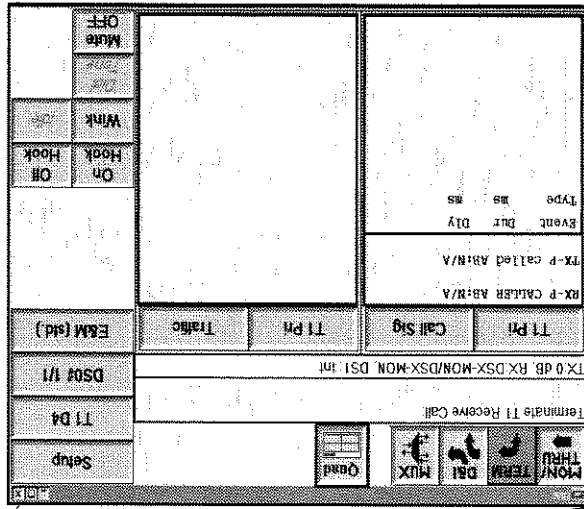



Connecting the 2310 to the circuit

- 1 To connect the 2310 to the circuit
- 1 Connect a cable from the PRIMARY TX jack to the IN jack of the DSX-1. Connect a cable from the PRIMARY RX jack to the OUT jack of the DSX-1.
- 2 Press the **RESTART** permanent softkey to clear alarms. Verify the SIGNAL and FRAME LEDs are illuminated (green).
- 3 Select the **Call Sig** Results Category button beside the Primary Results Group selection. Verify that **On Hook** is observed in the Call Sig Results Category display.
- 4 Press the **Off Hook** action button to initiate a call and then **Push 2** Talk to establish voice connection.
- 5 Observe call sequence events as the call is established.

T1 Drop and Insert (Place Call)

Configuring the 2310

- To perform Drop and Insert to place a call
- 1 On the menu bar, press **D&I > D&I Place Call**. The 2310 configures

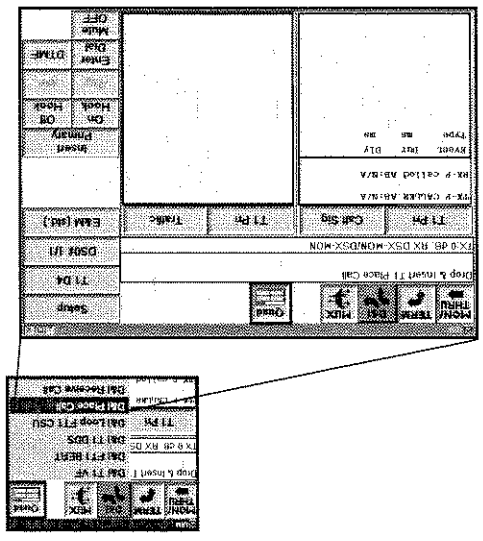

- 2 Press **Setup**. Ensure the characteristics shown in the Summary setup screen match the network characteristics.
- 3 To change baseline settings, select the desired property sheet tabs in the property setup sheets. Set the **Framing**, **Code**, **Rx Input**, and **Channel** tabs to appropriate settings.
- 4 Select the **Trunk** tab. Select the appropriate trunk type (standard E&M, Loop Start, Ground Start). If Loop Start or Ground Start is selected, choose FXS or SLC as the type of card emulation. Remember to also select the appropriate digit type (MF, DP, or DTMF). Press **OK**.

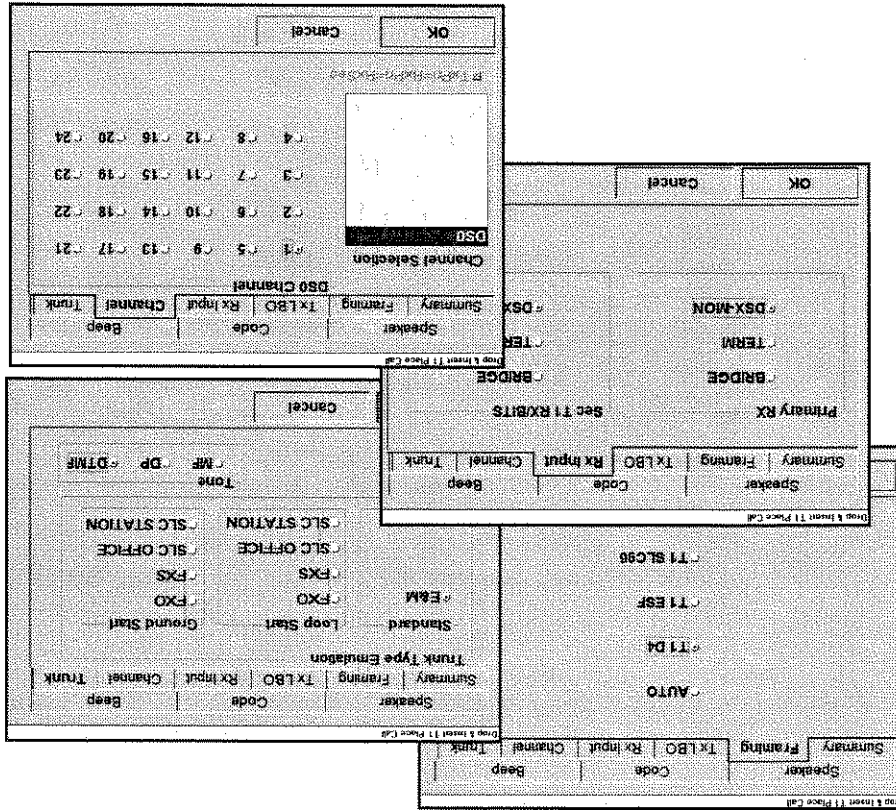

Connecting the 2310 to the circuit

- To connect the 2310 to the circuit
- 1 Connect a cable from the PRIMARY RX jack to the appropriate DSX-1 A-Side MON jack (see Figure 29). The PRIMARY RX must be in the DSX jack facing the direction of the device under test.
 - 2 Connect a cable from the SECONDARY RX jack to the appropriate DSX-1 Z-side MON jack (see Figure 29).
 - 3 Check for FRAME and SIGNAL SYNC.
 - 4 Simultaneously, connect a cable from the Primary TX jack to the appropriate DSX-1 A-side (IN) jack while inserting a 100 ohm terminating plug into the DSX-1 Z-side (OUT) jack. This connection should be on the same side of the DSX as the PRIMARY RX (see Figure 29).

NOTE:

Never insert the terminating plug first.

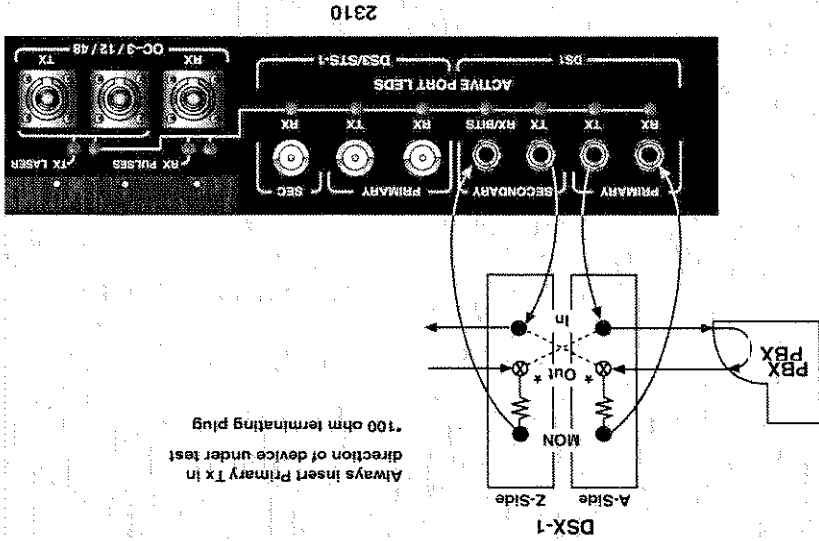
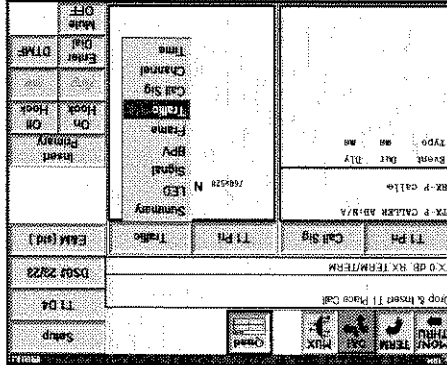

Figure 29 — Drop and Insert test setup

- 9 Press **Off Hook**. Verify that **Off Hook** appears in the Results display, followed by either a **WINK** (on standard E&M trunks) or dial tone (on Loop and Ground Start trunks).
- 10 Press **Push 2 Talk** and speak into the microphone to establish a voice path.
- 11 Dial the test number on the numeric keypad.
- 12 Press **ON Hook** to complete the call.
- 13 Press **DS0# X/X** to select another DS0 channel to test.
- 14 Repeat procedures from Step 11 to continue testing remaining DS0 channels.
- 15 Disconnect from the circuit in the reverse order to prevent service disruption.

Action buttons enable variances in testing



- 5 Press the **RESTART** permanent softkey to clear alarms.
- 6 Verify the Primary and Secondary Results display are illuminated and the Primary and Secondary Results display shows Results ok (under **Summary** Category).
- 7 Press **Insert Primary** > **Enter Dial** to bring up the numerical keypad.
- 8 Select **Call Sig** in left Results Category and **Traffic** in right Results Category. Verify that **ON Hook** is observed in the **Call Sig** Results Category.

Using the VF option

The following procedure outlines how to use the 2310 to monitor DS0 (VF) channels out of a DS1 signal. These tests allow you to

- Qualify voice-grade VF circuits by measuring Signal-to-Noise ratio (S/N), C-Message, and C-Notch.
- Qualify data-grade VF circuits with the 3 KHz Flat, and 3 KHz Notch filters.
- Perform automated frequency sweeps.

The following test enables you to drop and monitor voice frequency channels from a DS1 signal.

VF Channel Drop/ Monitoring from DS1

To drop and monitor DS0 (VF) Channels out of a DS1 signal

- 1 On the menu bar, press **MON/THRU > Monitor T1 > T1 VF**. The unit automatically configures to a default setup.

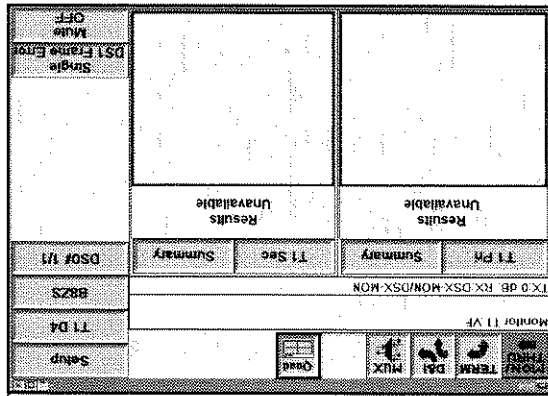
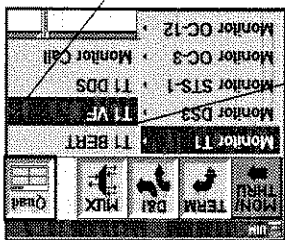

- 2 Press **Setup**. Ensure the characteristics shown in the Summary setup screen match the network characteristics (such as AMI), as well as the desired VF/DS0 channel. To change the settings, select the desired tabs in the property setup sheets.

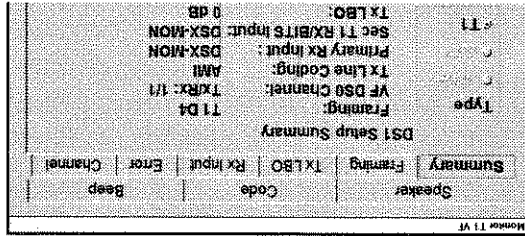

- 3 Press **OK**.

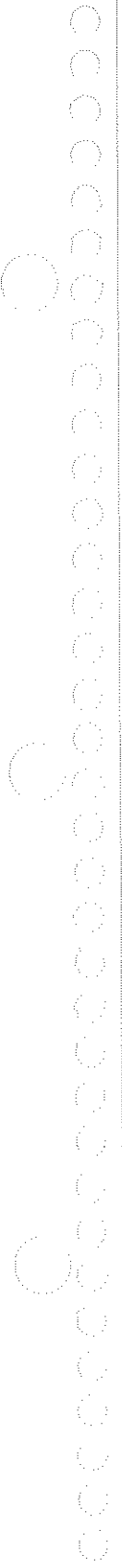

**Connecting the 2310
to the circuit**

- 1 To connect the 2310 to the circuit
- 2 Connect a cable from the PRIMARY and SECONDARY DSI RX jack to the appropriate DSX monitor point.
- 3 Press the **RESTART** permanent softkey to clear alarms and begin the test.
- 4 Verify the green SIGNAL and FRAME LEDs are illuminated and the Primary and Secondary Results displays show Results OK.
- 5 Press **DS0# X/X** to change the channel that is dropped to the speaker if you want to test another channel.
- 6 To adjust the volume level, press the File Cabinet permanent softkey and select the Speaker tab.

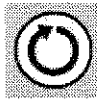
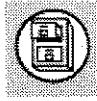

4

If monitoring a second line, press one of the buttons labeled **T1 PRI** in the Results Group window and select **T1 Sec** from the pull-down menu. Set both Results Category buttons to **Channel**.

Category buttons

Results		Results	
T1 Pri	Channel	T1 Sec	Channel

Connecting the 2310
Figure 30 depicts a diagram sample depiction of cable connections from the DSX-1 panel to the inputs on the 2310 for a DS0 (VF) Drop/ Monitor test.

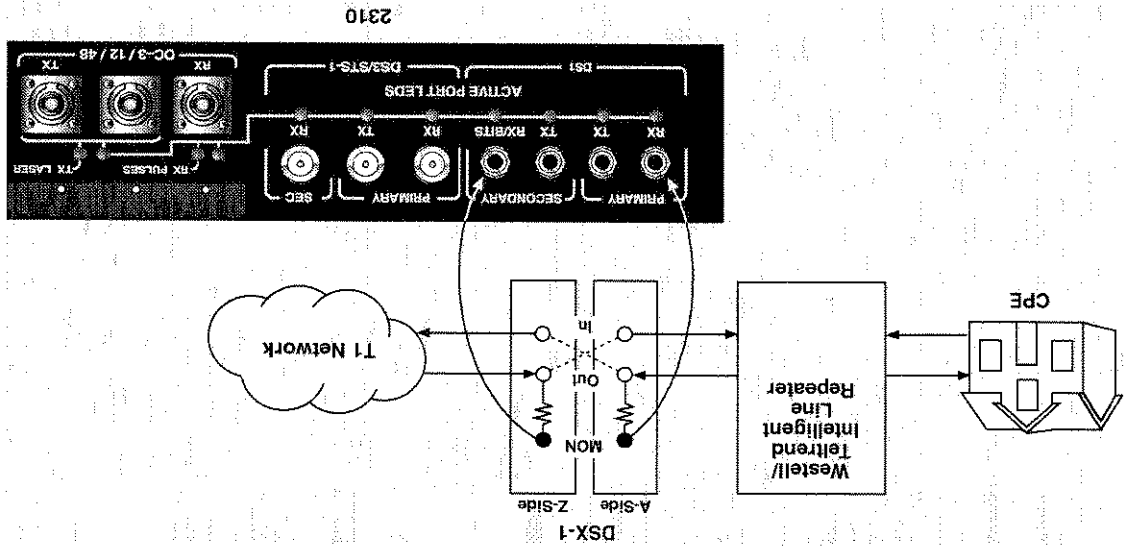
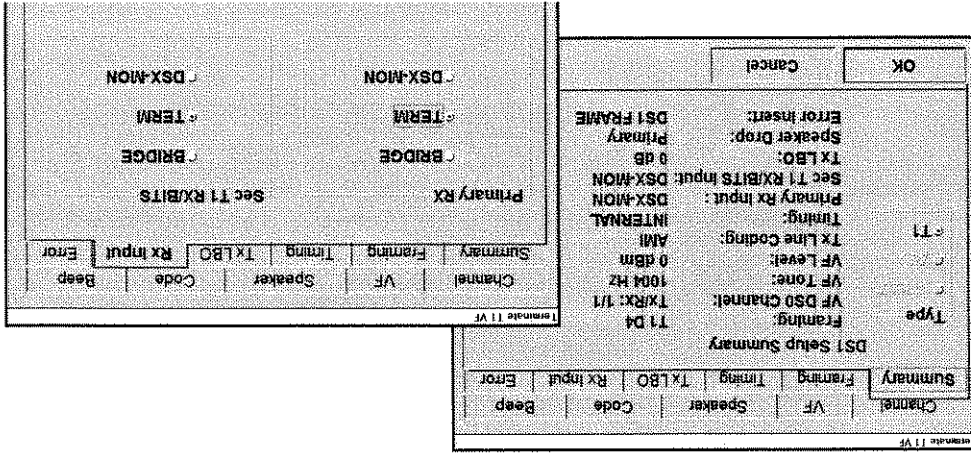
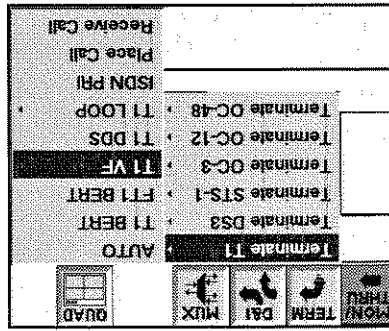

Figure 30 — DS0 (VF) Drop/Monitor test setup



3 Press the **Tx LBO** tab and select the appropriate dB level.

2 Press **Setup**. From the Summary window, select the **RX Input** tab and select **TERM**.



1 On the menu bar, press **TERM > Terminate T1 > T1 VF**. The unit automatically configures to a default setup.
To transmit DS0 (VF) Channels on a DS1 signal

Configuring the 2310

Transmitting VF Tones

The following test enables you to transmit voice frequency tones on a DS1 signal, while terminating the T1 circuit.

Using the VF option



- 4 Press the **Channel** tab and select the appropriate channel to transmit tone.
- 5 Press the **VF** tab and select tone to be transmitted.
- 6 Press the **Timing** tab and set timing to the appropriate setting for the T1 circuit under test.

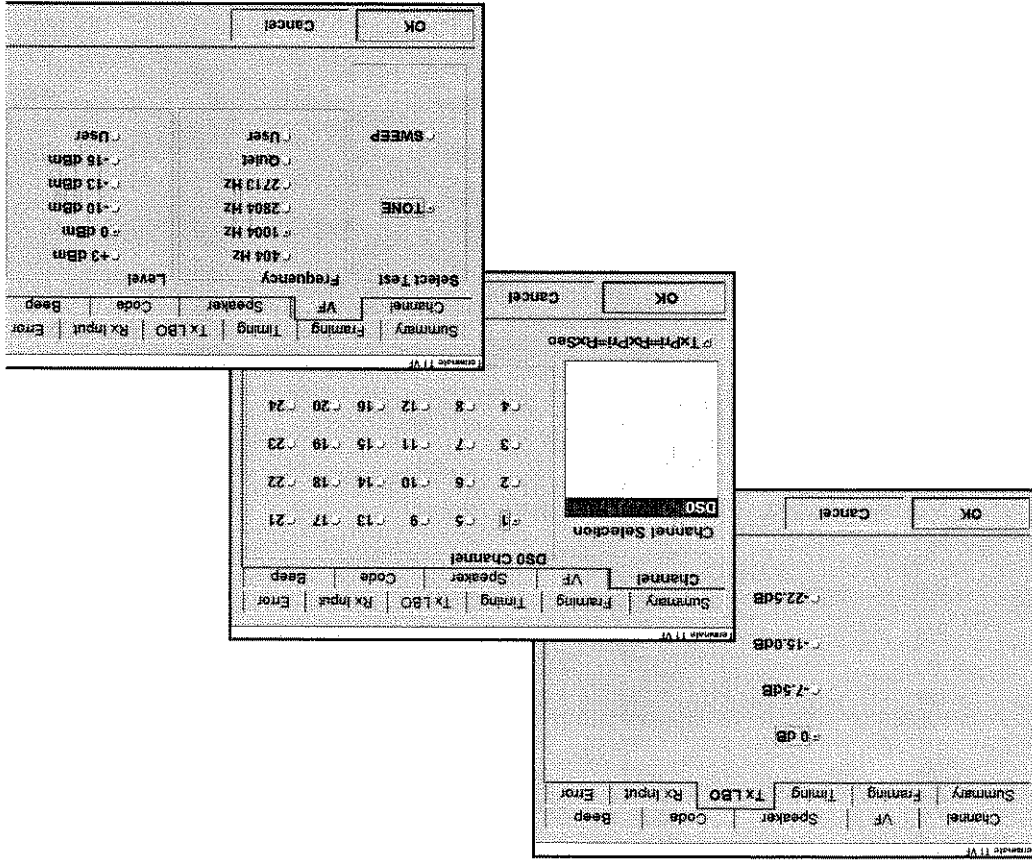

- 7 Press the **Summary** tab. Ensure DSI Framing and TX Line Code settings are correct.
- 8 Press **OK**.
- 9 Verify that the yellow DSI PRIMARY TX and RX active port LEDs are illuminated.

Connecting the 2310 to the circuit

- 1 Connect a cable from the DSI PRIMARY RX jack to the appropriate DSX-1 RX (OUT) jack.
- 2 Connect a cable from the DSI PRIMARY TX jack to the appropriate DSX-1 TX (IN) jack.
- 3 Loop the end of the network to be tested.
- 4 Press the **RESTART** permanent softkey to clear alarms and begin the test.

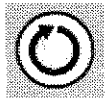

5 Verify the green PRI DSI SIGNAL, and FRAME LEDs are illuminated.

If the Primary DSI signal is free of errors, the Summary Results displays Results OK.

- 6 To view VF measurements, select the channel Results Category.
- 7 Press **DS0# X/X** to change the channel that is dropped to the speaker if you want to test another channel.
- 8 To adjust the volume level, press the File Cabinet permanent softkey and select the Speaker tab.

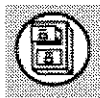
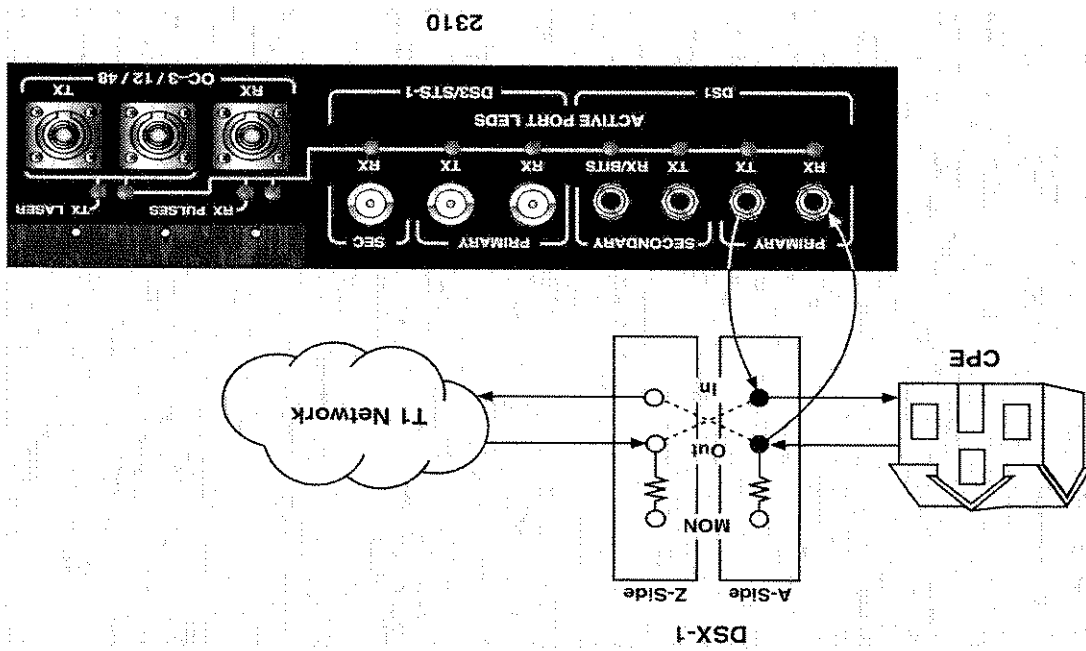

Figure 31 — VF Tone Insertion test setup



Connecting the 2310 to the circuit diagram
Figure 31 is a sample depiction of cable connections from the DSX-1 panel to the inputs on the 2310 for VF Tone Insertion testing.

Using the Intelligent Repeater Span option

The following test application provides an example of how you can sectionalize addressable repeater spans by transmitting appropriate pre-programmed loop codes from the central office (CO).

The Intelligent Repeater Span option provides the intelligent span equipment loop codes used to loop up and loop down individual, addressable, office repeaters and line repeaters, or to transmit maintenance switch commands.

The following devices can be armed, disarmed, queried, and looped back when the TB2310-ILE option is installed.

- Teltrend Model 7231LP IOR/ 7239LP ILR Intelligent Repeaters
- Teltrend Model 9132LP IHR Intelligent Repeater
- Teltrend Model 7231LW IOR / 7239LW ILR Intelligent Repeaters
- Teltrend Model 9132LW IHR Intelligent Repeater
- Westell 3130-80 IOR Intelligent Repeater
- Westell 3150-80 ILR Intelligent Repeater
- Westell 3150-81 ILR Intelligent Repeater
- Westell 3150-56 ILR Intelligent Repeater
- Westell 3151-56 ILR Intelligent Repeater
- Westell 3130-56 IOR Intelligent Repeater
- XEL 7853-200 ILR Intelligent Repeater
- Westell 3171 T1 Network Interface and Maintenance System (60 Series)

This test allows you to qualify T1 circuit error performance by testing for logic errors, BPVs, and frame errors (if applicable) on T1 spans.

To transmit pre-programmed loop codes on addressable repeater

- 1 On the menu bar, press **TERM > Terminate T1 > T1 Loop > Repeater**. The unit automatically configures to a default setup screen.

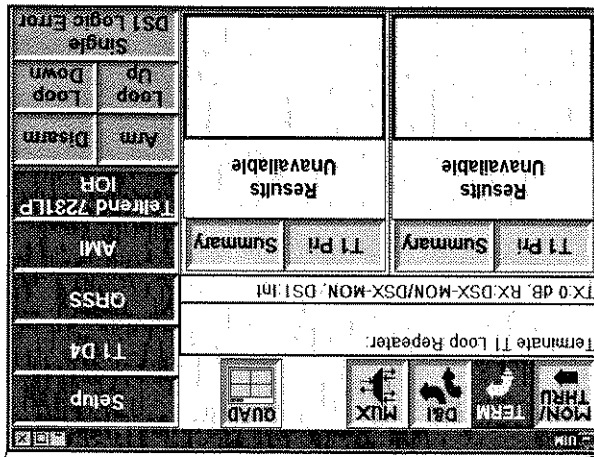
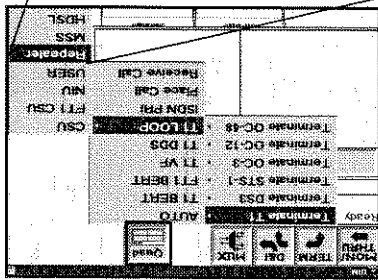

- 2 Press **Setup**. Ensure the characteristics shown in the Summary setup screen match the network characteristics. To change settings, select the desired tabs in the property setup sheets.

NOTE:

Make sure you select the **Receive Input** tab and select **TERM** for each receiver for this test.

- 5 Set Tx Coding as appropriate (B8ZS or AMI).
- 6 Set Timing to INTERNAL if emulating central office equipment, Set Timing to RECOVERED (loop) if emulating customer premises equipment.
- 7 Set Tx LBO to appropriate value (typically 0 dB).
- 8 Set Rx Input to TERM.
- 9 Set Error to DSI LOGIC.
- 10 Set Insertion Type to SINGLE.

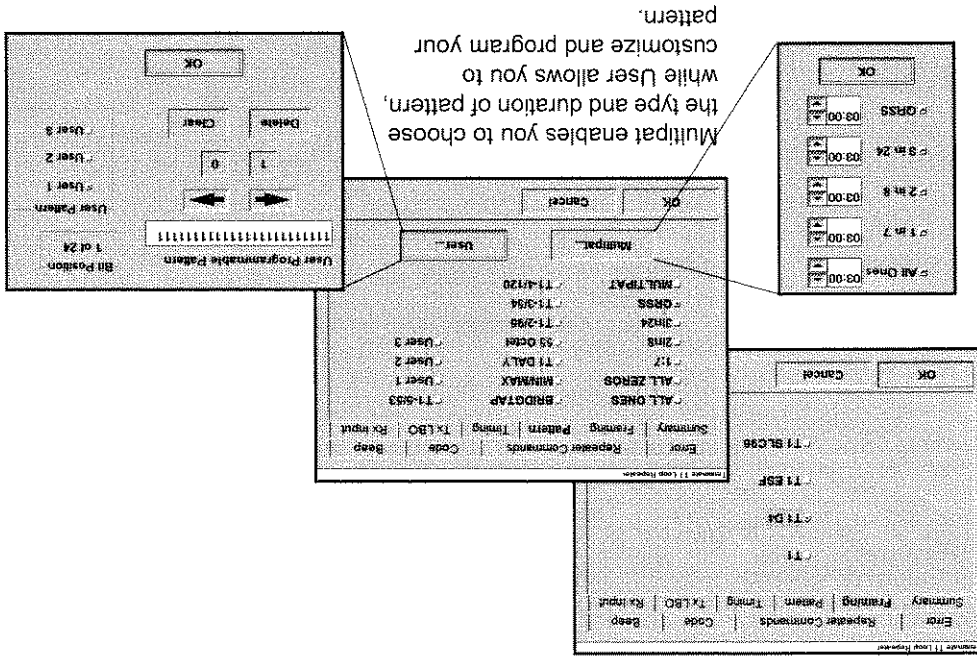

- 3 Select the proper setting in the Framing tab (AUTO, T1, T1D4, T1 ESF, or T1 SLC96).
- 4 Select the proper setting in the Pattern tab.

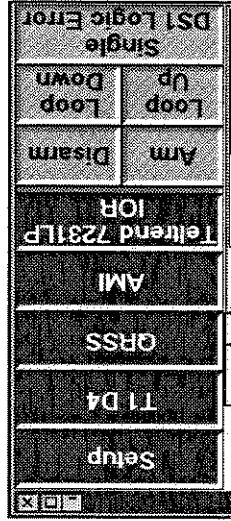

Pressing Arm equips the T1 Span.

Connecting the 2310 to the circuit

- 1 Connect a cable from the PRIMARY TX jack to the appropriate DSX-1 IN jack.
- 2 Connect a cable from the PRIMARY RX jack to the appropriate DSX-1 OUT jack.
- 3 Press Arm.

To connect the 2310 to the circuit

12 Press OK.

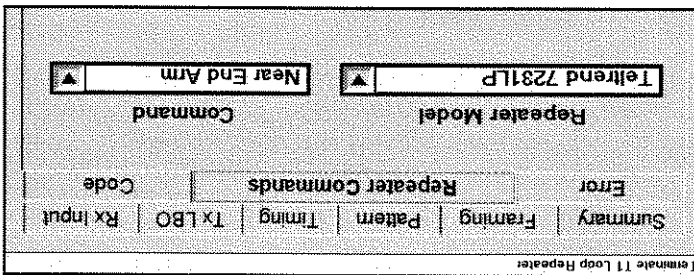

11 Set Repeater Commands to the desired Repeater Model and Repeater Command.

- 4 Press Loop Up.
 - 5 Press the **RESTART** permanent softkey to clear alarms and begin the test.
- 
- 6 Verify the Primary SIGNAL, FRAME, and PATTERN LEDs are illuminated and the Primary Results display shows Results OK.
 - 7 Insert one or two errors by pressing **Start DS1 Logic Error** action button to verify connectivity.

Figure 32 depicts a diagram sample depiction of cable connections from the DSX-1 panel to the inputs on the 2310 for an intelligent repeater loop code test.

Connecting the 2310 to the circuit diagram

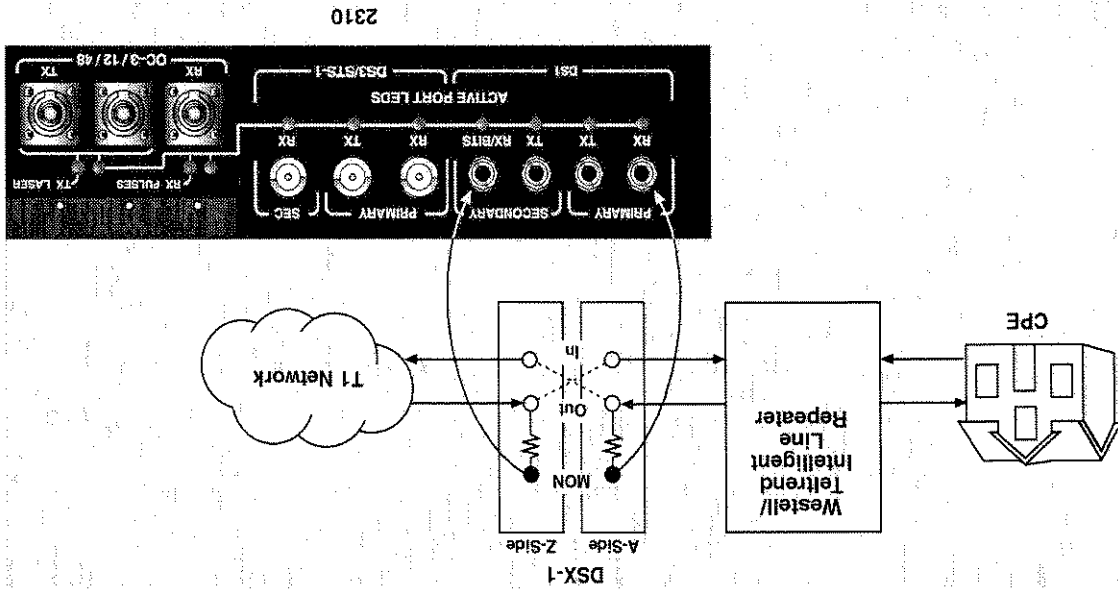

Figure 32 — Intelligent Repeater Loop Code Test Setup

Using the DS3 option

This option adds DS3 testing to the already extensive DS1/DS0 testing capabilities of the 2310. Without adding any size to the existing test set, this option lets you qualify DS3 circuits with BERT patterns for both M13 and C-bit framing, insert patterns on one or all DS3 channels, drop DS1 and DS0 channels from DS3 signals to test and monitor, and verify frame synchronization on DS3 lines.

The following test enables you to monitor DS3 signals.

Monitoring DS3 performance

Configuring the 2310

To monitor the DS3 signal

- 1 On the menu bar, press **MON/THRU > Monitor DS3 > DS3 BERT**.

The unit automatically configures to a default setup for the chosen application.

Initial setup screen for DS3 Monitor testing. You can press Setup to change configurations.

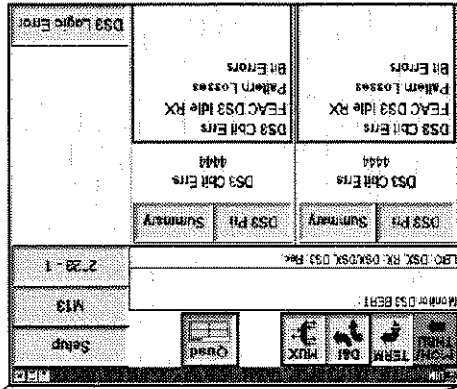
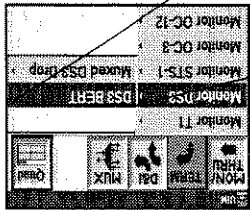

- 2 Press **Setup**. Ensure the characteristics shown in the Summary setup screen match the network characteristics.

3 To change these default settings, select the desired tabs in the property setup sheets.

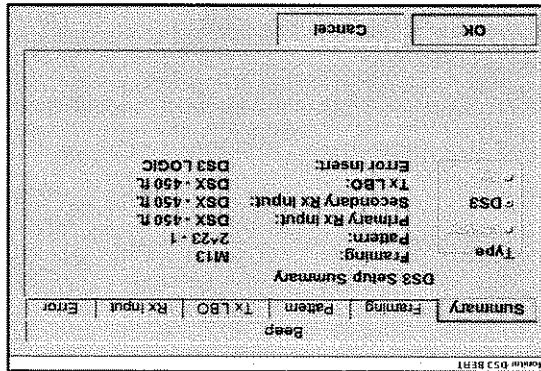

4 Press OK.

5 If monitoring a second signal, press one of the buttons labeled **DS3 PRI** in the Results Group window and select **DS3 Sec**. Set both Category buttons to **Summary**.

NOTE:

The Dual RX option must be present to use the Secondary DS3 receiver.



Category buttons

6 Verify the yellow active port LEDs next to the DS3 PRIMARY RX and SECONDARY RX jacks are illuminated.

Figure 33 — DS3 Monitor test setup

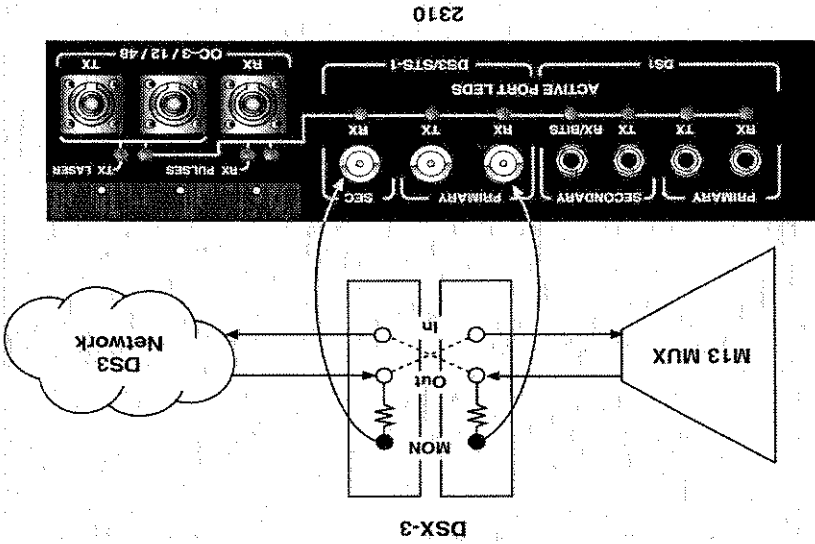

Connecting the 2310 to the circuit diagram

Figure 33 depicts a diagram sample depiction of cable connections from the DSX-3 panel to the inputs on the 2310.

Connecting the 2310 to the circuit

- 1 To configure the circuit
- 1 Connect a cable from the DS3 PRIMARY RX jack to the DSX-3 A-SIDE MON jack.
- 2 Connect a cable from the DS3 SECONDARY RX jack to the DSX-3 Z-SIDE MON jack.
- 3 Press the **RESTART** permanent softkey to clear alarms and begin the test.
- 4 Verify the green **SIGNAL** and **FRAME** LEDs are illuminated and the **PRIMARY** and **SECONDARY** Results displays show **RESULTS OK**.

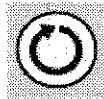

DS3 BER testing

This test lets you qualify DS3 circuits with BERT patterns for both M13 and C-bit framing, insert patterns on one or all DS3 channels, drop DS1 and DS0 channels from DS3 signals to test and monitor, and verify frame synchronization on DS3 lines.

Configuring the 2310

To perform DS3 BER testing

- 1 On the menu bar, press **TERM > Terminate DS3 > DS3 BERT**. The unit automatically configures to a default setup.

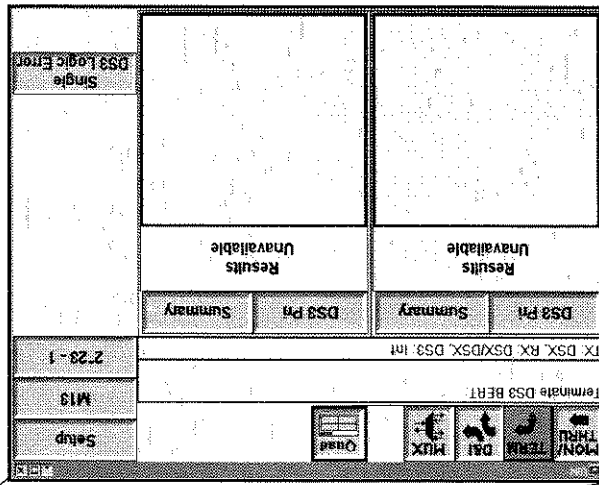
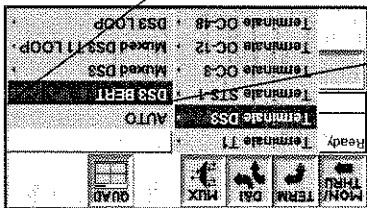

- 2 Press **Setup**. The Summary property sheet displays.
- 3 Press the **Tx LBO** tab and select the appropriate level. (DSX-450 ft. if accessing from DSX-3)
- 4 Press the **Rx Input** tab and select the appropriate receiver input (DSX-450 ft. if accessing from DSX-3).

10 Verify the yellow DS3 PRIMARY RX and TX active port LEDs are illuminated.



Category buttons

- 9 Set the Results Category button to **Summary**.
- 8 Press **OK**.
- 7 Press the **Summary** tab. Ensure the characteristics shown in the setup screen match the network characteristics and test to be performed.

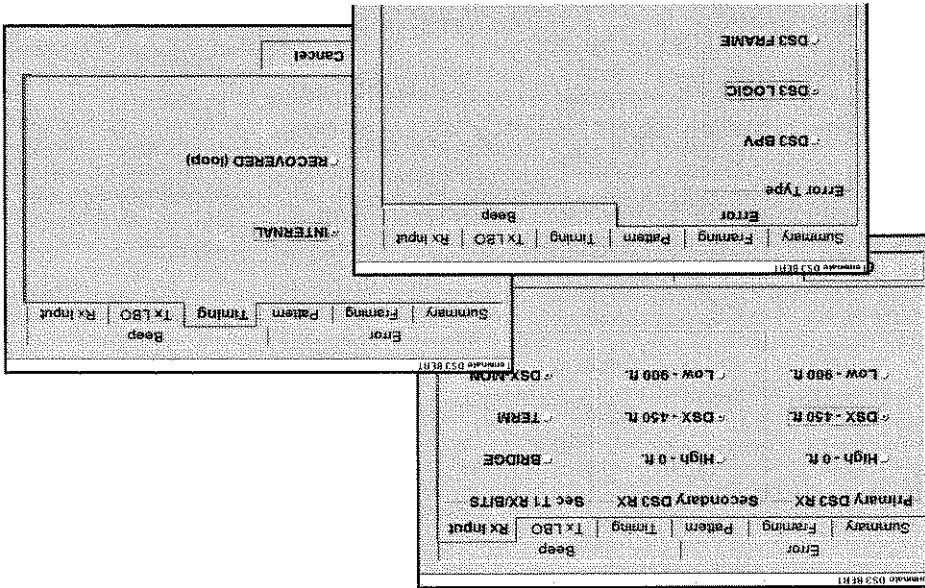

- 6 Press the **Error** tab and select **DS3 LOGIC**.
- 5 Press the **Timing** tab and select the appropriate timing for the DS3 circuit under test.

**Connecting the 2310
to the circuit**

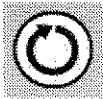
- 1 Connect a cable from the DS3 PRIMARY RX jack to the appropriate side of the DSX-3 RX (OUT) jack.
 - 2 Connect a cable from the DS3 PRIMARY TX jack to the appropriate DSX-3 TX (IN) jack.
 - 3 Loop back the far-end DSX-3 (either manually or by using the DS3 FEAC loop code).
 - 4 Press **RESTART** to clear alarms and begin the test.
- 
- 5 Verify the green **PRI DS3 SIGNAL, FRAME, and PATTERN** LEDs are illuminated and the **SUMMARY Results** displays Results ok.
 - 6 Press the **Logic Error Insert** action button five times. Ensure five logic errors are received in the Results Summary.

Connecting the 2310 Figure 34 is a sample depiction of cable connections from the DSX-3 panel to the inputs on the 2310 for DS3 Termination testing.

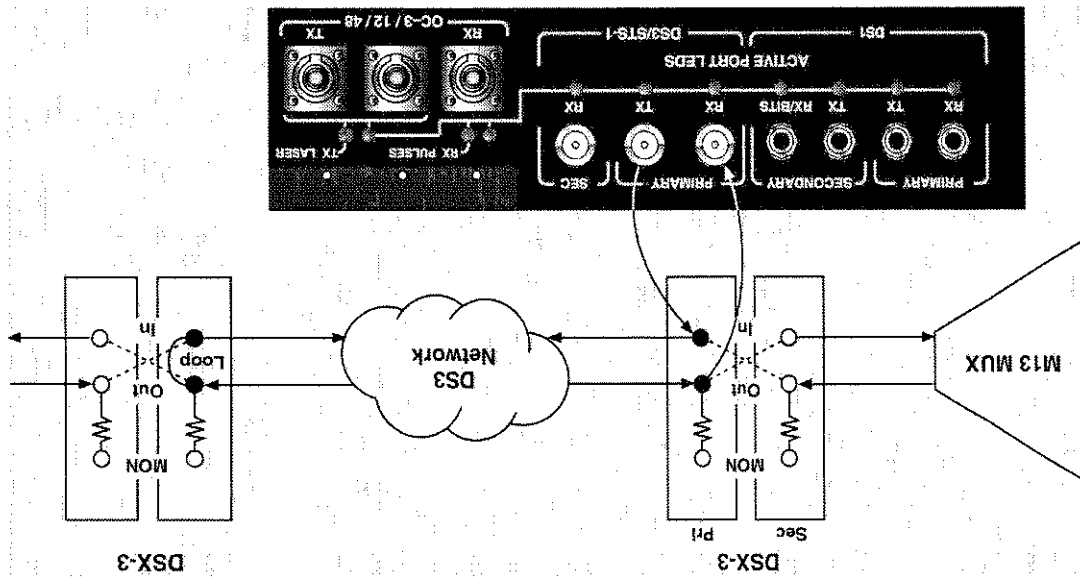

Figure 34 — DS3 Termination test setup

Using the STS-1 option

The STS-1 option provides SONET receive and transmit signal and payload insert error and alarm capabilities at the Synchronous Transport Signal - Level 1 (STS-1) Rate.

The following test enables you to monitor STS-1 signals for framing, path pointer adjustments, and BPVs.

Configuring the 2310

To receive STS-1 signals

- 1 On the menu bar, press **MON/THRU > Monitor STS-1** and the appropriate payload mapping (in this case, **DS3 Drop** was chosen). The unit automatically configures to a default setup for the chosen application.

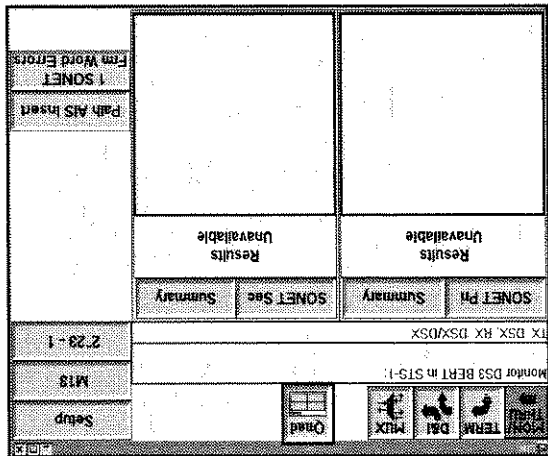
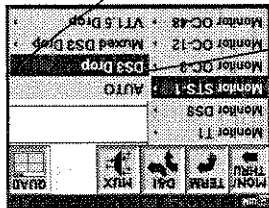

2 Press **Setup**. Ensure the characteristics shown in the Summary setup screen match the network characteristics.

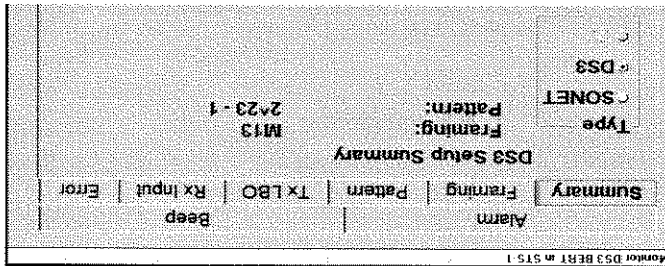

3 To change these default settings, select the desired tabs in the property setup sheets. Note the differences between the baseline DS3 setup property sheets and the baseline STS-1 setup property sheets.

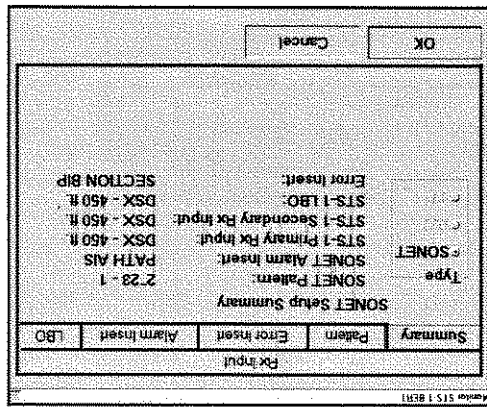

Property setup tabs for STS-1 Monitor Testing. You can press any tab to change configurations.

4 Press **OK**.

5 If monitoring a second signal, press one of the buttons labeled **SONET Prt** in the Results Group window and select **SONET Sec**. Set both Category buttons to **Summary**.

**Connecting the 2310
to the circuit**

- 1 To connect the 2310 to the circuit
Connect a cable from the STS-1 PRIMARY RX jack to the STS-1 PRIMARY MON jack.
- 2 Connect a cable from the STS-1 SECONDARY RX jack to the STS-1 SECONDARY MON jack.
- 3 Press the **RESTART** permanent softkey to clear alarms and begin the test.
- 4 Verify the green SIGNAL, FRAME, PATTERN, and PATH PTR LEDs are illuminated and the Primary and Secondary Results displays show Results OK.

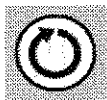

NOTE: The Dual RX option must be present to use the Secondary STS-1 receiver.

SONET Pr		Results	
Summary	SONET Pr	Summary	Results

Category buttons

Using the STS-1 option

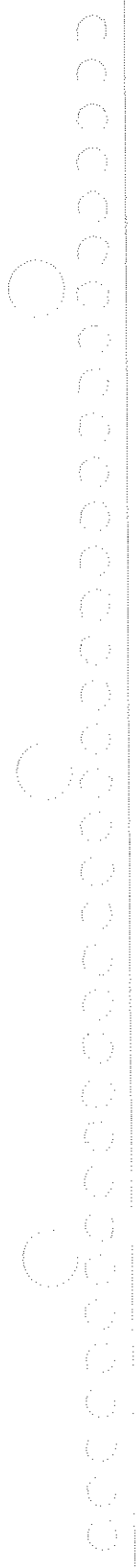

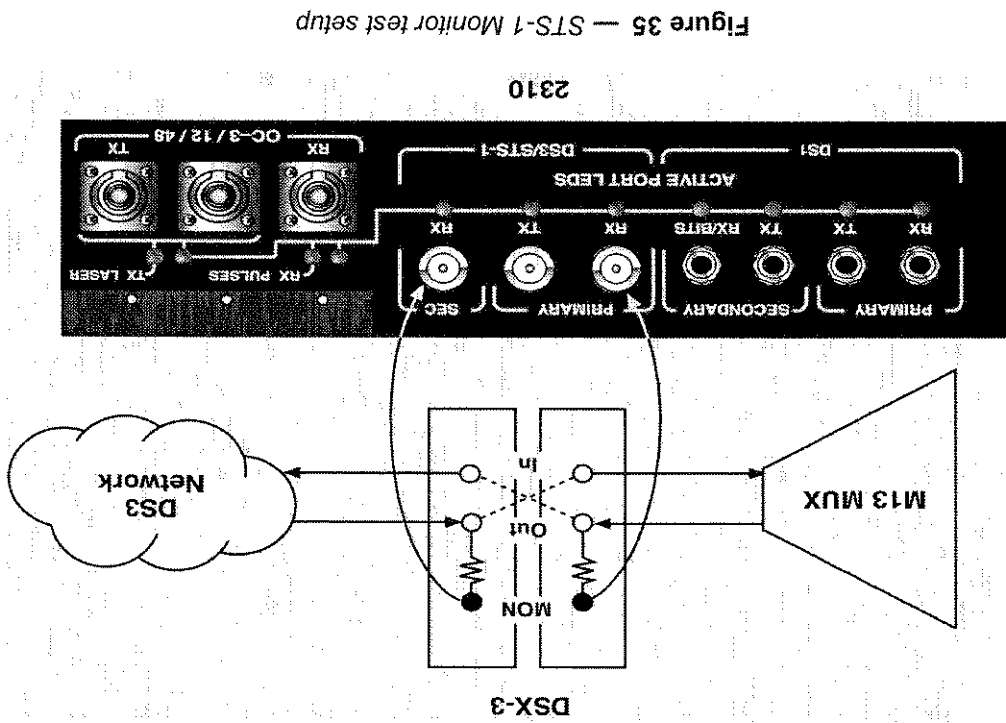
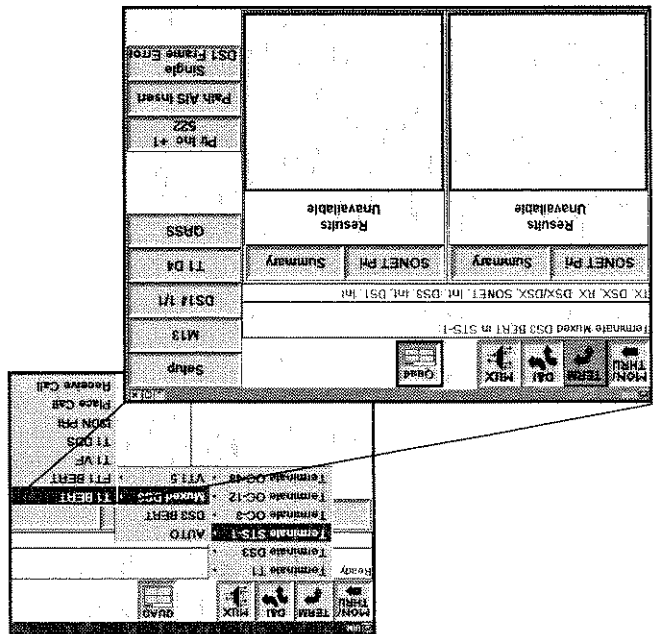
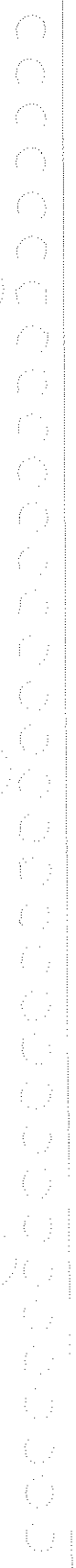

Figure 35 — STS-1 Monitor test setup

Connecting the 2310 to the circuit diagram
Figure 35 depicts a diagram sample depiction of cable connections from the DSX-3 panel to the inputs on the 2310.



Configuring the 2310

The following test enables the 2310 to perform STS-1 BER tests with a DS3 or VT1.5 muxed payload.

To transmit the DS3 signal on an STS-1 rate

- 1 On the menu bar, press **TERM > Terminate STS-1** and the appropriate payload mapping (in this case, **Muxed DS3** and **T1 BER** were chosen). The unit automatically configures to a default setup for the chosen application.

STS-1 BER testing

Using the STS-1 option



- 2 Press **Setup**. Ensure the characteristics shown in the Summary setup screen match the network characteristics.

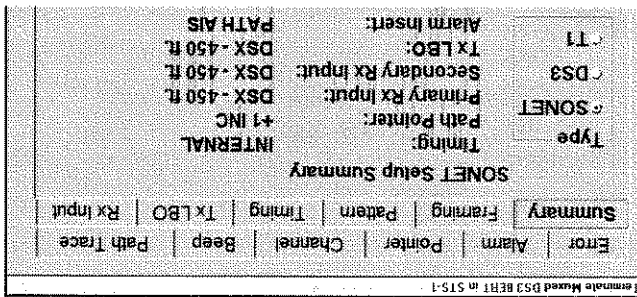

- 3 To change these default settings, select the desired tabs in the property setup sheets.

- 4 Press **OK**.

- 5 Set one Results Group to **SONET Pri** and the other to **T1 PRI**, and set the Category buttons to **Summary**.

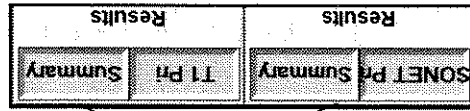

- 6 Verify the yellow active port LEDs next to the STS-1 PRIMARY TX and RX jacks are illuminated.

Connecting the 2310 to the circuit

- To connect the 2310 to the circuit
- 1 Connect a cable from the STS-1 PRIMARY RX jack to the DSX OUT jack.
 - 2 Connect a cable from the STS-1 PRIMARY TX jack to the DSX IN jack.
 - 3 Establish a far-end loop.

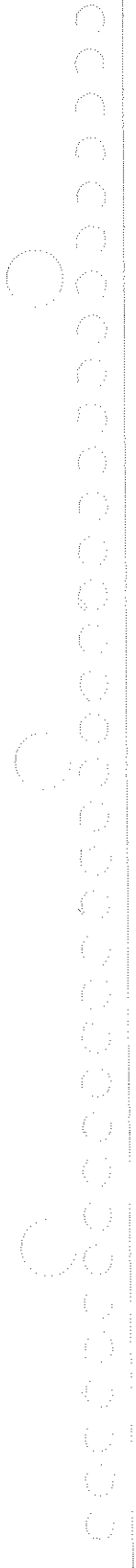

Using the STS-1 option

- 4 Press the **RESTART** permanent softkey to clear alarms and begin the test.
- 5  Verify the green **SIGNAL**, **FRAME**, and **PATTERN** for T1 and **SONET** signals (and **PATH** LEDs for **SONET** only) are illuminated, and the Primary and Secondary Results displays show Results OK.

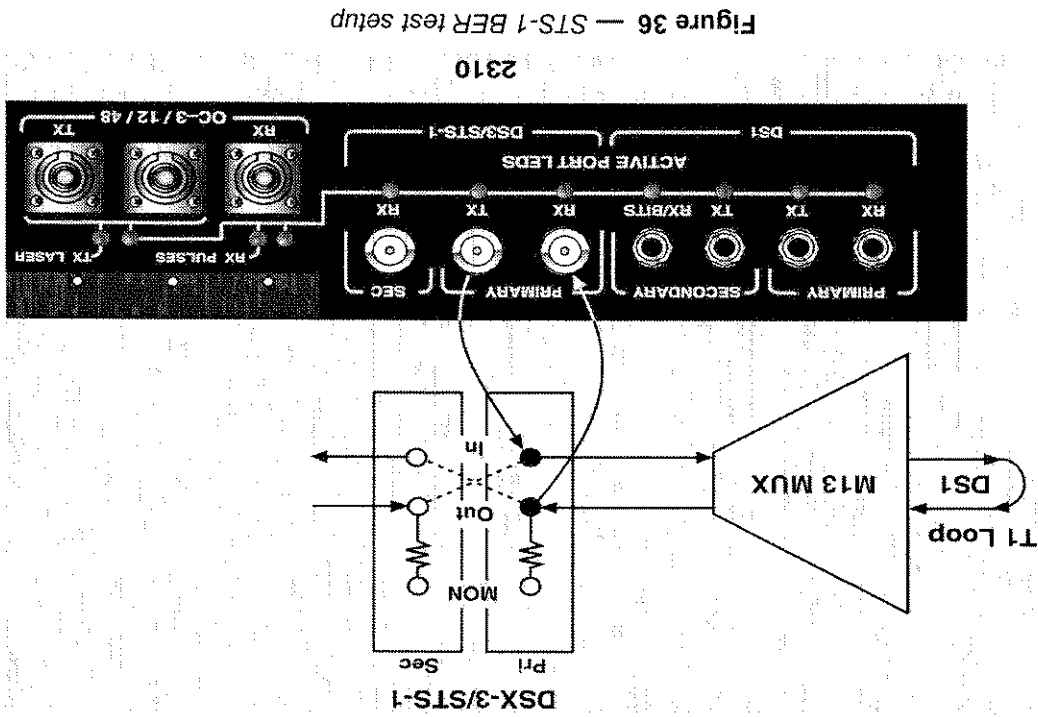
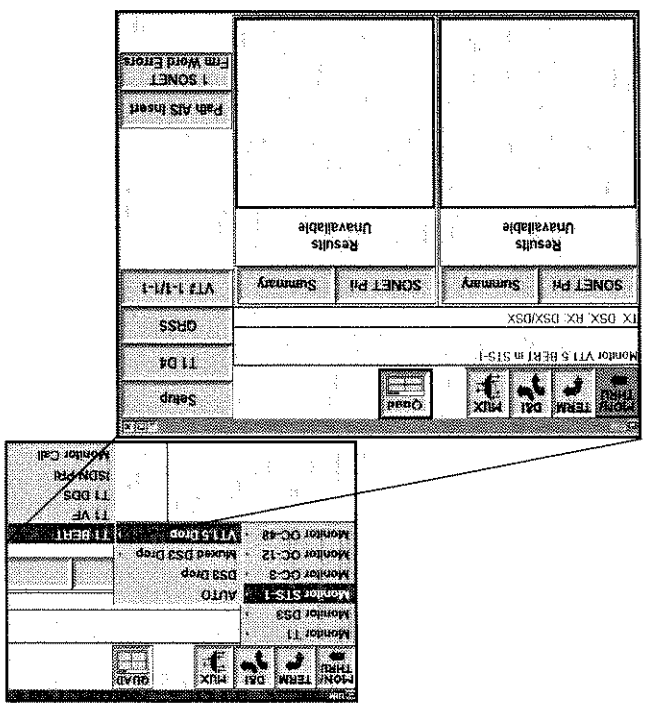

Figure 36 — STS-1 BER test setup

Connecting the 2310 to the circuit diagram
 Figure 36 depicts a diagram sample depiction of cable connections from the STS-1 panel to the inputs on the 2310.

- 2 Press **Setup**. Ensure the characteristics shown in the Summary setup screen match the network characteristics.
- 3 To change these baseline settings, select the desired tabs in the property setup sheets.



- 1 On the menu bar, press **MON/THRU > Monitor STS-1** (or **OC-3/OC-12/OC-48 > VT1.5 Drop > T1 BERT**). The unit automatically configures to a default setup for the chosen application. To receive VT1.5 or DS1 signals dropped from an STS-1 rate

The following procedure outlines how to setup the 2310 to monitor VT1.5 or DS1 signals dropped from an STS-1 signal.

VT1.5 Drop/ Monitoring from STS-1

Configuring the 2310

Using the STS-1 option

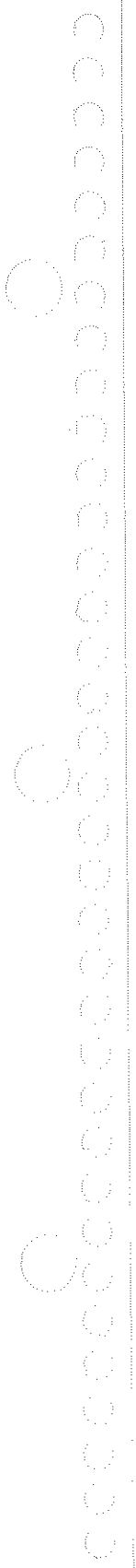

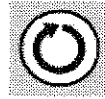

Connecting the 2310 to the circuit

- 1 To connect the 2310 to the circuit
- 1 Connect a cable from the DS3/STS-1 PRIMARY and SECONDARY RX jack to the Primary and/or Secondary side of the DSX-3/STX-1 MON jack.
- 2 Press the **RESTART** permanent softkey to clear alarms and begin the test.

- 7 Verify the yellow active port LEDs next to the DS3/STS-1 PRIMARY RX and SECONDARY RX jacks are illuminated.



Category buttons

- 4 Press **OK**.
- 5 Press the **SONET Pri** button in one Results Group and the **T1 Pri** button in the second Results Group.
- 6 Set both Results Category buttons to **Summary**.

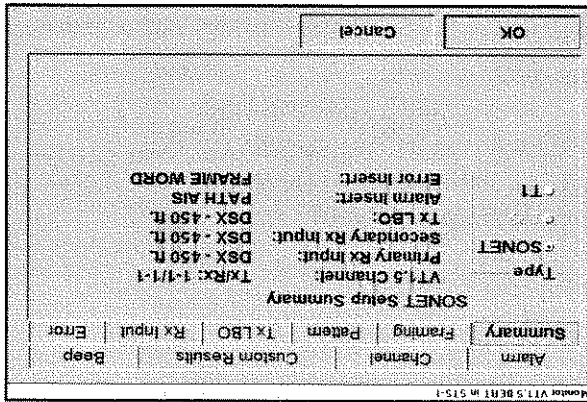

Property setup tabs for VT 1.5 from an STS-1 Monitor testing. You can press any tab to change configurations.

- 3 Verify the green SIGNAL, FRAME, PATTERN, and PATH PTR LEDs are illuminated and the Primary and Secondary Results displays show Results ok.

Figure 37 depicts a diagram sample depiction of cable connections from the DSX-3/STS-1 panel to the inputs on the 2310 for a DS1/VT1.5 Drop/Monitor test.

Connecting the 2310 to the circuit diagram

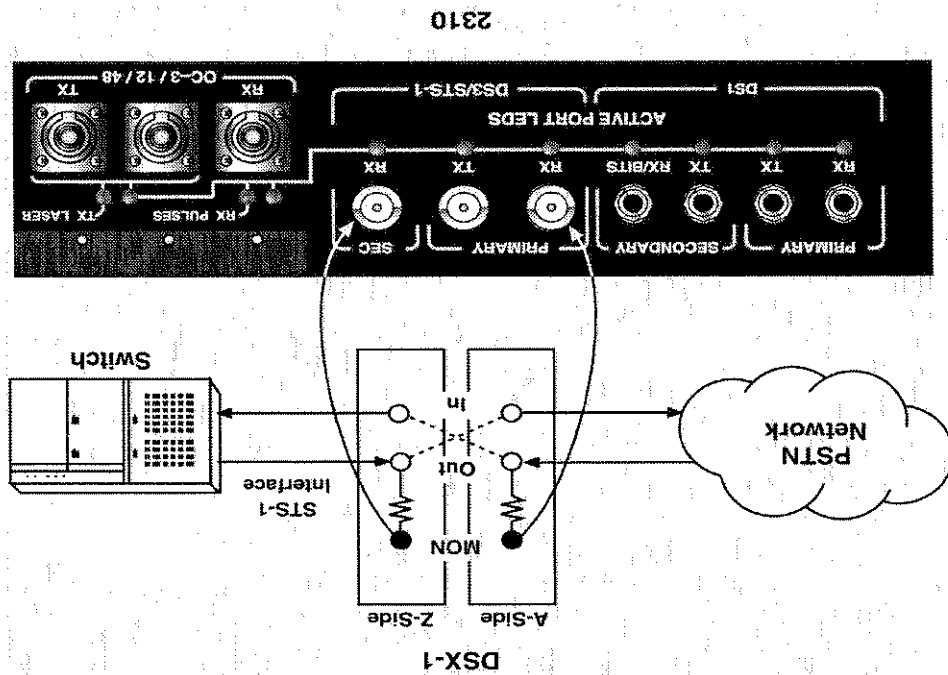
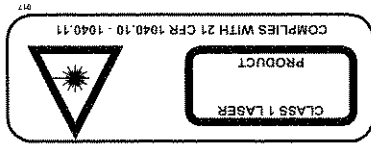

Figure 37 — STS-1/NT 1.5 Drop/Monitor test setup

Using the OC-3/OC-12/OC-48 option

The OC-3/OC-12/OC-48 option enables transmitting or receiving SONET signals from optical carriers, as well as, concatenated Optical Carrier- Levels OC-3/12/OC-48 signals. It can analyze signal overhead and drop/insert DS3 or DS1 payloads.

Cautions must be observed before and during all phases of instrument operation. The following symbol designates that the 2310 is a Class I Laser product and you must be careful not to incur hazardous laser light exposure. This symbol carries the following warning:



WARNING: HAZARDOUS LASER LIGHT EXPOSURE!



Do not look directly into the 2310 optical output. The optical source is designed for safe Class I operation. However, it is recommended that you not look directly into the optical output of the unit or at the output of any optical cable connected to the unit. If a fiber optic connection is removed from a transmitting connector, screw the safety cap onto the connector to prevent inadvertent exposure to the laser output. Use of controls, adjustments or procedures other than those specified herein may result in hazardous laser light exposure.

Monitoring OC-3/ OC-12/OC-48 performance

The following procedure outlines how to setup the 2310 to monitor and perform error/alarm insertion using the Thru mode.

Configuring the 2310

- To monitor an OC-3/OC-12/OC-48 rate
- 1 On the menu bar, press MON/THRU > Monitor OC-3/OC-12/OC-48 > OC-3c/OC-12c/OC-48c BERT. The unit automatically configures to a default setup screen.

OC-3c BERT is similar to the OC-12c/48c menu with the exception that you cannot test OC-12c from the OC-3 menu. In the same manner, you cannot test OC-48c from the OC-12 menu.

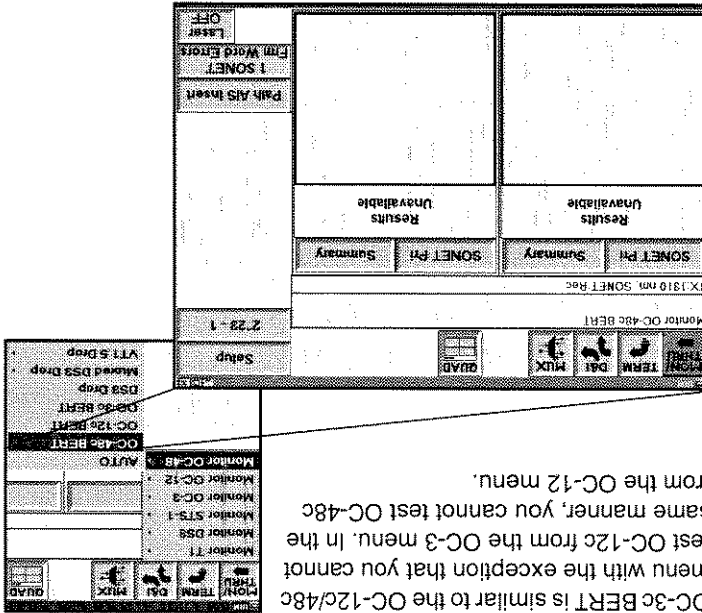

- 2 Press Setup. The Summary property sheet displays.

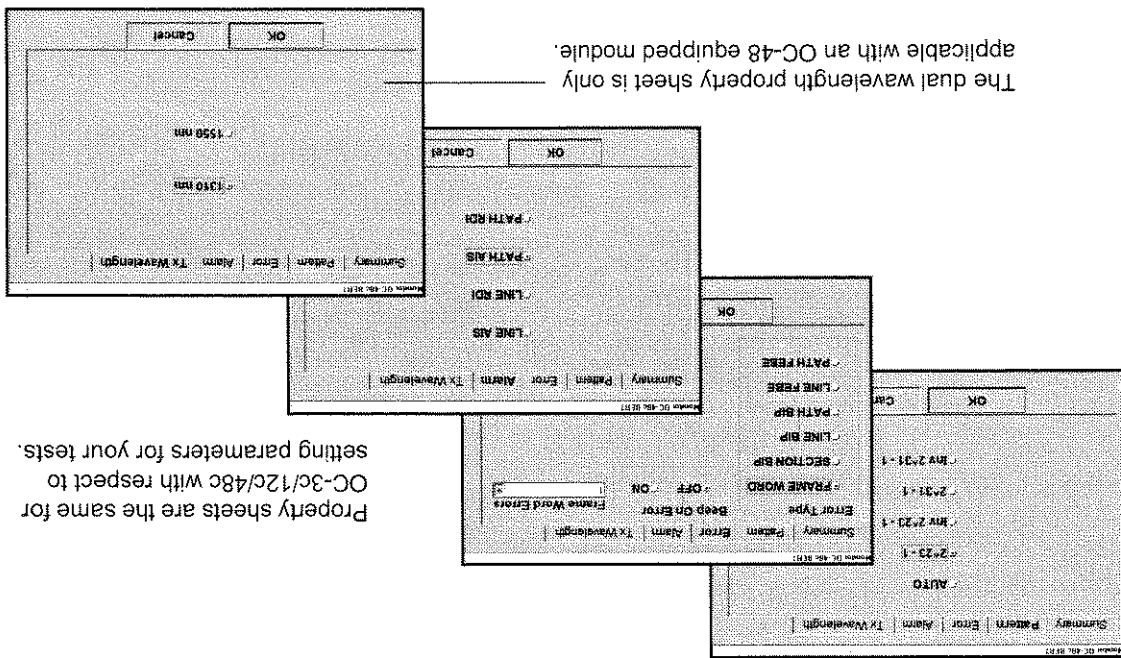

The dual wavelength property sheet is only applicable with an OC-48 equipped module.

Property sheets are the same for OC-3c/12c/48c with respect to setting parameters for your tests.

- 4 Set parameters for **Pattern**, **Error**, **Alarm**, and **TX Wavelength** tabs. to be performed. Press **OK**.
- 3 Press the **Summary** property sheet tab. Ensure the settings shown in the **Summary** tab match the network characteristics and the test

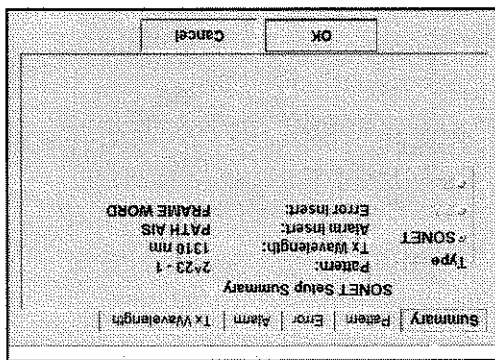

Using the OC-3/OC-12/OC-48 option



5 Verify the yellow active port LEDs next to the OC-3/OC-12/OC-48 jacks are illuminated.

Connecting the 2310 to the circuit

- To connect the 2310 to the circuit
- 1 Connect a fiber cable from the OC-3/OC-12/OC-48 RX jack to the network's RECEIVE optical splitter access jack.
 - 2 Press the **RESTART** permanent softkey to clear alarms and begin the test.

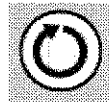

3 Verify the green **SONET SIGNAL**, **FRAME**, and **PATH PTR** LEDs are illuminated (green) and the Results Window displays Results OK.

4 Press the **RESTART** permanent softkey to clear old test results and start a new test.

5 Verify test results in the Results display windows. If the signal is error free, Results OK displays.

Connecting the 2310 to the circuit diagram
Figure 38 is a sample depiction of cable connections from the OC-3c/12c/48c panel to the inputs on the 2310 for OC-3/OC-12/OC-48 for in-service monitoring and error/alarm insert testing.

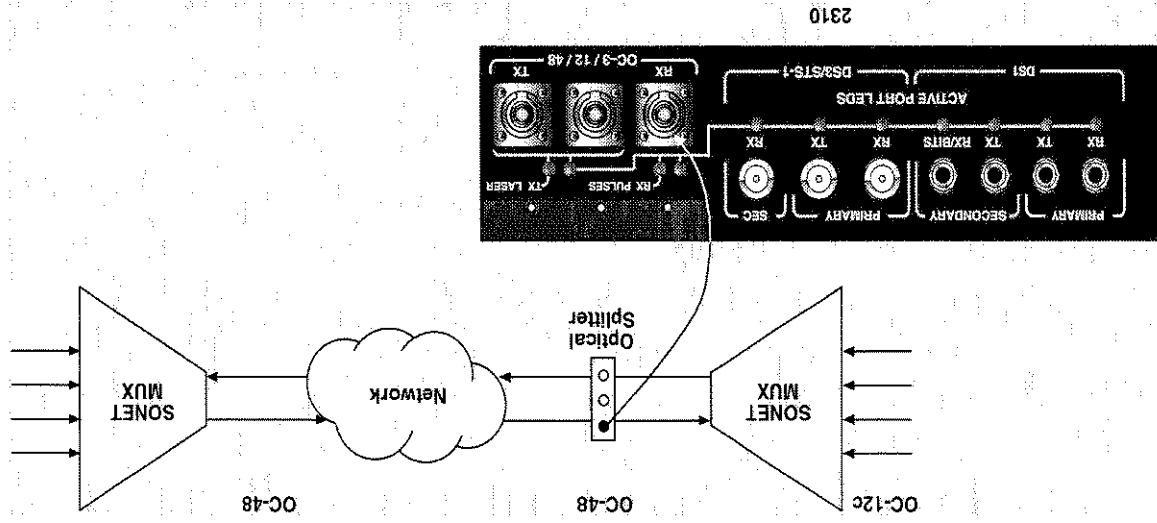

Figure 38 — MON/THRU Mode Error/Alarm Insert test setup

OC-3/OC-12/OC-48 BER testing

The following procedure outlines how to setup the 2310 to terminate a SONET signal for BER testing and perform Error/Alarm Insertion on concatenated SONET signals.

WARNING: DAMAGE TO TEST PAD



Never loop the high-power TRANSMIT on OC-48 modules to the RECEIVE of the 2310. It will result in serious damage to the 2310.

Configuring the 2310

- 1 To test an OC-3/OC-12/OC-48 rate for BER testing
- 1 On the menu bar, press **TERM > Terminate OC-3/OC-12/OC-48 > OC-3c/OC-12c/OC-48c BERT**. The unit automatically configures to a default setup.

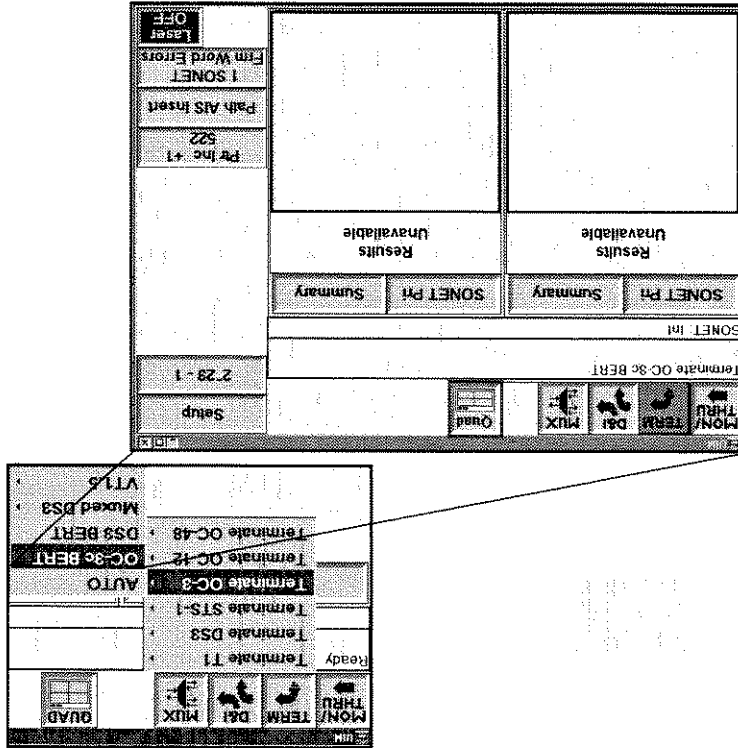

5 Press OK.

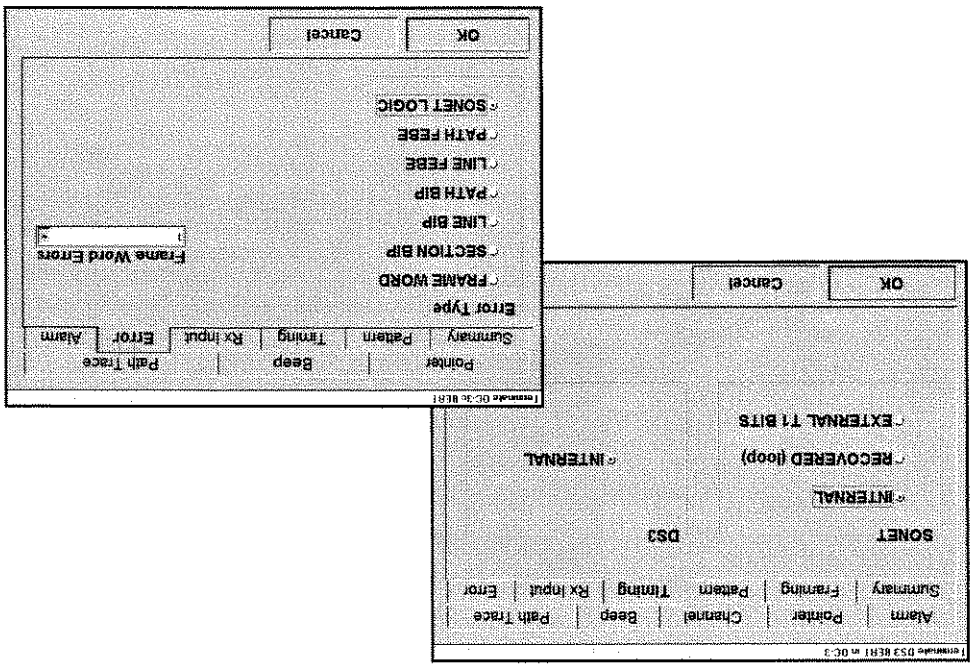

4 Press the Error tab. Select SONEt LOGIC.

3 Press the Timing tab. If an external timing source is used, select EXTERNAL T1 BITS. If the timing is received from the network, select RECOVERED. If the 2310 is the timing source, select INTERNAL.

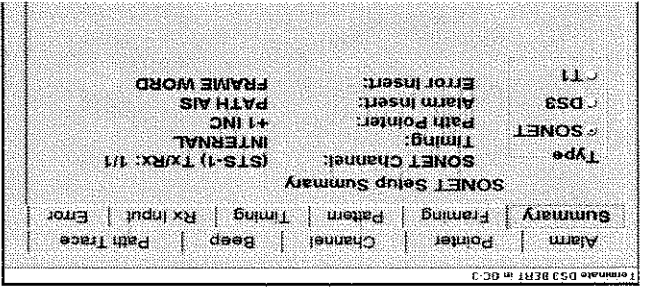

2 Press Setup. The Summary property sheet displays.

Using the OC-3/OC-12/OC-48 option



- 6 Verify the green **PRI SONE**T SIGNAL, **FRAME**, **PATTERN**, and **PATH PTR** LEDs are illuminated and the Results Window displays Results OK.



- 5 Press **RESTART** to clear alarms and begin the test.
- 4 Loop back the far-end of the network.

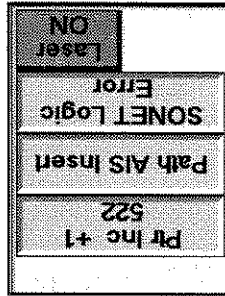

- 3 Press the **Laser ON** action button.
- 2 Connect a fiber cable from the network's **TRANSMIT** optical access jack to the network's **RECEIVE** optical access jack.
- 1 Connect a fiber cable from the OC-3/OC-12/OC-48 **RX** jack to the network's **RECEIVE** optical access jack.

Connecting the 2310 to the circuit

To connect the 2310 to the circuit

- 7 Verify the yellow OC-3/OC-12/OC-48 active port LEDs are illuminated.

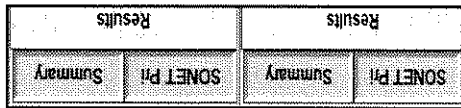

- 6 Set the Results Category button to **Summary**.
Category buttons

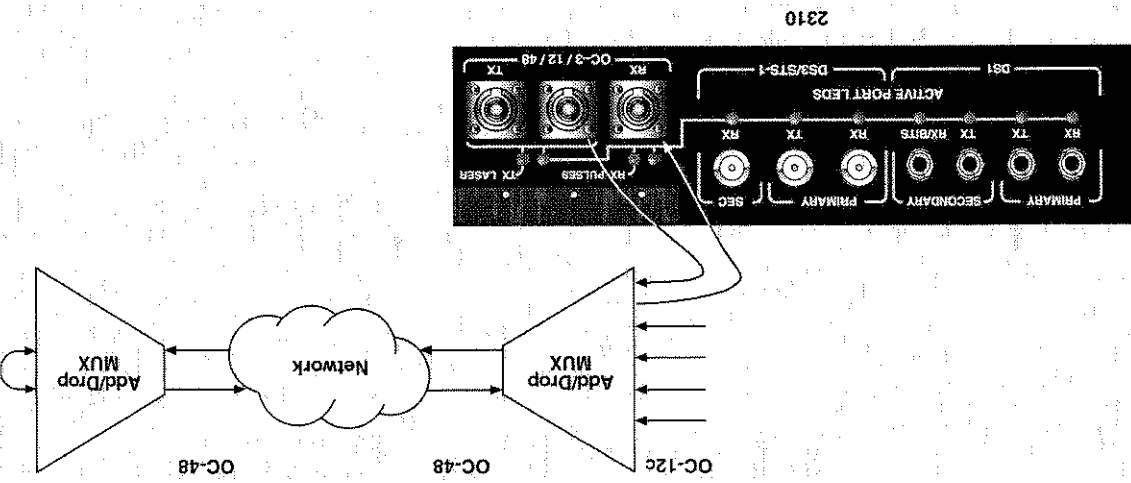

Figure 39 — SONET Termination BER test setup

Connecting the 2310 to the circuit diagram

Figure 39 is a depiction of cable connections from a SONET signal to the input/output on the 2310 for a SONET Termination BER test.

- 7 Press **SONET Logic Error** on the main screen five times to insert errors. Verify five logic errors are received.
- 8 Press **RESTART** to clear old test results and start a new test.

Using the OC-3/OC-12/OC-48 option

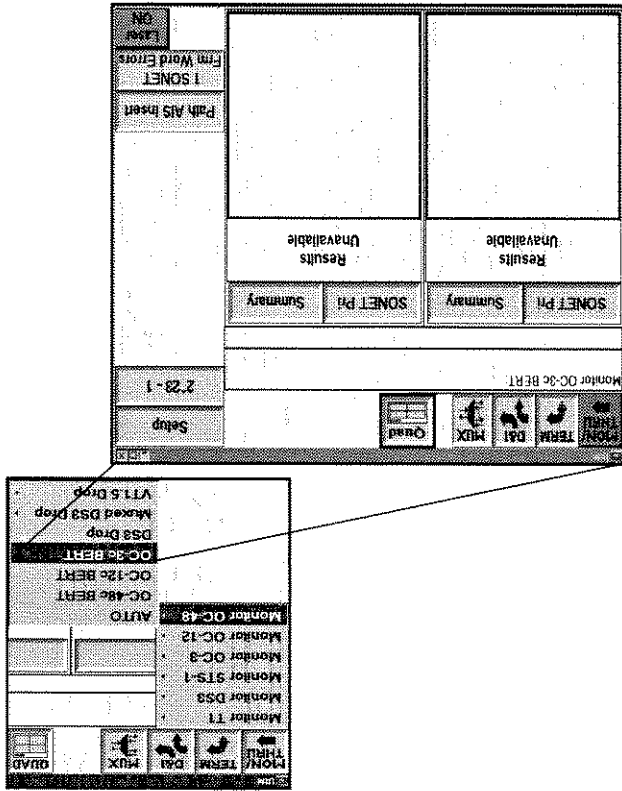

- To measure optical power in an OC-3/OC-12/OC-48 rate
- 1 On the menu bar, press **MON/THRU** > **Monitor OC-3/OC-12/OC-48** > **OC-3c/OC-12c/OC-48c BERT**. The unit automatically configures to a default setup.

Configuring the 2310

Optical Power measurement

This test measures the optical power of a signal in an optical fiber. The following symbol refers to Class 1 laser products. Refer to the warning for Class 1 laser products on page 125 and follow all precautions.

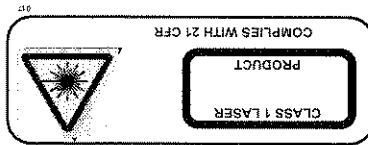

**Connecting the 2310
to the circuit**

- 1 Connect the fiber to be tested to the OC-3/OC-12/OC-48 RX jack.
- 2 Press the **RESTART** permanent softkey to clear alarms and begin the test.
- 3 Ensure the green PRI SONET SIGNAL LED is illuminated.
- 4 Read the optical power measured in the Results Screen.



To connect the 2310 to the circuit

- 3 Verify that the yellow OC-3/OC-12/OC-48 active port LEDs are illuminated.

Results		Results	
SONET Pn	Signal	SONET Pn	Signal

Category buttons

- 2 Set Category buttons to **Signal**, then select **Optical Power dBm** at 1310 nm or 1550 nm.

Using the OC-3/OC-12/OC-48 option



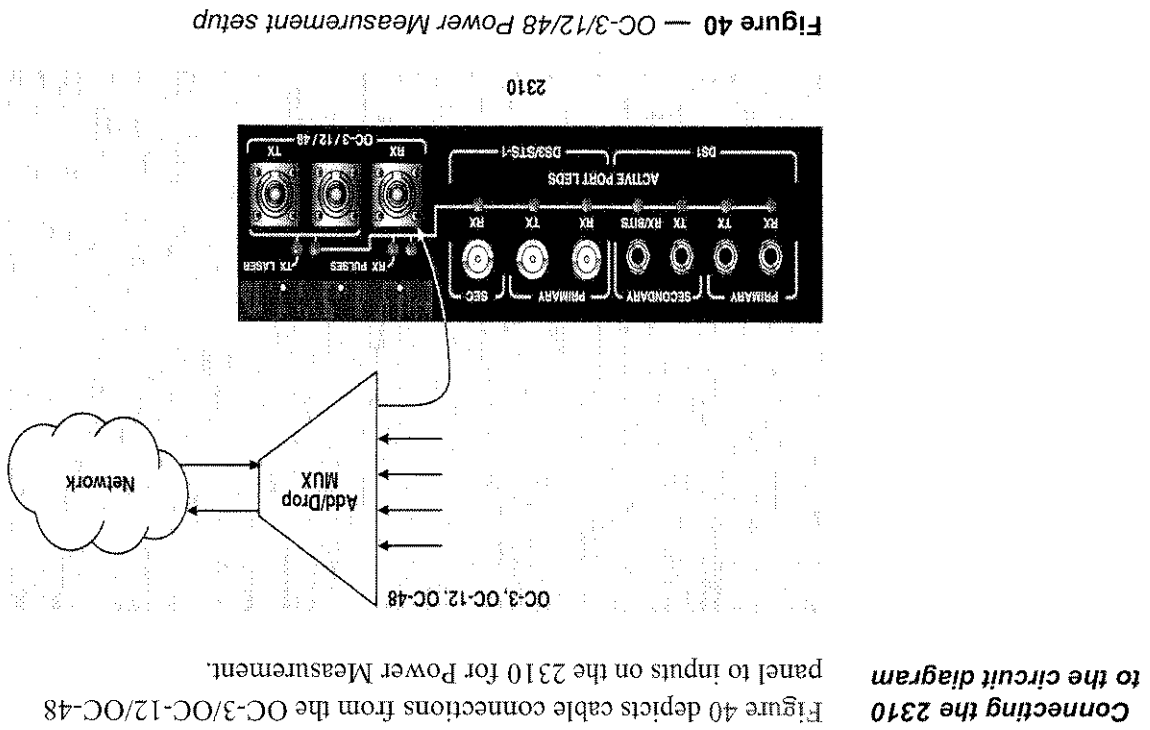

Figure 40 — OC-3/12/48 Power Measurement setup

Using the VT100 Emulation option

The 2310 can be configured to perform VT-100 terminal emulation. For this function, the TB2310-VT100 option is required.

In this mode, you can locally access network components, such as HDLSL units or performance monitoring devices (e.g., PMNIU or PMDNI), and provision them or obtain performance information from them. When the VT100 option is installed in your 2310, there is no need to carry a laptop computer to do VT100 emulation.

Configuring the 2310

To do VT-100 terminal emulation

- 1 Connect the RS-232 interconnect cable (supplied) from the printer port on the 2310 to the network device under test (e.g., HDLSL unit). If necessary, connect a "gender changer" to the DB-9 connector end.

NOTE:

There are two interconnect cables provided with 2000 products; you must verify that the 9-pin connector is used for the VT100 Emulator.

- 2 Access the VT100 emulator by pressing the **Aux** permanent softkey icon (file cabinet).

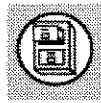

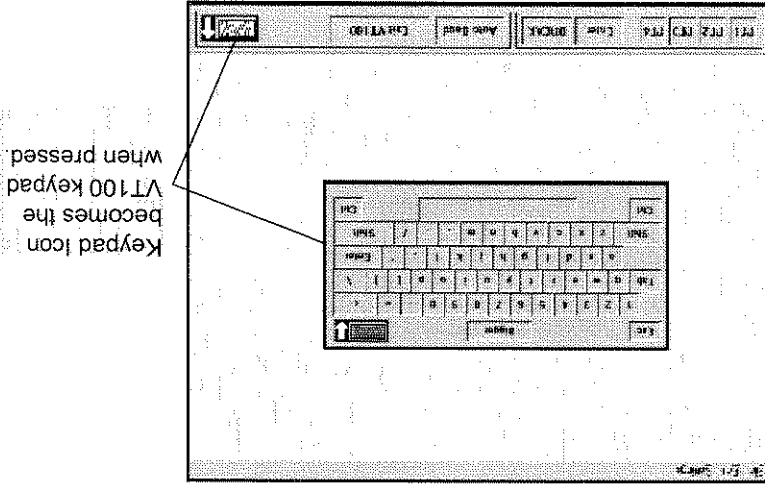

- 4 Press the keypad icon located on lower right of the screen to access the keypad.
The screen turns into a VT100 terminal with a cursor blinking at the top left hand corner.

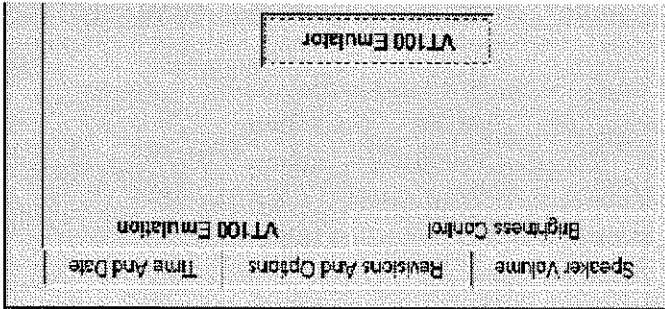

- 3 Press the **VT100 Emulation** tab in the auxiliary functions screen, followed by VT100 Emulator in the middle of the screen.

5 Change the size of the keypad by clicking the **Bigger/Smaller** button on the keyboard. You can also move/drag the keyboard to any desired location.

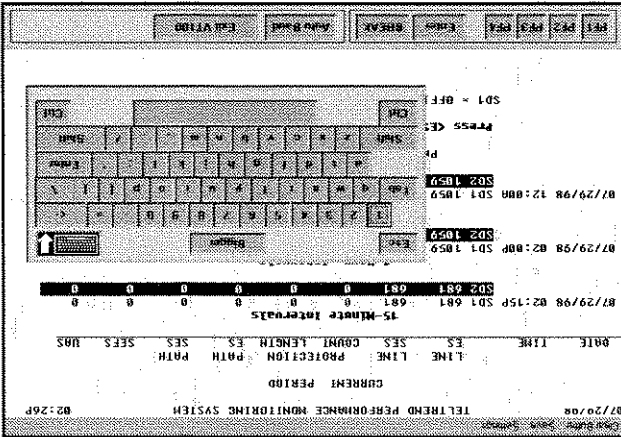

Notice the keypad icon has moved from status bar onto the pop-up keypad.

6 Access the menu of the network unit by either waiting a few seconds (e.g., Westell devices) or by touching the <ESC> key (e.g., Telit devices). Often, pressing the space bar works. If nothing appears on the screen after trying the above procedures, press **Settings > Terminal Preferences/Communications** from the menu bar to ensure settings are correct. For example, in the **Terminal Preferences** screen, you may want to have **Local Echo** turned off, especially if double characters are

- 8 Minimize the VT 100 keyboard if it is displayed on your screen.
 - a Press **Exit VT100** to exit VT 100 Emulation.
 - 7 Perform operations according to menu selections of the network device connected to the 2310 VT100 Emulator.
- The menu for the network unit should appear and the format should be correct. If not, go back to **Settings > Terminal Preferences** and check the CR/LF insert.

NOTE: In the Communications Screen, **DO NOT** change the Connector setting. The setting is correct for the application, and should always remain on COM2.

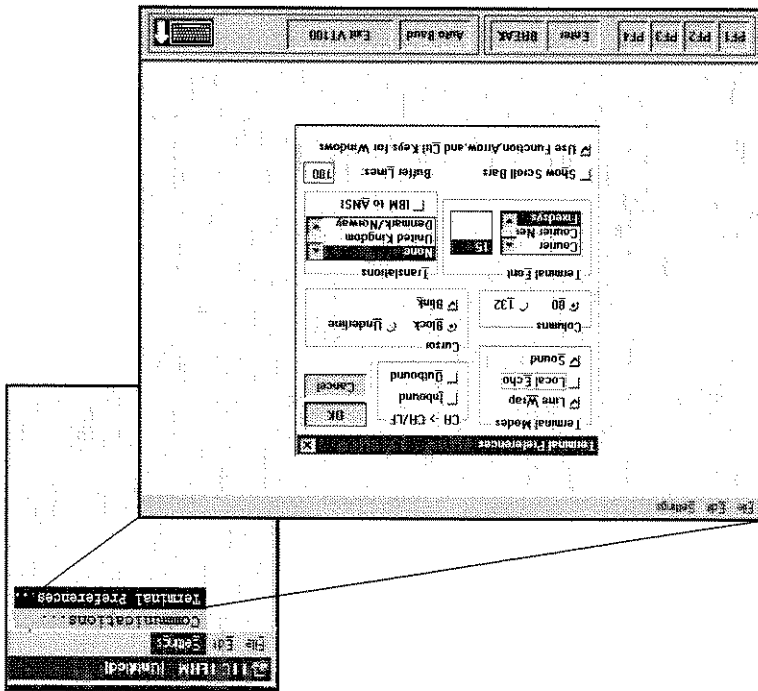

appearing on the screen. If settings are incorrect, change and save the settings. Try step 6 again.

Using the OC-3c/12c ATM option

The OC-3c/12c ATM options enable you to generate and analyze OC-3c/12c ATM payloads. With these options, you can test the ATM signal at the OC-3c/12c rate to check HEC framing, generate TTC ATM test cells (see Figure 41 on page 142), and record measurements on specific ATM streams.

ATM is a communications transport technology that formats, multiplexes, cross-connects, and switches voice, video, and data traffic. The 2310 stores four user-programmable virtual path identifier (VPI) and virtual channel identifier (VCI) transmit profiles, and one receive profile. These VPI/VCI profiles allow a specific value to be entered into the generic flow control (GFC), payload type identifier (PTI), and cell loss priority (CLP) fields in the ATM headers. These four profiles enable you to do the following:

- Analyze overall ATM measurements, which may include header-error control (HEC) errors, dropped cells, cell types, correlation tag, and bandwidth utilization.
- Generate ATM compliant idle cells, which fill unallocated payload bandwidth.
- Generate ATM compliant TTC test cells, which are comprised of TTC cell profiles.
- Support network node interface (NNI) and user-to-network interface (UNI) cell formats.

Table 12 shows the primary user-configurable settings for transmit and receive profile setup per VPI/VCI. These profiles represent the four possible ATM virtual connections. The 2310 transmits one primary and one secondary profile continuously chosen from these four profiles. In the Rx Profile, all of the fields can be set to "X," which matches any value. When monitoring a virtual connection,

Figure 41 — TTC ATM Test Cell #1

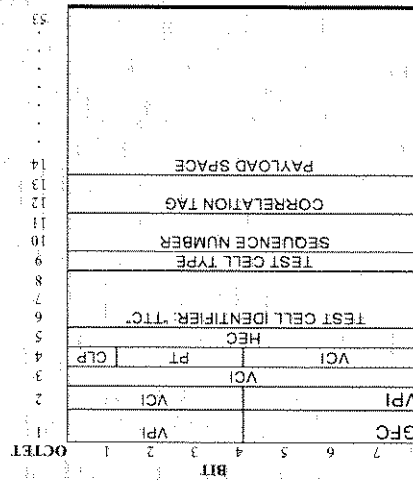

Cell #1. If the profile selected is inactive, you can use Search mode. In this mode, the 2310 actively searches for TTC ATM Test Cell #1 or live ATM cells. The results of the search are displayed on the user interface. Figure 41 shows the composition of the TTC ATM Test

Profiling with the Search Mode

The above table is for both UNI and NNI, with the exception that NNI does not have a GFC setup field and its VPI = 0 - 4095.

NOTE:

TX and RX Profile(s)	GFC	VPI	VCI	PTI	CLP
TX Profile P1 - P4	00-15	000-255	00000-65535	0-7	0-1
Rx Profile	00-15 or X	000-255 or X	00000-65535 or X	0-7 or X	0-1 or X

Table 12 — OC-3c/12c ATM TX and RX Profile setup fields

GFC, PTI, and CLP are commonly set to "X." When monitoring a virtual path, the VCI may also be set to "X."

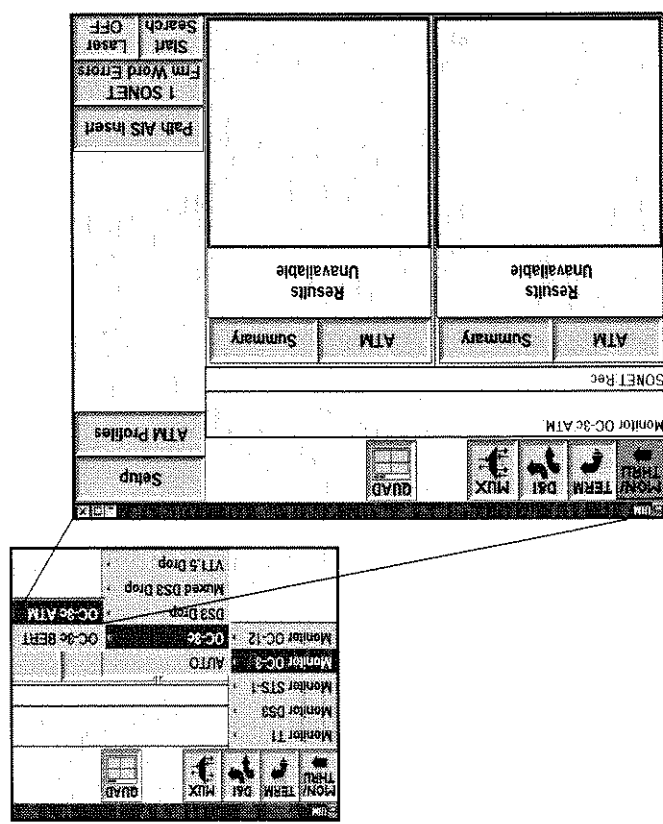

Monitoring ATM payloads

Configuring the 2310

- 1 On the menu bar, press **Mon/Thru > Monitor OC-3/12 > OC-3c/12c > OC-3c/12c ATM**. The unit automatically configures to a default setup screen.

The following procedure outlines how to setup the 2310 to monitor OC-3c/12c ATM payloads.

Using the OC-3c/12c ATM option



2 Press **Setup**. Ensure the characteristics shown in the Summary property setup screen match the network characteristics.

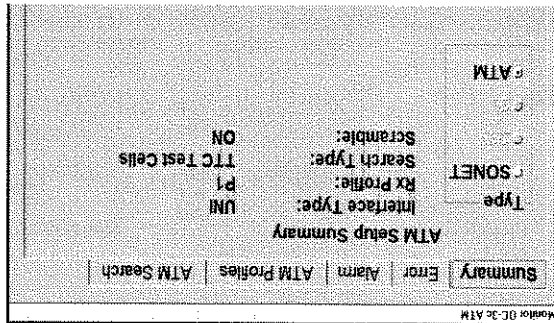

3 Select the **ATM Search** tab and designate the type of cells for which you want to search. Press **OK**.

NOTE:

The ATM Search mode can be used to actively search for ATM cells.

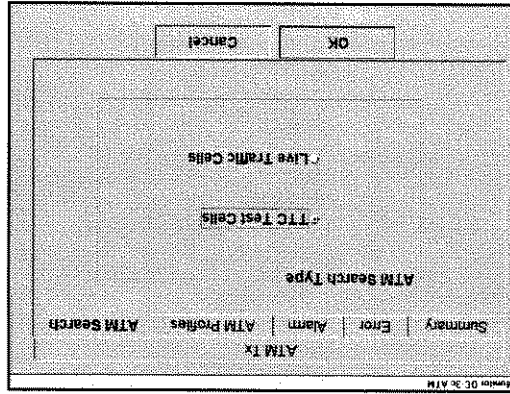

4 Set left and right Result Group buttons to **ATM** and **Category** buttons to **Summary** on the main screen.

- 1 Connect a cable from the RX OC-3c/12c interface to the OC-3c/12c test RECEIVE access point. Using laser safety guidelines found on page 125, press **Laser ON**.
- To connect the 2310 to the circuit

Connecting the 2310 to the circuit

When Start Search is pressed while viewing ATM results, the Results Category defaults to Stats.

Start Search becomes Stop Search when pressed.

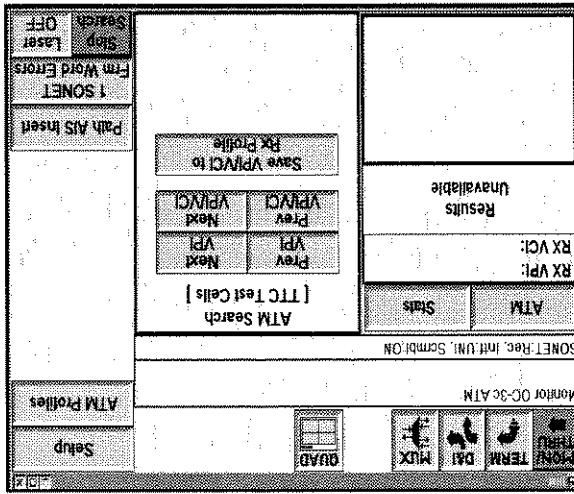

- 5 Press **Start Search** to initiate a search for specific ATM streams. The results of the search are displayed in the ATM Results Category window (when **Stats** is selected). You can also begin searches by pressing the appropriate VPI/VCI buttons.

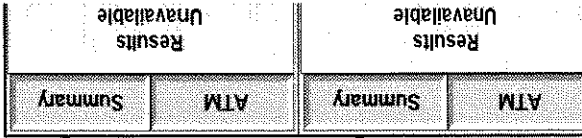

Result Category Buttons

2 Press the **RESTART** permanent softkey to clear alarms and begin the test.



3 Verify that the **SONET SIGNAL**, **FRAME**, **PATH PTR**, and **ATM SYNC** LEDs are illuminated (green).
 4 Select a Result Category. Observe the ATM activities in the display.

Connecting the 2310 to the circuit diagram

Figure 42 is a sample depiction of cable connections from the OC-3c/12c ATM 12c panel to the inputs on the 2310 for monitoring OC-3c/12c ATM traffic.

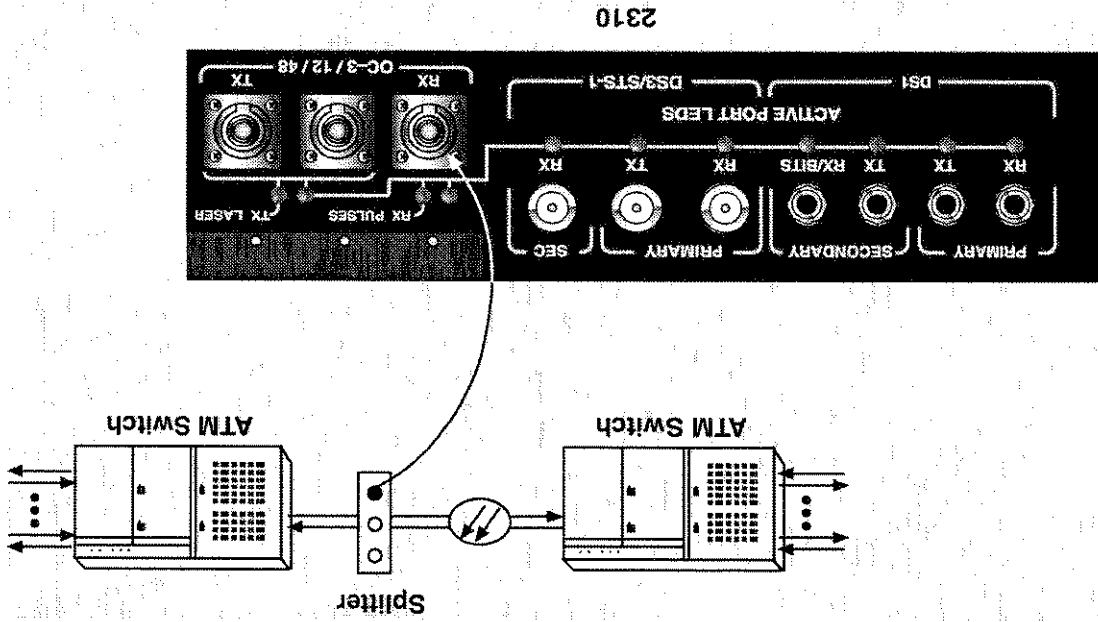

Figure 42 — Monitoring OC-3c/12c ATM test setup

Terminating ATM payloads

This test enables you to generate and analyze OC-3c/12c ATM payloads by checking HEC framing, generating TTC ATM test cells, and recording measurements on specific ATM streams.

Configuring the 2310

- To configure the 2310
- 1 On the menu bar, press **TERM** > **Terminate OC-3/OC-12** > **OC-3c/12c** > **OC-3c/12c ATM**. The unit automatically configures to a default setup screen.

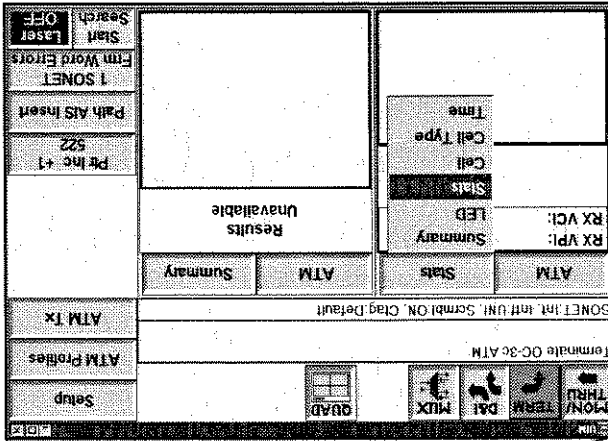
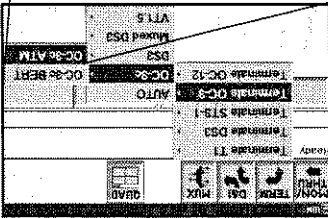

NOTE:

The default Results Category display is Summary. For ATM results, choose from the Category pull-down menu. When Stats is selected, the 2310 is set up to display VPI and VCI results.

- 3 Select the **ATM Profiles** tab to set the appropriate Terminate profile parameters. First, indicate your network interface (UNI or NNI); this choice determines the GFC and VPI formats.
 - UNI is the default, enabling you to set profile numbers for all setup fields.
 - If NNI is selected, there is no GFC field, and the VPI becomes a 12-bit field instead of an 8-bit field.
- 4 Select the Pri Tx Profile, Rx Profile, and the Sec Tx Profile from the Tx/Rx Profile Selections box.
 - Select Scramble OFF/ON (to determine whether the traffic should be scrambled). The default for Scramble is ON.
 - Choose one of four possible profiles and an Rx profile from the Profile Settings box. For each profile, set the numbers for the GFC, VPI, VCI, PTI, and CLP setup fields. Press **OK**.

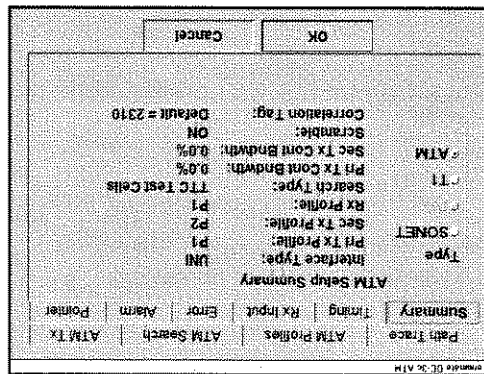

- 2 Press **Setup**. Ensure that the characteristics shown in the Summary property setup screen match the network characteristics.

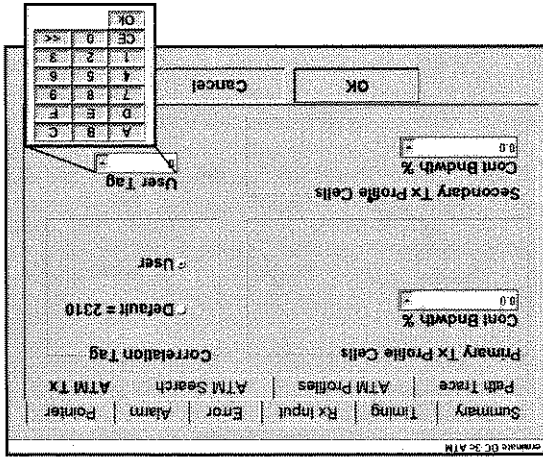

The Correlation Tag allows cells from multiple 2310 units to be differentiated from one another. You can also designate a specific User Tag.

- 5 Select the **ATM Tx** tab and designate the Primary and Secondary Tx Profile Cell bandwidths. Select the default Correlation Tag or a specific User Tag. Press **OK**.

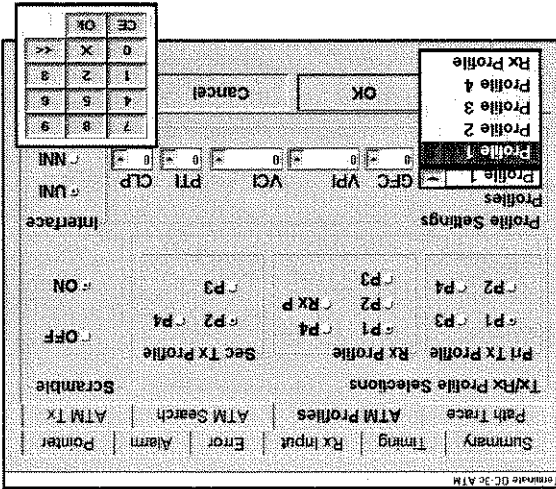

When you use the down arrows beside the boxes in the setup fields, a keypad displays so you can type in the values you want for Tx/Rx profile setup fields.

- To connect the 2310 to the circuit
- 1 Connect two cables, one from the Tx OC-3c/12c interface and the other from the Rx OC-3c/12c interface, to the OC-3c/12c test access point. Using laser safety guidelines, press **Laser ON**.

Connecting the 2310 to the circuit

To reconfigure for more searches, press the appropriate ATM profile buttons.

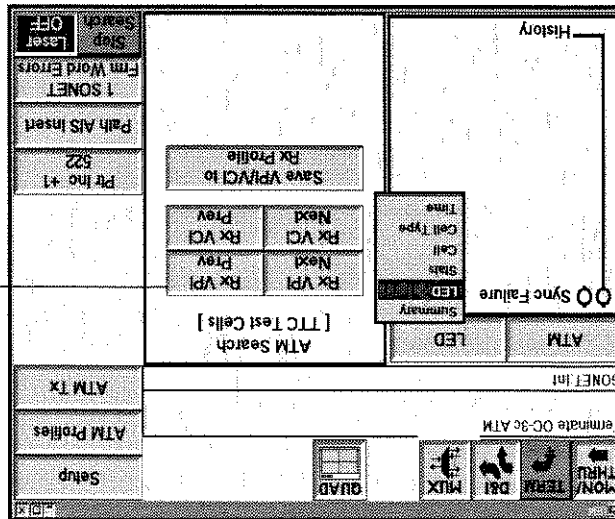

Press Summary, LED, Stats, Cell, Cell Type, or Time for ATM Category Results.

- 7 Set the Result Category buttons to ATM on the left and Summary on the right. Press **Start Search** to start the search function.

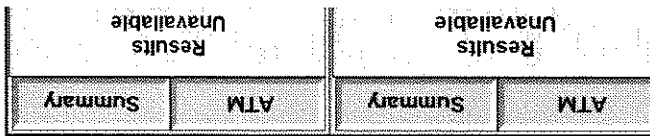

- 6 Set both Result Group buttons to ATM.

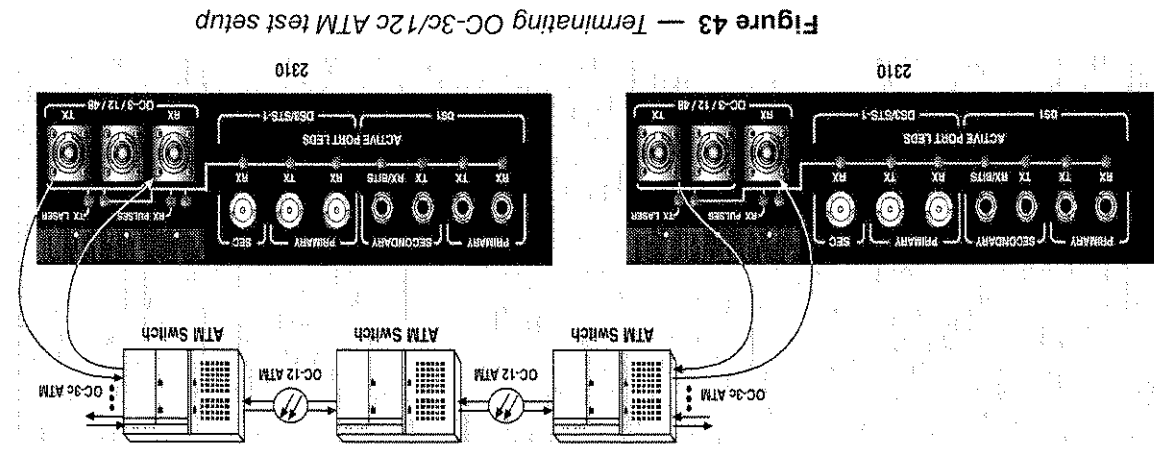
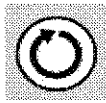

Figure 43 — Terminating OC-3c/12c ATM test setup

Connecting the 2310 to the circuit diagram

Figure 43 is a sample depiction of cable connections from the OC-3c/12c ATM switch to the inputs on the 2310 for terminating OC-3c/12c ATM testing.

- 2 Press the **RESTART** permanent softkey to clear alarms and begin the test.
- 3 Verify that the SONET SIGNAL, FRAME, PATH PTR, and ATM SYNC LEDS are illuminated (green).
- 4 Observe the ATM activity in the Results display.



Using the OC-3c/12c ATM option

Using the GR-303 option

GR-303 is a protocol which enables service for circuit-switched services. It efficiently deploys transport voice and/or data traffic using GR-303 based digital loop carriers.

The 2310 performs basic GR-303 protocol link packet analysis on a user-specified DS0 time slot within a framed T1 signal drop. These DSOs are either the embedded-operations channel (EOC), typically channel 12, or the time-management channel (TMC)/common-signaling channel (CSC), typically channel 24. The analysis is conducted non-intrusively on the link, on Level-2 layer (LAPD) packets sent across the GR-303 protocol link.

The 2310 enables you to choose packets with a specific SAPI/TEI filter value and display their counts. These packets include the following:

- Total packets
- Information packets
- Receiver-Ready packets
- Receiver-Not-Ready packets
- Reject packets

The 2310 also enables you to display counts for packets with CRC errors, the number of seconds with at least one CRC-errored packet, the rate at which CRC-errored packets are received, and those packets discarded due to misalignments, aborts, or sizing constraints. These packets include the following:

- CRC-Errored packets
- CRC-Errored seconds
- CRC-Error rate
- Discarded packets

The 2310 displays the current state of the link under analysis (via virtual LEDs in the LED Category). The link is considered "ready" if an Unnumbered Acknowledgement (UA) response or a Receiver-Ready (RR) Packet is received. The link is considered "not ready" if a Disconnect Mode (DM) response or a Receiver-Not-Ready (RNR) Packet is received, or if the carrier signal is lost for that link.

Level 3 call statistics

The 2310 also performs basic GR-303 call analysis within framed DS1 signal drops of a duplex T1 circuit. It is non-intrusive and performed on Layer-3 packets sent across the GR-303 time slot management channel/customer service center (TMC/CSC) protocol link, typically channel 24.

The 2310 enables you to acknowledge basic telephone events. These events include the following:

- Call attempts
- Call connects
- Call releases
- Percentage of blocked calls

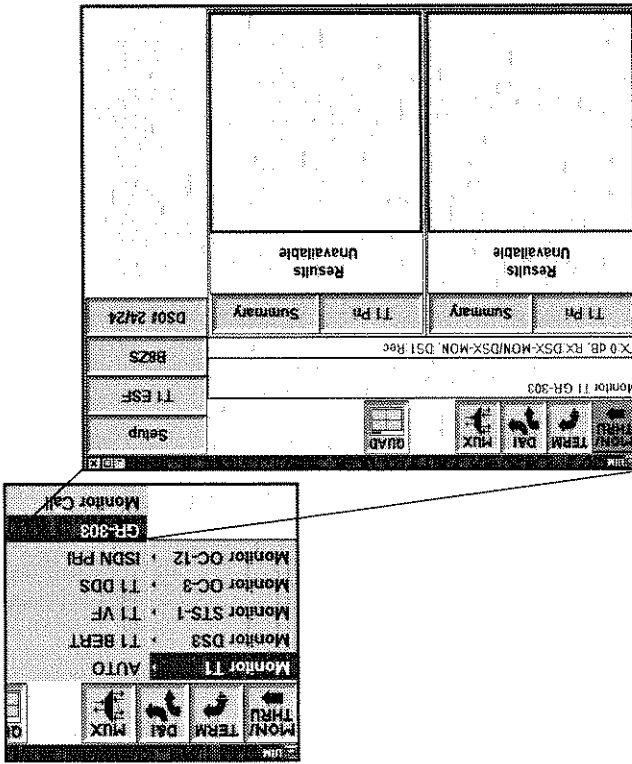

- 1 On the menu bar, press MON/THRU > Monitor T1 > GR-303. The unit automatically configures to a default setup.
- To configure the 2310

Configuring the 2310

Monitoring GR-303 performance

The following test enables you to monitor GR-303 performance.

Using the GR-303 option

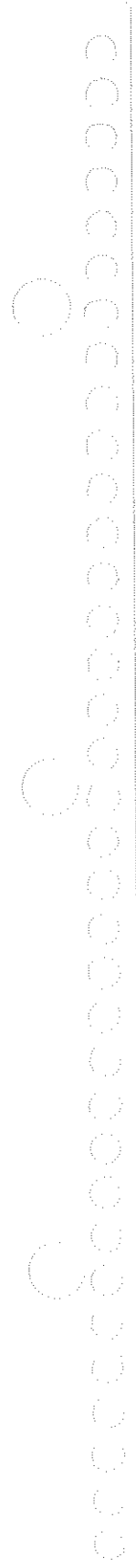

2 Press **Setup**. Ensure that the characteristics shown in the Summary tab match the network characteristics, such as T1 ESF. Summary tab match the network characteristics, such as T1 ESF.

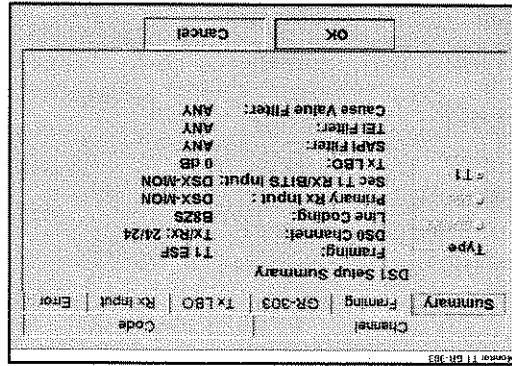

3 Select the **Rx Input** tab and select DSX-MON. Press **OK**.

4 Select the **Code** tab and select B8ZS. Press **OK**.

5 Select the **Channel** tab and select the DSO channel for the link under analysis: EOC (typically Channel 12) or TMC/CSC (typically Channel 24). Press **OK**.

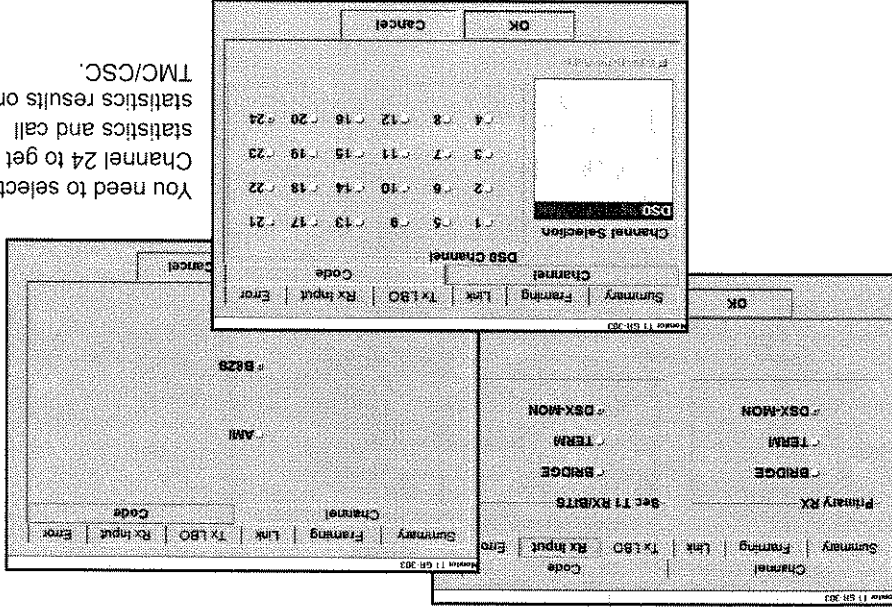

You need to select Channel 24 to get link statistics and call statistics results on the TMC/CSC.

10 Verify that the yellow active port LEDs next to the DS1 PRIMARY RX and SECONDARY RX jack are illuminated.

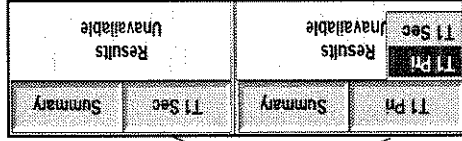

Result Group Buttons

9 If monitoring a second signal, press **T1 PRI** in the Results Group window and **T1 Sec** from the pull-down menu.

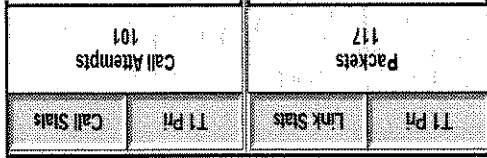

8 Set the Result Category buttons to **Link Stats** on the left and **Call Stats** on the right.

7 Set both Result Group buttons to **T1 Pri**.

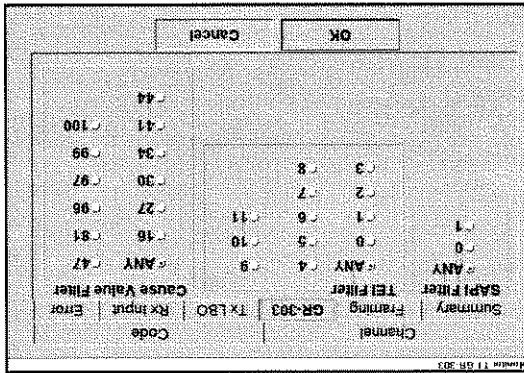

Select ANY in the TEI Filter field if you do not want to engage a filter.

6 Select the **GR-303** tab. Select the type of service access point identifier (SAPI) filter value, terminal endpoint identifier (TEI) filter value for link analysis, and the Cause Code value for call analysis. Press **OK**.

Connecting the 2310 to the circuit

- To connect to a circuit
- 1 Connect a cable from the PRIMARY RX jack to the DSX-1 A-Side MON jack.
 - 2 Connect a cable from the SECONDARY RX jack to the DSX-1 Z-Side MON jack.
 - 3 Press the **RESTART** permanent softkey to clear alarms and begin the test.
 - 4 Verify that the green SIGNAL and FRAME LEDs are illuminated and the Primary and Secondary Results displays show results OK.

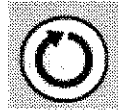

Connecting the 2310 to the circuit diagram
 Figure 44 is a sample depiction of cable connections from the DSX-1 panel to the inputs on the 2310 for T1 monitoring.

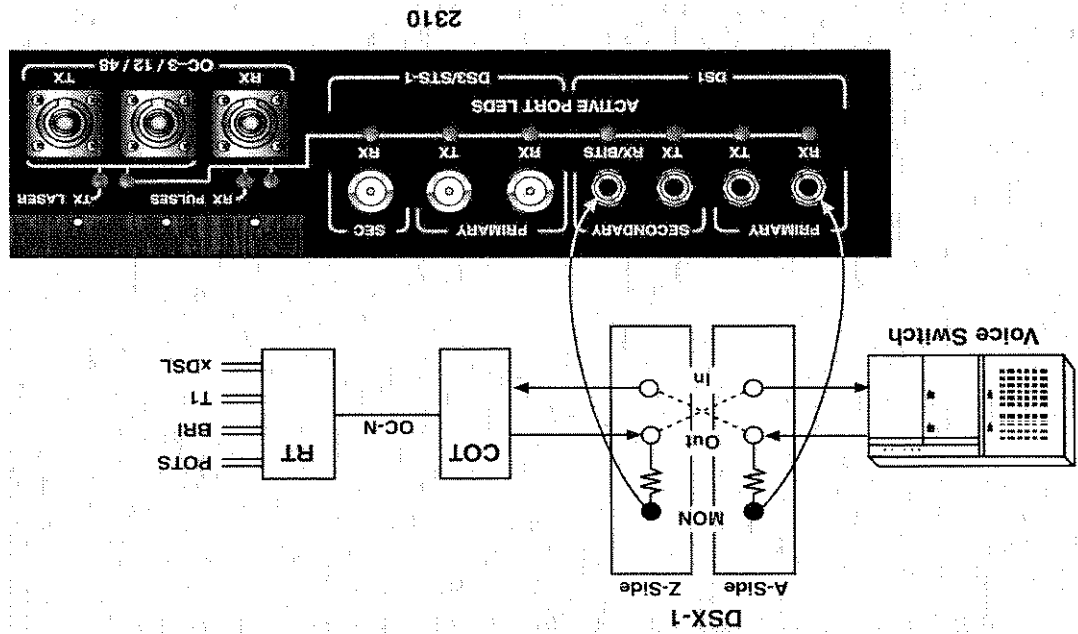

Figure 44 — GR-303 test setup

2310



Using the ISDN PRI option

The ISDN Primary Rate Option allows the 2310 to test the operational status of ISDN PRI links that use T1, DS3, and STS-1 as the physical interface. Features of the 2310 Primary Rate ISDN option include the following capabilities:

- Supports LUCENT 5ESS, NORTEL DMS 100, and National ISDN-2 Call Control specifications
- Supports different call types which include voice, 56K, 64K, Nx64K, Nx56K, and H0
- Places or receives two simultaneous voice or data calls while emulating a Terminal Equipment (TE) device (e.g., PBX)
- Provides test data services with BERT patterns or test voice services with a microphone and speaker
- Provides history of calls that were placed and terminated, as well as providing their corresponding cause codes
- Monitors physical layer (T1, DS3, and STS-1), and provide decodes of LAPD and Q.931 messages signaling on the D channel when in Monitor mode
- Performs back-up D channel testing and ability to support Network Facility Associated Signaling (NFAS)

Monitoring ISDN PRI calls

In Monitor mode, the unit allows full duplex, non-intrusive monitoring of a single D channel (which enables interpreting messages going from Terminal Equipment (TE) to Network Termination (NT) as well as messages going from NT to TE. In addition to providing the T1, DS3, and STS-1 results, the option provides full text decodes of the messages on the D channel.

Configuring the 2310

To configure the 2310

- 1 On the menu bar, press **MON > Monitor T1/ISDN PRI** to monitor a T1 circuit.

For all monitor ISDN PRI rate selections, see the following PRI ISDN choices:

To test...	Then...
T1	On the menu bar, press MON > Monitor T1 > ISDN PRI
DS3	On the menu bar, press MON > Monitor DS3 > Muxed DS3 Drop > ISDN PRI
STS-1 with DS3 muxed	On the menu bar, press MON > Monitor STS-1 > Muxed DS3 Drop > ISDN PRI
STS-1 with VT1.5	On the menu bar, press MON > Monitor STS-1 > VT1.5 Drop > ISDN PRI

The 2310 automatically configures to a default setup for the chosen application.

- 2 Press **Setup**. Ensure the characteristics shown in the setup summary screen match the network characteristics. To change settings, select the desired property sheet tabs in the property setup sheet.
- 3 Select the **Rx Input** tab. Ensure that BRIDGE or DSX-MON is selected. Press **OK**.

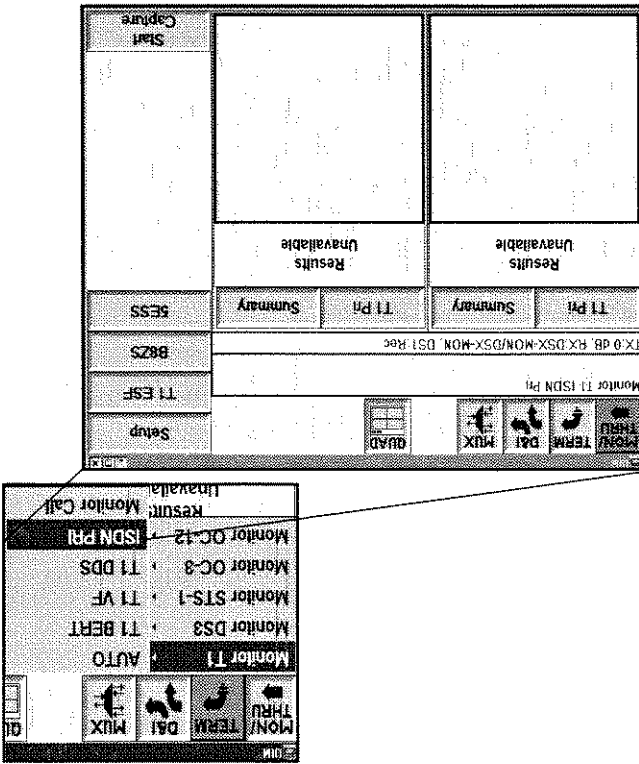

Notice how selecting Decodes changes the screen as the 2310 begins to capture frames after Start Capture is pressed.

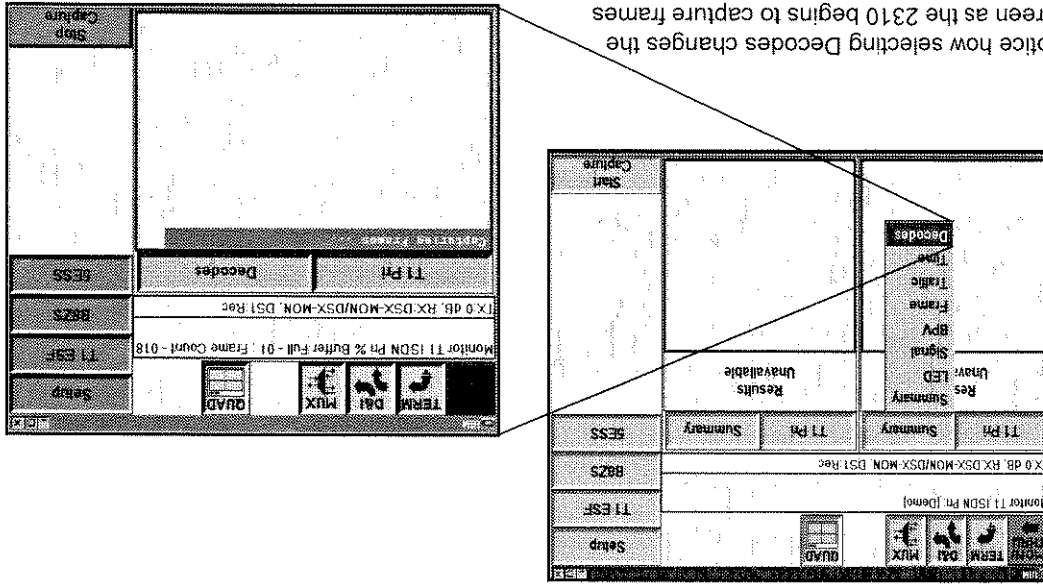

- 4 Select **Decodes** in the Result Category under either the Primary or Secondary Result Group. Press **Start Capture**.

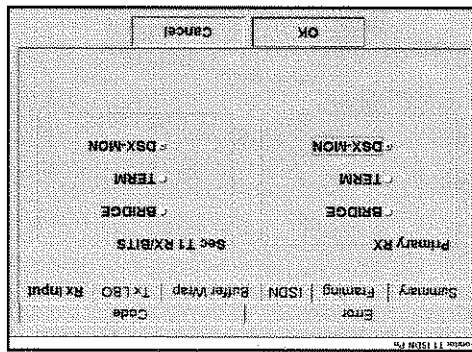

Connecting the 2310 to the circuit

- 1 To connect to a circuit
 - 1 Connect a cable from the PRIMARY RX jack to the DSX-1 A-Side MON jack.
 - 2 Connect a cable from the SECONDARY RX jack to the DSX-1 Z-Side MON jack.
- 6 Observe results in the display.

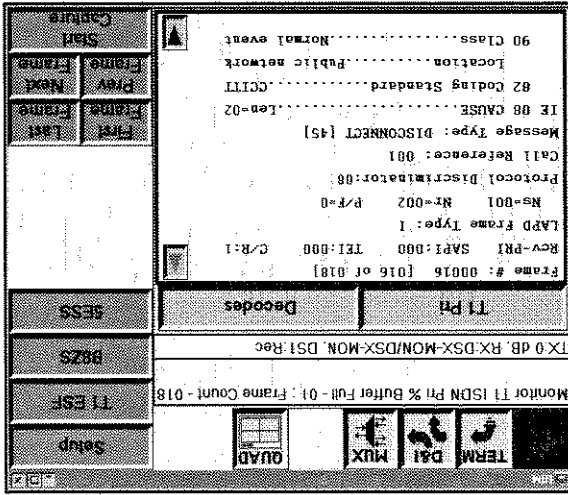

Start Capture becomes Stop Capture when the buffer is full.

- 5 View the D channel message decodes. The number of frames captured and the percent of buffer used displays in the status message window.

Pressing **Stop Capture** displays the last captured frame in the display window. If no frames were captured, the text no frames captured displays. To traverse through the list of frames that were captured, press any of the four action buttons named **First Frame**, **Last Frame**, **Prev Frame**, and **Next Frame**.

3 Press the **RESTART** permanent softkey to clear alarms and begin the test.

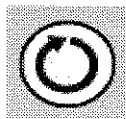

4 Verify that the green **SIGNAL** and **FRAME** LEDs are illuminated and the **Primary** and **Secondary Results** displays show results OK.

Connecting the 2310 to the circuit diagram
 Figure 45 is a sample depiction of cable connections from the DSX-1 panel to the inputs on the 2310 for T1 monitoring.

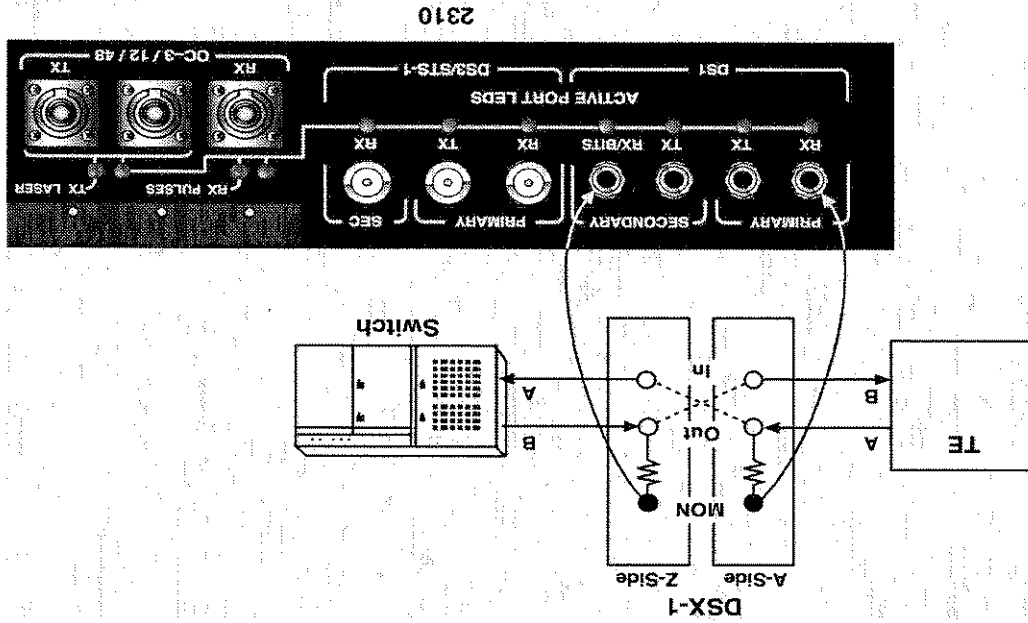
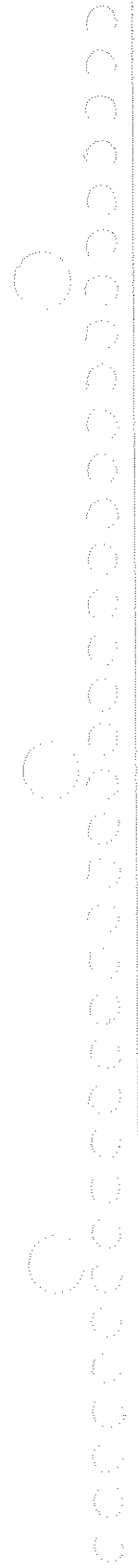

Figure 45 — Monitor ISDN PRI test setup



Using PRI ISDN in Terminate mode

The Terminate ISDN PRI test application emulates a TE device such as a PBX. Place Call and Receive Call is an advanced supported feature of Terminate Mode PRI. It enables the processing of up to two simultaneous calls (two terminating, two placing, or generating one call while terminating a second call). One or two calls may be placed on the same T1 or on different T1s.

Placing a call

This test allows you to place calls to and from the network.

Configuring the 2310

To configure the 2310 for placing a call

- 1 On the menu bar, press **TERM > Terminate T1 > ISDN PRI**.

For all terminate ISDN PRI rate selections, see the following PRI ISDN choices:

To test...	Then...
T1	On the menu bar, press TERM > Terminate T1 > ISDN PRI
DS3	On the menu bar, press TERM > Terminate DS3 > Muxed DS3 Drop > ISDN PRI
STS-1 with DS3 muxed	On the menu bar, press TERM > Terminate STS-1 > Muxed DS3 Drop > ISDN PRI
STS-1 with VT1.5	On the menu bar, press TERM > Terminate STS-1 > VT1.5 Drop > ISDN PRI

The 2310 automatically configures to a default setup for the chosen application.

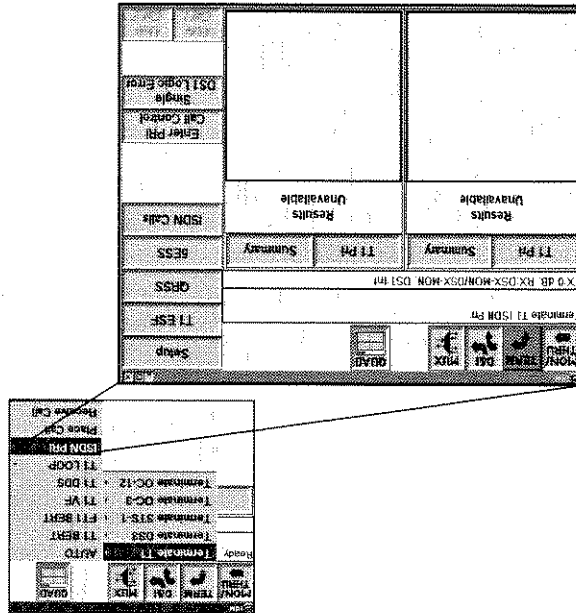

- 5 Select the **ISDN Call** property sheet tab. Configure the call(s) by pressing Config Call 1 and/or Config Call 2. Choose the type of call, the B channel to place the call on, and enter the number to be dialed on the Called # keypad. For a data call, enter a callback

*The DMS and SESS selections are for switches running vendor-pro-
prietary ISDN. For switches running National ISDN, NI-2 should be
selected regardless of the switch manufacturer.*

NOTE:

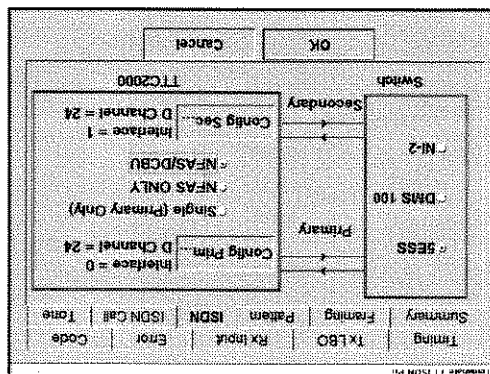

ISDN tab with SESS as the primary interface is NFAS/DCBU, and the D channel is 24.

- 4 Select the **ISDN** property sheet tab. Choose the Switch type and then Config Prim. D channel test type (Single [Primary Only], NFAS Only, or NFAS/DCBU), and the D channel (s) DS0s.

number. Of course, this number must be capable of receiving a data call, such as a loop back number.

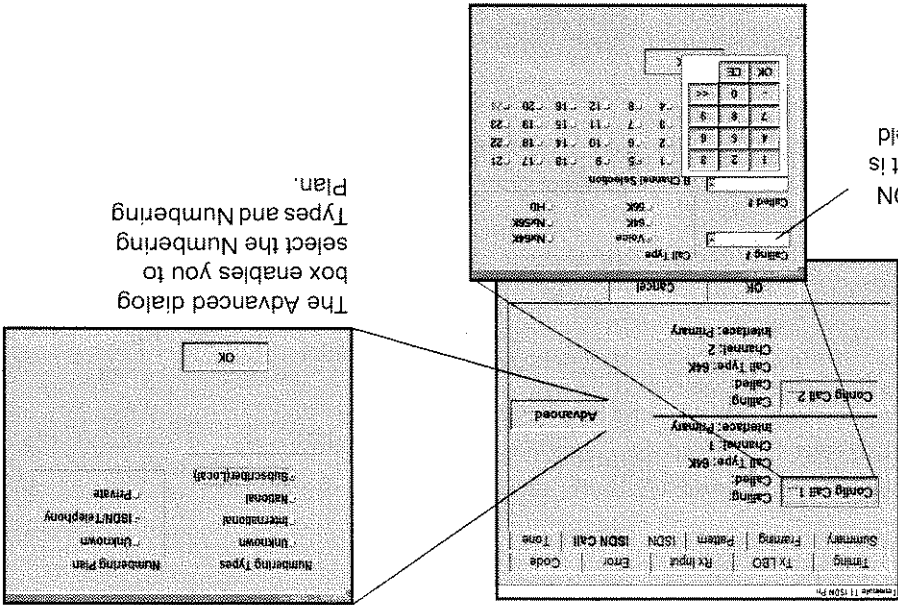

The Advanced dialog box enables you to select the Numbering Types and Numbering Plan.

Calling # is the number of the ISDN line under test. If it is not known, this field may be left blank.

Connecting the 2310 to the circuit

- 1 To connect to the circuit
- 2 Connect a cable from the PRIMARY RX jack to the DSX-1 A-Side OUT jack.
- 3 Connect a cable from the PRIMARY TX jack to the DSX-1 Z-Side IN jack.
- 4 Press the **RESTART** permanent softkey to clear alarms and begin the test.

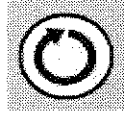

- 4 Verify that the green SIGNAL and FRAME LEDs are illuminated and the Primary and Secondary Results displays show results
OK.
- 5 Check the **D Chan Ready LED** under the LED Result Category to verify that the D channel and/or the D channel backup are in service.

NOTE: When the 2310 is configured for the correct switch type (Call Control) and the D channel, it establishes the data link and is ready to carry out ISDN call processing. The unit enables BERT and VF analysis of the B channels being used after successful call establishment. In addition to providing the results for the physical interface, the unit also provides statistics collected on the D channel, as well as results based on the analysis of the B channel. The Call Controls supported in this mode include LUCENT 5ESS, NT DMS 100, and NI-2.

Verify the D Chan Ready Category LED is evident before placing a call.

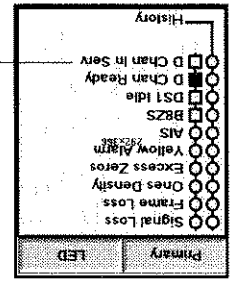

Receiving a call

Configuring the 2310

To configure the 2310 for receiving a call

- 1 Follow procedural steps 1 - 8 in "Placing a call" on page 167.
- 2 Press **Enter PRI Call Control** to open the PRI CALL CONTROL keypad.
- 3 Press **Answer (or Reject)** for the incoming call.
- 4 Press **Push 2 Talk** and speak into the microphone to establish a voice path.

When an ISDN call from the network is received by the 2310, you are alerted by a flashing **Enter PRI Call Control** action button, and a message in the status display.

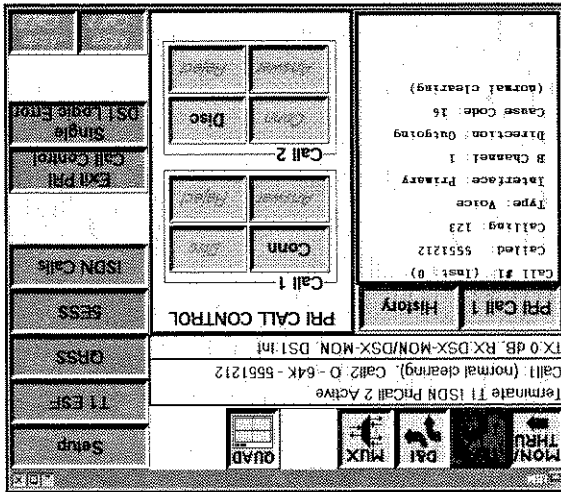

- 6 Press **Enter PRI Call Control**. The PRI CALL CONTROL keypad pops up. Press **Conn** to place the call.

Using the ISDN PRI option



**Connecting the 2310
to the circuit**

- To connect to the circuit
- 1 Connect a cable from the PRIMARY RX jack to the DSX-1 A-Side (OUT) jack.
 - 2 Connect a cable from the PRIMARY TX jack to the DSX-1 Z-Side (IN) jack.
 - 3 Press the **RESTART** permanent softkey to clear alarms and begin the test.
 - 4 Verify that the green **SIGNAL** and **FRAME** LEDs are illuminated and the Primary and Secondary Results displays show Results OK.

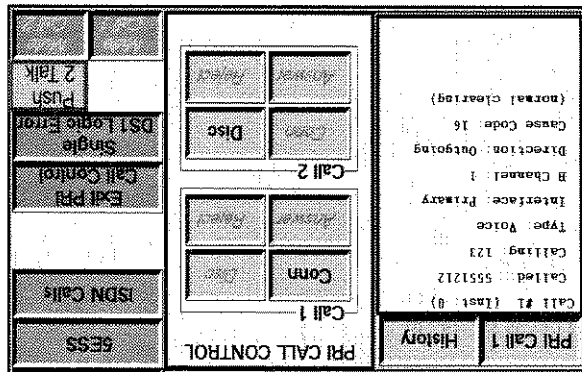
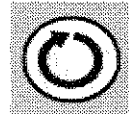

- 5 Press **Disc** to disconnect the call.

NFAS and D channel backup testing

The D channel Backup option enables all signaling information to take place on one D channel for both PRI interfaces on the Network Facility Associated Signaling (NFAS). Furthermore, there is a dedicated channel on the non-active D channel interface for the purpose of carrying signaling information in the case of the primary D channel failure.

Configuring the 2310

To configure the 2310

- 1 Follow procedural steps 1 - 4 in "Placing a call" on page 167.
- 2 Select NFAS or NFAS/DCBU, depending on the PRI line characteristics. For this example, choose NFAS/DCBU on the secondary interface, which supports the signaling information for

Figure 46 — Terminate ISDN PRI Test Setup

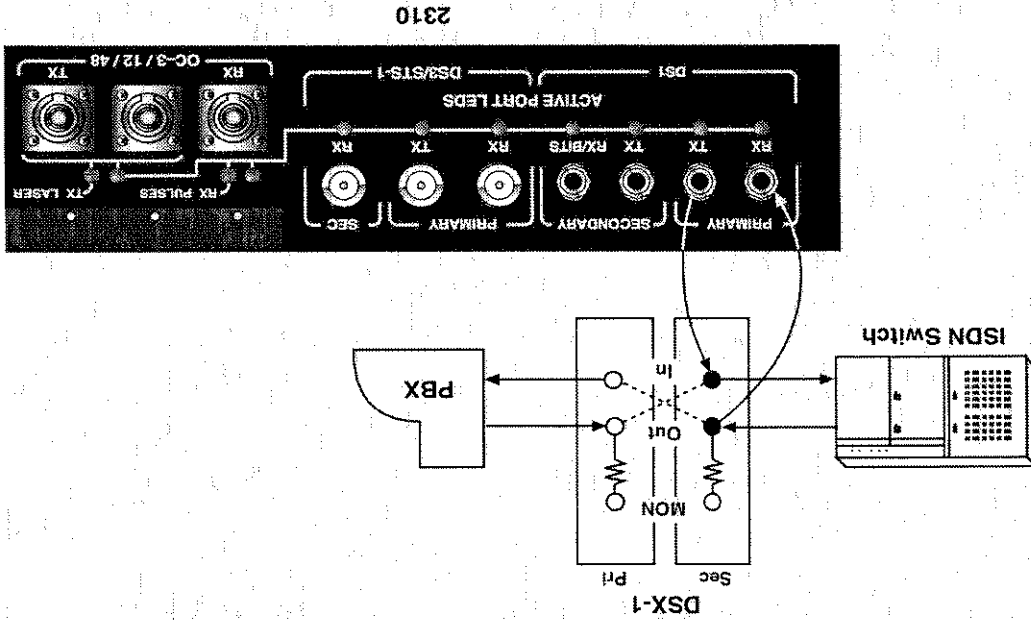

Connecting the 2310 to the circuit diagram

Figure 46 is a sample depiction of cable connections from the DSX-1 panel to the inputs on the 2310 for T1 monitoring.

two PRI links taking place on the D channel in each T1 (one active, one backup). Because NFAS/DCBU was chosen, Config Sec enables the selection of the DSO which will carry signaling information.

Choose the ISDN property sheet after pressing Setup on main screen.

Select NFAS/DCBU. The Interface Identifiers are set to "0" on Config Prim and "1" on Config Sec.

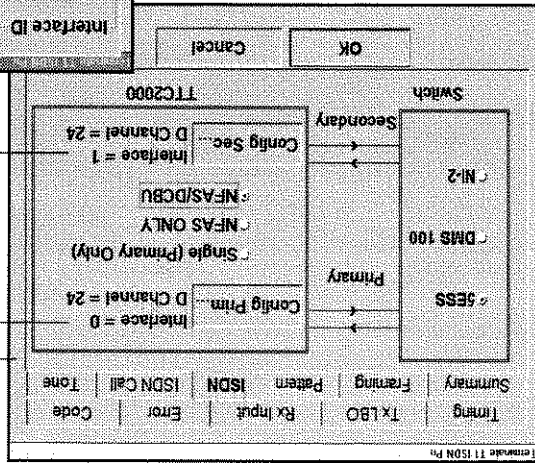

On Config Prim and Config Sec pop-ups, select 24 on D Chan Select and Interface ID.

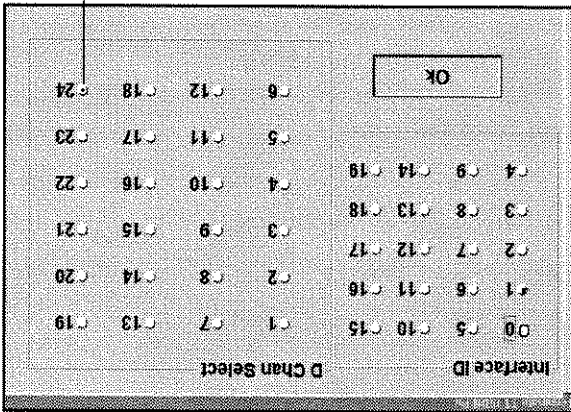

NOTE:

The Interface ID is most commonly set to 1 for the backup D channel. However, if a non-standard ID is assigned, it must match the switch.

5 Continue with placing and receiving calls as addressed earlier.

The backup D channel feature can test the switch-over of a standby D channel to the in-service D channel.

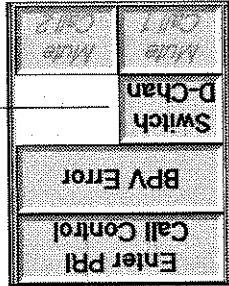

D Chan Ready in the LED Category locates an in-service and ready D channel.

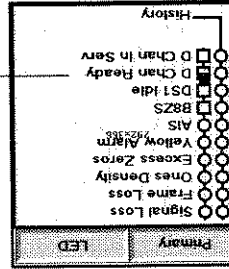

The D Chan In Serv LED is provided under the LED Result Category as a convenient means of checking for an in-service D channel. To initiate the D channel to test the switch over of a standby D channel to the in-service D channel, disconnect the in-service T1 or press **Switch D-Chan**.

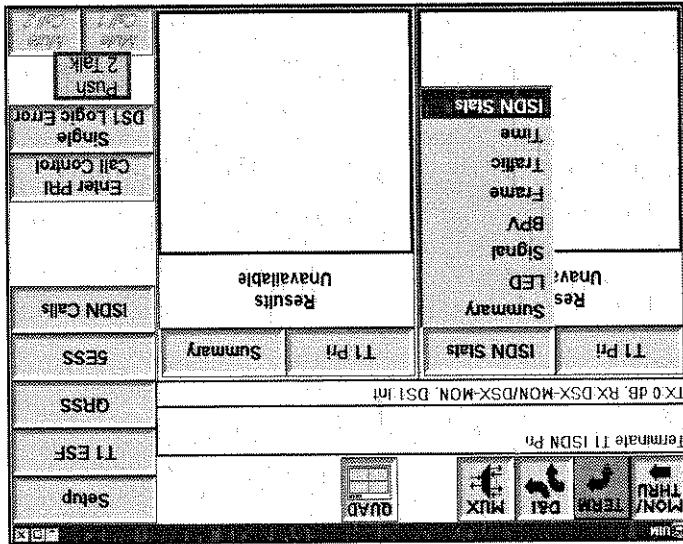

- 3 Set the Interface ID to **1** for the Secondary Interface and **24** on the D Chan Select section.
- 4 Select the **ISDN Stats** Result Category to check this information.

6 Switch between D channels when testing NFAS/DCBU. Do this several times by pressing **Switch D-Chan.**

Table 13 describes the D channel message displays.

Table 13 — D channel states and descriptions

D channel States	Descriptions
In Service	D channel carries signaling information.
Out of Service	D channel is not available.
Maintenance	State is entered automatically when state changes are taking place on the other interface.
Busy	D channel is waiting for a response from the network in order to enter the in-service state.
Standby	D channel is transitioning to the in-service state in the case of the Primary D channel failure.

Test Results

This chapter describes 2310 test results for DS1, DS3, and SONET. The available test results discussed in this chapter include the following:

- "Results Categories" on page 181
- "Summary Category" on page 181
- "LED Category" on page 183
- "Signal Category" on page 188
- "BPV Category" on page 192
- "Frame Category" on page 193
- "Parity Category" on page 197
- "SONET Section Category" on page 199
- "SONET Line Category" on page 200
- "SONET Path Category" on page 204
- "SONET Path Trace Category" on page 206
- "SONET VT Category" on page 207
- "SONET ATM Category" on page 210
- "Channel Category" on page 212

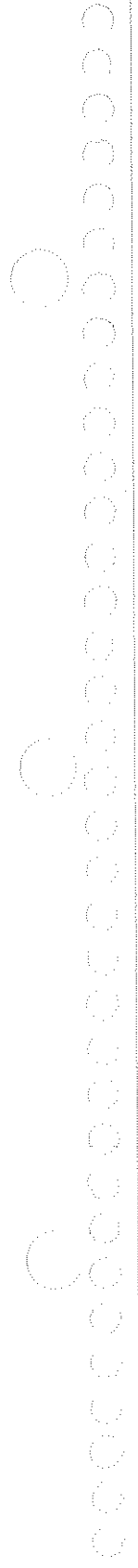
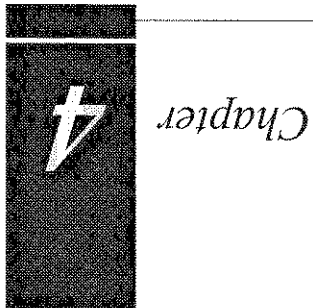

- “Call Signal Category” on page 215
- “Traffic Category” on page 217
- “Logic Category” on page 218
- “Time Category” on page 220
- “GR-303 Category” on page 221
- “PRI ISDN Category” on page 225
- “Quad Results” on page 230

D51 Summary Category test results

Select T1 Pri/Sec from the Result Group and Summary from the Result Category for test results.

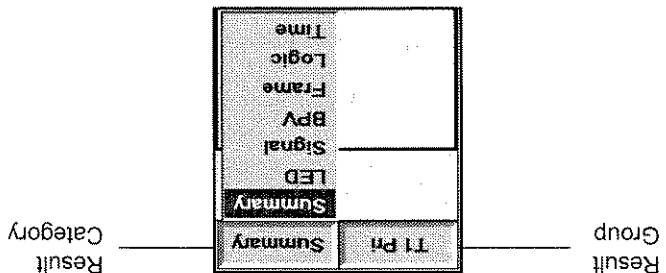

Summary Category

The Summary Category automatically displays key results that are non-zero or out-of-specification. This allows quick access to the results without having to search through the other categories. When all Summary results are error-free, the message Results OK displays. When an error is detected, the appropriate test result appears in the Summary Category window.

Many of the categories will be discussed with their test results.

- Summary
- LED
- Signal
- BPV
- Call Signal
- Logic
- VT
- Frame
- Parity
- Section
- Line
- Traffic
- Time
- Path
- Path Trace
- Channel
- Bridgetap
- Multipat
- ISDN Stats
- Link Stats
- Call Stats
- Cell
- Cell Type
- Stats

The following list shows the possible test result categories:

Results Categories

The results that appear in the Summary Category for DS1 include the following:

- Results OK
- BPVs
- CRC Errors
- Yellow Alarm
- Frame Errors
- Pattern Slips
- Frame Slips
- B8ZS Detected
- Frame Losses
- Signal Losses
- Signal Present
- Excess Zeros
- Ones Density

The results that appear in the Summary Category for DS3 include the following:

- Results OK
- Yellow Alarm
- Parity Slips
- C-Bit Errors
- DS2 Framesync
- Signal Present
- Signal Losses
- Blue Alarm
- Results OK
- Pattern Slips
- BPV Errors
- FEBES
- Frame Sync
- Frame Losses
- Frame Errors
- Bit Errors
- Pattern Losses
- Pattern Losses
- DS2 Frame Losses
- FEAC Codes
- RX Frequency

SONET Summary Category test results

- Results OK
- Line AIS
- Line RDI
- Path AIS
- Path RDI

The results that appear in the Summary Category for SONET include the following:

- Line Unavailable Secs
- Line BIP Errors
- Line FEBES
- Path Pointer Justifications
- Path Pointer NDFs
- OC-12 RX Frequency
- OC-48 RX Frequency
- VT FEBES
- VT RDI
- VT Pointer NDFs

For DS1, DS3, and SONET signal testing, green status LEDs provide information about the current condition of the received primary and secondary (optional) signals. The status LEDs are divided into two groups, PRI (Primary) and SEC (Secondary). The PRI status LEDs refer to the signal received through the Primary RECEIVE jack. The PRI status LEDs also indicate the condition of the signal dropped from the payload of a higher signal (for example, the condition of a DS3 signal dropped from an OC-3 signal). The SEC status LEDs refer to the signal received through the Secondary RECEIVE jack. Select **LED** from the Result Category for LED test results.

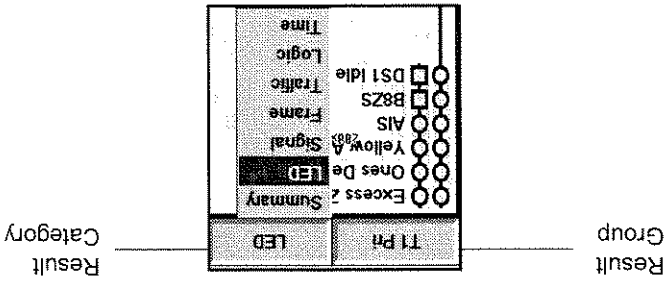

LED Category

- VT AIS
- Frame Word Errors
- Frame Losses
- Framesync
- Severely Errored Frame
- Bit errors
- Section BIP Errors
- Severely Errored Frame Defect
- APS Message Count
- BPIs
- Path Pointer Size
- Path BIP Errors
- Path FEBES
- Path Pointer Present
- Path Unavailable Secs
- STS-1 RX Frequency
- Pattern Slips
- Pattern Losses
- Pattern Sync
- OC-3 RX Frequency
- VT Pointer Justifications
- VT Pointer Present
- VT Loss of Pointer
- VT Unavailable Secs
- VT BIP Errors
- Signal Present
- Signal History
- Signal Losses
- RX Overload
- VT RDI

DS1 LED Category test results

As the received signal is recognized, the appropriate Status LEDs illuminate. The DS1 LED Category test results are defined in

Table 14.

Table 14 — DS1 LED test results

Displayed Test Result	Description
Excess Zeros	Excess Zeros — Illuminates when excess zeros (more than 8 consecutive) are detected in B8ZS coding and more than 15 in AMI coding.
Ones Density	Ones Density — Illuminates if the T1 signal violates the ones density criteria (when there is at least n ones in $8(n+1)$ bits).
Yellow Alarm	Yellow Alarm — Illuminates when the Far-End Out-of-Frame (FEOFF) signal is detected. FFOO in FDL for ESF, bit 2 is set to 0 for 255 consecutive DS0 channels for T1-D4.
AIS	Alarm Indication Signal — Illuminates when the unframed pattern is all ones. AIS indicates to downstream equipment that an upstream piece of equipment has detected loss of signal or loss of framing.
B8ZS	Bipolar with 8-Zero Substitution — Illuminates when B8ZS clear channel coding is detected in the received DS1 signal.
DS1 Idle	DS1 Idle — Illuminates when the T1 D4 inband (all DS1 channels contain 0001 0111 bit pattern) or T1 ESF out-of-band (FFOO) idle code (Yellow Alarm) is present.



DS3 LED Category test results

As the received signal is recognized, the appropriate status LEDs illuminate. The DS3 LED Category test results are defined in Table 15.

Table 15 — DS3 LED test results

Displayed Test Result	Description
Far End Alarm	Far-End Alarm — Illuminates when Far-End Alarm and Control (FEAC) messages in the C-bit parity framing format (third C-bit in the M1 subframe) are detected.
Blue Alarm	Blue Signal Alarm — Illuminates when the Blue Signal (Alarm Indication Signal) is detected (1010 pattern or stuck C bit). AIS indicates to downstream equipment that an upstream piece of equipment has detected loss of signal or loss of framing.
Yellow Alarm	Yellow Alarm — Illuminates when the Far-End Out-of-Frame (FEOLF) signal (X-bits set to zero) is detected.
DS2 Frame Loss	DS2 Frame Loss — Illuminates when frame synchronization to the DS2 signal is lost.
DS2 Frame Sync	DS2 Frame Sync — Illuminates when synchronization to the DS2 framing format is present.
C-Bit Frame	C-Bit Frame — Illuminates when the T-BERFD 2310 acquires C-bit frame synchronization.
DS3 Idle	DS3 Idle — Illuminates when a DS3 signal is received in a 100 pattern aligned in the payload for one M-frame.

SONET LED test results

As the received signal is recognized, the appropriate status LEDs illuminate. Select **SONET Pri/Sec** from the Result Group for STS-1, OC-3/OC-12/OC-48 results. Select **LED** from the Result Category for test results.

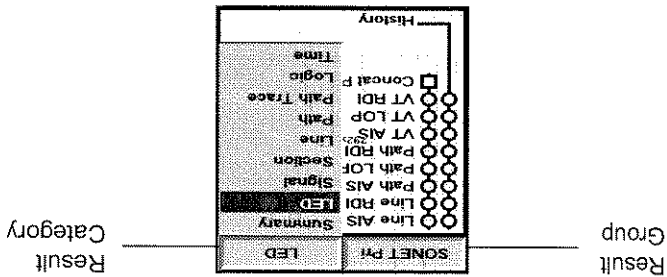

The SONET LED Category test results are defined in Table 16.

Table 16 — SONET LED test results

Displayed Test Result	Description
Line AIS	Line Alarm Indication Signal — Line (AIS) detects a 111 pattern in the Line overhead APS byte (K2), Bits 6 to 8, for five consecutive frames. Line AIS is removed after detecting a pattern other than 111 in Bits 6-8 of byte K2 for five consecutive frames. Line AIS indicates to downstream equipment that an upstream section terminating equipment (STE) has detected loss of signal or loss of framing.
Line RDI	Line Remote Defect Indication — (RDI) alarm (also known as far-end receive fail (FERF) alarm) detects a 110 pattern in the Line overhead APS byte (K2), Bits 6 to 8, for five consecutive frames. Line RDI is removed after detecting a pattern other than 110 in Bits 6-8 of byte K2 for five consecutive frames. Line RDI alerts an upstream device of a downstream failure, such as loss of signal, loss of frame, or Line AIS.
Path AIS	Path Alarm Indication Signal — Path AIS alarm detects an all ones pattern in the Line overhead pointer bytes (H1 and H2) for three consecutive frames. Path AIS is removed when a valid set of pointer bytes and active new data flags (NDFs) are received, or when a valid pointer value is observed in three consecutive frames. Path AIS alerts the downstream path terminating equipment (PTE) that an upstream failure occurred.

Table 16 — SONET LED test results (continued)

Displayed Test Result	Description
Path LOP	Path Loss Of Pointer — Path LOP alarm occurs when a valid pointer value cannot be determined from the line overhead pointer bytes (H1 and H2). Specifically, Path LOP is declared if a valid pointer is not found in eight consecutive frames, if eight consecutive active NDFs are received without the corresponding concatenation indication. The Path LOP alarm is removed when a consistent pointer value or concatenation indication is received for three consecutive frames.
Path RDI	Path Remote Defect Indication — Path RDI alarm (also known as RAI or Yellow Alarm) detects a one in Bit 5 of the Path status byte (G1) for five consecutive frames. STS Path RDI is removed after Bit 5 of byte G1 contains a zero for five consecutive frames. Path RDI indicates to the upstream PTE that a downstream failure has been detected.
VT AIS	Virtual Tributary Alarm Indication Signal — VT AIS alarm detects an all ones pattern in the VT pointer bytes (V1 and V2) for three consecutive VT superframes. VT Path AIS is removed under two conditions: when a valid VT pointer, valid VT size, and the NDF 1001 flag are detected, or three consecutive VT superframes containing a valid VT pointer, valid VT size, and a normal NDF are detected. VT AIS alerts the downstream VT PTE of an upstream failure.
VT LOP	Virtual Tributary Loss Of Pointer — VT LOP alarm detects a valid pointer value cannot be determined from the VT Path overhead bytes (V1 and V2). Specifically, VT Path LOP is declared if a valid pointer is not found in eight consecutive frames, if eight consecutive active NDFs are received. The VT Path LOP alarm is removed when a consistent pointer value is received for three consecutive frames.
VT RDI	Virtual Tributary Remote Defect Indication — VT RDI alarm (also known as RAI or Yellow Alarm) detects a one in Bit 8 of the VT Path overhead byte (V5) for five consecutive VT superframes. The VT Path RDI alarm is removed when a zero is detected in Bit 8 of byte V5 for five consecutive frames. VT RDI indicates to the upstream VT PTE that a downstream failure has been detected.
Concat Payload	Concat Payload — A Concatenated pointer value is detected in the first received STS-1 and NDFs with pointer values of 0 in the remaining STS-1s for three frames.

Signal Category

The Signal Category results include signal level, frequency, and loss seconds. The results are accumulated after initial signal detection. Select **T1 Pri/Sec** from the Result Group and **Signal** from the Result Category for Signal Category test results.

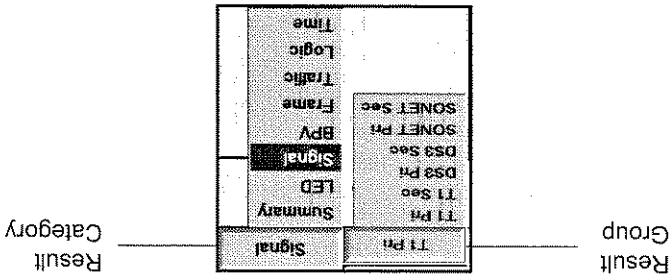

The DS1 Signal Category test results are defined in Table 17.

DS1 Signal test results

Table 17 — DS1 Signal test results

Displayed Test Result	Description
Signal Losses	Signal Losses — The T1 signal is lost or absent (equal to 1 loss in every 100 milliseconds).
Signal Loss Secs	Signal Loss Seconds — The number of seconds during which the received DS1 signal was lost for all or part of a second since initial signal detection.
RX Frequency	Receive Frequency — The frequency of the clock recovered from the received DS1.
TX Frequency	Transmit Frequency — The frequency of the clock as measured from the transmitted data.
Simplex Curr mA	Simplex Current measured in milliamperes — DS1 electrical signal received in the primary T1 test, the value is displayed as xxx mA in a range from 10 mA to 200 mA.

Table 17 — DS1 Signal test results (continued)

Displayed Test Result	Description
RX Level dbdsx	Receive Level Decibels dsx — DS1 power of signal received in a T1 test. The value is displayed as xxx dbdsx in a range from +6.0 dbdsx to -40.0 dbdsx.
RX Level dbm	Receive Level Decibels below 1 Milliwatt — DS1 power of signal received in a T1 test. The value is displayed as + xx.x dbm in a range from +23.0 dbdsx to -23.5 dbdm. Will only be valid for unframed ones.
RX Level Vpp	Receive Level Volts peak-to-peak — DS1 power of signal received in a T1 test. The value is displayed as + xx.x V in a range from +12.0 V to 1.0 V.
Timing Slips	Timing Slips — The number of bit slips (+/-) and frame slips (absolute value) counted when the DS1 test signal slips from the DS1 reference signal after both signals are present simultaneously. Counts from 0 to + or - 192 and then rolls over to 0. Resets to 0 if signal present is lost on the analyzed T1 or on the reference T1. A positive result indicates that the analyzed T1 is faster than the reference T1.
Frame Slips	Frame Slips — The number of frame slips (absolute value) counted when the DS1 test signal slips from the DS1 reference signal after both signals are present simultaneously.

DS3 Signal test results
 The DS3 Signal Category test results are defined in Table 18.

Table 18 — DS3 Signal test results

Displayed Test Result	Description
Signal Losses	Signal Losses — The DS3 signal is lost or absent (equal to 1 loss in every 100 milliseconds).
Signal Loss Secs	Signal Loss Seconds — The number of seconds during which the received DS3 signal was lost for all or part of a second since initial signal detection.

Displayed Test Result	Description
Signal Losses	Signal Losses—Occurs during transition from ON to OFF of SONET signal.
Signal Loss Secs	Signal Loss Seconds — Represents an asynchronous test second in which the appropriate loss of signal was present at least some portion of the second.
RX Frequency (STS-1)	STS-1 Receive Frequency — Represents the total number of STS-1 cycles received during the last second. The resolution is 4 Hz. If the signal is further than (+/-) 1% from the nominal, a message displays indicating that the signal is not STS-1.
RX Frequency (OC-3/12/48)	OC-3/12/48 Receive Frequency — Represents the total number of OC-3/12/48 cycles received during the last second. If the signal is further than (+/-) 1% from the nominal, a message displays indicating that the signal is not OC-3/12/48.

Table 19 — SONET Signal test results

SONET Signal test results
The SONET Signal Category test results are defined in Table 19.

Displayed Test Result	Description
RX Frequency	Receive Frequency — The frequency of the clock recovered from the received data measured in Hz.
TX Frequency	Transmit Frequency — The frequency of the clock recovered from the transmitted data measured in Hz.
Level Volts	Level Volts — The receive level on the incoming STS-1 represented in volts. Accuracy is (+/-) 10% or 20 millivolts, whichever is greater. Range is .00 to 1.99 Vp, and resolution is 0 millivolts.
RX Level dbdsx	Receive Level Decibels dsx — DS3 power of the signal received.
RX Level dbm	Receive Level Decibels below 1 Milliwatt — DS3 power of signal received in the primary DS3 test. The value is displayed as + xx.x dbm. This is not a true power measurement and is instead derived from the peak level measurement.

Table 18 — DS3 Signal test results (continued)

Table 19 — SONET Signal test results (continued)

Displayed Test Result	Description
TX Frequency (STS -1)	STS-1 Transmit Frequency — Represents the total number of STS-1 cycles transmitted during the last second.
TX Frequency (OC-3/12/48)	OC-3/12/48 Transmit Frequency — Represents the total number of OC-3/12/48 cycles transmitted during the last second.
STS-1 Level Volts	STS-1 Level Volts — Represents the receive level on the incoming STS-1 in volts. Accuracy is (+/-) 10% or 20 millivolts, whichever is greater. Range is .00 to 1.99 Vp, and resolution is 10 millivolts.
STS-1 Level dbdsx	STS-1 Level Decibels dsx — Represents the receive level on the incoming STS-1 in dbdsx. If the result is too high, the 2310 indicates the signal is too high and out of range. If the result is 0.00 Volts, it indicates the signal is too low.
STS-1 Power dbm	Receive Level Decibels below 1 Milliwatt — Represents the receive level on the incoming STS-1 in dbm. This is not a true power measurement and is instead derived from the peak level measurement. If the result is too high, the 2310 indicates the signal is too high and out of range. If the result is 0.00 Volts, it indicates the signal is too low.
Optical Power (1310/1550) dbm	Optical Power Decibels below 1 Milliwatt — Represents the receive level on the incoming optical signal (OC-3/12/48) in dbm.
BPVs	Bipolar Violations — Represents the number of bipolar violations (BPVs) detected since the beginning of the test.
BPV Rate	Bipolar Violation Rate — Represents the ratio of BPVs to received bits since initially acquiring signal presence.
BPV % Err Free Secs	BPV Percentage of Error-Free Seconds — Represents the percentage of the number of seconds during which no BPVs occurred since the beginning of the test.
Rx Overload	Receive Level Overload — Occurs when the received optical power level is greater than -6 dbm. The receiver automatically shuts down and "Rx Overload" appears (only applicable with OC-48 equipped modules).
Temp - Celsius	Temperature in Celsius degrees — Indicates the internal 2310 temperature.

BPV Category

The BPV Category results include electrical level bi-polar violation measurements.

Select **T1 Pri/Sec** from the Result Group and **BPV** from the Result Category for BPV test results.

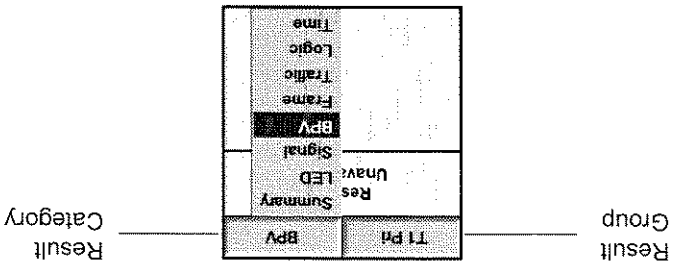

DS1 BPV test results

The DS1 BPV Category test results are defined in Table 20.

Table 20 — DS1 BPV test results

Displayed Test Result	Description
BPVs	Bipolar Violations — The number of bipolar violations (BPVs) detected since the beginning of the test. Intentional B8ZS code violations are excluded from the count.
BPV Rate	Bipolar Violation Rate — The ratio of BPVs to received bits since initially acquiring signal presence.
BPV Err Secs	BPV Errored Seconds — The number of seconds during which one or more BPVs occurred since the beginning of the test.

Frame Category

Frame errors begin accumulating after initial frame synchronization on the incoming DS1 signal. Select **T1 Pri/Sec** from the Result Group and **Frame** from the Result Category for Frame test results.

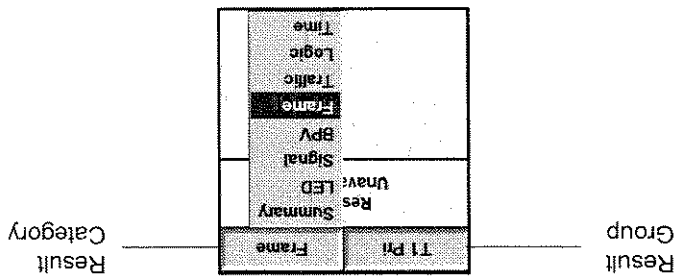

Displayed Test Result	Description
BPVs	Bipolar Violations — The number of bipolar violations (BPVs) detected since the beginning of the test. Intentional B3ZS code violations are excluded from the count.
BPV Rate	Bipolar Violation Rate — The ratio of BPVs to received bits since initially acquiring signal presence.
BPV Err Secs	BPV Errored Seconds — The number of seconds during which one or more BPVs occurred since the beginning of the test.

Table 21 — DS3 BPV test results

DS3 BPV test results The DS3 BPV Category test results are defined in Table 21.

Displayed Test Result	Description
Frame Losses	Frame Losses — A count of discrete losses of frame synchronization since initial frame synchronization or last test restart.
Frame Errors	Frame Errors — The number of frame errors detected since initial DS1 frame synchronization.
Frame Error Rate	Frame Error Rate — The ratio of frame errors to received framing bits since initially acquiring frame synchronization.
Frame Erred Secs	Frame Erred Secs — The number of seconds during which one or more frame errors occurred since initial DS1 frame synchronization.
Frame Loss Secs	Frame Loss Secs — The number of seconds during which one or more frame synchronization losses occurred or during which frame synchronization could not be achieved, since initial DS1 frame synchronization.
Frame SES	Frame Severely Erred Seconds — The number of seconds during which the total number of frame errors equals 12 or more (D4 framing only).
CRC Errors	Cyclic Redundancy Check Errors — The number of CRC errors detected since initial DS1 frame synchronization. CRC errors are counted only when ESF framing is present in the received T1 data.
CRC Erred Rate	Cyclic Redundancy Check Error Rate — The ratio of CRC errors to the number of extended superframes received.
CRC SES	Cyclic Redundancy Check Severely Erred Seconds — The number of seconds during which the total number of CRC errors and frame synchronization losses equaled 320 or more.
CRC Erred Secs	Cyclic Redundancy Check Erred Seconds — The number of seconds during which one or more CRC errors occurred.

Table 22 — DS1 Frame test results

DS1 Frame test results
The DS1 Frame Category test results are defined in Table 22.

Displayed Test Result	Description
Frame Losses	DS3 Frame Losses — The detection of frame synchronization lost since the beginning of the test.
DS2 Frame Losses	DS2 Frame Losses — The number of DS2 frame losses occurring after initial frame synchronization.
Frame Errors	Frame Errors — The number of frame errors detected since initial DS3 frame synchronization.
Frame Error Rate	Frame Error Rate — The ratio of frame errors to received framing bits since initially acquiring frame synchronization.
Frame Erred Secs	Frame Erred Seconds — The number of seconds during which one or more frame errors occurred since initial DS3 frame synchronization.
Far-End OOF Sec	Far-End Out-of-Frame Seconds — The number of seconds during which the received X-bits are zero within the 1 second interval.
Near-End OOF Sec	Near-End Out-of-Frame Seconds — The number of seconds during which an out-of-frame condition or an AIS is detected.
DS2 Frame Errors	DS2 Frame Errors — The number of DS2 frame errors detected since initial DS2 frame synchronization.
DS2 Frame Error Rate	DS2 Frame Error Rate — The ratio of detected DS2 frame errors to the total DS2 framing bits received.
TX X-Bits	Transmitted X-bit — The current setting of the transmitted X-bits when in a framed mode.
RX X-Bits	Received X-bit — The current status of the received X-bits when in a framed mode. The result is available after receiving DS3 frame synchronization.

Table 23 — DS3 Frame test results

DS3 Frame test results

The DS3 Frame Category test results are defined in Table 23.

Table 23 — D3 Frame test results (continued)

Displayed Test Result	Description
FEAC, History	Far-End Alarm and Control (FEAC) message History — The reception of at least 2 consecutive repetitions of one of the following FEAC messages in the C-bit FEAC channel:
DS3 Idle:	DS3 Idle Signal Received
DS3 AIS:	DS3 Alarm Indication Signal Received
DS3 Out of Frame:	DS3 Out-of-Frame, Loss of DS3 Frame Synchronization
DS3 LOS/HBER:	DS3 Loss-of-Signal/High Bit Error Ratio
DS3 Equip Fail SA:	DS3 Equipment Failure, Service Affecting (Type 1 equipment failure)
DS3 Equip Fail NSA:	DS3 Equipment Failure, Non-Service Affecting (Type 2 equipment failure)
DS1 Idle:	DS1 Idle Signal Received
DS1 Out of Frame:	DS1 Out-of-Frame, Loss of DS1 Frame Synchronization
DS1 LOS/HBER:	DS1 Loss-of-Signal/High Bit Error Ratio
DS1 Equip Fail SA:	DS1 Equipment Failure, Service Affecting (Type 1 equipment failure)
DS1 Equip Fail NSA:	DS1 Equipment Failure, Non-Service Affecting (Type 2 equipment failure)

Parity Category

Parity errors begin accumulating after initial frame synchronization on the incoming DS3 signal. The DS3 PARITY Category results depend on the current framing mode and the received framing signal. Select **DS3 Pri/Sec** from the Result Group and **Parity** from the Result Category for Parity test results.

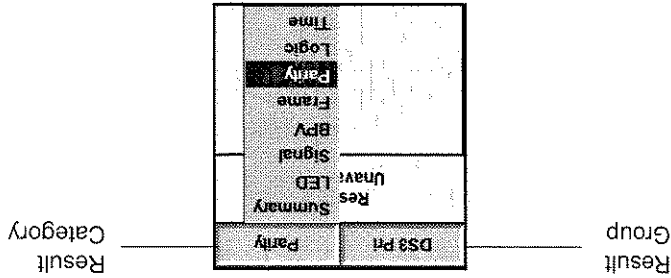

The DS3 Parity Category test results are defined in Table 24.

DS3 Parity test results

Table 24 — DS3 Parity test results

Displayed Test Result	Description
Parity Errors	Parity (P-bit) Errors — An M-Frame that contains a mismatch between either parity bit (P-bits) and the parity calculated from the information bits in the previous M-frame.
Parity Error Rate	Parity (P-bit) Error Rate — The ratio of parity errors to the number of bits over which parity was calculated.
Parity Error Secs	Parity (P-bit) Errored Seconds — The number of seconds during which one or more parity errors occurred since initial DS3 frame synchronization.
C-bit Errors	C-bit Parity Errors — An M-Frame that contains a mismatch between the majority rule of the C-bit path parity bits (CP-bits) and the parity calculated from the information bits in the previous M-frame.

Table 24 — DS3 Parity test results (continued)

Displayed Test Result	Description
C-Bit Error Rate	C-bit Parity Error Rate — The ratio of C-bit parity errors to the number of bits over which C-bit parity was calculated.
C-Bit Error Secs	C-bit Parity Errored Seconds — The number of seconds during which one or more C-bit parity error occurred since initial DS3 C-bit frame synchronization.
FEBEs	Far-End Block Errors — Far-end block errors (FEBEs) detected since initial DS3 C-bit frame synchronization caused by an M-Frame in which any of the three FEBE bits is a zero.
FEBE Rate	Far-End Block Error Rate — The ratio of FEBEs to the number of bits over which C-bit parity was calculated.
FEBE Errored Seconds	Far-End Block Errored Seconds — The number of seconds during which at least one FEBE occurred since initial DS3 C-bit frame synchronization.

Displayed Test Result	Description
Frame Word Errors	Counts the number of errored frame alignment signal (FAS) subsets (subset of bytes A1 and A2) received since gaining initial frame synchronization.
Section BIP Errors	Represents an error in the even parity Section BIP-8 (B1) byte when used as a parity check against the preceding STS-n frame. Up to 8 BIP errors may be counted per STS-n frame. Section BIP errors are only defined for the first STS-1 on an STS-n.
Section BIP Error Rate	Represents the ratio of Section BIP Errors to the total number of received bits.
Section BIP Error Sec	Counts the number of seconds in which one or more Section BIP errors occurred since test restart. The errored second interval is not synchronous to the occurrence of the BIP error.

Table 25 — SONET Section test results

SONET Section test results

The SONET Section Category test results are defined in Table 25.

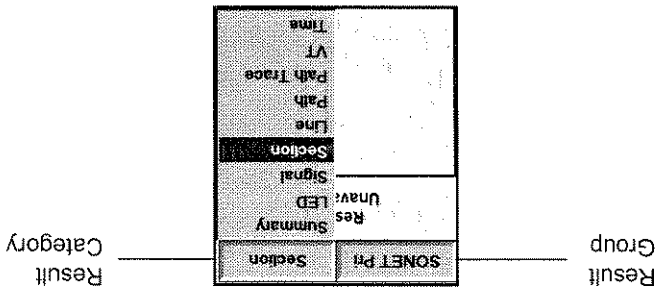

SONET Section overhead test results enable the 2310 to analyze the SONET section of a network. The results are only available when a SONET option is installed. Select **SONET Pri/Sec** from the Result Group and **Section** from the Result Group for Section test results.

SONET Section Category

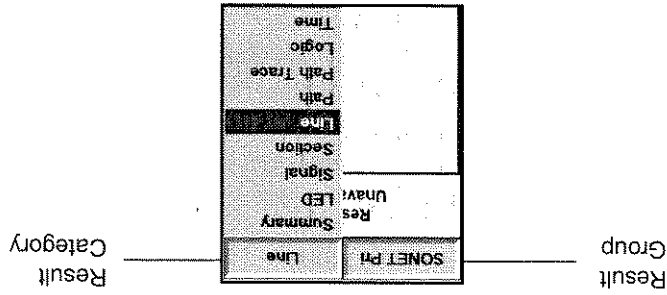

SONET Line overhead test results enable the 2310 to analyze the SONET Line of a network. The results are only available when a SONET option is installed. Select **SONET Pri/Sec** from the Result Group and **Line** from the Result Category for SONET Line test results.

SONET Line Category

Displayed Test Result	Description
SEF Defect	Severely Errored Frame Defects — Occurs when four contiguous errored frame alignment words (A1/A2 pair) are detected.
Sect SES	Section BIP Severely Errored Seconds — Represents an asynchronous test second in which 2500 or more Section BIP Errors were counted.
SEF Secs	Severely Errored Frame Seconds — Represents an asynchronous test second in which a Severely Errored Frame was counted.

Table 25 — SONET Section test results (continued)

Displayed Test Result	Description
APS Msg Count	APS Message Count — Counts the number of transitions occurring in the switch priority field of the line overhead byte (K1), Bits1 - 4. This is an indication of protection switch activity; it is not a direct count of protection switches.
APS Bridged Line	APS Bridged Line — Provides the number of the channel bridged bits 1-4 onto the protection line. If 0, then no line is bridged to the APS line.
APS Switch Mode	APS Switching Mode — Displays the current protection switching mode.
	K2 Bits
	5678
	0xxx
	1xxx
	Provisioned for 1:n
	Bidirectional switching
	Unidirectional switching

Table 26 — SONET Line test results

SONET Line test results

The SONET Line Category test results are defined in Table 26.

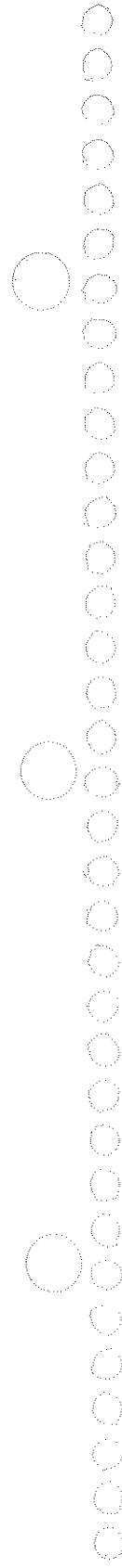

Table 26 — SONET Line test results (continued)

Displayed Test Result	Description
APS Request Msg	APS Request Message — Displays the current protection switch request message and channel as indicated by the line overhead byte (K1). Each message will have a Channel Number Code Assignment and a type of request.
	K1 Bits
	1234
	Lockout of Protection 1111
	Forced Switch 1110
	Signal Fail — High Priority 1101
	Signal Fail — Low Priority 1100
	Signal Degradate — High Priority 1011
	Signal Degradate — Low Priority 1010
	(not used) 1001
	(not used) 1000
	Manual Switch 1000
	(not used) 0111
	Wait-to-Restore 0110
	(not used) 0101
	Exercise 0100
	(not used) 0011
	Reverse Request 0010
	Do Not Revert 0001
	No Request 0000
	5678
	Channel Number Code Assignment
	Null Channel 0000
	Actual number (1-15) 0001-1111
Line BIP Error Rate	Line BIP Error Rate — Represents the Line BIP Errors/Total number of received bits in the previous STS-n frame less the SOH. The denominator of the message is the total number of non-section received bits instead of the number of BIPs so that the result is used to approximate overall received bit error rate. This approximation works on the assumption that only 1 bit error occurs per SONET frame per bit position (1-8 or 1-24 for OC-3c/12c/48c).
Line BIP Error Secs	Line BIP Error Seconds — Counts the number of seconds in which one or more Line BIP errors occurred since initial SONET frame synchronization. The errored second interval is not synchronous to the occurrence of the BIP error.

Table 26 — SONET Line test results (continued)

Displayed Test Result	Description
Line BIP Errors	Line BIP Errors — Represents an error in the even parity line BIP-8 (B2) byte when used as a parity check against the preceding STS-1 frame less the SOH. Up to 8 BIP errors may be counted per STS-1 frame. Line BIP errors are defined for all STS-1s on an STS-n. In OC-3c/12c/48c mode, three line BIPs from each STS-1 are treated as one 24 bit BIP, and hence, up to 24 BIP errors may be counted per OC-3c frame.
Line SES	Line BIP Severely Errored Seconds — Counts the number of seconds in which more than 2500 Line BIP errors occurred in 1 second for an STS-1, OC-1, or OC-3 signal; or more than 10,000 errors occurred for an OC-12 signal.
Line Unavailable Secs	Line Unavailable Seconds — Counts the number of seconds in which the line is not available based on counts of consecutive line severely errored seconds, or the presence of an AIS alarm.
Line AIS Seconds	Line Alarm Indication Signal Seconds — Represents any asynchronous test second in which Line AIS was present for any portion of the test second.
Line FEBEs	Line Far-End Block Errors — Occurs if a FEBE count is present in the Z2 byte.
Line FEBE Rate	Line Far-End Block Rate — Represents the ratio of line FEBEs to total number of received bits in the previous STS-n frame, less the SONET overhead.
Path Ptr Just	Path Pointer Justifications — Counts the number of times the synchronous payload envelope (SPE) pointer changed since initial SONET frame synchronization.
Path Ptr Incs	Path Pointer Increments — Counts the number of times the pointer bytes (H1 and H2) indicated an increment to the path payload pointer since initial SONET frame synchronization.
Path Ptr Decs	Path Pointer Decrements — Counts the number of times the pointer bytes (H1 and H2) indicated a decrement to the path payload pointer since initial SONET frame synchronization.
Path Ptr NDFs	Path Pointer New Data Flags — Counts the number of times the pointer bytes (H1 and H2) indicated an active new data flag (arbitrary change in pointer) since initial SONET frame synchronization. An active NDF occurs during a change in the payload content, or after an AIS or some other failure condition. If a change in the pointer is detected for three consecutive frames, the change is counted as an NDF, even if the pointer never has an active NDF.

SONET Path Category

Select **SONET Pri/Sec** from the Result Group and **Path** from the Result Category for SONET Path test results.

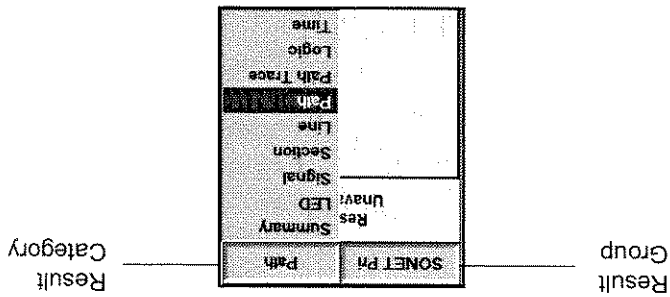

Displayed Test Result	Description
Path Ptr Value	Path Pointer Value — Presents the current STS path pointer value from 0 to 782. <i>UNAVAILABLE</i> appears under a number of error conditions, such as line AIS, etc. <i>OUT OF RANGE</i> appears if the pointer value is outside 0 to 782.
Path Ptr Size	Path Pointer Size Bits — Indicates the binary setting of the size bits in the SONET H1 byte. The normal setting for the pointer size bits is 00 to indicate a SONET payload. If the received bits are other than 00, the result appears in the SUMMARY category.

Table 26 — SONET Line test results (continued)

SONET Path test results

The SONET Path Category test results are defined in Table 27.

Table 27 — SONET Path test results

Displayed Test Result	Description
Path BIP Errors	Path BIP Errors — An error in the even parity Path BIP-8 (B3) byte when used as a parity check against the preceding STS-1 frame less the SOH and LOH. Up to 8 BIP errors may be counted per STS-1 frame. Path BIP errors are defined for all STS-1s on an STS-n. In OC-3c/12c/48c mode, the 3 Path BIPs from each STS-1 are treated as one 24 bit BIP and hence up to 24 BIP errors may be counted per OC-3c/12c/48c frame.
Path BIP Error Rate	Path BIP Error Rate — Derived from the number of times in which the Path BIP byte (B3) indicates an error in the previous frame since initial SONET frame synchronization. Path BIP Errors are divided by the total number of received bits in the previous STS-n frame less the SOH and LOH.
Path BIP Error Secs	Path BIP Error Secs — Counts the number of seconds in which one or more Path BIP errors occurred since initial SONET frame synchronization. The errored second interval is not synchronous to the occurrence of the BIP error.
Path SES	Path BIP Severely Errored Seconds — Counts the number of seconds in which 2500 or more Path BIP errors occurred since initial SONET frame synchronization.
Path Unavail Secs	Path Unavailable Seconds — Counts the number of seconds in which the Path BIP Severely Errored Second was counted or Path AIS was present for any portion of the test second.
Path AIS Secs	Path Alarm Indication Signal Seconds — Represents an asynchronous test second in which Path AIS was present for any portion of the test second.
Path AIS/LOP Secs	Path Alarm Indication Signal/Loss Of Pointer Seconds — Counts the number of seconds in which one or more Path AIS or LOP occurs.
Path LOP Secs	Path Loss Of Pointer Seconds — Shows asynchronous test seconds in which a Path LOP was present for any portion of the test.
Path FEBES	Path Far-End Block Errors — Represents the FEBE count present in the Z2 byte. Up to 8 FEBEs errors may be counted per STS-1 frame.

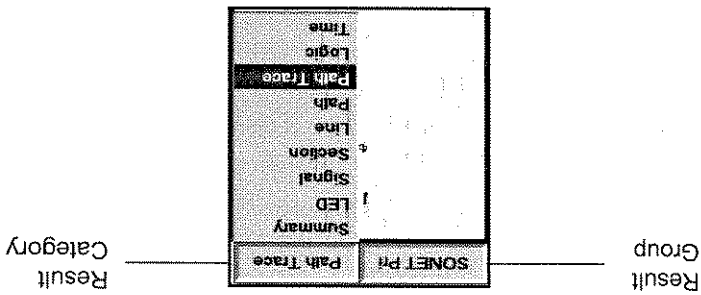

SONET Path Trace enables one of three default or user-defined messages to be transmitted over the path trace byte (J1) of the inserted STS-1 signal. Select **SONET Path Trace** from the Result Group and Path Trace from the Result Category for test results.

SONET Path Trace Category

Displayed Test Result	Description
Path FEBE Rate	Path Far-End Block Rate — Represents the ratio of FEBEs to (1) the number of bits over which C-bit parity was calculated.
STS-1 Signal Label	STS Path Signal Label — Presents the payload type being carried in the current position of the current STS. The information is derived from the Path signal label (C2) and VT overhead (V5) bytes. Any C2/V5 combinations which cannot be decoded appear as UNRECOGNIZED.

Table 27 — SONET Path test results (continued)

SONET VT Category

The SONET Virtual Tributary overhead test results enable the 2310 to analyze the SONET VT of a network. The results are only available when a SONET option is installed. Select **SONET Pri/Sec** from the Result Group and **VT** from the Result Category for SONET VT test results.

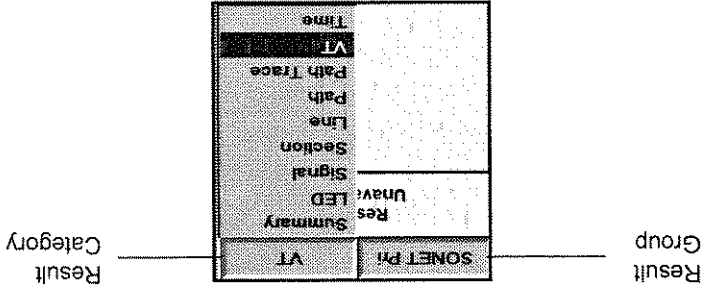

Displayed Test Result	Description
STS Path Signal Label	STS Path Signal Label — Presents the payload type being carried in the current position of the current STS. The information is derived from the Path signal label (C2) and VT overhead (V5) bytes. Any C2/V5 combinations which cannot be decoded appear as UNRECOGNIZED.
Path Trace	Path Trace Message — Displays the 64-byte path trace ASCII message which is carried in the path overhead byte (J1).

Table 28 — SONET Path Trace test results

SONET Path Trace test results

The SONET Path Trace Category test results are defined in Table 28.

SONET VT test results

The SONET VT Category test results are defined in Table 29.

Table 29 — SONET Virtual Tributary Overhead test results

Displayed Test Result	Description
VT BIP Errors	Virtual Tributary Bit Interleaved Parity (BIP) Errors — Counts the number of times in which the VT BIP byte (V5, Bits 1 and 2) indicates an error in the received signal. A maximum of two VT BIP errors can be counted in each SONET frame.
VT BIP Error Rate	Virtual Tributary BIP Error Rate — Represents the ratio of VT BIP errors to the total of received bits in the previous VT frame.
VT BIP Error Secs	Virtual Tributary BIP Error Secs — Counts the number of seconds in which one or more VT BIP errors, an AIS, or VT LOP occurred.
VT SES	Virtual Tributary BIP Severely Error Secs — Counts the number of seconds in which 600 or more VT BIP errors occurred during a single second.
VT AIS/LOP Secs	Virtual Tributary Alarm Indication Signal/Loss Of Pointer Secs — Counts the number of seconds in which one or more VT AIS or LOP occurs.
VT AIS Secs	Virtual Tributary Alarm Indication Signal Error Secs — Counts the number of seconds in which one or more VT AIS occurs.
VT LOP Secs	Virtual Tributary Loss Of Pointer Error Secs — Counts the number of seconds in which one or more VT LOP occurs.
VT Unavail Secs	Virtual Tributary Unavailable Seconds — Counts the number of seconds in which the VT path is unavailable. It is an asynchronous test second in which a Path BIP Severely Error Second was counted or Path AIS was present for any portion of the test second.
VT FEBE	Virtual Tributary FEBE — Counts the number of VT BIP errors detected by the downstream PTE. It is calculated by summing the FEBE counter of the path status byte (V5, Bit 3) from each received VT superframe.
VT FEBE Rate	Virtual Tributary FEBE Rate — Represents the ratio of VT FEBEs to the total number of received bits in the previous VT frame.
VT Ptr Just	Virtual Tributary Pointer Justifications — Represents the occurrence of a VT pointer increment, a VT pointer decrement, or a VT pointer NDF.

Displayed Test Result	Description
VT Ptr Incs	Virtual Tributary Pointer Increments — Represents an increment of 1 in the SPE pointer that is recognized when a majority vote of the 5 D bits in the V1, V2 bytes indicate an inversion.
VT Ptr Decs	Virtual Tributary Pointer Decrements — Represents a decrement of 1 in the SPE pointer that is recognized when a majority vote of the 5 D bits in the V1, V2 bytes indicate an inversion.
VT Ptr NDFs	Virtual Tributary Pointer New Data Flags — Occurs when the presence of an NDF is recognized by an invert of the 4 N Bits in the V1, V2 bytes, or when the presence of an new SPE pointer persists for 3 consecutive frames.
VT Ptr Value	Virtual Tributary Pointer Value — Presents the current VT pointer value from 0 to 103. Out of Range appears if the pointer value is outside 0 to 103.

Table 29 — SONET Virtual Tributary Overhead test results (continued)

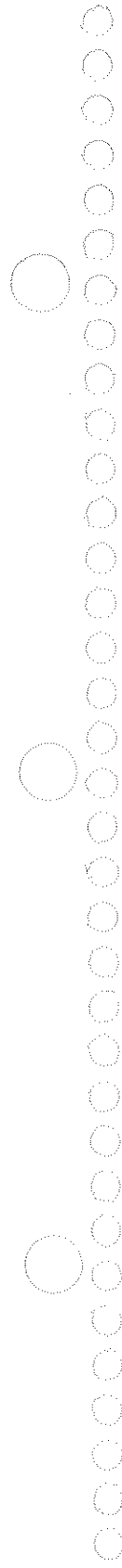

SONET ATM Category

SONET ATM successfully tests the OC-3c/12c ATM circuit by generating an ATM (cell) stream containing test cells and analyzes the received ATM cell stream. Select **ATM** from the Result Group and the appropriate category from the Result Category for SONET VT test results.

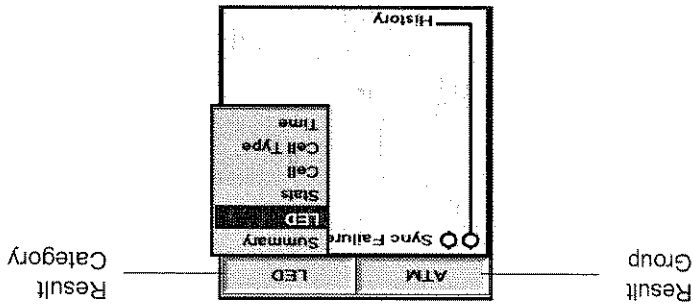

SONET ATM VP/VC test results

ATM cell streams have the following ATM test results associated with each VP/VC, as defined in Table 30.

Table 30 — ATM VP/VC Stats, Cell, and Cell Type Category results

Displayed Test Results	Description
VP1, VCI % Utilization	Measures percentage of all active (non-idle) cells with selected VP1/VCI combinations.
VP1, VCI Kbps Util	Measures approximate bandwidth in kilobits per second of all active cells with selected VP1/VCI combinations.
Total % Utilization	Measures percentage of all active cells.
Total Kbps Util	Measures approximate bandwidth in kilobits per second of all active cells in the payload.
HEC Errors	Counts cells with at least one HEC error, available after cell synchronization.

Table 30 — ATM VP/VC Stats, Cell, and Cell Type Category results (continued)

Displayed Test Results	Description
Dropped Cells	Counts the dropped test cells. The result is only available when TTC test cells are received (Type 1 or greater).
Out-Of-Seq Cells	Counts all out-of-sequence cells of TTC ATM cells being received for which the sequence number is out of order. The result is only available when a TTC profile is received.
Misinserted Cells	Counts all cells with the selected VP/VC that do not have the TTC test cell payload. The result is only available when TTC cells are received.
Correlation Tag	Indicates the current received TTC test cell correlation tag number. The result is only available when TTC test cells are received.
Cell Type	Indicates the current type of TTC ATM cells being received. The result is only available when TTC test cells are received.
Mask Cells	Counts cells received that match Rx Profile selection.
Active Cells	Counts the not-idle cells in the received ATM cell stream.

Channel Category

Results for tone analysis and tone noise analysis measurements are presented below. The VF measurements are categorized into the following result types:

Select the appropriate rate from the Result Group and Channel from the Result Category for Channel VF and DDS test results.

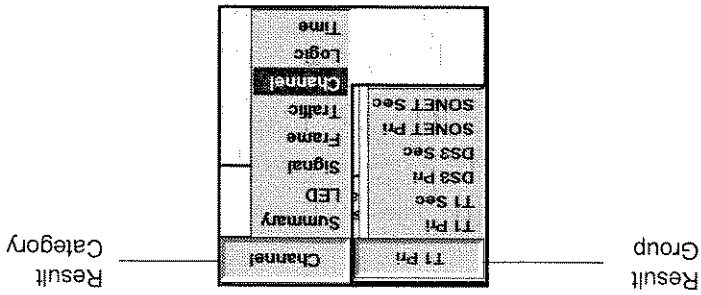

The Channel VF and DDS Category test results are defined in Table 31.

Channel VF and DDS test results

Table 31 — Channel VF and DDS Category test results

Displayed Test Result	Description
Received Byte	DDS Received Byte — Displays a sampling of the received 8-bit byte of the selected channel. If the received byte is recognized as a control code, the control code name is displayed in the RCODE result.
Frequency Hz	Voice Frequency — Represents the frequency (Hz) of a VF tone within a selected DS0 channel.
Level dBm	Voice Frequency Level — Represents the level (dBm) of a VF tone within a selected DS0 channel.

Table 31 — Channel VF and DDS Category test results (continued)

Displayed Test Result	Description
3.4K Flat dBm	3.4 KHz Flat Noise — Measures the noise (dBm) weighted with a 3 kHz flat filter. Used when qualifying data-grad circuits.
3.4K Notch dBm	Notch Noise — Measures the noise (dBm) against a weighted 3 kHz flat filter. A transmitted 1004 Hz tone is filtered out prior to the measurement for analog data-grade analysis. This measurement includes quantization noise caused by analog/digital conversion in the CODEC.
Cmsg dBmC	C-Message Noise — Measures the noise (in dBmC) weighted with a C-Message filter for voice-grade analysis. This measurement determines the noise on an idle channel.
Cnotch dBmC	C-Message Notch Noise — Measures the noise (in dBmC) against a weighted C-message filter. A transmitted 1004 Hz tone is filtered out prior to the measurement for voice-grade analysis.
Snr dB	Signal-to-Noise Ratio — Represents the signal-to-noise ratio of the received signal, assuming a 1004 Hz tone is inserted from an external source.
Holding Tone Loss	Holding Tone Loss — Occurs when a transmitted 1004 Hz tone is not detected.
DDS Control Code	DDS Control Code — Displays the name of the received DDS code identified in the DDS Receive Byte (see Table 32).

Reportable DS0 Control Codes

The Reportable DS0 Control Codes are defined in Table 32.

Table 32 — Reportable DS0 Control Codes

Code ID	Control Byte	Description
ASC	x001 1110	Abnormal Station Code. Generated by the OCU due to a signal loss from the DSU/CSU, the DSU/CSU isn't attached, or a faulty OCU.
C IDLE	x111 1110	Control Mode Idle. Equivalent to RTS set to OFF. Neither the customer nor the network is using the channel.
CHAN	x010 1000	Alternating Channel (CSU) Loopback.
D IDLE	x111 1111	Data Mode Idle. Equivalent to RTS set to ON, but no data is being sent by the computer.
DSU	x010 1100	Alternating DSU Loopback.
FEV	x101 1010	Far End Voice Byte. Last (Fourth) byte sent in latching loop up sequence.
LBE	x101 0110	Loopback Enable. Third byte sent in the latching loop up sequence.
MA	x111 0010	MJU Alert Code. Second byte sent during an MJU loop up sequence.
MAP0	x001 0011	MAP 0 Confirmation Code (line/T1 side). Sent by the second DS0-DP being looped.
MAP1	x110 1101	MAP 1 Confirmation Code (drop/DS0 side). Sent by the first DS0-DP being looped.
MOS	x001 1010	Multiplexer Out of Synchronization. Sent by SRMU when it loses substrate frame synchronization.
OCU	x010 1010	Alternating OCU Loopback.
RELEASE	x111 1000	MJU Release Code.
TA	x110 1100	Test Alert. First byte sent during an MJU loop up sequence.
TEST	x001 1100	Test Code. Sent in opposite direction during loop up.
TIP	x011 1010	Transition In Progress. First byte sent during a DS latching loop up sequence. Also sent for DS latching loop down.

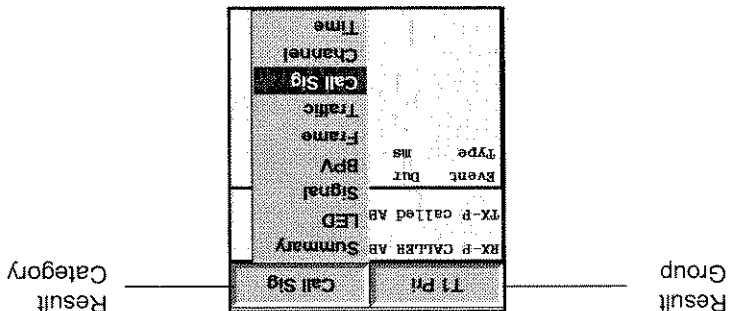

Results for the Call Signal Category provide a means to scan signaling bit transitions on all channels of a duplex T1 circuit. Select the appropriate rate from the Result Group and Call Sig from the Result Category for Call Signal test results.

Call Signal Category

Code ID	Control Byte	Description
UMC	X001 1000	Unassigned Multiplexer Channel. Sent by DS0-DP when no OCU-DP installed in channel bank.
		† x = a substrate framing bit when the byte is transmitted or received as a DS0B signal. Framing bit pattern determined by DS0B data rate.
		† x = a don't care mode when the byte is received at a DS0A substrate.
		† x = a 1 when the byte is transmitted at a DS0A substrate.
		† x = a 0 when control codes (except IDLE) are transmitted at DS0A 56 kb/s rate.
		† x = a don't care mode when control codes (except IDLE) are received at DS0A 56 kb/s rate.
		† x = a 1 when the IDLE code is transmitted or received at DS0A 56 kb/s rate.

Table 32 — Reportable DS0 Control Codes (continued)

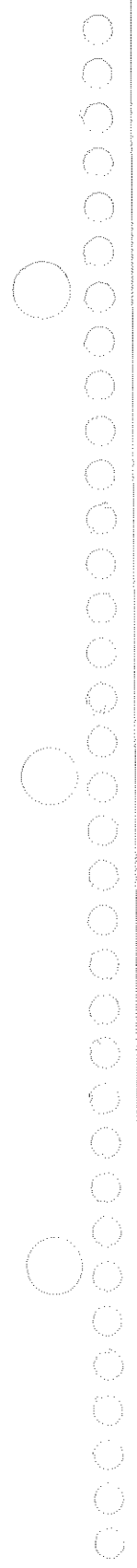

Call Signal test results

The Call Signal Category test result types are defined in Table 33.

Table 33 — Call Signal Category test results

Displayed Test Result	Description
Signaling Delay	Measures the delay between the conclusion of the previous signaling event/digit and the start of the current signaling event/digit under examination. This result is applicable to all signaling events/digits in the chronological sequence except the first event/digit in the sequence.
Signaling Duration	Measures the duration of certain signaling events and all digits in the chronological sequence. This result is applicable for all interpretable digits received, and the signaling events ring, wink, and dial tone. This result is measured in milliseconds. Any result whose value is above 9999 milliseconds (~10 seconds) will be flagged as greater than 10 seconds.

Traffic Category

Results for the Traffic Category provide a means to scan signaling bit transitions on all channels of a duplex T1 circuit. Select the appropriate rate from the Result Group and **Traffic** from the Result Category for Traffic test results.

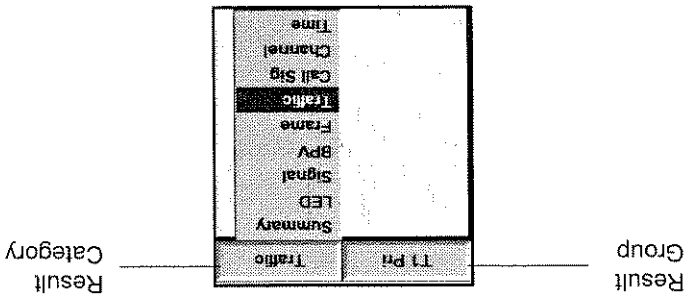

Traffic Category test results

The Traffic Category test result type is defined in Table 34.

Table 34 — Traffic Category test results

Displayed Test Result	Description
Signaling Bits	Provides the current ABCD signaling bits for either the Primary or Secondary receivers. This result is available during all T1 signaling tests with T1 frame synchronization. This result is measured as a group.

Logic Category

Logic errors are based on discrepancies between the transmitted and received bit stream. The accumulation of logic errors is dependent on frame synchronization (if in a framed mode) and pattern synchronization errors are not available until initial pattern synchronization is obtained. The results are also not available when sending loop codes. During loss of frame or pattern synchronization, the accumulation of errors is halted.

Select the appropriate rate from the Result Group and Logic from the Result Category for Logic test results.

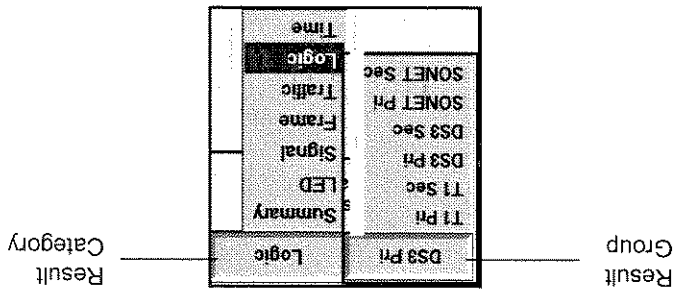

DS1, DS3, and SONET Logic test results

As the received signal is recognized, the appropriate test result displays in the message window. All three rates (DS1/DS3/SONET) share the same test result messages. Therefore, the Logic Category test results are defined in Table 35.

Table 35 — DS1, DS3, and SONET Logic test results

Displayed Test Result	Description
Pattern Losses	The number of times the received pattern is lost relative to the expected (i.e., internally generated) test pattern.

Table 35 — DS1, DS3, and SONET Logic test results (continued)

Displayed Test Result	Description
Pattern Slips	Pattern Slips — The number of times the received pattern becomes skewed relative to the expected (i.e., internally generated) test pattern. When a slip is detected, the 2310 automatically re-synchronizes to the received pattern. However, pattern bit errors are not suppressed during this process. Pattern slips are available only when using pseudorandom patterns.
Bit Errors	Bit Errors — The number of received pattern bits which have a value opposite that of the corresponding transmitted bit pattern since initial pattern synchronization.
Bit Error Rate	Bit Error Rate — The ratio of pattern bit errors to received pattern bits since initially acquiring pattern synchronization.
Sync Loss Secs	Out-of-Synchronization Loss Seconds — The number of seconds during which the receiver has lost pattern synchronization, even momentarily, since initial pattern synchronization.
Error Secs	Error Seconds — The number of seconds during which one or more pattern bit errors occurred since initial pattern synchronization.
Error-Free Secs	Error-Free Seconds — The number of seconds during which no pattern bit errors are detected while DS1 pattern synchronization is present.
% Error-Free Secs	Percentage of Error-Free Seconds — The ratio, expressed as a percentage, of seconds during which no pattern bit errors were detected, to the total number of seconds while pattern synchronization is present.

Time Category

The TIME category lists current date, time, and timed results for DS1, DS3, and SONET. Select the appropriate rate from the Result Group and Time from the Result Category for Time test results.

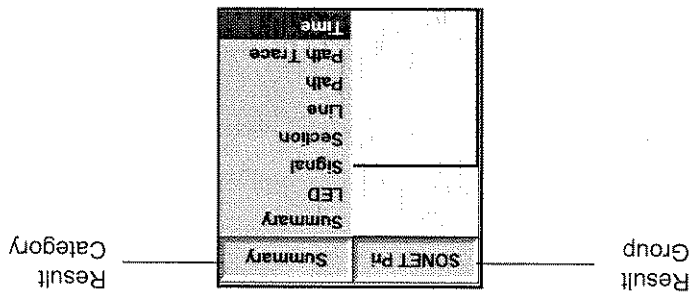

Time Category test results

The Time category results are defined in Table 36.

Table 36 — Time Category test results

Displayed Test Result	Description
Time	Current Time of Day — The current time of day in hours, minutes, and seconds. The time is set through the FILE CABINET Softkey.
Date	Current Date — The current day and month. The date is set through the FILE CABINET Softkey.
Elapsed Time	Elapsed Time — The elapsed time in hours, minutes, and seconds since the last test restart.

Displayed Test Results	Description
Packets	Counts all error-free packets with a user-specified SAP/TEI detected since test restart. If no SAP/TEI is specified, all packets are counted.
CRC Err Packets	Counts packets with CRC errors detected since test restart. The 2310 cannot count packets for a specific SAP/TEI.
Packet Error Sec	Counts errored seconds with at least one CRC errored packet.

Table 37 — GR-303 Level-2 Protocol Link test results

GR-303 Level-2 test results

GR-303 Level-2 Protocol Link test results are defined in Table 37.

Result Group		Result Category	
T1 Pn	Link Stats	T1 Pn	Call Stats
Packets 117		Call Attempts 101	
Info Packets RR Packets RNR Packets Reject Packets CRC Err Packets Discarded Packets Packet Error Sec Packet Error Rate		Call Attempts Call Connects Call Releases	

The GR-303 category Level-2 Protocol Link and Level-3 call-
 statistical test results are conducted non-intrusively on the protocol
 link. Set the Result Group to **T1 Pn** and the Category buttons to **Link**
 Stats on the left and **Call Stats** on the right.

GR-303 Category

Table 37 — GR-303 Level-2 Protocol Link test results (continued)

Displayed Test Results	Description
Packet Error Rate	Packet CRC Error Rate — Counts CRC errored packets divided by the sum of total valid packets recognized (Packets + Discarded Packets + any others with a valid SAP/TEI combination for a GR-303 system) + CRC Err Packets detected since test restart.
Discarded Packets	Discarded Packets — Counts discarded packets since test restart. Discarded packets include packets with seven successive ones (aborts), terminating flag misalignments, sizes that are not a multiple of 8 bits, as well as packets that are too long, too short, or are outside of the bounds of legitimacy.
Info Packets	Information Packets — Counts error-free information packets with a user-specified SAP/TEI detected since test restart. If no SAP/TEI is specified, all information packets are counted.
RR Packets	Receiver-Ready Packets — Counts error-free, Receiver-Ready packets with a user-specified SAP/TEI detected since test restart. If no SAP/TEI is specified, all RR packets are counted. RR packets act as a "keep-alive" for the protocol link.
RNR Packets	Receiver-Not-Ready Packets — Counts error-free, Receiver-Not-Ready packets with a user-specified SAP/TEI detected since test restart. If no SAP/TEI is specified, all RNR packets are counted.
Reject Packets	Reject Packets — Counts error-free Reject packets with a user-specified SAP/TEI detected since test restart. If no SAP/TEI is specified, all Reject packets are counted.
Link Ready	Link Ready Status — Indicates the virtual LED link activity (active/not active). The link is considered "ready" if an Unnumbered Acknowledgement (UA) response or a Receiver-Ready (RR) packet is received. The link is considered "not ready" if a Disconnect Mode (DM) response or a Receiver-Not-Ready (RNR) packet is received, or if the carrier signal is lost for that link.

Displayed Cause Code	Description
16	Normal clearing
27	Destination out of service
30	Response to STATUS ENQUIRY
34	Channel unavailable
41	Temporary failure
44	Line unit unavailable
47	Ring failure

Table 39 — GR-303 Cause Codes
GR-303 Cause Codes are described in Table 39.

GR-303 Cause Codes

Displayed Test Results	Description
Call Attempts	Counts all call attempts (Setup messages) since test restart. The receipt of each Setup message triggers an increment of one in this count.
Call Connects	Counts all calls connected (Connect messages) since test restart. The receipt of each Connect message triggers an increment of one in this count.
Call Releases	Counts all calls released since test restart due to a user-specified Cause Value (or ANY, if specified). Each released call triggers an increment of one in this count.
% Blocked Calls	Represents the ratio of released calls, due to a cause value of 34 (Channel Unavailable), to total calls attempted since test restart.

Table 38 — GR-303 Level-3 call statistical test results

GR-303 Level-3 test results
GR-303 Level-3 call-statistical test results from the TMC/CSC are described in Table 38.

Table 39 — GR-303 Cause Codes

Displayed Cause Code	Description
81	Invalid call reference
96	Mandatory information element missing
97	Message unimplemented
99	Information element unimplemented
100	Invalid information element contents
Default (any)	Unspecified cause value!

PRI ISDN Category

Test results for the Primary Rate ISDN option are displayed in the Terminate mode. There are two types of ISDN results: Physical Interface (T1, DS3, and STS-1)-Relative and Call-Relative.

PRI ISDN test results
 Table 40 lists the test Results Categories for the Primary Rate ISDN option.

Table 40 — ISDN PRI category descriptions

Category	Description
Summary Category (Primary/Secondary Result Group)	LAPD Multi-Frame Loss
	Call Fail Count
	LAPD Protocol Errors
	D channel Ready — Presented as a square LED to indicate the datalink is established and ready for call control. (Pri/Sec)
	Call Connected — Presented as a square LED to indicate a call connected for PRI Call 1 or PRI Call 2.
	Call Failure — Presented as a round LED to indicate PRI Call 1 or PRI Call 2 has been cleared with a cause other than "normal." Check Call History.
ISDN Stats Layer 2 Category (Primary/Secondary)	Frame Count — Counts total number of valid LAPD frames received.
	Errored Frames — Counts valid frames with one or more of the following errored conditions: undefined control fields, "S" or "U" frame with incorrect length, or "I" frame with a long information field.
	Invalid Frames — Counts frames with FCS errors or invalid SAP.
	Aborted Frames — Counts aborted LAPD frames detected (excluding Out-of-Frame aborts) count.
	Reject Frames — Counts LAPD reject frames.
	Frame Reject Frames — Counts LAPD frame reject frames.

Table 40 — ISDN PRI category descriptions (continued)

Category	Description
History Category (Call 1 and Call 2)	Call Failure — Stores up to 12 call attempts (including normal and abnormal call clears).

If a problem with the ISDN PRI line arises, but the physical T1 is working correctly, Cause Codes that are found in these messages become valuable information for understanding where the fault lies. For statistics about the physical T1, select **T1 PRI** or **T1 SEC**. For call specific results, such as frame statistics and LAPD statistics for the D channel, select **PRI Call 1** or **PRI Call 2**.

In the instance where there are problems completing calls or something goes wrong during the transmission, the History Category gives Cause Codes to explain where the problem may lie.

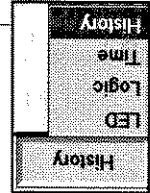

NFAS and NFAS/DCBU

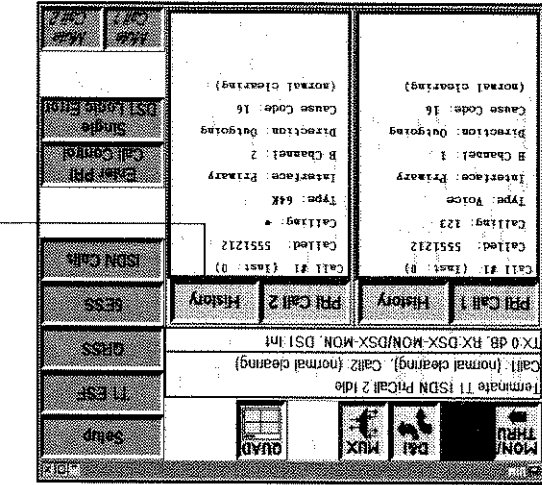

Associated Signaling

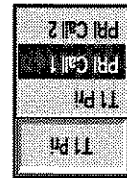
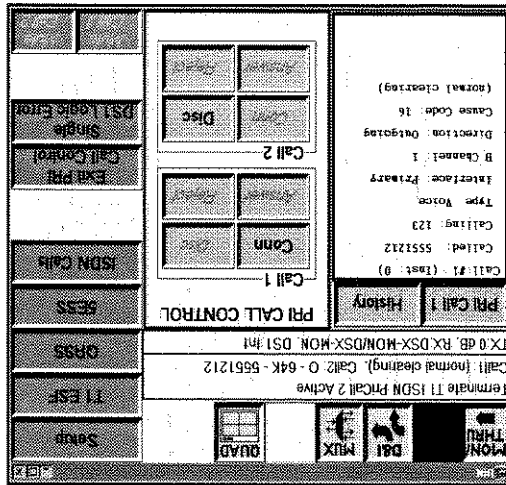

Cause Code #	Cause Message — Q.931 Cause Codes (1988)
1	Unassigned number.
2	No route to specified transit network.
3	No route to destination.
6	Channel unacceptable.
7	Call awarded and delivered in an established channel.
16	Normal call clearing.
17	User busy.
18	No user responding.
19	No answer from user (user alerted).
21	Call rejected.
22	Number changed.
26	Non-selected user clearing.
27	Destination out of order.
28	Invalid number format.
29	Facility rejected.

Table 41 — Cause Codes descriptions

Table 41 provides the information between the Cause Code and the Cause Messages that are displayed in the Message/Status window. The Cause Message is shown when the call placed between the PBX and the Network fails.

PRI ISDN Cause Codes

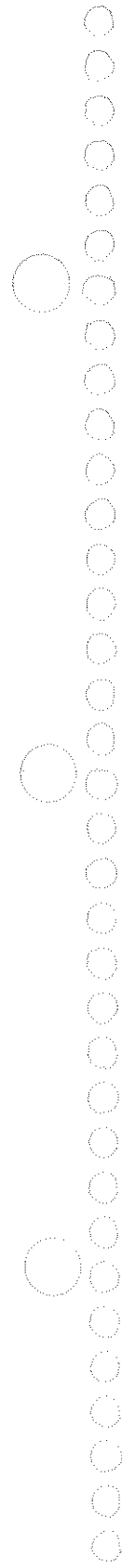

Table 41 — Cause Codes descriptions (continued)

Cause Code #	Cause Message — Q.931 Cause Codes (1988)
30	Response to STATUS INQUIRY.
31	Normal, unspecified.
34	No circuit/channel available.
41	Temporary failure.
42	Switching equipment congestion.
43	Access information discarded.
44	Requested circuit/channel not available.
47	Resources unavailable, unspecified.
50	Requested facility not subscribed.
57	Bearer capability not presently authorized.
58	Bearer capability not available.
63	Service or option not available, unspecified.
65	Bearer capability not implemented.
69	Requested facility not implemented.
79	Service or option not implemented, unspecified.
81	Invalid call reference value.
88	Incompatible destination.
96	Mandatory information element is missing.
97	Message type non-existent or not implemented.
99	Information element non-existent or not implemented.

**National-specific
Cause Codes**

Table 42 indicates National-specific cause values.

Table 42 — National-specific Cause Codes

Cause Code #	Cause message — (Defined in TA-NWT-001268)
4	Vacant code.
8	Prefix 0 dialed in error.
9	Prefix 1 dialed in error.
10	Prefix 1 not dialed.
11	Excessive digits received, Call is proceeding.

Table 41 — Cause Codes descriptions (continued)

Cause Code #	Cause Message — Q.931 Cause Codes (1988)
100	Invalid information element contents.
101	Message not compatible with call state.
102	Recovery on timer expiry.
111	Protocol error, unspecified.
127	Interworking

Quad Results

Quad Results is a results function that displays up to four embedded signal rates at once in the Results Window of the 2310. For example, by pressing the Quad Results icon, you could monitor a STS-1 signal with a DS3 mapped payload, a T1 signal, and measure the VF tone within a specific DS0, in both the Primary and Secondary directions (if the Dual Rx option is installed).

Quad Results contain a pre-defined list of results called Customized test results. Table 43 lists the Custom Results that apply for each line rate as they appear on the Custom Results property sheets. For definitions on any of the results, look in the appropriate results section of this manual.

Table 43 — Custom Results for DS0, T1, DS3, and SONET

DS0 Rate	T1 Rate	DS3 Rate	SONET Rate
Receive Byte	Rx Level dbdsx	Level dbdsx	STS-1 Rx Freq
VF Level dB	Rx Level Vpp	Level dbm	OC-n Rx Freq
VF Frequency	Rx Frequency	Rx Frequency	Path PTR Just
DDS Control Codes	Timing Slips	BPV Errors	Path BIP Errors
Error Secs	Error Secs	BPV Rate	Sec BIP Errors
Bit Errors	Bit Errors	BPV Err Secs	Line BIP Errors
Bit Error Rate	Bit Error Rate	Frame Errors	Frame Errors
BPVs	BPVs	Frame Error Rate	Frame Error Rate
BPV Rate	BPV Rate	Parity Errors	Parity Errors
BPV Err Secs	BPV Err Secs	Parity Error Rate	Parity Error Rate
Frame Errors	Frame Errors	DS2 Frame Error	DS2 Frame Error
Frame Error Rate	Frame Error Rate	DS2 Fr Err Rate	DS2 Fr Err Rate

Configuring the 2310 for Quad results

- To access Quad results
- 1 On the menu bar, press **Quad**. The Quad Results screen is automatically displays (see Figure 47). The results setup is



The Quad Results icon is applicable in all applications and tests. To engage, first use any of the test procedures described in Chapter 3, Common Applications. After you have selected the type of test and rate, you are now ready to apply the Quad Results feature. Pressing the Quad icon automatically configures the application-specific results for which you are testing to the Quad Results screen.

Using Quad results

DS0 Rate	T1 Rate	DS3 Rate	SONET Rate
Frame Loss Secs	Bit Errors	Bit Error Rate	Bit Error Rate
	C-Bit Errors	C-Bit Error Rate	FEBS
			FEBE Rate
			Err Secs

Table 43 — Custom Results for DS0, T1, DS3, and SONET (continued)

automatically configured to the application in which you are testing.

Press the Channel action button to analyze another channel.

Press the Setup action button to change any test parameters.

Press the Exit action button to go back to the original application test setup screen.

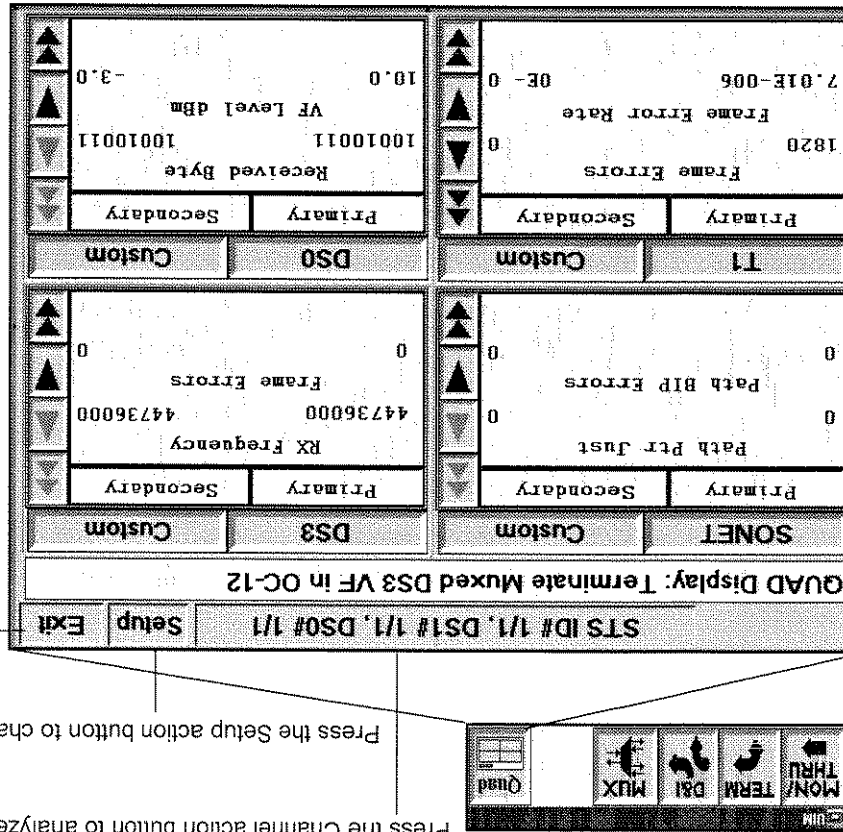
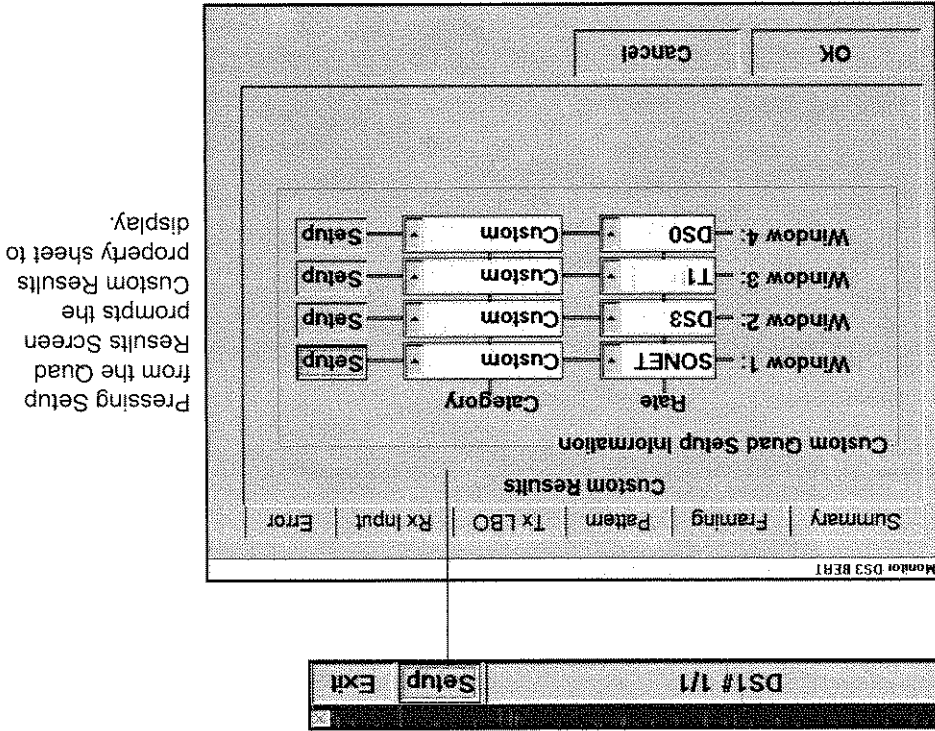

Figure 47 — Sample Quad Results screen on 2310

- 3 Select the appropriate **Rate** and **Category** in the Custom Quad Setup Information box. If you press the **Setup** action button here, a selection screen that pertains to that signal rate allows you to enable or disable results.

Figure 48 — Custom Results property sheet



Pressing Setup from the Quad Results Screen prompts the Custom Results property sheet to display.

- 2 Press **Setup** to enable the Custom Results tab associated with the applications to display, as shown in Figure 48.

4 Choose the appropriate settings as in the examples shown in Figure 49.

Pressing Setup in the Custom Quad Setup information box enables detailed parameter sheets to display. Set your parameters for each Rate and Category.

Custom Quad Setup Information

Window	Rate	Category	Action
Window 1	SONET	Custom	Setup
Window 2	DS3	Custom	Setup
Window 3	T1	Custom	Setup
Window 4	DS0	Custom	Setup

SONET Custom Results

- STS-1 RX Freq
- OC-n RX Freq
- Path Bit Just
- Path BIP Errors
- Line BIP Errors
- Sect BIP Errors

DS6 Custom Results

- Received Byte
- VF Level dbm
- VF Frequency Hz
- DDS Control Byte

DS3 Custom Results

- DS3 Level dbdsk
- DS3 Level dbm
- DS3 RX Frequency
- DS3 BL Error Rate
- DS3 DB Error Rate
- DS3 Error Sacks
- DS3 FEBS
- DS3 FERBE Rate
- DS3 BPV Errors
- DS3 BPV Rate
- DS3 D32 Frame Errors
- DS3 D32 Fr Err Rate
- DS3 Frame Errors

T1 Custom Results

- T1 RX Level dbdsk
- T1 BPV
- T1 BPV Rate
- T1 RX Level Vpp
- T1 BIP Error Sacks
- T1 RX Frequency
- T1 Timing Slips
- T1 Frame Errors
- T1 Frame Error Rate
- T1 BK Errors
- T1 BK Error Rate
- T1 Frame Loss Sacks
- T1 Error Sacks

Figure 49 — Custom Results enable/disable property sheets

As stated previously, the available test results depend on the installed options. Categories where all results are unavailable display the message Unavailable.



Customer Services

This chapter describes the customer services available through Acterna, formerly TTC and WG. Topics discussed in this chapter include the following:

- "Customer service locations" on page 236
- "Instrument services" on page 237
- "Product Enhancement Group" on page 238
- "Test systems field engineering and installation" on page 238
- "Technical training" on page 239
- "Warranty information" on page 240
- "Equipment return instructions" on page 242

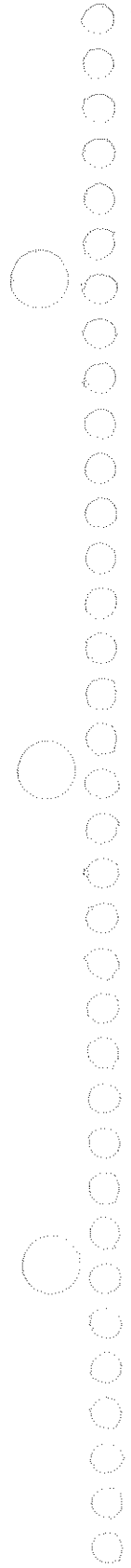

About our services

Acterna offers unmatched services to support purchased equipment, including a wide range of customer care, technical support, instrument maintenance, and training services. Acterna customer service specialists are fully trained to help customers find the answers they are looking for. Call Customer Services for the following:

- Information on products and services, including upgrades, calibration, training, software enhancement agreements (SEAs), and product maintenance agreements. Our representatives can also provide assistance with product returns and repairs.
- Expert technical support, including help with product configuration, circuit qualification, and complete network trouble sectionalization. Acterna is also available on a contractual basis to provide customized application development, network consulting and management services, software customization, and test procedure development.

All Acterna products are backed by an industry-leading warranty that guarantees maintenance repair or replacement for 3 years and all other parts for 1 year.

Customer service locations

For questions regarding Acterna products and services, including return authorizations and repairs, technical support, training, and all other available services, contact your local distributor or Acterna Customer Service.

Instrument services

To maintain your organization's long-term investment, Acterna will structure a service plan to fit your network performance goals and budget. Acterna understands the impact of equipment down time on operations and is staffed to ensure a quick turnaround. Available services include the following:

Product Repair — All equipment returned for service is tested to the same rigorous standards as newly manufactured equipment. This ensures products meet all published specifications, including any applicable product updates.

Calibration — Acterna's calibration methods are ISO 9001 approved and based on NIST standards. Each calibration comes with a dated certificate, instrument stickers, and a data sheet.

Factory Upgrades — Any unit returned for a hardware feature enhancement will also receive applicable product updates and will be thoroughly tested, ensuring peak performance of the complete feature set.

Software Enhancement Agreements — These agreements assist in keeping equipment up to date with the latest software features, by providing automatic notification of any new software enhancements and changes for Acterna products.

Product Maintenance Agreements — Yearly service and calibration maintenance agreements simplify billing and help ensure the equipment is always operating at optimum levels. Product maintenance agreements can be used to extend a current warranty or provide protection for out-of-warranty units.

Other Pricing Options — For out-of-warranty repairs, Acterna offers two additional pricing options: time and material pricing and flat rate pricing. Under time and material pricing, customers are billed for the actual cost of the repair, making this a cost-effective method for minor repairs. Under flat rate pricing, customers pay a fixed service charge to repair unit failures (excluding damage or abuse), resulting in simplified paperwork and easier budgeting.

Product Enhancement Group

The Product Enhancement Group offers one of the broadest and most experienced resource portfolios in the communications testing industry. This team of professionals offers expertise in software development, test procedure development, and network consulting, as well as years of expert test knowledge. Support is available for all core Acterna product lines:

Network Consulting and Management — Provides services such as productivity analysis, test strategy assessment, on-site applications assistance, and specialized training.

Software Customization — Develops scripts for remote and automated testing, statistics, and emulation.

Test Procedure Development — Creates procedures for automated testing, network testing, and compliance testing.

Test systems field engineering and installation

Acterna offers a range of support services for our centralized test systems, designed around the needs of the customer's network. These services help preserve the investment over the life of the equipment. Available services include the following:

Critical Services Program — Provides technical support at any time, 7 days a week, 24 hours a day. Replacement parts are guaranteed to arrive within 48 hours of contacting Acterna.

Maintenance Contracts — Cost-effective management for networks with multiple test systems.

Out-of-Warranty Service Agreement — Covers the test system for failures after the warranty expires, including all time and material costs and return shipping costs to the customer site. **Field Engineering and Installation Service** — Provides a variety of options for implementing the test system into the network, including installation, configuration, upgrades, and on-site technical support.

Technical training

By providing both experienced instructors and a hands-on atmosphere, Acterna training is designed to optimize test strategies and employee development requirements. Available services include the following:

Customized Technical Training — Designed to incorporate real-life challenges technicians face daily, while addressing the customer's training requirements, Acterna provides training at the customer's designated site, so the whole staff is trained at one time. Step-by-step reviews of current technologies and products enable new or experienced technicians to translate theory into practical, hands-on expertise.

Public Courses — Regularly scheduled, in-depth, hands-on product and technology courses are offered worldwide. Public courses provide a learning environment that allows individuals from different companies to share their knowledge and experience with their peers.

Computer-Based Training (CBT) — Acterna's CBT complements our hands-on technical training. With CBT, customers can learn about emerging communications technologies at their own convenience — at work, at home, or while traveling. Acterna's CBT courses cover technology topics such as ATM, frame relay, ISDN, LAN basics, and more.

Customized Multimedia Course Development — Multimedia courseware can be created to customer specifications, making it easier to learn new test instruments or applications. These custom packages provide consistent educational content and training for the entire staff. Students learn at their own pace on their own PC. **Consulting and Needs Analysis Services** — Acterna can help identify training needs and develop customized training curricula to maximize learning opportunities, all while providing a measurable return on investment.

Warranty Information

The warranties described herein shall apply to all commercially available Acterna products. Any additional or different warranties shall apply only if agreed to by Acterna in writing. These warranties are not transferable without the express written consent of Acterna.

Hardware Warranty — Acterna warrants that Hardware Product sold to customer shall, under normal use and service, be free from defects in materials and workmanship. The warranty period shall be three (3) years for mainframes and options (parts and labor), and (1) one year for accessories and field-replaceable batteries. If installation services have been ordered, the warranty period shall begin on the earlier of (1) completion of installation, or (2) thirty (30) days after shipment to Customer. If Installation Services have not been ordered, the warranty period shall begin upon shipment to Customer. Hereafter these periods of time shall be collectively referred to as the "Initial Warranty Period."

Acterna's obligation and customer's sole remedy under this Hardware Warranty is limited to the repair or replacement, at Acterna's option, of the defective product. Acterna shall have no obligation to remedy any such defect if it can be shown: (a) that the Product was altered, repaired, or reworked by any party other than Acterna without Acterna's written consent; (b) that such defects were the result of customer's improper storage, mishandling, abuse, or misuse of Product; (c) that such defects were the result of customer's use of Product in conjunction with equipment electronically or mechanically incompatible or of an inferior quality; or (d) that the defect was the result of damage by fire, explosion, power failure, or any act of nature.

Acterna warrants that Products returned to Acterna for repair shall be warranted from defective materials and workmanship for a one (1) year for the same repair issue, and ninety (90) days for a different repair issue from date of shipment from Acterna to customer, or until the end of the Initial Warranty Period, whichever is longer. Risk of loss or damage to Product returned to Acterna for repair or replacement shall be borne by customer until delivery to Acterna. Upon delivery of such product, Acterna

shall assume the risk of loss or damage until that time that the product being repaired or replaced is returned and delivered to customer. Customer shall pay all transportation costs for equipment or software shipped to Acterna for repair or replacement. Acterna shall pay all transportation costs associated with returning repaired or replaced product to customer.

Software Warranty — Acterna warrants that Software Products licensed to Customer shall, under normal use and service, and for a period of ninety (90) days from the date of shipment of the Software to Licensee (the "Warranty Period"), perform in all material respects in accordance with the published specifications for such Software as established by Acterna. However, Acterna does not warrant that the Software will operate uninterrupted or error free, operate in the combination with other software, meet Customer's requirements, or that its use will be uninterrupted.

Acterna's obligation and Customer's sole and exclusive remedy under this Software Warranty is limited to, at Acterna's option, either (i) correcting the material errors reported to Acterna in writing by Customer during the Warranty Period and which Acterna is able to reproduce, (ii) replacing such defective Software, provided that Acterna received written notice of such defect within the Warranty Period, or (iii) provided that Acterna received written notice of such defect within the Warranty Period, upon return to Acterna of the Software, Documentation and all other materials provided by Acterna under the applicable License, providing Customer with a refund of all charges paid with respect thereto. Acterna shall have no warranty obligations hereunder if (a) the Software is altered or modified or is merged with other software by Customer or any third party or (b) all or any part of the Software is installed on any computer equipment other than the Designated Server or used with any operating system for which the Software is not designed.

Services Warranty — Acterna warrants that the Services provided by Acterna, if any, shall be performed promptly, diligently and in a professional manner in accordance with the commercial standards of the industry. Acterna shall not, however, be responsible for any delays that are not due to Acterna's fault or

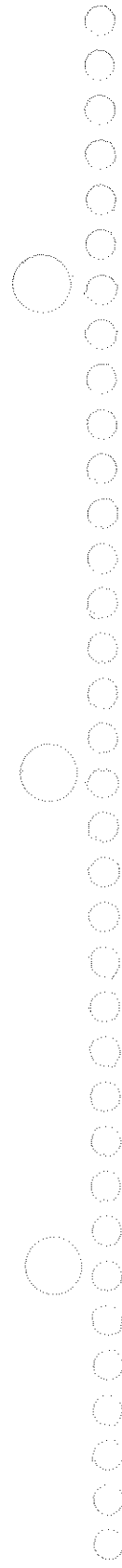

negligence or that could not have reasonably been foreseen or provided against.

WARRANTY DISCLAIMER — FOR HARDWARE, SOFTWARE, AND/OR SERVICES FURNISHED BY ACTERNA, THE FOREGOING WARRANTIES ARE IN LIEU OF ALL OTHER WARRANTIES AND CONDITIONS, EXPRESS OR IMPLIED. ACTERNA SPECIFICALLY DISCLAIMS ALL OTHER WARRANTIES, EITHER EXPRESS OR IMPLIED, ON ANY HARDWARE, SOFTWARE, DOCUMENTATION OR SERVICES INCLUDING BUT NOT LIMITED TO WARRANTIES RELATING TO QUALITY, PERFORMANCE, NONINFRINGEMENT, MERCHANTABILITY OR FITNESS FOR A PARTICULAR PURPOSE, AS WELL AS THOSE ARISING FROM ANY COURSE OF DEALING, USAGE OR TRADE PRACTICE. UNDER NO CIRCUMSTANCES WILL ACTERNA BE LIABLE FOR ANY INDIRECT OR CONSEQUENTIAL DAMAGES RELATED TO BREACH OF THIS WARRANTY.

Equipment return instructions

For each piece of equipment returned for repair, attach a tag that includes the following information:

- Owner's name, address, and telephone number.
- The serial number, product type, and model.
- Warranty status. (If you are unsure of the warranty status of your instrument, contact Acterna Customer Service.)
- A detailed description of the problem or service requested.
- The name and telephone number of the person to contact regarding questions about the repair.
- The return authorization (RA) number (US customers), or reference number (European Customers).

If possible, return the equipment using the original shipping container and material. If the original container is not available, the unit should be carefully packed so that it will not be damaged in transit; when needed, appropriate packing materials can be obtained by contacting Acterna Customer Services. Acterna is not liable for any damage that may occur during shipping. The customer should clearly mark the

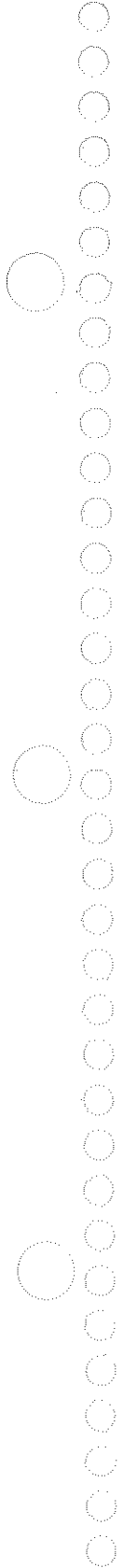

Acterna-issued RA or reference number on the outside of the package and ship it prepaid and insured to Acterna.

Equipment return instructions





Appendix

Specifications

This appendix describes the specifications for the 2310 and its options. Topics discussed are as follows:

- “Physical specifications” on page 246
- “Environmental specifications” on page 246
- “Electrical specifications” on page 247
- “DS1 input specifications” on page 248
- “DS1 output specifications” on page 249
- “DS3 and STS-1 input specifications” on page 250
- “DS3 and STS-1 output specifications” on page 251
- “Optical specifications for OC-3/12/48” on page 252
- “ISDN PRI specifications” on page 254
- “ATM specifications” on page 255
- “GR-303 specifications” on page 255

Item	Description
Temperature	Operating 32°F to 113°F (0°C to +40°C) Storage -4°F to 158°F (-20°C to +70°C)
Humidity	10% to 90% Relative Humidity, non-condensing Relative Humidity, non-condensing
Shock and Vibration	Meets IEEE-743

Table 45 — Electrical characteristics for 2310

The environmental characteristics for the 2310 unit are described in Table 45.

Environmental specifications

Item	Description
Height	7.5" (19 cm)
Width	411.5" (29.2 cm)
Depth	2.25" (5.7 cm)
Weight	5 lb. (11.02 kg.)

Table 44 — Physical characteristics for 2310

The physical characteristics for the 2310 unit are described in Table 44.

Physical specifications

Electrical specifications

The electrical characteristics for the 2310 unit are described in Table 46.

Table 46 — Electrical characteristics

Item	Description
Battery	Rechargeable 10.8 V Nickel-Metal Hydride (NiMH)
Operating Time	Typically provides up to 1.5 hours of operation performing DS3/DS1 tests. Typically provides up to 30 minutes of operation performing STS-1 and OC-3/12 SONET tests. Typically provides up to 25 minutes of operation for OC-48 SONET tests.
Recharging Period	Maximum of 1.5 hours.
AC Adaptor	19 VDC, 2.6 amps; 90-240 VAC, 45-65 Hz
Cable	75 Ohm RG59 B/U cable, attenuation measured at 22.368 MHz is 5.7 ± 0.2 dB per 450 ft. of cable.

NOTE:

The battery life may decrease after 100 charge/discharge cycles.

DS1 input specifications

The input specifications for DS1 are described in Table 47.

Table 47 — Input specifications for DS1

Item	Description
Connector type	Bantam jack
Frequency	1.544 MHz \pm 50 ppm
Impedance	BRIDGE TERM DSX-MON 1000 ohms minimum 100 ohms \pm 5% 100 ohms \pm 5%
Range	BRIDGE TERM DSX-MON +6 to -35.0 dBdsx +6 to -35.0 dBdsx -10 to -26.0 dBdsx of resistive loss
Jitter Tolerance	Per Reference Bell PUB 62411 - 1990
Accuracy	Receive Level Measurement From 6 dBdsx to -15 dBdsx, accuracy of \pm 1 dB From -16 dBdsx to -30 dBdsx, accuracy of \pm 2 dB From -31 dBdsx to -40 dBdsx, accuracy of \pm 3 dB Simplex Current Measurement \pm 2% or \pm 2 mA up to 60 mA \pm 3% or \pm 3 mA up to 61 mA to 175 mA Receive Frequency Measurement \pm 3 ppm \pm 1 ppm per year

DS1 output specifications

The output specifications for DS1 are described in Table 48.

Table 48 — Output specifications for DS1

Item	Description
Connector type	Bantam jack
LBO Level	Line build-out of 0, -7.5, -15.0, and -22.5 dB of cable loss at 772 Hz
LBO Tolerance	± 2 dB at 772 kHz for -7.5 dB, -15.0 dB, and -22.5 dB ± 1 dB at 772 kHz for 0 dB
Internal Timing	± 3 ppm ± 1 ppm per year
Line Codes	AMI or B8ZS
Error Insert Type	Logic, BPV, or Frame
Pulse Shape	With output terminated in 100 ohms resistive load and 0 dB line build-out selected, the 2310 meets ITU-T Recommendation G.703; AT&T Publications CB113, CB119, ANSI T1.403-1995, CB132, CB143, and PUB62508; and AT&T PUB62411 pulse shape specifications

DS3 and STS-1 input specifications

The input specifications for DS3 and STS-1 are described in Table 49.

Table 49 — Input specifications for DS3 and STS-1

Item	Description
Connector type	Two WECCO 560A connectors
Input Level Range	
HIGH	Accepts a nominal signal level of 1.2 Vp (0 feet of cable attenuation from a HIGH source). With cable attenuation, accepts signal levels from +5dB (-450 feet) of gain to -5 dB (450 feet) of loss from the nominal signal level (1.2 Vp). With resistive attenuation, accepts signal levels from +5 dB of gain to -28 dB of loss from the nominal signal level (1.2Vp).
DSX	Accepts a nominal signal level of 0.6 Vp (450 feet of cable attenuation from a HIGH source). With cable attenuation, accepts signal levels from +5 dB (-450 feet) of gain to -5dB (450 feet) of loss from the nominal signal level (0.6 Vp). With resistive attenuation, accepts signal levels from +6 dB of gain to -26 dB of loss from the nominal signal level (0.6 Vp).
LOW	Accepts a nominal signal level of 0.3 Vp (900 feet of cable attenuation from a HIGH source). With cable attenuation, accepts signal levels from +5 dB (-450 feet) of gain to -5 dB (450 feet) of loss from the nominal signal level (0.3 Vp). With resistive attenuation, accepts signal levels from +5 dB of gain to -5 dB of loss from the nominal signal level (0.3 Vp).
Input Impedance	75 ohms nominal, unbalanced to ground. Per applicable specifications
Jitter Tolerance	Exceeds TR-TSY-000499

NOTE:

The maximum signal that the 2310 can recover without errors is 1.7 Vp. The minimum signal that the it can recover without errors is 0.025 Vp. The maximum input signal level is 2.5 Vp.

DS3 and STS-1 output specifications

The output specifications for DS3 and STS-1 are described in Table 50.

Table 50 — Output specifications for DS3 and STS-1

Item	Description
Connector type	One WECCO 560A connector
Output level range	<p>HIGH Nominal 1.20 Vp. DS3 signal meets ANSI T1.102-1993, Table 5, and CCITT Recommendation G.703 for DS3 pulse mask when transmitted through 450 feet of coaxial cable (WECCO 728A, RG59B/U, or equivalent). STS-1 pulse mask meets BELL CORE GR-253-CORE-1995 and the DS3 ANSI T1.102-1993.</p> <p>DSX Nominal 0.61 Vp. DS3 signal meets ANSI T1.102-1993, Table 5, and CCITT Recommendation G.703, Section 5. The STS-1 signal meets ANSI T1.102-1993 and BELL CORE GR-253-CORE-1995.</p> <p>LOW Nominal 0.31 Vp. Signal is equivalent to a DSX signal transmitted through 450 feet of coaxial cable (WECCO 728A, RG59B/U, or equivalent).</p>
Output impedance	75 ohms nominal, unbalanced to ground. Per applicable specifications
Jitter transfer	Per TR-TSY-000499
Frequency	DS3 = 44.736 MHz \pm 10 ppm. STS-1 = 51.84 MHz \pm 3 ppm \pm 1 ppm per year.

Optical specifications for OC-3/12/48

The 2310 is a Class 1 Laser product which complies with 21 CFR 1040.10 - 1040.11 laser standards. Cautions must be observed before and during all phases of instrument operation. The following symbol designates a Class 1 Laser product. Please observe the warning to avoid hazardous laser light exposure.

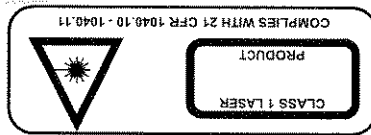

WARNING: HAZARDOUS LASER LIGHT EXPOSURE!



Do not look directly into the 2310 optical output. The optical source is designed for safe Class 1 operation. However, it is recommended that you not look directly into the optical output of the unit or at the output of any optical cable connected to the unit. If a fiber optic connection is removed from a transmitting connector, screw the safety cap onto the connector to prevent inadvertent exposure to the laser output. Use of controls, adjustments, or procedures other than those specified herein may result in hazardous laser light exposure.

The optical specifications for OC-3, OC-12, and OC-48 are described in Table 51. The receiver is a multimode compatible receiver so that it will work with multimode or single mode fiber.

Table 51 — Optical specifications for OC-3/12/48

Item	Description
Optical connector types ^a	OC-3/12/48 Receive — FC, SC, or ST OC-3/12/48 Transmit — FC, SC, or ST
Transmit Measurement Range	Transmitter works with multimode or single mode fiber Uses either 1310 or 1550 wavelengths
Output level for high-power transmit ^{b, c}	+2 to -4.3 dBm
Output level for low-power transmit	- 8.0 to -15 dBm
Eye diagram	Per BELL CORE; GR-253-CORE-1995
Clock frequency accuracy	± 3 ppm ± 1 ppm per year
Receive Measurement Range	- 8 dBm to -28 dBm
Receive level sensitivity	± 100 ppm year
Frequency range for OC-3 equipped units	± 500 ppm year
Frequency range for OC-3/12/48 equipped units	± 500 ppm year
Frequency measurement accuracy	± 3 ppm ± 1 ppm per year
Jitter tolerance	Per BELL CORE; GR-253-CORE-1995
Receiver shutdown ^c	-6 dBm
Reflectance for OC-3/12/48 equipped units	> +20 dBm
Range for OC-3/12/48 equipped units	- 6 to -28 dBm
Range for OC-3 and OC-3/12 equipped units	- 5 to -45 dBm
Accuracy	± 2 dB
Resolution	± 0.1dB
<p>a. Never remove laser connectors to clean the optical fiber. Damage to the optics may occur if this is done. Refer all servicing to qualified Acterna service personnel.</p> <p>b. On OC-3 or OC-3/12 equipped units, the only transmitter provided meets the low-power specification. A high-power transmit is only provided with units equipped up to OC-48.</p> <p>c. A greater than -8 dbm optical-level signal should not be input into the 2310. Damage to the receiver may occur. Never self-loop the high-power transmitter back to the test set.</p>	

ISDN PRI specifications

ISDN PRI characteristics

Table 52 lists the specifications for the Primary Rate ISDN option.

Table 52 — ISDN option characteristics

Item	Specification
Connectors	Option utilizes the T1 interface connectors.
Line Termination (resistive)	100 ohms $\pm 5\%$.
TEI Assignment	0

The status message display window (below the application selection buttons) shows the status of the D channel and the progress of ISDN calls for both incoming and outgoing calls. Table 53 provides the list of messages and their descriptions. The second line of the status message window also provides additional information about call direction.

Table 53 — ISDN PRI status messages

Message	Description
1	Incoming
0	Outgoing
Call Type	64k, 56k, Voice, Nx64k, Nx56k, H0
Called Num	Outgoing calls
Calling Num	Incoming Calls

ATM specifications

The specifications for the ATM analysis option are based on the following standards:

- ITU-T I.150-1995 — B-ISDN Asynchronous Transfer Mode functional characteristics
- ITU-T I.356-1996 — B-ISDN ATM layer cell transfer performance
- ITU-T I.361-1999 — B-ISDN ATM Layer specifications
- ITU-T O.191-1997 — Equipment to assess ATM Layer Cell Transfer performance
- ITU-T O.191 Addendum 1-1997 — Equipment to assess ATM Layer Cell Transfer performance

GR-303 specifications

The specifications for the GR-303 option are based on the following standards:

- Bellcore, TR-NWT-000303-1992 — *Integrated Digital Loop Carrier System Generic Requirements, Objectives, and Interface, Issue 2*
- Bellcore, GR-303-CORE-1996 — *Integrated Digital Loop Carrier System Generic Requirements, Objectives, and Interface, Issue 1, Revision 2*
- ITU-T, Recommendation Q.921-1997 — Digital Subscriber Signaling System No. 1 (DSS 1) - ISDN User-Network Interface - Data Link Specification
- ITU-T, Recommendation Q.931-1993 — Digital Subscriber Signaling System No. 1 (DSS 1) - ISDN User-Network Interface Layer 3 Specification for Basic Call Control, (ITU-T, March 1993)

Index

Symbols

% Error-Free Secs
logic test result, 219

A

A/B/C/D Signaling Bits
monitoring, 77

Aborted Frames
ISDN PRI test results, 225

Action Softkeys
main screen, 26

Active Port LEDs
top-panel features, 11

AIS
DS1 LED test result, 184

Alarm
LED display for current/history
signal, 17

Alarm LEDs
red, 19

Alarms LED
SONET alarm LED, 19

Analysis

T1 timing slip, 52

Application Icon Selection
main screen, 21

Application Icons with Pull-Down
Lists, 22

Application Setup Property
Screens, 28

Applications

common, 41
DDS option, 67

DDS drop and insert
testing, 71

DDS loopback BER
testing, 67

DS3 BER testing, 108

DS3 option, 105

monitoring DS3
performance, 105

FT1 option, 57

FT1 drop and insert
testing, 61

FT1 loopback BER
testing, 57

intelligent prepeater span
option, 99

- OC-3 and OC-12 option, 125
- monitoring OC-3 and OC-12 performance, 126, 143
- OC-3 and OC-12 BER testing, 130
- optical power measurement, 134
- signaling option, 77
- monitoring A/B/C/D signaling bits, 77
- PBX/switch emulation (original bits), 77
- PBX/switch emulation (terminating a call), 83
- PBX/switch emulation (terminating a call), 85
- signaling monitor (call capture), 79
- T1 drop and insert setup (place call), 87
- STS-1 option, 113
- monitoring STS-1 performance, 113
- STS-1 BER testing, 117
- VT1.5 drop/monitoring from STS-1, 121
- T1 option, 43
- monitoring T1 performance, 43
- T1 BERT termination setup, 46
- T1 loopback BER testing, 49
- T1 timing slip analysis, 52
- VF option, 91
- transmitting VF tones, 95
- VF channel drop/monitor setup, 91
- VT100 emulation option, 137
- APS Bridged Line SONET line test result, 201
- APS Msg Count SONET line test result, 201
- APS Request Msg SONET line test result, 202
- APS Switch Mode SONET line test result, 201
- OC-3 and OC-12 option, 125
- monitoring OC-3 and OC-12 performance, 126, 143
- OC-3 and OC-12 BER testing, 130
- optical power measurement, 134
- signaling option, 77
- monitoring A/B/C/D signaling bits, 77
- PBX/switch emulation (original bits), 77
- PBX/switch emulation (terminating a call), 83
- PBX/switch emulation (terminating a call), 85
- signaling monitor (call capture), 79
- T1 drop and insert setup (place call), 87
- STS-1 option, 113
- monitoring STS-1 performance, 113
- STS-1 BER testing, 117
- VT1.5 drop/monitoring from STS-1, 121
- T1 option, 43
- monitoring T1 performance, 43
- T1 BERT termination setup, 46
- T1 loopback BER testing, 49
- T1 timing slip analysis, 52
- VF option, 91
- transmitting VF tones, 95
- VF channel drop/monitor setup, 91
- VT100 emulation option, 137
- APS Bridged Line SONET line test result, 201
- APS Msg Count SONET line test result, 201
- APS Request Msg SONET line test result, 202
- APS Switch Mode SONET line test result, 201
- Available Interface Connectors getting started, 12
- B**
- B8ZS DS1 LED test result, 184
- Basic Test Setup, 36
- Battery
 - access door
 - bottom-panel features, 10
 - recharging the, 39
 - replacement, 40
- Battery Low LED front-panel features, 9
- BER Testing
 - DDS loopback, 67
 - DS3, 108
 - FT1 loopback, 57
 - OC-3 and OC-12, 130
 - simulation of DDS loopback, 70
 - STS-1, 117
 - T1 loopback, 49
 - T1 termination setup, 46
- Bit Error Rate logic test result, 219
- Bit Errors logic test result, 219
- Bits
 - monitoring A/B/C/D signaling, 77
 - Blue Alarm DS3 LED test result, 185
 - Bottom Vent bottom-panel features, 10
 - Bottom-Panel Features getting started, 9
 - BPV % Err Free Secs SONET (STS-1) BPV test result, 191
 - BPV Category description, 24

C-Bit Error Rate
DS3 parity test result, 198

C-Bit Error Seconds
DS3 parity test result, 198

C-Bit Errors
DS3 parity test result, 197

C-Bit Frame
DS3 LED test result, 185

Changing Between Primary and Secondary Receivers
description, 23

Changing Modules
instrument description, 6

Channel Category
description, 25

Charging LED
front-panel features, 9

Choosing Test Results
description, 23

Codes
reportable DSO control, 214

Common Applications, 41

Computer-Based Training (CBT)
technical training, 239

Concat Payload
SONET LED test result, 187

Connection
printer, 31

Connectors
available interface, 12

Consulting and Needs Analysis Services
technical training, 239

Control Codes
reportable DSO, 214

CRC Erred Rate
DS1 frame test result, 194

BPV Err Secs
DS1 BPV test result, 192
DS3 BPV test result, 193

BPV Rate
DS1 BPV test result, 192
DS3 BPV test result, 193

BPVs
DS1 BPV test result, 192
DS3 BPV test result, 193
SONET (STS-1) BPV test result, 191

BPV Test Results
DS1, 192
DS3, 193

Calibration
instrument service, 237

Call 1
ISDN PRI result screens, 227

Call 1 Connected
ISDN PRI test results, 225

Call Capture
signaling monitor, 79

Call Fail Count
ISDN PRI test results, 225

Call Failure
ISDN PRI test results, 225, 226

Call Sig (Call Signal) Category
description, 25

Category
DS1 LED, 184
DS1 summary, 181
DS3 summary, 182
errors, 39
pull-down list in results, 23
SONET LED, 186
SONET summary, 182

C

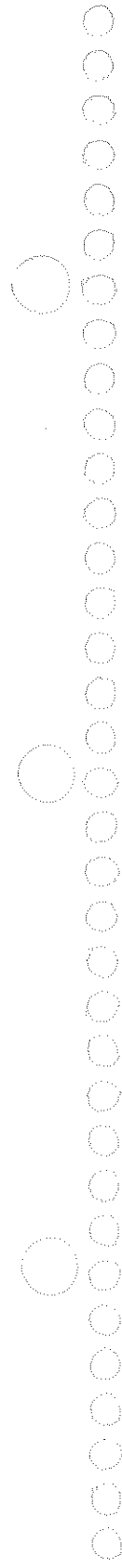



- CRC Erred Secs
 - DS1 frame test result, 194
- CRC Errors
 - DS1 frame test result, 194
- CRC SES
 - DS1 frame test result, 194
- Critical Services Program
 - test systems field engineering and installation, 238
- Custom Results Enable/Disable
 - Property Sheets, 234
- Custom Results Property Sheet, 233
- Customer Service Locations, 236
- Customized Multimedia Course Development
 - technical training, 239
- Customized Technical Training
 - customer services, 239
- D**
- D&I Mode
 - description, 22
- Date
 - time test result, 220
- D-Channel Ready
 - ISDN PRI test results, 225
- DPS Drop and Insert Setup
 - simulation, 76
- DPS Drop and Insert Testing, 71
- DPS Loopback BER Test Setup
 - simulation, 70
- DPS Loopback BER Testing, 67
- DPS Option
 - common applications, 67
- Display Panel
 - LED, 17
- Drop and Insert Setup
 - DPS testing, 71
 - FT1 testing, 61
 - simulation DDS, 76
 - T1 (place call), 87
- Drop/Monitor Setup
 - VF channel, 91
 - VT1.5 from STS-1, 121
- DS0 Control Codes
 - reportable, 214
- DS1
 - input specifications for, 248
- DS1 BPV Test Results, 192
- DS1 Frame Test Results, 194
- DS1 Idle
 - DS1 LED test result, 184
- DS1 LED Category
 - test results, 184
- DS1 Signal Test Results, 188
- DS1 Summary Category
 - test results, 181
- DS1 Timing Slips
 - simulation, 56
- DS1, DS3, and SONET Logic Category
 - test results, 218
- DS1/DS3/STS-1 Primary and Secondary RX & TX Jacks
 - top-panel features, 11
- DS2 Frame Error Rate
 - DS3 frame test result, 195
- DS2 Frame Errors
 - DS3 frame test result, 195
- DS2 Frame Loss
 - DS3 LED test result, 185
- DS2 Frame Losses
 - DS3 frame test result, 195

Equipment Return Instructions
 service and repair
 information, 242

Error Secs
 logic test result, 219

Error/Alarm Insert Test Setup
 MON/THRU mode, 129

Errored Frames
 ISDN PRI test results, 225

Error-Free Secs
 logic test result, 219

Errors Category, 39

Events Property Sheet, 34

Excess Zeros
 DS1 LED test result, 184

F

Factory Upgrades
 instrument service, 237

Far-End OOF Sec
 DS3 frame test result, 195

FEAC, History
 DS3 frame test result, 196

Features
 bottom-panel, 9
 front-panel, 8
 top-panel, 10

FEBE Errored Seconds
 DS3 party test result, 198

FEBE Rate
 DS3 party test result, 198

FEBEs
 DS3 party test result, 198

Field Engineering and Installation
 Service
 test systems field engineering
 and installation, 238

Frame Category
 description, 24

DS2 Frame Sync
 DS3 LED test result, 185

DS3 and STS-1
 output specifications for, 251

DS3 BER Testing
 common applications, 108

DS3 BPV Test Results, 193

DS3 Frame Test Results, 195

DS3 Idle
 DS3 LED test result, 185

DS3 Logic Category
 test results, 218

DS3 Option
 common applications, 105

DS3 Party Test Results, 197

DS3 Performance
 monitoring, 105

DS3 Signal Test Results, 189

DS3 Summary Category
 test results, 182

Dual Test Results Display
 main screen, 27

Dual Test Results Display
 (Labeled), 28

Dual-PCMCIA Card Door/Slot
 top-panel features, 11

E

Elapsed Time
 time test result, 220

Emulation (Originating a Call)
 PBX/switch, 83

Emulation (Terminating a Call)
 PBX/switch, 85

Enable/Disable Property Sheets
 custom results, 234

FT1 Option
common applications, 57

G

Green Status LEDs, 18

I

icons
Permanent Softkey, 15, 16

information
warranty, 240

input specifications
DS1, 248

installation
test systems field engineering
and, 238

instructions
equipment return, 242

instrument service
customer services, 237

intelligent repeater span option
common applications, 99

invalid frames
ISDN PRI test results, 225

ISDN PRI
Status Messages, 254

L

LAPD Multi-Frame Loss
ISDN PRI test results, 225

LAPD Protocol Errors
ISDN PRI test results, 225

LCD
front-panel features, 9

LED Category
description, 24

LED Display for Current/History Sig-
nal Alarm, 17

Frame Count
ISDN PRI test results, 225

Frame Erred Secs
DS1 frame test result, 194

Frame Error Rate
DS1 frame test result, 194

Frame Errors
DS3 frame test result, 195

Frame LED
DS1 alarm LED, 19

Frame Loss Secs
DS1 frame test result, 194

Frame Losses
DS1 frame test result, 194

Frame Reject Frames
ISDN PRI test results, 225

Frame SES
DS1 frame test result, 194

Frame Slips
DS1 signal test result, 189

Frame Test Results
DS1, 194

Frame Word Errors
SONET section test result, 199

Front-Panel Features
getting started, 8

FT1 Drop and Insert Testing, 61
FT1 Loopback Test Setup
simulation, 61

FT1 Loopback BER Testing, 57

LED Display Panel, 17
front-panel features, 9

LED Test Results
DS3, 185
SONET, 186

LEDs
green status, 18
red alarm, 19

Level Volts
DS3 signal test result, 190

Line AIS
SONET LED test result, 186

Line AIS Seconds
SONET line test result, 203

Line BIP Error Rate
SONET line test result, 202

Line BIP Error Secs
SONET line test result, 202

Line BIP Errors
SONET line test result, 203

Line Category
description, 25

Line FEBE Rate
SONET line test result, 203

Line FEBEs
SONET line test result, 203

Line RDI
SONET LED test result, 186

Line SES
SONET line test result, 203

Line Unavailable Seconds
SONET line test result, 203

Locations
customer service, 236

Logic Category
description, 24

Loopback BER Testing
DDS, 67

Loopback Test Setup
simulation of DDS, 70
simulation of FT1, 61
simulation of T1, 52

M
Main Screen, 21
Maintenance Contracts
test systems field engineering
and installation, 238

Measurement
optical power, 134

Message Display
main screen, 28

Messages
ISDN PRI status, 254

Mon/Thru Mode Error/Alarm Insert
Test Setup, 129

Mon/Thru Modes
description, 21

Monitor (Call Capture)
signaling, 79

Monitoring
A/B/C/D signaling bits, 77
DS3 performance, 105
OC-3 and OC-12
performance, 126, 143
STS-1 performance, 113
T1 performance, 43

MUX Mode
description, 22

N
Near-End OOF Sec
DS3 frame test result, 195

Network Consulting and Manage-
ment
product enhancement group, 238

- O**
 - OC-12 Performance
 - monitoring OC-3 and, 126, 143
 - OC-3 and OC-12 BER Testing, 130
 - OC-3 and OC-12 Option
 - common applications, 125
 - OC-3 and OC-12 Performance
 - monitoring, 126, 143
 - OC-3 RX Frequency
 - SONET signal test result, 190
 - OC-3 TX Frequency
 - SONET signal test result, 191
 - Ones Density
 - DS1 LED test result, 184
 - Optical Power dbm
 - SONET signal test result, 191
 - Optical Power Measurement, 134
 - Options
 - DDS
 - common applications, 67
 - DS3
 - common applications, 105
 - FT1
 - common applications, 57
 - intelligent repeater span
 - common applications, 99
 - OC-3 and OC-12
 - common applications, 125
 - signaling
 - common applications, 77
 - STS-1
 - common applications, 113
 - T1
 - common applications, 43
 - VF
 - common applications, 91
 - VT100 emulation
 - common applications, 137
 - Other Pricing Options
 - instrument service, 237
- P**
 - Panel
 - bottom, 9
 - front, 8
 - LED display, 17
 - top, 10
 - Parity Category
 - description, 25
 - Parity Error Rate
 - DS3 parity test result, 197
 - Parity Error Seconds
 - DS3 parity test result, 197
 - Parity Errors
 - DS3 parity test result, 197
 - Parity Test Results
 - DS3, 197
 - Path & VT LED
 - status LED, 18
 - Path AIS
 - SONET LED test result, 186
 - Path AIS Secs
 - SONET path test result, 205
 - Path AIS/LOP Secs
 - SONET path test result, 205
 - Path BIP Error Rate
 - SONET path test result, 205
 - Path BIP Error Secs
 - SONET path test result, 205
 - Path BIP Errors
 - SONET path test result, 205
 - Path Category
 - description, 25
- Out-of-Warranty Service Agreement**
 - test systems field engineering
 - and installation, 238
 - Output Specifications
 - DS3 and STS-1, 251

Permanent Softkey Icons
color display, 15
transflective-monochrome
display, 16

Permanent Softkeys
main screen, 25

Place Call
T1 drop and insert setup, 87

Power LED
front-panel features, 8

Power Measurement
optical, 134

Power Switch
bottom-panel features, 10

Preview Screen of Files within Print
Buffer, 33

PRI Status Messages
ISDN, 254

Print Buffer
preview screen of files within, 33

Printer
connection, 31
settings property sheet, 35
setup, 31

Printer Connector
top-panel features, 11

Printer settings, 31
printer settings, 35

Printout Controls Property Sheets
events, 34
printer settings, 35
printouts, 32

Product Enhancement Group
customer services, 238

Product Maintenance Agreements
instrument service, 237

Product Repair
instrument service, 237

monitoring T1, 43

monitoring STS-1, 113

143

monitoring OC-3 and OC-12, 126,

Performance
monitoring DS3, 105

terminating a call, 85

originating a call, 83

PBX/Switch Emulation
logic test result, 219

Pattern Slips
logic test result, 218

Pattern Losses
status LED, 18

SONET alarm LED, 19

DS3 alarm LED, 19

DS1 alarm LED, 19

Pattern LED
SONET path test result, 205

Path Unavail Secs
description, 25

Path Trace Category
SONET path trace test result, 207

Path Trace
SONET path test result, 205

Path SES
SONET LED test result, 187

Path RDI
SONET alarm LED, 19

Path PTR LED
SONET path test result, 205

Path LOP Secs
SONET LED test result, 187

Path LOP
SONET path test result, 205

Path FEBES
SONET path test result, 206

Path FEBE Rate

Property Sheet
 custom results, 233
 custom results enable/disable, 234
 events, 34
 printout controls, 32, 34, 35
 printouts, 32
 setup summary, 29
 tabs set test parameters, 30
 Property Sheets
 application setup, 28
 PTR ADJ LED
 SONET alarm LED, 19
 Public Courses
 technical training, 239
 Pull-Down List
 application icons with, 22
 in results category, 23
Q
 Quad Results
 description, 22
 Quick Configuration Softkeys
 main screen, 26
 Quick Configuration/Action Buttons
 Diagram, 26
R
 Receive Byte
 channel VF and DDS test
 result, 212
 Recharging the Battery, 39
 Red Alarm LEDs, 19
 Reject Frames
 ISDN PRI test results, 225
 Replacing Battery, 40
 Reportable DS0 Control Codes, 214
 Results
 DS1 BPV, 192
 DS1 frame, 194

DS1 signal, 188
 DS1 summary, 181
 DS3 BPV, 193
 DS3 frame, 195
 DS3 LED, 185
 DS3 parity, 197
 DS3 signal, 189
 DS3 summary, 182
 SONET LEDs, 186
 SONET section, 199
 SONET signal, 190
 SONET summary, 182
 using quad, 231
 Results Category Display
 main screen, 23
 Results Display (Labeled)
 dual test, 28
 Results Enable/Disable Property
 Sheets
 custom, 234
 Results Group Display
 main screen, 23
 Results group selection, 23
 Results Group Selection on Main
 Menu Screen, 23
 Results Property Sheet
 custom, 233
 Return Instructions
 equipment, 242
 RX Frequency
 DS1 signal test result, 188
 DS3 signal test result, 190
 RX Level dbdsx
 DS3 signal test result, 190
 RX Level dbm
 DS1 signal test result, 189
 DS3 signal test result, 190
 RX Pulse and TX Laser LEDs
 top-panel features, 11

simulation of FT1 loopback test, 61
simulation of T1 loopback test, 52
simulation of T1 termination test, 48
summary property sheet, 29
T1 BERT termination, 46
T1 drop and insert (place call), 87
VF channel drop/monitor, 91

Sheet
custom results enable/disable property, 234
custom results property, 233
printer settings property, 35
printout controls property, 32, 34, 35
setup summary property, 29

Signal Alarm
LED display for current/history, 17
Signal Category description, 24

Signal LED
DS1 alarm LED, 19
DS3 alarm LED, 19
SONET alarm LED, 19

Signal Loss Count
DS1 signal test result, 188
DS3 signal test result, 189

Signal Loss Secs
DS1 signal test result, 188
DS3 signal test result, 189

Signal Losses
SONET signal test result, 190

Signal Test Results
DS1, 188
DS3, 189
SONET, 190

Signaling Bits
monitoring A/B/C/D, 77

RX X-Bits
DS3 frame test result, 195

S
Sample Configuration/Action Buttons Usage, 27
Sample Quad Results Screen, 232

Screen
application setup property, 28
main, 21
results group selection on main menu, 23

Sec SES
SONET section test result, 200

Section BIP Error Rate
SONET section test result, 199

Section BIP Error Sec
SONET section test result, 199

Section BIP Errors
SONET section test result, 199

Section Category
description, 25
test results, 199

SEF Defect
SONET section test result, 200

SEF Secs
SONET section test result, 200

Service
instrument, 237

Service Locations
customer, 236

Setup
basic test, 36
MON/THRU mode error/alarm insert test, 129
printer, 31
simulation DDS drop and insert, 76
simulation of DDS loopback BER test, 70

- DS1 traffic test result, 217
- Signal Delay
 - call signal test result, 216
- Signaling Duration
 - call signal test result, 216
- Signaling Monitor (Call Capture), 79
- Signaling Option
 - common applications, 77
- Simplex Curr mA
 - DS1 signal test result, 188
- Simulation
 - DDS drop and insert setup, 76
 - DDS loopback BER test setup, 70
 - DS1 timing slips, 56
 - FT1 loopback test setup, 61
 - T1 loopback test setup, 52
 - T1 termination test setup, 48
- Softkey icons
 - Permanent, 15, 16
- Software Customization
 - product enhancement group, 238
- Software Enhancement Agreements
 - instrument service, 237
- SONET LED Category
 - test results, 186
- SONET Logic Category
 - test results, 218
- SONET Signal Test Results, 190
 - SONET Summary Category
 - test results, 182
 - SPE Pointer Justification
 - SONET line test result, 203
 - Speaker
 - front-panel features, 8
 - Specifications
- SONET alarm LED, 20
- SONET FAILURE
 - Summary Property Sheet
 - setup, 29
- SONET alarm LED, 19
- SUMMARY
 - SONET alarm LED, 19
 - Summary Category
 - description, 24
 - DS1 test results, 181
 - DS3 test results, 182
 - SONET test results, 182
- Summary Property Sheet
 - setup, 29
- SYNC FAILURE
 - SONET alarm LED, 20
- STS Path Signal Label
 - SONET path trace test result, 207
- STS-1 BER Testing, 117
- STS-1 Level dBdsx
 - SONET signal test result, 191
- STS-1 Level Volts
 - SONET signal test result, 191
- STS-1 Option
 - common applications, 113
- STS-1 Performance
 - monitoring, 113
- STS-1 RX Frequency
 - SONET signal test result, 190
- STS-1 TX Frequency
 - SONET signal test result, 191
- STS-Power dbm
 - SONET signal test result, 191
- SONET signal test result, 191

DS3 signal, 189
 DS3 summary, 182
 dual display (labeled), 28
 SONET LED, 186
 SONET section, 199
 SONET signal, 190
 SONET summary, 182

T

Sync Loss Secs
 logic test result, 219

T1 BERT Termination Setup, 46
 T1 Drop and Insert Setup (Place Call), 87
 T1 Loopback BER Testing, 49
 T1 Loopback Test Setup
 simulation of, 52

T1 Option
 common applications, 43
 T1 Performance
 monitoring, 43
 T1 Termination Test Setup
 simulation of, 48

T1 Timing Slip Analysis, 52
 Technical Training
 customer services, 239

Term Mode
 description, 22

Terminating a Call
 PBX/switch emulation, 85

Termination Test Setup
 simulation of T1, 48
 T1 BERT, 46

Test Parameters
 property sheet tabs set, 30

Test Procedure Development
 product enhancement group, 238

Test Results
 DS1 BPV, 192
 DS1 frame, 194
 DS1 signal, 188
 DS1 summary, 181
 DS3 BPV, 193
 DS3 frame, 195
 DS3 LED, 185
 DS3 parity, 197

Testing
 DDS drop and insert, 71
 DDS loopback BER, 67
 DS3 BER, 108
 FT1 drop and insert, 61
 FT1 loopback BER, 57
 OC-3 and OC-12 BER, 130
 STS-1 BER, 117
 T1 loopback BER, 49

Thru Mode
 description, 22

Time
 time test result, 220

Time Category
 description, 25

Timing Slip Analysis
 T1, 52

Timing Slips
 DS1 signal test result, 189
 simulation DS1, 56

Tones
 transmitting VF, 95

Test Systems Field Engineering and Installation
 customer services, 238

Test Setup
 basic, 36
 MON/THRU mode error/alarm insert, 129
 simulation of DDS loopback BER, 70
 simulation of FT1 loopback, 61
 simulation of T1 loopback, 52
 simulation of T1 termination, 48

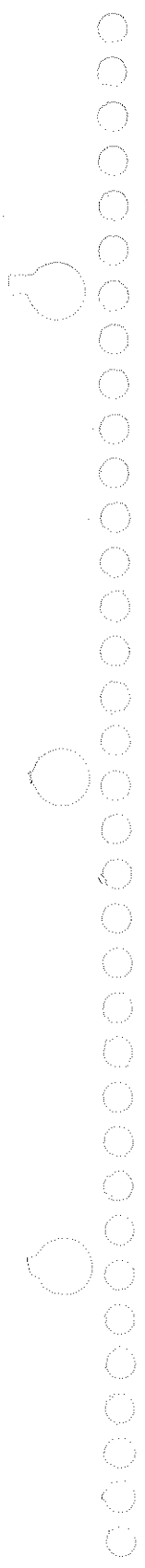

Top-Panel Features
getting started, 10

Traffic Category
description, 25

Training
technical, 239

Transmitting VF Tones, 95

TTC 2000 Test Pad and T-BERD
2310 Module, 7

TX Frequency
DS1 signal test result, 188
DS3 signal test result, 190

TX X-Bits
DS3 frame test result, 195

U

Using Quad Results, 231

V

VF Channel Drop/Monitor Setup, 91

VF Option
common applications, 91

VF Tones
transmitting, 95

Virtual Tributary (VT) Category
description, 25

VT AIS
SONET LED test result, 187

VT AIS/LOP Secs
SONET VT test result, 208

VT BIP Error Rate
SONET VT test result, 208

VT BIP Error Secs
SONET VT test result, 208

VT BIP Errors
SONET VT test result, 208

VT BIP Errors
SONET VT test result, 208

W

Warranty Information
customer services, 240

Y

Yellow Alarm
DS3 LED test result, 185