

Telecommunications
Techniques
Corporation

INTERCEPTOR® 132A

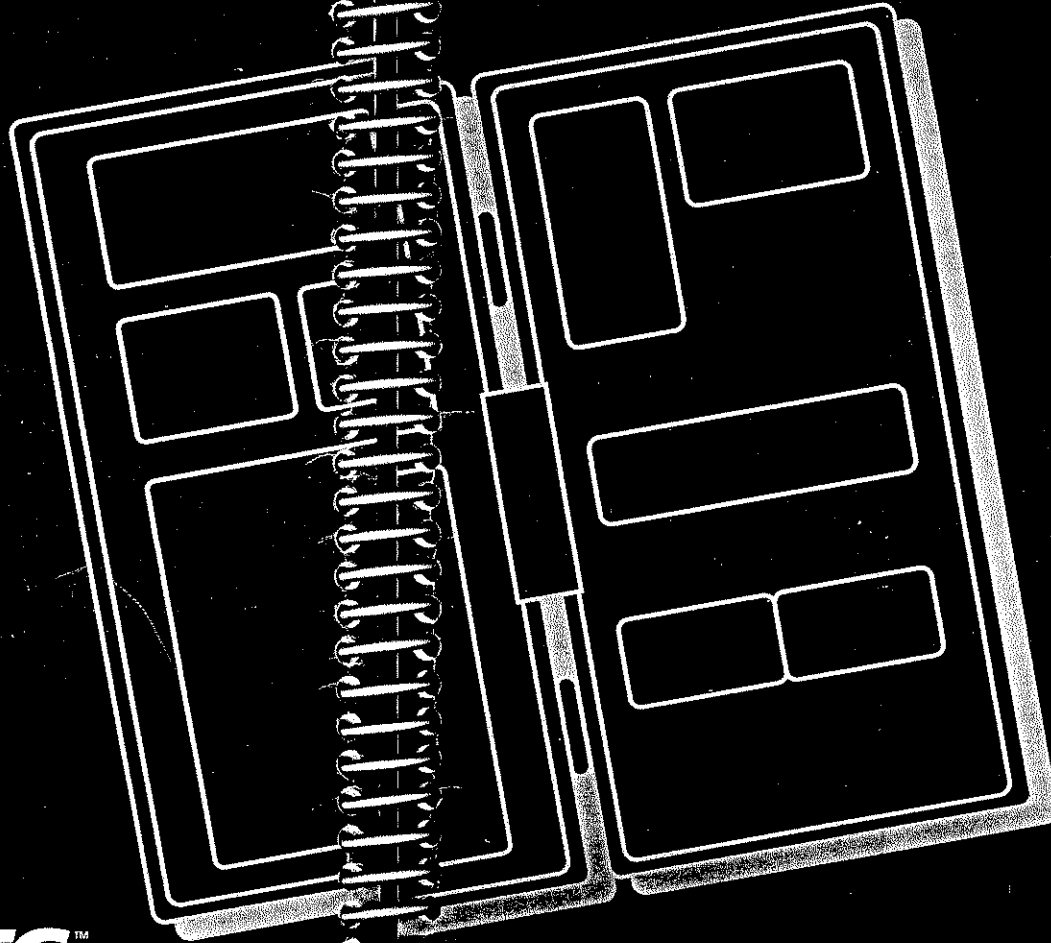

Reference Manual



Telecommunications Techniques Corporation
20400 Observation Drive, Germantown, Maryland 20876
Tel. (800) 638-2049 or (301) 353-1550 (MD)
FAX (301) 353-0731



50-13627-01
Rev. B

INTERCEPTOR 132A 2 Mbit/s Analyzer

Reference Manual

May 1995

©1994 Telecommunications Techniques Corporation®
20400 Observation Drive, Germantown, Maryland 20876
(800) 638-2049 or (301) 353-1550 (MD)
FAX (301) 353-9216
or contact your local distributor

TABLE OF CONTENTS

SECTION	PAGE
GETTING STARTED	
1.1 INTRODUCING THE INTERCEPTOR 132A	1-1
1.2 OPTIONS FOR THE INTERCEPTOR 132A	1-2
1.3 WARNINGS	1-4
1.4 UNPACKING INSTRUCTIONS	1-4
1.5 STANDARD EQUIPMENT AND ACCESSORIES	1-5
1.6 POWERING THE INTERCEPTOR 132A	1-5
1.7 INITIAL CHECK-OUT PROCEDURE	1-6
1.8 BASIC SETUP PROCEDURE	1-8
INSTRUMENT DESCRIPTION	
2.1 OVERVIEW	2-1
2.2 TRANSMITTER	2-4
2.3 EXTERNAL CLOCK	2-5
2.4 STATUS & ALARMS	2-6
2.5 RECEIVER	2-9
2.6 MISCELLANEOUS CONTROLS AND LEDS	2-13
2.7 DISPLAY, SCROLL, CURSOR, SELECT	2-14
2.8 SETUP	2-15
2.9 RESULTS	2-16
2.10 VOLUME CONTROLS AND SPEAKER	2-16
2.11 PRINTER CONTROLS	2-17
2.12 POWER	2-18
2.13 TOP PANEL OF THE TEST INSTRUMENT	2-18
SETUP CATEGORIES	
3.1 OVERVIEW	3-1
3.2 TEST MODE CATEGORY	3-2
3.3 CONFIGURATION CATEGORY	3-5
3.4 TIMESLOTS CATEGORY	3-20

SECTION	PAGE
3.5 ALARM/SIGNAL CATEGORY	3-24
3.6 AUXILIARY CATEGORY	3-29
TEST RESULTS	
4.1 OVERVIEW	4-1
4.2 SUMMARY RESULTS	4-1
4.3 LOGIC & TIME RESULTS	4-2
4.4 SIGNAL, CODE & FAS RESULTS	4-5
4.5 CHAN. & SIGNALING RESULTS	4-10
4.6 PERFORMANCE RESULTS	4-12
USING A PRINTER	
5.1 OVERVIEW	5-1
5.2 CONTROLS PRINT	5-2
5.3 RESULTS PRINT	5-3
5.4 AUTO PRINT — TIMED	5-4
5.5 AUTO PRINT — EVENT	5-5
5.6 HISTOGRAM PRINT	5-6
5.7 PRINTER SETUP	5-10
REMOTE CONTROL	
6.1 OVERVIEW	6-1
6.2 REMOTE CONTROL OPERATION	6-2
6.3 COMMANDS AND QUERIES	6-3
6.4 ERROR MESSAGES	6-44
APPLICATIONS	
7.1 OVERVIEW	7-1
7.2 IN-SERVICE MONITORING	
A 2048 KBIT/S CIRCUIT	7-1
7.3 OUT-OF-SERVICE TESTING A	
2048 KBIT/S CIRCUIT	7-3
7.4 ANALOG/DIGITAL TESTING OF	
A VOICE CHANNEL	7-6
7.5 TROUBLESHOOTING AN NX56 OR	
NX64 KBIT/S CIRCUIT	7-8
7.6 COMMISSIONING A CUSTOMER'S	
NX64K SERVICE	7-11

SECTION	PAGE
7.7 MONITORING 2048 KBIT/S	
CIRCUITS FROM DS3 ACCESS	
POINTS USING A T-BERD 305	
OR T-BERD 310 ANALYZER	7-15
7.8 PERFORMING A BIT	
SLIP/FRAME SLIP TEST	7-17
7.9 NOTES REGARDING	
ROUND-TRIP DELAY	7-19
SPECIFICATIONS	
8.1 2 MBIT/S OPERATING MODES	8-1
8.2 PRINTER / REMOTE CONTROL	
INTERFACE	8-5
8.3 GENERAL	8-6
MAINTENANCE AND SERVICE	
9.1 OVERVIEW	9-1
9.2 TROUBLESHOOTING	9-1
9.3 SERVICE	9-2
9.4 HOW TO CONTACT TTC	9-6
APPENDIX	
A. PRINTER/ REMOTE CONTROL	
INTERFACE	A-1
B. REMOTE CONTROL STATUS REGISTERS	
B.1 REGISTER OPERATION	B-1
B.2 QUEUE AND BUFFER OPERATION	B-3
B.3 STATUS BYTE REGISTER GROUP	B-3
B.4 EVENT STATUS REGISTER GROUP	B-6
B.5 TEST SUMMARY REGISTER GROUP	B-8
B.6 LINE STATUS REGISTER GROUP	B-9
B.7 ALARM STATUS REGISTER GROUP	B-11
C. UNDERSTANDING G.821	
PERFORMANCE ANALYSIS	
C.1 WHY CCITT G.821 PERFORMANCE	
ANALYSIS?	C-1
C.2 PERFORMANCE ANALYSIS	
RESULTS	C-1

Table of Contents

Table of Contents

SECTION	PAGE
C.3 DETERMINING AVAILABLE AND UNAVAILABLE SECONDS	C-2
C.4 DETERMINING DEGRADED MINUTES	C-6
D. UNDERSTANDING HISTOGRAMS	
D.1 UNDERSTANDING HISTOGRAM GRAPHS	D-1
D.2 UNDERSTANDING HISTOGRAM LISTS	D-4
FIGURES	
2-1 INTERCEPTOR 132A (LEFT SIDE)	2-2
2-2 INTERCEPTOR 132A (RIGHT SIDE)	2-3
3-1 FORMAT OF THE TIMESLOTS DISPLAY	3-21
5-1 HISTOGRAM PRINT (WHEN HIST TYPE IS GRAPH, PRINTER MODE IS GRAPH)	5-8
5-2 HISTOGRAM PRINT (WHEN HIST TYPE IS GRAPH, PRINTER MODE IS ASCII)	5-9
5-3 HISTOGRAM PRINT (WHEN HIST TYPE IS LIST)	5-10
5-4 PRINTER CONNECTION	5-12
7-1 IN-SERVICE MONITORING OF A 2.048 MBIT/S CIRCUIT	7-1
7-2 OUT-OF-SERVICE TESTING OF A 2048 KBIT/S CIRCUIT	7-4
7-3 A/D TESTING OF A VOICE CHANNEL ...	7-6
7-4 TROUBLESHOOTING AN NX56 OR NX64 KBIT/S CIRCUIT	7-9
7-5 TROUBLESHOOTING A CUSTOMER'S NX64K SERVICE	7-11
7-6 MONITORING A 2 MBIT/S CIRCUIT FROM A DS3 ACCESS POINT	7-15
7-7 PERFORMING A BIT SLIP OR FRAME SLIP TEST	7-17
B-1 INTERCEPTOR 132A REGISTERS	B-1
B-2 REGISTER OPERATION	B-2
B-3 STATUS BYTE REGISTER	B-4

FIGURES	
B-4 EVENT STATUS REGISTER GROUP	B-6
B-5 TEST SUMMARY REGISTER	B-8
B-6 LINE STATUS REGISTER GROUP	B-9
B-7 ALARM STATUS REGISTER GROUP	B-11
C-1 DIVISION OF TEST SECONDS FOR PERFORMANCE ANALYSIS	C-1
C-2 SLIDING WINDOW AFTER 29TH TEST SECOND	C-3
C-3 SLIDING WINDOW AFTER 88TH TEST SECOND	C-3
C-4 SLIDING WINDOW AFTER 89TH TEST SECOND	C-4
C-5 SLIDING WINDOW AFTER 160TH TEST SECOND	C-5
D-1 SAMPLE HISTOGRAM GRAPH	D-1
D-2 SAMPLE LIST HISTOGRAM PRINT	D-5

LIST OF TABLES	
3-1 TEST MODE CATEGORY	3-2
3-2 CONFIGURATION CATEGORY	3-6
3-3 TIMESLOTS CATEGORY	3-20
3-4 ALARM/SIGNAL CATEGORY	3-25
3-5 AUXILIARY CATEGORY	3-29

GETTING STARTED

1.1 INTRODUCING THE INTERCEPTOR 132A

The INTERCEPTOR 132A 2.048 Mbit/s Analyzer is a hand-held, battery-operated digital communications test instrument. It can perform in-service and out-of-service analysis on 2048 kbit/s circuits, 64 (or 56) kbit/s timeslots (including individual, adjacent, or non-adjacent timeslots).

The front panel of the test instrument is arranged so that the test instrument is easy to use. To learn more about the functions of controls and indicators on the front panel, see Section 2, Instrument Description. To set up to test a digital communications circuit, see Section 3, Setup Categories.

As you conduct a test, the test instrument provides a number of test results that provide information about the circuit under test. For information about the test results, see Section 4, Test Results.

In addition to performing the tests and viewing the results, you can also connect a printer to the test instrument and print information regarding the test setup and test results. The information can be printed in a number of formats, including histogram format. For information regarding printing, see Section 5, Using a Printer.

Additionally, the test instrument can be controlled through a remote controller such as a personal computer. For information regarding remote control, see Section 6, Remote Control.

The INTERCEPTOR 132A includes the following key features:

- Operates at 2 Mbit/s, Nx64, Mx64, Nx56, and Mx56 kbit/s
- Measures 2 Mbit/s signal level
- Performs digital and VF channel analysis
- Displays 2 Mbit/s timeslot activity
- Automatically detects 2 Mbit/s framing and pattern
- Performs bit slip and frame slip analysis and stress testing of network timing (Option 132A-1)
- Detects REBE (Remote End Block Error) bits in 2Mbit/s mode
- Measures round trip delay
- Provides a 16K test mode
- Transmits NTPM, LEPM, and programmable ISDN (Sa6) loop codes
- Displays and prints Sa6 messages
- Generates frequencies from 50 bit/s to 2.048 Mbit/s
- Transmits and displays Transmic 2G (C-Bit) loop codes
- Performs M.2100 in-service performance analysis
- Provides remote control commands for remote operation
- Stores and recalls setup configuration
- Stores and prints Results with/without Histograms
- Squelches printing during excessive error rate periods

INTERCEPTOR 132A Applications include:

- Commissioning (pre-service testing) new 2048 kbit/s circuits
- In-service monitoring of 2048 kbit/s circuits
- Monitoring individual voice channels in 2048 kbit/s circuits
- Testing 64 (or 56) kbit/s, Nx64, or Mx64 kbit/s paths through digital cross-connect systems (DCS)
- Commissioning new fractional 2048 kbit/s services
- Out-of-service testing of 2 Mbit/s circuits by using NTPM and LEPM (Sa6) loop codes
- Out-of-service testing of 2 Mbit/s circuits by using Transmic 2G (C-Bit) loop codes
- Testing 2 Mbit/s, Nx64, and Mx64 circuits for timing-related problems (with Option 132A-1 installed)
- Stress testing equipment.

1.2 OPTIONS FOR THE INTERCEPTOR 132A

Options for the test instrument are available to provide additional functionality. Currently, the following option is available.

Option 132A-1, Timing Analysis Option

The Timing Analysis option allows you to input an external clock source. With this option, the test instrument can provide Bit Slip and Frame Slip results. With this option, the test instrument can also transmit at a user-set variable frequency offset from -20,000 ppm to +20,000 ppm. A data synthesizer is included with this option.

1.3 WARNINGS

Here is some important information to keep in mind as you use the test instrument.

WARNING: Do not remove the test instrument's cover when power is applied.

CAUTION: Do not operate the test instrument in an ambient temperature above 45°C. Operating the test instrument in higher temperatures can cause improper operation or damage.

1.4 UNPACKING INSTRUCTIONS

Inspect the test instrument shipping container for damage. If the container is damaged, keep the container until the contents of the shipment have been checked for completeness (see Section 1.5 and the packing list included in the shipment) and the test instrument has been checked physically and operationally (see Section 1.7).

If the shipment is incomplete or damaged, or if the test instrument does not pass its operational test, keep the shipping container and packaging materials for the carrier's inspection. Notify the carrier and TTC (see Section 9.4) or your local distributor.

If you have any questions regarding your order, available accessories, or options, contact TTC Customer Service or call your local TTC Representative (see Section 9.4).

1

1.5 STANDARD EQUIPMENT AND ACCESSORIES

The following equipment should be present when the INTERCEPTOR 132A shipment is received and unpacked. Check the shipping invoice for a complete list of materials.

- AC Mains power adapter
- Printer/Remote Control cable
- INTERCEPTOR 132A Reference Manual.

1.6 POWERING THE INTERCEPTOR 132A

The test instrument is equipped with an internal, sealed, lead-acid battery. When fully charged, the battery can power the instrument for 3 to 6 hours, depending on test configuration.

The test instrument can also operate using AC Mains power. To connect to AC Mains power, use the AC Mains power adapter (which is supplied with each test instrument).

To recharge the internal battery, connect the test instrument to AC Mains power. While the test instrument is connected to AC Mains power, battery charging occurs automatically. From a complete discharge, the battery can be fully recharged in approximately 8 hours if the test instrument is not powered on.

1.7 INITIAL CHECK-OUT PROCEDURE

The check-out procedure described in this section assumes that your test instrument is still in its factory default configuration. If you have changed the test instrument's setup before performing this procedure, return the test instrument to its factory default setup by clearing memory.

If you need information about how to operate the test instrument, see Section 2, Instrument Description. Perform the following check-out procedure as soon as possible after unpacking the test instrument.

1. **Press POWER to apply power. Verify the following steps occur.**
 - a. The Liquid Crystal Display (LCD) performs its power-on test for about 2 seconds.
 - b. All light-emitting diodes (LEDs) illuminate for about one second. (The 2M TX POWER OFF LED illuminates only briefly.)
 - c. The current software revision is displayed in the LCD for a few seconds.
 - d. The back-light for the LCD switches on and remains on. (The LCD back-light switches off automatically after about 5 minutes of inactivity. The LCD back-light comes back on when you press any control.)
2. **Verify the SELF LOOP LED is on.**
3. **Press SETUP until the TEST MODE yellow LED illuminates.**
Verify the Test Mode is set to 2048K.
4. **Select the CONFIGURATION setup category.**
Verify the Transmitter is set to ON.
5. **Move the cursor to the current Framing selection (it should be AUTO).**

6. **Using the SELECT up or down control set Framing to MFAS-CRC.**
7. **Move the cursor to the current Pattern selection (it should be AUTO).**
8. **Using the SELECT up or down control set the Pattern to 2^23-1.**
9. **Press SETUP to select the AUXILIARY setup category.**
Verify the Tx Coding is set to HDB3.
10. **Verify the following LEDs are on.**
Green: SIGNAL, FAS SYNC, MFAS SYNC, and PATTERN SYNC.
Yellow: CRC-4.
11. **Press RESULTS until the SUMMARY LED illuminates.**
12. **Press RESTART.**
Verify the following message is displayed:

Results OK.
13. **Press ERROR INSERT one time.**
Verify the SUMMARY display shows:

Bit Errs:	1
CRC Errs:	1

NOTE: Each time you press ERROR INSERT, the Bit Errs and CRC Errs results should increase by 1.
14. **Hold down ERROR INSERT until the ERROR INSERT LED illuminates.**
The Bit Errs and CRC Errs results should begin to increment.

15. **Select the LOGIC & TIME Results category.**
16. **Press RESTART to clear all results.**
After two seconds, verify the following result is displayed.

BER: 1.00 E-03.

If you have any questions about this procedure, or if your test instrument does not pass this operational test, contact TTC Customer Service (see Section 9.4).

1.8 BASIC SETUP PROCEDURE

Setting up the test instrument to perform circuit analysis is facilitated by the easy-to-use front panel and display categories.

Following is a typical sequence of steps to use in setting up the test instrument to perform a test.

1. **Turn off PANEL LOCK.**
Before beginning any test instrument setup procedures, verify the PANEL LOCK LED is off. If PANEL LOCK is on, then no setup changes are allowed. To turn off PANEL LOCK, hold down PANEL LOCK (for approximately 5 seconds) until the LED turns off.
2. **Use the SETUP categories to configure the INTERCEPTOR 132A for the test.**
The SETUP categories, and the items within each category, are arranged in a logical order, so that you can proceed from top to bottom to properly set up a test. That is, start with the TEST MODE category, then proceed to the CONFIGURATION category, and so on.

In each category, only applicable items are displayed, depending on the setup you have specified in earlier categories and items. This feature makes setup simpler and faster.

3. **Turn off SELF LOOP.**
Verify the SELF LOOP LED is off. Unless you are performing a self-check of the test instrument, SELF LOOP should always be off.
4. **Turn off ERROR INSERT.**
If you do not want to generate errors, verify the ERROR INSERT LED is off.
5. **Select the 2 Mbit/s RECEIVER input mode.**
For 2 Mbit/s testing only, use the RECEIVER control to select the receiver connector and mode.

NOTE: Be sure to perform this step before connecting the RECEIVER to the equipment under test. Improper receiver input mode selection (for example, TERM instead of BRIDGE) could result in bit errors on a live circuit under test when monitoring from a point not equipped with isolation resistors.
6. **Connect the INTERCEPTOR 132A to the circuit.**
Connect the circuit under test to the test instrument's RECEIVER and TRANSMITTER as applicable.
7. **Press RESTART to begin a test.**
To restart (that is, start a new test), press RESTART. (A new test is also begun when you change certain test setup configurations, such as changing test mode.)

INSTRUMENT DESCRIPTION

2.1 OVERVIEW

The front panel of the INTERCEPTOR 132A is designed so it is easy to use. Associated items are grouped together; items are clearly labeled; and LEDs illuminate so you can see at a glance the status of the circuit under test. The test instrument includes:

- Connectors for connecting to the circuit under test and to peripheral devices
- LEDs that illuminate to provide information
- Controls that you press to initiate an action.

For a view of the front panel, see Figures 2-1 and 2-2.

The left side of the test instrument primarily includes items regarding the 2 Mbit/s transmitter. The right side of the test instrument includes items regarding the 2 Mbit/s receiver, as well as items regarding the setup of the test instrument and the display of test results.

For information about the individual sections of the test instrument, see the subsections that follow the Figures.

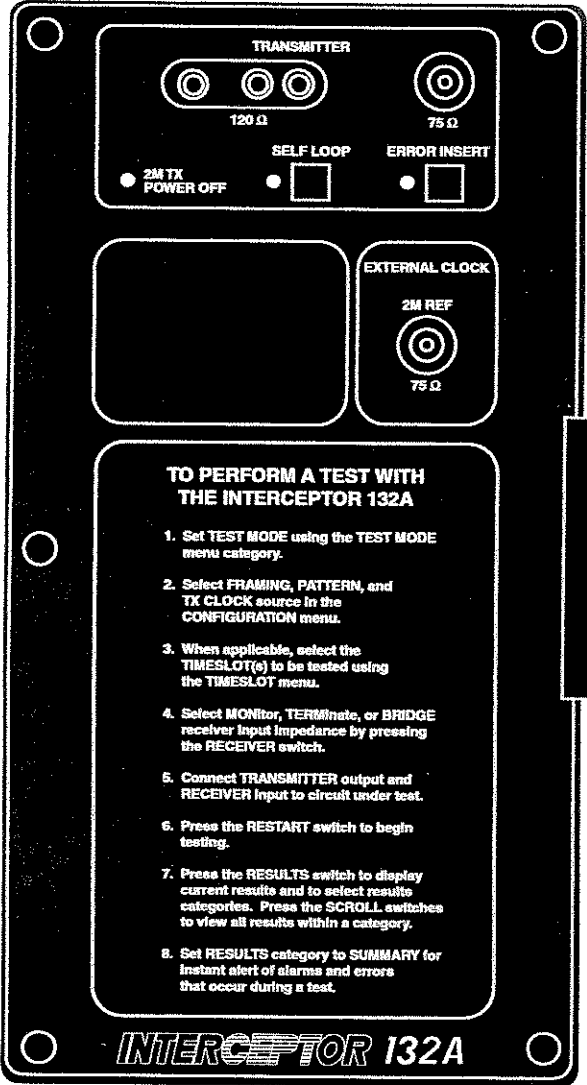

Figure 2-1 INTERCEPTOR 132A (Left Side)

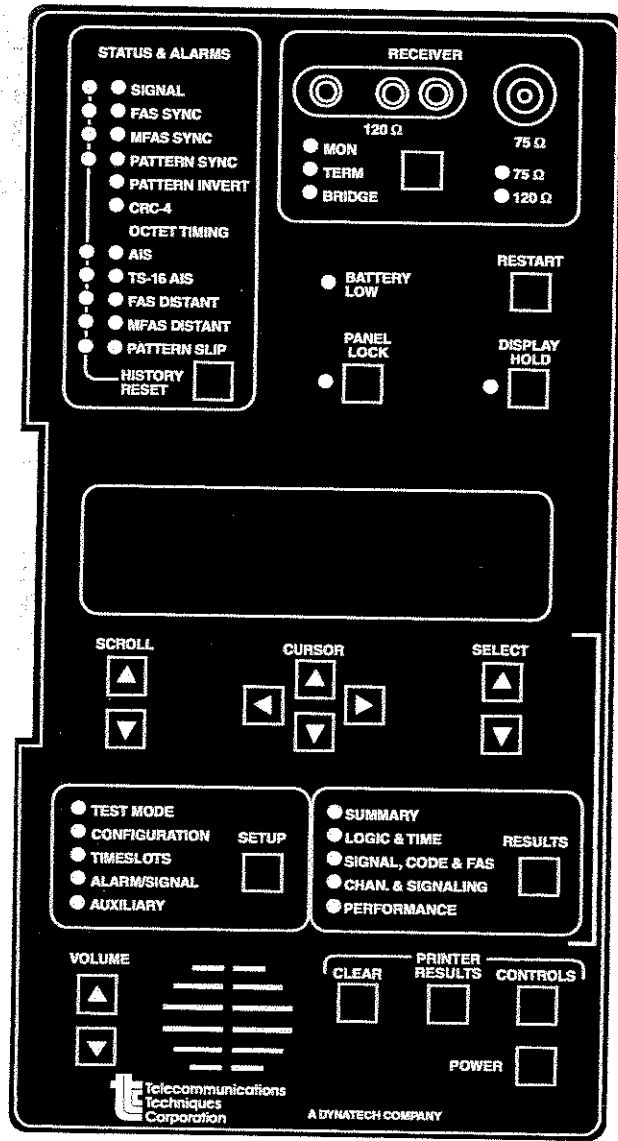
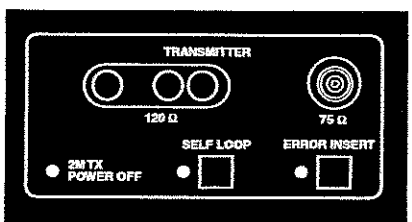

Figure 2-2 INTERCEPTOR 132A (Right Side)

2.2 TRANSMITTER

The TRANSMITTER portion of the front panel includes connectors, LEDs, and controls that are associated with the transmitter side of the test instrument.



TRANSMITTER Connectors (120Ω and 75Ω)

The TRANSMITTER connectors are used to connect the INTERCEPTOR 132A to the circuit or equipment under test so you can transmit a 2048 kbit/s signal. Use the 120 Ω 3-pin Siemens connector to connect to balanced 2 Mbit/s interfaces. Use the 75 Ω connector (BNC or 1.6/5.6 mm) to access unbalanced 2 Mbit/s interfaces.

2M TX POWER OFF

The 2M TX POWER OFF (2 Mbit/s Transmitter Power Off) LED illuminates when the 2 Mbit/s Transmitter is off. (See the Transmitter item in the CONFIGURATION Setup category.) Less power is consumed (and therefore the battery will last longer) when the Transmitter is turned off.

SELF LOOP

Press SELF LOOP to turn Self Loop on or off. When Self Loop is on, the red LED illuminates.

While Self Loop is on, the transmitter and receiver are connected internally for the 2 Mbit/s circuitry, as appropriate. Self Loop is therefore used only to perform instrument self-checks.

ERROR INSERT

ERROR INSERT is used to generate and insert errors into the transmitted signal. (For information regarding the type of error that is inserted, see the Error Type item in the AUXILIARY setup category.)

To insert a single error, press ERROR INSERT once. To insert a constant 10⁻³ error ratio in the transmitted stream, hold down ERROR INSERT until the LED illuminates. To stop inserting errors, press ERROR INSERT again so the LED extinguishes.

2.3 EXTERNAL CLOCK

The EXTERNAL CLOCK connector is a 75Ω BNC unbalanced connector (or an optional 1.6/5.6 mm connector) that is used to connect the test instrument to an external clock source. When the external clock source is selected, transmit timing is provided by the source that you connect to the test instrument. The external clock may also be used as a reference signal to compare timing to that of the signal under test for slip measurements.

NOTE: The EXTERNAL CLOCK connector is present only if Option 132A-1 is installed.

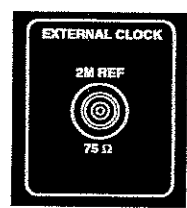

2.4 STATUS & ALARMS

The STATUS & ALARMS section provides immediate and easy-to-see information regarding the status of the received signal, as shown in the following diagram.

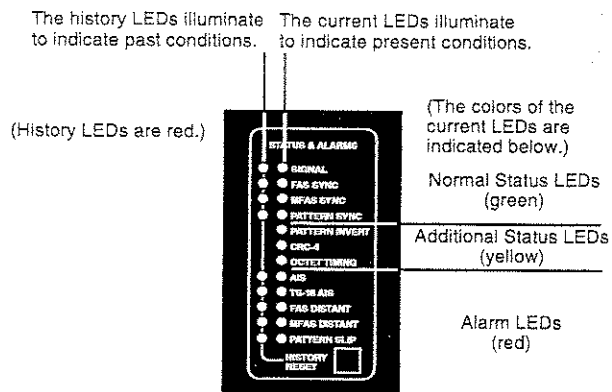

The current and history LEDs for a given item may be off or on at the same time. The meaning of the various on/off conditions for the LEDs is as follows:

History LED off, and current LED off.

The condition is not detected now and has never been detected during this test period.

History LED off, and current LED on.

The condition is detected now and has been detected continuously since it was first detected during this test period. Indicates a current condition.

History LED on, and current LED off.

The condition is not detected at the moment, but has been detected at least once during this test period. Indicates an intermittent condition or one-time event.

History LED on, and current LED on.

The condition is detected now, but has not been detected continuously since it was first detected during this test period. Indicates a recurring condition that currently exists.

The colors used for the current and history LEDs help to quickly identify conditions. Green LEDs indicate a positive condition (for example, the signal is being received and synchronization is being achieved). Yellow LEDs provide general information about the received signal. Red LEDs indicate a negative condition: either an alarm is being (or has been) received, or a positive condition has been lost.

The STATUS & ALARMS LEDs are described as follows:

SIGNAL

The green current status SIGNAL LED illuminates when the test instrument detects a valid received 2 Mbit/s signal.

The red history SIGNAL LED illuminates when, after detecting a valid received 2 Mbit/s signal, the signal is lost. The history LED remains illuminated even after the signal is again detected.

FAS SYNC

The green current status LED for FAS SYNC illuminates when the test instrument achieves Frame Alignment Signal (FAS) synchronization with the received signal. This LED remains on while testing a valid 2.048 Mbit/s signal containing a valid (G.704-compatible) Frame Alignment Signal.

MFAS SYNC

The MFAS SYNC LED illuminates when the test instrument achieves Multiframe Alignment Signal (MFAS) synchronization.

PATTERN SYNC

The PATTERN SYNC LED illuminates when the test instrument achieves pattern synchronization.

PATTERN INVERT

The PATTERN INVERT LED illuminates when the test instrument detects pattern inversion (that is, expected ones are received as zeros and expected zeros are received as ones).

CRC-4

The CRC-4 LED illuminates when the test instrument achieves synchronization with the CRC (Cyclic Redundancy Check) bit sequence.

OCTET TIMING

The OCTET TIMING LED does not apply for the INTERCEPTOR 132A.

AIS

The AIS (Alarm Indication Signal) LED illuminates when the receiver detects AIS (unframed all 1's).

TS16 AIS

The TS16 AIS (Timeslot 16 Alarm Indication Signal) LED illuminates when the receiver detects TS16 AIS (that is, Timeslot 16 in the frames of the received signal contains all 1's). A TS16 AIS implies multiframe synchronization has been lost.

FAS DISTANT

The FAS DISTANT (Frame Alignment Signal Distant alarm) LED illuminates when the 2 Mbit/s receiver detects an FAS Distant alarm. An FAS Distant alarm indicates the distant end has lost frame synchronization or has lost the signal.

MFAS DISTANT

The MFAS DISTANT (Multiframe Alignment Signal Distant alarm) LED illuminates when the 2 Mbit/s receiver detects an MFAS Distant alarm. An MFAS Distant alarm indicates the distant end has lost multiframe synchronization.

PATTERN SLIP

The PATTERN SLIP LED illuminates each time a pattern slip is detected in the received test pattern. Pattern slips generally occur when a network element, such as a digital cross-connect system (DCS) or higher-order multiplexer, experiences a controlled or uncontrolled timing slip. Pattern slip monitoring is a useful tool for detecting and troubleshooting network timing problems.

HISTORY RESET

The Status and Alarms section also includes a HISTORY RESET control. Press HISTORY RESET to extinguish the history LEDs.

2.5 RECEIVER

The RECEIVER section pertains to the testing of 2 Mbit/s signals, and includes input connectors, the RECEIVER control and LEDs.

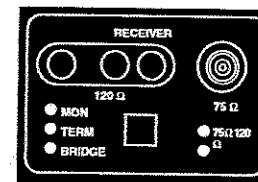

CAUTION: Select the Receiver mode and connector before you connect the test instrument to the circuit under test. Not following this order could result in damage to the test instrument.

2.5.1 Receiver Connectors

When you connect the test instrument to the 2 Mbit/s signal under test, use the appropriate connector as described below.

120Ω Connector

When you are testing a balanced circuit, use a three-pronged Siemens connector cable to connect the test instrument (using the 120Ω Receiver connector) to the circuit under test.

75Ω Connector

When you are testing an unbalanced circuit, use a 75Ω coaxial cable to connect the test instrument (using the 75Ω Receiver connector, which can be a BNC or an optional 1.6/5.6 mm connector) to the circuit under test.

2.5.2 Receiver Control and LEDs

Use the control in the RECEIVER section to select the Receiver mode and circuit impedance. Press the control until the LEDs illuminate for the appropriate mode (MON, TERM, or BRIDGE) and circuit impedance (75Ω or 120Ω).

MON (Monitor)

Use MON (Monitor) mode to monitor a 2 Mbit/s signal (such as when you are performing in-service, or non-intrusive, tests) at a resistor-isolated monitor point. Resistor-isolated monitor points may be provided at main distribution frames (MDFs), network terminating equipment (NTE), network termination units (NTUs), or at cross-connect locations. Monitor mode provides Automatic Gain Control (AGC) to compensate for loss caused by monitor points or cable losses.

Instrument Description

The following diagram illustrates a typical Monitor mode application.

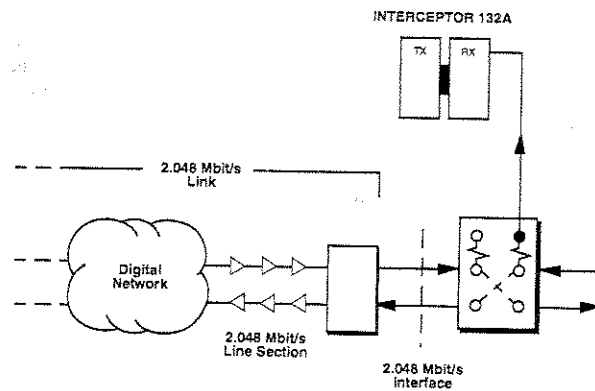

Instrument Description

TERM (Terminate)

Use TERM (Terminate) mode to terminate the circuit at the test instrument (such as when you are performing out-of-service tests on a 2.048 Mbit/s link at G.703-compatible points).

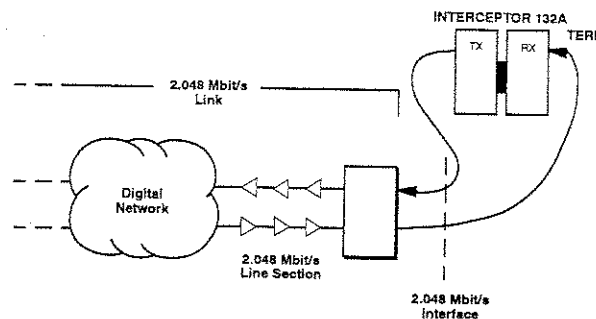

Terminate mode also provides automatic cable equalization (such as when you are testing on the network, or line, side of multiplexers, NTE, or NTUs), as illustrated below.

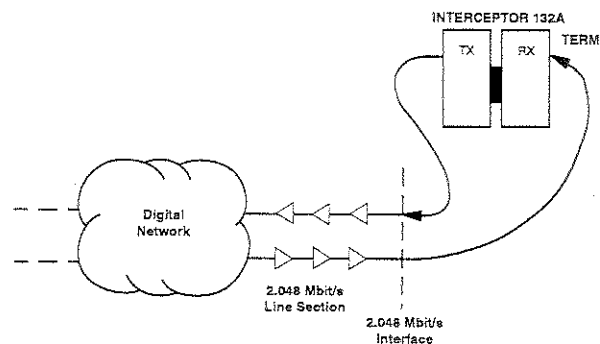

BRIDGE

Use BRIDGE mode to monitor a 2 Mbit/s signal (such as when you are performing in-service, or non-intrusive, tests) from a monitor point that is not equipped with isolation resistors (as illustrated below). With BRIDGE mode, the test instrument provides an input impedance of greater than 1000Ω and provides automatic cable equalization so the testing will not affect the circuit under test.

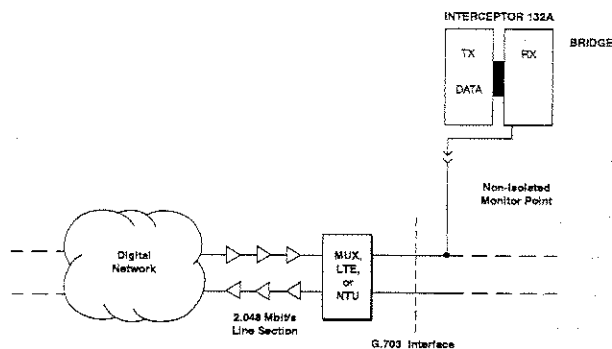

2.6 MISCELLANEOUS CONTROLS AND LEDS

Below the RECEIVER section are the BATTERY LOW LED, the PANEL LOCK control and LED, the RESTART control, and the DISPLAY HOLD control and LED.

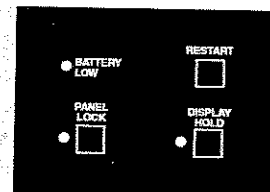

BATTERY LOW (LED)

The BATTERY LOW LED illuminates when the rechargeable battery has approximately 10 minutes of power left.

If the battery is low when you turn the power on, the following message appears.

BATTERY LOW!

If the battery power is too low, the test instrument will not power on until you connect it to an AC Mains power source or until the battery has been recharged.

PANEL LOCK (Control and LED)

Press PANEL LOCK to disable all controls on the front panel except PANEL LOCK. (Locking the panel can be useful if you are performing a long test and you do not want anyone to accidentally change any of the settings.) The LED illuminates when the panel is locked.

To unlock the panel, hold down PANEL LOCK until the LED extinguishes.

RESTART

When all setup selections have been made and the test instrument is properly connected to the circuit under test, press RESTART to start a new test. Starting a new test clears accumulated test results, clears any errors detected during the connection process, and begins a new test period.

DISPLAY HOLD (Control and LED)

At any time during a test, you can press DISPLAY HOLD to "freeze" the display to view rapidly changing results. (For information about results, see Section 4, Test Results.) This capability is useful, for example, when recording errors as a function of time. DISPLAY HOLD has no effect on result accumulation which continues normally. To "unfreeze" the display, press DISPLAY HOLD again.

2.7 DISPLAY, SCROLL, CURSOR, SELECT

The liquid crystal display (LCD) shows either the setup configuration or test results, depending on whether you most recently pressed SETUP or RESULTS. The display can show one page, or four lines, of a category list at a time.

A sample display is shown in the following diagram. The up/down arrows appear in the left margin of the display when there is more to see above or below the current items displayed.

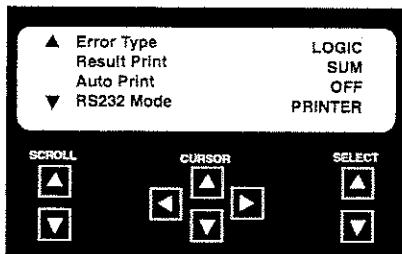

To control the display, use the following controls:

SCROLL (Up and Down)

Press the SCROLL up (or down) control to scroll up (or down) the display, a page at a time.

CURSOR (Up, Down, Left, and Right)

Press the appropriate CURSOR control to move the cursor (flashing box) up, down, left, or right within the display.

SELECT (Up and Down)

To change the selection for a given item, move the cursor to the selection and press the SELECT up (or down) control until the desired selection appears.

2.8 SETUP

Press SETUP to select one of the SETUP categories. The LED next to the selected SETUP category illuminates. Repeatedly press SETUP to scroll from one SETUP category to the next.

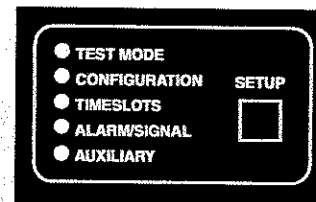

When you select one of the SETUP categories, the Display lists the items for that category. (For information about the items in the SETUP categories, see the section on Setup Categories.)

a printer is properly connected, the Print will be printed. If a printer is not connected, the Print is stored in the Print Buffer. (For more information about Results Prints, see Section 5, Using a Printer.)

PRINTER CONTROLS Control

To prepare a Controls Print, press PRINTER CONTROLS. If a printer is connected properly, the Print is printed. If a printer is not connected, the Print is stored in the Print Buffer. (For more information about Controls Prints, see Section 5, Using a Printer.)

2.12 POWER

Press POWER to turn the INTERCEPTOR 132A power on or off.

2.13 TOP PANEL OF THE TEST INSTRUMENT

The top panel of the test instrument includes the LED and two connectors that are described following the figure.

BATTERY CHARGING (LED)

The BATTERY CHARGING LED illuminates when the test instrument is connected to an AC Mains power source for recharging.

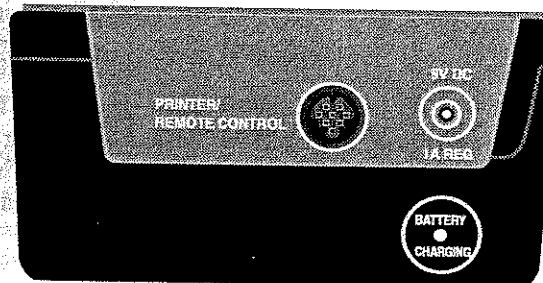

9V DC (AC Mains Power Adapter) Connector

To recharge the test instrument's battery, or to operate on AC Mains (versus battery) power, plug one end of the AC Mains Power Adapter into the 9V DC connector, and connect the other end of the adapter into an AC Mains power source. (The test instrument can remain connected to AC Mains power indefinitely; the battery cannot become "overcharged.")

WARNING: Use the TTC-supplied AC Mains Power Adapter. Use only the TTC-supplied AC Mains Power Adapter. This adapter supplies 9 VDC and uses positive outer polarity. Damage may result from the use of an incorrect adapter.

PRINTER / REMOTE CONTROL Connector

Use the PRINTER / REMOTE CONTROL adapter cable to connect the INTERCEPTOR 132A to a printer or to a remote controller. To use a printer or remote controller, connect one end of the Printer/Remote Control cable into the PRINTER / REMOTE CONTROL connector, and plug the other end into the printer or remote controller.

NOTE: Since the same PRINTER / REMOTE CONTROL connector is used for connecting to a printer or a remote controller, you cannot use both a printer and a remote controller at the same time.

For information about connecting and using a printer, see Section 5, Using a Printer. For information about connecting and using a remote controller, see Section 6, Remote Control.

SETUP CATEGORIES**3.1 OVERVIEW**

Use the INTERCEPTOR 132A SETUP categories to set up the test instrument for the test you want to perform.

There are five SETUP categories: TEST MODE, CONFIGURATION, TIMESLOTS, ALARM/SIGNAL, and AUXILIARY. The SETUP categories, and the items within each category, are arranged in a logical order so you can proceed from top to bottom to properly set up a test. (That is, start with the TEST MODE category, then proceed to the CONFIGURATION category, and so on.)

To automatically simplify setup, items in each category are displayed only if they are applicable (depending on previous setup selections). For example, if transmitter power is turned off, then any item having to do with the transmitter (such as the Tx Clock and Tx Alarm) are not displayed.

To select the category you want to view, press SETUP. Then press SCROLL or CURSOR to view the individual items in that category. Press CURSOR to move the cursor to the selection you want to change, and press SELECT to change the selection for that item.

The SETUP categories (and all possible items in each category) are described in the following subsections.

3.2 TEST MODE CATEGORY

Use the TEST MODE category to specify the type of test you want to perform. To set up the items in the TEST MODE category, press SETUP until the TEST MODE LED illuminates. Specify the selection for Test Mode first, since it will determine what other items are applicable (and, therefore, available) in the TEST MODE (and other) categories.

Below is an example setup for the TEST MODE category.

```
Test Mode      Nx64K
Channel        NORMAL
(Chan Rate    64Kbps)
```

For a summary of the TEST MODE items, see Table 3-1. Following the Table are descriptions of the TEST MODE items.

**Table 3-1
TEST MODE Category**

Item	Selections
	VOICE 64K Nx64K Mx64K
Channel	NORMAL (64Kbps) RESTRICTED (56Kbps)

3.2.1 Test Mode

When you are testing a 2 Mbit/s circuit, use the Test Mode item to specify whether you want to test the entire 2 Mbit/s circuit or just a portion of the 2 Mbit/s circuit (for example, a single timeslot or more than one contiguous or non-contiguous timeslots).

The following Test Mode selections are available.

2048K

Select 2048K for full bandwidth test of a 2 Mbit/s link.

VOICE*

Select VOICE to perform analog (level and frequency), or channel-associated, signaling tests on any PCM-encoded voice channel carried on a selected 64 (or 56) kbit/s timeslot in a 2 Mbit/s link.

When Test Mode is set to VOICE, the speaker is activated so that the traffic or a test tone on the selected timeslot can be monitored. Also, when Test Mode is set to VOICE, a PCM-encoded 1020 Hz test tone is automatically inserted into the selected timeslot of the transmitted signal.

64K*

Select 64K to perform tests on an individual 64 (or 56) kbit/s timeslot in a 2 Mbit/s circuit.

Nx64K*

Select Nx64K for tests on a circuit composed of N contiguous 64 (or 56) kbit/s timeslots in a 2 Mbit/s circuit.

Mx64K*

Select Mx64K for tests on M non-contiguous 64 (or 56) kbit/s timeslots in a 2 Mbit/s circuit.

* For all Test Mode selections (except 2048K), you must specify which timeslots of the 2 Mbit/s signal are to be tested. For more information, see items in the TIMESLOTS category.

3.2.2 Channel

Use the Channel item to configure the test instrument for normal (64 kbit/s) or restricted (56 kbit/s) timeslot operation.

Understanding Normal and Restricted Operation:

2.048 Mbit/s channels are made up of individual channels that operate at 64 kbit/s (normal operation) or 56 kbit/s (restricted operation, found mainly in circuits originating from the USA). In either case, each channel is created by sampling a signal (such as a telephone conversation) at a rate of 8,000 times per second.

In the case of normal operation, eight bits are used to represent each sample; and therefore the channel rate is 64 kbit/s (8 x 8,000 bit/s).

In the case of restricted operation, however, the last bit of every byte is set to 1. Therefore, only seven bits are available to encode each sample, and the channel rate is 56 kbit/s (7 x 8,000 bit/s).

The following Channel selections are available:

NORMAL

Select NORMAL to test a normal bandwidth (64 kbit/s) timeslot(s).

RESTRICTED

Select RESTRICTED to test a restricted bandwidth (56 kbit/s) timeslot(s).

3.3 CONFIGURATION CATEGORY

The CONFIGURATION category is used to configure key items associated with the transmitter and receiver.

To set up the items in the CONFIGURATION category, press SETUP one or more times until the LED for the CONFIGURATION setup category illuminates. For each item, select the desired setting.

Below is an example of a CONFIGURATION setup. In this example, Test Mode is set to 2048K.

```
Transmitter      OFF
Framing          MFAS
Pattern          2^15-1
```

For a summary of the CONFIGURATION items, see Table 3-2. For descriptions of the CONFIGURATION category items, see the subsections following the Table.

Table 3-2
CONFIGURATION Category

Item	Available Selections
Transmitter	ON or OFF
Thru Mode	ON or OFF
Framing	AUTO, UNFRAMED, FAS, FAS-CRC, MFAS, or MFAS-CRC
REBEs	ON or OFF
Tx Clock	INTERNAL (or INT 2048K*), RECOVERED, 2M REF*, or DPPM X YYYYYY*
DPPM	±20,000 ppm in 1 ppm steps*
2M Ref Input	MON, BRIDGE, or TERM
TS Idle	An 8-bit word that can be edited bit-by-bit. (See the text for details.)

Table 3-2
CONFIGURATION Category (Continued)

Item	Available Selections
Loopcodes	OFF, SA6BITS, or CBITS
Sa6bits	IDLE, 2M NTPM, 2M LEPM, or 2M PROG
2M PROG	Selects the Sa6 programmable loop code
CBIT	Displays the number of the C-Bit the user has selected
CBIT Status	Displays the bit name and TX status in text form
CBIT Word	Displays and allows editing of the C-Bit word in the form F0000111100000 CBIT MODE EDIT, SEND, or IDLE Transmits last selected C-Bits (IDLE or SEND) when in EDIT mode.

* These selections are available only if Option 147-1 is installed.

3.3.1 Transmitter

Use the Transmitter item to switch the 2 Mbit/s Transmitter power on or off. The following selections are available for Transmitter.

ON

2M Transmitter is powered on.

OFF

2M Transmitter is not powered (and the 2M TX POWER OFF LED illuminates). This setting is useful if the test instrument is operating on battery power. When the 2M Transmitter is set to OFF, the test instrument uses less power (and, therefore, the battery lasts longer).

3.3.2 Thru Mode

Use the Thru Mode item to turn Thru Mode on or off. Thru Mode allows you to insert a test pattern on selected timeslots without affecting traffic on the remaining timeslots. The following selections are available for Thru Mode.

ON

When Thru Mode is set to ON, the live traffic received is "passed through" without alteration on unselected transmit timeslots.

This selection is generally used for in-service testing when you want to test individual timeslots without disrupting live traffic on the remaining (unselected) timeslots.

OFF

When Thru Mode is set to OFF, an idle pattern (see "TS Idle") is transmitted on the unselected timeslots.

This selection is generally used for out-of-service testing or Fractional testing when the unselected timeslots are unused or not important.

3.3.3 Framing

Set the Framing item to the type of framing that you want the Receiver to look for, and that you want the Transmitter to use (as applicable). The framing can be set to the unframed, multiframed, and framed modes listed below.

AUTO

When Framing is set to AUTO, the test instrument attempts (at the start of each test) to set Framing to the framing format detected in the received signal. If the test instrument cannot achieve frame synchronization by setting framing to MFAS-CRC, MFAS, FAS-CRC, or FAS, then the framing defaults to UNFRAMED if Test Mode is set to 2048K, or otherwise to FAS. (To determine which type of framing was detected, check the LEDs in the STATUS & ALARM section.)

When the automatic frame synchronization process is complete, the framing remains fixed until a new test is started. That is, if Frame Sync is achieved and then lost, the test instrument does not re-initiate the automatic synchronization process. Instead, the test instrument indicates loss of Frame Sync and attempts to reacquire Frame Sync using the framing that was detected when automatic synchronization was initially achieved. This procedure ensures that the test instrument properly reports loss of sync, rather than simply revert to the default.

UNFRAMED

Configures the test instrument to operate in an unframed mode. An unframed 2 Mbit/s signal contains no frame alignment or other overhead bits. Unframed test patterns are often used to perform out-of-service tests on 2 Mbit/s lines. (The UNFRAMED selection is available only when Test Mode is set to 2048K.)

FAS

Configures the test instrument to operate using the Frame Alignment Signal (FAS), or 31-timeslot, framing format. In this format, 8-bit timeslots are organized into frames of 32 timeslots each. Timeslot 0 in each frame is reserved for overhead functions including transmission of the FAS and NFAS.

FAS-CRC

Configures the test instrument to operate using the FAS-CRC framing format. This format is identical to the FAS format, except that a 4-bit cyclic redundancy check (CRC-4) code is added. The CRC-4 code is inserted into the first bit of Timeslot 0 in odd-numbered frames.

MFAS

Configures the test instrument to operate using the Multiframe Alignment Signal (MFAS) framing format. As in the FAS format, timeslots are grouped into frames of 32 timeslots each. However, with MFAS framing, 30 of the 32 timeslots are available for customer data, and the other two timeslots are used for framing and signaling information. Timeslot 0 of every frame is used for FAS and other overhead functions. Timeslot 16 of every frame is reserved for additional overhead functions including transmission of channel associated signaling (CAS).

MFAS-CRC

Configures the test instrument to operate using the MFAS-CRC framing format. This format is identical to the MFAS format, except that a 4-bit cyclic redundancy check (CRC-4) code is included in the first bit of timeslot 0 in even-numbered frames.

3.3.4 REBEs

Remote End Block Errors allows the REBEs (E bits) detection to be enabled or disabled. When this menu item is ON (the default) the E bits are monitored and when it is OFF, the E bits are ignored. The following selections are available for REBE as indicated.

ON

When in a 2 Mbit/s mode with CRC set to ON, REBEs are counted and displayed. If a circuit without REBEs is tested with REBE set to ON, an erroneous REBE count may be displayed.

OFF

REBEs are not counted or displayed.

3.3.5 Tx Clock

Use the Tx Clock item to specify the clock source used by the transmitter. The INTERNAL (or INT 2048K) and RECOVERED selections are always available. Additional selections are available if the appropriate option is installed. The following selections are available for Tx Clock as indicated.

INTERNAL

Transmitter frequency is set equal to the standard frequency of the test instrument's internal 2.048 MHz oscillator.

INT 2048K

The INTERNAL selection (see above) appears as "INT 2048K" when Option 135A-1 is installed.

RECOVERED

The Transmitter clock is recovered from the receive signal. Thus, the transmitter frequency is equal to the frequency of the received 2 Mbit/s signal.

2M REF

The Transmitter clock is supplied by the signal that is input at the 2MREFINPUT connector. (This selection is available when Option 135A-1 is installed, and SELF LOOP is off.)

ΔPPM X YYYYY

The transmitter frequency is set from 20,000 parts per million (ppm) *above* to 20,000 ppm *below* the frequency of the test instrument's internal 2.048 MHz oscillator in 1 ppm steps. The "X" represents the sign of the frequency offset "+" or "-", and the YYYYY is a value from 00000 to 20000. (This selection is available when Option 135A-1 is installed.)

3.3.6 ΔPPM

Use the ΔPPM item to set the frequency offset from -20,000 ppm to + 20,000 ppm in 1 ppm steps. The setting is only applied when the TX Clock item is set to ΔPPM. (This item is available when Option 135A-1 is installed.)

3.3.7 2M Ref Input

Use the 2M Ref Input item to select the 2M Reference input termination. Then you can recover a clock as a reference signal when performing bit slip and frame slip measurements or when set up for external timing mode. (2M Ref Input is available only if Option 135A-1 is installed.)

MON

Monitor. Derives the 2M Reference from a resistor-isolated source. This selection provides a 75Ω input impedance for the 2M Ref Input signal.

BRIDGE

Bridge. Derives the 2M Reference from a source not equipped with resistor-isolated monitor points. This selection provides greater than 1000Ω input impedance for the 2M Ref Input signal.

TERM

Termination. Derives the 2M Reference from a source on the network where cable equalization is required. This selection provides a 75Ω input impedance for the 2M Ref Input signal.

3.3.8 TS Idle

Use the TS Idle item to specify the pattern used in unselected timeslots.

The format of the TS Idle item is:

TS Idle bbbbbbbb

where bbbbbbbb is an 8-bit byte that you can specify.

To specify each bit (represented by a "b"), move the cursor to the bit you want to change and press SELECT to change a "1" to a "0" or a "0" to a "1."

NOTE: When Channel is set to RESTRICTED, the format of TS Idle is:

TS Idle bbbbbbbX

where X is the rightmost bit, which cannot be changed. When the byte is inserted into unselected timeslots, the rightmost bit is always "1." Therefore, only the seven leftmost bits of the TS Idle byte can be specified.

3.3.9 Loopcodes

Use the Loopcodes item to specify the loop code type, if any, to be transmitted. The loop codes are applicable in the 2M framed, 2M Voice, 2M Nx64k/56k, 2M Mx64k/56k, and 2M 64k/56k setup when the 2M Transmitter is ON. The following selections are available for Loopcodes as indicated.

OFF

Loop codes are not transmitted.

SA6BITS

Selects the Sa6 loop codes for transmission in the Sa6 bit message. Refer to the Sa6bits item for information on the available loop codes.

CBITS

Selects the Transmic 2G loop codes for transmission.

3.3.10 SA6BITS

Use the SA6BITS item to specify the Sa6 loop code type to be transmitted. The Sa6 loop codes are applicable in the 2M framed, 2M Voice, 2M Nx64k/56k, 2M Mx64k/56k, and 2M 64k/56k setup when the 2M Transmitter is ON. The following selections are available for SA6BITS as indicated.

IDLE

Idle loop code (0000) is transmitted.

2M NTPM

Selects the loop code (1010) for the Network Termination Unit (NTPM).

2M LEPM

Selects the loop code (1111) for the Circuit Termination Unit (LEPM).

2M PROG

Selects the four-bit programmable loop code. Since these circuits do not have synchronization, there are only six unique loop code combinations (0000, 0001, 0011, 1010, 1110, and 1111).

3.3.11 CBIT

Use the CBIT item to display the number of the C-Bit that has been selected.

3.3.12 CBIT Status

Use the CBIT Status item to display C-Bit name and transmission status in text form, as follows:

Bit	Function	Description
1	C-Bit Frame Sync Locking	Alternating 1, 0, 1, ... [Fif]
2	Escapement	Active 0 [ON/OFF]
3	2M Access Loop Address	Network access 1, Customer access 0 [Net/Cust]
4	Origin Loop 2 & 3 Commands	Network origin 1, Customer origin 0 [Net/Cust]
5a	Loop 2 Command	Bit 5 = 0 + Bit 4 = 1 Network origin
5b	Loop 2 Command	Bit 5 = 0 + Bit 4 = 0 Customer origin
6a	Loop 2 Command	Bit 6 = 0 + Bit 4 = 1 Network origin
6b	Loop 2 Command	Bit 6 = 0 + Bit 4 = 0 Customer origin
7a	Loop 2 Command	Bit 7 = 0 + Bit 3 = 1 Network
7b	Loop 2 Command	Bit 7 = 0 + Bit 3 = 0 Customer
8	Ack Reception Looping Command	Active 0 [ON/OFF]
9	Alarm	Normal is 1 [Norm/Fault]
10	Local Fault	Active 0 [ON/OFF]
11	Distant Fault	Active 0 [ON/OFF]
12	Loss of Lock on Frame C	Active 0 [ON/OFF]
13	xxx	Active 0 [AvllNorm]
14	Reserved	Set to 1
15	Reserved	Set to 1

3.3.13 CBIT Word

Use the CBIT Word item to view and specify the C-Bit word. The format of the CBIT Word item is:

CBIT Word Fbbbbbbbbbbbbbb

where F is the framing bit and bbbbbbbbbbbbbbb represents the remaining 14 bits that you can specify. If F is 0, the C-Bit Word is an unframed all zeros signal (IDLE). If F is 1, the C-Bit Word is an unframed all ones signal (AIS). If F is F, the C-Bit Word is framed.

To specify each bit, move the cursor to the bit you want to change and press SELECT to change a "1" to a "0" or a "0" to a "1."

3.3.14 CBIT MODE

Use the CBIT MODE item to select the C-Bit transmit mode. The following selections are available for CBIT MODE as indicated.

EDIT

Lets you edit the C-Bits without changing the transmitted signal. While in EDIT mode, the last selected C-Bit mode, SEND or IDLE is transmitted.

SEND

Transmits the current C-Bits. No editing is permitted in SEND.

IDLE

Transmits the idle (All zeros) signal on the C-Bits.

3.3.15 Pattern

Set the Pattern item to the test pattern that you want to receive and transmit. (The Pattern item is not available if Test Mode is set to VOICE or if Intf is set to V.24 ASYNC.)

NOTE: The Receiver can synchronize to an incoming pattern even if it is inverted. The STATUS & ALARMS LEDs illuminate to indicate pattern sync and pattern inversion.

Available test patterns include the fixed patterns, pseudorandom (2^n-1) patterns, and programmable patterns described below.

AUTO

When Pattern is set to AUTO, the test instrument attempts (at the start of each new test) to detect what pattern is being received and to synchronize to it. However, if pattern synchronization cannot be achieved by trying to detect any of the test patterns described below, then the pattern defaults to $2^{15}-1$.

When the pattern auto-synchronization process is complete, the pattern remains fixed until a new test is started. That is, if pattern sync is achieved and then lost, the test instrument does not re-initiate the auto-sync process. Instead, the test instrument indicates loss of pattern sync and attempts to reacquire pattern sync using the pattern that was detected when auto-sync was initially achieved. This procedure ensures that the test instrument properly reports loss of sync, rather than simply revert to the default.

MARK

All ones pattern (1111, etc.).

SPACE

All zeros pattern (0000, etc.).

1:1

Alternating ones and zeros (10101010, etc.).

1:3

One followed by three zeros (10001000, etc.).

1:4

One followed by four zeros (1000010000, etc.).

 2^6-1

63-bit pseudorandom pattern with a maximum of 5 sequential zeros and 6 sequential ones (as described in CCITT Recommendation Q5 and Q6).

 2^9-1

511-bit pseudorandom pattern with a maximum of 8 sequential zeros and 9 sequential ones (as described in CCITT Recommendation V.52).

 $2^{11}-1$

2,047-bit pseudorandom pattern with a maximum of 10 sequential zeros and 11 sequential ones (as described in CCITT Recommendation O.152).

 $2^{15}-1$

32,767-bit pseudorandom pattern with a maximum of 14 sequential zeros and 15 sequential ones (as described in CCITT Recommendation O.151).

 $2^{20}-1$

1,048,575-bit pseudorandom pattern with a maximum of 19 sequential zeros and 20 sequential ones (as described in CCITT Recommendation V.57).

 $2^{23}-1$

8,388,607-bit pseudorandom pattern with a maximum of 22 sequential zeros and 23 sequential ones (as described in CCITT Recommendation O.151).

QRSS

Quasi-Random Signal Source. $2^{20}-1$ pattern modified to transmit a maximum of 14 consecutive zeros.

TS BYTE

Timeslot Byte. User-programmable 8-bit byte inserted (byte-aligned) into every selected timeslot. To program this byte, use the TS Byte item. (When Test is set to DATA, the TS BYTE pattern is not available.)

PRGM

User-programmable pattern (1 to 24 bits). To program this pattern, use the Program Pattern item. (PRGM is available if Test is set to 2M or DATA.)

DELAY

Delay is the pattern that is transmitted when round trip delay is being calculated. (The DELAY pattern is not valid when Test is set to MUX or the Transmitter is OFF.)

FOX

FOX is the standard teleprinter test pattern: THE QUICK BROWN FOX JUMPS OVER THE LAZY DOG 1234567890, followed by the nonprintable characters: carriage return and linefeed.

(The FOX pattern is available only if Intf is set to V.24 ASYNC. FOX never actually appears as a selection, but it is automatically used when Intf is set to V.24 ASYNC.)

3.3.16 TS Byte

Use the TS Byte item to specify the pattern to be transmitted in all selected timeslots when Pattern is set to TS BYTE. (For information about selecting timeslots, see the TIMESLOTS category.)

The format of the TS Byte item is:

TS Byte bbbbbbbb

where bbbbbbbb is an 8-bit byte that you can specify. To specify each bit (represented by a "b"), move the cursor to the bit you want to change and press SELECT to change a "1" to a "0" or a "0" to a "1."

NOTE: When Channel is set to RESTRICTED, the format of the TS Byte item appears as:

TS Byte bbbbbbbX

When Channel is set to RESTRICTED, the rightmost bit appears as an X and is always set to 1 and cannot be changed. Therefore, you can specify only the 7 leftmost bits of the TS Byte.

3.3.17 Program Pattern

Use the Program Pattern item to specify the 1- to 24-bit programmable test pattern to be transmitted in all selected timeslots when Pattern is set to PRGM. (For information about selecting timeslots, see the TIMESLOTS category.)

The format of the Program Pattern item appears as:

Program Pattern
Bit Length NN
bbbbbbbbbbbb
bbbbbb

where NN is the length of the pattern (that is, the number of bits in the programmable pattern), and bbb...bbb represents the bits of the pattern to be used. (The number of bits displayed depends on the setting of NN.)

To change the length of the pattern, move the cursor to the NN position, and press the SELECT up or down control until the display shows the desired number of bits. As you change the value in NN, the number of bits in the last two lines of the display changes to reflect the number of bits you specify.

To change the bit values in the pattern, move the cursor to the bit you want to change, and press SELECT to change a "1" to a "0" or a "0" to a "1."

3.4 TIMESLOTS CATEGORY

Use the TIMESLOTS category to select the timeslot (or timeslots) you want to test or analyze. The TIMESLOTS category is used only when you need to select individual timeslots in a 2 Mbit/s signal. Therefore, the TIMESLOTS category is not available when Test Mode is set to 2048K.

For an overview of the items available in the TIMESLOTS category, see Table 3-3.

Table 3-3
TIMESLOTS Category

Item	Available Selections
TS	Graphical depiction of the timeslots for the transmit and receive sides. (See the text for an explanation.)
RxTS	Graphical depiction of the timeslots for the receive side. (See the text for an explanation.)
TxTS	Graphical depiction of the timeslots for the transmit side. (See the text for an explanation.)
Coupling	Tx=Rx Tx≠Rx

The TIMESLOTS category provides a one-, two-, or three-page display and includes graphical depictions of the timeslots in a 2 Mbit/s signal so that you can indicate which timeslots are selected and which timeslots are not selected. For an overview of the display for the TIMESLOTS category, see Figure 3-1.

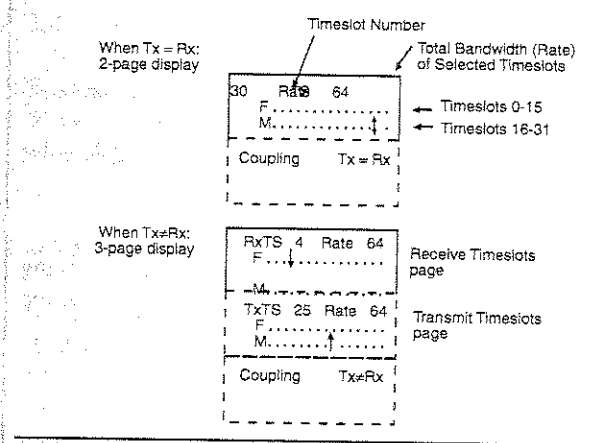

The 32 timeslots are numbered 0 through 31. Each timeslot is represented by one of the following symbols as appropriate.

- F FAS Word is in Timeslot 0
- M MFAS Word is in Timeslot 16
- Non-selected Timeslot
- ↑ Selected Timeslot (on transmit and receive sides)
- ↓ Selected Timeslot (on receive side)
- ↑ Selected Timeslot (on transmit side)

Figure 3-1
Format of the TIMESLOTS Display

Selecting Timeslots

The information in this box applies whether you are selecting timeslots using the TS, TxTS, or RxTS pages.

Selecting a Single Timeslot

To select a single timeslot for testing (that is, when Test Mode is set to VOICE or 64K), use the procedure described below.

Move the cursor to the Timeslot Number.
Press SELECT until the number of the desired timeslot is displayed.
(As you change the selection, the graphical display changes to reflect your selections.)

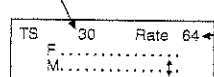

The displayed Rate automatically reflects the selection you made for Channel or 2M (as applicable).

Selecting Adjacent Timeslots

To select multiple, but adjacent, timeslots for testing (that is, when Test Mode is set to Nx64K), use the procedure described below.

Move the cursor to the Timeslot Number.
Press SELECT until the number of the starting timeslot is displayed.
(As you change the selection, the graphical display changes to reflect your selections.)

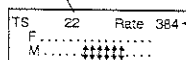

Move the cursor to the Rate indicator.
Press SELECT until the desired rate is displayed.
(As you change the Rate, the graphical display changes to select the appropriate number of adjacent timeslots for that rate.)

Selecting Non-adjacent Timeslots

To select multiple non-adjacent timeslots for testing (that is, when Test Mode is set to Mx64K), use the procedure described below.

The Timeslot Number indicates the cursor's location in the graphical display.

This number indicates the total Rate. The total Rate = (the number of selected timeslots in the graphical display) x (the rate for a single timeslot, as selected in the Channel item.)

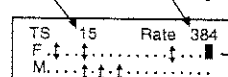

Move the cursor to each of the timeslots in the graphical display (as appropriate) and press SELECT to select (or un-select) the timeslot as desired.

3.4.1 TS (Timeslots Page)

When you want to select the same timeslot(s) on the transmit and receive sides, use the TS (Timeslot) page to select the timeslot(s) you want to test. (The TS page is available only when Coupling is set to Tx=Rx.)

3.4.2 RxTS (Receive Timeslots Page)

To select the timeslot(s) on the receive side, use the RxTS (Receive Timeslot) page. (The RxTS page is available when Coupling is set to Tx≠Rx.)

3.4.3 TxTS (Transmit Timeslots Page)

To select the timeslot(s) on the transmit side, use the TxTS (Transmit Timeslot) page. (The TxTS page is available when Coupling is Tx≠Rx.)

A Special Case: Broadcast Mode

When Test Mode is set to VOICE or 64K and Coupling is Tx≠Rx, normally you would set up the test instrument to transmit on one timeslot and receive on one timeslot. But you can use the special "Broadcast mode" to transmit on all timeslots, while still receiving on only one timeslot. (The signal on the transmit timeslots is a 1020 Hz test tone if Test Mode is set to VOICE, and is the Pattern selection if Test Mode is set to 64K.)

To select all transmit timeslots:

- Scroll to the TxTS page.
- Press SELECT until ALL appears.

To discontinue selecting all transmit timeslots:

- Scroll to the TxTS page.
- Press the SELECT up or down control.

3.4.4 Coupling

Use the Coupling item to indicate whether or not you want to select the same timeslots on the transmit and receive sides. The Coupling selection can be changed at any time.

The following selections are available for Coupling.

Tx=Rx

Select Tx=Rx if you want to select the same timeslots on the transmit and receive sides.

Tx≠Rx

Select Tx≠Rx if you want to select different timeslots on the transmit and receive sides.

NOTE: When Coupling is set to Tx≠Rx and the rates for the RxTS and TxTS pages do not match, then the following warning message is momentarily displayed.

```
WARNING
RX TIMESLOT RATE
DOES NOT MATCH
TX TIMESLOT RATE
```

To correct this discrepancy, simply select the same number of timeslots on the RxTS and TxTS pages.

3.5 ALARM/SIGNAL CATEGORY

The ALARM/SIGNAL category is used to transmit alarms on or off, and to configure overhead bits. The ALARM/SIGNAL category is available when transmitting a 2 Mbit/s signal. For an overview of the ALARM/SIGNAL category, see Table 3-4.

Table 3-4
ALARM/SIGNAL Category

Item	Available Selections
Tx Alarm	AIS (ON/OFF) FAS (ON/OFF) MFAS (ON/OFF)
Tx NFAS	An 8-bit byte in which certain bits can be edited.
Tx MFAS	An 8-bit byte in which certain bits can be edited.
Tx ABCD	A 4-bit word that can be edited bit-by-bit.
Tx Idle ABCD	A 4-bit word that can be edited bit-by-bit.

A sample ALARM/SIGNAL setup is shown below.

```
Tx Alarm      FAS OFF
Tx NFAS      C1A11111
Tx MFAS      00001A11
Tx ABCD      1101
Tx Idle ABCD 1010
```

3.5.1 Tx Alarm

Use the Tx Alarm item to specify which alarm (or alarms) you want the test instrument to transmit.

The format of the Tx Alarm item is shown below.

```
Tx Alarm      AIS      ON
```

The following alarms can be set: AIS, FAS, or MFAS. Each alarm can be set ON or OFF.

AIS (ON/OFF)

AIS (Alarm Indication Signal). When Tx Alarm is set to AIS ON, the transmitter transmits unframed all 1's. (This selection is not available when Framing is set to UNFRAMED.)

FAS (ON/OFF)

FAS (Framing Alignment Signal). When Tx Alarm is set to FAS ON, the transmitter transmits a FAS Distant alarm (that is, bit 3 of the NFAS word is set to 1).

MFAS (ON/OFF)

MFAS (Multiframe Alignment Signal). When Tx Alarm is set to MFAS ON, the transmitter transmits an MFAS Distant alarm (that is, bit 6 of the MFAS word is set to 1).

3.5.2 Tx NFAS

Use the Tx NFAS (Transmit "not FAS") item to specify the NFAS byte, which is transmitted in Timeslot 0 in odd-numbered frames of a framed 2 Mbit/s signal. As shown in the following diagram, you can specify the values for the last five bit positions (4 through 8) of the NFAS byte.

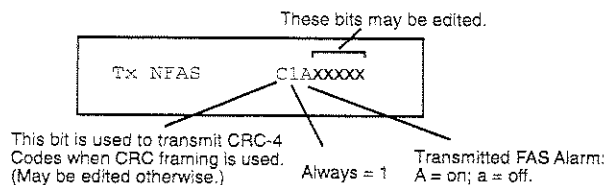

Bit position 1 can also be edited if Framing is set to FAS or MFAS. However, when Framing is set to FAS-CRC or MFAS-CRC, an uppercase "C" is displayed in bit position 1 and cannot be edited. The "C" indicates that this bit is used to send CRC-4 error detection codes.

Bit 2 is always set to 1. In bit position 3, an uppercase "A" is displayed when the test instrument is generating an FAS Distant alarm (Tx Alarm = FAS ON), or a lowercase "a" when it is not (Tx Alarm = FAS OFF).

In bit position 6, an uppercase "L" is displayed when the test instrument is generating Sa6 loopcodes.

3.5.3 Tx MFAS

Use the Tx MFAS (Transmit MFAS) item to specify the MFAS byte, which is transmitted in Timeslot 16 of the first frame of every multiframe in all MFAS and MFAS-CRC formatted 2 Mbit/s signals. As shown in the following diagram, you can specify the values for bits 5, 7, and 8 of the MFAS byte.

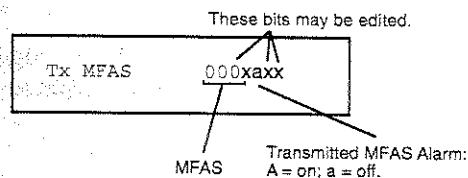

Bits 1 through 4 of the MFAS byte always contain the multiframe alignment signal 0000. In bit position 6, an uppercase "A" is displayed if the test instrument is generating an MFAS Distant alarm (Tx Alarm = MFAS ON), or a lowercase "a" when it is not (Tx Alarm = MFAS OFF).

3.5.4 Tx ABCD

Use the Tx ABCD item to set the four signaling bits associated with the selected voice channel.

The format of the Tx ABCD item is:

Tx ABCD XXXX

where XXXX represents the four signaling bits. To set the signaling bits, move the cursor to the bit you want to change, and press SELECT.

CAUTION: Unless you have a specific reason to do so, do not set Tx ABCD to 0000. Setting Tx ABCD to all zeros can cause a false multiframe alignment to occur in receiving equipment.

Bit C becomes an uppercase "L" when the test instrument is generating C-Bit loopcodes.

3.5.5 Tx Idle ABCD

The Tx Idle ABCD item is used to set the four signaling bits that are inserted into the transmitted signal for each idle channel.

The format of the Tx ABCD item is:

Tx Idle ABCD XXXX

where XXXX represents the four signaling bits. To set the signaling bits, move the cursor to the bit you want to change, and press SELECT.

CAUTION: Unless you have a specific reason to do so, do not set Tx Idle ABCD to 0000. Setting Tx Idle ABCD to all zeros can cause a false multiframe alignment to occur in receiving equipment.

3.6 AUXILIARY CATEGORY

The AUXILIARY category is used to set up a variety of items, including items regarding printing capabilities and the current time and date. For an overview of the category, see Table 3-5. Descriptions of the individual items follow the table.

Table 3-5
AUXILIARY Category

Item	Selections
Language	ENGLISH or <Local Language>
Tx Coding	AMI or HDB3
Error Type	LOGIC, CODE, or FAS
Error Rate	10-3 or 5x10-3
Adjacent FAS Errs	3, 2, or 1
Site ID	8-character alphanumeric site identification
Result Print	STD, SUM, or SIGNAL
Auto Print	OFF, TIMED, or EVENT
Time Interval	(HH:MM)
Event	SIGNAL (ON/OFF) FRAME (ON/OFF) LOGIC (ON/OFF) ALARMS (ON/OFF)
RS232 Mode	PRINTER or REMOTE
Prt Type	PR40A or OTHER (Printer Type)
Printer Mode	ASCII or GRAPH
Printer Term	CRLF, LF, or CR
RS232 Port	9600, 4800, 2400, 1200, or 300 N, E, or O 7 or 8

Table 3-5
AUXILIARY Category (continued)

Item	Selections
Printer Mode	ASCII or GRAPH
Printer Term	CRLF, LF, or CR
Hist Buf x%	ON or OFF
Hist Rslt	AIS, BIT ERRS, CODE ERRS, CRC4 ERRS, ERR SEC, FAS DIST, FAS ERRS, FAS LOSS, MFAS DIST, MFAS ERRS, MFAS LOSS, PATT LOSS, PATT SLIP, SES, SIG LOSS, TS16 AIS, UNAVL SEC, or ALL
Hist Print?	(See description.)
Start	DD/HH:MM (00/00:00 to 99/23:59)
Len	AUTO MANUAL DD/HH:MM
Hist Type	GRAPH or LIST
Hist Buf Clear?	(See description.)
Program X	STORE ?
Program X	RECALL ?
Performance	G.821 or M.2100
Beeper	ON or OFF
FAS Results	BIT or WORD
Time	HH:MM
Date	DD/MMM/YYYY
Memory Clear?	(See description.)

3.6.1 Language

Use the Language item to select the language for the menus, overlays, and printouts. The following selections are available for LANGUAGE.

ENGLISH

Select ENGLISH to display menus in English.

<Local Language>

Select the appropriate available local language to display menus in the local language (for example, Francais).

3.6.2 Tx Coding

Set Tx Coding to specify the (line) coding to be used by the transmitter.

Available when Transmitter is ON or when you are conducting a MUX test (that is, transmitting a 2 Mbit/s signal).

NOTE: The Tx Coding setup has no effect on receiver operation. Instead, the receiver is always set up to decode HDB3 "zero substitution" words when they are detected. Thus the receiver is always compatible with either the AMI code (which does not contain zero substitution words), or the HDB3 code (which does contain zero substitution words).

The following selections are available for Tx Coding.

HDB3

HDB3 (High Density Bipolar 3) is a modified bipolar code. With HDB3, whenever more than three consecutive zeroes occur in the data, a substitution word replaces the zeros (to ensure a high pulse density). Therefore, 2 Mbit/s links using the HDB3 code can carry data patterns with a low 1's density.

AMI

AMI (Alternate Mark Inversion) is a bipolar code with no zero substitution.

3.6.3 Error Type

Use the Error Type item to specify the type of errors to be transmitted when ERROR INSERT is pressed. The following selections are available for Error Type.

LOGIC

Inserts logic (or bit) errors into the data portion of the transmitted signal prior to encoding. (A bit error occurs when a "1" is mistakenly transmitted as a "0," or vice versa.) The receiving test equipment should detect bit errors. When FAS-CRC or MFAS-CRC framing is used, the receiving test equipment should also detect CRC errors.

CODE

Inserts code errors (bipolar violations) into the data or overhead portion of the transmitted signal. To ensure that no bit errors are caused, code errors are inserted such that they do not fall within HDB3 zero substitution words.

FAS

Inserts logic errors into the FAS (word error). See also the Adjacent FAS Errs item.

3.6.4 Error Rate

Use the Error Rate item to select the injected error rate (1E-3 or 5E-3) that you want the transmitter to transmit when you press and hold ERROR INSERT. This item is available when the Error Type item is set to LOGIC or CODE.

3.6.5 Adjacent FAS Errs

Use the Adjacent FAS Errs item to specify the number of adjacent FAS errors (3, 2, or 1) that you want the transmitter to transmit when you press ERROR INSERT. This feature can be used to test the "loss of framing synchronization" criterion used by 2 Mbit/s receivers.

3.6.6 Site ID

Use alphanumeric characters to create a unique 8-character identification of the test site.

3.6.7 Result Print

Use the Result Print item to specify the type of Results Print you want. (A Results Print is created whenever you press RESULTS, or when Auto Print is set to TIMED.) The following selections are available.

STD

Select STD for standard Results Prints which contain all of the results accumulated by the test set. For a sample Print, see Section 5, Using a Printer.

SUM

Select SUM for summary Results Prints which contain the following key results:

Bit Errors	MFAS Rate	%EFS
BER	CRC Rate	%SES
Test Sec	MFAS Rate	%DEG MIN
Freq ppm	CRC Rate	AVAIL SEC
Code Rate	MFAS Rate	ERR SEC
FAS Rate	Selected Timeslots	

Use this selection to save printing time and paper. For a sample Print, see Section 5, Using a Printer.

SIGNAL

Select SIGNAL for Signaling Summary prints which contain a record of up to 250 of the most recent signaling bit changes detected since the beginning of the current test. (The signaling bits are contained in Timeslot 16 of a 2 Mbit/s signal.) For a sample Print, see Section 5, Using a Printer.

3.6.8 Auto Print

Use the Auto Print (Automatic Print) item to enable or disable automatic Prints. The selections listed below are available.

OFF

Disables all automatic Prints.

TIMED

Enables Timed Results Prints. The type of Results Print depends on the selection in the Result Print item. The time interval between Prints depends on the selection in the Time Interval item.

NOTE: When a Timed Results Print prints out, the Print is labeled "TIMED" (instead of "RESULTS").

EVENT

Enables Event Prints. Then an Event Print is generated whenever one or more of the event types (selected in the Event item) occur.

3.6.9 Time Interval

Use the Time Interval item to set the amount of time between automatic timed Prints. To change the time interval, move the cursor to the time displayed, and press SELECT until the desired time interval is displayed. The time interval is displayed in an HH:MM (hours:minutes) format.

NOTE: Setting Time Interval to 00:00 disables Timed Prints.

3.6.10 Event

Use the Event item to specify which event types will cause an Event Print to be created.

The format of the Event item is:

Event	SIGNAL	ON
-------	--------	----

More than one selection can be set to ON at the same time. Setting all of the selections to OFF, in effect, disables Event Prints. The following event types can be selected.

SIGNAL (ON/OFF)

When Event is set to SIGNAL ON, any of the following signal events will trigger an Event Print: Signal Loss, Signal Present, Clock Loss, Clock Present, HDB3 Lost, HDB3 Present, Code Errors, Frequency Drift (that is, Δp_{ppm} worse than ± 50).

FRAME (ON/OFF)

When Event is set to FRAME ON, any of the following frame events will trigger an Event Print: FAS Sync Loss, FAS Sync Present, MFAS Sync Loss, MFAS Sync Present, CRC Multiframe Sync, CRC Multiframe Sync Lost, FAS Errors, CRC Errors, MFAS Errors.

LOGIC (ON/OFF)

When Event is set to LOGIC ON, any of the following logic events will trigger an Event Print: Pattern Sync, Pattern Sync Loss, Pattern Slip, Bit Errors.

ALARMS (ON/OFF)

When Event is set to ALARMS ON, any of the following alarm events will trigger an Event Print: AIS, AIS Cleared, TS-16 AIS, TS-16 AIS Cleared, FAS Distant Alarm Detected, FAS Distant Alarm Cleared, MFAS Distant Alarm Detected, MFAS Distant Alarm Cleared.

3.6.11 RS232 Mode

Use the RS232 Mode item to specify whether the PRINTER / REMOTE CONTROL connector will be used to connect a printer or a remote controller to the test instrument. The following selections are available for RS232 Mode.

PRINTER

Select PRINTER if you will be connecting a printer to the INTERCEPTOR 132A.

REMOTE

Select REMOTE if you will be connecting a remote controller to the INTERCEPTOR 132A.

3.6.12 PRT Type

Use the PRT Type item to specify the type of printer that is connected to the INTERCEPTOR 132A. The following selections are available:

PR40A

Select PR40A if you are using TTC's PR-40A Thermal Printer.

OTHER

Select OTHER if you are not using TTC's PR-40A.

3.6.13 Printer Mode

Use the Printer Mode item to specify the operating mode of the printer. The following selections are available for the Printer Mode item.

ASCII

Selects the ASCII mode for printer operation. In ASCII mode, the bars in a graph are represented by columns of asterisks. This selection is useful for sending Histogram Prints to a device (such as a remote controller) that cannot produce bars, but can produce ASCII text characters (such as asterisks).

GRAPH

Selects the graphic mode for printer operation.

NOTE: When Printer Mode is set to GRAPH, be sure to set the number of data bits per byte to 8 (in the RS232 Port item).

3.6.14 Printer Term

Use the Printer Term item to specify the line termination. The following selections are available for Printer Term.

CRLF

Set the printer line termination to carriage return and linefeed.

LF

Set the printer line termination to linefeed.

CR

Set the printer line termination to carriage return.

3.6.15 RS232 Port

Use the RS232 Port item to configure the RS232 Port (that is, the PRINTER / REMOTE CONTROL connector) for the appropriate baud rate, parity, and number of data bits per byte. (The RS232 Port item is not available when Printer Type is set to PR40A, since the RS232 port is then automatically configured properly.)

The format for the RS232 Port items is:

```
RS232 Port  BaudRate  Parity  Bits
```

To change a selection, move the cursor to the selection you want to change, and press SELECT until the desired selection is displayed.

The Baud Rate selections are 9600, 4800, 2400, 1200, and 300.

The Parity selections are N (none), E (even), or O (odd) parity.

The Data Bits per Byte selections are 7 or 8.

NOTE: Set the number of data bits to 8 when Printer Mode is set to GRAPH.

3.6.16 Hist Buf

Use the Hist Buf (Histogram Buffer) item to turn the histogram buffer on or off. The Hist Buf item also displays a percentage, which indicates how full the histogram buffer is. (When the Histogram Buffer is full, no more information can be written to it.)

To change the selection, move the cursor to ON or OFF, and press SELECT.

ON

The histogram buffer collects results information.

NOTE: If the buffer was previously OFF and you turn it ON, the display will show the following message:

```
Clear Buffer      NO  YES
```

Move the cursor to the appropriate answer (NO or YES), and press SELECT. If you select NO, previously collected results remain in the histogram buffer. If you select YES, then the buffer is cleared, and the display shows the following message.

```
Clearing
Histogram Data
```

OFF

The histogram buffer stops collecting information. However, turning the buffer off does not clear the buffer.

3.6.17 Hist Rslt

Use the Hist Rslt (Histogram Result) item to specify the result from the histogram buffer to be printed in a Histogram Print. (For more information, see the section on Histogram Prints.)

The following selections are available. When you select ALL, histograms are printed for each of the histogrammable results.

AIS	Alarm Indication Signal
BIT ERRS	Bit Errors
CODE ERRS	Code Errors
CRC4 ERRS	CRC4 Errors
ERR SEC	Errored Seconds
FAS DIST	Distant Frame Alignment Signal Losses
FAS ERRS	Frame Alignment Signal Errors
FAS LOSS	Frame Alignment Signal Losses
MFAS DIST	Distant Multiframe Alignment Signal Losses
MFAS ERRS	Multiframe Alignment Signal Errors
MFAS LOSS	Multiframe Alignment Signal Losses
PATT LOSS	Pattern Losses
PATT SLIP	Pattern Slip
SES	Severely Errored Seconds
SIG LOSS	Signal Losses
T16 AIS	Timeslot 16 Alarm Indication Signal
UNAVL SEC	Unavailable Seconds
ALL	All of the above results

3.6.18 Hist Print?

To create a histogram and send it to the Print Buffer, move the cursor to the Hist Print? item and press SELECT. The histogram is created and placed in the Print Buffer for printing when a printer is attached and ready.

After you request that a histogram be created, you may get one of several messages (shown below with their explanations).

While the INTERCEPTOR 135A prepares the histogram data, the the following message is displayed.

```
Processing Histogram
Data - Please Wait
```

If no information regarding the specified result (as selected in the Hist Rslt item) has accumulated in the histogram buffer, the display shows the following message.

```
No Such Event During
Specified Time
```

If the histogram has been prepared and placed in the Print Buffer to be printed out, but the printer is not ready, the display shows the following message.

```
HISTOGRAM PRINT
PRINTS PENDING: #
PRINT BUFFER xx% FULL
```

where # is the number of Prints that are in the Print Buffer, and xx% indicates how full the Print Buffer is.

If the Start time that was specified (in the Start item) is later (relative to the time the histogram buffer was turned on) than the current time, and the histogram buffer is on, the display shows the following message.

```
Start Time Must Be
<= Stored Time
```

If the Start time that was specified (in the Start item) is later (relative to the time the histogram buffer was turned on) than the current time, and the histogram buffer is off, the display shows the following message.

```
Start Time Must Be
<= Elapsed Time
```

To clear this error message, set Start to 00:00:00 and Len to AUTO.

If the Print Buffer is full (100%), the display shows the following message.

```
No Memory For
Print Request
```

When you receive this message, you must clear sufficient space in the Print Buffer (by printing one or more of the waiting Prints or by clearing the Print Buffer) before you can send histogram information to the Print Buffer.

3.6.19 Start

Use the Start item to specify the start time (relative to the time the histogram buffer was originally turned on) for the Histogram Print. Specify the start time in the DD/HH:MM (day/hour:minute) format.

NOTE: A complete specification of the time to be covered in the Histogram Print requires both the Start and Len times. It is often useful on the first Histogram Print to set Start to 00/00:00 and Len to AUTO to get a Print of the entire histogram buffer contents. Then from that Print, you can determine if you want to use different Start and Len settings to "zoom in" on particular time periods. (For complete information, see the section on Histogram Prints.)

3.6.20 Len

Use the Len (Length) item to specify the amount of time to be covered in the Histogram Print. Specify the time length in the DD/HH:MM (day/hour:minute) format.

3.6.21 Hist Type

Use the Hist Type item (Histogram Type) to specify whether you want the histogram to be printed in a GRAPH or LIST format (as described below).

GRAPH

Selects the graphics format (which presents the results information in the form of a 2-dimensional graph) for Histogram Prints. For printing, normally use GRAPH.

LIST

Selects the LIST format (which presents the results information as a list of ASCII text characters separated by commas). Usually, LIST is used only in connection with spreadsheet work.

3.6.22 Hist Buf Clear?

Use the Hist Buf Clear? (Histogram Buffer Clear?) to erase the contents of the histogram buffer. To clear the histogram buffer, move the cursor to the Hist Buf Clear? item, and press SELECT.

If the histogram buffer contains information, when you press SELECT the display shows following message.

```
Clear Buffer      NO      YES
```

Move the cursor to the appropriate answer (NO or YES), and press SELECT. If you select NO, previously collected results remain in the histogram buffer. If you select YES, then the buffer is cleared, and the display shows the following message.

```
Clearing
Histogram Data
```

3.6.23 Program Store

Use the Program Store item to store the current setup information. The information is stored in the battery-backed storage location having the number you specify. Then you can later recall the information stored under that program number to configure the INTERCEPTOR 135A.

```
Program X  STORE?
```

To store a SETUP configuration, perform the following steps.

1. Move the cursor to the program number.
2. Press SELECT until the display shows the number you want to assign to this configuration.
3. Move the cursor to STORE?
4. Press SELECT.

As the current SETUP configuration is stored under the number you specified, the display shows the following message.

```
STORING  
PROGRAM ....
```

3.6.24 Program Recall

Use the Program Recall item to recall a setup from any of the ten battery-backed memory locations (0 through 9). When you recall a setup, the test instrument is automatically configured to match that setup.

```
Program X  RECALL?
```

To recall a SETUP configuration, perform the following steps.

1. Move the cursor to the program number.
2. Press SELECT until the display shows the number of the program you want to recall.
3. Move the cursor to RECALL?
4. Press SELECT.

As the test instrument recalls the SETUP configuration that is stored under the number you specified, the display shows the following message.

```
RECALLING  
PROGRAM ....
```

The test instrument is automatically reconfigured to the setup stored in the specified program.

3.6.25 Performance

Use the Performance item to specify whether you are using a G.821 standard or an M.2100 standard. The following selections are available for the Performance item:

G.821

Select G.821 to use the CCITT Recommendation G.821 performance analysis standard.

M.2100

Select M.2100 to use the CCITT Recommendation M.2100 performance analysis standard.

3.6.26 Beeper

Use the Beeper item to turn the beeper ON or OFF.

When set to ON, the beeper beeps when you are viewing the SUMMARY Results category and there is a change in one of the items in the SUMMARY Results category.

3.6.27 FAS Results

Use the FAS Results item to specify whether you want the FAS Errors result to be based on FAS bit errors or FAS word errors. The following selections are available for FAS Results.

BIT

When based on FAS bit errors, one FAS error is counted for every bit that is in error in a FAS word.

WORD

When based on FAS word errors, one FAS error is counted when one or more errors occur in a FAS word.

3.6.28 Time

Use the Time item to set the test instrument's internal time of day clock. The Time setting is used in the time and date stamp that appears on all Prints and is displayed in the Time result.

The format of the Time item is as follows:

Time 15:58

The current time is shown in a 24-hour HH:MM (hour:minute) format.

3.6.29 Date

Use the Date item to set the test instrument's internal calendar. The Date setting is used in the time and date stamp that appears on all Prints and is displayed in the Date result.

The format of the Date item is as follows:

Date 15/FEB/1994

The current date is shown in the DD/MMM/YYYY (day/month/year) format.

3.6.30 Memory Clear?

Use the Memory Clear? item to reset all battery-backed memory locations to their factory default configurations.

CAUTION: Be careful using the Memory Clear feature because it permanently erases from memory all programs, results, and Prints that have been stored.

To clear the test instrument's memory, move the cursor to the Memory Clear? item, and press SELECT. The display shows the following message.

Are You Sure? NO YES

Move the cursor under the appropriate response (NO or YES) and press SELECT.

If you select YES, the test instrument clears its battery-backed memory. This process takes several seconds. When completed, the test instrument is back in its factory default setup and the Print Buffer is empty.

TEST RESULTS

4.1 OVERVIEW

The INTERCEPTOR 132A provides test results that give you the information you need to qualify and maintain your telecommunications circuits. INTERCEPTOR 132A test results are grouped into the following categories.

- SUMMARY
- LOGIC & TIME
- SIGNAL, CODE & FAS
- CHAN. & SIGNALING
- PERFORMANCE

To select the category you want to view, press RESULTS. The test results included in that category are displayed in the liquid crystal display.

NOTE: The displayed results pertain to the current test only.

4.2 SUMMARY RESULTS

The SUMMARY Results category presents a helpful list of the key results from the other results categories. The SUMMARY category can include the following results.

- Bit Errs (Bit Errors)
- Patt Slip (Pattern Slip)
- Patt Loss (Pattern Loss)
- Code Errs (Code Errors)
- FAS Errs (FAS Errors)
- MFAS Errs (MFAS Errors)
- CRC Errs (CRC Errors)
- Freq Δppm (Frequency Deviation)
- RT Delay (Round Trip Delay)

The SUMMARY category displays only those results from the above list that have acquired a non-zero value since the start of the current test and that are applicable for the current test setup.

When the SUMMARY category is displayed and a change occurs in one of the SUMMARY results, the beeper sounds (if it is activated).

Also, before the INTERCEPTOR 132A is connected to the circuit under test (and, therefore, before test results are available), the SUMMARY results category displays the following message:

Results Unavail

When the INTERCEPTOR 132A is connected to the circuit under test and test results indicate no errors, the SUMMARY results category displays the following message:

Results OK

4.3 LOGIC & TIME RESULTS

The LOGIC & TIME Results category includes results based on bit errors detected in the test pattern and also includes the current time and date setting. The LOGIC & TIME category can include the following results.

- Rcv Pat (Received Pattern)
- Bit Errs (Bit Errors)
- BER (Bit Error Ratio)
- Patt Loss (Pattern Loss)
- Patt Slip (Pattern Slip)
- Elpsd Sec (Elapsed Second)
- Test Sec (Test Second)
- Time
- Date
- RT Delay (Round Trip Delay)

Rcv Pat

The Rcv Pat (Received Pattern) result indicates the test pattern that is being detected when the INTERCEPTOR 132A is set up for automatic pattern detection.

Bit Errs

The Bit Errors result indicates the number of bit errors detected in the test pattern since pattern synchronization was achieved.

BER

The BER (Bit Error Rate) result is the ratio of the number of bit errors to the total number of bits received.

Patt Loss

The Pattern Synchronization Loss result indicates the number of times the receiver has lost pattern synchronization.

Patt Slip

The Pattern Slips result indicates the number of pattern slips detected in the received pseudorandom (2^N-1) test pattern. Pattern slips occur when one or more bits of the test pattern are deleted or repeated.

Elpsd Sec

The Elpsd Sec (Elapsed Seconds) result indicates the number of seconds that have elapsed since the test was restarted.

Test Sec

The Test Seconds result indicates the number of seconds that have elapsed since achieving pattern synchronization.

Time

The Time result indicates the current time (in hours, minutes, and seconds) in the following 24-hour format: HH:MM:SS.

Date

The Date result indicates the current date (in day, month, and year) in the following format: DD MMM YYYY.

RT Delay

The Round Trip Delay result indicates the amount of time it takes for a signal to travel to the looped-back point in the network and back. (This test result is available only when Pattern is set to DELAY.)

NOTE: To update this test result, press the **RESTART** control.

The accuracy of this result is to the nearest bit (for example, at 64 kbit/s the accuracy is ± 32 microseconds, and at 2 Mbit/s the accuracy is ± 1 microsecond).

4.4 SIGNAL, CODE & FAS RESULTS

The SIGNAL, CODE & FAS Results category contains 2.048 Mbit/s signal frequency and level measurements, and contains results that are based on code and FAS errors. The SIGNAL, CODE & FAS category can include the following results.

- Freq (Frequency)
- Freq Δ ppm (Frequency Deviation)
- Bit Slip
- Frame Slip
- Level (dBnom)
- Level (Vpeak)
- Code Errs
- Code Rate
- FAS Errs
- FAS Rate
- MFAS Errs
- MFAS Rate
- CRC Errs
- CRC Rate
- FAS Word
- NFAS Word
- MFAS Word
- CRC MF Wrđ
- REBEs
- Sa6Bits

Descriptions of the SIGNAL, CODE & FAS results follow.

Freq

The Freq (Frequency) result indicates the measured frequency (in hertz) of the received signal.

Freq Δ ppm

The Freq Δ ppm (Frequency Deviation) result indicates the peak value difference between the measured frequency and the 2.048 Mbit/s internal clock, expressed in parts per million (ppm).

Bit Slip

The Bit Slip result indicates the difference between the recovered clock of the receiver input and the recovered clock of the 2M Reference Input. (The Bit Slip result is available if Option 132A-1 is installed.)

Frame Slip

The Frame Slip result is the Bit Slip result divided by the number of bits per frame (256). (The Frame Slip result is available if Option 132A-1 is installed.)

Level (dBnom)

The Level (dBnom) result indicates the level of the received signal, expressed in dB, relative to the 2 Mbit/s G.703 nominal value.

Level (Vpeak)

The Level (Vpeak) result indicates the peak level of the received 2 Mbit/s signal, expressed in volts.

Code Errs

The Code Errs (Code Errors) result indicates the number of code violations detected at 2 Mbit/s.

Code Rate

The Code Rate result is the Code Errs result divided by the number of bits received.

FAS Errs

The FAS Errs (Frame Alignment Signal Errors) result indicates the number of FAS words or FAS bits received that contain an error. (FAS Errs measures either FAS bit errors or FAS word errors depending on the selection for FAS Results in the AUXILIARY setup category.)

FAS Rate

The FAS Rate result is the FAS Errs result divided by the number of bits received since the start of the test.

MFAS Errs

The MFAS Errs (Multiframe Alignment Signal Errors) result indicates the number of MFAS words received since MFAS or MFAS-CRC synchronization that contain an error.

MFAS Rate

The MFAS Rate result is the MFAS Errs result divided by the number of bits received.

CRC Errs

The 2 Mbit/s CRC Errs (Cyclic Redundancy Code Errors) result indicates the number of CRC-4 errors received while in FAS-CRC or MFAS-CRC synchronization.

CRC Rate

The CRC Rate result is the 2 Mbit/s CRC Errs result divided by the total number of CRC-4 sub-multiframes received.

FAS Word

The FAS Word result is the FAS Word found in Timeslot 0 of even-numbered frames.

The format for the FAS Word result is C0011011, where:

C Indicates the presence of a valid CRC-4 code.

0011011 The normal Frame Alignment Signal. (If an X appears in place of any of the bit positions, it indicates an error in the indicated bit position.)

NFAS Word

The NFAS Word ("Not FAS" Word) result presents the 8-bit byte found in Timeslot 0 of odd-numbered frames (which do not contain a frame alignment signal).

The format for the NFAS Word result is C1ABBBBB, where:

- C A "C" in the first bit position indicates the presence of a valid CRC-4 code.
- 1 Bit position two should always be set to "1." (An "X" appears if the bit is received in error.)
- A The following values in bit 3 indicate the absence or presence of a FAS Distant alarm, as indicated:
 0 Absence
 1 Presence

BBBBB Spare bits that are used in various applications recommended by CCITT. When these bits are not used, they should be set to "1."

MFAS Word

The MFAS Word (Multiframe Alignment Signal Word) result indicates the 8-bit byte found in Timeslot 16 of Frame 0 of every multiframe.

The format for the MFAS Word result is MMMMbabb, where:

- MMMM Normally, the MFAS is "0000." If an X appears in place of any of the bit positions, it indicates an error in the indicated bit position.
- b Spare bits. Normally set to "1."
- a Indicates the absence (0) or presence (1) of an MFAS Distant alarm.

CRC MF Wrd

The CRC MF Wrd (CRC Multiframe Word) result indicates the values received in the Bit 0 position of the eight consecutive NFAS words in a multiframe.

The format for the CRC MF Word result is 001011ii, where:

- 001011 The CRC Multiframe Alignment Signal. If an X appears in place of any of the bit positions, it indicates an error in the indicated bit position.
- ii International bits. The values that appear in these bit positions will depend on the application.

REBEs

The Remote End Block Errors (REBEs) result indicates the number of Remote End Block Errors detected while in CRC-4 multiframe alignment with REBEs turned on. The REBE Errs result is only valid for 2 Mbit/s modes with CRC set to ON.

Sa6Bits

The Sa6Bits result displays the Sa6 loop code bits. The Sa6 messages are applicable to 2M framed, 2M Voice, 2M Nx64k/56k, 2M Mx64k/56k, and 2M 64k/56k setups. The four Sa6 bits represent specific network conditions, as follows:

- 0000 No loopbacks selected
- 1110, 0111, 1011, or 1101 NTPM frame sync loss
- 0001, 0010, 0100, or 1000 NTPM power loss
- 1111 NTPM AIS

4.5 CHAN. & SIGNALING RESULTS

The CHAN. & SIGNALING (Channel and Signaling) results category contains results regarding the timeslots. An example set of CHAN. & SIGNALING results (for Timeslot 3) is shown below.

```
Timeslot: 3
Active Timeslots:
  F123...789012...5
  M78.....56...901
```

```
Timeslot: 3
Rx Byte: 00011010
ABCD: 1101
Freq: 1966 Hz
```

```
Timeslot: 3
Peak: -126
Level: -7.6 dBm
```

The CHAN. & SIGNALING category can include the following results.

- Timeslot
- Active Timeslots
- Rx Byte
- ABCD
- Freq (Hz)
- Peak
- Level (dBm)
- C-Bits
- C-Bit Delay

Timeslot

The Timeslot line is displayed at the top of every page of the CHAN. & SIGNALING display. The Timeslot number (0 through 31) indicates the timeslot for which the results are provided. To see the results for a different timeslot, move the cursor to the timeslot number and press SELECT.

Active Timeslots

The Active Timeslots result provides a graphical representation of timeslots 0 through 31 in the following format:

```
F123...789012...5
M78.....56...901
```

where:

0-9 Indicates the last digit of the timeslot number (0 to 31) of an active timeslot. (A timeslot is considered to be active when a PCM signal with a level greater than -35 dBm is detected on the timeslot.)

F When FAS is present, an "F" replaces the "0" of Timeslot 0 to indicate the presence of the FAS word.

M When MFAS is present, an "M" replaces the "6" of Timeslot 16 to indicate the presence of the MFAS word.

• Replaces a timeslot's number in the graphical representation to indicate that the timeslot is idle.

Rx Byte

The Rx Byte (Received Byte) result indicates the 8-bit byte received in the selected timeslot.

ABCD

The ABCD result indicates the ABCD, or channel-associated signaling (CAS), bits in the selected timeslot. (The ABCD result is available only when Framing is set to MFAS or MFAS-CRC.)

Freq

The Freq (Frequency) result is the measured frequency of the PCM-encoded signal in the selected timeslot.

Peak

The Peak result is the peak PCM code (1 through 27) detected during the previous second in the selected timeslot.

Level (dBm)

The Level result is the measured power (in dBm) of the signal in the selected timeslot.

C-Bits

The C-Bits result displays the C-Bit information for the RX voice channel in the following format:

```
Timeslot: 07
C-Bits
Loop 2M      On
F011100001001000
```

If out of C-Bit Framing synchronization, the C-Bits show as either "1111111111111111" or "0000000000000000" depending on the received C-Bit in the ABCD word.

C-Bit Delay

The C-Bit Delay is the delay between the time the last C-Bit is sent and the C-Bit Word is received with the acknowledgement bit (bit 8) low.

4.6 PERFORMANCE RESULTS

The PERFORMANCE Results category contains results that are calculated according to CCITT Recommendation G.821 or M.2100 depending on the Auxiliary Category Performance selection (M.2100 or G.821). These results are based on out-of-service bit error results that are

extrapolated over time to determine useful information reported as Performance results. For more information about how these Results are calculated, see Appendix D.

The PERFORMANCE category can include the following results.

G.821 Results	M.2100 Results
Avl Sec	2 Avl T
% Avl Sec	2 %Avl T
Unavl Sec	2 Una T
SES	2 SES
%SES	2 %SES
Err Sec	2 ES
Deg Min	2 %EFS
% Deg Min	2 ESF
EFS	
%EFS	
Err-SES	
BER-SES	

4.6.1 G.821 Results**Avl Sec**

Available Seconds, calculated as specified in CCITT Specification G.821.

%Avl Sec

Percentage of Available Seconds, calculated as specified in CCITT Specification G.821.

Unavl Sec

Unavailable Seconds, calculated as specified in CCITT Specification G.821.

SES

Severely Errored Seconds, calculated as specified in CCITT Specification G.821.

%SES

Percentage of Severely Errored Seconds, calculated as specified in CCITT Specification G.821.

Err Sec

Errored Seconds—The number of Available Seconds that contain one or more errors, calculated as specified in CCITT Specification G.821.

Deg Min

Degraded Minutes, calculated as specified in CCITT Specification G.821.

%Deg Min

Percentage of Degraded Minutes, calculated as specified in CCITT Specification G.821.

EFS

Error Free Seconds, calculated as specified in CCITT Specification G.821.

%EFS

Percentage of Error Free Seconds, calculated as specified in CCITT Specification G.821.

Err-SES

Bit Errors Minus Severely Errored Seconds — Total bit errors, excluding errors that occurred during severely errored seconds.

BER-SES

Bit Error Rate Minus Severely Errored Seconds — The BER calculated over the test interval, excluding severely errored seconds.

4.6.2 M.2100 Results**2 Avl T**

Available Time (in seconds), calculated as the total number of seconds without a defect or an anomaly rate below CCITT thresholds. This count does not begin until ten consecutive available seconds are detected. The count includes the first ten available seconds.

2 %Avl T

Percentage of Available Time, calculated as the ratio of the number of available seconds to the total number of test seconds, then multiplied by 100.

2 Una T

Unavailable Time, calculated as the total number of seconds with a defect or an anomaly rate that exceeds CCITT thresholds. This count does not begin until ten consecutive unavailable seconds are detected. The count includes the first ten unavailable seconds.

2 SES

Severely Errored Seconds, calculated as the total number of seconds with a defect or an anomaly rate that exceeds CCITT thresholds.

2 %SES

Percentage of Severely Errored Seconds, calculated as the ratio of severely errored seconds to the total number of available seconds, then multiplied by 100.

2 ES

Errored Seconds — The number of Available Seconds that contain one or more defects or anomalies. These one-second intervals are not synchronized to the bit errors (Error Analysis category).

2 EFS

Error Free Seconds, calculated as specified in CCITT Specification M.2100.

2 %EFS

Percentage of Error Free Seconds, calculated as the ratio of error free seconds to the total number of available seconds, then multiplied by 100.

USING A PRINTER**5.1 OVERVIEW**

You can set up the INTERCEPTOR 132A to create various types of Prints. The Prints are placed in the INTERCEPTOR 132A's Print Buffer. The Print Buffer can hold up to 50 standard (STD) Results Prints or 500 Event Prints. The contents of the Print Buffer remain even when the test instrument is powered off (because the buffer is part of the test instrument's battery-backed memory). To send the contents of the Print Buffer to a printer, connect a printer to the INTERCEPTOR 132A and set up for printing. When a Print is sent to the printer, the information is removed from the Print Buffer.

For information regarding how to create the following types of Prints, see the indicated section.

Controls Print	Section 5.2
Results Print	Section 5.3
Auto Print - TIMED	Section 5.4
Auto Print - EVENT	Section 5.5
Histogram Print	Section 5.6

For information on how to connect a printer to an INTERCEPTOR 132A and set up for printing, see Section 5.7.

5.2 CONTROLS PRINT

A Controls Print provides a Print indicating the test instrument's current configuration.

To create a Controls Print, press the PRINTER CONTROLS control on the INTERCEPTOR 132A. A sample Controls Print follows.

```

=====
CONTROLS PRINT      16:10:06  7-JAN-1994
Self Loop          ON    Err Insert          OFF
Test Mode          2048K  Transmitter         ON
Tx Clock INT2048K
Framing            AUTO  Pattern             AUTO
Tx ABCD            1101  Tx AIS Alarm        OFF
Tx FAS Alarm       OFF   Tx MFAS Alarm       OFF
TX NFAS Clk11111  Tx MFAS             00001a11
Result Print       SUM   Auto Prints         OFF
RS232 ModePRINTER RS232 Prt           2400,N,8
Printer ModeASCII  Printer Term        CRLF
Hist Buf           0% OFF Hist Rslt            SES
Start              00/00:00 Len      AUTO 00/00:01
Hist Type          GRAPH
  
```

5.3 RESULTS PRINT

A Results Print gives you a Print of the accumulated test results. To create a Results Print, use the following instructions.

1. **Set up for the type of Results Print you want.**
In the AUXILIARY category's Result Print item, select the desired type of Results Print.
2. **To create a manual Results Print, press the PRINTER RESULTS control.**
When you press the PRINTER RESULTS control, a Results Print (of the type you have selected) is created.

Following are descriptions of the types of Results Prints.

Results Print (Standard Format)

A Results Print in Standard (STD) format includes every result maintained by the test instrument. A sample Results Print in Standard Format follows.

```

=====
RESULTS PRINT      16:10:15  7-JAN-1994
Rcv Pat:          2^15-1  Bit Errs:           0
BER:              0.E-09  Patt Loss:          0
Patt Slip:        0      Elpsd Sec:           3161
Test Sec:         3161   Freq:              2047999 Hz
Freq ppm:         -1    Bit Slip:           No Ref
Frame Slip:       No Ref Level:           -0.1 dBnom
Level:            2.974 Vpeak Code Rate:      0.E-09
FAS Rate:         0.E-06 MFAS Rate:        0.E-06
CRC Rate:         0.E-06 CRC Errs:           0
CRC MF Wrd:00101111 Code Errs:           0
FAS Errs:         0      MFAS Errs:          0
FAS Word:         C0011011 NFAS Word:       C1011111
MFAS Word: 00001011 %EFS:             100.0 %
%SES:             0.0 % %Avl Sec:           100.0 %
%Deg Min:         0.0 % EFS:                3161
Err Sec:          0      SES:                0
Err-SES:          0     BER-SES:           0.E-09
Deg Min:          0     Avl Sec:           3161
Unavl Sec:        0     Signal:                On
FAS Sync:         On    MFAS Sync:           On
Patt Sync:        On    Patt Invr:           Off
CRC4:             On    TS-16 AIS:           Off
AIS:              Off   MFAS Dist:           Off
FAS Dist:         Off
Patt Slip:        Off
  
```

Results Print (Summary Format)

A Results Print in Summary format provides a list of the most important results, as shown in the following example.

```
=====
RESULTS PRINT      16:10:30 7-JAN-1994
Patt Loss:        0      MFAS Errs:      0
AIS:              Off    MFAS Dist:Hist/Off
%Avl Sec:        100.0 %  Err Sec:      2
%EFS:            99.9 %  %SES:         0.1 %
%Deg Min:        0.0 %
```

Results Print (Signaling Summary Format)

A Results Print in Signaling Summary format lists up to the last 250 signaling changes detected on the selected voice timeslot since the start of the current test. Each change of state is time and date stamped. A sample Results Print in Signaling Summary Format follows.

```
=====
SIGNALING SUMMARY  14:50:24 15-JAN-1994
TIMESLOT 01  ABCD
14:49:08  15-Jan-1994      0101
14:49:13  15-Jan-1994      1101
14:49:21  15-Jan-1994      0101
14:49:27  15-Jan-1994      1101
14:49:40  15-Jan-1994      0101
14:49:53  15-Jan-1994      1101
14:50:21  15-Jan-1994      0101
```

5.4 AUTO PRINT — TIMED

A Timed Print is created automatically whenever a specified amount of time elapses. A Timed Print looks just like a Results Print, except that it is labeled **TIMED PRINT** (instead of **RESULTS PRINT** or **SIGNALING SUMMARY**). The type of Timed Results Print (**SUM**, **STD**, or **SIGNAL**) depends on the setting of the Result Print item.

To create a Timed Print, use the following instructions.

1. **Select the AUXILIARY setup category.**

2. **Set Auto Print to TIMED.**

3. **Set Time Interval to the desired value**

Determine the desired time interval between automatic Timed Prints in hours and minutes (HH:MM).

5.5 AUTO PRINT — EVENT

An automatic Event Print is created whenever a specified event occurs. The Print includes the name of the event, the accumulated value of the event since the beginning of the test, and the date and time that it occurred.

To create an Event Print, use the following instructions.

1. **Select the AUXILIARY setup category.**

2. **Set Auto Print to EVENT.**

3. **Set Event(s) to act as the Event Print trigger.**

Each Event Print lists all the error types, alarms, and events that occurred during the second the Event Print was triggered.

Two sample Event Prints follow.

```
EVENT PRINT      16:11:35 7-Jan-1994
HDB3 Loss       0      Patt Loss      0
FAS Loss        1      MFAS Loss      0
AIS Present     NO
```

```
EVENT PRINT      16:11:35 7-Jan-1994
HDB3 Present YES  Pattern Sync  YES
MFrame Err      5      FAS Sync      YES
MFAS Sync       ON     AIS Clear     NO
MFAS Dist       OFF    MFAS Dist     Clear
```

5.6 HISTOGRAM PRINT

A Histogram Print provides information regarding accumulated results for a specified period of time. There are two types of Histogram Prints: Graph and List. Examples of the different formats of histogram prints, depending on the specified setup, are provided at the end of these instructions. For an explanation of the parts of a Histogram Print, see Appendix D.

To create a Histogram, use the following instructions.

Ensure the histogram buffer includes the desired information.

1. If desired, clear the histogram buffer.

If the buffer contains information that you no longer need, you can clear the histogram buffer by using the Hist Buf Clear? item in the AUXILIARY setup category. To find out how full the histogram buffer is at any time, check the Hist Buf item in the AUXILIARY setup category.

2. When desired, turn the histogram buffer on to start collecting information.

To turn on the histogram buffer, in the AUXILIARY category, set Hist Buf to ON. When the histogram buffer is on, information for all histogrammable results is continually stored in the histogram buffer.

Specify the format for the histogram print.

(To see examples of the various formats, see the diagrams that follow this list of instructions.)

3. Select the AUXILIARY setup category.

4. Select Hist Type (GRAPH or LIST).

Use GRAPH to present the results information in the form of a bar graph and proceed to Step 5.

Use LIST to present the results information as a list of ASCII characters and skip to Step 6.

5. Set Printer Mode (GRAPH or ASCII).

For non-graphics printers, use ASCII (so that the bars of the graph can be represented using ASCII characters). For graphics printers, use GRAPH or ASCII.

Specify the histogram print information.

6. Set the Hist Rslt item.

You can request a histogram for a single result or histograms for all results.

7. Set Start and Len.

You can print all, or only a portion of, the contents of the histogram buffer. Use Start to specify the start time and Len to specify the amount of time to be covered.

To print the entire contents of the histogram buffer, set Start to 00/00:00 and set Len to AUTO. If you find that all (or most) of the results are clustered around a given time period, you can create another Histogram Print — this time “zooming in” on a smaller time period so that you can see that time period in greater detail. (The minimum span of time on which you can zoom in is 60 seconds.)

Create the histogram.

8. Select the Hist Print? item and press SELECT.

5.6.1 Examples of Histogram Prints

a Histogram Print depends on the setting of Hist Type (GRAPH or LIST) and, if Hist Type is set to GRAPH, the setting for Printer Mode (GRAPH or ASCII).

Figure 5-1 is an example of a Histogram Print when Hist Type is set to GRAPH and Printer Mode is set to GRAPH. The bars in the graph represent the test results.

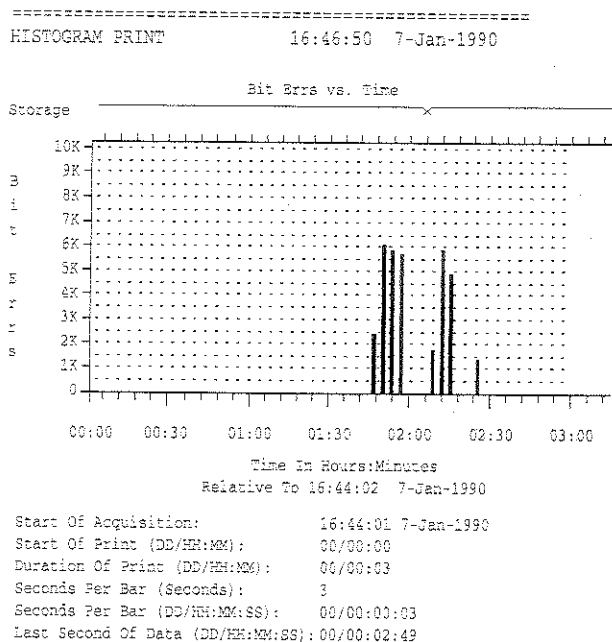

Figure 5-1
Histogram Print (GRAPH; GRAPH)

Figure 5-2 is an example of a Histogram Print when Hist Type is set to GRAPH and Printer Mode is set to ASCII. The bars in the graph are represented by columns of asterisks. This type of setup is often used when you are displaying a histogram on a non-graphics printer.

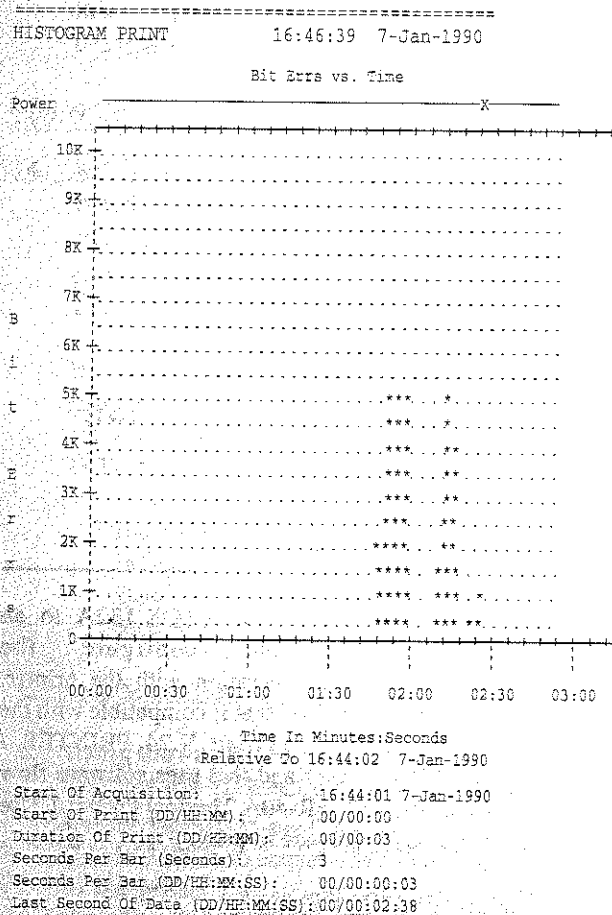

Figure 5-2
Histogram Print (GRAPH; ASCII)

6. Check the paper supply in the printer.

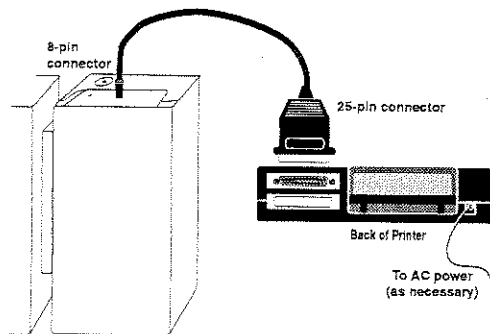

Figure 5-4
Printer Connection

Prepare to print

7. Power on the INTERCEPTOR 132A and the printer.

NOTE: Do not place the printer on line yet!

8. If desired, clear the Print Buffer.

The Print Buffer stores Prints (including automatically-generated Prints) for printing when a printer is available. If you do not want to print any stored Prints, clear the buffer. To clear the Print Buffer, press the PRINTER CLEAR control. The display shows the following message: Are You Sure NO YES?. Position the cursor to the appropriate choice and press SELECT. The display momentarily shows the following message: CLEARING PRINT BUFFER.

Begin printing.

9. To begin printing, place the printer on line.

REMOTE CONTROL

6.1 OVERVIEW

You can control the INTERCEPTOR 132A by remote control. That is, instead of configuring the INTERCEPTOR 132A by pressing the controls on the front panel and using the SETUP categories, you can configure the INTERCEPTOR 132A by typing in commands on a computer keyboard. And instead of viewing test results by observing the front panel of the INTERCEPTOR 132A or by printing out the results, you can view test results by displaying them on a computer screen.

The INTERCEPTOR 132A complies with the command syntax specified in IEEE-488.2 (1987). Among other things, IEEE-488.2 supports certain common commands and standardizes the numerical format for exponential notations to make writing remote control programs less complex.

For information on how to begin and to operate in remote control, see Section 6.2. For an alphabetical list and description of the remote control commands and queries, see Section 6.3. For a description of Error Messages you might see when operating in remote command mode, see Section 6.4. For details regarding IEEE 488.2 status register reporting, see Appendix B.

6.2 REMOTE CONTROL OPERATION

If you have a suitable remote controller (such as a dumb terminal, a computer, or a controller), perform the following steps to set up for Remote Control operation.

1. Connect the 132A and the remote controller.

The 8-pin to 25-pin Printer/Remote Control cable (Model 31202) is used to connect the INTERCEPTOR 132A to the remote controller. Plug the 8-pin round connector into the INTERCEPTOR 132A PRINTER/REMOTE CONTROL port, and plug the 25-pin D connector into the appropriate port on the remote controller.

NOTE: Since the same port on the test instrument is used for printing and for remote control, the printer and the remote controller cannot be used at the same time. However, information that would normally be printed can be output to the remote controller's screen.

2. Power on the 132A and the remote controller.

3. Set up the 132A to operate under remote control.

In the AUXILIARY category, set RS232 Mode to REMOTE. Also, appropriately set the RS232 Port, Printer Mode, and Printer Term items.

4. To begin type Control C at the remote controller.

A prompt character (>) appears on the controller monitor to indicate that you can enter your first command/query. When you enter the first command/query, the LED for PANEL LOCK illuminates to indicate that control is now at the controller (and not at the front panel).

Initially, the controller is in "terminal" mode. In terminal mode, the INTERCEPTOR 132A operates interactively with the remote controller. That is, the

INTERCEPTOR 132A provides a prompt character (>) when it is ready to receive a command, echoes all characters back to the remote controller, and transmits error response messages.

If you do not want to see the commands/queries you type in or any error messages, you can switch to "computer" mode. In computer mode, the INTERCEPTOR 132A provides an output to the controller only in direct response to a query. The controller receives no other output. Computer mode lets you concentrate on the commands and responses, without being interrupted by echoed statements or error messages.

To switch to computer mode, type the following command: MISC:RC_MODE COMP.

5. When you are finished using remote control mode, return control to the front panel.

To leave remote control and return control to the front panel, enter the LOCAL command.

6.3 COMMANDS AND QUERIES

The remote control commands are messages that you can send to the INTERCEPTOR 132A. The remote control commands include commands that are standard with any IEEE 488.2 interface, plus commands used to set up the INTERCEPTOR 132A, commands to obtain tests results, and miscellaneous commands. The remote control queries are messages that you send to the INTERCEPTOR 132A to request information.

6.3.1 Syntax for Commands and Queries

The general format for entering commands is:

```
command:subcommand parameter1,parameter2
terminator
```

Note that there is a colon between the command and the subcommand. And there is a space between the subcommand and the first parameter (when there is a parameter). And if there is more than one parameter, the parameters are separated by a comma. A command always ends in a terminator. (The terminator is whatever you have set it to be. See the SET:TERM command.)

You may enter more than one command at a time. Just separate the commands with a semicolon and when you are finished entering commands, enter a terminator, as illustrated below.

```
command:subcommand;command:subcommand
terminator
```

Additionally, when you type a string of commands, if they all begin with the same command, you do not need to type the command each time; just type the subcommand and parameters as in the following example (which does not repeat the "SET:" command before the "HSTC" subcommand).

```
SET:HSTB OFF;HSTC
```

When you enter a series of commands in a single string, the responses will be presented as a string separated by semicolons.

The following conventions are used in the representation of the commands/queries presented in this section.

< >	Substitute the appropriate value (in the indicated format, as appropriate).
[x y z]	You must type x, or y, or z.
[?]	You may type ?, as desired.

NOTE: When an underscore (_) or quotation marks (" ") are shown in the command, you must include them when you type the command.

6.3.2 Common Commands and Queries

The standard IEEE 488.2 commands and queries are listed alphabetically in this section. These commands all begin with an asterisk. Information that is entered using the remote controller is shown in **this bold typeface**.

Where useful, an explanation and example are included. Additionally, for the RES: queries, short forms of the query are shown and "Not Ready Values" (NRV) are indicated, as applicable. (The NRV is the response that is provided when you type in a query and the result is not yet available. When the result becomes available, it appears on the monitor without the need for you to repeat the command.)

***CLS**

Clear Status command only

***ESE [<mask> | ?]**

Event Status Enable command/query

The *ESE command sets the Standard Event Status Enable Register bits. The value of the bits in the Standard Event Status Enable Register determines which bits in that register are enabled. When a bit of the Standard Event Status Register and its corresponding enable bit are set, the Event Status bit 5 (ESB) of the Status Byte Register is also set.

The *ESE? query requests the current contents of the enable register. When the Standard Event Status Register is read, the value returned is the bit weights of all the set bits at the time the byte was read.

The act of reading the Standard Event Status Enable Register sets Bit 5 of the Status Byte Register.

The bits in the Standard Event Status Enable Register include:

Bit 0	Operation Complete
Bit 1	Request Control
Bit 2	Query Error
Bit 3	Device Dependent Error
Bit 4	Execution Error
Bit 5	Command Error
Bit 6	User Request
Bit 7	Power On

For additional information, see the *ESR and *STB commands, and refer to Appendix B.

Example:

```
>*ESE32  Enables bit 5 (Command Error) of the
          Standard Event Status Enable Register.
>*ESE?   Reads back the Standard Event Status
          Enable Register.
```

```
32
```

***ESR?**

Event Status Register query only

The *ESR? query requests the contents of the Standard Event Status Register. The value returned is the weight of all bits that are set at the time you read the byte. The Standard Event Status Register is cleared after it is read.

The bits of the Standard Event Status Register include:

Bit 0	Operation Complete
Bit 1	0
Bit 2	Query Error
Bit 3	0
Bit 4	Execution Error
Bit 5	Command Error
Bit 6	0
Bit 7	Power On (sets Bit 5 of the Status Byte Register)

The act of reading the Standard Event Status Register sets Bit 5 of the Status Byte Register.

For additional information, see the *SRE and *OPC commands, and see Appendix B.

Example:

```
>*ESR?  Requests the Event Status Register status.
32      Response indicates that a Command
          Error occurred.
```

***IST?**

Individual Status query only

The *IST? query requests device status information from the Parallel Poll Enable Register.

***LRN?**

Learn Device Setup query only

The *LRN? query requests the current test setup. The response lists the commands that are sent to the test instrument at some later time to restore it to its present setup.

***OPC[?]**

Operation Complete command/query

Use the *OPC command to set the Operation Complete (OPC) bit (Bit 1 of the Standard Event Status Register). This bit is set when all pending device operations have been completed. (For additional information, see Appendix B.)

The response to the *OPC query is an ASCII "1" in the output queue when all pending device operations have been completed.

Example:

>SET:TMOD 2048K; *OPC Sets the OPC bit 1 in the Standard Event Status Register after the test mode has been set to 2048K.

>SET:TMOD 2048K; *OPC?
1 Responds with a 1 after the test mode has been set to 2048K.

***OPT?**

Option Identification query only

The *OPT? query requests which options are installed in the INTERCEPTOR 132A. A "0" represents an option that is not installed. If no options are installed, a series of seven 0's is returned. An installed option is represented by its name.

NOTE: As new options and capabilities are developed, the number of elements in the response will almost certainly change in future software versions. However, the order and positions of the currently defined options will not change.

Example:

>*OPT? Requests the list of currently installed options.
DELTA_PPM, 2M_REF, 0, 0, 0, 0, 0

***PRE [<int> | ?]**

Parallel Poll Enable Register command/query

Use the *PRE command to set the IST message of the INTERCEPTOR 132A.

The *PRE? query requests the contents of the Parallel Poll Enable Register. The value returned is the weight of all bits that are set at the time you read the byte. The Parallel Poll Enable Register is cleared after it is read.

The act of reading the Parallel Poll Enable Register sets the IST message.

The bits of the Parallel Poll Enable Register include:

Bit 0	Error Available
Bit 1	0
Bit 2	Test Status Summary
Bit 3	0
Bit 4	0
Bit 5	Event Status Summary
Bit 6	Master Status Summary
Bit 7	0

*PSC [<int> | ?]

Power-on Status Clear command/query

Use the *PSC command to set the power-on status clear bit setting of the INTERCEPTOR 132A, using the following values for <int>.

- 1 The INTERCEPTOR 132A automatically clears all of the Status Enable Registers when powered on. This setting prevents the INTERCEPTOR 132A from generating a service request when it is powered on.
- 0 The INTERCEPTOR 132A does not clear the enable registers when powered ON.

The *PSC? query requests the current power-on status clear setting.

Example:

- ```
>*PSC 0 Preserves the Status Enable Registers
 through a power cycle.
>*PSC? Requests the current value of the power-
 on status clear setting.
```

0

#### \*RCL <int>

Recall Stored Test Setups command only

The \*RCL command causes the INTERCEPTOR 132A to recall a stored test setup. This command is the same as the Program Recall item in the AUXILIARY category. Unlike the Program Recall item, however, the remote control and printer device selections are not changed, nor is the RS232 setting changed. This exception ensures that remote control operation can continue after the \*RCL command is issued. Valid program numbers are 0 to 9.

Example:

- ```
>*RCL 3 Recalls stored test setup
           number 3.
```

*RST

Reset to factory defaults. command only

The *RST command sets the INTERCEPTOR 132A to its factory default settings.

*SAV <int>

Save test setups. command only

The *SAV command saves the current configuration of the test instrument, and under the number you specify. (Valid numbers are 0 through 9.) This command is the same as the Program Store item in the AUXILIARY category.

Example:

- ```
>*SAV 3 Saves the current test setup as
 Setup #3.
```

**\*SRE [<mask> | ?]**

Service Request Enable Register      command/query

The \*SRE command sets the Service Request Enable Register bits. The value of the bits in the Service Request Enable Register determines which bits in the Service Request Register are to be enabled. When a bit of the Service Request Register and its corresponding enable bit are set, the Master Summary Status (MSS) bit 6 of the Status Register is also set. The Master Summary Status bit represents the summary of all the status registers, queues, and buffers.

The \*SRE? query responds with the current contents of the Service Request Enable Register. When the Service Request Enable Register is read, the value returned is the bit weights of all bits that are set at the time the byte is read.

The act of reading the Parallel Poll Enable Register sets Bit 6 of the Status Byte Register.

The bits of the Service Request Enable Register include:

|       |                       |
|-------|-----------------------|
| Bit 0 | Error Available       |
| Bit 1 | Print Available (PAV) |
| Bit 2 | Test Status Summary   |
| Bit 3 | 0                     |
| Bit 4 | 0                     |
| Bit 5 | Event Status Summary  |
| Bit 6 | 0                     |
| Bit 7 | 0                     |

For additional information, see the \*STB command, and see Appendix B.

Example:

```
>*SRE 2 Enables Bit 1 (Print Available,
 PAV) to set the Master Status
 Summary bit.

>*SRE? Requests the SRE register status.
2 The INTERCEPTOR 132A
 responds with the current value
 of the SRE register.
```

**\*STB?**

Status Byte      query only

The \*STB? query requests the current value of the status byte. When you read the Status Byte Register, the value returned is the bit weight of all bits that are set at the time you read the byte.

The bits read include:

|       |                       |
|-------|-----------------------|
| Bit 0 | Error Available (EAV) |
| Bit 1 | Print Available       |
| Bit 2 | Test Status Summary   |
| Bit 3 | 0                     |
| Bit 4 | 0                     |
| Bit 5 | Event Status Summary  |
| Bit 6 | Master Status Summary |
| Bit 7 | 0                     |

For additional information, see the \*SRE command, and see Appendix B.

Example:

```
>*STB? Requests the Status Byte register status.
33 Indicates that the ESB and EAV bits are
 set.
```

**\*TRG**

Trigger      command only

The \*TRG command executes a device trigger, causing the INTERCEPTOR 132A to clear all results. This command is similar to the RESULT:CLEAR command.

**\*TST?**

Self-Test query only

Use the \*TST? query to find out whether the INTERCEPTOR 132A passed or failed its last self-test. The INTERCEPTOR 132A performs a self-test when powered on. The \*TST? query does not cause a self-test to be performed. A response to a \*TST? query of "0" indicates that no problems were encountered during the self-test. A response of "1" indicates that a problem occurred during the self-test. Possible problems identified by the self-test are ROM failure, RAM failure, and NOVRAM loss.

Example:

```
>*TST? Requests the self-test status.
0 Self-test was successful.
```

**\*WAI**

Wait command only

The \*WAI command causes all previous commands to complete before executing any other commands or queries.

**NOTE:** The INTERCEPTOR 132A executes all commands serially. Therefore, the \*WAI command is not necessary.

Example:

```
>SET:TMOD 64K; *WAI; SET:FRM AUTO<term>
Causes all commands previous to
the *WAI command to execute
before starting the commands after
*WAI.
```

**6.3.3 Status Commands and Queries**

**STATUS:ALRM?**

Status: Alarm query only

The STATUS:ALRM? query requests the current contents of the Alarm register. The value returned is the bit weights of all the set bits at the time the byte was read.

The bits of the Alarm register include:

- Bit 0     AIS
- Bit 1     TS-16 AIS
- Bit 2     FAS Distant
- Bit 3     MFAS Distant
- Bit 4     0
- Bit 5     0
- Bit 6     0
- Bit 7     0

The act of reading the contents of the register sets Bit 1 of the Test Summary register.

Example:

```
>STATUS:ALRM? Returns an integer indicating
 the status of the Alarm register.
12 A FAS Distant alarm and
 MFAS (TS16) Distant alarm
 are being received.
```

**STATUS:ALRM\_EN [<mask> | ?]**

Alarm Enable command/query

The STATUS:ALRM\_EN command is used to activate the alarms indicated by a "1" in the mask. The mask is a number that is the decimal equivalent of the binary number in the register (where Bit 7 is the Most Significant Bit). To enable a given alarm, specify a number that places a "1" in that alarm's bit position.



The act of reading the Line Register sets Bit 0 of the Test Summary register.

Example:

```
>STATUS:LINE? Reads the Line register.
11 The value 11 (=1+2+8)
 indicates that signal
 presence, FAS sync, and
 pattern sync are detected.
```

#### STATUS:LINE\_EN [<mask> | ?]

Status: Line Enable Register                      command/query

The STATUS:LINE\_EN command is used to activate the lines indicated by a "1" in the mask. The mask is a number that is the decimal equivalent of the binary number in the register (Bit 7 is the Most Significant Bit). To enable a given line, specify a number that places a "1" in that line's bit position.

The Line Enable Register contains a mask value for the bits to be enabled in the Line History register.

The act of reading the Line Enable Register sets bit 0 of the Test Summary register.

For additional information, see Appendix B.

The bits read include:

|       |                |
|-------|----------------|
| Bit 0 | Signal Present |
| Bit 1 | FAS Sync       |
| Bit 2 | MFAS Sync      |
| Bit 3 | Pattern Sync   |
| Bit 4 | Pattern Invert |
| Bit 5 | CRC            |
| Bit 6 | 0              |
| Bit 7 | Pattern Slip   |

#### STATUS:LINE\_HIST?

Status: Line History Register                      query only

The response to the STATUS:LINE\_HIST? query is a bit-weighted value indicating which bits are high in the Line History register. Bits 0 through 5 are set when the corresponding bits in the Line Register transition from 1 to 0 (indicating a loss of synchronization). Bit 7 is set when a pattern slip occurs. A non-zero value in this register indicates that a problem occurred since the last time the register was read.

Reading the register resets all bits to 0, and sets Bit 0 of the Test Summary register.

The bits read include:

|       |                |
|-------|----------------|
| Bit 0 | Signal Present |
| Bit 1 | FAS Sync       |
| Bit 2 | MFAS Sync      |
| Bit 3 | Pattern Sync   |
| Bit 4 | 0              |
| Bit 5 | 0              |
| Bit 6 | 0              |
| Bit 7 | Pattern Slip   |

Example:

```
>STATUS:LINE_HIST? Reads the Line History
 register.
11 The value 11 (=8+2+1)
 indicates that the
 INTERCEPTOR 132A
 has lost pattern sync,
 FAS Sync, and signal
 presence since the
 register was last read.
```



**STATUS:PRINT?**

Status: Print query only

The STATUS:PRINT? query gets the most recent Print that was stored in the remote control buffer. (You can use the \*STB command to determine if Bit 1 of Status Byte is set to indicate that there is a Print in the remote control buffer.) The example below shows a typical sequence of commands for use in viewing Prints. (For more information, see the commands included in the example, and the STATUS:CLEAR\_PR and SYSTEM:RC\_PRINT commands, and Appendix B.)

Example:

```
>SYSTEM:RC_PRINT ON
 Enables the remote control
 Print Buffer.

>MISC:PRT:CTRL Causes a Controls Print to be
 created and stored in the remote
 control buffer.

>*STB Requests the value of the Status
 Byte.

2 This response indicates that
 there is a Print in the remote
 control buffer.

>STATUS:PRINT? Requests that the most recent
 Print stored in the remote
 control Print Buffer be
 displayed on the remote
 controller's monitor.
```

**STATUS:TEST?**

Status: Test Summary Register query only

The response to the STATUS:TEST? query is a bit-weighted value indicating the contents of the Test Summary register. (The bits of the Test Summary register are set according to the corresponding bits in the Line Status Summary and Alarm Status registers.)

When one or more bits of the Test Summary Register is set, Bit 2 of the Status Byte register is set. For more information, see Appendix B.)

The bits of the Test Summary register include:

|       |                      |
|-------|----------------------|
| Bit 0 | Line Status Summary  |
| Bit 1 | Alarm Status Summary |
| Bit 2 | 0                    |
| Bit 3 | 0                    |
| Bit 4 | 0                    |
| Bit 5 | 0                    |
| Bit 6 | 0                    |
| Bit 7 | 0                    |

Example:

```
>STATUS:TEST? Read the Test Summary
 register.

2 The AIS Alarm Summary bit is
 set high.
```

**STATUS:TEST\_EN [<mask> | ?]**

Status: Test Summary Enable Register command/query

The STATUS:TEST\_EN command sets the Test Summary Enable register bits. The STATUS:TEST\_EN command is used to activate the lines indicated by a "1" in the mask. The mask is a number that is the decimal equivalent of the binary number in the register (where Bit 7 is the Most Significant Bit). To enable a given line, specify a number that places a "1" in the appropriate bit position.

When a bit of the Test Summary register is set and its corresponding bit in the Test Summary Enable register is also set, the Test Summary Status bit (Bit 2) of the Status Byte register is set.

The bits in the Test Summary Enable register include:

|       |                      |
|-------|----------------------|
| Bit 0 | Line Status Summary  |
| Bit 1 | Alarm Status Summary |
| Bit 2 | 0                    |
| Bit 3 | 0                    |
| Bit 4 | 0                    |
| Bit 5 | 0                    |
| Bit 6 | 0                    |
| Bit 7 | 0                    |

The STATUS:TEST\_EN? query requests the contents of the Test Summary Enable register. The STATUS:ALRM\_EN? query responds with an integer indicating which alarms are activated. Reads the currently enabled condition.

#### SYSTEM:RC\_PRINT [ON | OFF]

System: Remote Control Print Buffer command only

The SYSTEM:RC\_PRINT command turns the remote control Print Buffer on or off. If the Print Buffer is off, you cannot send information to it.

Example:

```
>SYSTEM:RC_PRINT ON Enables printing to
 the remote control
 Print Buffer.
```

### 6.3.4 Setup Commands and Queries

#### SET:2MREF [BRG | TRM | MON | ?]

Set the 2M Reference Input. command/query

This command is available only if Option 132A-1 is installed.

#### SET:64K:RX [<timeslot> | ?]

Set the 64 kbit/s Receive Timeslot. command/query

#### SET:64K:TX [<timeslot> | ?]

Set the 64 kbit/s Transmit Timeslot. command/query

#### SET:ABCD [“<4-bit string>” | ?]

Set the ABCD (signaling) Bits. command/query

Use this command to specify the values of the ABCD (or signaling) bits in the transmitted signal. (Also see SET:IABCD.)

Example:

```
>SET:ABCD "1010" Sets the signaling bits to 1010.
>SET:ABCD? Requests the current setting of
 the signaling bits.
"1010" The signaling bits are set to
 1010.
```

#### SET:ADJF [3 | 2 | 1 | ?]

Set the number of Adjacent FAS Errors. command/query

#### SET:AUPR:[OFF | TIMED | EVENT | ?]

Set the auto print function. command/query

#### SET:BEEP [ON | OFF | ?]

Set the beeper. command/query

#### SET:CBITS [“<15-bit string>” | ?]

Set the 15-bit C-Bit string. command/query

#### SET:CHRT:[NORM | REST | ?]

Set the channel rate. command/query

#### SET:CODE\_RATE:[1E-3 | 5E-3 | ?]

Set the error insertion rate for code errors. command/query

#### SET:DATE [“<DD/MMM/YYYY>”]

Set the date. command only

Example:

```
>SET:DATE "02/JAN/1995" Sets the date to be
 the second day of
 January 1995.
```

**SET:ERRT:[LOGIC | CODE | FAS | ?]**

Set the error type. command/query

**SET:EVPR:ALR [ON | OFF | ?]**

Set the Events Print Alarms trigger. command/query

**SET:EVPR:FRM [ON | OFF | ?]**

Set the Events Print Framing trigger. command/query

**SET:EVPR:LOG [ON | OFF | ?]**

Set the Events Print Logic trigger. command/query

**SET:EVPR:SIG [ON | OFF | ?]**

Set the Events Print Signaling trigger. command/query

**SET:FASERR [BIT | WORD | ?]**

Set FAS Error. command/query

**SET:FRMG****[AUTO|MFASC|MFAS|IFASC|IFAS|IUNFR | ?]**

Set: Framing. command/query

**SET:HSTB [ON|OFF|CLEAR | ?]**

Set Histogram Buffer. command/query

**SET:HSTC**

Clear the histogram buffer. command only

**SET:HSTF?**

Request how full the histogram buffer is. query only

Example:

**>SET:HSTF?** Requests how full the histogram buffer is.

54 The histogram buffer is 54% full.

**SET:HSTL ["<DD/HH:MM>" | "AUTO" | "END" | ?]**

Set the histogram length. command/query

Used to set (or request) the histogram's length. You can specify the amount of time, specifying values for the day, hour, and minute, as follows:

DD 00 to 99

HH 00 to 23

MM 00 to 59

For more information (and a complete example), see the SET:HSTM and SET:HSTS commands.

**SET:HSTM [AUTO | MAN | ?]**

Set the histogram mode. command/query

Used to set (or request) the histogram mode, which may be automatic (AUTO) or manual (MAN). When set to AUTO, you cannot use the SET:HSTL command until after you enter the SET:HSTM MAN command. When set to MAN, you can use the SET:HSTL command to set the length of the histogram.

Example:

**>SET:HSTM?**

Requests the current setting.

AUTO

The current mode is AUTO.

**>SET:HSTM MAN**

Sets the mode to manual so that the length can be set using the SET:HSTL command.

**>SET:HSTL "02/23:09"**

Sets the histogram length to be 2 days, 23 hours, and 9 minutes long.

**>SET:HSTL?**

Requests the histogram length.

"02/23:09"

The histogram length is 2 days, 23 hours, and 9 minutes.

**SET:HSTP[?]**

Set the Histogram Print. query only

Use the SET:HSTP? query to find out whether or not there is a histogram in the Print Buffer. If there is a histogram in the Print Buffer, the request triggers the printout.

**SET:HSTR [SIG\_LOSS | FAS\_LOSS | MFAS\_LOSS | PATT\_LOSS | AISI TS16\_AISI | FAS\_DIST | MFAS\_DIST | PATT\_SLIP | BIT\_ERRS | CODE\_ERRS | FAS\_ERRS | MFAS\_ERRS | CRC4\_ERRS | UNAVL\_SEC | ERR\_SEC | SES | ALL | ?]**

Set the histogram results. command/query

**SET:HSTS ["<DD/HH:MM>" | ?]**

Set the histogram start time. command/query

Used to set (or request) the histogram's start time.

The values used in the length parameter may be as follows:

DD 00 to 99

HH 00 to 23

MM 00 to 59

The start time is relative to the time the histogram buffer was turned on. For example, if the histogram buffer is turned on today at 2:00 pm, and you want the Histogram Print to contain that portion of the histogram starting at 3:15 pm tomorrow, DD/HH:MM would be 01/01:15. Therefore, you must know when the histogram buffer was turned on. (Often, the start time is the same as the buffer turn-on time. In that case, the start time is 00/00:00.)

Example:

**>SET:HSTS "01/01:15"** Tells the INTERCEPTOR 132A that the histogram portion to be eventually printed is to be that portion that begins one day and one hour and fifteen minutes after the histogram buffer was turned on.

**>SET:HSTS?** Requests the histogram start time.

"01/01:15" The histogram's start time is one hour and fifteen minutes after the histogram buffer was turned on.

**SET:HSTT [GRAPH | LIST | ?]**

Set the histogram type. command/query

**SET:IABCD ["<4-bit string>" | ?]**

Set the transmit idle ABCD bits. command/query

(See also SET:ABCD.)

**SET:LOGIC\_RATE [1E-3 | 5E-3 | ?]**

Set the error insertion rate for logic errors. command/query

**SET:LPBACK [OFF | CBITS | SA6BITS | ?]**

Select the ISDN loopback code. command/query

**SET:LPBACK\_PGM ["<4-bit string>" | ?]**

Set the loopback programmable 4-bit code. command/query

**SET:MEMCLR**

Memory Clear. command only

**SET:Mx64K:RX** [**"<32-bit string>"** | **?**]

Set the non-adjacent receive timeslots to be selected or not selected. command/query

Used to indicate which receive timeslots are selected. A selected timeslot is indicated by a "1"; a non-selected timeslot is indicated by a "0." The 32-bit string represents timeslots 0 through 31.

Example:

```
>SET:Mx64K:RX"001011000000000000000000000000"
 Sets Timeslots 2, 4, and 5 to be
 active.
```

**SET:Mx64K:TX** [**"<32-bit string>"** | **?**]

Set the non-adjacent transmit timeslots to be selected or not selected. command/query

Used to indicate which transmit timeslots are selected. A selected timeslot is indicated by a "1"; a non-selected timeslot is indicated by a "0." The 32-bit string represents timeslots 0 through 31.

**SET:Nx64K:RX** [**<start timeslot>**, **<number of timeslots>** | **?**]

Set adjacent receive timeslots to be selected. command/query

Used to indicate which receive timeslots (0 through 31) are selected. In **<start timeslot>**, enter the number of the first selected timeslot. In **<number of timeslots>**, enter the total number of selected timeslots. (The overall rate equals the rate for one of the timeslots times the number of timeslots selected. To set the individual timeslot rate, see SET:CHRT.)

Example:

```
>SET:Nx64K:RX 3,3
 Selects receive timeslots 3,
 4, and 5.
```

**SET:Nx64K:TX** [**<start timeslot>**, **<number of timeslots>** | **?**]

Set adjacent transmit timeslots to be selected. command/query

Used to indicate which transmit timeslots are selected. The timeslots are numbered 0 through 31. In **<start timeslot>**, enter the number of the first selected timeslot. In **<number of timeslots>**, enter the total number of selected timeslots. (The overall rate equals the rate for one of the timeslots times the number of timeslots selected. To set the individual timeslot rate, see SET:CHRT.)

Example:

```
>SET:Nx64K TX?
 Requests selected transmit
 timeslots.
4,2
 Timeslots 4 and 5 are
 selected.
```

**SET:PATT** [**AUTO** | **MARK** | **SPACE** | **1:1** | **1:3** | **1:4** | **2^6** | **2^9** | **2^11** | **2^15** | **2^20** | **2^23** | **QRSS** | **TSBYTE** | **PRGM** | **DELAY** | **?**]

Set Pattern. command/query

**SET:PERF** [**M2100** | **G821** | **?**]

Select performance measurement type. command/query

**SET:PGRC** **<number>**

Program Recall. command only

**SET:PGST** **<number>**

Program Store command only

**SET:PORT** ["<baud, parity, data bits>" | ?]  
Set the RS232 port configuration. command/query

The following values may be used.

Baud 300, 1200, 2400, 4800, 9600

Parity N (no parity), E (even parity), or O (odd parity)

Data Bits 7 or 8

Example:

>**SET:PORT** "2400,E,8" Sets the port's configuration.

**SET:PRGPAT** ["<-1- to 24-bit string>" | ?]  
Set the programmable pattern. command/query

**SET:PTHRU** [ON | OFF | ?]  
Set Pass-Through. command/query

**SET:REBE** [ON | OFF | ?]  
Set Remote End Block Errors. command/query

**SET:RSPR** [SUM | STD | ?]  
Set Result Print. command/query

**SET:SA6\_LPBACK** [IDLE | 2M\_NPTM | 2M\_LEPM | 2M\_PROG | ?]  
Select the ISDN Sa6 bits loopback code. command/query

**SET:SUBCH** [1 | 2 | 3 | 4 | ?]  
Select the 16K subchannel within a 64K timeslot. command/query

**SET:SYNTH** [50 to 2048000 | ?]  
Set the synthesizer rate. command/query

**SET:TERM** [CRLF | LF | CR | ?]  
Set Terminator. command/query

**NOTE:** When entering this command, you must terminate the command with the previously-selected termination character.

**SET:TIME** ["<HH:MM>"]  
Set Time. command only

Specify the time in the format shown, using a 24-hour clock.

Example:

>**SET:TIME** "23:59" Sets the time to be one minute before midnight.

**SET:TMINT** ["<HH:MM>" | ?]  
Set Time Interval (for TIMED Prints). command/query

**SET:TMOD** [2048K | VOICE | 64K | Nx64K | Mx64K | ?]  
Set Test Mode. command/query

**SET:TMSL\_CPLNG** [ON | OFF | ?]  
Set Timeslot Coupling. command/query

**SET:TSBYTE** ["<8-bit string>" | ?]  
Set Timeslot Byte (when pattern is TSBYTE). command/query

**SET:TSIDL** ["<8-bit string>" | ?]  
Set Timeslot Idle. command/query

**SET:TX** [ON | OFF | ?]  
Set Transmitter. command/query

Used to turn the 2 Mbit/s Transmitter on or off (to conserve power).

**SET:TXAL:AIS** [ON | OFF | ?]  
Set Transmit Alarm AIS. command/query

**SET:TXAL:FAS** [ON | OFF | ?]  
Set Transmit Alarm FAS. command/query

**SET:TXAL:MFAS [ON | OFF | ?]**

Set Transmit Alarm MFAS. command/query

**SET:TXCLK [INT | REC | PPM-50 | PPM+100 | PPM-100 | PPM+50 | 2MREF | ?]**

Set Transmit Clock. command/query

(NOTE: The PPM and 2MREF selections are valid only if Option 132A-1 is installed.)

**SET:TXCOD [AMI | HDB3 | ?]**

Set Transmit Coding. command/query

**SET:TXMFAS ["<4-bit string> " ]**

Set Transmit MFAS Word. command/query

**SET:TXNFAS ["<8-bit string>"]**

Set Transmit NFAS Word. command/query

**SET:VF\_FREQ [300 to 3000 | ?]**

Set the transmitted VF frequency. command/query

**SET:VF\_LEVEL [-20.0 to +3.0 | ?]**

Set the transmitted VF level. command/query

**6.3.5 Result Commands and Queries****RES:%AVL\_SEC?**

Results: Percentage of Available Seconds query only

Short form: RES:%AVLS?

Not Ready Value: -1.00

**RES:%DEG\_MIN?**

Results: Percentage Degraded Minutes query only

Short form: RES:%DEGM?

Not Ready Value: -1.00

**RES:%EFS?**

Results: Percentage of Error-Free Seconds query only

Not Ready Value: -1.00

**RES:%SES?**

Results: Percentage of Severely Errored Seconds query only

Not Ready Value: -1.00

**RES:2\_%EFS?**

Results: Percentage of M.2100 Error-Free Seconds query only

**RES:2\_%AV\_T?**

Results: Percentage of Available Time query only

NOTE: Only valid in M2100 performance.

**RES:2\_%EFS?**

Results: Percentage of Error-Free Seconds query only

NOTE: Only valid in M2100 performance.

**RES:2\_%SES?**

Results: Percentage of Severely Errored Seconds query only

NOTE: Only valid in M2100 performance.

**RES:2\_AV\_T?**

Results: Available Time (in seconds) query only

NOTE: Only valid in M2100 performance.

**RES:2\_EFS?**

Results: Error-Free Seconds query only

NOTE: Only valid in M2100 performance.

**RES:2\_ES?**

Results: Errored Seconds query only

NOTE: Only valid in M2100 performance.

**RES:2\_SES?**

Results: Severely Errored Seconds query only

**NOTE:** Only valid in M2100 performance.**RES:2\_UNA\_T?**

Results: Unavailable Time (in seconds) query only

**NOTE:** Only valid in M2100 performance.**RES:2M\_FREQ?**

Results: 2 Mbit/s Signal Frequency query only

Short form: **RES:2MFREQ?**

Not Ready Value: -1

**RES:2M\_FREQ\_PPM?**

Results: 2 Mbit/s Frequency Delta ppm. query only

Short form: **RES:2MFRQP?**

Not Ready Value: +0

**RES:2M\_LEVEL\_DBNOM?**

Results: 2 Mbit/s Level dB nominal query only

Short form: **RES:2MLVLD?**

Not Ready Value: -99.9

**RES:2M\_LEVEL\_VPEAK?**

Results: 2 Mbit/s Level Voltage Peak query only

Short form: **RES:2MLVLV?**

Not Ready Value: -1.00

**RES:ABCD? <timeslot>**

Request the ABCD bits. query only

Returns the value of the four signaling bits (ABCD bits).

Not Ready Value: "NOT READY"

**RES:ACTIVE\_TIMESLOTS?**

Results: Active Timeslots query only

Response is a string of characters indicating which timeslots are active. For more information, see "Active Timeslots." (Also see the RES:TIMESLOT command.)

Short form: **RES:ATMSL?**

Not Ready Value: "NOT READY"

Example:

**>RES:ATMSL?** Asks which timeslots are active.**"F..34.....12.....567..01"**

Timeslot 0 contains the FAS Word; MFAS is not being used; and Timeslots 3, 4, 11, 12, 25, 26, 27, 30, and 31 are active. Note that only the last digit of the timeslot number is shown (for example, Timeslot 25 appears as a 5 and Timeslot 31 appears as a 1), and the timeslots are in listed in sequence (0 through 31).

**>RES:TMSL 25** Announces that timeslot 25 will be the timeslot to view.**>RES:TMSL?** Requests the values for the timeslot.**"10111001"** Timeslot 25 contains the indicated values.**RES:AVL\_SEC?**

Results: Available Seconds query only

Short form: **RES:AVLS?**

Not Ready Value: -1

**RES:BER?**

Results: Bit Error Rate query only

Not Ready Value: **-1.0E+0**



**RES:BER\_SES?**

Results: Bit Error Rate Minus SES bit errors query only

Short form: **RES:BSSES?**Not Ready Value: **-1.0E + 0****RES:BIT\_ERRS?**

Results: Bit Errors query only

Short form: **RES:BTERR?**Not Ready Value: **-1****RES:BIT\_SLIP?**

Results: Bit Slips query only

Short form: **RES:BITS?**Not Ready Value: **-1**No Reference **-0**

The "No Reference" value indicates that the information cannot be supplied because the required external 2 Mbit/s reference signal is not available.

**RES:CBITS?**

Results: C-Bits string query only

**RES:CODE\_ERRS?**

Results: Code Errors query only

Short form: **RES:CDER?**Not Ready Value: **-1****RES:CODE\_RATE?**

Results: Code Error Rate query only

Short form: **RES:CDRT?**Not Ready Value: **-1.0E + 0****RES:CRC\_ERRS?**

Results: CRC Errors query only

Short form: **RES:CRER?**Not Ready Value: **-1****RES:CRC\_MF\_WORD?**

Results: MFAS Word query only

Short form: **RES:CMWD?**Not Ready Value: **"NOT READY"****RES:CRC\_RATE?**

Results: CRC Error Rate query only

Short form: **RES:CRRT?**Not Ready Value: **-1.0E + 0****RES:DATE?**

Results: Date query only

Not Ready Value: **"0 Jan, 0000"****RES:DEG\_MIN?**

Results: Degraded Minutes query only

Short form: **RES:DEGM?**Not Ready Value: **-1****RES:DISP:HOLD:[ON | OFF | ?]**

Display Hold command/query

Used to turn the Display Hold on or off (or to check the status of Display Hold). This remote control command has the same effect as that of pressing DISPLAY HOLD on the front panel of the test instrument.

**RES:EFS?**

Results: Error Free Seconds query only

Not Ready Value: **-1****RES:ELPSD\_SEC?**

Results: Elapsed Seconds query only

Short form: **RES:ELPS?**Not Ready Value: **-1****RES:ERR\_SEC?**

Results: Errored Seconds query only

Short form: **RES:ERRS?**Not Ready Value: **-1**

**RES:ERR\_SES?**

Results: Bit Errors Minus SES query only

Short form: **RES:ESES?**

Not Ready Value: -1

**RES:FAS\_ERRS?**

Results: FAS Errors query only

Short form: **RES:FSER?**

Not Ready Value: -1

**RES:FAS\_RATE?**

Results: FAS Error Rate query only

Short form: **RES:FSRT?**

Not Ready Value: -1.0E + 0

**RES:FAS\_WORD?**

Results: FAS Word query only

Short form: **RES:FSWD?**

Not Ready Value: "NOT READY"

**RES:FRAME\_SLIP?**

Results: Frame Slip query only

Short form: **RES:FSLP?**

Not Ready Value: +0

No Reference -0

The "No Reference" value indicates that the information cannot be supplied because the required external 2 Mbit/s reference signal is not available.

**RES:FREQ? <timeslot>**

Results: Frequency query only

Not Ready Value: -1

**RES:HELD:<result?>**

Results: Held Result query only

Returns the specified result using the information from the snapshot in the remote control buffer.

Example:

>**RES:HOLD** Saves all current results.>**RES:HELD:BER?** Requests the saved BER result.

1.5 E+4 The BER result was 1.5 x 104.

**RES:HIST:RESET**

History Reset command only

**RES:HOLD**

Results: Hold command only

Stores a snapshot of all results in the remote control buffer. For more information and a complete example, see the RES:HELD? query.

**RES:LEVEL\_DBM? <timeslot>**

Results: Level (in dBm) query only

Short form: **RES:LVL0? <timeslot>**

Not Ready Value: -99.9

**RES:MFAS\_ERRS?**

Results: MFAS Errors query only

Short form: **RES:MFER?**

Not Ready Value: -1

**RES:MFAS\_RATE?**

Results: MFAS Error Rate query only

Short form: **RES:MFRT?**

Not Ready Value: -1.0E + 0

**RES:MFAS\_WORD?**

Results: MFAS Word query only

Short form: **RES:MFWD?**

Not Ready Value: "NOT READY"

**RES:NFAS\_WORD?**

Results: NFAS Word query only

Used to obtain the Not FAS Word result. For more information, see NFAS Word in the SIGNAL, CODE & FAS category.

Short form: **RES:NFWD?**

Not Ready Value: "NOT READY"

**RES:PATT\_LOSS?**

Results: Pattern Loss query only

Short form: **RES:PATL?**

Not Ready Value: -1

**RES:PATT\_SLIP?**

Results: Pattern Slip query only

Short form: **RES:PATS?**

Not Ready Value: -1

**RES:PEAK? <timeslot>**

Results: PCM code peak query only

Not Ready Value: -999

**RES:RCV\_PAT?**

Results: Receive Pattern query only

Short form: **RES:RCVP?**

Not Ready Value: "NOT READY"

**RES:RESTART**

Results: Restart command only

**RES:RTD?**

Results: Round Trip Delay query only

**RES:RX\_BYTE? <timeslot>**

Results: Receive Byte query only

Short form: **RES:RXBT? <timeslot>**

Not Ready Value: "NOT READY"

**RES:SA6BITS?**

Results: Sa6 Bits string query only

**RES:SES?**

Results: Severely Errored Seconds query only

Not Ready Value: -1

**RES:TEST\_SEC?**

Results: Test Seconds query only

Short form: **RES:TSTS?**

Not Ready Value: -1

**RES:TIME?**

Results: Time query only

Used to obtain the current time setting (giving the hour, minute, and second in HH:MM:SS format).

Not Ready Value: "00:00:00"

**RES:TIMESLOT [ <timeslot | ? ]**

Results: Timeslot command and query

For information and a complete example, see the RES:ACTIVE\_TIMESLOTS command.

Short form: **RES:TMSL [<timeslot> | ?]****RES:UNAVL\_SEC?**

Results: Unavailable Seconds query only

Short form: **RES:UVLS?**

Not Ready Value: -1

### 6.3.6 Miscellaneous Commands and Queries

#### LOCAL

Local Control command only

Sets the INTERCEPTOR 132A to local control mode. (Enables all controls on the INTERCEPTOR 132A.)

#### LOCK[?]

Lock command/query

Completely disables the controls on the front panel of the test instrument — including PANEL LOCK. Therefore, the only way to unlock the front panel after sending this command is to send the UNLOCK command. This command is useful to prevent changes being made on the front panel while in remote control mode.

In the response to the query, a 0 indicates that the panel is not locked, and a 1 indicates that the panel is locked.

#### MISC:DISP:HOLD [ON | OFF | ?]

Miscellaneous: Display Hold command/query

#### MISC:ERRIN:RATE [ON | OFF | ?]

Miscellaneous: Error Insert Rate command/query

#### MISC:ERRIN:SNGL

Miscellaneous: Error Insert Single command only

#### MISC:HIST:RESET

Miscellaneous: History Reset command only

#### MISC:PRT:CLR[?]

Miscellaneous: Print Clear command/query

#### MISC:PRT:CTRL[?]

Miscellaneous: Print Controls command/query

#### MISC:PRT:RSLT[?]

Miscellaneous: Print Results command/query

#### MISC:RC\_MODE [TERM | COMP | ?]

Miscellaneous: Remote Control Mode command/query

#### MISC:RCV [M120| T120|B120| M75| T75|B75|?]

Miscellaneous: Receiver Input Mode command/query

#### MISC:SLFLP [ON | OFF | ?]

Miscellaneous: Self Loop command/query

#### MISC:VOL [<number> | ?]

Miscellaneous: Volume command only

Used to set (or check) the volume level of the speaker. To set the volume level, specify a number from 0 (to silence the speaker) to 9 (the loudest).

#### REMOTE

Remote Control command only

Sets the test instrument to remote control. In remote control, all controls on the front panel of the test instrument are disabled except PANEL LOCK.

#### UNLOCK

Unlock command only

Enables the PANEL LOCK control. (See the LOCK command.)

## 6.4 ERROR MESSAGES

If a remote control command or query is typed incorrectly, the INTERCEPTOR 132A responds with an error message. The error messages that the INTERCEPTOR 132A can send are listed below alphabetically with a description of the error message. When you receive one of these messages, check the last command you entered and be sure to enter it correctly.

### 2M Reference Input Option Not Installed.

This error message is caused by requesting the bit slips results when Option 132A-1 is not installed. You may receive this message in response when you send the following query: `res:bits?`

### Argument out of Range.

This error message is caused by sending a value that is invalid for the associated register. You may receive this message in response when you send the following commands: `*ese`, `*sre`, `status:line_en`, `status:alm_en`, `status:test_en`.

### Bitstring Too Long.

This error message is caused by sending a bit string with too many bits (for example, sending 9 bits instead of sending 8 bits). You may receive this message in response when you send one of the SET: commands.

### Bitstring Too Short.

This error message is caused by sending a bit string with too few bits (for example, sending 3 bits instead of sending 8 bits). You may receive this message in response when you send one of the SET: commands.

### Cannot Set Length - Auto Mode Enabled.

This error message is caused by sending a length value when length is set to AUTO. You may receive this message in response when you send the following command: `set:hstl`.

### Incorrectly Formed Histogram Length.

This error message is caused by sending a histogram length that is not in the "DD/HH:MM" format. You may receive this message in response when you send the following command: `set:hstl`.

### Incorrectly Formed Histogram Start Time.

This error message is caused by sending a Histogram Start Time that is not in the "DD/HH:MM" format. You may receive this message in response when you send the following commands: `set:hsts`.

### Invalid Bit String.

This error message is caused by sending a bit string that contains characters other than binary (for example, sending 12345678 instead of 10110110). You may receive this message in response when you send one of the SET: commands.

### Invalid Date String.

This error message is caused by sending a date parameter that is not in the proper format. You may receive this message in response when you send the following command: `set:date`.

### Invalid HH:MM Time String.

This error message is caused by sending a time that is not between 00:00 and 23:59 (inclusive). You may receive this message in response when you send the following commands: `set:time` and `set:tmint`.

### Invalid Value.

This error message is caused by sending a value that is invalid for the associated register. You may receive this message in response when you send one of the SET: commands.

**Length Must Be > 0.**

This error message is caused by requesting a Histogram Print when the length value is 0. You may receive this message in response when you send the following command: `misc:prt:hist?`

**No Memory For Print Request.**

This error message is caused by requesting a Histogram Print when there is no space available in the Print Buffer. You may receive this message in response when you send the following query: `misc:prt:hist?`

**No Such Event During Specified Time.**

This error message is caused by requesting a Histogram Print when the selected histogram result has not occurred within the specified time. You may receive this message in response when you send the following query: `misc:prt:hist?`

**Print Buffer Is Empty.**

This error message is caused by requesting a Histogram Print when no Prints are pending. You may receive this message in response when you send the following query: `status:print?`

**Program Number Out of Range.**

This error message is caused by sending a program number that is not between 0 and 9. You may receive this message in response when you send the following commands: `set:pgst`, `*rcl`, and `set:pgrc`.

**Request Invalid In This Setup.**

This error message is caused by sending a configuration command that is invalid for the current setup. You may receive this message in response when you send one of the SET: commands.

**Result Not Available.**

This error message is caused by requesting a result value before it is available. You may receive this message in response when you send one of the RES: commands.

**Save Number Out of Range.**

This error message is caused by sending a save number that is not between 0 and 9. You may receive this message in response when you send the following command: `*sav`.

**Start Time Must Be <= Elapsed Time.**

This error message is caused by requesting a Histogram Print when the start time is greater than the elapsed time. You may receive this message in response when you send the following query: `misc:prt:hist?`

**Start Time Must Be <= Stored Time.**

This error message is caused by requesting a Histogram Print when the start time is greater than the stored time. You may receive this message in response when you send the following query: `misc:prt:hist?`

**Timeslot out of range.**

This error message is caused by sending a timeslot value that is not within the range for the selected configuration. You may receive this message in response when you send the following queries: `res:rxbt?`, `res:abcd?`, `res:freq?`, `res:peak?`, and `res:lvl0?` This error message may also be sent in response to the following commands: `set:64k:rx`, `set:64k:tx`, `set:nx64k:rx`, and `set:nx64k:tx`.

**Unrecognized 2M Reference.**

This error message is caused by sending an invalid 2M reference parameter. You may receive this message in response when you send the following command: `set:2mref`.

**Unrecognized Alarm State.**

This error message is caused by sending an invalid alarm state parameter. You may receive this message in response when you send the following command: `set:txal`.

**Unrecognized Auto Print.**

This error message is caused by sending an invalid auto print parameter. You may receive this message in response when you send the following command: `set:aupr`.

**Unrecognized Channel Rate.**

This error message is caused by sending an invalid channel rate parameter. You may receive this message in response when you send the following command: `set:chrt`.

**Unrecognized Display Hold State.**

This error message is caused by sending an invalid display hold state parameter. You may receive this message in response when you send the following command: `misc:disp:hold`.

**Unrecognized Error Insert State.**

This error message is caused by sending an invalid error state parameter. You may receive this message in response when you send the following command: `misc:errin:rate`.

**Unrecognized Error Type.**

This error message is caused by sending an invalid error type parameter. You may receive this message in response when you send the following command: `set:errt`.

**Unrecognized Event Print State.**

This error message is caused by sending an invalid event print state parameter. You may receive this message in response when you send the following command: `set:evpr`.

**Unrecognized Framing State.**

This error message is caused by sending an invalid framing state parameter. You may receive this message in response when you send the following command: `set:frmg`.

**Unrecognized Histogram Buffer Action.**

This error message is caused by sending an invalid histogram buffer action parameter. You may receive this message in response when you send the following command: `set:hstb`.

**Unrecognized Histogram Results.**

This error message is caused by sending an invalid histogram result parameter. You may receive this message in response when you send the following command: `set:hstr`.

**Unrecognized Histogram Type.**

This error message is caused by sending an invalid histogram type parameter. You may receive this message in response when you send the following command: `set:hstt`.

**Unrecognized Pass Through Mode.**

This error message is caused by sending an invalid pass-through mode parameter. You may receive this message in response when you send the following command: `set:pthru`.

**Unrecognized Pattern.**

This error message is caused by sending an invalid pattern parameter. You may receive this message in response when you send the following command: `set:patt`.

**Unrecognized Port Configuration.**

This error message is caused by sending an invalid port configuration parameter. You may receive this message in response when you send the following command: `set:port`.

**Unrecognized Receive Mode.**

This error message is caused by sending an invalid receive mode parameter. You may receive this message in response when you send the following command: `misc:rcv`.

**Unrecognized Remote Control Mode.**

This error message is caused by sending an invalid remote control mode parameter. You may receive this message in response when you send the following command: `misc:rcmode`.

**Unrecognized Result Print.**

This error message is caused by sending an invalid result print parameter. You may receive this message in response when you send the following command: `set:rspr`.

**Unrecognized Self Loop State.**

This error message is caused by sending an invalid self loop state parameter. You may receive this message in response when you send the following command: `misc:slflp`.

**Unrecognized Terminal Type.**

This error message is caused by sending an invalid terminal type parameter. You may receive this message in response when you send the following command: `set:term`.

**Unrecognized Test Mode.**

This error message is caused by sending an invalid test mode parameter. You may receive this message in response when you send the following command: `set:tmod`.

**Unrecognized Timeslot Coupling State.**

This error message is caused by sending an invalid timeslot coupling state parameter. You may receive this message in response when you send the following command: `set:tmsl_cplng`.

**Unrecognized Transmitter State.**

This error message is caused by sending an invalid transmitter state parameter. You may receive this message in response when you send the following command: `set:tx`.

**Unrecognized Tx Clock.**

This error message is caused by sending an invalid transmit clock parameter. You may receive this message in response when you send the following command: `set:txclk`.

**Unrecognized Tx Coding.**

This error message is caused by sending an invalid transmit coding parameter. You may receive this message in response when you send the following command: `set:txcod`.

**Volume out of range.**

This error message is caused by sending an invalid volume range parameter. You may receive this message in response when you send the following command: `misc:vol`.



## APPLICATIONS

### 7.1 OVERVIEW

You can use the INTERCEPTOR 132A in a variety of testing applications for 2 Mbit/s signals. For a description of the various testing scenarios, how to set up for each testing situation, and how to interpret the test results, see the appropriate subsection that describes the appropriate 2 Mbit/s test.

### 7.2 IN-SERVICE MONITORING A 2048 KBIT/S CIRCUIT

The INTERCEPTOR 132A is an excellent tool for in-service (non-intrusive) testing of 2048 kbit/s links. The primary advantage of in-service testing is that the link under test does not have to be removed from service. This means that no unnecessary down time is incurred. In addition, data- or time-specific problems can be hard to isolate using out-of-service methods.

For an illustration of how to configure the INTERCEPTOR 132A to measure the overall performance of an in-service 2048 kbit/s link, see Figure 7-1. (The monitor point is shown between the Network Terminating Equipment and a Pulse Code Modulation Multiplexer.)

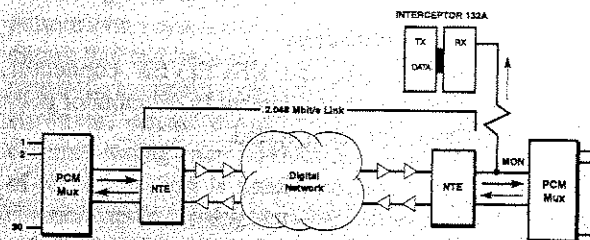

**Figure 7-1**  
In-Service Monitoring of a 2.048 Mbit/s Circuit

**Test Setup**

1. **Perform the Basic Setup Procedure.**  
Verify that the PANEL LOCK and SELF LOOP LEDs are off.
2. **TEST MODE category.**  
Since you will be performing full-bandwidth tests, set Test Mode to 2048K. (For VOICE monitoring, see Section 7.4.)
3. **CONFIGURATION category.**  
To maximize battery life, set Transmitter to OFF. Set Framing to the format used on the 2048 kbit/s link that you are testing (or set Framing to AUTO).
4. **AUXILIARY category.**  
If you are using a printer, set all printer-related setup items as desired. (For more information, see Section 5.) Check the Time and Date items to verify that they are set for the current time and date.
5. **RECEIVER control.**  
Press the RECEIVER control to select MON (for connection at a resistor-isolated monitor jack) or BRIDGE (for connection at a resistor-isolated monitor point), and to select 120Ω or 75Ω, as appropriate. (If the Receiver is set incorrectly, the test instrument can still appear to work correctly, but it is highly sensitive to data pattern, signal shape, noise, and other factors.)
6. **RECEIVER connector.**  
Using the selected RECEIVER connector, connect the test instrument to the monitor point of the circuit being tested.

**Test Results**

1. **Check the error results.**  
To analyze the performance of a 2048 kbit/s link (while it is in-service), you can check the circuit CRC-4 error results, frame (FAS and MFAS) error results, REBEs (Remote End Block Errors), or code error results. When available, CRC-4 error results provide a good indication of overall link performance. However, note that Digital Cross-connect Systems and Automatic Cross-connect Equipment (DCS/ACE) generally are considered terminals (source/sink devices) for 2048 kbit/s links. Thus, CRC-4 errors received on one 2048 kbit/s link are not passed through to other 2048 kbit/s links terminating on the same DCS/ACE.
2. **Check the STATUS & ALARMS LEDs.**  
Verify proper detection of signal, framing, pattern, and absence of alarms.
3. **Check for timing problems.**  
To check for timing problems, perform a bit slip/frame slip test (See Section 7.8).

### 7.3 OUT-OF-SERVICE TESTING A 2048 KBIT/S CIRCUIT

---

Out-of-service testing is performed by sending a test pattern over a new circuit at installation time or an existing circuit that has been taken out of service. Circuit down-time is the major disadvantage of out-of-service techniques. However, circuit down-time is not a problem when commissioning a new 2048 kbit/s circuit. In addition, out-of-service testing is sometimes used to find marginal components on existing links that cannot easily be identified using in-service techniques. Overall, out-of-service testing provides a more reliable and thorough analysis of circuit quality.

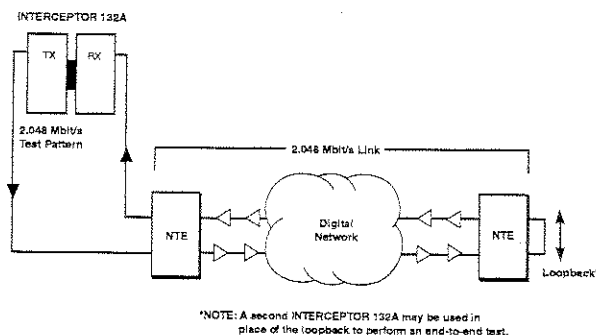

Figure 7-2  
Out-of-Service Testing of a 2048 kbit/s Circuit

### Test Setup

1. **Perform the Basic Setup Procedure.**  
Verify that the PANEL LOCK and SELF LOOP LEDs are off.
2. **Set Test Mode to 2048K.**
3. **Set CONFIGURATION category items.**  
Set Transmitter to ON.  
Set Framing to the format used by the circuit under test or set Framing to AUTO.  
Set Loopcodes to OFF (not performing loopback testing) or to the appropriate terminating equipment for the circuit under test (CBITS or SA6BITS).  
Set Tx Clock to INTERNAL (or INT 2048K if Option 147-1 is installed).  
Generally, set Pattern to a pseudorandom pattern, such as  $2^{15}-1$  or  $2^{23}-1$ . (These patterns are good choices because they simulate live traffic.)
4. **Set ALARM/SIGNAL category items.**  
Set each type of Tx Alarm to OFF (no alarms will be generated).

5. **Check AUXILIARY category items.**  
If you are using a printer, set all printer-related setup items as desired. (For more information, see Section 5). Check the Time and Date items to verify they are set for the current time and date.
6. **Set RECEIVER control to TERM.**  
Select TERM because you will be conducting an out-of-service test, and to select  $120\Omega$  or  $75\Omega$ , as appropriate.
7. **Connect to the RECEIVER connector.**  
Using the selected RECEIVER connector, connect the test instrument to the receive direction of the circuit that is being tested.
8. **Connect to the TRANSMITTER connector.**  
Using the appropriate TRANSMITTER connector, connect the test instrument to the transmit direction of the circuit that is being tested.

### Test Results

1. **Check the STATUS & ALARMS LEDs.**  
Verify proper detection of signal, framing, pattern, and absence of alarms.
2. **Check the SUMMARY Results category for evidence of error conditions.**
3. **Check G.821 performance results**  
In the PERFORMANCE Results category, the G.821 performance results provide an excellent means of verifying overall quality of the link under test.
4. **Print histograms and results information (if desired).**

## 7.4 ANALOG/DIGITAL TESTING OF A VOICE CHANNEL

You can use the INTERCEPTOR 132A on the digital (line) side of a PCM multiplexer (mux). First use a Voice Frequency (VF) test set to insert a test tone into the analog input of a voice channel card in the mux (as shown in Figure 7-3). Then use the INTERCEPTOR 132A to measure the level and frequency of that test tone as it is received. You can also use the INTERCEPTOR 132A's speaker to monitor the voice channel (with or without a test tone present) to identify severe noise problems.

When a noise or level problem is reported on a voice circuit, you can use the INTERCEPTOR 132A to help isolate the problem to a particular channel card in a PCM mux or to the 2048 kbit/s circuit itself.

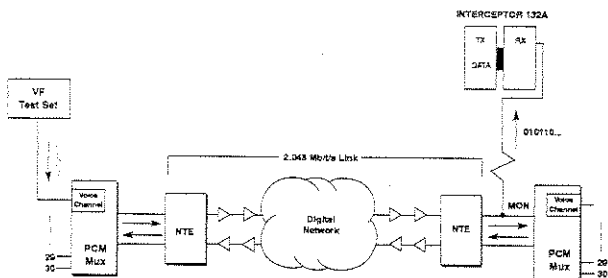

Figure 7-3  
A/D Testing of a Voice Channel

### Test Setup

1. **Perform the Basic Setup Procedure.**  
Verify that the PANEL LOCK and SELF LOOP LEDs are off.
2. **Set Test Mode to VOICE.**  
With this setting, the speaker is enabled.

3. **Set the CONFIGURATION category items.**  
Set Transmitter to OFF (this is a receive-only test). Set Framing to the format used by the link under test or set Framing to AUTO.
4. **Select the timeslot to be tested.**
5. **Check the AUXILIARY category items.**  
If you are using a printer, set all printer-related setup items as desired (refer to Section 5). Check the Time and Date items to verify they are set for the current time and date.
6. **Set RECEIVER control to MON or BRIDGE.**  
Press the RECEIVER control to select MON or BRIDGE mode as appropriate and to select 120Ω or 75Ω, as appropriate.
7. **Connect to the RECEIVER connector.**  
Using the selected RECEIVER connector, connect the test instrument to the monitor point of the circuit that is being tested.

### Test Results

1. **Check the STATUS & ALARMS LEDs.**  
Verify proper detection of signal, framing, pattern, and absence of alarms.
2. **Monitor the timeslot over the speaker.**  
(To specify the voice channel to be monitored, select a receive timeslot in the RxTS item in the TIMESLOTS Setup category or in the Timeslot item in the CHAN. & SIGNALING Results category.)
3. **Verify received frequency and signal level.**  
In the SIGNAL, CODE & FAS Results category, verify proper received frequency and signal level.

#### 4. Check Active Timeslots for live traffic.

In the CHAN. & SIGNALING Results category, check the Active Timeslots result to verify or identify the channels that contain live traffic. Also, for the selected timeslot(s), check the Rx Byte, ABCD, Freq (Hz), Peak, and Level (dBm) results.

### 7.5 TROUBLESHOOTING AN NX56 OR NX64 KBIT/S CIRCUIT

You can use the INTERCEPTOR 132A to isolate a fault on an Nx64 kbit/s (or Nx56 kbit/s) circuit. Simply take the suspected adjacent timeslots out of service, transmit an appropriate test pattern over the selected timeslots, and check the error results at various points along the circuit. As shown in Figure 7-4, the test pattern can be generated on the data (customer) side of an NTE by another INTERCEPTOR 132A. Note that while the data circuit under test must be taken out of service in this procedure, all other circuits on the 2048 kbit/s link remain in-service.

#### Test Setup

Use the following steps to set up the INTERCEPTOR 132A that is used for monitoring at the exchange.

1. **Perform the Basic Setup Procedure.**  
Verify that the PANEL LOCK and SELF LOOP LEDs are off.
2. **Set TEST MODE category items.**  
Set Test Mode to Nx64K.  
Set Channel to NORMAL or RESTRICTED, depending on the type of circuit under test (Nx64 or Nx56 kbit/s, respectively).

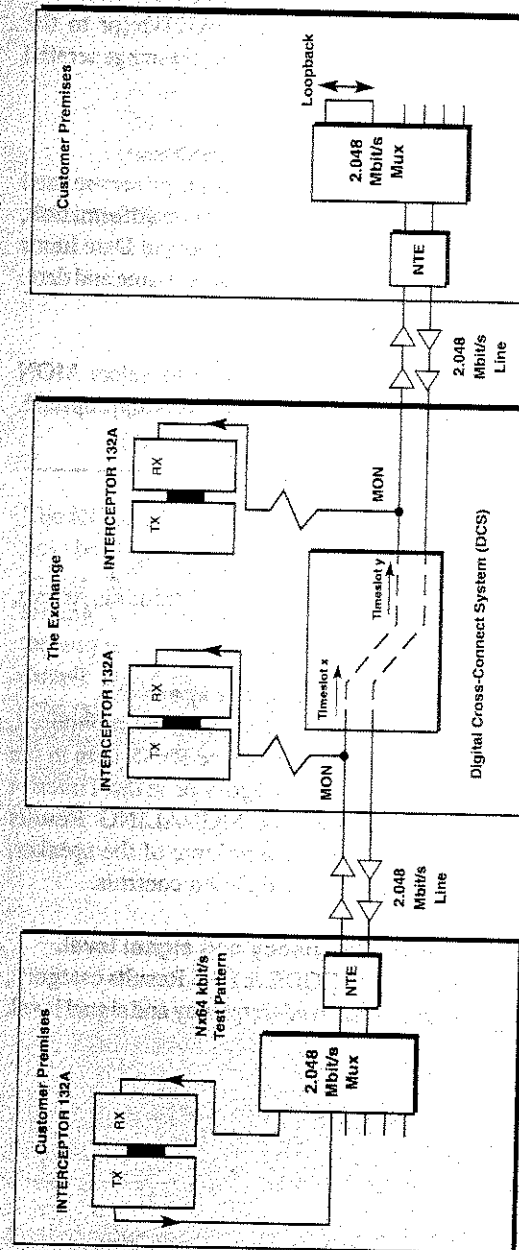

Figure 7-4  
Troubleshooting an Nx56 or Nx64 Kbit/s Circuit

- 3. **Set the CONFIGURATION category items.**  
To maximize battery life, set Transmitter to OFF. Set Pattern and Framing to AUTO (or to the specific test pattern and framing being generated by the data analyzer).
- 5. **Check AUXILIARY category items.**  
If you are using a printer, set all printer-related setup items as desired. (For more information, see Section 5). Check the Time and Date items to verify they are set for the current time and date.
- 6. **Set RECEIVER control to MON.**  
Press the RECEIVER control to select MON mode and to select 120Ω or 75Ω, as appropriate.

**Test Results**

- 1. **Check the STATUS & ALARMS LEDs.**  
Verify proper detection of signal, framing, pattern, and absence of alarms.
- 2. **Monitor the timeslot over the speaker.**  
To specify the voice channel to be monitored, select a receive timeslot in the RxTS item in the TIMESLOTS Setup category or in the Timeslot item in the CHAN. & SIGNALING Results category. To adjust the volume of the speaker, use the Volume Up and Down controls.
- 3. **Verify received frequency and signal level.**  
In the SIGNAL, CODE & FAS Results category, verify proper received frequency and signal level.

- 4. **Check Active Timeslots for live traffic.**  
In the CHAN. & SIGNALING Results category, check the Active Timeslots result to verify or identify the channels that contain live traffic. Also, for the selected timeslot(s), check the Rx Byte, ABCD, Freq (Hz), Peak, and Level (dBm) results.
- 5. **Verify the correct routing of timeslots.**  
Locate the channel containing the test pattern at each point you are monitoring.

**7.6 COMMISSIONING A CUSTOMER'S NX64K SERVICE**

The INTERCEPTOR 132A can be used to commission a new Nx64K service from the customer's premises, even before the 2048 kbit/s NTE is installed. Pre-service testing is performed using the basic out-of-service technique in which a test pattern is transmitted on the circuit under test and bit error counts or performance analysis results are used to gauge overall circuit performance. For a diagram of a typical test setup, see Figure 7-5.

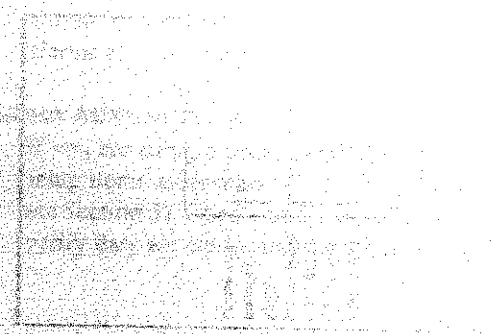

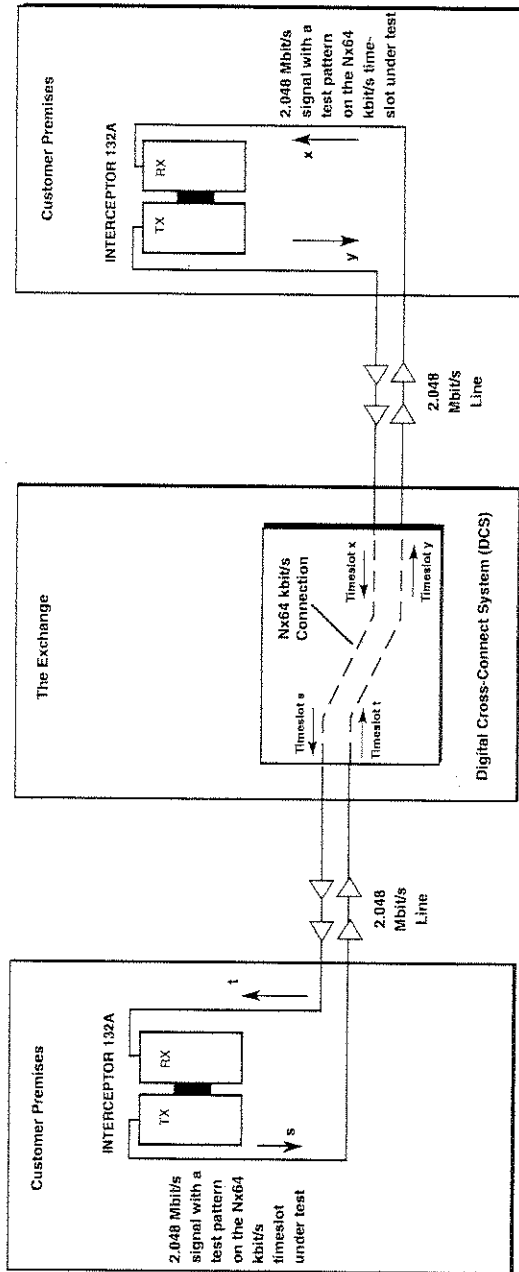

Figure 7-5  
Troubleshooting a Customer's Nx64K Service Test Setup

1. **Perform the Basic Setup Procedure.**  
Verify that the PANEL LOCK and SELF LOOP LEDs are off.
2. **Set TEST MODE category items.**  
Set Test Mode to Nx64 or Mx64, as appropriate. Set Channel to NORMAL or RESTRICTED, depending on the type of circuit under test (Nx64 or Nx56 kbit/s, respectively).
3. **Set the CONFIGURATION category items.**  
Set Transmitter to ON.  
Set Framing to the format used by the circuit under test when in service (or set Framing to AUTO).  
Set Loopcodes to OFF (not performing loopback BERT testing) or to the appropriate terminating equipment for the circuit under test (CBITS or SA6BITS).  
Set Tx Clock to INTERNAL (or INT 2048K if Option 147-1 is installed).  
Generally, set Pattern to a pseudorandom pattern, such as  $2^{15}-1$  or  $2^{23}-1$ . (These patterns are good choices because they simulate live traffic.)
4. **Select the timeslots to be tested.**  
If the timeslots used in the transmit and receive direction are not the same, then set Coupling to Tx≠Rx.
5. **Set ALARM/SIGNAL category items.**  
Set each type of Tx Alarm to OFF (so that no alarms are generated).
6. **Check AUXILIARY category items.**  
If you are using a printer, set all printer-related setup items as desired. (For more information, see Section 5). Check the Time and Date items to verify they are set for the current time and date.

7. **Set RECEIVER control to TERM.**  
This is an out-of-service test that requires cable equalization, and to select 120Ω or 75Ω, as appropriate.
8. **Connect to the RECEIVER connector.**  
Using the selected RECEIVER connector, connect the test instrument to the receive direction of the circuit that is being tested.
9. **TRANSMITTER connector.**  
Using the appropriate TRANSMITTER connector, connect the test instrument to the transmit direction of the circuit that is being tested.

### Test Results

1. **Check the STATUS & ALARMS LEDs.**  
Verify proper detection of signal, framing, pattern, and absence of alarms.
2. **Check the SUMMARY Results for any errors or events.**
3. **Check the G.821 or bit error results.**  
At the end of the circuit commissioning test period, record the bit error results or the G.821 performance analysis results as desired. Check the results to determine if they meet acceptable limits so that the circuit can be qualified.
4. **If desired, print histograms and results information.**

### 7.7 MONITORING 2048 KBIT/S CIRCUITS FROM DS3 ACCESS POINTS USING A T-BERD 305 OR T-BERD 310 ANALYZER

You can use the INTERCEPTOR 132A in conjunction with a TTCT T-BERD 305, or a T-BERD 310 DS3 Analyzer equipped with 2048 kbit/s drop capability, to monitor a 2048 kbit/s circuit from a DS3 (45 Mbit/s) signal access point. For example, when you are troubleshooting a 2048 kbit/s North America-to-Europe gateway circuit on the North American side, the INTERCEPTOR 132A (located at the DS3 monitor point) works with a second 2048 kbit/s test set (located at a 2048 kbit/s circuit input) to perform an out-of-service test. However, the INTERCEPTOR 132A can also be used to perform in-service tests on 2048 kbit/s circuits from DS3 monitor points. For a diagram of a typical test setup, see Figure 7-6.

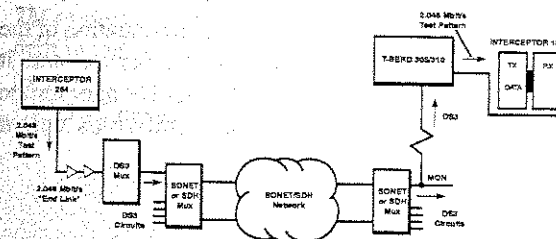

**Figure 7-6**  
Monitoring a 2 Mbit/s Circuit From a DS3 Access Point

**NOTE:** Use the instructions below to set up the receiving INTERCEPTOR 132A located at the DS3 monitor point. It is assumed that the transmitting 2048 kbit/s test set has been configured to generate a suitable test pattern, such as  $2^{15}-1$  or  $2^{23}-1$  and has been configured to use the framing mode normally used on the 2048 kbit/s circuit under test. It is also assumed that the T-BERD 305 or T-BERD 310 has been properly configured to drop the 2048 kbit/s circuit under test.



## Test Setup

1. **Perform the Basic Setup Procedure.**  
Verify that the PANEL LOCK and SELF LOOP LEDs are off.
2. **Set Test Mode to 2048K.**
3. **Set the CONFIGURATION category items.**  
Set Transmitter to OFF to conserve battery life.  
Set Framing and Pattern to the framing and pattern used by the transmitting test set.
4. **Check AUXILIARY category items.**  
If you are using a printer, set all printer-related setup items as desired. (For more information, see Section 5). Check the Time and Date items to verify they are set for the current time and date.
5. **Set RECEIVER control to TERM.**  
TERM mode provides proper termination of the T-BERD 305/310 2048 kbit/s output, and it enables selection of 120Ω or 75Ω as appropriate for compatibility with the 2048 kbit/s output from the T-BERD 305/310.

## Test Results

1. **Check the error results.**  
To analyze the performance of a 2048 kbit/s link (while it is in-service), you can check the circuit's CRC-4 error results, frame (FAS and MFAS) error results, or code error results. When available, CRC-4 error results provide a good indication of overall link performance. However, note that Digital Cross-connect Systems and Automatic Cross-connect Equipment (DCS/ACE) generally are considered terminals (source/sink devices) for 2048 kbit/s links. Thus, CRC-4 errors received on one 2048 kbit/s link are not passed through to other 2048 kbit/s links terminating on the same DCS/ACE.

2. **Check the STATUS & ALARMS LEDs.**  
Verify proper detection of signal, framing, pattern, and absence of alarms.
3. **Check for timing problems.**  
To check for timing problems, perform a bit slip/frame slip test (See Section 7.8).

## 7.8 PERFORMING A BIT SLIP/FRAME SLIP TEST

You can use an INTERCEPTOR 132A that includes Option 132A-1 to perform a bit slip or frame slip test when, for example, you are troubleshooting a 2048 kbit/s link to the customer premises (as shown in Figure 7-7). The INTERCEPTOR 132A performs a timing analysis to compare the 2M clock recovered from the circuit with the 2M reference from the network equipment to measure any drift in the recovered clock from the reference clock. An in-service test can be performed using the MON or BRIDGE input.

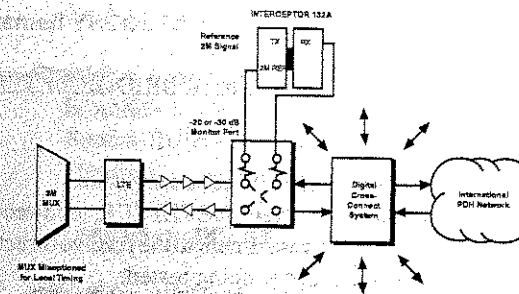

Figure 7-7  
Performing a Bit Slip or Frame Slip Test

**Test Setup**

1. **Perform the Basic Setup Procedure.**  
Verify that the PANEL LOCK and SELF LOOP LEDs are off.
2. **Set Test Mode to 2048K.**
3. **Set the CONFIGURATION category items.**  
Set Transmitter to ON.  
Set Framing to the format used by the 2048 kbit/s link under test (or set Framing to AUTO).  
Set Tx Clock to 2M REF.
4. **Check AUXILIARY category items.**  
If you are using a printer, set all printer-related setup items as desired. (For more information, see Section 5). Check the Time and Date items to verify they are set for the current time and date.
5. **Set RECEIVER control to MON.**  
Press the RECEIVER control to select MON (when working from a resistor-isolated monitor jack), and to select 120 $\Omega$  or 75 $\Omega$ , as appropriate.
6. **Set the CONFIGURATION CATEGORY items.**  
Set Tx Clock to 2M REF.  
Set 2M Ref Input to MON, BRIDGE, or TERM (as appropriate).
7. **Connect to the RECEIVER connector.**  
Using the selected RECEIVER connector, connect the test instrument to the receive direction of the circuit that is being tested.
8. **Connect to the EXT CLOCK connector.**  
Using the EXT CLOCK 2M REF BNC connector, connect the test instrument to the circuit's 2M clock reference.

**Test Results**

In the SIGNAL, CODE & FAS Results category, view the Freq  $\Delta$ ppm, Bit Slip, and Frame Slip results. These results indicate the relative stability of the recovered clock to the reference clock. The Freq  $\Delta$ ppm result indicates the recovered clock frequency deviation (in parts per million) from 2.048 Mbit/s. The Bit Slip value indicates whether the 2M reference is above or below the recovered clock. The Bit Slip value increments when the 2M reference is higher than the recovered clock frequency. The Bit Slip value decrements when the 2M reference is lower than the recovered clock frequency.

## 7.9 NOTES REGARDING ROUND-TRIP DELAY

---

To measure Round-Trip Delay, use the following steps.

**Test Setup**

1. **Set up the test instrument.**  
Set Framing, Interface, etc. as appropriate.
2. **Establish a loopback on the circuit.**  
Establish a loopback on the circuit under test. Send a Bit Error to verify proper setup of the loopback.
3. **Set Pattern to DELAY.**
4. **Check the STATUS & ALARMS LEDs.**  
Verify signal presence and appropriate frame synchronization.

**NOTE:** Pattern synchronization does not apply for Round-Trip Delay testing.

5. Press the RESTART control to begin each measurement.
6. Check the RT Delay (Round-Trip Delay) result. Check in the LOGIC & TIME or SUMMARY Results category.

## SPECIFICATIONS

### 8.1 2 MBIT/S OPERATING MODES

This section lists the capabilities of the INTERCEPTOR 132A when operating on 2.048 Mbit/s signals.

#### 8.1.1 Framing

The INTERCEPTOR 132A can process signals with the following CCITT G.704 framing formats:

- FAS with or without CRC-4
- MFAS with or without CRC-4
- Unframed

#### 8.1.2 2 Mbit/s Channel Access

The INTERCEPTOR 132A can access signals at the following levels:

- 64 kbit/s and 56 kbit/s timeslots for VF or error analysis
- Contiguous (Nx) or Non-contiguous (Mx) 56 or 64 kbit/s timeslot access

**8.1.3 Channel Associated Signaling Analysis**

The INTERCEPTOR 132A can provide the following channel-associated signaling analysis:

- Display ABCD bits
- Print signaling changes
- Insert ABCD bits (You can set different values for each of the VOICE channels.)

**8.1.4 Transmitter**

The specifications for the INTERCEPTOR 132A's Transmitter follow.

**8.1.5 Clock Sources**

The following clock sources are available with the INTERCEPTOR 132A:

- Internal (2.048 MHz  $\pm 5$  ppm stability)
- Recovered
- Offset  $\pm 50, 100$  ppm with 5 ppm stability (Option 132A-1)
- External (Option 132A-1)

**8.1.6 Encoding**

The INTERCEPTOR 132A can process 2 Mbit/s signals using the following types of encoding:

- HDB3
- AMI

**8.1.7 Output Connectors/Levels**

The INTERCEPTOR 132A includes the following connectors:

- 120 $\Omega$  balanced: 3-pin banana.  $\pm 3V \pm 10\%$
- 75 $\Omega$  unbalanced: 1.6/5.6 mm or BNC  $2.37V \pm 10\%$
- Serial 8-pin DIN (PRINTER / REMOTE CONTROL port)

**8.1.8 Generator**

The generator can generate the following patterns and errors.

Fixed Patterns: Mark, Space, 1:1, 1:3, 1:4, Program, Byte

Pseudorandom Patterns:  $2^6-1$  ( $Q_6 + Q_5$ ),  
 $2^9-1$  (CCITT V.52),  
 $2^{11}-1$  (CCITT O.152),  
 $2^{15}-1$  (CCITT O.151),  
 $2^{20}-1$  (CCITT V.57),  
 $2^{23}-1$  (CCITT O.151).

Other Patterns: QRSS\*, Delay.

Tone: 1020 Hz @ nominal 0 dBm.

Logic/Code Error Insertion: Single or  $10^{-3}$  rate.

FAS Error Insertion: Single, consecutive (1, 2, or 3) or  $10^{-3}$  rate.

**8.1.9 Receiver**

The Receiver has the following characteristics:

**Input sensitivity**

|                 |                                           |
|-----------------|-------------------------------------------|
| Terminate mode: | Cable compensation = 0 dB to -22 dB.      |
| Bridge mode:    | Cable compensation = +6 dB to -22 dB.     |
| Monitor mode:   | Resistive attenuation = -18 dB to -30 dB. |

**Input Impedance**

|                 |                                   |
|-----------------|-----------------------------------|
| Terminate mode: | 120Ω balanced, or 75Ω unbalanced. |
| Bridge mode:    | >2 kΩ.                            |
| Monitor mode:   | 120Ω balanced, or 75Ω unbalanced. |

**8.1.10 Signal Analysis**

The following specifications are for signal analysis.

|                            |                                     |
|----------------------------|-------------------------------------|
| Frequency Measurement:     | 56 kHz to 2.048 MHz ( $\pm 5$ ppm). |
| VF Peak Code:              | -127 to +127.                       |
| VF Channel Level:          | -60 to +3 dBm.                      |
| 2.048 Mbit/s Peak Voltage: | 0V to 7V ( $\pm 3\%$ ).             |
| 2.048 Mbit/s Level:        | -36 to +7.4 dBnom ( $\pm 0.3$ dB).  |

**8.1.11 Compliance with CCITT Recommendations**

The INTERCEPTOR 132A also complies with the following CCITT Recommendations.

|          |                        |
|----------|------------------------|
| 2M G.772 | (for monitor)          |
| 2M G.823 | (for jitter tolerance) |
| 2M G.704 | (for framing)          |

**8.2 PRINTER / REMOTE CONTROL INTERFACE**

The INTERCEPTOR 132A's PRINTER / REMOTE CONTROL interface (on the top of the test instrument) allows you to connect a printer or a remote controller. The following specifications are used with the PRINTER / REMOTE CONTROL interface.

|                  |                                                                                                                        |
|------------------|------------------------------------------------------------------------------------------------------------------------|
| Format:          | The INTERCEPTOR 132A can print to 80-column printers and to 40-column printers that allow 80-to-40 column compression. |
| Baud Rate:       | 300, 1200, 2400, 4800, or 9600.                                                                                        |
| Word Length:     | 7 or 8.                                                                                                                |
| Parity:          | Odd, even, or none.                                                                                                    |
| Line Terminator: | CR, LF, CRLF.                                                                                                          |
| Connector:       | Serial, 8-pin DIN (See Appendix A for the pin assignments.).                                                           |

**8.3 GENERAL****8.3.1 Memory Specifications**

In non-volatile memory, you can store:

- up to 10 complete configurations for the test instrument
- the front-panel switch settings and setup selections that were current at the time of power-off.

In the Print Buffer's non-volatile memory, you can store more than 50 Results Prints or up to 500 Event Prints.

In the histogram buffer's non-volatile memory, you can store 1000 event-seconds of information.

**8.3.2 Physical Specifications**

The physical characteristics for the INTERCEPTOR 132A are:

Case Dimensions:      9.1 cm (3.6 in.) High.  
                                  11.4 cm (4.5 in.) Wide.  
                                  21.8 cm (8.6 in.) Deep.

Weight:                    1.8 kg (4.0 lbs).

Operating Temperature: 0 to 45 °C (32 to 113 °F).

Storage Temperature: -40 to 70 °C (-40 to 158 °F).

**8.3.3 Power Specifications**

Power Requirements:    4.2 W.

**Battery**

Type:                      Sealed lead-acid.  
 Rating:                    6V @ 2.4 A Hr.  
 Operation:                3 - 6 hours (depending on  
                                  mode).  
 Charging Time:         8 hours (unit not operating).

## MAINTENANCE AND SERVICE

### 9.1 OVERVIEW

---

This section contains information on maintenance and service for the INTERCEPTOR 132A, including TTC's warranty policies and repair procedures.

### 9.2 TROUBLESHOOTING

---

Use the appropriate procedures listed below, depending on whether the test instrument fails to turn on, or does not operate as expected.

#### 9.2.1 If Your Test Instrument Fails to Turn On

If the test instrument fails to operate and no front panel indicators illuminate, the test instrument's internal battery may need charging. Connect the AC Mains power adaptor to your test instrument and then to AC Mains power. If the BATTERY CHARGING indicator does not illuminate, check the connections. If the BATTERY CHARGING indicator does illuminate, but the test instrument still fails to operate, then refer to the following sections for service information or contact your TTC distributor for applications assistance.

### 9.2.2 If Your Test Instrument Does Not Operate As Expected

If your test instrument cannot successfully perform the Initial Check-Out Procedure (see Section 1.7), or if it does not operate as expected, check the following items.

- When performing a self test of the test instrument, such as the Initial Check-Out Procedure, make sure that SELF LOOP is on.
- In general, follow the Basic Setup Procedure. It is important to use this top-down approach because some items in later categories do not appear unless related items in earlier categories have been selected first.
- If your test instrument appears to be reporting false errors, verify that the RECEIVER mode is set up properly.
- If your test instrument cannot achieve framing or pattern synchronization, try setting either Framing or Pattern or both (in the CONFIGURATION category) to AUTO.

## 9.3 SERVICE

The information in the following subsections explains TTC's warranty policy, and in-warranty and out-of-warranty service policies.

### 9.3.1 Warranty Policy

All equipment manufactured by Telecommunications Techniques Corporation (TTC) is warranted against defects in material and workmanship. This warranty applies only

to the original purchaser and is non-transferrable unless express written authorization of the warranty transfer is granted by TTC.

The INTERCEPTOR 132A will be repaired or replaced (at our option) at no charge for a period of three (3) years after shipment to the customer. Cables, printers, accessories, breakout boxes and all equipment other than the above mainframe will be repaired or replaced (at our option) at no charge for a period of one (1) year after shipment to the customer.

Liability under this warranty extends only to the replacement value of the equipment. This warranty is void under the following conditions:

- Equipment has been altered or repaired without specific authorization by TTC.
- Equipment is installed or operated other than in accordance with instructions contained in TTC literature and operating manuals.

No other warranty is expressed or implied. TTC is not liable for any direct, indirect, incidental or consequential damages.

### 9.3.2 In-Warranty Service

Equipment in warranty must be returned to the factory or authorized service center with shipping prepaid. The equipment should be packed and shipped in accordance with Instructions in Section 9.3.5 of this manual. Before returning any equipment, the customer must obtain a Return Authorization (RA) number by contacting the nearest TTC Repair Center. The RA number should appear on all paperwork and be clearly marked on the outside of the shipping container.



After TTC repairs the equipment, it will be tested to applicable specifications and returned to the customer with shipping prepaid. A brief description of the work performed and the materials used will be provided on the Equipment Repair Report furnished with the returned equipment.

### 9.3.3 Out-of-Warranty Service

The procedure for repairing out-of-warranty equipment is the same as that used for equipment still in warranty. However, there is a minimum charge applied to each request for out-of-warranty service. The minimum charge guarantees the customer an estimate of the repair costs and is used as credit against actual materials and labor costs should the equipment be repaired. Contact the nearest TTC Repair Center for specific information on the minimum out-of-warranty charge.

The customer will be billed for parts plus standard rates in effect at the time of repair. The customer will also be required to furnish a purchase order number before repair work can be started, and TTC (or the authorized service center) must receive a hard copy of the purchase order before the repaired equipment may be shipped to the customer. A description of the labor and materials used will be provided in the Equipment Repair Report.

Once an out-of-warranty repair is made, the repaired part or component is warranted for one year. This warranty applies only to the part that was repaired; other parts or components are not covered under the one year repair warranty.

### 9.3.4 Calibration

The INTERCEPTOR 132A requires calibration at one-year intervals. For price information and to schedule your INTERCEPTOR 132A for calibration, contact TTC's Customer Service. When you send the test instrument to TTC for calibration, be sure to follow the Equipment Return Instructions provided in the following section.

### 9.3.5 Equipment Return Instructions

When you return equipment for repair, attach a tag that includes the following information:

- Owner name and address
- A list of the equipment being returned (including the serial number of each piece of equipment)
- A detailed description of the problem or service requested
- The name and telephone number of the person to contact regarding questions about the repair
- The RA number.

If possible, you should use the original shipping container and material when you return equipment. If the original container is not available, the test instrument should be carefully packed so that it will not be damaged during shipment. TTC is not liable for any damage that may occur during shipping. You should clearly mark the TTC-issued RA number on the outside of the package, and ship the package prepaid and insured to TTC.

**9.4 HOW TO CONTACT TTC**

If you have any questions regarding the operation, application, or service of your test instrument, please call your TTC Distributor, or contact TTC (at the numbers or address listed below).

**Phone:**

From the United States or Canada,  
dial 1-800-638-2049 or 1-301-353-1550

From outside the United States or Canada,  
(01) 301-353-1550 (International)

Ask for Customer Service.

**FAX:**

1-301-353-0731 (USA and Canada)  
(01) 301-353-0731 (International)  
Attention: Customer Service.

**Mailing Address:**

Attn. Customer Service  
TTC — CEPT Telecom Test  
20400 Observation Drive  
Germantown, MD 20876

You may also contact your local TTC Offices:

**In Canada:**

TTC-Montreal: (514) 879-1820  
TTC-Toronto: (905) 507-4117  
TTC-Vancouver: (604) 436-0855

**In Europe:**

TTC-Europe: 0 89 8116935

**In France:**

TTC-France: 0 1-30.48.83.00, or  
0 1-30.48.83.90

**In Germany:**

TTC-Friedrichsdorf: 0 6172.77055  
TTC-Munich: 0 89-907874

**In Ireland:**

TTC Ireland: 353-18-251.355

**In the UK:**

TTC (UK) Ltd.: 44-293-617700

**In Hong Kong:**

TTC Hong Kong: 852-529.0356, ext. 288

## PRINTER / REMOTE CONTROL INTERFACE

The INTERCEPTOR 132A has a serial (V.24) PRINTER / REMOTE CONTROL port that is used to connect the test instrument to a printer or to a remote controller. The serial port connector is an 8-pin, female, DIN connector.

To connect to the port, use the Printer/Remote Control cable (model 31202) that is supplied with the INTERCEPTOR 132A. The Printer/Remote Control cable has an 8-pin, male DIN connector at one end (to plug into the test instrument's PRINTER / REMOTE CONTROL port) and a 25-pin, male, D-type connector at the other end (to plug into the printer or the remote controller).

When connected to a printer or remote controller, the INTERCEPTOR 132A acts as a DCE. The pins used on the PRINTER / REMOTE CONTROL interface and their associated functions are listed below.

| Pin Number on 8-pin Connector | Function                    | Pin Number on 25-pin Connector * |
|-------------------------------|-----------------------------|----------------------------------|
| 1 RTS                         | Request to Send (input)     | 4                                |
| 2 Ground                      | Signal Ground               | 7                                |
| 3 Ground                      | Chassis Ground              | 1                                |
| 4 CTS                         | Clear to Send (output)      | 5                                |
| 5 TXD                         | Transmitted Data (input)    | 2                                |
| 6 DTR                         | Data Terminal Ready (input) | 20                               |
| 7 RXD                         | Receive Data (output)       | 3                                |
| 8 DSR                         | Data Set Ready (output)     | 6                                |

\* All other pins are not assigned.

## REMOTE CONTROL STATUS REGISTERS

The INTERCEPTOR 132A uses a set of internal registers, queues, and buffers to store information about test status, line conditions, alarm conditions, error conditions, and print information. The user may access this information by using INTERCEPTOR 132A status queries.

### B.1 REGISTER OPERATION

The INTERCEPTOR 132A has six groups of registers: Status Byte Register, Event Status Register, Test Summary Register, Remote Alarms Register, AIS Alarms Register, and Line History Register (see Figure B-1).

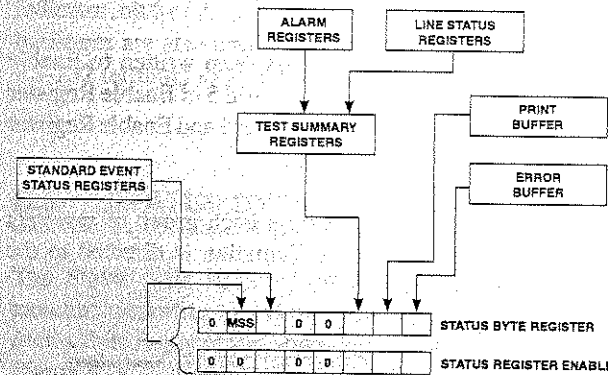

Figure B-1  
INTERCEPTOR 132A Registers

Each group of registers captures specific events. Within each group of registers is a status register, composed of 8 bits, representing up to 8 events. When a specific event occurs, the corresponding bit is set to 1. The user may read each status register and interpret the bits to provide test status information.

Each group of registers contains one writable 8-bit enable register. The user may program the bits in each enable register to report selected events in the corresponding status register. Setting the bits in the enable register controls the generation of the summary bit for each register group. The summary bit is set when a status register bit and its corresponding enable register bit are both set.

Users may read registers using an associated query. Users may use an associated command to write a value to enable registers. The \*CLS command clears all event registers, buffers, and queues except the output queue.

### Register Operation Example

In Figure B-2, the value 36 has been written to Enable Register 1. This value sets bits 2 and 5 of Enable Register 1. Since bit 5 of both Status Register 1 and Enable Register 1 is set, the summary bit is set.

This process is duplicated with each group of registers until all of the summary information is directed to the Status Byte Register.

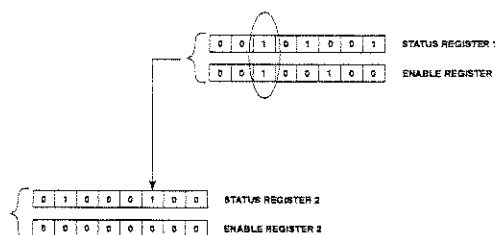

Figure B-2  
Register Operation

## B.2 QUEUE AND BUFFER OPERATION

All responses that the INTERCEPTOR 132A generates are placed in the Output Queue. With RS-232 Remote Control operation, the contents of the Output Queue are immediately transmitted to the terminal. When a response is in the Output Queue, the Message Available indicator bit 6 of the Status Byte Register is set to 1.

Printouts generated by the INTERCEPTOR 132A may be sent to an internal buffer called the RC Print Queue. An available print in the RC Print Queue sets the Print Available indicator bit 6 of the Status Byte Register to 1. This ability is enabled through the command SYSTEM:RC PRINT. Users may read the printouts by using the STATUS:PRINT? query.

The Error Buffer is an internal buffer used to store the last generated error message. The Error Buffer is read using the STATUS:ERROR? query and is cleared using the STATUS:CLEAR\_ERR command. When an error message is present in the Error Buffer, the Error Available indicator, bit 0 of the Status Byte Register, is set to 1. Error messages are also transmitted directly to the terminal in RS-232 terminal mode operation.

## B.3 STATUS BYTE REGISTER GROUP

The Status Byte Register group summarizes the data structures reporting to it, and consists of two 8-bit registers: Status Byte Register and Status Byte Enable Register. See Figure B-3.

The Status Byte Register contains summary bits from the data structures that report to it. Each bit reports whether a specific event or condition has occurred. The INTERCEPTOR 132A defines 6 of the 8 bits in the Status Byte Register; the other 2 bits are always set to 0.

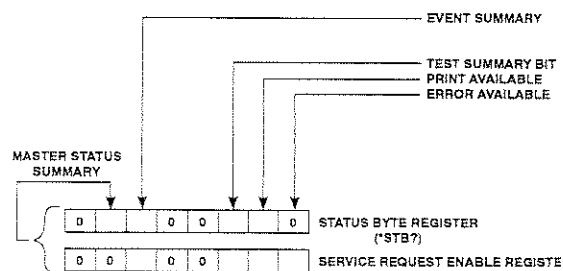

**Figure B-3**  
**Status Byte Register**

The controller reads the Status Byte Register by using a serial poll or the \*STB query. If the Status Byte Register is read using a serial poll, bit 6 is returned as a Request Service (RQS); if it is read with a \*STB? query, bit 6 is returned as a Master Summary Status (MSS).

When the Status Byte Register is read, a binary-weighted integer is returned. This integer represents the decimal equivalent of the enabled bits in the register. Convert the returned value to binary to determine the status of the bits in the Status Byte Register.

- Bit 7 Not Defined. Always set to 0.
- Bit 6 MSS - Master Status Summary  
Represents the summary of all other bits in the Status Byte Register. The corresponding enabling bit in the Service Request Enabling Register (\*SRE) is not programmable.
- Bit 5 ESB - Event Status Bit  
Indicates that an enabled event in the Standard Event Status Register has occurred. Read the Standard Event Status Register to determine which event has occurred.

- Bit 4 Not Defined. Always set to 0.
- Bit 3 Not Defined. Always set to 0.
- Bit 2 Bit 2 indicates that an enabled event in the Test Summary Register has occurred. Read the Test Summary Register to determine which event has occurred.
- Bit 1 PAV - Print Available  
Indicates that a printout is available in the remote control print queue. See the STATUS:PRINT?remote control command.
- Bit 0 EAV - Error Message Available  
Indicates that an error message is available in the error buffer. See the STATUS:ERROR? and STATUS: CLEAR\_ERR remote control commands.

The Status Byte Enable Register is an 8-bit register that determines which bits of the Status Byte Register can cause the MSS bit 6 of the Status Byte Register to be set. The Service Request Enable Register is written to with the \*SRE command.

## B.4 EVENT STATUS REGISTER GROUP

The Event Status Register group is used to detect specific IEEE-488.2 defined events, and consists of two, 8-bit registers: Event Status Register and Event Status Enable Register. See Figure B-4.

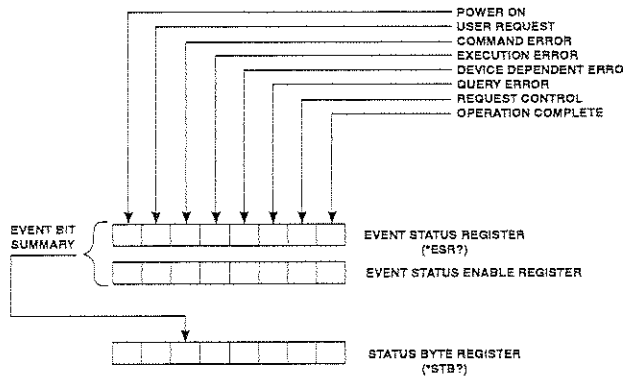

**Figure B-4**  
Event Status Register Group

The Event Status Register (ESR) assigns specific IEEE-488.2 defined events to each of the bits within the register. A bit is set in the Event Status Register when the event that corresponds to that bit has occurred since the register was last read or cleared. This register is cleared each time it is read.

- Bit 7 PON - Power On  
Power has been cycled OFF and ON since the last time the Event Status Register was read.
- Bit 6 URQ - User Request  
Not used. Always reads 0.

- Bit 5 CME - Command Error  
Indicates that a command received by the INTERCEPTOR 132A was not executed because it was not understood.
- Bit 4 EXE - Execution Error  
Indicates that the INTERCEPTOR 132A is unable to execute a command.
- Bit 3 DDE - Device Dependent Error  
Not used. Always reads 0.
- Bit 2 QYE - Query Error  
Indicates that the controller has attempted to read the INTERCEPTOR 132A output queue when nothing was available to be read, or that data in that queue has been lost.
- Bit 1 RQC - Request Control  
Not used. Always reads 0.
- Bit 0 OPC - Operation Complete  
Reports that all pending operations are complete. See the \*OPC common command.

The Event Status Enable Register (ESE) is an 8-bit register that allows the controller to enable or disable each bit in the Event Status Register. When a bit in the Event Status Enable Register is set to 1, the corresponding bit in the Event Status Register is enabled. When an enabled bit in the Event Status Register is set to 1, the ESB bit in the Status Byte Register is also set to 1.



B.5 TEST SUMMARY REGISTER GROUP

The Test Summary Register is an 8-bit register that contains summary bits from the data structures reporting to it. Figure B-5 depicts this register. In this example, only 3 of the 8 bits are used.

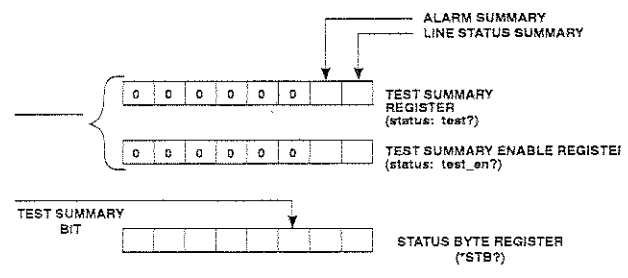

Figure B-5 Test Summary Register

- Bit 7 Not defined. Always set to 0.
- Bit 6 Not defined. Always set to 0.
- Bit 5 Not defined. Always set to 0.
- Bit 4 Not defined. Always set to 0.
- Bit 3 Not defined. Always set to 0.
- Bit 2 Not defined. Always set to 0.
- Bit 1 Alarm Status Summary Bit.
- Bit 0 Line Status Summary Bit.

B.6 LINE STATUS REGISTER GROUP

The Line Status Register group consists of three registers: Line Status Register, Line History Register, and Line Enable Register. This group of registers is used to detect the state of the signal presence indicator, the various FAS Sync indicators, the pattern slip indicator, and an alarm indicator. See Figure B-6.

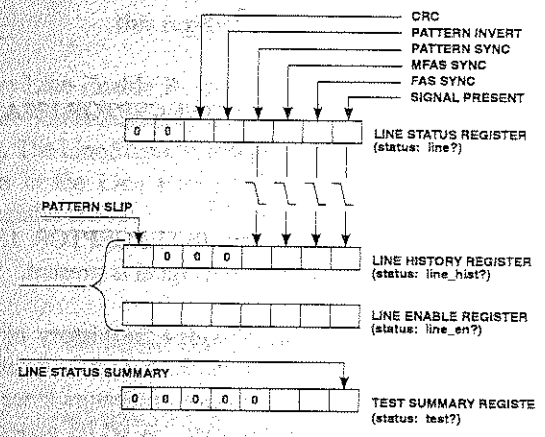

Figure B-6 Line Status Register Group

The Line Status Register gives the current state of the signal presence indicator, the various FAS Sync indicators, the pattern slip indicator, and an alarm indicator. The Line Status Register is read with the query, STATUS:LINE?. The bit grouping is as follows:

- Bit 7 Not used. Always set to 0.
- Bit 6 Not used. Always set to 0.
- Bit 5 CRC  
Set to 1 when the INTERCEPTOR 132A has detected CRC framing.

Remote Control Status Registers

Remote Control Status Registers



*INTERCEPTOR 132A 2Mbit/s Analyzer*

- Bit 4 PATTERN INVERT  
Set to 1 when the INTERCEPTOR 132A has detected pattern inversion.
- Bit 3 PATTERN SYNC  
Set to 1 when the INTERCEPTOR 132A has detected pattern sync.
- Bit 2 MFAS SYNC  
Set to 1 when the INTERCEPTOR 132A has detected MFAS Sync.
- Bit 1 FAS SYNC  
Set to 1 when the INTERCEPTOR 132A has detected FAS Sync.
- Bit 0 SIGNAL PRESENT  
Set to 1 when the INTERCEPTOR 132A detects that an input signal is present.

The Line History Register provides the history of the signal presence indicator, various FAS Sync indicators, pattern slip indicator, and the alarm indicators since the Line History Register was last read. A set bit generally indicates an error has occurred or synchronization was lost during the interval since the register was last read.

The Line History Register is read using the query, STATUS:LINE HIST?.

- Bit 7 PATTERN SLIP  
Indicates that a pattern slip occurred since this register was last read.
- Bit 6 Not Used. Always set to 0
- Bit 5 Not Used. Always set to 0
- Bit 4 Not Used. Always set to 0
- Bit 3 PATTERN SYNC  
Indicates that PATTERN Sync was lost since this register was last read.

*INTERCEPTOR 132A 2Mbit/s Analyzer*

- Bit 2 MFAS SYNC  
Indicates that MFAS Sync was lost since this register was last read.
- Bit 1 FAS SYNC  
Indicates that FAS Sync was lost since this register was last read.
- Bit 0 SIGNAL PRESENT  
Indicates that signal presence was lost since this register was last read.

The Line Enable Register is used to determine how the Line Status Summary bit of the Test Summary Register is set. The Line Status Summary bit is set when corresponding bits in the Line History Register and the Line Enable Register are set.

**B.7 ALARM STATUS REGISTER GROUP**

The Alarm Status Register group consists of three registers: Alarm Status Register, Alarm History Register, and Alarm Enable Register. See Figure B-7.

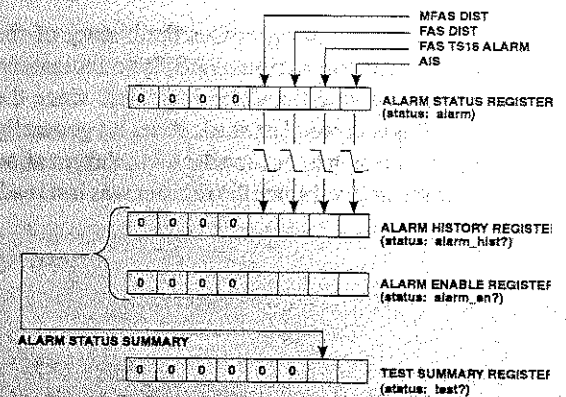

**Figure B-7**  
**Alarm Status Register Group**

The Alarm Status Register gives the current state of the signal presence indicator, the various FAS Sync indicators, the pattern slip indicator, and an alarm indicator. The Alarm Status Register is read with the query, STATUS:ALARM?. The bit grouping is as follows:

- Bit 7 Not Used. Always set to 0
- Bit 6 Not Used. Always set to 0
- Bit 5 Not Used. Always set to 0
- Bit 4 Not Used. Always set to 0
- Bit 3 MFAS Distant  
Indicates that the MFAS Distant alarm is active.
- Bit 2 FAS Distant  
Indicates that the FAS Distant alarm is active.
- Bit 1 TS-16 AIS  
Indicates that the TS-16 AIS is active.
- Bit 0 AIS  
Indicates that AIS is active.

The Alarm History Register provides the history of the signal presence indicator, various FAS Sync indicators, pattern slip indicator, and the alarm indicators since the Alarm History Register was last read. A set bit generally indicates that an error has occurred or synchronization was lost during the interval since the register was last read.

The Alarm History Register is read using the query, STATUS:ALARM HIST?.

- Bit 7 Not Used. Always set to 0
- Bit 6 Not Used. Always set to 0
- Bit 5 Not Used. Always set to 0
- Bit 4 Not Used. Always set to 0
- Bit 3 MFAS Distant  
Indicates that the MFAS Distant alarm was detected since this register was last read.
- Bit 2 FAS Distant  
Indicates that the FAS Distant alarm was detected since this register was last read.
- Bit 1 TS-16 AIS  
Indicates that the TS-16 AIS was detected since this register was last read.
- Bit 0 AIS  
Indicates that AIS was detected since this register was last read.

The Alarm Enable Register is used to determine how the Alarm Status Summary bit of the Test Summary Register is set. The Alarm Status Summary bit is set when corresponding bits in the Alarm History Register and the Alarm Enable Register are set.

## UNDERSTANDING G.821 PERFORMANCE ANALYSIS

### C.1 WHY CCITT G.821 PERFORMANCE ANALYSIS?

This appendix discusses the criteria for performance analysis, the concept of available time versus unavailable time, and degraded minutes as specified in CCITT Recommendation G.821. This discussion is provided to familiarize users with the G.821 Performance results.

### C.2 PERFORMANCE ANALYSIS RESULTS

The performance results (available in the INTERCEPTOR 132A's PERFORMANCE results category) are derived by observing the received bit error counts and received bit counts at 1-second intervals, and classifying each 1-second interval as available, unavailable, severely errored, or error free seconds. This division of test time is illustrated in Figure C-1. Further calculations yield the number and percentage of degraded minutes, and percentages of available, severely errored, and error free seconds.

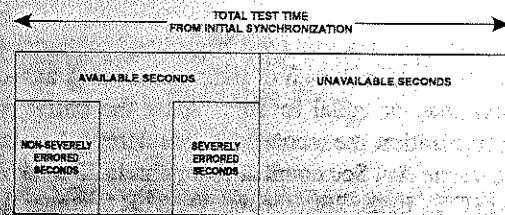

**Figure C-1**  
Division of Test Seconds for Performance Analysis

### C.3 DETERMINING AVAILABLE AND UNAVAILABLE SECONDS

CCITT Recommendation G.821 defines available and unavailable time as follows.

“A period of unavailable time begins when the bit error rate (BER) in each second is worse than  $10^{-3}$  for a period of 10 consecutive seconds. These 10 seconds are considered to be unavailable time. The period of unavailable time terminates when the BER in each second is better than  $10^{-3}$  for a period of 10 consecutive seconds. These 10 seconds are considered to be available time.”

Available and unavailable time are measured in seconds — available seconds (Avl Sec) and unavailable seconds (Unavl Sec), respectively. All seconds after initial pattern synchronization must fall into one of the two categories (total Avl Sec + total Unavl Sec = total seconds after initial pattern synchronization).

After initial pattern synchronization, seconds are considered to be available time; the Avl Secs begin counting (seconds that occur before initial pattern synchronization are not included in performance analysis). These seconds continue to be counted until 10 consecutive seconds, each with a BER greater than  $10^{-3}$ , occur. A sliding window, 10 seconds in length, is used to detect this transition from available time to unavailable time and vice versa.

As an example, assume a test begins and continues to run for 25 seconds and each of those 25 seconds has a BER greater than or equal to  $10^{-3}$ . After the initial pattern synchronization, the seconds are considered to be available time, so the Avl Sec count at this point is 25 as shown in Figure C-2. In the 26th second, the BER becomes greater than  $10^{-3}$ . The same for the 27th and 28th seconds. In the 29th second, the BER improves to less than or equal to  $10^{-3}$ . All 29 seconds are a part of available time and are, therefore, counted as Avl Sec.

Even though there were 3 consecutive seconds (the 26th, 27th, and 28th) which each had a BER greater than  $10^{-3}$ , 10 such consecutive seconds are required to make the transition to unavailable time. Those 3 individual seconds are still in available time and they are counted as Avl Sec.

|     |     |     |     |     |     |     |     |     |     |
|-----|-----|-----|-----|-----|-----|-----|-----|-----|-----|
| sec | sec | sec | sec | sec | sec | sec | sec | sec | sec |
| 20  | 21  | 22  | 23  | 24  | 25  | 26  | 27  | 28  | 29  |
| BER | BER | BER | BER | BER | BER | BER | BER | BER | BER |
| <=  | <=  | <=  | <=  | <=  | <=  | >   | >   | >   | <=  |

**Figure C-2**  
Sliding Window after 29th Test Second still in Available Time

The 3 seconds with a BER greater than  $10^{-3}$  are also included in the count of severely errored seconds (SES), which are those seconds with a BER greater than  $10^{-3}$  that occur in available time. A signal loss second or a second in which pattern synchronization is lost is also considered to be a second with a BER greater than  $10^{-3}$ . Therefore, the current test result values for the Avl Sec count = 29; the SES count = 3 and the Unavl Sec count = 0.

|     |     |     |     |     |     |     |     |     |     |
|-----|-----|-----|-----|-----|-----|-----|-----|-----|-----|
| sec | sec | sec | sec | sec | sec | sec | sec | sec | sec |
| 79  | 80  | 81  | 82  | 83  | 84  | 85  | 86  | 87  | 88  |
| BER | BER | BER | BER | BER | BER | BER | BER | BER | BER |
| <   | >   | >   | >   | >   | >   | >   | >   | >   | >   |

**Figure C-3**  
Sliding Window after 88th Test Second still in Available Time

The same test continues to run and remains in available time. In the 80th second, the BER for that second is greater than  $10^{-3}$  as shown in Figure C-3. The BER for the 81st through the 85th seconds is also greater than  $10^{-3}$ . In the

INTERCEPTOR 132A 2Mbit/s Analyzer

86th second, pattern synchronization is lost. This also continues for the 87th and 88th seconds. We now have 9 consecutive seconds each of which has a BER worse than  $10^{-3}$ . As each of these seconds occurs, we are still in available time, so they are counted as Avl Sec and SES. The transition has not been made from available time to unavailable time.

Figure C-4 shows the 89th second also has a BER less than  $10^{-3}$ . At this point, the Avl Sec count = 89, the SES count = 13, and the Unavl Sec count = 0. However, the sliding window now contains 10 consecutive seconds each having a BER worse than  $10^{-3}$ . At this point the transition is made to unavailable time:

Those 10 seconds which had been counted as Avl Sec are deducted from the Avl Sec count and are added to the Unavl Sec count; the Avl Sec count becomes 79, and the Unavl Sec count becomes 10. Those same 10 seconds were also included in the SES count. However, SES is limited to only those seconds in available time which have a BER greater than  $10^{-3}$ ; therefore, those last consecutive 10 seconds must also be deducted from the SES count (the SES count is updated to 3).

|     |     |     |     |     |     |     |     |     |     |
|-----|-----|-----|-----|-----|-----|-----|-----|-----|-----|
| sec | sec | sec | sec | sec | sec | sec | sec | sec | sec |
| 80  | 81  | 82  | 83  | 84  | 85  | 86  | 87  | 88  | 89  |
| BER | BER | BER | BER | BER | BER | BER | BER | BER | BER |
| >   | >   | >   | >   | >   | >   | >   | >   | >   | >   |

**Figure C-4**  
Sliding Window after 89th Test Second  
Transition to Unavailable Time

INTERCEPTOR 132A 2Mbit/s Analyzer

Once the transition occurs from available time to unavailable time, all seconds are counted as Unavl Sec until 10 consecutive seconds occur each with a BER less than  $10^{-3}$ . As the sample test continues, the 90th through 150th seconds each have a BER greater than or equal to  $10^{-3}$ . We are still in unavailable time, so these seconds are counted as Unavl Sec; now the total Avl Sec count = 79 and the total Unavl Sec count = 71.

|     |     |     |     |     |     |     |     |     |     |
|-----|-----|-----|-----|-----|-----|-----|-----|-----|-----|
| sec | sec | sec | sec | sec | sec | sec | sec | sec | sec |
| 151 | 152 | 153 | 154 | 155 | 156 | 157 | 158 | 159 | 160 |
| BER | BER | BER | BER | BER | BER | BER | BER | BER | BER |
| <   | <   | <   | <   | <   | <   | <   | <   | <   | <   |

**Figure C-5**  
Sliding Window after 160th Test Second  
Transition to Available Time

Beginning with the 151st second, the BER for that second is less than  $10^{-3}$ , as shown in Figure C-5. It is still counted as an Unavl Sec since we are still in unavailable time and the transition has not been made to available time. A BER less than  $10^{-3}$  also occurs for the 152nd through the 160th seconds. Since there are now 10 consecutive seconds with a BER less than  $10^{-3}$ , the transition is made from unavailable time to available time.

As each of these 10 seconds occurred, it was added to the Unavl Sec count (Unavl Sec = 81, Avl Sec = 79, and SES = 3). Now that those consecutive seconds have triggered the transition to available time, they are deducted from the Unavl Sec count and added to the Avl Sec count. Now the Unavl Sec count = 71 and the Avl Sec count = 89.

The monitoring of available and unavailable time continues for the duration of the test.

### C.4 DETERMINING DEGRADED MINUTES

Degraded minutes (Deg Min) is an error analysis result that is affected by available and unavailable time. Deg Min is a count of the number of minutes during which an average BER greater than  $10^{-6}$  occurs. The 1-minute intervals are derived by removing Unavl Sec and SES from the total test time and then consecutively grouping the remaining seconds into blocks of 60. The average BER is calculated for the block of 60 seconds and, if it is greater than  $10^{-6}$ , the block is counted as a degraded minute.

In the transition from available time to unavailable time, the Deg Min result is unaffected. This is because a switch to unavailable time requires 10 consecutive seconds each with a BER greater than  $10^{-3}$ . Any second in available time with a BER greater than  $10^{-3}$  is considered to be a severely errored second and, therefore, not included in the accumulation of seconds used to calculate Deg Min.

Moving from unavailable time to available time may affect the Deg Min count. While in unavailable time, 10 consecutive seconds each with a BER less than  $10^{-3}$  are required for the transition to available time. When this happens, those 10 seconds are subtracted from the Unavl Sec count and are added to the Avl Sec count. Since these seconds are now considered to be a part of available time and they are not SES, they are included in the calculation of Deg Min.

### UNDERSTANDING HISTOGRAMS

The INTERCEPTOR 132A can produce Graph and List Histogram Prints. To understand the information that appears in both types of Histogram Prints, read the information in this appendix.

#### D.1 UNDERSTANDING HISTOGRAM GRAPHS

GRAPH-type histograms provide a graphical depiction of test results over a period of time. The description of GRAPH histograms provided in this section applies whether the histogram is printed using a Printer Mode of GRAPH or ASCII; when the Printer Mode is ASCII, the bars are replaced with columns of asterisks.

In the sample histogram shown below, the circled numbers correspond to the numbers used in the explanations that follow the diagram.

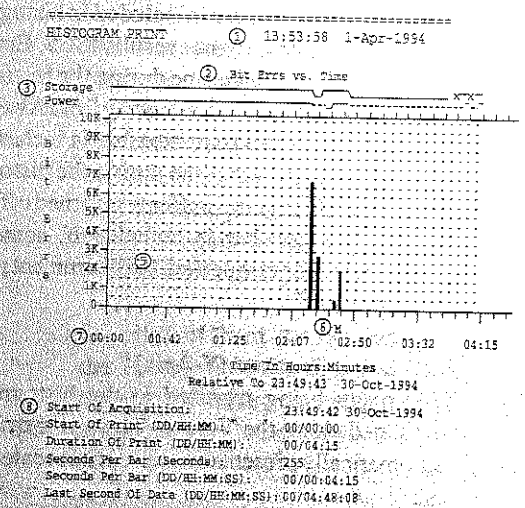

Figure D-1 Sample Histogram Graph



1. Time and Date of Print

At the top of Histogram Print, is the time and date when the histogram was created.

2. Histogram Title

The histogram title indicates what result is being histogrammed. For example, depending on the Hist Rslt selection, the histogram may show Bit Errors versus Time, or Severely Errored Seconds versus Time, etc.

3. Transition Bar(s) Labeled Av T, Storage, Power

Three transition bars that may appear have the following titles:

- Av T (Available Time)
- Storage
- Power

These transition bars indicate changes (or transitions) that occurred during the histogram period that affect the availability of histogram information.

The Av T transition bar is included in histograms of one of the performance results (SES, Err Sec, or Unavl Sec) if, sometime during the histogram period, a transition was made away from Available Time. The Storage transition bar is included in the histogram if, sometime during the histogram period, the Histogram Buffer was turned off. The Power transition bar is included if, sometime during the histogram period, the instrument power was turned off.

4. Result Being Tracked (Y-Axis)

The result being reported in the histogram is indicated along the Y axis. The test instrument automatically presents an appropriate scale along the Y-axis.

5. Results (Bar Graph)

The vertical bars on the Histogram Print indicate how many of the specified events occurred at the indicated times.

6. Mode Change Indicator(s)

When a mode change occurs, the Mode Change Indicator appears as an "M" to show the time. For purposes of Histogram Prints, a mode change is defined as any change in test instrument configuration.

7. Relative Time Indicators (X-Axis)

The X axis indicates the time, relative to the start time of the histogram. The time indicators are automatically evenly spread along the X axis, ranging from 00:00 to the time set up in the AUXILIARY setup category's Len item. To correlate the time with real time, add the relative time indicated on the X axis to the real time.

8. Information About the Histogram

The following information about the histogram is provided:

**Start of Acquisition** — Time when the histogram buffer was turned on.

**Start of Print (DD/HH:MM)** — Time indicating the start of the Histogram Print, relative to the time the histogram buffer was turned on. This value is equal to the value you set in the AUXILIARY category's Start item.

**Duration of Print (DD/HH:MM)** — Time that the Histogram Print covers. This value is equal to the value you set in the AUXILIARY setup category's Len item.





## 2. Results

The name of the test result that is being histogrammed is followed by a list of the values for that result. Each of the values (separated by commas) indicates the value for the corresponding time period. In the example shown, in the 36th group of 255 seconds of the time covered by the histogram, 6643 bit errors were detected; in the following 255 seconds of the time covered by the histogram, 2699 bit errors were detected; and so on.

## 3. Transition Information Labeled Avl Sec, Storage, and Power

The Transition Information lines correspond to the Transition Bars available with Graph histograms. In List histograms, the transition information is indicated by a list of numbers (separated by commas). Each number represents the condition for the given time period. In the example shown, the first number indicates the condition during the first time period (that is, the first 255 seconds), etc. The numbers represent the conditions listed below.

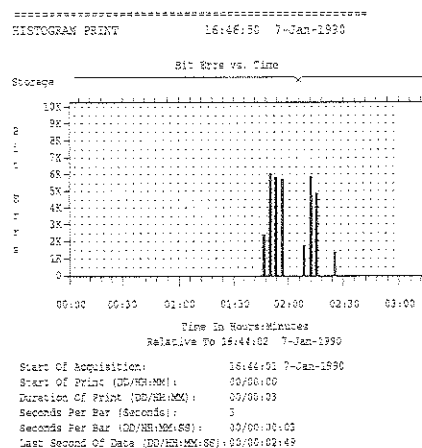

## 4. Mode Change Information

The numbers on Modechgng (Mode Change) line report the following information regarding mode changes:

- 0 No mode change occurred.
- 1 A mode change occurred.
- 5 Unable to determine; may occur immediately after power up.

## 5. Information About the Histogram

At the bottom of the List Histogram is a list of information about the histogram. This information is the same as is reported with Graph histograms.