

WAVETEK

USER'S HANDBOOK

Model 9100
Universal Calibration System

Volume 2 — Performance

Final Width = 215mm

User's Handbook

For

The Model 9100

Universal Calibration System

Volume 2 — Performance

(for Introduction, Installation, Controls (with Tutorial), Manual Mode and Procedure Mode refer to Volume 1 — Operation)
(for Options 250 and 600 refer to Volume 3 — Operation and Performance)

WAVETEK



For any assistance contact your nearest Wavetek Sales and Service Center. Addresses can be found at the back of this handbook.

Due to our policy of continuously updating our products, this handbook may contain minor differences in specification, components and circuit design to the instrument actually supplied. Amendment sheets precisely matched to your instrument serial number are available on request.

WAVETEK is a US registered trademark of Wavetek Corporation.

Wavetek Corporation Standard Warranty Policy

Wavetek warrants that all Products manufactured or procured by Wavetek conform to Wavetek's published specifications and are free from defects in materials and workmanship for a period of one (1) year from the date of delivery to the original Buyer, when used under normal operating conditions and within the service conditions for which they were designed. This warranty is not transferrable and does not apply to used or demonstration products.

The obligation of Wavetek arising from a Warranty claim shall be limited to repairing, or at its option, replacing without charge, any assembly or component (except batteries) which in Wavetek's sole opinion proves to be defective within the scope of the Warranty. In the event Wavetek is not able to modify, repair or replace nonconforming defective parts or components to a condition as warranted within a reasonable time after receipt thereof, Buyers shall receive credit in the amount of the original invoiced price of the product.

Wavetek must be notified in writing of the defect or nonconformity within the Warranty period and the affected Product returned to Wavetek's factory, designated Service Provider, or Authorized Service Center within thirty (30) days after discovery of such defect or nonconformity. Buyer shall prepay shipping charges and insurance for Products returned to Wavetek or its designated Service Provider for warranty service. Wavetek or its designated Service Provider shall pay costs for return of Products to Buyer.

Wavetek shall have no responsibility for any defect or damage caused by improper storage, improper installation, unauthorized modification, misuse, neglect, inadequate maintenance, accident or for any Product which has been repaired or altered by anyone other than Wavetek or its authorized representative or not in accordance with instructions furnished by Wavetek.

The Warranty described above is Buyer's sole and exclusive remedy and no other warranty, whether written or oral, expressed or implied by statute or course of dealing shall apply. Wavetek specifically disclaims the implied warranties of merchantability and fitness for a particular purpose. No statement, representation, agreement, or understanding, oral or written, made by an agent, distributor, or employee of Wavetek, which is not contained in the foregoing Warranty will be binding upon Wavetek, unless made in writing and executed by an authorized representative of Wavetek. Under no circumstances shall Wavetek be liable for any direct, indirect, special, incidental, or consequential damages, expenses, or losses, including loss of profits, based on contract, tort, or any other legal theory.

April 1, 1994

SAFETY WARNING!

If this equipment is used in a manner not specified by the manufacturer, the protection provided by the equipment may be impaired.



This product complies with the requirements of the following European Community Directives:
89/336/EEC (Electromagnetic Compatibility) and 73/23/EEC (Low Voltage)
as amended by **93/68/EEC (CE Marking)**.

However, noisy or intense electromagnetic fields in the vicinity of the equipment can disturb the measurement circuit. Users should exercise caution and use appropriate connection and cabling configurations to avoid misleading results when making precision measurements in the presence of electromagnetic interference.

Contents

	Page
Section 1 The Model 9100 Multifunction Calibrator	See Volume 1 - Operation
Section 2 Installing the Model 9100	See Volume 1 - Operation
Section 3 Model 9100 Controls	See Volume 1 - Operation
Section 4 Using the Model 9100 — Manual Mode	See Volume 1 - Operation
Section 5 Using the Model 9100 — Procedure Mode	See Volume 1 - Operatio

Volume 2 — Performance (*This Volume*)

Section 6 Remote Interfaces

6.1 About Section 6	6-1
6.2 Index of IEEE-488.2 and SCPI Codes used in the Model 9100	6-2
6.3 Introduction	6-4
6.4 Using the Model 9100 in a System	6-8
6.5 Retrieval of Device Status Information	6-15
6.6 Model 9100 SCPI Language - Commands and Syntax	6-24
6.7 The IEEE Bus Interface for the Power Option	6-58
Section 6 Appendix A: IEEE 488.2 Device Documentation Requirements	6-A1
Section 6 Appendix B: SCPI Conformance Information	6-B1
Section 6 Appendix C: IEEE 488.2 Common Commands and Queries Implemented in the Model 9100	6-C1
Section 6 Appendix D: Model 9100 — Device Settings after *RST	6-D1
Section 6 Appendix E: Model 9100 — Device Settings at Power On	6-E1

Section 7 Model 9100 Specifications

7.1 General	7-1
7.2 Options and Associated Products	7-2
7.3 DC Voltage Specifications	7-3
7.4 AC Voltage Specifications	7-4
7.5 DC Current Specifications	7-8
7.6 AC Current Specifications	7-9
7.7 Resistance Specifications	7-14
7.8 Conductance Specifications	7-15
7.9 Frequency Function Specifications	7-16
7.10 Mark/Period Function Specifications	7-17
7.11 % Duty Cycle Function Specifications	7-18
7.12 Auxiliary Functions - Specifications	7-19
7.13 Capacitance Specifications	7-20
7.14 Thermocouple Temperature Specifications	7-21
7.15 RTD Temperature Specifications	7-22
7.16 Logic-Pulses Function Specifications	7-23
7.17 Logic-Levels Function Specifications	7-24
7.18 Insulation/Continuity Specifications	7-25
7.19 Power Specifications	7-27

Section 8 Model 9100 — Routine Maintenance and Test

8.1	About Section 8	8-1
8.2	Routine Maintenance	8-2
8.3	Model 9100 Test and Selftest	8-10
8.4	Printing Selftest Results	8-26
	Section 8 Appendix A Error Reporting Subsystem	8-A1

Section 9 Model 9100 — Specification Verification

9.1	About Section 9	9-1
9.2	The Need for Verification	9-1
9.3	Equipment Requirements	9-2
9.4	Interconnections	9-2
9.5	Verification Points	9-3
9.6	Calculating Absolute Specification Limits	9-4

Section 10 Model 9100 — Calibration

10.1	About Section 10	10.1-1
10.2	The Model 9100 Calibration Mode	10.2-1
	10.2.1 Introduction	10.2-1
	10.2.2 Mode Selection	10.2-2
	10.2.3 Selection of Calibration Mode	10.2-2
	10.2.4 Special Calibration	10.2-5
	10.2.5 Cold Junction Calibration	10.2-8
	10.2.6 Standard Calibration	10.2-12
	10.2.7 Overview of Calibration Operations	10.2-14
10.3	Standard Calibration — Basic Sequences	10.3-1
	10.3.1 Introduction	10.3-2
	10.3.2 Selecting Hardware Configurations	10.3-4
	10.3.3 Selecting Target Calibration Values	10.3-5
	10.3.4 Calibrating the Model 9100 at Target Values	10.3-9
	10.3.5 Standard Calibration of AC Functions	10.3-13
10.4	Front Panel Calibration by Functions	10.4-1
	10.4.1 Introduction	10.4-1
	10.4.2 Summary of Calibration Process	10.4-2
	10.4.3 DC Voltage Calibration	10.4-6
	10.4.4 AC Voltage Calibration	10.4-14
	10.4.5 DC Current Calibration	10.4-20
	10.4.6 AC Current Calibration	10.4-28
	10.4.7 Resistance Calibration	10.4-36
	10.4.8 Capacitance Calibration	10.4-45
	10.4.9 Insulation Resistance Calibration	10.4-51
	10.4.10 Continuity Calibration	10.4-57
10.5	Remote Calibration of the Model 9100 via the IEEE 488 Interface	10.5-1
	10.5.1 The Model 4950 MTS System	10.5-1

Final Width = 215mm



DANGER
HIGH VOLTAGE



**THIS INSTRUMENT IS CAPABLE OF DELIVERING
A LETHAL ELECTRIC SHOCK!**

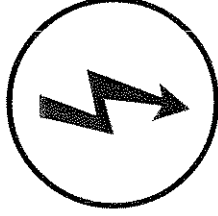

Model 9100: I+, I-, Hi, Lo, sHi and sLo Terminals
Model 9105: H (Red), sH (Red), sL (Black) LI- (Black)
and I+20 (Yellow) Leads carry the Full Output Voltage

THIS CAN KILL !

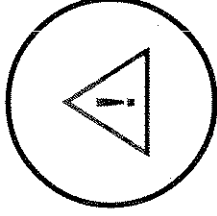

Final Width = 215mm

Avoid damage to your instrument !
Refer to User's Handbook, Volume 2, Section 7; for
Maximum Output Voltages and Currents.

Unless **you** are **sure** that it is **safe** to do so,

DO NOT TOUCH ANY of the following:

Model 9100: I+ I- Hi Lo sHi or SLo leads and terminals

Model 9105: H sH sL LI- or I+20 leads

DANGER

Section 6: 9100 System Application via IEEE-488 Interface

6.1 About Section 6

Section 6 describes the environment in which the Model 9100 will operate in remote applications, using the SCPI (Standard Commands for Programmable Instruments) language, within the IEEE-488.1 remote interface. In Section 6 we shall show how the 9100 adopts the IEEE-488.2 message-exchange model and reporting structure, and define the SCPI commands and syntax used to control the 9100. Section 6 is divided into the following sub-sections:

	page:
6.2 Index of IEEE-488.2 and SCPI Codes used in the 9100	6-2/3
6.3 Introduction	
<i>9100 System Operational Parameters.</i>	
6.3.1 Interface Capability	6-4
6.3.2 Interconnections	6-6
6.3.3 SCPI Programming Language	6-7
6.4 Using the 9100 in a System	
<i>9100 System — Infrastructure.</i>	
6.4.1 Addressing the 9100	6-8
6.4.2 Operation via the IEEE-488 Interface	6-10
6.4.3 Message Exchange	6-12
6.4.4 Request Service (RQS)	6-14
6.5 Retrieval of Device Status Information.	
<i>9100 'SCPI' Status Reporting Structure, based on IEEE-488.2.</i>	
6.5.1 General	6-15
6.5.2 IEEE-488 and SCPI Standard-Defined Features	6-17
6.5.3 9100 Status Reporting — IEEE-488.2 Basics	6-18
6.5.4 9100 Status Reporting — SCPI Elements	6-23
6.6 9100 SCPI Language — Commands and Syntax.	
<i>Detailed treatment of the 9100 SCPI Command Set</i>	
6.6.1 Introduction	6-24
6.6.2 CALibration Subsystem	6-25
6.6.3 OUTPut Subsystem	6-28
6.6.4 SOURce Subsystem	6-30
6.6.5 STATus Subsystem	6-49
6.6.6 SYSTEM Subsystem	6-53
Appendix A: IEEE 488.2 Device Documentation Requirements	6-A1
Appendix B: SCPI Command Set & Conformance Information	6-B1
Appendix C: IEEE 488.2 Common Commands and Queries	6-C1
Appendix D: *RST (Reset) Conditions	6-D1
Appendix E: Power-on Conditions	6-E1

Final Width = 215mm

6.2 Index of IEEE 488.2 and SCPI Codes used in the 9100

6.2.1 Common IEEE 488.2 Commands and Queries

Program Coding	Description	Appendix C, Page:
*CLS	Clears event registers and queues (not O/P queue)	6-C1
*ESE Nrf	Enables standard-defined event bits	6-C2
*ESE?	Returns ESE register mask value	6-C2
*ESR?	Reads Event Status register	6-C3
*IDN?	Reports manufacturer, model, etc.	6-C4
*OPC	Sets the 9100 to monitor the 'No-Operations-Pending' flag.	6-C5
*OPC?	For 'No-Operations-Pending' flag 'TRUE', places a 1 in the Output Queue.	6-C5
*OPT?	Recalls the instrument's option configuration.	6-C6
*PSC 0/1	Sets/resets power-on status clear flag	6-C7
*PSC?	Recalls power-on status clear flag	6-C8
*PUD	Allows entry of user data to protected store	6-C9
*PUD?	Recalls user-entered data	6-C10
*RST	Resets instrument to power on condition	6-C11 / App D, p6-D1
*SRE Nrf	Enables Service Request Byte bits	6-C11
*SRE?	Returns Service Request Byte mask value	6-C12
*STB?	Non-destructively reads Service Request Byte	6-C12
*TST?	Perform Full Test	6-C13
*WAI	Conforms, but little relevance to 9100 application	6-C14

Final Width = 215mm

6.2.2 9100 SCPI Subsystems

CALibration	Used to calibrate the functions and hardware ranges of the 9100, correcting for system errors which have accumulated due to drift and ageing effects: 6-25
	:PASSWORD. Gains access to Calibration operations, using 'Cal Enable' switch and Password. 6-25
	:EXIT. Permits clean exit from calibration operation 6-26
TARGet	Sets up the calibration target point, hardware range (and frequency, where required). 6-27
TRIGger?	Initiates the calibration at a single point, once the target and levels have been set up, and returns '0' for pass, and '1' for fail 6-27
SPECIAL?	Runs the DAC characterization and returns '0' for pass, and '1' for fail 6-27
CJUNCTION?	Runs the reference thermocouple junction temperature measurement and returns '0' for pass, and '1' for fail 6-27
OUTPut	Used to control parameters associated with output connections: 6-28
[STATe] (?)	Controls output on/off switching 6-28
COMPensation (?)	Switches the output connections for 4-wire/2-wire in impedance functions 6-28
ISELectioN (?)	For Current outputs, selects between front panel terminals (High currents, Current coils), and front panel D-type Socket (Low currents) 6-29
[SOURce]	Used to select the main 9100 Function (Voltage, Current etc.), to be output: 6-30
FUNCTION	Selects the Waveshape of output signals 6-32
VOLTage	Selects the Voltage source for output 6-34
CURRent	Selects the Current source for output 6-36
RESistance	Selects the Resistance source for output 6-37
CONDuctance	Selects the Conductance source for output 6-38
CAPacitance	Selects the Capacitance source for output 6-39
FREQUency	Controls the Output Frequency value for AC functions 6-40
PHASe	Selects and controls the Phase-shifting facility 6-41
PULSe	Selects and controls the Pulse source for output 6-43
TEMPerature	Selects and controls the Temperature sources for output 6-44
STATus	Gives access to the 9100 SCPI-defined Status Reporting Structure: 6-49
OPERation	Reads from, or writes to, the OPERATION Status Register 6-49
QUESTionable	Reads from, or writes to, the QUESTIONABLE Status Register 6-51
PRESet	Presets a default status reporting condition 6-52
SYSTem	Collects general functions that are not related to 9100 performance: 6-53
ERRor?	Requests the next entry from the 9100 error queue. 6-53
DATE(?)	Reads or writes the present date 6-54
TIME(?)	Reads or writes the present time 6-55
SVOLTage(?)	Reads or writes the Safety Threshold Voltage in DC or AC Voltage function 6-56
VERsion?	Returns a numeric value corresponding to the SCPI version for which the instrument complies .. 6-56

Final Width = 215mm

6.3 Introduction

This first part of Section 5 gives the information necessary to put the 9100 into operation on the IEEE 488 bus. For more detailed information, refer to the standard specification in the publications ANSI/IEEE Std. 488.1-1987 and IEEE Std. 488.2-1988.

6.3.1 Interface Capability

6.3.1.1 IEEE Standards 488.1 and 488.2

The 9100 conforms to the Standard Specification IEEE 488.1-1987: 'IEEE Standard Digital Interface for Programmable Instrumentation', and to IEEE 488.2-1988: 'Codes, Formats, Protocols and Common Commands'.

6.3.1.2 The 9100 in IEEE 488.2 Terminology

In IEEE 488.2 terminology the 9100 is a **device** containing a **system interface**. It can be connected to a **system** via its **system bus** and set into programmed communication with other bus-connected **devices** under the direction of a **system controller**.

6.3.1.3 Programming Options

The instrument can be programmed via the IEEE Interface, to:

- Change its operating state (Function, Range, etc).
- Transmit its own status data over the bus.
- Request service from the system controller.

6.3.1.4 Capability Codes

To conform to the IEEE 488.1 standard specification, it is not essential for a device to encompass the full range of bus capabilities. For IEEE 488.2, the device must conform exactly to a specific subset of IEEE 488.1, with a minimal choice of optional capabilities.

The IEEE 488.1 document describes and codes the standard bus features, for manufacturers to give brief coded descriptions of their own interfaces' overall capability. For IEEE 488.2, this description is required to be part of the device documentation. A code string is often printed on the product itself.

The codes which apply to the 9100 are given in table 6.1, together with short descriptions. They also appear on the rear of the instrument next to the interface connector. These codes conform to the capabilities required by IEEE 488.2.

Appendix C of the IEEE 488.1 document contains a fuller description of each code.

IEEE 488.1 Subset	Interface Function
SH1	Source Handshake Capability
AH1	Acceptor Handshake Capability
T6	Talker (basic talker, serial poll, unaddressed to talk if addressed to listen)
L4	Listener (basic listener, unaddressed to listen if addressed to talk)
SR1	Service Request Capability
RL1	Remote/Local Capability (incl. Local Lockout)
PP0	No Parallel Poll Capability
DC1	Device Clear Capability
DT0	No Device Trigger Capability
C0	No Controller Capability
E2	Open-Collector and Three-State Drivers
Table 6.1	
IEEE 488.1 Interface Capability	

Final Width = 215mm

6.3.1.5 Bus Addresses

When an IEEE 488 system comprises several instruments, a unique 'Address' is assigned to each to enable the controller to communicate with them individually.

Only one address is required for the 9100. The application program adds information to it to define 'talk' or 'listen'. The method of setting the address, and the point at which the user-initiated address is recognized by the 9100, is given in *Sub-Section 6.4.1*.

The 9100 has a single primary address, which can be set by the user to any value within the range from 0 to 30 inclusive. It cannot be made to respond to any address outside this range. Secondary addressing is not available.

6.3.1.6 Limited Access

The 9100 has five main modes, which are described briefly in *Volume 1 of this Handbook, Section 1, Sub-section 1.2.2*. Remote operation is available only subject to the following limitations:

- **Procedure Mode**
When the 9100 is in Procedure Mode, it is driven essentially from the front panel. Remote Operation will not be allowed in this mode.
N.B. The 9100 can be powered up in either Manual mode or Procedure mode, as set locally in Configuration mode.
- **Manual Mode**
Remote operation is available for each Manual mode function, but for ease of programming, some remote commands do not mirror front panel operations exactly.
- **Configuration Mode**
Remote operation is not available, and configuration commands have not been included in the SCPI command set for the 9100.
- **Calibration Mode**
Remote operation is available, but refer to *Sub-section 6.6.2* for details of entry protection.
- **Test Mode**
Remote operation is not available, but the 'Full' selftest can be initiated by a SCPI command. The 9100 will give a straight Pass/Fail response, but to investigate further, it will be necessary to re-run the test in Test mode from the front panel.

Final Width = 215mm

6.3.2 Interconnections

Instruments fitted with an IEEE 488 interface communicate with each other through a standard set of interconnecting cables, as specified in the IEEE 488.1 Standard document.

The IEEE-488 interface socket, J101, is fitted on the rear panel. It accommodates the specified connector, whose pin designations are also standardized as shown in Table 6.2.

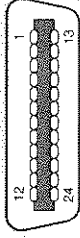

Connector J101 - Pin Layout

Pin No.	Name	Description
1	DIO 1	Data Input/Output Line 1
2	DIO 2	Data Input/Output Line 2
3	DIO 3	Data Input/Output Line 3
4	DIO 4	Data Input/Output Line 4
5	EOI	End of Identify
6	DAV	Data Valid
7	NRFD	Not Ready For Data
8	NDAC	Not Data Accepted
9	IFC	Interface Clear
10	SRQ	Service Request
11	ATN	Attention
12	SHIELD	Screening on cable (connected to 9100 safety ground)
13	DIO 5	Data Input/Output Line 5
14	DIO 6	Data Input/Output Line 6
15	DIO 7	Data Input/Output Line 7
16	DIO 8	Data Input/Output Line 8
17	REN	Remote Enable
18	GND 6	Gnd wire of DAV twisted pair
19	GND 7	Gnd wire of NRFD twisted pair
20	GND 8	Gnd wire of NDAC twisted pair
21	GND 9	Gnd wire of IFC twisted pair
22	GND 10	Gnd wire of SRQ twisted pair
23	GND 11	Gnd wire of ATN twisted pair
24	GND	9100 Logic Ground (internally connected to Safety Ground)

Table 6.2 Connector J101 - Pin Designations

Final Width = 215mm

6.3.3 SCPI Programming Language

Standard Commands for Programmable Instruments (SCPI) is an instrument command language which goes beyond *IEEE 488.2* to address a wide variety of instrument functions in a standard manner.

IEEE 488.2 defines sets of Mandatory Common Commands and Optional Common Commands along with a method of Standard Status Reporting. The 9100 implementation of SCPI language conforms with all *IEEE-488.2* Mandatory Commands but not all Optional Commands. It conforms with the SCPI-approved Status Reporting method.

Note: Commands in SCPI language, prefaced by an asterisk (eg: *CLS), are *IEEE-488.2* standard-defined 'Common' commands.

Conformance of the 9100 remote programming commands to SCPI ensures that the 9100 has a high degree of consistency with other conforming instruments. For most specific commands, such as those relating to frequency and voltage, the SCPI approved command structure already exists and has been used wherever possible.

SCPI commands are easy to learn, self-explanatory and account for a wide variety of usage skills. A summary of the 9100 commands is given on *pages 6-2 and 6-3*. The full range of 9100 commands, with their actions and meanings in the 9100, is detailed in alphabetical order in *Sub-Section 6-6*.

Final Width = 215mm

6.4 Using the 9100 in a System

6.4.1 Addressing the 9100

6.4.1.1 Accessing the Bus Address

The instrument address can only be set manually; using the **Bus Address** menu, which is accessed via the **Configuration** menus.

N.B. A password is required for access to change the bus address.

6.4.1.2 Select 'Configuration' Mode

1. Press the **Mode** key on the right of the front panel to obtain the 'Mode Selection' menu screen:
2. Press the **CONFIG** screen key at the center of the bottom row to progress into 'Configuration' mode. The 9100 will transfer to the open 'Configuration' menu screen:

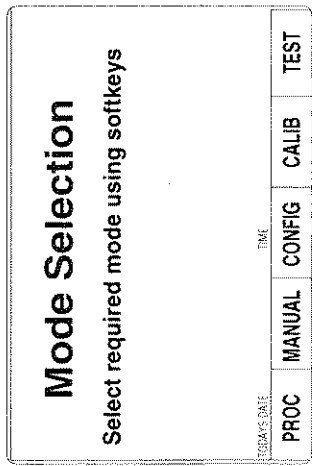

Final Width = 215mm

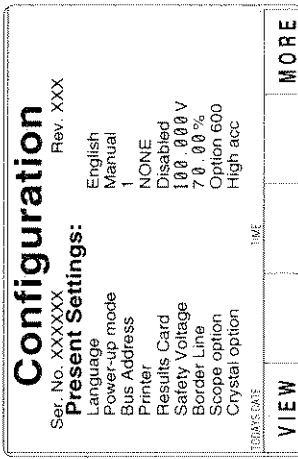

6.4.1.3 Select 'MORE' Parameters

The bus address is one of the 'MORE' parameters. By trying to select 'MORE', the 'Configuration' password will be required.

Press the **MORE** screen key on the right of the bottom row. The 9100 will transfer to the 'Password Entry' screen.

6.4.1.4 Enter Your Password

- When you enter your password using the alpha-numeric keyboard, security icons will appear on the screen as you type. Finally press the ↵ (return) key. If the password is incorrect: an error message will be given and the security icons will be removed, enabling a new attempt to enter the password. The **EXIT** screen key acts to escape, back to the previous screen.

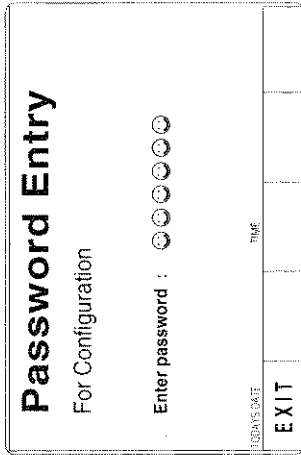

- The correct password, followed by ↵, will provide entry to the main 'Configuration' menu screen, which shows the present settings of the parameters which can be changed using screen keys on this display:
- In this case we are interested in 'BUS ADDRESS'.

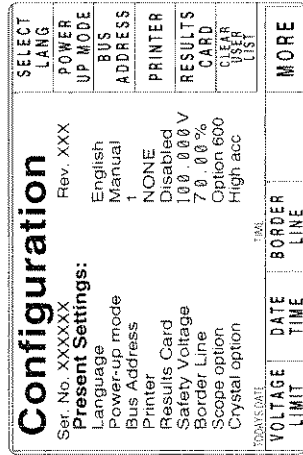

6.4.1.5 Change the Bus Address

- For access from the 'Present Settings' screen, press the **BUS ADDRESS** screen key on the right. This action will transfer to the 'Change the address' screen:

The 9100 IEEE-488 bus address can be set to any number within the range 0 to 30.

- Use Digit edit or Direct edit to set the required bus address number. If using Direct edit, after typing the number press the ↵ key.
- Press **EXIT** to return to the 'Present Settings' screen.

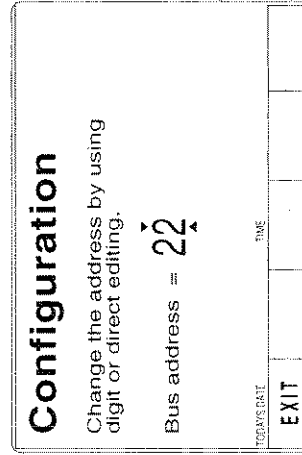

Note: Address Recognition

With an address selected in the range 0 to 30; control may be manual, or remote as part of a system on the Bus. The address must be the same as that used in the controller program to activate the 9100. The 9100 is always aware of its stored address, responding to Talk or Listen commands from the controller at that address. When the address is changed by the user, the 9100 recognizes its new address and ignores its old address, as soon as it is stored by the user pressing the **EXIT** key in the **Configuration — Bus Address** menu.

6.4.2 Operation via the IEEE-488 Interface

6.4.2.1 General

The power-up sequence is performed as in local operation. The 9100 can be programmed to generate an SRQ at power-up, also preparing a status response for transmission to the controller when interrogated by a subsequent serial poll.

6.4.2.2 Operating Conditions

When the 9100 is operating under the direction of the application program, there are two main conditions, depending on whether the application program has set the 'REN' management line 'true' or 'false':

1. REN True ('REN' line low):

The 9100 can be addressed and commanded if in either 'Manual' or 'Calibration' mode. All access to front panel control will be removed, except for the bottom right screen key, labelled 'Enable Local Usage'. The cursor controls will not be present.

If *LLO* (Local Lockout) has been sent with REN true, then the 'Enable Local Usage' screen key will be inoperative. If *LLO* has not been sent, the 'Enable Local Usage' screen key will return to local control as if REN were false (see 2 below).

The 9100 will act in response to valid commands, performing any changes in output, etc. The display presentation will track the changes.

Remote control cannot command 'Configuration' mode or 'Procedure' mode. These are Local Modes only. Remote control cannot break into locally-entered 'Configuration' mode, 'Procedure' mode or 'Test' mode. However, 'Test' can be run remotely.

2. REN False ('REN' line high):

The 9100 will remain in Local Operation, but can be addressed and commanded, while full access to front panel control is also retained.

The 9100 will act in response to the commands, performing any changes in output, etc. These changes will occur rapidly enough for the only noticeable effect to be the display presentation tracking the changes.

6.4.2.3 Programmed Transfer to Local Control (GTL or REN False)

The application program can switch the 9100 into 'Local' Control (by sending Command *GTL*, or by setting the *REN* line *false*), permitting a user to take manual control from the front panel.

The application program can regain 'Remote' control by sending the overriding command: *Listen Address* with *REN* true (addressing the 9100 as a listener with the Remote Enable management line true {Low}). This will re-impose remote control, unless the 9100 is in Configuration, Procedure or Test Mode.

6.4.2.4 'Device Clear'

Either of the commands *DCL* or *SDC* will force the following instrument states:

- all IEEE 488 input and output buffers cleared;
- with 'IFC' (Interface Clear), any device-dependent message bus holdoffs cleared.
- the status byte is changed by clearing the MAV bit.

These commands **will not**:

- change any settings or stored data within the device except as listed above;
- interrupt analog output;
- interrupt or affect any functions of the device not associated with the IEEE 488 system;

6.4.2.5 Levels of Reset

Three levels of reset are defined for IEEE 488.2 application programs, a complete system reset being accomplished by resetting at all three levels, in order, to every device. In other circumstances they may be used individually or in combination:

IFC Bus initialization;

DCL Message exchange initialization;

***RST** Device initialization.

The effects of the *RST command are described in *Appendix C* to this section.

Final Width = 215mm

6.4.3 Message Exchange

6.4.3.1 IEEE 488.2 Model

The IEEE 488.2 Standard document illustrates its Message Exchange Control Interface model at the detail level required by the device designer. Much of the information at this level of interpretation (such as the details of the internal signal paths etc.) is transparent to the application programmer. However, because each of the types of errors flagged in the Event Status Register is related to a particular stage in the process, a simplified 9100 interface model can provide helpful background. This is shown below in Fig. 6.1, together with brief descriptions of the actions of its functional blocks.

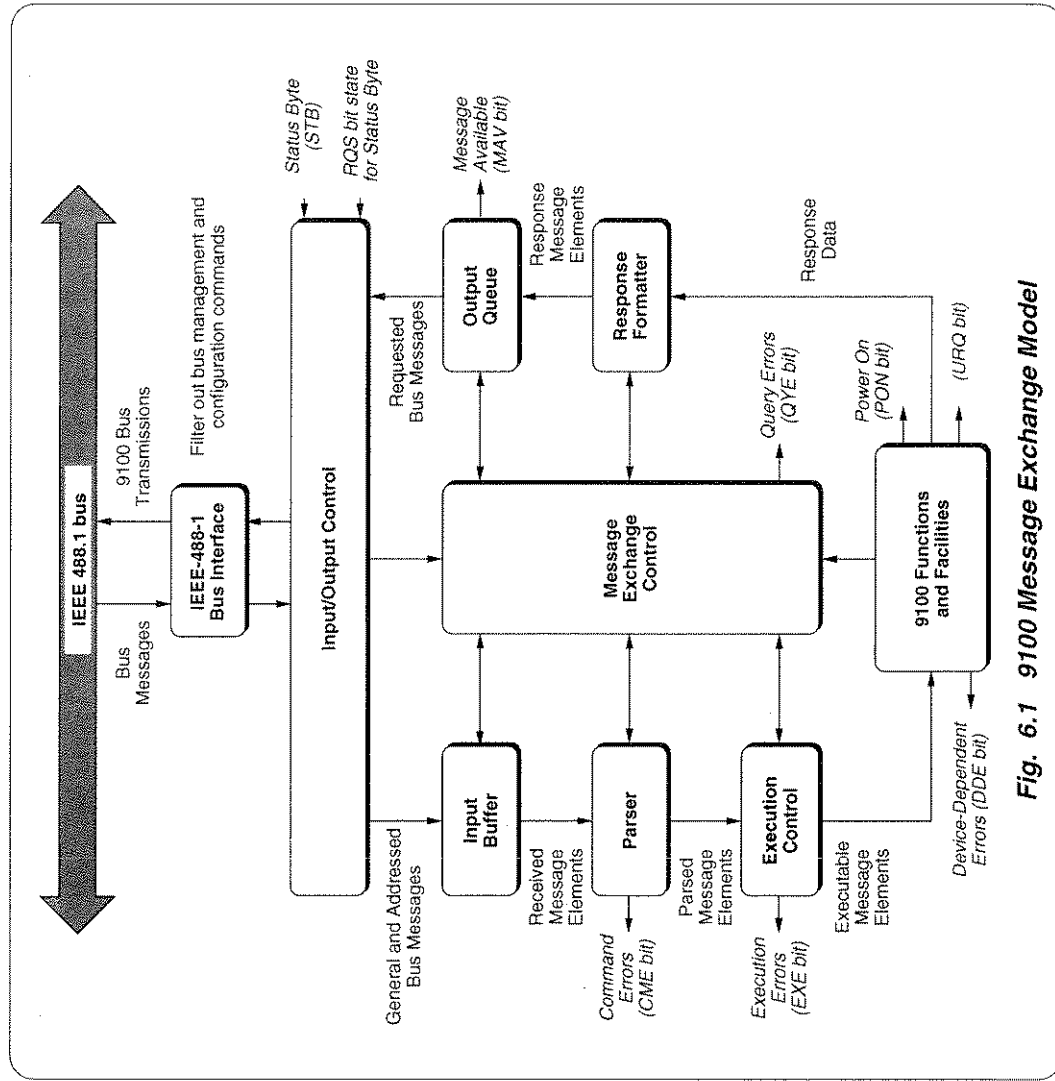

Fig. 6.1 9100 Message Exchange Model

6.4.3.2 9100 STATUS Subsystem

Input/Output Control transfers messages from the 9100 output queue to the system bus; and conversely from the bus to either the input buffer, or other predetermined destinations within the device interface. It receives the Status Byte from the status reporting system, as well as the state of the Request Service bit which it imposes on bit 6 of the Status Byte response. Bit 6 reflects the 'Request Service state *true*' condition of the interface.

6.4.3.3 Incoming Commands and Queries

The **Input Buffer** is a first in - first out queue, which has a maximum capacity of 128 bytes (characters). Each incoming character in the I/O Control generates an interrupt to the instrument processor which places it in the Input Buffer for examination by the Parser. The characters are removed from the buffer and translated with appropriate levels of syntax checking. If the rate of programming is too fast for the Parser or Execution Control, the buffer will progressively fill up. When the buffer is full, the handshake is held.

The **Parser** checks each incoming character and its message context for correct Standard-defined generic syntax, and correct device-defined syntax. Offending syntax is reported as a **Command Error**, by setting true bit 5 (CME) of the Standard-defined Event Status register (refer to Sub-Section 6.5 'Retrieval of Device Status Information').

Execution Control receives successfully parsed messages, and assesses whether they can be executed, given the currently-programmed state of the 9100 functions and facilities. If a message is not viable then an Execution Error is reported, by setting true bit 4 (EXE) of the Standard-defined Event Status register. Viable messages are executed in order, altering the 9100 functions, facilities etc. Execution does not 'overlap' commands; instead, the 9100 Execution Control processes all commands or *coupled groups of commands* (see Note in left column) 'sequentially' (ie. waits for actions resulting from the previous command to complete before executing the next).

6.4.3.4 9100 Functions and Facilities

The 9100 Functions and Facilities block contains all the device-specific functions and features of the 9100, accepting Executable Message Elements from Execution Control and performing the associated operations. It responds to any of the elements which are valid Query Requests (both IEEE 488.2 Common Query Commands and 9100 Device-specific Commands) by sending any required Response Data to the Response Formatter (after carrying out the assigned internal operations).

Device-dependent errors are detected in this block. Bit 3 (DDE) of the Standard Event Status register is set true when an internal operating fault is detected. Each reportable error number is appended to the Error Queue as the error occurs.

Note: Coupled Commands

Coupled commands are best described by an example:

In Section 7, on pages 7-5 and 7-10, the 'Volt-Hz' and 'Amp-Hz' profiles are given. In the 9100, no AC output can be generated whose product of amplitude and frequency occurs outside the relevant profile.

With sequential execution of commands a change in amplitude and frequency (e.g.: VOLT 121.; FREQ 10E3 - a setting within the profile) would cause an execution error if the present frequency was 50kHz, as the combination of 121V and 50kHz is outside the profile

Such anomalies are overcome by defining a coupling between commands which allows the execution of the individual components to be deferred until all **contiguous** coupled commands in the same group have been parsed and the validity of the combination checked

Note that this does not require that all the coupled components in a group must be supplied for each new signal but that those programmed will be correctly parsed.

Individual commands may be a member of several coupled command groups. Refer to Appendix A to this Section, page 6-A-1, for details of coupled groups.

6.4.3.5 Outgoing Responses

The **Response Formatter** derives its information from Response Data (being supplied by the Functions and Facilities block) and valid Query Requests. From these it builds Response Message Elements, which are placed as a Response Message into the Output Queue.

The **Output Queue** acts as a store for outgoing messages until they are read over the system bus by the application program. For as long as the output queue holds one or more bytes, it reports the fact by setting true bit 4 (Message Available - MAV) of the Status Byte register. Bit 4 is set false when the output queue is empty (*refer to Sub-Section 6.5 'Retrieval of Device Status Information'*).

6.4.3.6 'Query Error'

This is an indication that the application program is following an inappropriate message exchange protocol, resulting in the *Interrupted, Unterminated or Deadlocked* condition: Refer to 'Bit 2' in *paras 6.5.3.5*.

The Standard document defines the 9100's response, part of which is to set true bit 2 (QYE) of the Standard-defined Event Status register.

6.4.4 Request Service (RQS)

6.4.4.1 Reasons for Requesting Service

There are two main reasons for the application program to request service from the controller:

- When the 9100 message exchange interface is programmed to report a system programming error;
- When the 9100 is programmed to report significant events by RQS.

The significant events vary between types of devices; thus there is a class of events which are known as 'Device-Specific'. These are determined by the device designer.

6.4.4.2 RQS in the IEEE 488.2 Model

The application programmer can enable or disable the event(s) which are required to originate an RQS at particular stages of the application program. The IEEE-488.2 model is extended to incorporate a flexible SCPI status reporting structure in which the requirements of the device designer and application programmer are both met.

This structure is described in *Sub-Section 6.5*, dealing with 'Retrieval of Device Status Information'.

6.5 Retrieval of Device Status Information

6.5.1 General

For any remotely-operated system, the provision of up-to-date information about the performance of the system is of major importance. In the case of systems which operate under automatic control, the controller requires the necessary feedback to enable it to progress the task; any break in the continuity of the process can have serious results.

When developing an application program, the programmer needs to test and revise it, knowing its effects. Confidence that the program elements are couched in the correct grammar and syntax (and that the program commands and queries are thus being accepted and acted upon), helps to reduce the number of iterations needed to confirm and develop the viability of the whole program. So any assistance which can be given in closing the information loop must benefit both program compilation and subsequent use.

Such information is given in the following pages.

Final Width = 215mm

SCPI Status Structure Registers IEEE 488.2 Status Structure Registers

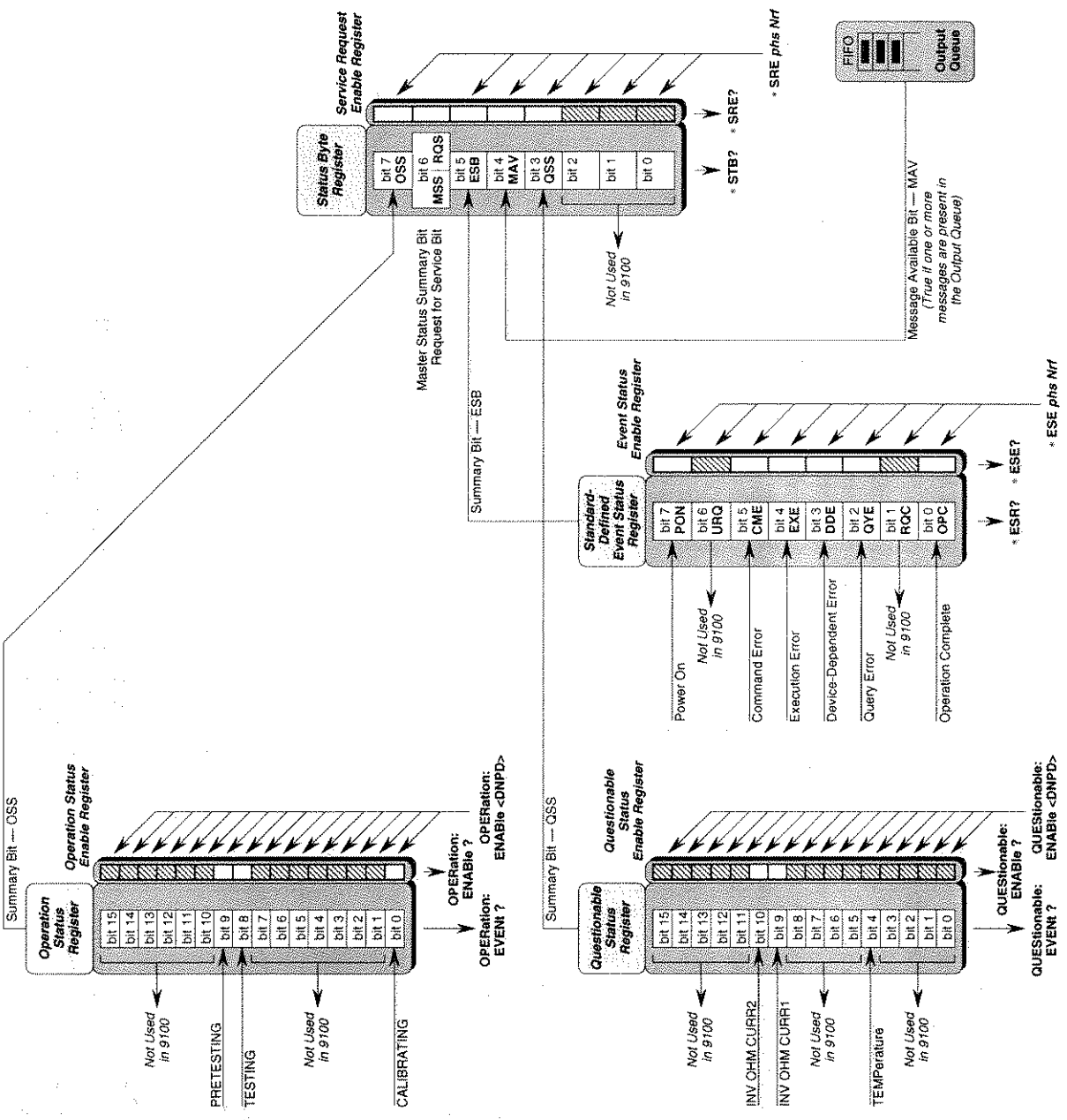

Fig. 6.2 9100 Status Reporting Structure

Final Width = 215mm

6.5.2 IEEE-488 and SCPI Standard-Defined Features (Fig. 6.2)

Two main categories of information are provided: 'Status Summary' information, and 'Event Register' conditions.

6.5.2.1 Status Summary Information and SRQ

The Status Byte consists of four 'summary' bits which notify events in the 8-bit latched IEEE-488.2-defined 'Event Status Register' (ESB), the two 16-bit latched SCPI-defined registers (OSS & QSS), and the Output Queue (MAV). Whenever one of these summary bits is enabled and set *true*, the Status Byte summary bit (MSS) is also set *true*. The buffered bit 'RQS' follows *true* when MSS goes true, and will set the IEEE-488 SRQ line *true* (Note that in Fig 6.2 no arrow points at bit 6 of the Service Request Enable Register — bit 6 is always enabled).

A subsequent serial poll by the Application Program will discover that the 9100 was the requesting device (while resetting RQS *false* again, MSS remaining *true*), and which of the summary bits is *true*. The *STB? command is an equivalent command to serial poll, where serial poll is not available.

6.5.2.2 Event Register Conditions

The Status Byte summary bits direct the application program down the structure towards causal events.

ESB and MAV are standard IEEE-488 features, described in detail in *Sub-Section 6.5.3*.

OSS and QSS are features of the SCPI structure, described in *Sub-Section 6.5.4*.

6.5.2.3 Access via the Application Program

Referring to Fig. 6.2, take as an example the main Event Status register:

Enabling the Events

The main *Standard-Defined Event Status Register* has a second *'Event Status Enable Register'*. A program command (*ESE *phs Nrf*) can be used to set the state of the bits in the *Enable* register. This enables or disables the events which will set the main register's summary bit *true*.

Reading the Enable Register

A 'query' command (*ESE?) permits the application program to read the state of the *Enable* register, and hence find out which events are enabled to be reported.

Reading the Main Register

Another 'query' command (*ESR?) reads the state of the main *Standard-Defined* register, to discover which event has occurred (i.e. has caused the summary bit to be set *true*). Reading this register clears all its bits.

Reporting the Event

If an event is to be reported via the SRQ, its corresponding *enable* bit will have been set *true*, (using the number *Nrf*). Each bit in the *Standard-Defined* register remains in *false* condition unless its assigned event occurs, when its condition changes to *true* and remains *true* until cleared by *ESR? or *CLS. This causes the register's summary bit in the Status Byte also to be set *true*. If this bit is enabled, then the Status Byte bit 6 (MSS/RQS) will be set *true*, and the 9100 will set the IEEE-488 bus SRQ line *true*.

SCPI Status Registers

The two SCPI Status registers operate in the same way, using the appropriate program commands to set the enable registers, and query commands to discover the condition of the registers.

Subsequent Action

Thus the application programmer can enable any assigned event to cause an SRQ, or not. The controller can be programmed to read the Status Byte, using a serial poll to read the Status Byte register and the *true* summary bit (ESB, OSS, QSS or MAV). The application program then investigates the appropriate event structure until the causal event is discovered. The detail for each register is expanded in the following paragraphs, and in the command descriptions.

Note about the ERROR Queue

The Error Queue is a sequential memory stack. Each reportable error has been given a listed number and explanatory message, which are entered into the error queue as the error occurs. The queue is read destructively as a First-In/First-Out stack, using the query command SYSTEM ERROR? to obtain a code number and message.

Repeated use of the query SYSTEM ERROR? will read successive Device-Dependent, Command and Execution errors until the queue is empty, when the 'Empty' message (0, "No error") will be returned.

It would be good practice to repeatedly read the Error Queue until the 'Empty' message is returned.

The common command *CLS clears the queue.

6.5.3.5 IEEE 488.2-defined Event Status Register

The 'Event Status Register' holds the Event Status Byte, consisting of event bits, each of which directs attention to particular information. All bits are 'sticky'; i.e. once *true*, cannot return to *false* until the register is cleared. This occurs automatically when it is read by the query: *ESR?. The common command *CLS clears the Event Status Register and associated error queue, but not the Event Status Enable Register.

Note that because the bits are 'sticky', it is necessary to read the appropriate subordinate register of the status structure in order to clear *its* bits and allow a new event from the same source to be reported.

The 'Event Status Register' bits are named in mnemonic form as follows:

Bit 0 Operation Complete (OPC)

This bit is *true* only if *OPC has been programmed *and* all selected pending operations are complete. As the 9100 operates in serial mode, its usefulness is limited to registering the completion of long operations, such as self-test.

Bit 1 Request Control (RQC)

This bit is not used in the 9100. It is always set *false*.

Bit 2 Query Error (QYE)

QYE *true* indicates that the application program is following an inappropriate message exchange protocol, resulting in the following situations:

- **Interrupted Condition.** When the 9100 has not finished outputting its **Response Message** to a **Program Query**, and is interrupted by a new **Program Message**.
- **Unterminated Condition.** When the application program attempts to read a **Response Message** from the 9100 without having first sent the complete **Query Message** (including the **Program Message Terminator**) to the instrument.
- **Deadlocked Condition.** When the input and output buffers are filled, with the parser and the execution control blocked.

Bit 3 Device Dependent Error (DDE)

DDE is set *true* when an internal operating fault is detected, and the appropriate error message is added to the Error Queue. See the 'Note about the Error Queue' in the previous column.

Bit 4 Execution Error (EXE)

An execution error is generated if the received command cannot be executed, owing to the device state or the command parameter being out of bounds. The appropriate error message is added to the Error Queue. See the 'Note about the Error Queue' in the previous column.

Bit 5 Command Error (CME)

CME occurs when a received bus command does not satisfy the IEEE 488.2 generic syntax or the device command syntax programmed into the instrument interface's parser, and so is not recognized as a valid command. The appropriate error message is added to the Error Queue. See the 'Note about the Error Queue' on the previous page.

Bit 6 User Request (URQ)

This bit is not used in the 9100. It is always set *false*.

Bit 7 9100 Power Supply On (PON)

This bit is set *true* only when the Line Power has just been switched on to the 9100, the subsequent Power-up Selftest has been completed successfully, and the 9100 defaults into Manual mode at Power-on. (If the Power-on default is Procedure mode, remote operation is not available. If the selftest is unsuccessful, the 9100 will report the fact in Test mode, which also does not permit remote operation).

Whether or not an SRQ is generated by setting bit 7 *true*, depends on the previously-programmed 'Power On Status Clear' message *PSC *phis Nrf*:

- For an *Nrf* of 1, the Event Status Enable register would have been cleared at power on, so PON would not generate the ESB bit in the Status Byte register, and no SRQ would occur at power on.
- If *Nrf* was zero, **and** the Event Status Enabling register bit 7 *true*, **and** the Service Request Enabling register bit 5 *true*; a change from Power Off to Power On will generate an SRQ. This is only possible because the enabling register conditions are held in non-volatile memory, and restored at power on.

This facility is included to allow the application program to set up conditions so that a momentary Power Off followed by reversion to Power On (which could upset the 9100 programming) will be reported by SRQ. To achieve this, the Event Status register bit 7 must be permanently *true* (by *ESE *phis Nrf*, where *Nrf* ≥ 128); the Status Byte Enable register bit 5 must be set permanently *true* (by command *SRE *phis Nrf*, where *Nrf* lies in one of the ranges 32-63, 96-127, 160-191, or 224-255); Power On Status Clear must be disabled (by *PSC *phis Nrf*, where *Nrf* = 0); and the Event Status register must be read destructively immediately following the Power On SRQ (by the common query *ESR?).

6.6 9100 SCPI Language - Commands and Syntax

The command subsystems are placed in alphabetical order.

6.6.1 Introduction

This Sub-Section lists and describes the set of SCPI-compatible remote commands used to operate the 9100. To provide familiar formatting for users who have previously used the SCPI reference documentation, the command descriptions are dealt with in a similar manner. In particular, each sub-system's documentation starts with a short description, followed by a table showing the complete set of commands in the sub-system; finally the effects of individual keywords and parameters are described. Some extra identification of style and syntax is detailed in *paras 6.6.1.1 and 6.6.1.2* to clarify shorthand meanings.

6.6.1.1 SCPI Syntax and Styles

Where possible the syntax and styles used in this section follow those defined by the SCPI consortium. The commands on the following pages are broken into three columns; the **KEYWORD**, the **PARAMETER FORM**, and any **NOTES**. The **KEYWORD** column provides the name of the command. The actual command consists of one or more keywords since SCPI commands are based on a hierarchical structure, also known as the tree system.

Square brackets ([]) are used to enclose a **keyword** that is optional when programming the command; that is, the 9100 will process the command to have the same effect whether the optional node is omitted by the programmer or not.

Letter case in tables is used to differentiate between the accepted shortform (upper case) and the long form (upper and lower case). The **PARAMETER FORM** column indicates the number and order of parameter in a command and their legal value. Parameter types are distinguished by enclosing the type in angle brackets (< >). If **parameter** form is enclosed by square brackets ([]) these are then optional (care must be taken to ensure that optional parameters are consistent with the intention of the associated keywords). The vertical bar (|) can be read as "or" and is used to separate alternative parameter options.

6.6.1.2 Legend

<DNPD>	=	Decimal Numeric Program Data, used to identify numerical information needed to set controls to required values. The numbers should be in 'N/f' form as described in the IEEE 488.2 Standard Specification.
<CPD>	=	Character Program Data. This normally represents alternative groups of unique 'literate' parameter names, available for the same keyword. In the notation the set of alternatives will follow the <CPD> in the Parameter Form column of the Sub-System table, enclosed in a pair of braces. For example, in the OUTPUT sub-system, the compound command header (keyword): OUTPUT : COMPENSATION is followed by the parameter form <CPD>{ON OFF 0 1}. The <CPD> gives the denomination of 'Character' program data, and {ON OFF 0 1} gives the actual characters to be used to command each unique parameter.
<SPD>	=	String Program Data. This is a string of variable literate characters which will be recognized by the internal 9100 software. They are used for such inputs as passwords, serial numbers and date/time.
?	=	Indicate query commands with no associated command form, and no attached parameters. (for example: CALIBRATION:TRIGGER?).
(?)	=	All commands which may include parameters in the command form, but also have an additional query form without parameters. (for example: OUTPUT:COMPENSATION(?) <CPD>{HIGH LOW})

The response from this query will be one of the parameters listed in association with the command.

6.6.2 CALIBRATION Subsystem

This subsystem is used to calibrate the functions and hardware ranges of the 9100. This will correct for any system errors due to drift or ageing effects.

Before any calibration can take place, two security levels must be set. First, there is a switch on the 9100 itself that must be set to CAL ENABLE. Having done this, the calibration password command must be sent.

Once entered into Calibration mode, the commands present in the table at 6.6.2.1 are enabled.

6.6.2.1 CALIBRATION Subsystem Table

Keyword	Parameter Form	Notes
CALIBRATION		
:SECure	<SPD>	
:PASSword	[<SPD>, <CPD> {PRD7 PRD14 PRD30 PRD60}]	
:EXIT	<DNPD>, <DNPD> [, <DNPD>]	
:TARGet		[query only]
:TRIGger?		[query only]
:SPECial?		
:COUNction?	<DNPD>	

Final Width = 215mm

6.6.2.2 CAL:SEC:PASS <SPD>

Purpose

This command is used to gain access to Calibration mode. The <SPD> must be the correct 'Calibration' password registered in the 9100 software. The calibration password can be changed only in Configuration mode from the 9100 front panel. (Refer to Volume 1 of this User's Handbook, Section 3, Paras 3.3.2.11 and 3.2.2.22).

6.6.2.3 CAL:SEC:EXIT [<SPD>, <CPD> {PRD7 | PRD14 | PRD30 | PRD60}]

Purpose

This command is used to switch off Calibration mode, cancelling any set CAL:TARG command and protecting the calibration by positively disabling the calibration commands. Parameters in the command permit a user optionally to date-stamp the calibration, record the next-due calibration date, and set up an advance warning for that calibration. Certain Functions are not available in Calibration Mode (such as Conductance and Logic Pulses/Levels, for which calibration is not required). When finishing a calibration procedure, it is necessary to exit from Calibration mode in order to access these functions.

- The <SPD> must be the due date of the next calibration for the 9100. It must conform to the format decided by the SYStem FORmat <spd> command.
- In the <CPD>, PRDXX gives the required number of days advance warning of the cal due date. (Refer to Section 10, Paras 10.3.6).

6.6.2 CALIBRATION Subsystem (Contd.)

6.6.2.4 CAL:TARG <DNPD> , <DNPD> [, <DNPD>]

Purpose

For each calibration operation, the required calibration point (factor) must be targetted (Refer to Section 10, Paras 10.3.4). This command permits the user to define three parameters associated with the calibration point in the current operation:

- The first <DNPD> is an integer from 1 to 6, allocated to the calibration point at which calibration is intended. This will be one of those listed on the Calibration mode screen, in 'Target State', for the corresponding function and hardware range.
- The second <DNPD> is a value which will determine the required *hardware range (amplitude)* of the 9100 for that calibration point.
- The third, optional, <DNPD> is a value which will determine the required *hardware range (frequency)* of the 9100 for that calibration point.

For example when the 9100 is in AC Voltage at 30V 1KHZ:

CAL:TARG 1 , 29.001 , 1.05

indicates that calibration of point 1 is required, at a voltage of 29.001V and a frequency of 1.05kHz.

Once a target has been set, the 9100 adjustment is restricted to values within the selected hardware voltage span and frequency band. In order to release this restriction, one of the following commands must be sent:

TRIG? , EXIT or a new TARG command

Any error which occurs will also release the restriction.

Final Width = 215mm

6.6.2.5 CAL:TRIG?

Purpose

After the parameters are set for calibration at a single calibration point, this command initiates the internal calibration process.

Response

If the calibration operation is a success then the command returns a '0'. If the process fails for any reason, then a '1' is returned and an error message is put in the error queue.

6.6.2.6 CAL:SPEC?

Purpose

This command characterizes the instrument's main Digital-to-Analog Converter.

Response

The process takes approximately 15 minutes to complete. If the characterization operation is a success then the command returns a '0'. If the process fails for any reason, then a '1' is returned and an error message is put in the error queue.

6.6.2.7 CAL:CJUN? <dnpd>

Purpose

To obtain a calibration factor from an external measurement of the temperature of the reference junction in its pod, and a similar internal measurement which is triggered by this command.

The <dnpd> MUST be supplied and should be the externally-measured temperature of the pod.

For successful calibration, the pod MUST be fitted and the external measurement MUST be supplied with the command.

This is the remote equivalent of the manual calibration of the pod detailed in *Section 10, paras 10.2.5*. Identification of the association of the pod with a particular host 9100 unit should be recorded as for the manual case (*paras 10.2.5.7*)

Response

If the calibration operation is a success then the command returns a '0'. If the process fails for any reason, then a '1' is returned and an error message is put in the error queue.

Final Width = 215mm

6.6.3 OUTPUT Subsystem

This subsystem is used to select the output connections of the 9100, switch the output on and off, and switch the lead compensation on and off.

6.6.3.1 OUTPUT Subsystem Table

Keyword	Parameter Form	Notes
OUTPUT		
[:STATE] (?)	<CPD>{ON OFF 0 1}	
:COMPensation (?)	<CPD>{ON OFF 0 1}	
:ISElection (?)	<CPD>{HIGH HI50turn HI10turn LOW}	

6.6.3.2 OUTP [:STAT] (?) <CPD>{ON|OFF|0|1}

Purpose

This command turns the 9100 output on and off.

- ON or 1 will set the output on
- OFF or 0 will set the output off

Response to Query Version

The 9100 will return ON if output is on, or OFF if output is off.

6.6.3.3 OUTP :COMP (?) <CPD>{ON|OFF|0|1}

Purpose

This command switches the output connections for 4-wire/2-wire in the impedance functions.

Impedance Functions:

Resistance, Conductance, Capacitance and PRT Temperature.

Response to Query Version

The 9100 will return ON if compensation is on (4-wire), or OFF if compensation is off (2-wire).

6.6.3.4 OOTP:ISEL(?) <CPD>{HIGHi | HI50 | HI10 | LOWi }

Purpose

The I+ Output in Current function can be passed out via the unguarded front panel I+ terminal, or on a guarded line (pin 8) through the D-type socket ('Signal Output' J109) beneath the terminals. Pin 7 of J109 is connected to internal Guard shields for this purpose, and is available for external guard connection. The return is always via the front panel main I- terminal.

The front panel I+ terminal can carry all DC currents and AC currents up to the maximum -20A to +20A output (refer to *Volume 1, Section 4, paras 4.5.5.3* for time limitations). Pin 8 of J109 is limited to -1A to +1A output.

OOTP:ISEL HIGH switches current outputs via the front panel I+ terminal.

OOTP:ISEL HI50 (Option 200) switches current outputs via the front panel I+ terminal, and provides equivalent currents of $\pm(16.0A$ to $1000A)$ into the 50-turn current coil.

OOTP:ISEL HI10 (Option 200) switches current outputs via the front panel I+ terminal, and provides equivalent currents of $\pm(3.2A$ to $200A)$ into the 10-turn current coil.

OOTP:ISEL LOW switches current outputs via J109 pin 8.

Response to Query Version

The 9100 will return HIGH/HI50/HI10/LOW to match the active programming parameter.

Final Width = 215mm

6.6.4 SOURCE Subsystem

This subsystem is used to select the sources of 9100 output .

6.6.4.1 SOURCE Subsystem Table

Keyword	Parameter Form	Notes
[SOURCE]		
:FUNCTION		
[:SHAPE] (?)	<CPD>{DC SINUSOID PULSE SQUARE IMPULSE TRIANGLE TRAPEZOID SYMSQUARE}	
:VOLTage		
[:LEVEL]		
[:IMMEDIATE]		
[:AMPLITUDE] (?)	<DNPd>	
:HIGH (?)	<DNPd>	
:LOW (?)	<DNPd>	
:CURRENT		
[:LEVEL]		
[:IMMEDIATE]		
[:AMPLITUDE] (?)	<DNPd>	
:RESistance		
[:LEVEL]		
[:IMMEDIATE]		
[:AMPLITUDE] (?)	<DNPd>	
:UUT_I (?)	<CPD>{LOW HIGH SUPER}	
:CONductance		
[:LEVEL]		
[:IMMEDIATE]		
[:AMPLITUDE] (?)	<DNPd>	
:UUT_I (?)	<CPD>{LOW HIGH SUPER}	
:CAPacitance		
[:LEVEL]		
[:IMMEDIATE]		
[:AMPLITUDE] (?)	<DNPd>	
:UUT_I (?)	<CPD>{LOW HIGH SUPER}	
:FREquency		
[:CW FIXed] (?)		
:PHASE		
[:ADJJust] (?)		
:INPut		
[:STATE] (?)	<CPD>{ON OFF 0 1}	
:OUTPut		
[:STATE] (?)	<CPD>{ON OFF 0 1}	

Final Width = 215mm

```

[SOURCE] (Cmd)
: PULSE <DNPD>
: PERIOD(?) <DNPD>
: WIDTH(?) <DNPD>
: DCYCLE(?) <DNPD>
: TEMPERATURE <CPD>{C|CEL|F|FAH|K}
: UNITS(?) <CPD>{TS68|TS90}
: SCALE(?)
: THERMOCOUPLE
  [:LEVEL]
  [:IMMEDIATE]
  [:AMPLITUDE](?)
: TYPE(?) <DNPD>{B|C|E|J|K|N|R|S|T}
: PRT
  [:LEVEL]
  [:IMMEDIATE]
  [:AMPLITUDE](?)
: TYPE(?) <DNPD>{PT385|PT392}
: NRESISTANCE(?) <DNPD>
: UUT_I(?) <CPD>{LOW|HIGH|SUPER}
: CONTINUITY
  [:LEVEL]
  [:IMMEDIATE]
  [:AMPLITUDE](?)
: TCURRENT? <DNPD>
: INSULATION
  [:LEVEL]
  [:IMMEDIATE]
  [:AMPLITUDE](?)
: UUT_I(?) <DNPD>
: TVOLTAGE? <CPD>{HIGH|SUPER}
: TCURRENT?

```

Final Width = 215mm

Note to the [SOURCE] Subsystem Table

Many optional keywords are included in the table; shown in square brackets, as required by the SCPI reference document. The structure of the command set is such that in all cases, these optional keywords can be omitted.

Notes about Types of Command Separators

The [SOURCE] subsystem has a complex tree structure. To clarify descriptions (as, for instance, in the table overleaf), examples of branching are referred to the root. In the table, when transferring from, say, a VOLT HIGH command to a VOLT LOW command, the command string returns to the root, so that rather than using the valid short-cut ; branching separator, it is shown as returning to the root by a ; separator.

This does not mean that valid short-cut 'program message unit' separators cannot be used, but merely that we are defining the commands in full, to avoid confusion.

6.6.4.2 [SOUR] : FUNC [: SHAP] (?) <CPD> { DC | SIN | PULS | SQU | IMP | TRI | TRAP | SYMS }

Purpose

Defines the waveshape of the required output. In certain cases this also steers the 9100 towards the required source. This is necessary to select a 9100 source in a particular group, if the present 9100 source lies outside that group.

For example:

DC Voltage and DC Current are listed below in Group 2. To select either of these when neither of Group 2 is already selected, then the command FUNC DC must be used before selecting Voltage or Current.

For those users who are familiar with local (front panel) operation of the 9100, the relationships between the local Function selections and the corresponding remote commands are given in the following table:

[SOURce] Command Group	Equivalent 9100 Local Function	Remote Commands
1	a	RES <DNPd> or RES <DNPd>; RES:UUT_I <CPD>
	b	COND <DNPd> or COND <DNPd>; COND:UUT_I <CPD>
	c	CAP <DNPd> or CAP <DNPd>; COND:UUT_I <CPD>
	d	TEMP:UNIT <CPD>; TEMP:SCAL <CPD>; TEMP:PRT <DNPd> or TEMP:UNIT <CPD>; TEMP:SCAL <CPD>; TEMP:PRT <DNPd>; TEMP:PRT:UUT_I <CPD>
	e	TEMP:UNIT <CPD>; TEMP:THER <DNPd>
2	a	FUNC DC;; VOLT <DNPd>
	b	FUNC DC;; VOLT <DNPd>
	c	FUNC DC;; CURR <DNPd>
3	a	FUNC {SIN IMP TRI TRAP SYMS};; VOLT <DNPd>;; FREQ <DNPd>
	b	FUNC {SIN IMP TRI TRAP SYMS};; CURR <DNPd>;; FREQ <DNPd>
4	Frequency	FUNC SQU;; FREQ <DNPd>;; VOLT:HIGH <DNPd>;; VOLT:LOW <DNPd>
5	a	FUNC PULS;; PULS:PER <DNPd>;; PULS:WID <DNPd>;; VOLT:HIGH <DNPd>;; VOLT:LOW <DNPd>
	b	FUNC PULS;; PULS:PER <DNPd>;; PULS:DCYC <DNPd>;; VOLT:HIGH <DNPd>;; VOLT:LOW <DNPd>
	c	FUNC PULS;; PULS:PER <DNPd>;; PULS:WID <DNPd>;; VOLT:HIGH <DNPd>;; VOLT:LOW <DNPd>

Notes:

- Group 1** No FUNC steering is required. The Thermocouple Temperature source (1e) is included in the same group as the other (PRT) Temperature source.
- Group 2** Steering command: FUNC DC is required. The remote equivalent of the local 'Logic Levels' Function uses the same commands as those for the main local DC Voltage Function.
- Group 3** Steering command: FUNC {SIN|IMP|TRI|TRAP|SYMS} is required. All alternative waveshapes shown are available only in this group.
- Group 4** Steering command: FUNC SQU is required. Hz (Frequency) employs a fixed 50% duty cycle.
- Group 5** Steering command: FUNC PULS is required. All local equivalents include variable Mark/Period ratio.

N.B. The groups of [SOURCE] commands, listed in the table, are not required by SCPI protocol, they have been devised specially for this description only for clearer explanation.

Function Changes and Parameter Defaults

The values set as parameters are *not* retained on change of **Equivalent Local Function (ELF)**, as indicated in the table. When the 9100 is transferred from, say, **ELF 1a** to **ELF 1b**, the programmable parameters of **ELF 1a** will be set to default values, and must be re-programmed on re-entry if different values are required.

<CPD>

The 'character program data' determines the waveshape of the output signal. It can be chosen from eight alternatives:

DC Determines that subsequent selection of VOLT or CURR will choose DC hardware for the output voltage or current. Voltage or Current levels will be set subsequently using the VOLT <DNPD> or CURR <DNPD> commands.

SINusoid Subsequent selection of VOLT or CURR will choose AC hardware for the output voltage or current. Voltage or Current RMS values will be set using the VOLT <DNPD> or CURR <DNPD> commands. Frequency values will be set using the FREQ <DNPD> command.

SQAre Selects a pulsed voltage output, and determines that the mark/period ratio will be 0.5 for any related FREQ selection. High and low voltage levels will be set to default values of +5V and 0V unless otherwise set using the VOLT HIGH and VOLT LOW commands.

PULSe Selects a pulsed voltage output and determines that the mark/period ratio will be set by selections of PULS PER, together with PULS WID or PULS DCYC. High and low voltage levels will be set to default values of +5V and 0V unless otherwise set using the VOLT HIGH and VOLT LOW commands.

IMPulse|TRIangle|TRAPEzoid|SYMSquare

Subsequent selection of VOLT or CURR will choose AC hardware for the output voltage or current, with the 'Impulse, Triangular, Trapezoidal or Symmetrical Square' waveshape (refer to Volume 1, Section 4, paras 4.4.3.4 and 4.4.6.4). Voltage or Current RMS values will be set using the VOLT <DNPD> or CURR <DNPD> commands. Frequency values will be set using the FREQ <DNPD> command.

Examples of using the FUNC element:

An example command message to select a Group 2 source of +10.5V from outside Group 2 would be:
FUNC DC ; VOLT 10.5

Alternatively, to select a Group 3 sinusoidal current source of 200mA at 1kHz from outside Group 3:

```
FUNC SIN ; CURR 200E-3 ; FREQ 1E3
```

To select (from outside Group 5) a pulsed signal of period 200µs and duty cycle 60%, switching between +3.5V and -1.5V:
FUNC PULS ; PULS : PER 2E-4 ; PULS : DCYC 60 ; VOLT : HIGH 3.5 ; VOLT : LOW -1.5

Sources in the Same Group

When selecting a source from within the *same* group as the previous [SOURCE] command, it is *not* necessary to prefix the FUNC command.

Response to Query Version

The 9100 will return the appropriate <CPD> from the selection {DC|SIN|PULS|SQU|IMP|TRI|TRAP|SYMS} which represents the present source 'shape'. If the 9100 is programmed in one of the impedance functions (Group 1 in the table), then it will return NONE.

6.6.4.3 [SOUR] : VOLT [: LEVE] [: IMM] [: AMPL] (?) <DNPD>

Purpose

This command selects either DC or AC Voltage hardware, dependent upon the DC or SIN | IMP | TRI | TRAP | SYMS parameter included in the most-recent FUNC command.

<DNPD>

The 'decimal numeric program data' is a number which sets the required output voltage, expressed in units of DC or RMS AC Volts. It will automatically choose the 'best' hardware range for the defined voltage output. The 9100 will accept signed or unsigned positive values for DC Voltage.

For details of local operation and parameter limitations, refer to *Volume 1, Section 4, Sub-Sections 4.3 (DCV), 4.4 (ACV) or 4.17 (Logic Levels)*.

Response to Query Version

The instrument will return the present DC or AC voltage output value, dependent upon the DC or SIN | IMP | TRI | TRAP | SYMS parameter implicit, or included, in the most-recent FUNC command. The returned number will be in standard scientific format (for example: -200 μ V DC would be returned as -2.0E-4 — positive numbers, however, are unsigned)

Final Width = 215mm

6.6.4.4 [SOUR] : VOLT [: LEVE] [: IMM] : HIGH (?) <DNPD>

Purpose

This command sets the high (most positive) voltage level for the square or pulsed voltage output, which has been selected by the SQU or PULS parameter included in the most-recent FUNC command.

<DNPD>

The 'decimal numeric program data' is a number which sets the required high-level (most-positive) output voltage of the programmed waveshape, expressed in units of Volts. It will automatically choose the 'best' hardware range for the defined voltage output, in conjunction with the corresponding VOLT : LOW command for the same waveshape.

The value of <DNPD> cannot be equal to or more negative than that sent as the <DNPD> with the corresponding VOLT : LOW command for the same waveshape. The 9100 will accept signed or unsigned positive values.

For details of local operation and parameter limitations, refer to *Volume 1, Section 4, Sub-Sections 4.9 (Frequency), 4.10 (Mark/Period), 4.11 (% Duty Cycle) or 4.16 (Logic Pulses)*.

Response to Query Version

The instrument will return the present high level voltage output value, associated with the SQU or PULS parameter implicit, or included, in the query command. The returned number will be in standard scientific format (for example: +200mV would be returned as 2.0E-1 — positive numbers are unsigned).

6.6.4.5 [SOUR]:VOLT[:LEVE] [:IMM]:LOW(?) <DNPD>

Purpose

This command sets the low (most negative) voltage level for the square or pulsed voltage output, which has been selected by the SQU or PULS parameter included in the most-recent FUNC command. Separate values are recorded for SQU and PULS functions.

<DNPD>

The 'decimal numeric program data' is a number which sets the required low-level (most-negative) output voltage of the programmed waveshape, expressed in units of Volts. It will automatically choose the 'best' hardware range for the defined voltage output, in conjunction with the corresponding VOLT:HIGH command for the same waveshape.

The value of <DNPD> cannot be equal to or more positive than that sent as the <DNPD> with the corresponding VOLT:HIGH command for the same waveshape. The 9100 will accept signed or unsigned positive values.

For details of local operation and parameter limitations, refer to *Volume 1, Section 4, Sub-Sections 4.9 (Frequency), 4.10 (Mark/Period), 4.11 (% Duty Cycle) or 4.16 (Logic Pulses)*.

Response to Query Version

The instrument will return the present low level voltage output value, associated with the SQU or PULS parameter implicit, or included, in the query command. The returned number will be in standard scientific format (for example: +200mV would be returned as 2.0E-1 — positive numbers are unsigned)

Final Width = 215mm

6.6.4.6 [SOUR] : CURR [: LEVE] [: IMM] [: AMPL] (?) <DNPD>

Purpose

This command selects either DC or AC Current hardware, dependent upon the DC or SIN | IMP | TRI | TRAP | SYMS parameter included in the most-recent FUNC command.

<DNPD>

The 'decimal numeric program data' is a number which sets the required output current, expressed in units of DC or RMS AC Amps. It will automatically choose the 'best' hardware range for the defined current output. The 9100 will accept signed or unsigned positive values for DC Current.

For details of local operation and parameter limitations, refer to *Volume 1, Section 4, Sub-Sections 4.5 (DCI) or 4.6 (ACT)*.

Response to Query Version

The instrument will return the present DC or AC current output value, dependent upon the DC or SIN | IMP | TRI | TRAP | SYMS parameter implicit, or included, in the most-recent FUNC command. The returned number will be in standard scientific format (for example: -200 μ A DC would be returned as -2.0E-4 — positive numbers, however, are unsigned)

Final Width = 215mm

6.6.4.7 [SOUR] : RES [: LEVE] [: IMM] [: AMPL] (?) < DNP D >

Purpose

This command selects Resistance hardware.

< DNP D >

The 'decimal numeric program data' is a number which sets the required output resistance, expressed in units of Ohms. It will automatically choose the 'best' hardware range for the defined resistance output.

For details of local operation and parameter limitations, refer to *Volume 1, Section 4, Sub-Section 4.7 (Resistance)*.

Response to Query Version

The instrument will return the present resistance output value. The returned number will be in standard scientific format (for example: 200k Ω would be returned as 2 . 0E5)

6.6.4.8 [SOUR] : RES : UUT _ I (?) < CP D > { LOW | HIGH | SUPER }

Purpose

In the synthesized resistance technology used in the 9100, the current sourced from the UUT must fall within certain spans of values for each commanded resistance value. For UUTs producing source currents which are larger than the values in the 'Low' (default) span, the greater current can be accommodated by selecting 'HIGH' or 'SUPER'.

The RES : UUT _ I { LOW | HIGH | SUPER } command is used to switch between the three current configurations. There is no default setting; refer to *Volume 1 of this User's Handbook, Section 4, Sub-section 4.7, paras 4.7.5.7* for a description of UUT_I current tracking during Resistance span changes.

< CP D >

The 'character program data' performs the required action. Refer to *Volume 1, Section 4, paras 4.7.5.7*, for a description of the current limits and output voltage limitation.

- LOW will select the UUT source current 'Low' limits.
- HIGH will select the UUT source current 'High' limits.
- SUPER will select the UUT source current 'Super' limits.

Response to Query Version

The 9100 will return either LOW, HIGH or SUP, dependent on the active limits selection.

6.6.4.9 [SOUR] : COND [: LEVE] [: IMM] [: AMPL] (?) <DNPD>

Purpose

This command selects Conductance hardware.

<DNPD>

The 'decimal numeric program data' is a number which sets the required output conductance, expressed in units of Siemens. It will automatically choose the 'best' hardware range for the defined conductance output.

For details of local operation and parameter limitations, refer to *Volume 1, Section 4, Sub-Section 4.8 (Conductance)*.

Response to Query Version

The instrument will return the present conductance output value. The returned number will be in standard scientific format (for example: 200µS would be returned as 2 . 0E - 4)

6.6.4.10 [SOUR] : COND : UUT _ I (?) <CPD> { LOW | HIGH | SUPER }

Purpose

In the synthesized conductance technology used in the 9100, the current sourced from the UUT must fall within certain spans of values for each commanded conductance value. For UUTs producing source currents which are larger than the values in the 'Low' (default) span, the greater current can be accommodated by selecting 'HIGH' or 'SUPER'.

The COND : UUT _ I { LOW | HIGH | SUPER } command is used to switch between the three current configurations. There is no default setting; refer to *Volume 1 of this User's Handbook, Section 4, Sub-section 4.8, paras 4.8.5.7* for a description of UUT_I current tracking during Conductance span changes.

<CPD>

The 'character program data' performs the required action. Refer to *Volume 1, Section 4, paras 4.8.5.7*, for a description of the current limits and output voltage limitation.

- LOW will select the UUT source current 'Low' limits.
- HIGH will select the UUT source current 'High' limits.
- SUPER will select the UUT source current 'Super' limits.

Response to Query Version

The 9100 will return either LOW, HIGH or SUP, dependent on the active limits selection.

Final Width = 215mm

6.6.4.11 [SOUR] : CAP [: LEVE] [: IMM] [: AMPL] (?) <DNPD>

Purpose

This command selects Capacitance hardware.

<DNPD>

The 'decimal numeric program data' is a number which sets the required output capacitance, expressed in units of Farads. It will automatically choose the 'best' hardware range for the defined capacitance output.

For details of local operation and parameter limitations, refer to *Volume 1, Section 4, Sub-Section 4.13 (Capacitance)*.

Response to Query Version

The instrument will return the present capacitance output value. The returned number will be in standard scientific format (for example: 200nF would be returned as 2 . 0E-7).

6.6.4.12 [SOUR] : CAP : UUT_I (?) <CPD> { LOW | SUPER }

Purpose

In the synthesized capacitance technology used in the 9100, the current sourced from the UUT must fall within certain spans of values for each commanded capacitance value. For UUTs producing source currents which are larger than the values in the 'Low' (default) span, the greater current can be accommodated by selecting 'SUPER'.

The CAP : UUT_I { LOW | SUPER } command is used to switch between the two current configurations (refer to *Volume 1 of this User's Handbook, Section 4, Sub-section 4.7, paras 4.7.5.7* for a description of UUT—I levels). There is no default setting. Most capacitance spans do not allow SUP. Thus if SUP is already selected, and a transition is made to a capacitance span for which it is not available, then LOW will be enforced.

<CPD>

The 'character program data' performs the required action. Refer to *Volume 1, Section 4, paras 4.13.5.7*, for a description of the current limits and output voltage limitation.

- LOW will select the UUT source current 'Low' limits.
- SUPER will select the UUT source current 'Super' limits.

Response to Query Version

The 9100 will return either LOW or SUP, dependent on the active limits selection.

6.6.4.13 [SOUR] : FREQ [: CW | FIX] (?) < DNPDP >

Purpose

This command is used to set one of three frequency parameters, each associated with either 'AC Voltage' function, 'AC Current' function or 'Hz' (Frequency) function.

For Example:

An 'AC Voltage' function output is programmed by:

FUNC : { SIN | IMP | TRI | TRAP | SYMS } ; : VOLT < DNPDP > ; : FREQ < DNPDP >

A (squarewave) 'Hz' (Frequency) function output is programmed by:

FUNC SQU ; : FREQ < DNPDP > ; : VOLT : HIGH < DNPDP > ; : VOLT : LOW < DNPDP >

An 'AC Current' function output is programmed by:

FUNC : { SIN | IMP | TRI | TRAP | SYMS } ; : CURR < DNPDP > ; : FREQ < DNPDP >

< DNPDP >

The 'decimal numeric program data' is a number which sets the required output frequency of the selected operation, expressed in units of Hertz. It will automatically choose the 'best' hardware range for the defined frequency of output.

Final Width = 215mm

For details of local operation and parameter limitations, refer to *Volume 1, Section 4, Sub-Section 4.9 (Frequency)*.

Response to Query Version

The instrument will return the present output frequency value for the selected operation, dependent upon the SIN or SQU parameter implicit, or included, in the most-recent FUNC command, and the most-recent VOLT or CURR command. The returned number will be in standard scientific format (for example: 20kHz would be returned as 2 . 0E4).

For Example:

If in AC Voltage or AC Current Function, a sinewave frequency is returned by the query: **FREQ?**

If in 'Hz' (Frequency) Function, the squarewave frequency is returned by the query: **FREQ?**

6.6.4.14 [SOUR] : PHAS [: ADJust] (?) <DNPD>

Purpose

This command is used to set the phase angle of the 9100 output, with respect to 'Phase Lock In', when operating in either 'AC Voltage' or 'AC Current' function.

<DNPD>

The 'decimal numeric program data' is a number which sets the required phase angle of the selected operation, expressed in units of Degrees. The Phase angle is resolved in increments of 0.01°, over a range of acceptable values from -180° to +180°.

Example:

An 'AC Voltage' function output phase angle could be programmed by:

```
FUNC: {SIN|IMP|TRI|TRAP|SYMS}; :VOLT <DNPD>; :FREQ <DNPD>; :PHAS <DNPD>; :PHAS:INP ON;
```

Function Change, *RST Common Command and Power-up

The 9100 phase angle is set to zero degrees (equivalent to PHAS:ADJ 0). For details of operation and parameter limitations, refer to *Volume 1, Section 4, Sub-Sections 4.4 and 4.6 (AC Voltage and AC Current)*.

Response to Query Version

The instrument will return the present phase angle value for the selected operation, dependent upon the most-recent VOLT or CURR command. The returned number will be in standard scientific format (for example: 90° would be returned as 9.0E1).

6.6.4.15 [SOUR] : PHAS : INP [: STATE] (?) <CPD> {OFF | ON | 0 | 1}

Purpose

The 9100 AC Voltage or AC Current output can be phase-shifted from a reference-phase input via the 'PHASE LOCK IN' plug on the rear panel (by a phase angle set by the PHAS:ADJust command — see 6.6.4.14 earlier).

This command switches the 9100: either to free run; or to be locked to the reference phase.

<CPD>

The 'character program data' switches the 9100: either to free run (OFF or 0); or to be locked to the reference phase, after setting the phase angle (ON or 1).

Example:

An 'AC Voltage' function output phase angle could be programmed by:

```
FUNC: {SIN|IMP|TRI|TRAP|SYMS}; :VOLT <DNPD>; :FREQ <DNPD>; :PHAS <DNPD>; :PHAS:INP ON;
```

Function Change, *RST Common Command and Power-up

The 9100 state changes to free run (equivalent to PHAS:INP {OFF|0}). For details of operation and parameter limitations, refer to *Volume 1, Section 4, Sub-Sections 4.4 and 4.6 (AC Voltage and AC Current)*.

Response to Query Version

The instrument will return the present 'phase input state' setting: {OFF | ON}.

6.6.4.16 [SOUR] : PHAS : OUTP [: STATE] (?) <CPD> { OFF | ON | 0 | 1 }

Purpose

The 9100 AC Voltage or AC Current output phase can be used as a reference-phase output via the 'PHASE LOCK OUT' plug on the rear panel. This command switches the reference phase on or off.

<CPD>

The 'character program data' switches the 9100: *either* to output the reference phase (ON or 1); *or* not (OFF or 0).

Example:

An 'AC Voltage' function output phase angle could be programmed by:

```
FUNC: {SIN|IMP|TRI|TRAP|SYMS}; VOLT <DNPD>; FREQ <DNPD>; PHAS: OUTP ON
```

Function Change, *RST Common Command and Power-up

The 9100 switches reference phase off (equivalent to PHAS : OUTP { OFF | 0 }). For details of operation and parameter limitations, refer to *Volume 1, Section 4, Sub-Sections 4.4 and 4.6 (AC Voltage and AC Current)*.

Response to Query Version

The instrument will return the present 'phase output state' setting: { OFF | ON }.

Final Width = 215mm

6.6.4.17 [SOUR] :PULS:{PER|WID|DCYC}(?) <DNPD>

Purpose

This command is used to set one of three parameters, each associated with Pulsed Voltage operation.

For definition of *Period*:

FUNC PULS ; :PULS:PER <DNPD> selects the period of the pulsed voltage.

For definition of *Pulsewidth* (in conjunction with *Period*, implicitly defining *Mark/Period Ratio*):

FUNC PULS ; :PULS:WID <DNPD> selects the pulsewidth. Alternatively:

For definition of *Mark/Period Ratio regardless of Period*:

FUNC PULS ; :PULS:DCYC <DNPD> selects the percentage duty cycle of the pulsed voltage.

Voltage levels are programmed by **VOLT:HIGH <DNPD>** and **VOLT:LOW <DNPD>** commands.

<DNPD>

The 'decimal numeric program data' is a number which sets the required *period* time interval or *pulse-width* time interval of the selected operation, expressed in units of Seconds. For *duty cycle*, this will be in units of Percentage. The <DNPD>s will, together, automatically choose the 'best' hardware configuration for the defined time intervals of output.

For Example:

A Pulsed Voltage (equivalent to the local selection of 'Mark/Period' or 'Logic Pulses' Function) is programmed by:

```
FUNC PULS ; :PULS:PER <DNPD> ; :PULS:WID <DNPD> ; :VOLT:HIGH <DNPD> ; :VOLT:LOW <DNPD>
```

A Pulsed Voltage (equivalent to the local selection of '% Duty Cycle' Function) is programmed by:

```
FUNC PULS ; :PULS:PER <DNPD> ; :PULS:DCYC <DNPD> ; :VOLT:HIGH <DNPD> ; :VOLT:LOW <DNPD>
```

For details of local operation and parameter limitations, refer to *Volume 1, Section 4, Sub-Sections 4.10 (Mark/Period), 4.11 (% Duty Cycle) or 4.16 (Logic Pulses)*.

Responses to Query Versions

The instrument will return the present period, pulsewidth or percentage duty cycle for the selected operation. The returned number will be in standard scientific format (for example: 50ms would be returned as 5.0E-2, and 30% would be returned as 3.0E1).

For Example:

If in 'Mark/Period', 'Logic Pulses' or '% Duty Cycle' Function, the squarewave period is returned by the query: **PULS:PER?**

If in 'Mark/Period' or 'Logic Pulses' Function, the squarewave pulsewidth is returned by the query: **PULS:WID?**

If in '% Duty Cycle' Function, the squarewave duty cycle percentage is returned by the query: **PULS:DCYC?**

6.6.4.18 [SOUR] : TEMP : UNIT (?) <CPD> { C | CEL | F | FAH | K }

Purpose

This command affects the values of *subsequently* programmed temperature. This is clearly demonstrated by the following examples:

1. A 9100 unit is already programmed to simulate a thermocouple at 200°C (Celsius). To simulate 300°C, it is necessary only to send the value command: TEMP : THER 300 .
2. If now the same unit is required to respond to Fahrenheit values, the command: TEMP : UNIT F can be sent. The voltage output resulting from the previous 300°C programming will not change, but now the unit recognizes *that* voltage as having the equivalent Fahrenheit value (572). For instance, if the TEMP : THER ? query is sent, then the unit will respond with the number 572 only. The other change is that *subsequent* value-programming commands must be sent with the required temperatures expressed in Fahrenheit.
3. Reprogramming must now follow in Fahrenheit values, so the command: TEMP : THER 482 can be sent, resulting in an output voltage representing a simulated temperature of 482°F (250°C or 523K).

<CPD>

The 'character program data' selects the factor which will govern the conversion from temperature value to simulated thermocouple voltage output (selected thermocouple type) or resistance output (selected RTD type). Where users wish to enter temperature values in units of Celsius, Fahrenheit or Kelvin, this command permits the required entry unit to be selected.

C | CEL For subsequent commands TEMP : THER <DNPD> or TEMP : PRT <DNPD>, the 9100 will recognize the units of the <DNPD> value as 'degrees Celsius'.

F | FAH For subsequent commands TEMP : THER <DNPD> or TEMP : PRT <DNPD>, the 9100 will recognize the units of the <DNPD> value as 'degrees Fahrenheit'.

K For subsequent commands TEMP : THER <DNPD> or TEMP : PRT <DNPD>, the 9100 will recognize the units of the <DNPD> value as 'Kelvins'.

Function Change, *RST Common Command and Power-up

The most-recently programmed 'units' setting is remembered regardless of [SOUR] keyword changes until either the setting is changed by another TEMP : UNIT command, a *RST command is sent, or the next power down. Power-up and *RST default units are 'Celsius'.

Response to Query Version

The instrument will return the present 'units' setting { C | F | K }.

6.6.4.19 [SOUR] :TEMP:SCAL(?) <CPD>{TS68 | TS90}

Purpose

The 9100 supports two types of temperature scale: IPTS-68 (default) and ITS-90. This command determines which of the two temperature scales will be used for *subsequently* programmed temperature.

<CPD>

The 'character program data' selects the type of scale:

TS68 For subsequent commands TEMP:THER <DNPD> or TEMP:PRT <DNPD>, the 9100 will use the IPTS-68 temperature scale.

TS90 For subsequent commands TEMP:THER <DNPD> or TEMP:PRT <DNPD>, the 9100 will use the ITS-90 temperature scale.

Function Change, *RST Common Command and Power-up

The most-recently programmed 'scale' setting is remembered regardless of [SOUR] keyword changes until either the setting is changed by another TEMP:SCAL command, a *RST command is sent, or the next power down. Power-up and *RST default units are 'TS68'.

Response to Query Version

The instrument will return the present 'scale' setting {TS68 | TS90}.

Final Width = 215mm

6.6.4.20 [SOUR] : TEMP : THER [: LEVE] [: IMM] [: AMPL] (?) <DNPD>

Purpose

This command will select Thermocouple function with a default of Type K, setting the required temperature value, which will determine the output voltage (refer to the *Programming Example after paras 6.6.4.21*).

<DNPD>

The 'decimal numeric program data' is a number which sets the required temperature value. It must be expressed as a value relating to the units (degrees Celsius, Degrees Fahrenheit, or Kelvin), already set into the 9100 by the most-recent TEMP : UNIT <CPD> command (see *paras 6.6.4.18*). Power-up and *RST default units are Celsius.

The value of <DNPD>, in conjunction with the 'UNIT', 'SCAL' and 'TYPE' commands, will automatically choose the 'best hardware range for the defined thermocouple voltage output.

For details of local operation and parameter limitations, refer to *Volume 1, Section 4, Sub-Section 4.14 (Thermocouple Temperature)*.

Software Compensation

Software compensation takes account of the temperature of the isothermal block on which the Reference Junction is mounted, behind the D-type socket on the 9100 front panel (refer to *Volume 1, Section 4, Sub-section 4.14.4*).

Final Width = 215mm

The block temperature is sensed at OUTPUT ON, and regularly at 5-second intervals until OUTPUT OFF.

Response to Query Version

The instrument will return a number which is the value of the present output temperature in currently-programmed units. The returned number will be in standard scientific format (for example: 200°C would be returned as 2.0E2).

6.6.4.21 [SOUR] : TEMP : THER : TYPE (?) <CPD> { B | C | E | J | K | L | N | R | S | T }

Purpose

This command will select the Thermocouple function with the type selected and a default of 25°C. (refer to the *Programming Example below*).

<CPD>

The 'character program data' automatically selects the required simulation software. The <CPD> 'type' character is the same as the internationally-recognized thermocouple type. Power-up and *RST default is 'K'-type.

Response to Query Version

The instrument will return the character which represents the presently-programmed thermocouple 'type' simulation: { B | C | E | J | K | L | N | R | S | T }.

Programming Example: To ensure the setup of a required thermocouple type and temperature, use:

```
:TEMP:THER 200 ; :TEMP:THER:TYPE B<nl>  
or :TEMP:THER 353 ; :TEMP:S<nl>
```

6.6.4.22 [SOUR] :TEMP:PRT[:LEVE][:IMM][:AMPL] (?) <DNPD>

Purpose

This command selects PRT simulation hardware, and sets the required temperature value, which determines the output resistance, once the type of PRT has been selected (*refer to paras 6.6.4.23 and to the Programming Example after paras 6.6.4.25*).

<DNPD>

The 'decimal numeric program data' is a number which sets the required temperature value. It must be expressed as a value relating to the units (degrees Celsius, Degrees Fahrenheit, or Kelvin), already set into the 9100 by the most-recent TEMP:UNIT <CPD> command (see *paras 6.6.4.18*). Power-up and *RST default units are Celsius. For this command sent on its own; other defaults are: NRES = 100Ω, TYPE = PT385 and UUT_I = HIGH.

The value of <DNPD>, in conjunction with the 'UNIT', 'SCAL' and 'TYPE' commands, will automatically choose the 'best' hardware range for the defined PRT resistance output.

For details of local operation and parameter limitations, refer to *Volume 1, Section 4, Sub-Section 4.15 (RTD Temperature)*.

Response to Query Version

The instrument will return a number which is the value of the present output temperature in currently-programmed units. The returned number will be in standard scientific format (for example: 200°C would be returned as 2.0E2).

Final Width = 215mm

6.6.4.23 [SOUR] :TEMP:PRT:TYPE (?) <CPD>{PT385 | PT392 }

Purpose

This command selects the appropriate conversion software to simulate the selected RTD type (*refer to the Programming Example after paras 6.6.4.25*).

<CPD>

The 'character program data' selects the required simulation software for the required type of RTD:

PT385 For subsequent commands TEMP:PRT <DNPD>, the 9100 will use the PT385 (European) conformance curve.

PT392 For subsequent commands TEMP:PRT <DNPD>, the 9100 will use the PT392 (USA) conformance curve.
Power-up and *RST default is 'PT385'. For this command sent on its own; other defaults are: LEVE = 25°C, NRES = 100Ω and UUT_I = HIGH.

Response to Query Version

The instrument will return the characters which represent the presently-programmed RTD 'type' simulation: { PT385 | PT390 }.

6.6.4.24 [SOUR] : TEMP : PRT : NRESistance (?) <DNPD>

Purpose

The system defaults to provide parameters which simulate a platinum-resistance thermometer whose 0°C nominal value is 100Ω. The nominal value can be adjusted between 10Ω and 2kΩ to match the nominal 0°C value of the simulated thermometer. This command is invalid unless PRT function is programmed.

The TEMP : PRT : NRES command is used to adjust the 0°C nominal resistance parameter in the 9100 system (*refer to the Programming Example after paras 6.6.4.25*).

<DNPD>

The 'decimal numeric program data' is a number which sets the required 0°C nominal value. It must be expressed as a decimal value in Ohms which is the same as that of the 0°C nominal value for the simulated thermometer

The value of <DNPD>, in conjunction with the 'UNIT', 'SCAL' and 'TYPE' commands, will automatically adjust the software parameters for the PRT resistance output defined by the PRT [: LEVE] [: IMM] [: AMPL] <DNPD> command.

For details of local operation and parameter limitations, refer to *Volume 1, Section 4, Sub-Section 4.15* (RTD Temperature).

Response to Query Version

The instrument will return a number which is the value of the presently-programmed 0°C nominal value. The returned number will be in standard scientific format (for example: 200Ω would be returned as 2 . 0E2).

Final Width = 215mm

6.6.4.25 [SOUR] : TEMP : PRT : UUT_I (?) <CPD>{LOW|HIGH|SUPER}

Purpose

In the synthesized resistance technology used for RTD simulation in the 9100, the current sourced from the UUT must fall within certain spans of values for each commanded temperature value. For UUTs producing source currents which are larger than the values in the 'Low' (default) span, the greater current can be accommodated by selecting 'HIGH' or 'SUPER'.

The TEMP : PRT : UUT_I {LOW|HIGH|SUPER} command is used to switch between the three current configurations (*refer to the Programming Example below*). There is no default setting.

<CPD>

The 'character program data' performs the required action. Refer to *Volume 1, Section 4, paras 4.15.4.7*, for a description of the current limits and output voltage limitation.

- LOW will select the UUT source current 'Low' limits.
- HIGH will select the UUT source current 'High' limits.
- SUPER will select the UUT source current 'Super' limits.

Response to Query Version

The 9100 will return either LOW, HIGH or SUP, dependent on the active limits selection.

Programming Example: To ensure the setup of a required Type, Temperature, Nominal Resistance and Source Current use:

```
:TEMP : PRT 270 ; :TYPE PT392 ; :NRES 1E3 ; :UUT_I HIGH<n1 >
```

6.6.4.26 [SOUR] : CONT [: LEVE] [: IMM] [: AMPL] (?) <DNPD>

Purpose

This command activates the Continuity function. The value <DNPD> is the desired resistance value in ohms demanded by the user.

6.6.4.27 [SOUR] : CONT : TCUR?

Purpose

This query only command requests the test current provided by the UUT for confirmation that the UUT is providing sufficient test current to comply with its calibration specification (*also see Note 1 below*).

6.6.4.28 [SOUR] : INS [: LEVE] [: IMM] [: AMPL] (?) <DNPD>

Purpose

This command activates the Insulation Resistance function. The value <DNPD> is the resistance value in ohms demanded by the user.

6.6.4.29 [SOUR] : INS : UUT_I (?) <CPD>

Purpose

This command operates in the same manner as that for Active Resistance, with the exception that the only two permissible values of current setting <CPD> are HIGH and SUPER.

6.6.4.30 [SOUR] : INS : TVOL?

Purpose

This query only command returns the value of UUT test voltage (*also see Note 1 below*).

6.6.4.31 [SOUR] : INS : TCUR?

Purpose

This query only command returns the value of UUT test current (*also see Note 1 below*).

Note 1 : If the commands : CONT : TCUR?, : INS : TVOL? or : INS : TCUR? are executed when the output is OFF, or the Model 9100 is not in the relevant function, the value returned will be 2 . 0E+35.

6.6.5 STATUS Subsystem

This subsystem is used to enable bits in the Operation and Questionable Event registers. The Operation and Questionable: Event, Enable and Condition registers can be interrogated to determine their state. For further information regarding the Status structure, refer to *Sub-Section 6.5.4*.

6.6.5.1 STATUS Subsystem Table

Keyword	Parameter Form	Notes
STATUS		
:OPERATION		
[:EVENT]?		[Query Only]
:ENABLE(?)	<DNPD>	[Query Only]
:CONDITION?		[Query Only]
:QUESTIONABLE		
[:EVENT]?		[Query Only]
:ENABLE(?)	<DNPD>	[Query Only]
:CONDITION?		[Query Only]
:PRESET		

6.6.5.2 STAT:OPER[:EVENT]?

Purpose

OPER? returns the contents of the Operation Event register, clearing the register.

Response

A <DNPD> in the form of an Nr1 number is returned. The value of the number, when converted to base 2 (binary), identifies the Operation Event register bits to determine their current status.

For example (*refer to Fig. 6.2*):

If the 9100 had just performed a selftest, the 'TESTING' bit 8 of the register would be set, and if no other Operation Event bits were enabled, the number 256 would be returned. Bit 8 (indeed, all bits in the register) would be reset by this query.

6.6.5.3 STAT:OPER:ENAB(?) <DNPD>

Purpose

OPER:ENAB <DNPD> sets the mask which enables those Operation Event register bits which are required to be summarized at bit 7 of the IEEE 488.2 Status Byte register.

<DNPD>

This is a decimal integer whose binary equivalent represents the bits required to be enabled.

For example (*refer to Fig. 6.2*):

The command: OPER:ENAB 768 would be required to enable only the 'TESTING' and 'PRETESTING' bits 8 and 9 of the Operation Event register.

Response to the Query Version

A <DNPD> in the form of an Nrl number is returned. The value of the number, when converted to base 2 (binary), identifies the bits set in the Operation Enable mask.

For example (*refer to Fig. 6.2*):

If the 'CALIBRATING' and 'PRETESTING' bits 0 and 9 of the register are enabled, the number 513 would be returned.

6.6.5.4 STAT:OPER:COND?

Purpose

OPER:COND? returns the contents of the Operation Condition register, which is not cleared by the command.

N.B. This register contains transient states, in that its bits are not 'sticky', but are set and reset by the referred operations. The response to the query therefore represents an instantaneous 'Snapshot' of the register state, at the time that the query was accepted.

Response

A <DNPD> in the form of an Nrl number is returned. The value of the number, when converted to base 2 (binary), identifies the Operation Condition register bits to determine their current status.

For example (*refer to Fig. 6.2*):

If the 9100 was in the process of performing a selftest, only the 'TESTING' bit 8 of the register would be temporarily set, and the number 256 would be returned.

6.6.5.5 STAT:QUES [: EVEN] ?

Purpose

QUES? returns the contents of the Questionable Event register, clearing the register.

Response

A <DNPD> in the form of an Nr1 number is returned. The value of the number, when converted to base 2 (binary), identifies the Questionable Event register bits to determine their current status.

For example (*refer to Fig. 6.2*):

If an error had been initiated by an incorrect constant current during Resistance operations, the 'sticky' 'INV OHM CURR1' bit 9 of the register would be set, and if no other Questionable Event bits were enabled, the number 512 would be returned. Bit 9 (indeed, all bits in the register) would be reset by this query.

6.6.5.6 STAT:QUES:ENAB (?) <DNPD>

Purpose

QUES:ENAB <DNPD> sets the mask which enables those Questionable Event register bits which are required to be summarized at bit 3 of the IEEE 488.2 Status Byte register.

<DNPD>

This is a decimal integer whose binary equivalent represents the bits required to be enabled.

For example (*refer to Fig. 6.2*):

The command: QUES:ENAB 1536 would be required to enable only the 'INV OHM CURR1' and 'INV OHM CURR2' bits 9 and 10 of the Questionable Event register.

Response to the Query Version

A <DNPD> in the form of an Nr1 number is returned. The value of the number, when converted to base 2 (binary), identifies the bits set in the Questionable Enable mask.

For example (*refer to Fig. 6.2*):

If the 'INV OHM CURR1' bit 9 of the register is the only enabled bit, the number 512 would be returned.

6.6.5.7 STAT:QUES:COND?

Purpose

QUES:COND? returns the contents of the Questionable Condition register, which is not cleared by the command.

N.B. This register contains transient states, in that its bits are not 'sticky', but are set and reset by the referred conditions. The response to the query therefore represents an instantaneous 'Snapshot' of the register state, at the time that the query was accepted.

Response

A <DNED> in the form of an Nr.I number is returned. The value of the number, when converted to base 2 (binary), identifies the Questionable Condition register bits to determine their current status.

For example (*refer to Fig. 6.2*):

If an incorrect UUT source current was generating an error during Resistance operations, and the temporary 'INV OHMCURRI' bit 9 of the Condition register was set; and if no other Questionable Condition bits were set, the number 512 would be returned.

6.6.5.8 STAT:PRES

SCPI-Mandated Command

The intention behind mandating the PRES command is to enable all bits in the SCPI-defined 'Device-dependent' and 'Transition' registers in order to provide a "device-independent structure for determining the gross status of a device".

Purpose in the 9100

In the 9100, the functions of the 'Transition' registers are not required, so no access is given. The PRES command therefore affects only the two device-dependent enabling registers:

The Operation Event Enable register

The Questionable Event Enable register.

Refer to *Fig. 6.2 and Sub-Section 6.5.4*. Sending PRES will set true all bits in both Enable registers. This will enable all bits in the two Event registers, so that all reportable device-dependent events, reported in the two registers, will be capable of generating an SRQ; providing only that bits 3 and 7 in the IEEE-488.2 Status Byte Register are also enabled.

The use of PRES in the 9100 allows the status-reporting structure to be set to a known state, not only for the intention of the SCPI mandate, but also to provide a known starting point for application programmers.

6.6.6 SYSTEM Subsystem

This subsystem collects the functions that are not related to 9100 performance.

6.6.6.1 SYSTEM Subsystem Table

Keyword	Parameter Form	Notes
SYSTEM		
:ERROR?		[Query Only]
:DATE (?)	<SPD>	
:TIME (?)	<SPD>	
:SVOLTage (?)	<DNED>	
:VERSION?		[Query Only]
:FORMAT?		[Query Only]

6.6.6.2 SYST:ERR?

The Error Queue

As errors in the 9100 are detected, they are placed in a 'first in, first out' queue, called the 'Error Queue'. This queue conforms to the format described in the SCPI Command Reference (Volume 2), although errors only are detected. Three kinds of errors are reported in the Error Queue, in the sequence that they are detected:

Command Errors, Execution Errors and Device-Dependent errors

Queue Overflow

Any time the Error Queue overflows, the earliest errors remain in the queue, and the most-recent error is discarded. The latest error in the queue is replaced by the error: -350, "Queue overflow".

Purpose of SYST:ERR? — Reading the Error Queue

This query is used to return any error which has reached the head of the Error Queue, and delete the error from the queue. The Error Queue is first in / first out, so the returned string will represent the earliest error in the queue.

The queue is read destructively as described in the SCPI Command Reference to obtain a code number and error message. The query can be used successively to read errors in the queue until it is empty, when the message 0, "No error" will be returned.

Response

The response is in the form of 'String Program Data', and consists of two elements: a code number and error message. The list of possible responses is given in *Appendix 'A' to Section 8*.

6.6.6.3 SYST:DATE (?) <SPD>

The date *format* can only be changed locally; using the **Date Format** menu, which is accessed via the **Configuration** menus.

N.B. A password is required for access to change the date format. Refer to *Volume 1 of this User's Handbook; Section 3, Subsection 3.3.2, paras 3.3.2.2 and 3.3.2.10.*

Purpose

This command is not used to change the date format. It only changes the present date, as recognized by the 9100, within the *current* date format, as defined locally.

<SPD>

This string defines the present date, and consists of the three two-digit numbers, separated by forward slashes. The numbers represent day, month and year, but not necessarily in that order. The locally-defined date format governs the sequence in which these three numbers are recognized, and their order within the string must reflect the locally-defined sequence.

Possible Formats

The three possible formats are shown on the Configuration screen given in *Volume 1 of this User's Handbook; Section 3, Subsection 3.3.2, paras 3.3.2.10.*

The string must conform to the scheme: X/Y/Z, where X, Y and Z are two-digit numbers. The combination of the two-digit numbers must have one of the following meanings:

Day/Month/Year, Month/Day/Year or Year/Month/Day;

where the chosen sequence also agrees with that set locally in paras 3.3.2.10.

Response to Query Version SYST:DATE?

The Query will return the presently-programmed date, as three slash-separated two-digit numbers, in the date format that they are currently set.

6.6.6.4 SYST:TIME (?) <SPD>

Purpose

This command changes the present time as recorded by the 9100 software. Any new time will be updated from a non-volatile real-time internal 24-hour clock.

<SPD>

This string defines the present time, consisting of two 2-digit numbers, separated by a hyphen. The numbers represent hour and minute, in that order. Their order within the string must reflect the fixed sequence.

The string must conform to the scheme: X-Y, where X and Y are 2-digit numbers.

The combination of the 2-digit numbers must have the following meaning, within the context of a 24-hour clock:

Hour-Minute

Response to Query Version SYST:TIME?

The Query will return the updated time at the moment the query was accepted, as two hyphen-separated 2-digit numbers, in the fixed time format.

Final Width = 215mm

6.6.6.5 SYST:SVOL (?) <DNPD>

Purpose

This command sets the voltage value of the threshold for the High Voltage Warning as employed in DC Voltage and AC Voltage functions. The 9100 need not be currently set in either of these functions to program the voltage.

<DNPD>

The 'decimal numeric program data' is a number which sets the required voltage safety warning threshold, expressed in units of DC or RMS AC Volts. It should be unsigned. The parameter <DNPD> must have a value in the range 10.000V to 110.000V inclusive.

Response to Query Version: SYST:SVOL?

The instrument will return the present DC or AC voltage safety warning threshold value. The returned number will be in standard scientific unsigned format (for example: 90V would be returned as 9.0E1).

6.6.6.6 SYST:VERS?

Purpose

This query returns a numeric value corresponding to the SCPI version number for which the 9100 complies.

Response

SYST:VERS? returns an <Nf2> formatted numeric value corresponding to the SCPI version number for which the 9100 complies. At the time of writing, this will be 1994.0.

6.6.6.7 SYST:FOR?

Purpose

This query returns the present date format, as programmed locally.

Response

SYST:FOR? returns one of three sets of three characters: **DMY, MDY or YMD (Day/Month/Year, Month/Day/Year or Year/Month/Day)**. Formatting is carried out from a screen in 'Configuration' mode (*Refer to Volume 1 of this User's Handbook, Section 3, Subsection 3.3.2, paras 3.3.2.10).*

Final Width = 215mm

6.7.3.6 [SOURCE] : POWER : POLARITY : (?)
<cpd> { DC | SIGNED | ABSOLUTE }

This command sets the polarity mode of the DC or AC power functions. If the ABSOLUTE parameter is received, then power will not have a sign attached. The SIGNED parameter will allow positive and negative powers. (Note this may result in a change of phase angle in AC).

- If the instrument is not in DC nor AC power then a settings conflict error will be generated.

6.7.3.7 [SOURCE] : POWER : MAIN : VOLTAGE [: LEVEL] [: IMMEDIATE] [: AMPLITUDE] (?) <dnpd>
This sets the voltage amplitude of the selected channel.

- All waveshapes are specified in RMS.
- Only DC may have a negative <dnpd>.

6.7.3.8 [SOURCE] : POWER : AUXILIARY : CURRENT [: LEVEL] [: IMMEDIATE] [: AMPLITUDE] (?) <dnpd>
This sets the current amplitude of the auxiliary channel (Note the main channel is voltage only).

- All waveshapes are specified in RMS.
- Only DC may have a negative <dnpd>.
- This command is still used for the auxiliary amplitude even when POWER : AUXILIARY : MODE VOLTAGE is selected.

6.7.3.9 [SOURCE] : POWER : AUXILIARY : MODE (?) <cpd> { VOLTAGE | CURRENT }
This command determines the type of signal output on the auxiliary channel.

When in the VOLTAGE mode, the display continues to show current (I = xxx.xx) but the output on the auxiliary channel is calculated using the factor supplied by POWER : SCALE :

$$VOUT_{aux} = I_{aux} * Scale$$

- The default mode on entry to DC or AC will be CURRENT.

6.7.3.10 [SOURCE] : POWER : AUXILIARY : SCALE (?) <dnpd>

This command determines the scale factor applied to the auxiliary channel, when in 'auxiliary voltage' mode, to calculate the effective voltage on the auxiliary channel:

$$VOUT_{aux} = I_{aux} * Scale$$

- This is equivalent to the scale value set in the manual configuration screen.

6.7.4 Harmonic Selection

This sub-system defines the major hardware configuration of the power option harmonic feature.

6.7.4.1 [SOURCE] : HARMONIC (?) <dnpd>

This command selects the harmonic frequency on the auxiliary channel.

- The range of the <dnpd> is 1.0 to 40.0. Values outside this will generate a Data out of range error.

6.7.4.2 [SOURCE] : HARMONIC : MAIN : VOLTage [: LEVel] [: IMMEDIATE] [: AMPLItude] (?) <dnpd>

This sets the voltage amplitude, in RMS of the main channel.

6.7.4.3 [SOURCE] : HARMONIC : AUXiliary : CURRent [: LEVel] [: IMMEDIATE] [: AMPLItude] (?) <dnpd>

This sets the current amplitude, in RMS, of the auxiliary channel (Note the main channel is voltage only).

6.7.4.4 [SOURCE] : HARMONIC : AUXiliary : VOLTage [: LEVel] [: IMMEDIATE] [: AMPLItude] (?) <dnpd>

This sets the voltage amplitude, in RMS of the auxiliary channel.

6.7.4.5 [SOURCE] : HARMONIC : PANGLe (?) <dnpd>

This command sets the angular difference between the main and auxiliary waveforms. It is set as a phase angle in degrees.

- If the instrument is not in harmonics, then a settings conflict error will be generated.
- The range of the PANGLe <dnpd> is +180.0 to -180.0. Values outside this will generate a Data out of range error.

Final Width = 215mm

IEEE 488.2 Device Documentation Requirements

IEEE 488.2 requires that certain information be supplied to the user about how the device has implemented the standard. The Device Documentation Requirements are detailed in Section 4.9 of the Standard document IEEE Std 488.2-1992, on page 22. In this handbook, the required information is already contained within the descriptions of the system, and this appendix provides cross-references to those descriptions in which it is presented. The following paragraphs have the same numbers as the paragraphs of Section 4.9 in the Standard document to which they refer.

1. The list of IEEE 488.1 Interface Functions subsets implemented is given as Table 6.1 (page 6-4). The list is also printed close to the IEEE 488 connector on the rear of the instrument.
2. The instrument address is set manually, and the instrument firmware refuses to set any address outside the range 0-30. It responds instead with a Device Dependent Error, displayed on the front panel screen:
"Bus address must be within the range 0 - 30".
3. The (manual only) method of setting the address is described on pages 6-8/9, including the point in time when the 9100 recognizes a user-initiated address change.
4. Appendix E to Section 6 describes the active and non-active settings at power-on.

5. Message Exchange Options:

- a. The Input Buffer is a first in - first out queue, which has a maximum capacity of 128 bytes (characters). Each character generates an interrupt to the instrument processor which places it in the Input Buffer for examination by the Parser. The characters are removed from the buffer and translated with appropriate levels of syntax checking. If the rate of programming is too fast for the Parser or Execution Control, the buffer will progressively fill up. When the buffer is full, the handshake is held.
- b. No query returns more than one <RESPONSE MESSAGE UNIT>.
- c. All queries generate a response when parsed.
- d. No query generates a response when read.
- e. The following commands are coupled:
VOLT and FREQ
CURR and FREQ and ISEL
WID and PER and VOLT : HIGH and VOLT : LOW
DCYC and PER and VOLT : HIGH and VOLT : LOW
THER and UNIT and TYPE
PRT and UNIT and TYPE

6. The following functional elements are used in constructing the device-specific commands:
 - Command Program Header
 - Query Program Header
 - Character Program Data
 - Decimal Numeric Program Data.
 - String Program Data (PASS, DATE, TIME)
 - Arbitrary Block Program Data (*PUD)
 Compound Command Program Headers are used within the SCPI format.
7. *PUD blocks are limited to 63 bytes.
8. Expression Program Data elements are not used.
9. The syntax for each command is described in the general list of commands in Subsection 6.6 and Section 6, Appendix C. This list includes all queries, for which the response syntax is also described.
10. All device-to-device message transfer traffic follows the rules for <RESPONSE MESSAGE> elements.
11. The only command which elicits a Block Data response is the query *PUD?. Its response consists of #, 2, two digits and a data area of 63 bytes; 67 bytes in all.
12. A separate list of every implemented Common Command and Query is given in the alphabetical index at the start of Section 5. They are also described in Section 6, Appendix C
13. *CAL? is not implemented.
14. *DDT is not implemented.
15. Macro commands are not implemented.
16. *IDN? is described in Section 6, Appendix C.
17. *DDT is not implemented.
18. Neither *RDT nor *RDT? are implemented.
19. The states affected by *RST are described for each command in the list of commands and queries in Section 6, Appendix C.
20. Query Command *LRN? is not implemented; neither are Commands *RCL and *SAV.
21. *TST? invokes the Operational Selftest. The response to *TST? is described in Section 6, Appendix C, with a list of possible errors detailed in Appendix A to Section 8 of this handbook.
22. The additional status data structures used in the instrument's status reporting are fully described in Section 6, Subsection 6.5. Operating instructions for the status reporting facilities are given in Section 6, Appendix C.
23. All commands are sequential - overlapped commands are not used.
24. As all commands are sequential, there are no pending parallel operations. The functional criterion which is met, therefore, is merely that the associated operation has been completed.
25. No representations are used for 'Infinity' and 'Not-a-Number'.

Final Width = 215mm

SCPI Command Set and Conformance Information

The SCPI Standard requires that certain information be supplied to the user about how the device has implemented the standard. The Documentation Requirements are detailed in Section 4.2.3 of the Standard document Standard Commands for Programmable Instruments SCPI 1994; Volume 1: Syntax and Style; on page 4-6. The following paragraphs comply with those requirements:

1. The SCPI Version to which the Instrument Complies:

The instrument complies with the version 1994. The Confirmed Query: SYSTem:VERsion? will return this version number.

2. Syntax of All SCPI Commands and Queries Implemented in the Model 9100

All the Commands and Queries are present, each annotated with the state of its SCPI approval.

Keyword	Parameter Form	Notes	SCPI Approval
CALibration<n>			Confirmed
:SECure			Not SCPI Approved
:PASSword	<SPD>		Not SCPI Approved
:EXIT	<SPD>[PRD7 PRD14 PRD30 PRD60]		Not SCPI Approved
:TARGet	<DNPD>[<DNPD>]	[query only]	Not SCPI Approved
:TRIGger?		[query only]	Not SCPI Approved
:SPEcial?		[query only]	Not SCPI Approved
:CUNction?	<DNPD>		Not SCPI Approved
OUTPut<n>			Confirmed
:STATe(?)	<CPD>[ON OFF I]		Confirmed
:COMPenSation(?)	<CPD>[ON OFF I]		Not SCPI Approved
:SELEction(?)	<CPD>[HIGH HIS0 turn HI10 turn LOW]		Not SCPI Approved
[SOURCE<n>]			Confirmed
:FUNction	<CPD>[DC SIN usoid PULSe SQUare IMPulse TRiangle TRAPEzoid SYMSquare]		Confirmed
:SHAPE(?)			Not SCPI Approved
:VOLTage			Confirmed
[LEVEl]			Confirmed
[IMMediate]			Confirmed
[AMPLitude](?)	<DNPD>		Confirmed
:HIGH(?)	<DNPD>		Confirmed
:LOW(?)	<DNPD>		Confirmed
:CURRent			Confirmed
[LEVEl]			Confirmed
[IMMediate]			Confirmed
[AMPLitude](?)	<DNPD>		Confirmed

Find Width = 21.5mm

Keyword	Parameter Form	Notes	SCPI Approval
[SOURCE] (Contd.)			
:RESistance			Confirmed
[LEVEL]			Confirmed
[IMMediate]			Confirmed
[AMPLitude](?)			Confirmed
:UUT_(?)	<DNPD>		Not SCPI Approved
	<CPD>-[LOW HIGH SUPer]		
:CONductance			Not SCPI Approved
[LEVEL]			Not SCPI Approved
[IMMediate]			Not SCPI Approved
[AMPLitude](?)			Not SCPI Approved
:UUT_(?)	<DNPD>		Not SCPI Approved
	<CPD>-[LOW HIGH SUPer]		
:CAPacitance			Not SCPI Approved
[LEVEL]			Not SCPI Approved
[IMMediate]			Not SCPI Approved
[AMPLitude](?)			Not SCPI Approved
:UUT_(?)	<DNPD>		Not SCPI Approved
	<CPD>-[LOW SUPer]		
:FREQuency			Confirmed
[CW FIXed](?)	<DNPD>		Confirmed
:PHASe			Confirmed
[ADJust](?)	<DNPD>		Confirmed
:INPut			Not SCPI Approved
[STATe](?)	<CPD>-(ON OFF)[0 1]		Not SCPI Approved
:OUTPut			Not SCPI Approved
[STATe](?)	<CPD>-(ON OFF)[0 1]		Not SCPI Approved
:PULSe			Confirmed
:PERiod(?)	<DNPD>		Confirmed
:WIDth(?)	<DNPD>		Confirmed
:DCYCLE(?)	<DNPD>		Confirmed
:TEMPerature			Confirmed
:UNITS(?)	<CPD>-(C CE F FAH K		Not SCPI Approved
:SCALe(?)	<CPD>-[TS68 TS90]		Not SCPI Approved
:THERmocouple			Not SCPI Approved
[LEVEL]			Not SCPI Approved
[IMMediate]			Not SCPI Approved
[AMPLitude](?)			Not SCPI Approved
:TYPE(?)	<DNPD>		Not SCPI Approved
:PRT	<CPD>-[B C E I K L N R S T]		Not SCPI Approved
[LEVEL]			Not SCPI Approved
[IMMediate]			Not SCPI Approved
[AMPLitude](?)			Not SCPI Approved
:TYPE(?)	<DNPD>		Not SCPI Approved
:INRESistance(?)	<CPD>-[PT385 PT392]		Not SCPI Approved
:UUT_(?)	<DNPD>		Not SCPI Approved
	<CPD>-[LOW HIGH SUPer]		

Final Width = 215mm

Keyword	Parameter Form	Notes	SCPI Approval
STATUS			Confirmed
:OPERation			Confirmed
[:EVENT]?		[Query Only]	Confirmed
:ENABle(?)	<DNPd>		Confirmed
:CONDition?		[Query Only]	Confirmed
:QUESTIONable			Confirmed
[:EVENT]?		[Query Only]	Confirmed
:ENABle(?)	<DNPd>		Confirmed
:CONDition?		[Query Only]	Confirmed
:PRESet			Confirmed
SYSTem			Confirmed
:ERRor?		[Query Only]	Confirmed
:DATE(?) <SPD>			Not SCPI Approved
:TIME(?) <SPD>			Not SCPI Approved
:SVOLtag(?)			Not SCPI Approved
:VERsion?	<DNPd>		Confirmed
:FORMat?		[Query Only]	Not SCPI Approved

Final Width = 215mm

IEEE 488.2 Common Commands and Queries Implemented in the Model 9100

6.C.1 Clear Status

This measurement event status data structure conforms to the IEEE 488.2 standard requirements for this structure.

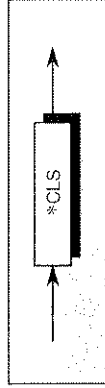

*CLS

clears all the event registers and queues except the output queue.
The output queue and MAV bit will be cleared if *CLS immediately follows a 'Program Message Terminator'; refer to the IEEE 488.2 standard document.

Execution Errors:

None.

Power On and Reset Conditions

Not applicable.

Final Width = 215mm

6.C.2 Event Status Enable

This event status data structure conforms to the IEEE 488.2 standard requirements for this structure.

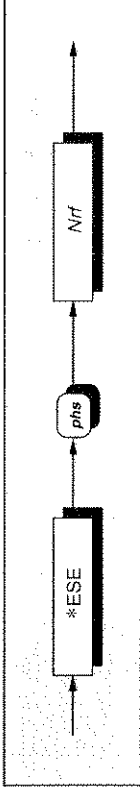

***ESE** enables the standard defined event bits which will generate a summary message in the status byte. Refer to Section 6; Subsection 6.5.

Execution Errors:
None.

Power On and Reset Conditions
Not applicable.

Nrf is a Decimal Numeric Data Element representing an integer decimal value equivalent to the Hex value required to enable the appropriate bits in this 8-bit register. The detailed definition is contained in the IEEE 488.2 standard document. Note that numbers **will** be rounded to an integer.

6.C.3 Recall Event Status Enable

This event status data structure conforms to the IEEE 488.2 standard requirements for this structure.

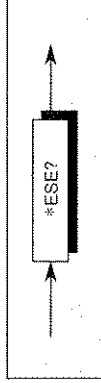

***ESE?** recalls the enable mask for the standard defined events. Refer to Section 6; Subsection 6.5.

Execution Errors:
None

Power On and Reset Conditions

The Power On condition depends on the condition stored by the common *PSC command - if 0 then it is not cleared; if 1 then the register is cleared. Reset has no effect.

Response Decode:
The value returned, when converted to base 2 (binary), identifies the enabled bits which will generate a summary message in the service request byte, for this data structure. The detailed definition is contained in the IEEE 488.2 document.

6.C.4 Read Event Status Register

This event status data structure conforms to the IEEE 488.2 standard requirements for this structure.



***ESR?**
recalls the standard defined events.
Refer to Section 6; Subsection 6.5.

Response Decode:
The value returned, when converted to base 2 (binary), identifies the bits as defined in the IEEE 488.2 standard.

Execution Errors:
None

Final Width = 215mm

6.C.5 I/D (Instrument Identification)

This command conforms to the IEEE 488.2 standard requirements.

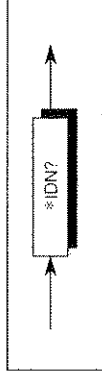

*IDN?

will recall the instrument's manufacturer, model number, serial number and firmware level.

Response Format:

Character position	1	2	3	4	5	6	7	8	9	10	11	12
W	a	v	e	t	e	k		L	t	d	,	
13	14	15	16	17								
9	1	0	0	,								
18	19	20	21	22	23	24	25	26	27	28	29	30
X	X	X	X	X	X	X	X	X	X	X	X	X
31	32	33	34									
X	.	X	X									

Final Width = 215mm

Where:

The data contained in the response consists of four comma-separated fields, the last two of which are instrument-dependent. The data element type is defined in the IEEE 488.2 standard specification.

A single query sent as a terminated program message will elicit a single response terminated by:

nl = newline with EOI

If multiple queries are sent as a string of program message units (separated by semi-colons with the string followed by a permitted terminator), then the responses will be returned as a similar string whose sequence corresponds to the sequence of the program queries. The final response in the string will be followed by the terminator:

nl = newline with EOI

Response Decode:

The data contained in the four fields is organized as follows:

- First field - manufacturer
- Second field - model
- Third field - serial number
- Fourth field - firmware level (will possibly vary from one instrument to another).

Execution Errors:

None.

Power On and Reset Conditions

Not applicable.

6.C.6 Operation Complete

This command conforms to the IEEE 488.2 standard requirements.

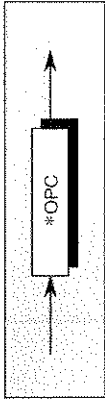

*OPC

is a synchronization command which will generate an operation complete message in the standard Event Status Register when all pending operations are complete.

Execution Errors:

None.

Power On and Reset Conditions

Not applicable.

6.C.7 Operation Complete?

This query conforms to the IEEE 488.2 standard requirements.

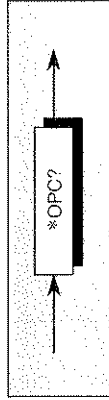

Final Width = 215mm

Response Decode:

The value returned is always 1, which is placed in the output queue when all pending operations are complete.

Recall the 9100 Instrument Hardware Fitment

This command conforms to the IEEE 488.2 standard requirements.

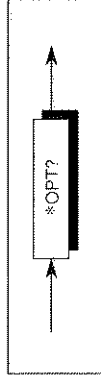

*OPT?

will recall the instrument's hardware fitment.

Response Format:

Character position

1 2 3 4 5 6 7 8 9 10 11 12
0 , 0 , 0 , x1 , x2 , x3 nl

Where:

The data in the response consists of comma-separated characters, each being either 1 or 0.

nl = newline with EOI

The data element type is Nr1 as defined in the IEEE 488.2 standard specification.

Response Decode:

The character positions represent the following hardware fitment:

- x1 - Option 600: Oscilloscope Calibrator Module
- x2 - Option 100: High Stability Crystal Reference
- x3 - Option 250: Oscilloscope Calibrator Module
- 0 - Positions reserved for future use

- x1 = 1 indicates that option 600 is fitted,
- x1 = 0 indicates that option 600 is not fitted.

- x2 = 1 indicates that option 100 is fitted,
- x2 = 0 indicates that option 100 is not fitted.

- x3 = 1 indicates that option 250 is fitted,
- x3 = 0 indicates that option 250 is not fitted.

Execution Errors:

None.

Power On and Reset Conditions

Not applicable.

Final Width = 215mm

6.C.8 Power On Status Clear

This common command conforms to the IEEE 488.2 standard requirements.

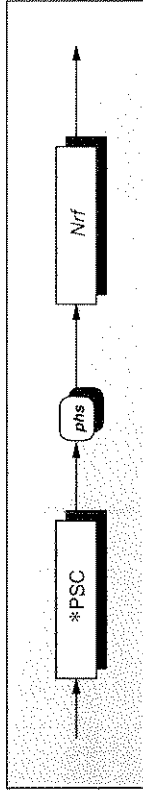

***PSC** sets the flag controlling the clearing of defined registers at Power On.

Nrf is a decimal numeric value which, when rounded to an integer value of zero, sets the *power on clear flag false*. This allows the instrument to assert SRQ at power on, providing that the PON bit in the ESR is enabled at the time of power-down, by the corresponding bit in its Enable register (ESE).

When the value rounds to an integer value other than zero it sets the *power on clear flag true*, which clears the standard *event status enable* and *service request enable* registers so that the instrument will not assert an SRQ on power up.

Examples:

*PSC 0 or *PSC 0.173 sets the instrument to **assert** an SRQ at Power On.

*PSC 1 or *PSC 0.773 sets the instrument to **not assert** an SRQ on Power On.

Execution Errors:
None.

Power On and Reset Conditions
Not applicable.

Final Width = 215mm

6.C.9 Recall Power On Status Clear Flag

This common query conforms to the IEEE 488.2 standard requirements. The existing flag condition will have been determined by the *PSC command.

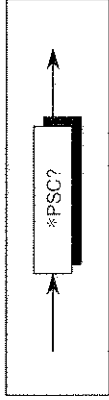

***PSC?**

will recall the Power On Status condition.

Response Format:

A single ASCII character is returned.

A single query sent as a terminated program message will elicit a single response terminated by:

nl = newline with EOI

If multiple queries are sent as a string of program message units (separated by semi-colons with the string followed by a permitted terminator), then the responses will be sent as a similar string whose sequence corresponds to the sequence of the program queries. The final response in the string will be followed by the terminator:

nl = newline with EOI

Response Decode:

The value returned identifies the state of the saved flag:

Zero indicates **false**. The instrument is **not** programmed to clear the Standard Event Status Enable Register and Service Request Enable Register at Power On, so the instrument will generate a 'Power On' SRQ, providing that the PON bit in the ESR is enabled at the time of power-down, by the corresponding bit in its Enable register (ESE).

One indicates **true**. The instrument is programmed to clear the Standard Event Status Enable Register and Service Request Enable Register at Power On, so the instrument cannot generate any SRQ at Power On.

Execution Errors:

None

Power On and Reset Conditions

No Change. This data is saved in non-volatile memory at Power Off, for use at Power On.

Final Width = 215mm

6.C.10 Protected User Data — Entry of User Data

This command conforms to the IEEE 488.2 standard requirements.

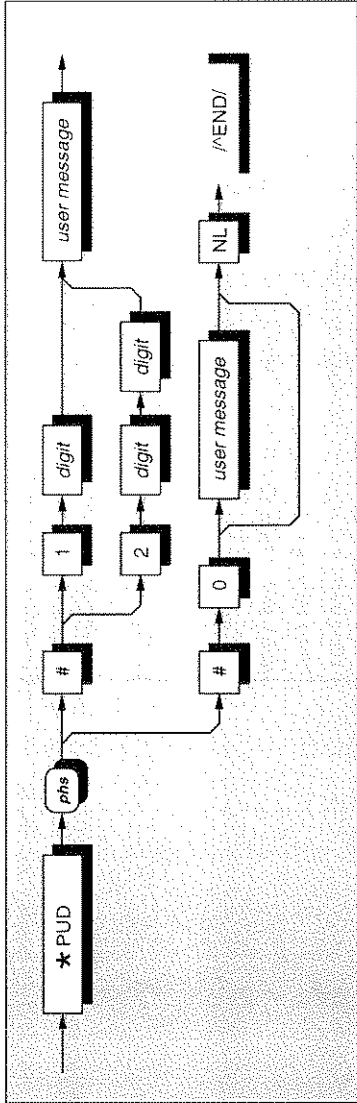

where:

p/hs = Program Header Separator,

digit = one of the ASCII-coded numerals,

user message = any message up to 63 bytes maximum.

Note

The slash-delimited '^END/' box is not outlined. This is to draw attention to the fact that it is not a data element, but represents the EOI line being set true with the last byte 'NL' to terminate the program message. Refer to the *Standard document IEEE Std 488.2-1992, Sub-section 7.7.6, page 78*.

*PUD

allows a user to enter up to 63 bytes of data into a protected area to identify or characterize the instrument. The two representations above are allowed depending on the message length and the number of 'digits' required to identify this. The instrument must be in calibration mode for this command to execute.

The data can be recalled using the *PUD? query.

Execution Errors

*PUD is executable only when the rear panel calibration switch is in the enabled position *and* calibration has been enabled. Otherwise an Execution Error is returned.

Command Errors

A Command Error is returned if the user message exceeds 63 bytes, or if the data does not conform to the standard format.

Power On and Reset Conditions

Data area remains unchanged.

Final Width = 215mm

6.C.11 Protected User Data — Recall of User Data

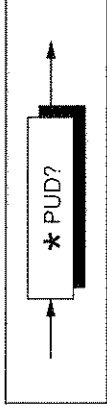

This common command conforms to the IEEE 488.2 standard requirements. *PUD? recalls previously entered user data. Refer to program command *PUD.

Response Syntax:

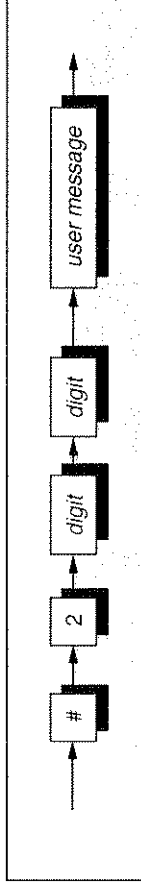

where:

digit = one of the ASCII-coded numerals previously determined from the length of the user message string,
user message = the saved user message.

Final Width = 215mm

Response Decode:

The previously-saved message is recalled.

If no message is available, the value of the two digits is 00. The data area contains up to 63 bytes of data.

A single query sent as a terminated program message will elicit a single response terminated by:

nl = newline with EOI

If multiple queries are sent as a string of program message units (separated by semi-colons with the string followed by a permitted terminator), then the responses will be sent as a similar string whose sequence corresponds to the sequence of the program queries. The final response in the string will be followed by the terminator:

nl = newline with EOI

Execution Errors:

None.

Power On and Reset Conditions

Data area remains unchanged.

6.C.12 Reset



*RST

will reset the instrument to a defined condition, stated for each applicable command with the command's description, and listed in Appendix D to Section 6.

The reset condition is not dependent on past-use history of the instrument except as noted below:

- *RST does not affect the following:
- the selected address of the instrument;
- calibration data that affect specifications;
- SRQ mask conditions;
- the state of the IEEE 488.1 interface.

Execution Errors:

None.

Power On and Reset Conditions

Not applicable.

Final Width = 215mm

6.C.13 Service Request Enable

This Status Byte data structure conforms to the IEEE 488.2 standard requirements for this structure.

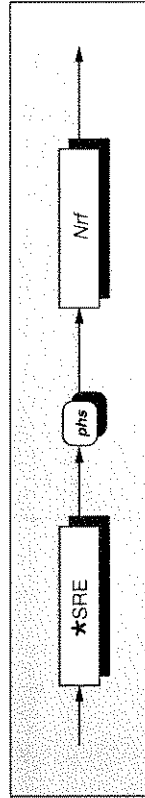

*SRE enables the standard and user-defined summary bits in the service request byte, which will generate a service request. Refer to Section 6, Subsection 6.5.

Nrf is a Decimal Numeric Data Element representing an integer/decimal value equivalent to the Hex value required to enable the appropriate bits in this 8-bit register. The detail definition is contained in the IEEE 488.2 document. Note that numbers **will** be rounded to an integer.

Execution Errors:

None.

Power On and Reset Conditions

Not applicable.

6.C.14 Recall Service Request Enable

This Status Byte structure conforms to the IEEE 488.2 standard requirements for this structure.

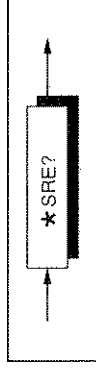

*SRE?

recalls the enable mask for the standard defined events. Refer to Section 6, Subsection 6.5.

Execution Errors:

None.

Power On and Reset Conditions

The Power On condition depends on the condition stored by the common *PSC command - if 0 then it is not cleared; if 1 then the register is cleared. Reset has no effect.

Response Decode:

The value returned, when converted to base 2 (binary), identifies the enabled bits which will generate a service request. The detail is contained in the IEEE 488.2 standard document.

6.C.15 Read Service Request Register

This Status Byte data structure conforms to the IEEE 488.2 standard requirements for this structure.

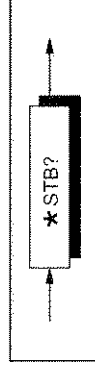

*STB?

recalls the service request register for summary bits. Refer to Section 6, Subsection 6.5.

Execution Errors:

None.

Power On and Reset Conditions

Not applicable.

Response Decode:

The value returned, when converted to base 2 (binary), identifies the summary bits for the current status of the data structures involved. For the detail definition see the IEEE 488.2 standard document. There is no method of clearing this byte directly. Its condition relies on the clearing of the overlying status data structure.

6.C.16 Test Operations — Full Selftest

This query conforms to the IEEE 488.2 standard requirements.

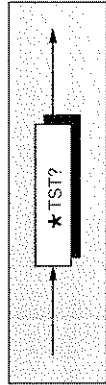

*TST?

executes a Full selftest. A response is generated after the test is completed.

N.B. Operational selftest is valid only at temperatures: $23^{\circ}\text{C}\pm 10^{\circ}\text{C}$.

Response Decode:

The value returned identifies pass or failure of the operational selftest:

ZERO indicates operational selftest complete with no errors detected.

ONE indicates operational selftest has failed.

The errors can be found only by re-running the selftest manually. Refer to Section 8.

Execution Errors:

Operational selftest is not permitted when calibration is successfully enabled.

Power On and Reset Conditions

Not applicable.

Final Width = 215mm

6.C.17 Wait

This command conforms to the IEEE 488.2 standard requirements.

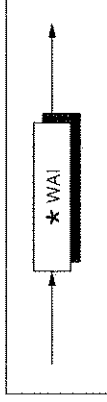

*WAI

prevents the instrument from executing any further commands or queries until the *No Pending Operations Flag* is set true. This is a mandatory command for IEEE-488.2 but has little relevance to this instrument as there are no parallel processes requiring Pending Operation Flags.

Execution Errors:

None.

Power On and Reset Conditions

Not applicable.

Final Width = 215mm

Model 9100 — Device Settings after *RST

6.D.1 Introduction

*RST

will reset the instrument to a defined condition, stated for each applicable command.

The reset condition is not dependent on past-use history of the instrument except as noted below:

*RST *does not* affect the following:

- the selected address of the instrument;
- calibration data that affect specifications;
- SRQ mask conditions;
- the contents of:
 - the Status Byte Register;
 - the Status Byte Enable Register;
 - the Standard Event Status Register;
 - the Standard Event Status Enable Register;
 - the SCPI Operation Status Register;
 - the SCPI Operation Status Enable Register;
 - the SCPI Questionable Status Register;
 - the SCPI Questionable Status Enable Register;
- the state of the IEEE 488.1 interface;
- the Error Queue;
- the Power-on Status Clear flag setting;
- the Protected User Data Query response.

The 'Enable Macro Command' (*EMC) is not used in the 9100.

The 'Define Device Trigger Command' (*DDT) is not used in the 9100.

Parallel Poll is not implemented in the 9100.

*RST enforces the following states:

- The 9100 reverts to Manual mode;
- the 9100 is returned to 'Operation Complete Command Idle State' (OCIS);
- the 9100 is returned to 'Operation Complete Query Idle State' (OQIS);
- Settings Related to Common IEEE 488.2 Commands are as detailed in paras 6.D.2, overleaf;
- Settings related to SCPI Commands are as detailed in paras 6.D.3, overleaf;

Final Width = 215mm

6.D.2 *RST Settings Related to Common IEEE 488.2 Commands

Program Coding	Condition
*CLS	Not applicable
*ESE Nrf	Not applicable
*ESE?	Previous state preserved
*ESR?	Previous state preserved
*IDN?	No Change
*OPC	OPIQ state forced
*OPC?	OPIQ state forced
*OPT?	Not applicable
*PSC 0/1	Not applicable
*PSC?	No change.
*PUD	Data area remains unchanged
*PUD?	Data area remains unchanged
*SRE Nrf	Not applicable
*SRE?	Previous state preserved
*STB?	Previous state preserved
*TST?	Not applicable
*WAI	Not applicable

Final Width = 215mm

6.D.3 *RST Settings Related to SCPI Commands

Keyword	Condition	Keyword	Condition
Calibration Disabled		STATUS	
:SECure		:OPERation	
:PASSword required to enter Calibration mode		:EVENT]? No change
		:ENABle(?)	... No change
OUTPUT		:CONDition?	.. Not applicable
		:QUESTionable	
:STATe] OFF	:EVENT]? No change
:COMPensation(?) OFF	:ENABle(?)	... No change
:ISElectiion(?) HIGH	:CONDition?	.. Not applicable
[SOURCE]		:PRESet Not applicable
:FUNctiion			
[:SHAPE] (?) DC	SYSTEM	
VOLTage Active	:ERRor? Not applicable
[LEVEL]		:DATE(?) As previously set, updated
[:IMMEDIATE]		:TIME(?) As previously set, updated
[:AMPLitude] (?) LV	:SVOLTage(?) As previously set
:HIGH(?) Not applicable	:VERSiion? 1993
:LOW(?) Not applicable		
CURRENT Inactive		
RESistance Inactive		
:UUT_I(?) LOW		
CONductance Inactive		
:UUT_I(?) LOW		
CAPacitance Inactive		
:UUT_I(?) LOW		
FREQuency Inactive		
PHASE Inactive		
[.ADJust] (?) 0°		
INPUT			
:STATe] (?) OFF		
OUTPUT			
:STATe] (?) OFF		
PULSe Inactive		
TEMPerature Inactive		
UNITS(?) C		
SCALE(?) TS68		
THERmocouple Inactive		
:TYPE(?) K		
PRT Inactive		
:TYPE(?) PT385		
:NRESistance(?) 100Ω		
:UUT_I(?) LOW		

Final Width = 215mm

Model 9100 — Device Settings at Power On

6.E.1 General

Active Mode: The 9100 can power-up in either 'Manual' or 'Procedure' mode, but Manual Mode or Calibration mode must be selected for Remote Operation.
 The required mode is selected by pressing **Mode** key on front panel and choosing from the Mode Menu (Calibration mode requires a password).

Device I/D (Serial Number) Protected User Data Factory serial number preserved
 Previous entry preserved

Status Reporting Conditions:

Status Byte Register Depends on state of *PSC
Status Byte Enable Register Depends on state of *PSC
Event Status Register Depends on state of *PSC
Event Status Enable Register Depends on state of *PSC
Operation Status Event Register Depends on state of *PSC
Operation Status Enable Register Depends on state of *PSC
Questionable Status Event Register Depends on state of *PSC
Questionable Status Enable Register Depends on state of *PSC
Error Queue Empty until first error is detected

6.E.2 Power-On Settings Related to Common IEEE 488.2 Commands

Program Coding	Condition
*CLS	Not applicable
*ESE Nrf	Not applicable
*ESE?	Response depends on state of *PSC
*ESR?	Response depends on state of *PSC
*IDN?	Not applicable
*OPC	Not applicable
*OPC?	Not applicable
*OPT?	Not applicable
*PSC 0/1	Not applicable
*PSC?	No change. This data is saved at power off for use at power on.
*PUD	Data area remains unchanged
*PUD?	Data area remains unchanged
*RST	Not applicable
*SRE Nrf	Not applicable
*SRE?	Response depends on state of *PSC
*STB?	Response depends on state of *PSC
*TST?	Not applicable
*WAI	Not applicable

Final Width = 21.5mm

6.E.3 Settings related to SCPI Commands

Keyword	Condition	Keyword	Condition
CALibration Disabled	STATUS	
:SECure		:OPERation	
:PASSword	Required to enter Cal Mode	:EVENT]? Depends on state of *PSC
OUTPut		:ENABLE(?) Depends on state of *PSC
[:STATE] OFF	:CONDITION? Not Applicable
:COMPensation(?) OFF	:QUESTIONable	
:ISElection(?) HIGH	:EVENT]? Depends on state of *PSC
[SOURCE]		:ENABLE(?) Depends on state of *PSC
:FUNCTION		:CONDITION? Not Applicable
[:SHApe](?) DC	:PReSet Not Applicable
:VOLTage Active	SYSTEM	
[:LEVEL]		:ERRor? Not applicable
[:IMMediate]		:DATE(?) As previously set, updated
[:AMPLitude](?) 1V	:TIME(?) As previously set, updated
:HIGH(?)	Not Applicable	:SVOLTage(?) As previously set
:LOW(?)	Not Applicable	:VERsion? 1993
:CURRent Inactive		
:RESistance Inactive		
:UUT_I(?) LOW		
:CONductance Inactive		
:UUT_I(?) LOW		
:CAPacitance Inactive		
:UUT_I(?) LOW		
:FREQuency Inactive		
:PHASE Inactive		
[:ADJust](?) 0°		
:INPut			
[:STATE](?) OFF		
:OUTPut			
[:STATE](?) OFF		
:PULSe Inactive		
:TEMPerature Inactive		
:UNITS(?)	C		
:SCALE(?)	TS68		
:THERmocouple Inactive		
:TYPE(?)	K		
:PRt Inactive		
:TYPE(?)	PT385		
:RESistance(?)	100Ω		
:UUT_I(?) LOW		

Final Width = 215mm

SECTION 7 9100 SPECIFICATIONS

7.1 General

7.1.1 Line Power Supply

Voltage (single ϕ): 100V/120V/220V/240V
selectable from rear panel
Variation: $\pm 10\%$ Nominal Voltage

Line Frequency: 48Hz to 63Hz

Consumption: 450VA max

Power Fuses: 220/240V: T3.15A HBC, 250V, IEC127
100/120V: T5.0A HBC, 250V, IEC127

7.1.2 Mechanical

Dimensions: Height: 3U

Width: 427mm (16.8 inches)

Depth: 460mm (18.1 inches)

Weight: 18.5kg (41lbs)

7.1.3 SAFETY:

Designed to UL1244, IEC348, IEC1010-1:
Pollution degree 2; installation category II;
Protection class I.

7.1.4 Peak Terminal Voltages and Currents

	Peak Volts to Ground	Peak Current
SHI	1500V	—
Hi	1500V	90mA
SLo	15V	—
Lo	15V	90mA
I+	10V	30A
I-	—	30A
Aux Analog Output	15V	1.5A

7.1.5 Environmental Conditions

Temperature: Operating: 5°C to 40°C
Transit: -20°C to 60°C <100hrs
Storage: 0°C to 50°C

Warm-up Time: 20 minutes

Max. Relative Humidity (non-condensing):
Operating: +5°C to +30°C: <90%,
+30°C to +40°C: <75%,
Storage: 0°C to +50°C: <95%.

Altitude

Operating: 0 to 2000m (6,562 ft)
Non-operating: 0 to 12,000m (40,000 ft)

Shock: MIL-T-28800, type III, class 5, style E.

Vibration: MIL-T-28800, type III, class 5, style E.

Enclosure: MIL-T-28800, type III, class 5, style E.

EMC: Designed to:
Generic Emissions: EN50081.
Generic Immunity: EN50082.
FCC Rules part 15 sub-part J class B.

Final Width = 215mm

7.1.6 The Meaning of 'Accuracy' when used in the Function Accuracy Tables

Accuracy includes long-term stability, temperature coefficient, linearity, load and line regulation and the traceability of factory and National calibration standards. Nothing further needs to be added to determine the Test Uncertainty Ratio over the instrument under test.

N.B. These specifications apply to both the Model 9100 output terminals and at the remote end of the Model 9105 lead kit unless otherwise stated.

7.2 Options and Associated Products

7.2.1 Model 9100 Option Summary

Option 10	Blank 256kByte, Flash memory.
Option 30	Blank 256kByte, Static RAM (SRAM), battery backed.
Option 50	Tracker Ball.
Option 60	Soft Carry Case.
Option 70	NAMAS Calibration Certificate traceable to National Standards.
Option 90	Rack Mounting Kit.
Option 100	High Stability Crystal Reference.
Option 200	10- and 50-Turn Current Coils.
Option 250	250MHz Oscilloscope Calibrator Module.
<i>or</i>	
Option 600	600MHz Oscilloscope Calibrator Module.
Line Voltage:	The 9100 is configured for use at the correct voltage at the shipment point.

Final Width = 215mm

7.2.2 Products Associated with the Model 9100

PLC-XXX	Procedure Library Cards (<i>User's Handbook Section 1, Sub-section 1.4</i>).
Model 9105	Comprehensive Lead Set (one unit supplied with each Model 9100 unit).
Model 9010	Memory Card Procedure Generator, inventory management software and memory card drive, supplied in 3.5" integral PC mount format, with accessories for external mounting. (Minimum hardware requirements: 100% IBM compatible, 80486 25MHz DX™ or better, with MS-DOS 5.0™ or later plus Windows™ Version 3.1 or later. 4MBytes of memory, 30MBytes of hard disk space is required for installation; further hard disk space will be required for generation of procedures, etc. One full-size expansion slot will be required.)

7.3 DC Voltage Specifications

7.3.1 DC Voltage Accuracy and Resolution

Voltage Output +ve & -ve Polarities	Accuracy * ±(% of Output + Floor) 1Year — Tcal ±5°C [1]	Compliance Current	Absolute Resolution
000.000 mV to 320.000 mV	0.006% + 4.16µV	< 20mA	1µV
0.32001 V to 3.20000 V	0.006% + 41.6µV	< 20mA	10µV
03.2001 V to 32.0000 V	0.0065% + 416µV	< 20mA	100µV
032.001 V to 320.000 V	0.0065% + 4.48mV	< 6mA	1mV
0320.01 V to 1050.00 V	0.006% + 19.95mV	< 6mA	10mV

* = For loads < 1MΩ; add load regulation error.

7.3.2 Other DCV Specifications

Settling Time:	to within 10% of accuracy: 0.08s
Load Regulation:	For loads < 1MΩ: add $(200/R_{LOAD})$ % of output
Maximum Capacitance:	1000pF.

Final Width = 215mm

NOTES: [1] Tcal = temperature at calibration. Factory calibration temperature = 23°C

7.4 AC Voltage Specifications

7.4.1 AC Voltage Accuracy (Sinusoidal Waveshape) and Resolution

Voltage Output	Frequency Band (2) (Hz)	Accuracy * ± (% Output + Floor) 1 Year — Tcal [1] ± 5°C	Current Compliance	Total Harmonic Distortion (% of Output)	Absolute Resolution
000.000 mV to 010.000 mV	10 - 3k	0.04 + 384µV	20mA	0.06	1µV
	3k - 10k	0.04 + 512µV	20mA	0.10	1µV
	10k - 30k	0.06 + 960µV	20mA	0.13	1µV
	30k - 50k	0.09 + 1.92mV	10mA	0.20	1µV
	50k - 100k	0.20 + 5.12mV	10mA	0.32	1µV
010.001 mV to 032.000 mV	10 - 3k	0.04 + 96.0µV	20mA	0.06	1µV
	3k - 10k	0.04 + 128µV	20mA	0.10	1µV
	10k - 30k	0.06 + 240µV	20mA	0.13	1µV
	30k - 50k	0.09 + 480µV	10mA	0.20	1µV
	50k - 100k	0.20 + 1.28mV	10mA	0.32	1µV
032.001 mV to 320.000 mV	10 - 3k	0.04 + 19.2µV	20mA	0.06	1µV
	3k - 10k	0.04 + 25.6µV	20mA	0.10	1µV
	10k - 30k	0.06 + 48.0µV	20mA	0.13	1µV
	30k - 50k	0.09 + 96.0µV	10mA	0.20	1µV
	50k - 100k	0.20 + 256µV	10mA	0.32	1µV
0.32001 V to 3.20000 V	10 - 3k	0.04 + 192µV	20mA	0.06	10µV
	3k - 10k	0.04 + 256µV	20mA	0.10	10µV
	10k - 30k	0.06 + 480µV	20mA	0.13	10µV
	30k - 50k	0.09 + 960µV	10mA	0.20	10µV
	50k - 100k	0.20 + 2.56mV	10mA	0.32	10µV
03.2001 V to 32.0000 V	10 - 3k	0.04 + 1.92mV	20mA	0.10	100µV
	3k - 10k	0.06 + 2.56mV	20mA	0.16	100µV
	10k - 30k	0.08 + 4.80mV	20mA	0.16	100µV
	30k - 50k	0.15 + 9.60mV	20mA	0.20	100µV
	50k - 100k	0.35 + 32.0mV	20mA	0.32	100µV
032.001 V to 105.000 V	10 - 3k	0.04 + 6.30mV	20mA	0.10	1mV
	3k - 10k	0.06 + 8.40mV	20mA	0.10	1mV
	10k - 30k	0.08 + 15.8mV	20mA	0.16	1mV
	30k - 50k	0.15 + 31.5mV	20mA	0.20	1mV
	50k - 100k	0.35 + 105mV	20mA	0.32	1mV
105.001 V to 320.000 V	40 - 100	0.05 + 19.2mV	6mA*	0.50	1mV
	100 - 1k	0.05 + 19.2mV	6mA*	0.32	1mV
	1k - 3k	0.08 + 19.2mV	6mA*	0.32	1mV
	3k - 10k	0.08 + 32.0mV	20mA	0.32	1mV
	10k - 20k	0.12 + 48.0mV	20mA	0.32	1mV
0320.01 V to 0800.00 V	20k - 30k	0.15 + 64.0mV	20mA	0.32	1mV
	40 - 100	0.05 + 63.0mV	6mA	0.50	10mV
	100 - 1k	0.05 + 63.0mV	6mA	0.32	10mV
	1k - 3k	0.08 + 63.0mV	6mA	0.32	10mV
	3k - 10k	0.08 + 105mV	20mA	0.32	10mV
0800.01 V to 1050.00 V	10k - 20k †	0.12 + 158mV	20mA	0.32	10mV
	20k - 30k †	0.15 + 210mV	20mA	0.32	10mV
	40 - 100	0.05 + 126mV	6mA	0.50	10mV
	100 - 1k	0.05 + 126mV	6mA	0.32	10mV
	1k - 3k	0.08 + 126mV	6mA	0.32	10mV
	3k - 10k	0.08 + 210mV	20mA	0.32	10mV
	10k - 20k †	0.12 + 315mV	20mA	0.32	10mV

* = For loads < 11MΩ; add load regulation error.

† = Availability of voltage and frequency combinations is subject to the Volt-Hertz limit (see V-Hz profile).

‡ = 20mA if the Power Option (Option PWR) is fitted.

Final Width = 215mm

7.4.2 Volt-Hertz Profile (Sinusoidal Waveshape)

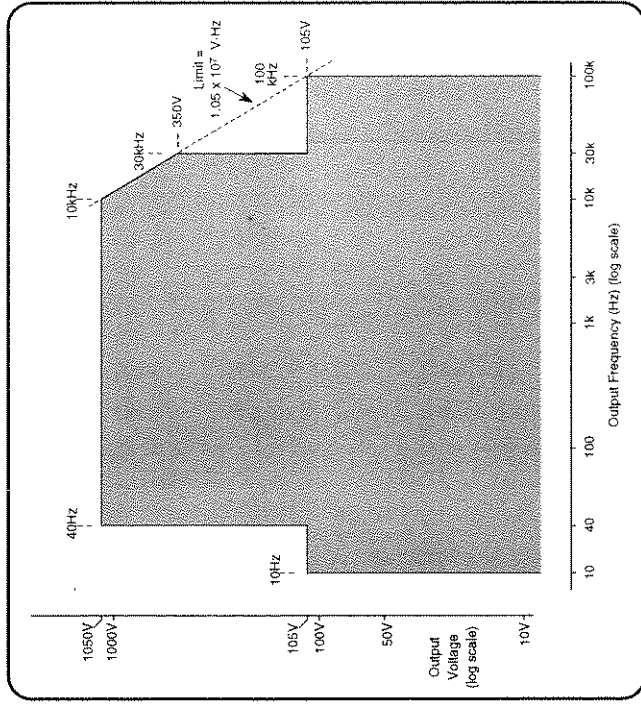

7.4.3 Frequency Spans vs Frequency Resolution

Absolute Resolution	Span of Frequencies
1mHz	010.000 Hz to 320.000 Hz
10mHz	0.01000 kHz to 3.20000 kHz
100mHz	00.0100 kHz to 32.0000 kHz
1Hz	000.010 kHz to 100.000 kHz

Final Width = 215mm

7.4.4 AC Voltage Phase (Sinusoidal Waveshape) *

Output Voltage Phase Span with respect to Phase Lock In = $\pm 180^\circ$
 Resolution of output voltage phase increments = 0.01°

Voltage Output	Selected Frequency f (Hz)	TTL Signals		1V to 3V RMS Sine Input † Output Phase Error with respect to 'Phase Lock In'
		Output Phase Error with respect to 'Phase Lock In'	Output Phase Error with respect to 'Phase Lock Out'	
0.30000 V to 105.000 V	10 - 40	$\pm 0.07^\circ$	$\pm 0.07^\circ$	$\pm 0.70^\circ$
	40 - 65	$\pm 0.07^\circ$	$\pm 0.07^\circ$	$\pm 0.14^\circ$
105.001 V to 0750.00 V ♦	65 - 1k	$\pm(0.07 + 0.001 \times f)^\circ$	$\pm(0.07 + 0.001 \times f)^\circ$	$\pm(0.14 + 0.001 \times f)^\circ$
	65 - 1k	$\pm 0.16^\circ$	$\pm 0.16^\circ$	$\pm 0.23^\circ$
		$\pm(0.16 + 0.0037 \times f)^\circ$	$\pm(0.16 + 0.0037 \times f)^\circ$	$\pm(0.23 + 0.0037 \times f)^\circ$

Note: An application can be employed in which the 'Slave' frequency is set to a harmonic (multiple) of the 'Master' frequency. In this case the slave frequency must not exceed 1kHz.

* = If two or more 9100 units are being used in a 'Master and Slave' configuration, this specification applies only when both Master and Slave are set to the same frequency. Mark/Space ratio of the input must not be less than 1:4.

† = DC-coupled input. Do not AC-couple. Up to 10mV p-p noise is rejected.

♦ = Maximum load current: 2mA; maximum load capacitance: 200pF.

NOTES: [1] Tcal = temperature at calibration. Factory calibration temperature = 23°C.

[2] Frequency Accuracy: 25ppm of output frequency.

More AC Voltage Specifications Overleaf

7.4 AC Voltage Specifications (Contd.)

7.4.5 AC Voltage Accuracy (Square-Wave)

Frequency Band [2] (Hz)	Output Voltage Span RMS	Output Voltage Span Peak	Accuracy * \pm (% Output + Floor) 1 Year — Tcal [1] \pm 5°C	Current Compliance
10 - 1k	0V - 14.08mV	0V - 14.14mV	0.12 + 450 μ V	20mA
10 - 1k	14.08mV - 45.08mV	14.14mV - 45.25mV	0.12 + 150 μ V	20mA
10 - 1k	45.08mV - 450mV	45.25mV - 452.5mV	0.12 + 40 μ V	20mA
10 - 1k	450mV - 4.5V	452.5mV - 4.525V	0.12 + 400 μ V	20mA
10 - 1k	4.5V - 45V	4.525V - 45.25V	0.12 + 4mV	20mA
10 - 1k	45V - 147.9V	45.25V - 148.4V	0.12 + 10mV	20mA
45 - 65	147.9V - 450V	148.4V - 452.5V	0.15 + 40mV	6mA
45 - 65	450V - 500V	452.5V - 502V	0.15 + 110mV	6mA

* = For loads < 1M Ω]; add load regulation error.

Ratios and Factors based on Square-Wave Unit-Value Peak

Peak: 1.0000
Peak to Peak: 2.0000
RMS: 0.9962
Mean: 0.9958
Crest Factor: 1.0038
Form Factor: 1.0004

7.4.6 AC Voltage Accuracy (Impulse-Wave)

Frequency Band [2] (Hz)	Output Voltage Span RMS	Output Voltage Span Peak	Accuracy * \pm (% Output + Floor) 1 Year — Tcal [1] \pm 5°C	Current Compliance
10 - 1k	0V - 7.43mV	0V - 14.14mV	0.30 + 1000 μ V	20mA
10 - 1k	7.43mV - 23.77mV	14.14mV - 45.25mV	0.30 + 500 μ V	20mA
10 - 1k	23.77mV - 238mV	45.25mV - 452.5mV	0.30 + 80 μ V	20mA
10 - 1k	238mV - 2.38V	452.5mV - 4.525V	0.30 + 800 μ V	20mA
10 - 1k	2.38V - 23.8V	4.525V - 45.25V	0.30 + 8mV	20mA
10 - 1k	23.8V - 78.05V	45.25V - 148.4V	0.30 + 20mV	20mA
45 - 65	78.05V - 238V	148.4V - 452.5V	0.35 + 80mV	6mA
45 - 65	238V - 500V	452.5V - 951V	0.35 + 200mV	6mA

* = For loads < 1M Ω]; add load regulation error.

Ratios and Factors based on Impulse-Wave Unit-Value Peak

Peak: 1.0000
Peak to Peak: 2.0000
RMS: 0.5270
Mean: 0.3333
Crest Factor: 1.8974
Form Factor: 1.5811

7.4.7 AC Voltage Accuracy (Triangular-Wave)

Frequency Band [2] (Hz)	Output Voltage Span RMS	Output Voltage Span Peak	Accuracy * \pm (% Output + Floor) 1 Year — Tcal [1] \pm 5°C	Current Compliance
10 - 1k	0V - 8.16mV	0V - 14.14mV	0.15 + 500 μ V	20mA
10 - 1k	8.16mV - 26.11mV	14.14mV - 45.25mV	0.15 + 175 μ V	20mA
10 - 1k	26.11mV - 261mV	45.25mV - 452.5mV	0.15 + 40 μ V	20mA
10 - 1k	261mV - 2.61V	452.5mV - 4.525V	0.15 + 400 μ V	20mA
10 - 1k	2.61V - 26.1V	4.525V - 45.25V	0.15 + 4mV	20mA
10 - 1k	26.1V - 85.7V	45.25V - 148.4V	0.15 + 10mV	20mA
45 - 65	85.7V - 261V	148.4V - 452.5V	0.18 + 40mV	6mA
45 - 65	261V - 500V	452.5V - 866V	0.18 + 120mV	6mA

* = For loads < 1M Ω]; add load regulation error.

Ratios and Factors based on Triangular-Wave Unit-Value Peak

Peak: 1.0000
Peak to Peak: 2.0000
RMS: 0.5774
Mean: 0.5000
Crest Factor: 1.7321
Form Factor: 1.1547

Final Width = 2.15mm

NOTES: [1] Tcal = temperature at calibration. Factory calibration temperature = 23°C.
[2] Frequency Accuracy: 25ppm of output frequency.

7.4.8 AC Voltage Accuracy (Trapezoidal-Wave)

Frequency Band [2] (Hz)	Output Voltage Span		Accuracy * ± (% Output + Floor) 1 Year — Total [1] ± 5°C	Current Compliance
	RMS	Peak		
10 - 1k	0V - 12.56mV	0V - 14.14mV	0.12 + 450µV	20mA
10 - 1k	12.56mV - 40.19mV	14.14mV - 45.25mV	0.12 + 150µV	20mA
10 - 1k	40.19mV - 402mV	45.25mV - 452.5mV	0.12 + 40µV	20mA
10 - 1k	402mV - 4.02V	452.5mV - 4.525V	0.12 + 400µV	20mA
10 - 1k	4.02V - 40.2V	4.525V - 45.25V	0.12 + 4mV	20mA
10 - 1k	40.2V - 131.9V	45.25V - 148.4V	0.12 + 10mV	20mA
45 - 65	131.9V - 402V	148.4V - 452.5V	0.15 + 40mV	6mA
45 - 65	402V - 500V	452.5V - 566V	0.15 + 110mV	6mA

* = For loads < 1MΩ; add load regulation error.

Ratios and Factors based on Trapezoidal-Wave Unit-Value Peak

Peak: 1.0000
 Peak to Peak: 2.0000
 RMS: 0.8819
 Mean: 0.8333
 Crest Factor: 1.3390
 Form Factor: 1.0583

7.4.9 Waveshape Harmonic Analysis

(Peak values as a percentage of the Fundamental's Peak Value)

Harmonic	Square	Impulse	Triangular	Trapezoidal
1	100.00	100.00	100.00	100.00
3	-33.32	60.71	11.11	-22.22
5	19.98	14.93	4.000	4.000
7	-14.25	-7.616	2.041	2.041
9	11.07	-6.746	1.235	-2.469
11	-9.040	-0.826	0.826	0.826
13	7.626	-0.592	0.592	0.592
15	-6.590	-2.428	0.444	-0.889
17	5.795	-1.291	0.346	0.346
19	-5.165	1.034	0.277	0.277
21	4.654	1.239	0.227	-0.454
23	-4.230	0.189	0.189	0.189
25	3.872	0.160	0.160	0.160
27	-3.565	0.750	0.137	-0.274
29	3.300	0.444	0.119	0.119
31	-3.068	-0.388	0.104	0.104
33	2.862	-0.502	0.092	-0.184
35	-2.679	-0.082	0.082	0.082
37	2.515	-0.073	0.073	0.073
39	-2.368	-0.359	0.066	-0.131
41	2.230	-0.222	0.060	0.060

Final Width = 215mm

7.4.10 Other ACV Specifications

Setting Time (to within 10% of accuracy): ≤105V: 0.08s; >105V: 0.5s.

Load Regulation:

For loads < 1MΩ: ≤105V, add: [(200/R_{LOAD}) + (C_{LOAD} * F₂ x 0.03)] % of output

For loads < 1MΩ: >105V, add: [(200/R_{LOAD}) + (C_{LOAD} * F₂ x 0.19 + C_{LOAD} * 3E7)] % of output

* = To calculate C_{LOAD} limit from Current compliance specification, while using 9105 lead set, allow ≈ 30pF for lead set.

Maximum Capacitance: 1000pF; subject to Output Current Limitations at HF.

7.5 DC Current Specifications

7.5.1 DC Current Accuracy and Resolution

Equivalent Current Output +ve & -ve Polarities	Accuracy ±(% of Output + Floor) 1 Year --- Tcal ±5°C [1]	Compliance Voltage (at 9100 terminals)	Compliance Voltage (at 9105 lead end)	Absolute Resolution
000.000µA - 320.000µA	0.014 + 11nA	4V	4V	1nA
0.32001mA - 3.20000mA	0.014 + 83nA	4V	4V	10nA
03.2001mA - 32.0000mA	0.014 + 900nA	4V	4V	100nA
032.001mA - 320.000mA	0.016 + 9.6µA	4V	4V	1µA
0.32001A - 3.20000A	0.060 + 118µA	2.2V	2.2V	10µA
03.2001A - 10.5000A	0.055 + 940µA	2.2V	2.1V	100µA
10.5001A - 20.0000A *	0.055 + 4.50mA	2.2V	2.0V	100µA

* = With output 'ON', maximum duty cycle of (>0.525FS; ≤0.525FS) is (1 : 4).
Continuous output >0.525FS will automatically reduce to <0.525FS after 2 Minutes.

7.5.2 Option 200: DC Current Accuracy and Resolution via Current Coils

Equivalent Current Output +ve & -ve Polarities	Accuracy † ±(% of Output + Floor) 1 Year --- Tcal ±5°C [1]	Absolute Resolution
10-Turn Coil:		
03.2001A - 32.0000 A	0.060 + 1.18mA	100µA
032.001A - 105.000A	0.055 + 9.40mA	1mA
105.001A - 200.000 A *	0.055 + 45.0mA	1mA
50-Turn Coil:		
016.001A - 160.000A	0.060 + 5.9mA	1mA
0160.01A - 0525.00A	0.055 + 47mA	10mA
0525.01A - 1000.00 A *	0.055 + 225mA	10mA

* = With output 'ON', maximum duty cycle of (>0.525FS; ≤0.525FS) is (1 : 4).
Continuous output >0.525FS will automatically reduce to <0.525FS after 2 Minutes.
† = Refers to accuracy at 9100 output terminals. With Option 200 coils connected, then at the output from the coils, add ±0.2% of output from coils for uncertainty of coils.

7.5.3 Other DCI Specifications

Settling Time:	to within 10% of accuracy: 0.08s
Maximum Terminal Inductance:	0 - 3.2mA : 50µH 3.2mA - 320mA : 30µH 320mA - 3.2A : 18µH 3.2A - 10.5A : 5.5µH 10.5A - 20A : 2.5µH 3.2A - 1000A : 700µH
(With 10 turn or 50 turn output selected):	

NOTES: [1] Tcal = temperature at calibration. Factory calibration temperature = 23°C

Final Width = 215mm

7.6 AC Current Specifications

7.6.1 AC Current Accuracy (Sinusoidal Waveshape)

Current Output	Frequency Band [2] (Hz)	Accuracy † ± (% Output + Floor) 1 Year - Tcal [1] ± 5°C	Compliance Voltage (VRMS at 9100 terminals)	Compliance Voltage (VRMS at 9105 Lead End)	Total Harmonic Distortion (% Output)	Compliance Error (A/V) for Vc>0.5VRMS	Absolute Resolution
000.000µA - 032.000µA	10 - 3k	0.07 + 900nA	4V	4V	0.10	60nA/V	1nA
	3k - 10k	0.10 + 1.8µA	4V	4V	0.25	600nA/V	1nA
	10k - 20k	0.20 + 6.0µA	4V	4V	0.40	2.4µA/V	1nA
	20k - 30k	0.25 + 9.0µA	4V	4V	0.60	5.4µA/V	1nA
032.001µA - 320.000µA	10 - 3k	0.07 + 300nA	4V	4V	0.10	60nA/V	1nA
	3k - 10k	0.10 + 600nA	4V	4V	0.25	600nA/V	1nA
	10k - 20k	0.20 + 2.0µA	4V	4V	0.40	2.4µA/V	1nA
	20k - 30k	0.25 + 3.0µA	4V	4V	0.60	5.4µA/V	1nA
0.32001mA - 3.20000mA	10 - 3k	0.07 + 300nA	4V	4V	0.10	60nA/V	10nA
	3k - 10k	0.10 + 600nA	4V	4V	0.25	600nA/V	10nA
	10k - 20k	0.20 + 2.0µA	4V	4V	0.40	2.4µA/V	10nA
	20k - 30k	0.25 + 3.0µA	4V	4V	0.60	5.4µA/V	10nA
03.2001mA - 32.0000mA	10 - 3k	0.07 + 3.2µA	4V	4V	0.10	0.5µA/V	100nA
	3k - 10k	0.10 + 6.4µA	4V	4V	0.25	4µA/V	100nA
	10k - 20k	0.20 + 12.8µA	4V	4V	0.40	15µA/V	100nA
	20k - 30k	0.25 + 22.4µA	4V	4V	0.60	32µA/V	100nA
032.001mA - 320.000mA	10 - 3k	0.08 + 32.0µA	4V	4V	0.10	2µA/V	1µA
	3k - 10k	0.10 + 48.0µA	4V	4V	0.25	4µA/V	1µA
	10k - 20k	0.20 + 64.0µA	4V	4V	0.40	15µA/V	1µA
	20k - 30k	0.25 + 96.0µA	4V	4V	0.60	35µA/V	1µA
0.32001A - 3.20000A	10 - 3k	0.10 + 480µA	2.5V	2.4V	0.20	90µA/V	10µA
	3k - 10k	0.25 + 2.56mA	2.5V	2.4V	1.10	600µA/V	10µA
	10 - 3k	0.20 + 3.0mA	2.5V	2.3V	0.20	0.3mA/V	100µA
	3k - 10k	0.50 + 10.0mA	2.2V	2.0V	1.10	2.1mA/V	100µA
03.2001A - 10.5000A	10 - 3k	0.20 + 6.9mA	2.5V ♦	2.2V ♦	0.30	0.3mA/V	100µA
	3k - 10k	0.50 + 23.0mA	2.1V	1.7V	1.50	2.1mA/V	100µA
	10 - 100	0.20 + 5.5mA	2.5V	2.5V	0.15	100µA	100µA
	100 - 440	0.78 + 27mA	2.5V	2.5V	0.50	100µA	100µA
032.001A - 290.000A ♦	10 - 100	0.21 + 90mA	2.5V ♦	2.3V ♦	0.15	1mA	1mA
	100 - 440	0.67 + 0.25A	2.5V	2.3V	0.50	1mA	1mA
	10 - 100	0.20 + 28mA	2.5V	2.5V	0.15	1mA	1mA
	10 - 100	0.21 + 0.45A	2.5V ♦	2.3V ♦	0.15	10mA	10mA

Final Width = 21.5mm

* = With output 'ON', maximum duty cycle of (>0.525FS : ≤0.525FS) is (1 : 4).
 Continuous output >0.525FS will automatically reduce to <0.525FS after 2 Minutes.

† = Total uncertainty includes compliance errors for Voltage ≤0.5VRMS.

♦ = Above 0.5V, add appropriate compliance error, except for Outputs marked ♥ and ▲.
 ♥ = Refers to accuracy at 9100 output terminals. With Option 200 10 turn coil connected, then at the output from the coil, add ±0.2% of output from coil for uncertainty of coil.

▲ = Refers to accuracy at 9100 output terminals. With Option 200 50 turn coil connected, then at the output from the coil, add ±0.2% of output from coil for uncertainty of coil.

◆ = For frequencies <40Hz, compliance voltage is reduced by 0.5V RMS.

▲ = These coils have been designed for optimum accuracy and inductance for use with the Model 9100. With some Hall effect clamp meters the increase in inductance, due to the current clamp design, will limit the obtainable 9100 Current/Hertz profile. In some cases, 1000A cannot be reached at higher frequency.

NOTES: [1] Tcal = temperature at calibration. Factory calibration temperature = 23°C.

[2] Frequency Accuracy: 25ppm of output frequency.

(More ACI Specifications overleaf)

7.6 AC Current Specifications (Contd.)

7.6.2 Amp-Hertz Profile (Sinusoidal Waveshape)

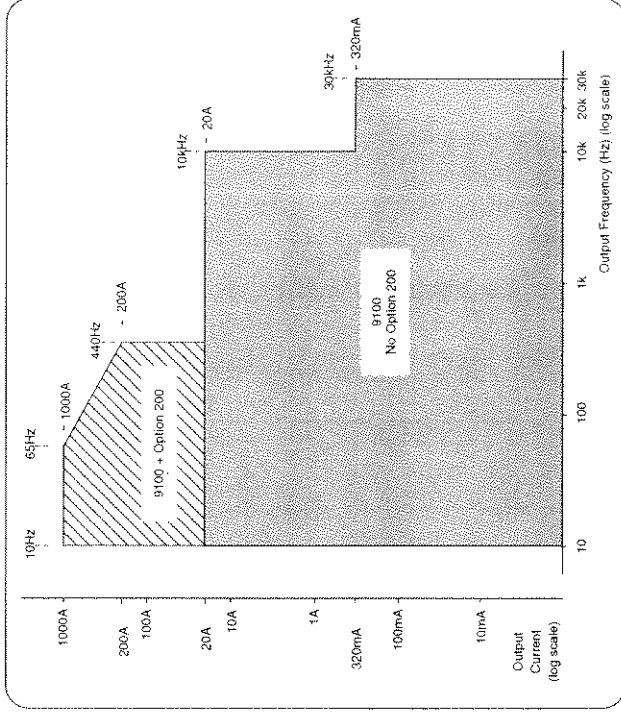

7.6.3 Frequency Spans vs Frequency Resolutions

Absolute Resolution	Span of Frequencies
1mHz	010.000 Hz to 320.000 Hz
10mHz	0.01000 kHz to 3.20000 kHz
100mHz	00.01000 kHz to 30.00000 kHz

7.6.4 AC Current Phase (Sinusoidal Waveshape) *

Output Current Phase Span with respect to Phase Lock In = $\pm 180^\circ$
 Resolution of Output Current phase increments = 0.01°

Current Output	Selected Frequency f (Hz)	TTL Signals Output Phase Error with respect to 'Phase Lock In'	1V to 3V RMS Sine Input † Output Phase Error with respect to 'Phase Lock In'
0.00000 A - 20.00000 A	10 - 40 40 - 65 65 - 1k	$\pm 0.08^\circ$ $\pm 0.08^\circ$ $\pm(0.08 + 0.0008 \times f)^\circ$	$\pm 0.71^\circ$ $\pm 0.15^\circ$ $\pm(0.15 + 0.001 \times f)^\circ$
03.20000 A - 1000.000 A ▲	10 - 40 40 - 65 65 - 1k	$\pm 0.23^\circ$ $\pm 0.23^\circ$ $\pm(0.23 + 0.003 \times f)^\circ$	$\pm 0.8^\circ$ $\pm 0.3^\circ$ $\pm(0.3 + 0.0037 \times f)^\circ$

Note: An application can be employed in which the 'Slave' frequency is set to a harmonic (multiple) of the 'Master' frequency. In this case the slave frequency must not exceed 1kHz.

* = If two or more 9100 units are being used in a 'Master and Slave' configuration, this specification applies only when both Master and Slave are set to the same frequency. Mark/Space ratio of the input must not be less than 1:4.

† = DC-coupled input. Do not AC-couple. Up to 10mV p-p noise is rejected.

▲ = With 10-turn or 50-turn output selected (Option 200).

NOTES: [1] Tcal = temperature at calibration. Factory calibration temperature = 23°C .
 [2] Frequency Accuracy: 25ppm of output frequency.

7.6.5 AC Current Accuracy (Square-Wave)

Frequency Band [2] (Hz)	Output Current Span		Accuracy † ± (% Output + Floor) 1 Year — Tcal [1] ± 5°C	Voltage Compliance (VRMS)
	RMS	Peak		
10 - 1k	0µA - 45.08µA	0V - 45.25µA	0.21 + 1.9µA	4.0
10 - 1k	45.08µA - 4.508mA	45.25µA - 4.525mA	0.21 + 0.6µA	4.0
10 - 1k	4.508mA - 45.08mA	4.525mA - 45.25mA	0.21 + 6.4µA	4.0
10 - 1k	45.08mA - 450.8mA	45.25mA - 452.5mA	0.24 + 64µA	4.0
10 - 100	0.4508A - 3.200A	0.4525A - 3.212A	0.30 + 960µA	2.2
10 - 100	3.200A - 18.00A*	3.212A - 18.07A	0.4 + 13.8mA	2.2 †
10 - 65	4.508A - 32.00A †	4.525A - 32.12A	1.0 + 16.8mA	2.2
10 - 65	32.00A - 180.0A* †	32.12A - 180.7A	1.2 + 162mA	2.2 †
10 - 65	22.54A - 160.0A †	22.63A - 160.6A	1.0 + 84mA	2.2
10 - 65	160.0A - 900.0A †	160.6A - 903.5A	1.2 + 0.82A	2.2 †

* = With output 'ON', maximum duty cycle of (>0.528FS : ≤0.528FS) is (1 : 4). Continuous output >0.528FS will automatically reduce to <0.528FS after 2 Minutes.

† = Total uncertainty includes compliance errors for Voltage ≤0.5VRMS.

‡ = Above 0.5V, add appropriate compliance error, except for Outputs marked † and ‡.

† = Refers to accuracy at 9100 output terminals. With Option 200 10 turn coil connected, then at the output from the coil, add ±0.2% of output from coil for uncertainty of coil.

‡ = Refers to accuracy at 9100 output terminals. With Option 200 50 turn coil connected, then at the output from the coil, add ±0.2% of output from coil for uncertainty of coil.

‡ = For frequencies <40Hz, compliance voltage is reduced by 0.5V RMS.

7.6.6 AC Current Accuracy (Impulse-Wave)

Frequency Band [2] (Hz)	Output Current Span		Accuracy † ± (% Output + Floor) 1 Year — Tcal [1] ± 5°C	Voltage Compliance (VRMS)
	RMS	Peak		
10 - 1k	0µA - 23.79µA	0V - 45.25µA	0.42 + 2.7µA	3.0
10 - 1k	23.79µA - 2.379mA	45.25µA - 4.525mA	0.42 + 0.9µA	3.0
10 - 1k	2.379mA - 23.79mA	4.525mA - 45.25mA	0.42 + 9.6µA	3.0
10 - 1k	23.79mA - 237.9mA	45.25mA - 452.5mA	0.48 + 96µA	3.0
10 - 100	0.2379A - 2.379A	0.4525A - 4.525A	0.60 + 1.44mA	1.8
10 - 100	2.379A - 15.00A*	4.525A - 28.53A	0.80 + 20.7mA	1.8 †
10 - 65	2.379A - 23.79A †	4.525A - 45.25A	0.80 + 25.2mA	1.8
10 - 65	23.79A - 150.0A* †	45.25A - 285.3A	1.20 + 243mA	1.8 †
10 - 65	118.9A - 118.9A †	226.3A - 226.3A	0.80 + 126mA	1.8 †
10 - 65	118.9A - 750.0A* †	226.3A - 1426A	1.20 + 1.23A	1.8 †

* = With output 'ON', maximum duty cycle of (>0.7FS : ≤0.7FS) is (1 : 4).

† = Continuous output >0.525FS will automatically reduce to <0.525FS after 2 Minutes.

‡ = Total uncertainty includes compliance errors for Voltage ≤0.5VRMS.

‡ = Above 0.5V, add appropriate compliance error, except for Outputs marked † and ‡.

† = Refers to accuracy at 9100 output terminals. With Option 200 10 turn coil connected, then at the output from the coil, add ±0.2% of output from coil for uncertainty of coil.

‡ = Refers to accuracy at 9100 output terminals. With Option 200 50 turn coil connected, then at the output from the coil, add ±0.2% of output from coil for uncertainty of coil.

‡ = For frequencies <40Hz, compliance voltage is reduced by 0.5V RMS.

Ratios and Factors based on Square-Wave Unit-Value Peak

Peak: 1.0000
 Peak to Peak: 2.0000
 RMS: 0.9962
 Mean: 0.9958
 Crest Factor: 1.0038
 Form Factor: 1.0004

Ratios and Factors based on Impulse-Wave Unit-Value Peak

Peak: 1.0000
 Peak to Peak: 2.0000
 RMS: 0.5270
 Mean: 0.3333
 Crest Factor: 1.8974
 Form Factor: 1.5811

Final Width = 215mm

7.6 AC Current Specifications (Contd.)

7.6.7 AC Current Accuracy (Triangular-Wave)

Frequency Band [2] (Hz)	Output Current Span		Accuracy † ± (% Output + Floor) 1 Year — Total [1] ± 5°C	Voltage Compliance (VRMS)
	RMS	Peak		
10 - 1k	0µA - 26.12µA	0µA - 45.25µA	0.21 + 1.8µA	3.2
10 - 1k	26.12µA - 2.612mA	45.25µA - 4.525mA	0.21 + 0.6µA	3.2
10 - 1k	2.612mA - 26.12mA	4.525mA - 45.25mA	0.21 + 6.4µA	3.2
10 - 1k	26.12mA - 261.2mA	45.25mA - 452.5mA	0.24 + 64µA	3.2
10 - 100	0.2612A - 2.612A	0.4525A - 4.525A	0.30 + 960µA	2.0
10 - 100	2.612A - 16.30A*	4.525A - 28.23A	0.40 + 13.8mA	2.0
10 - 65	2.612A - 26.12A	4.525A - 45.25A	0.40 + 16.8mA	2.0
10 - 65	26.12A - 163.0A*	45.25A - 282.3A	0.60 + 162mA	2.0
10 - 65	13.06A - 130.6A	22.62A - 226.2A	0.40 + 84mA	2.0
10 - 65	130.6A - 815.0A*	226.2A - 1411A	0.60 + 0.82A	2.0

* = With output 'ON', maximum duty cycle of (>0.644FS : ≤0.644FS) is (1 : 4). Continuous output >0.644FS will automatically reduce to <0.644FS after 2 Minutes.

† = Total uncertainty includes compliance errors for Voltage ≤0.5VRMS.

♥ = Above 0.5V, add appropriate compliance error, except for Outputs marked ♥ and ♣.

♣ = Refers to accuracy at 9100 output terminals. With Option 200 10 turn coil connected, then at the output from the coil, add ±0.2% of output from coil for uncertainty of coil.

♠ = Refers to accuracy at 9100 output terminals. With Option 200 50 turn coil connected, then at the output from the coil, add ±0.2% of output from coil for uncertainty of coil.

♣ = For frequencies <40Hz, compliance voltage is reduced by 0.5V RMS.

Ratios and Factors based on Triangular-Wave Unit-Value Peak

Peak: 1.0000
Peak to Peak: 2.0000
RMS: 0.5774
Mean: 0.5000
Crest Factor: 1.7321
Form Factor: 1.1547

7.6.8 AC Current Accuracy (Trapezoidal-Wave)

Frequency Band [2] (Hz)	Output Current Span		Accuracy † ± (% Output + Floor) 1 Year — Total [1] ± 5°C	Voltage Compliance (VRMS)
	RMS	Peak		
10 - 1k	0µA - 39.91µA	0V - 45.25µA	0.21 + 1.8µA	4.0
10 - 1k	39.91µA - 3.991mA	45.25µA - 4.525mA	0.21 + 0.6µA	4.0
10 - 1k	3.991mA - 39.91mA	4.525mA - 45.25mA	0.21 + 6.4µA	4.0
10 - 1k	39.91mA - 399.1mA	45.25mA - 452.5mA	0.24 + 64µA	4.0
10 - 100	0.3991A - 3.200A	0.4525A - 3.628A	0.30 + 960µA	2.3
10 - 100	3.200A - 19.20A*	3.628A - 21.77A	0.40 + 13.8mA	2.3
10 - 65	3.991A - 32.00A	4.525A - 36.28A	0.40 + 16.8mA	2.3
10 - 65	32.00A - 192.0A*	36.28A - 217.7A	0.60 + 162mA	2.3
10 - 65	19.95A - 160.0A	22.62A - 181.4A	0.40 + 84mA	2.3
10 - 65	160.0A - 960.0A	181.4A - 1088A	0.60 + 0.82A	2.3

* = With output 'ON', maximum duty cycle of (>0.547FS : ≤0.547FS) is (1 : 4).

† = Total uncertainty includes compliance errors for Voltage ≤0.547FS after 2 Minutes.

♥ = Above 0.5V, add appropriate compliance error, except for Outputs marked ♥ and ♣.

♣ = Refers to accuracy at 9100 output terminals. With Option 200 10 turn coil connected, then at the output from the coil, add ±0.2% of output from coil for uncertainty of coil.

♠ = Refers to accuracy at 9100 output terminals. With Option 200 50 turn coil connected, then at the output from the coil, add ±0.2% of output from coil for uncertainty of coil.

♣ = For frequencies <40Hz, compliance voltage is reduced by 0.5V RMS.

Ratios and Factors based on Trapezoidal-Wave Unit-Value Peak

Peak: 1.0000
Peak to Peak: 2.0000
RMS: 0.8819
Mean: 0.8333
Crest Factor: 1.3389
Form Factor: 1.0583

Final Width = 215mm

7.6.9 Waveshape Harmonic Analysis

(Peak values as a percentage of the Fundamental's Peak Value)

Harmonic	Square	Impulse	Triangular	Trapezoidal
1	100.00	100.00	100.00	100.00
3	-33.32	60.71	11.11	-22.22
5	19.98	14.93	4.000	4.000
7	-14.25	-7.616	2.041	2.041
9	11.07	-6.746	1.235	-2.469
11	-9.040	-0.826	0.826	0.826
13	7.626	-0.592	0.592	0.592
15	-6.590	-2.428	0.444	-0.889
17	5.795	-1.291	0.346	0.346
19	-5.165	1.034	0.277	0.277
21	4.654	1.239	0.227	-0.454
23	-4.230	0.189	0.189	0.189
25	3.872	0.160	0.160	0.160
27	-3.565	0.750	0.137	-0.274
29	3.300	0.444	0.119	0.119
31	-3.068	-0.388	0.104	0.104
33	2.862	-0.502	0.092	-0.184
35	-2.679	-0.082	0.082	0.082
37	2.515	-0.073	0.073	0.073
39	-2.368	-0.359	0.066	-0.131
41	2.230	-0.222	0.060	0.060

Final Width = 215mm

7.6.10 Other ACI Specifications

Settling Time:	to within 10% of accuracy: 0.08s
Maximum Terminal Inductance:	0 - 3.2mA : 50µH 3.2mA - 320mA : 30µH 320mA - 3.2A : 18µH 3.2A - 10.5A : 5.5µH 10.5A - 20A : 2.5µH 3.2A - 1000A : 700µH
(With 10 turn or 50 turn output selected):	

- NOTES:** [1] T_{cal} = temperature at calibration. Factory calibration temperature = 23°C.
 [2] Frequency Accuracy: 25ppm of output frequency.

7.7 Resistance Specifications

7.7.1 Resistance Accuracy and Resolution

Resistance Output	Accuracy			Absolute Resolution
	(Source UUTi Low) ±(% of Output + Floor) 1Year — Tcal ±5°C [1]	(Source UUTi High) ±(% of Output + Floor) 1Year — Tcal ±5°C [1]	(Source UUTi Super) ±(% of Output + Floor) 1Year — Tcal ±5°C [1]	
00.0000 Ω to 40.0000 Ω	0.025 + 10.0mΩ	0.050 + 20.0mΩ	0.100 + 50.0mΩ	0.1mΩ
040.001 Ω to 400.000 Ω	0.020 + 20.0mΩ *	0.015 + 20.0mΩ	0.035 + 100mΩ	1mΩ
0.40001 kΩ to 4.00000 kΩ	0.015 + 80.0mΩ	0.015 + 80.0mΩ	0.035 + 200mΩ	10mΩ
04.0001 kΩ to 40.0000 kΩ	0.020 + 800mΩ	0.015 + 800mΩ	0.025 + 2.0Ω	100mΩ
040.001 kΩ to 400.000 kΩ	0.020 + 8.0Ω	0.018 + 8.0Ω	0.025 + 20Ω	1Ω
0.40001 MΩ to 4.00000 MΩ	0.050 + 100Ω	0.020 + 100Ω	0.040 + 200Ω	10Ω
04.0001 MΩ to 40.0000 MΩ	0.150 + 2.0kΩ	0.050 + 2.0kΩ	0.050 + 2.0kΩ	100Ω
040.001 MΩ to 400.000 MΩ	0.260 + 40.0kΩ	0.060 + 40.0kΩ	---	1kΩ

* = Valid for UUTi ≥ 200μA.

Below 200μA: new floor = (200μA + Actual UUTi) × 20mΩ.

7.7.3 Source Current — Limits

Hardware Configuration Limits on Span of Output Resistance	Source Current Limits	
	UUTi Low	UUTi High
00.0000 Ω to 40.0000 Ω	250μA to 3.5mA	2.5mA to 35mA
040.001 Ω to 400.000 Ω	25μA to 320μA	250μA to 3.5mA
0.40001 kΩ to 4.00000 kΩ	25μA to 320μA	250μA to 3.5mA
04.0001 kΩ to 40.0000 kΩ	2.5μA to 32μA	25μA to 350μA
040.001 kΩ to 400.000 kΩ	250nA to 3.2μA	2.5μA to 35μA
0.40001 MΩ to 4.00000 MΩ	25nA to 320nA	250nA to 3.5μA
04.0001 MΩ to 40.0000 MΩ	8nA to 32nA	25nA to 350nA
040.001 MΩ to 400.000 MΩ	4nA to 32nA	25nA to 200nA

7.7.4 Other Resistance Specifications

Maximum Measurement Voltage:	10V; $I_{\text{measure}} \times R_{\text{actual}} \leq 10V$
Settling Time:	to within 10% of accuracy: 0 - 40kΩ : <0.08s 40kΩ - 4MΩ : <0.3s 4MΩ - 400MΩ : <1s
4-wire Lead Compensation:	Max total lead resistance : 50Ω Nominal lead resistance rejection: 10000:1

NOTES: [1] Tcal = temperature at calibration. Factory calibration temperature = 23°C

Final Width = 215mm

7.8 Conductance Specifications

7.8.1 Conductance Accuracy

Conductance Output	Accuracy ±(% Output)	
	1 Year UUTi Low & High	Tcal ±5°C [1] UUTi Super
2.5nS - 25.0nS	0.40	N/A
25.0nS - 250.0nS	0.20	0.45
250.0nS - 2.5µS	0.12	0.27
2.5µS - 25.0µS	0.05	0.12
25.0µS - 250.0µS	0.05	0.12
250.0µS - 2.5mS	0.04	0.09

7.8.2 Conductance Span vs Resolution

Absolute Resolution	Span of Values
0.1pS	02.5000 nS to 25.0000 nS
1pS	002.500 nS to 250.000 nS
10pS	0.00250 µS to 2.50000 µS
100pS	00.0025 µS to 25.0000 µS
1nS	000.002 µS to 250.000 µS
10nS	0.00001 mS to 2.50000 mS

7.8.3 Source Current — Limits

Hardware Configuration Limits on Span of Output Conductance	Current Source Limits	
	UUTi Low	UUTi High
02.5000 nS to 25.0000 nS	4nA to 32nA	2.5nA to 200nA
025.001 nS to 250.000 nS	8nA to 32nA	25nA to 350nA
0.25001 µS to 2.50000 µS	25nA to 320nA	250nA to 3.5µA
02.5001 µS to 25.0000 µS	250nA to 3.2µA	2.5µA to 35µA
025.001 µS to 250.000 µS	2.5µA to 32µA	25µA to 350µA
0.25001 mS to 2.50000 mS	25µA to 320µA	250µA to 3.5mA
		2.5A to 35mA
		UUTi Super
		N/A
		250nA to 3.5µA
		2.5µA to 35µA
		25µA to 350µA
		250µA to 3.5mA

Final Width = 2.15mm

7.8.4 Other Conductance Specifications

Maximum Measurement Voltage:	10V; I _{measure} / I _{actual} : ≤10V
Settling Time:	to within 10% of accuracy : 2.5nS - 250nS : <1s 250nS - 25µS : <0.3s 25µS - 2.5mS : <0.08s
4-wire Lead Compensation:	Max total lead resistance : 50Ω Nominal lead resistance rejection: 10000:1

NOTES: [1] Tcal = temperature at calibration. Factory calibration temperature = 23°C

7.9 Frequency Function Specifications

7.9.1 Frequency Function Accuracy

Frequency Output	Accuracy ±(ppm of Output Frequency) 1Year — Tcal ±5°C [1] Standard	Accuracy ±(ppm of Output Frequency) 5Year — Tcal ±5°C [1] Option 100
0.5Hz - 10.0MHz	25.0	0.25

7.9.2 High and Low Voltage Limits and Voltage Accuracy

Frequency Span	Output Voltage V_o	Accuracy (±Volts) 1Year — Tcal ±5°C [1]
0.5Hz to 2MHz	$V_o \leq 6Vpk$	0.06V †
2MHz to 10MHz	$V_o \leq 6Vpk$	1.0V
0.5Hz to 1kHz	$6Vpk < V_o \leq 30Vpk$	0.3V

† = After first 150ns.

7.9.3 Frequency Spans vs Frequency Resolution

Absolute Resolution	Span of Frequencies	Output Voltage $\leq 6Vpk$	Output Voltage $> 6Vpk$
1mHz	000.500 Hz to 320.000 Hz	*	*
10mHz	0.00050 kHz to 1.00000 kHz	*	*
100mHz	1.00001 kHz to 3.20000 kHz	*	---
1Hz	00.0005 kHz to 32.0000 kHz	*	---
10Hz	000.001 kHz to 320.000 kHz	*	---
100Hz	0.00001 MHz to 3.20000 MHz	*	---
	00.0001 MHz to 10.0000 MHz	*	---

* = Peak outputs available at stated levels.

7.9.4 Rise Times (Specified into loads $R_L > 100k\Omega$ in parallel with $C_L \leq 100pF$)

For signals $\leq 6Vpk$: <40ns.

For signals $> 6Vpk$: <1.5 μ s.

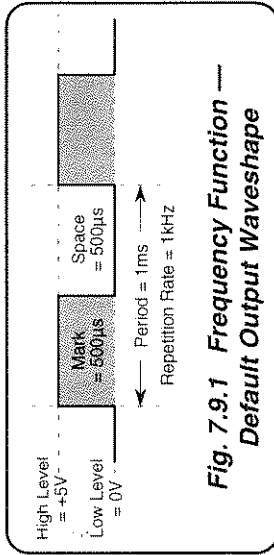

Fig. 7.9.1 Default Output Waveshape

Final Width = 215mm

NOTES: [1] Tcal = temperature at calibration. Factory calibration temperature = 23°C

7.10 Mark/Period Function Specifications

7.10.1 Pulse Width and Repetition Period Intervals Accuracy

Output Voltage	Interval	Accuracy ±(ppm of Output + Floor) 1Year — Tcal ±5°C [1]	Option 100 Accuracy ±(ppm of Output + Floor) 5Year — Tcal ±5°C [1]
$V_o \leq 6V_{pk}$	Pulse Width: 0.30µs to 1999.99ms Repetition Period: 0.6µs to 2000ms	25 + 10ns 25	0.25 + 10ns 0.25
$6V_{pk} < V_o \leq 30V_{pk}$	Pulse Width: 10µs to 1999.99ms Repetition Period: 1ms to 2000ms	25 + 200ns 25	0.25 + 200ns 0.25

7.10.2 High and Low Voltage Limits and Voltage Accuracy

Output Voltage V_o	Accuracy (±Volts) 1Year — Tcal ±5°C [1]
$V_o \leq 6V_{pk}$	0.06V †
$6V_{pk} < V_o \leq 30V_{pk}$	0.3V

† = After first 150ns.

7.10.3 Pulse Width Interval Spans vs Time Resolution

Absolute Resolution	$\leq 6V_{pk}$	$> 6V_{pk}$
100ns	000.3 µs to 999.9 µs*	010.00 µs to 990.0 µs**
100ns	00.0003 ms to 99.9999 ms*	00.0100 ms to 99.9999 ms**
1µs	000.001 ms to 999.999 ms	000.010 ms to 999.999 ms**
10µs	0000.01 ms to 1999.99 ms	0000.01 ms to 1999.99 ms

* = Maximum Pulse Width interval must be at least 0.3µs less than that of the set Repetition Period.

** = Maximum Pulse Width interval must be at least 10µs less than that of the set Repetition Period.

7.10.4 Repetition Period Interval Spans vs Time Resolution

Absolute Resolution	$\leq 6V_{pk}$	$> 6V_{pk}$
100ns	000.6 µs to 999.9 µs	-----
100ns	00.0006 ms to 99.9999 ms	01.0000 ms to 99.9999 ms
1µs	000.001 ms to 999.999 ms	001.000 ms to 999.999 ms
10µs	0000.01 ms to 2000.00 ms	0001.00 ms to 2000.00 ms

7.10.5 Rise Times (Specified into loads $R_L > 100k\Omega$ in parallel with $C_L \leq 100pF$)

For signals $\leq 6V_{pk}$: $< 40ns$.

For signals $> 6V_{pk}$: $< 1.5\mu s$.

NOTES: [1] Tcal = temperature at calibration. Factory calibration temperature = 23°C

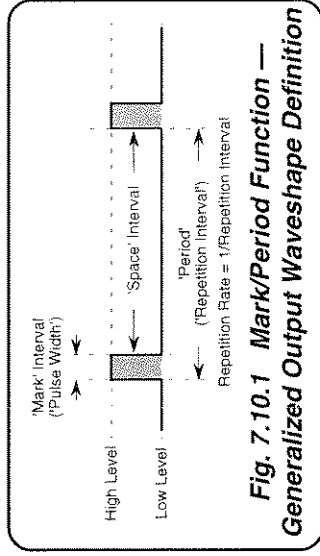

Fig. 7.10.1 Mark/Period Function — Generalized Output Waveshape Definition

Final Width = 215mm

7.11 % Duty Cycle Function Specifications

7.11.1 Introduction

Duty Cycle is a derived (relative) quantity which describes the Pulse Width / Repetition Period ratio of a pulsed waveform. In the 9100, it is expressed as a percentage. The values of Pulse Width and Repetition Period will change with frequency, while maintaining the same percentage ratio.

Hardware limitations drive the % Duty Cycle to a limit only when the Pulse Width and Repetition Period intervals reach their individual limits at particular frequencies. This means that any accuracy specification must be expressed in terms of constituent time intervals.

7.11.2 % Duty' Value: Screen Setting Limits

$$0.05\% \leq \% \text{ Duty} \leq 99.95\%$$

7.11.3 Repetition Period Interval Accuracy

Output Voltage	Interval	Accuracy ±(ppm of Output) 1Year — Tcal ±5°C [1]	Option 100 Accuracy ±(ppm of Output) 5Year — Tcal ±5°C [1]
$V_o \leq 6V_{pk}$	100µs to 2000ms	25	0.25
$6V_{pk} < V_o \leq 30V_{pk}$	1ms to 2000ms	25	0.25

7.11.4 Duty Cycle Accuracy

Output Voltage	Total Accuracy 1Year — Tcal ±5°C [1]
$V_o \leq 6V_{pk}$	35ns
$6V_{pk} < V_o \leq 30V_{pk} ‡$	225ns

‡ = Minimum Mark or Space interval: 10µs.

7.11.5 High and Low Voltage Limits and Voltage Accuracy

Output Voltage V_o	Accuracy (±Volts) 1Year — Tcal ±5°C [1]
$V_o \leq 6V_{pk}$	0.06V †
$6V_{pk} < V_o \leq 30V_{pk}$	0.3V

† = After first 150ns.

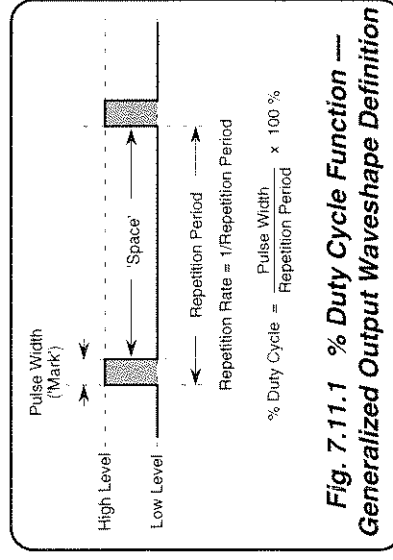

NOTES: [1] Tcal = temperature at calibration. Factory calibration temperature = 23°C.

7.11 % Duty Cycle Function Specifications (Contd.)

7.11.6 Repetition Period Interval Spans vs Time Resolution

Absolute Resolution	$\leq 6V_{pk}$	$> 6V_{pk}$
100ns	100.0 μ s to 999.9 μ s	-----
100ns	00.1000 ms to 99.9999 ms	01.0000 ms to 99.9999 ms
1 μ s	000.001 ms to 999.999 ms	001.000 ms to 999.999 ms
10 μ s	0000.01 ms to 2000.00 ms	0001.00 ms to 2000.00 ms

7.11.7 Rise Times (Specified into loads $R_L > 100k\Omega$ in parallel with $C_L \leq 100pF$)

For signals $\leq 6V_{pk}$: $< 40ns$.

For signals $> 6V_{pk}$: $< 1.5\mu s$.

Final Width = 215mm

7.12 Auxiliary Functions — Specifications

The Functions listed below are described as 'Auxiliary Functions' because they do not have their own individual front panel hard keys, but instead are accessed via the front-panel 'Aux' hard key, by screen selection from the 'Auxiliary Functions' menu.

Their specifications appear in the following sub-sections:

- 7.13 Capacitance Function Specifications
- 7.14 Thermocouple Temperature Function Specifications
- 7.15 RTD Temperature Function Specifications
- 7.16 Logic Pulses Function Specifications
- 7.17 Logic Levels Function Specifications

7.13 Capacitance Specifications

7.13.1 Capacitance Accuracy

Capacitance Output	Accuracy *			Absolute Resolution
	Source UUTI Low \pm (% of Output + Floor) 1 Year --- Tcal $\pm 5^{\circ}\text{C}$ [1] Stim Repetition Rate $\leq 350\text{Hz}$	Source UUTI Super \pm (% of Output + Floor) 1 Year --- Tcal $\pm 5^{\circ}\text{C}$ [1] Stim Repetition Rate $\leq 350\text{Hz}$	Source UUTI Super Stim Repetition Rate 350Hz to 1.5kHz	
0.5000 nF to 4.0000 nF	0.3 + 15pF	0.6 + 30.0pF	-----	0.1pF
4.0001 nF to 40.000 nF	0.3 + 30pF	0.6 + 60.0pF	-----	1pF
40.001 nF to 400.00 nF	0.3 + 160pF	0.6 + 320pF	-----	10pF
400.01 nF to 4.0000 μF	0.4 + 1.6nF	0.8 + 3.2nF	-----	100pF
4.0001 μF to 40.000 μF	0.5 + 16.0nF	1.0 + 32.0nF	-----	1nF
40.001 μF to 400.00 μF	0.5 + 160nF	1.0 + 320nF	0.75 + 160nF	10nF
400.01 μF to 4.0000 mF	0.5 + 1.6 μF	1.0 + 3.2 μF	0.75 + 1.6 μF	100nF
4.0001 mF to 40.000 mF	1.0 + 60 μF	2.0 + 120 μF	1.0 + 60 μF	1 μF

* = Accuracy specifications apply both at the 9100 output terminals, and at the output leads of the Model 9105 leadset.

7.13.2 Measurement and Discharge Current

Capacitance Output	Source UUTI Low		Source UUTI Super	
	Measurement Current Range	Maximum Discharge Current	Measurement Current Range	Maximum Discharge Current
0.5000 nF to 4.0000 nF	0.02 μA to 500 μA	1mA	-----	-----
4.0001 nF to 40.000 nF	0.02 μA to 500 μA	5mA	-----	-----
40.001 nF to 400.00 nF	0.04 μA to 1mA	10mA	-----	-----
400.01 nF to 4.0000 μF	0.5 μA to 1mA	10mA	-----	-----
4.0001 μF to 40.000 μF	5 μA to 3mA	10mA	-----	-----
40.001 μF to 400.00 μF	5 μA to 3mA	10mA	50 μA to 30mA	100mA
400.01 μF to 4.0000 mF	5 μA to 3mA	10mA	50 μA to 30mA	100mA
4.0001 mF to 40.000 mF	5 μA to 3mA	10mA	50 μA to 30mA	100mA

7.13.3 Other Capacitance Specifications

Maximum Measurement Voltage:	$\pm 3.5\text{V}$ (except 40 μF range which is limited to $\pm 2.5\text{V}$).
Settling Time:	to within 10% of accuracy : <0.08s
4-wire Lead Compensation:	Max total lead resistance : 10 Ω

NOTES: [1] Tcal = temperature at calibration. Factory calibration temperature = 23°C

7.14 Thermocouple Temperature Specifications

7.14.1 Temperature Accuracy (Temperature scales selectable between IPTS-68 and ITS-90)

Thermo-Couple Type	Temperature Output (Screen Resolution Shown)	Accuracy * † ‡ (±°C) 1 Year — Tcal ±5°C [1]
B	+0500.0°C - +0800.0°C	0.55
	+0800.0°C - +1000.0°C	0.41
	+1000.0°C - +1400.0°C	0.34
	+1400.0°C - +1820.0°C	0.37
C	0000.0°C - +0600.0°C	0.29
	+0600.0°C - +1000.0°C	0.27
	+1000.0°C - +1800.0°C	0.40
	+1800.0°C - +2320.0°C	0.41
E	-0250.0°C - -0200.0°C	0.45
	-0200.0°C - -0100.0°C	0.22
	-0100.0°C - +0100.0°C	0.17
	+0100.0°C - +1000.0°C	0.21
J	-0210.0°C - -0100.0°C	0.25
	-0100.0°C - +0800.0°C	0.19
	+0800.0°C - +1000.0°C	0.21
	+1000.0°C - +1200.0°C	0.23
K	-0250.0°C - -0200.0°C	0.57
	-0200.0°C - -0100.0°C	0.27
	-0100.0°C - +0100.0°C	0.19
	+0100.0°C - +0600.0°C	0.23
L	+0600.0°C - +1372.0°C	0.27
	-0200.0°C - -0050.0°C	0.26
	-0050.0°C - +0200.0°C	0.18
	+0200.0°C - +0700.0°C	0.20
N	+0700.0°C - +0900.0°C	0.23
	-0200.0°C - -0100.0°C	0.33
	-0100.0°C - +0900.0°C	0.23
	+0900.0°C - +1100.0°C	0.22
R †	+1100.0°C - +1300.0°C	0.24
	0000.0°C - +0100.0°C	0.52
	+0100.0°C - +0200.0°C	0.40
	+0200.0°C - +1600.0°C	0.35
S †	+1600.0°C - +1767.0°C	0.28
	0000.0°C - +0200.0°C	0.49
	+0200.0°C - +1000.0°C	0.37
	+1000.0°C - +1400.0°C	0.35
T	+1400.0°C - +1767.0°C	0.36
	-0250.0°C - -0200.0°C	0.59
	-0200.0°C - -0100.0°C	0.27
	-0100.0°C - 0000.0°C	0.22
	0000.0°C - +0400.0°C	0.17

NOTE: To calculate the Model 9100's accuracy in °F (Fahrenheit) or K (Kelvin) proceed as follows:-

- Convert the temperature in °F or K to °C using one of the following formulae as appropriate:

$$^{\circ}\text{C} = \text{K} - 273$$

$$^{\circ}\text{C} = \frac{(^{\circ}\text{F} - 32) \times 5}{9}$$

- Read the Model 9100's accuracy ($\pm\Delta^{\circ}\text{C}$) at this °C temperature from the accuracy table.
- Convert $\Delta^{\circ}\text{C}$ back to $\Delta^{\circ}\text{F}$ or ΔK using one of the following formulae as appropriate:

$$\Delta\text{K} = \Delta^{\circ}\text{C}$$

$$\Delta^{\circ}\text{F} = \frac{\Delta^{\circ}\text{C} \times 9}{5}$$

Example:

To calculate accuracy in °F ($\Delta^{\circ}\text{F}$) of K-Type output at 1994°F

- $^{\circ}\text{C} = \frac{(1994 - 32) \times 5}{9} = 1090^{\circ}\text{C}$
- $\Delta^{\circ}\text{C}$ at 1090°C = $\pm 0.27^{\circ}\text{C}$
- $\Delta^{\circ}\text{F} = \frac{0.27 \times 9}{5} = \pm 0.486^{\circ}\text{F}$

Final Width = 215mm

7.14.2 Other Thermocouple Output Specifications

Settling Time:	to within 10% of accuracy: 0.08s
Load Regulation:	(200/R _{Load}) % of output
Maximum Capacitance:	1000pF.

- * = Accuracy figures include C/JC error.
- † = Compensated output determined from pre-defined tables based on: IPTS-68 Reference Table NIST Monograph 125 for Types: B, E, J, K, R, S and T; ITS-90 Reference Table NIST Monograph 175 for Types: B, E, J, K, N, R, S and T; IPTS-68 Reference Table DIN 43710 for Type L; ITS-90 Reference Table DIN 43710 for Type L.
- ‡ = For loads < 1MΩ add load regulation error.
- ♦ = Types R & S adjusted above 1700°C for IPTS-68 as per NIST monograph 175.

NOTES: [1] Tcal = temperature at calibration. Factory calibration temperature = 23°C

7.15 RTD Temperature Specifications

7.15.1 RTD Temperature Accuracy *

To calculate accuracy in units of °F (Fahrenheit) and K (Kelvin), see the note in sub-sect. 7.14 (Thermocouple Specifications).

Temperature Output	Accuracy * : ±(% of Output + Floor) 1 Year — Tcal ±5°C [1]		
	Resistance at 0°C = 10Ω - 60Ω	Resistance at 0°C = 60Ω - 1kΩ	Resistance at 0°C = 1kΩ - 2kΩ
-200°C to -100°C	0.00 + 0.225°C	0.00 + 0.15°C	0.00 + 0.12°C
-100°C to +100°C	0.00 + 0.15°C	0.00 + 0.10°C	0.00 + 0.08°C
+100°C to +630°C	0.00 + 0.30°C	0.00 + 0.20°C	0.00 + 0.16°C
+630°C to +850°C	0.00 + 0.45°C	0.00 + 0.30°C	0.00 + 0.24°C

* = Accuracy figures apply to Output Temperature vs Resistance curves PT385 or PT392 and to Temperature Scales IPTS-68 or ITS-90 as selected by the user.

PT385, IPTS-68 as per IEC751.

PT392, IPTS-68 as per SAMA.

PT385, ITS-90 as per IEC751 amendment 2.

PT392, ITS-90 as per NIST monograph 175 corrections (90-68).

7.15.2 Spans of UUT Source Currents

Hardware Configuration Limits on Span of Output Resistance	Source Current Limits		
	UUTI Low	UUTI High	UUTI Super
00.0000 Ω to 40.0000 Ω	250µA to 3.5mA	2.5mA to 35mA	25mA to 350mA
040.001 Ω to 400.000 Ω	25µA to 320µA	250µA to 3.5mA	2.5mA to 35mA
0.40001 kΩ to 4.00000 kΩ	25µA to 320µA	250µA to 3.5mA	2.5mA to 35mA
04.0001 kΩ to 10.0000 kΩ †	2.5µA to 32µA	25µA to 350µA	250µA to 3.5mA

† = Resistance span used when the nominal operating point of the detector is raised, to give resistance values above 4kΩ for certain temperature readings.

7.15.3 Other RTD Temperature Specifications

Maximum Measurement Voltage:	10V; $I_{\text{measure}} \times R_{\text{actual}} : \leq 10V$
Settling Time:	to within 10% of accuracy : <0.08s
4-wire Lead Compensation:	Max total lead resistance : 50Ω Nominal lead resistance rejection: 10000:1

NOTES: [1] Tcal = temperature at calibration. Factory calibration temperature = 23°C.

Final Width = 215mm

7.16 Logic-Pulses Function Specifications

7.16.1 Pulse Width and Repetition Period Intervals Accuracy

Interval	Accuracy ±(ppm of Output + Floor) 1Year — Tcal ±5°C [1]	Option 100 Accuracy ±(ppm of Output + Floor) 5Year — Tcal ±5°C [1]
Pulse Width: 0.30µs to 1999.99ms	25 + 10.0ns	0.25 + 10.0ns
Repetition Period: 0.6µs to 2000.00ms	25	0.25

7.16.2 Fixed High/Low Levels & Voltage — Accuracy

Selected Logic	Signal Level	Voltage	Accuracy (±Volts) 1Year — Tcal ±5°C [1]
TTL	High	+5.00 V	0.06
	Low	0.00 V	0.06
CMOS	High	+5.00 V	0.06
	Low	0.00 V	0.06
ECL	High	-0.90 V	0.06
	Low	-1.75 V	0.06

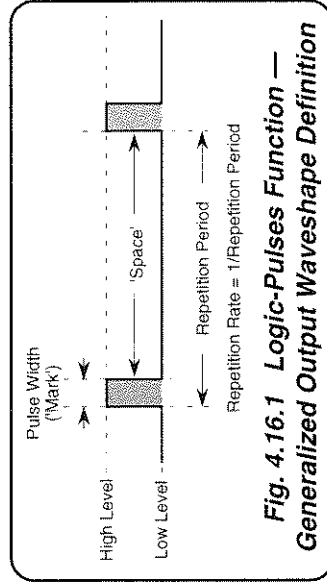

Final Width = 2.15mm

7.16.3 'Pulse Width' Interval vs Resolution

Absolute Resolution	Pulse Width
100ns	000.3 µs to 999.9 µs*
100ns	00.0003 ms to 99.9999 ms*
1µs	000.001 ms to 999.999 ms
10µs	0000.01 ms to 1999.99 ms

* = Maximum Pulse Width interval must be at least 0.3µs less than that of the set Repetition Period.

7.16.4 'Repetition Period' Interval vs Resolution

Absolute Resolution	Repetition Period
100ns	000.6 µs to 999.9 µs
100ns	00.0006 ms to 99.9999 ms
1µs	000.001 ms to 999.999 ms
10µs	0000.01 ms to 2000.00 ms

NOTES: [1] Tcal = temperature at calibration. Factory calibration temperature = 23°C.

7.17 Logic-Levels Function Specifications

7.17.1 Logic-Levels Accuracy

The accuracy of each DC signal voltage is the same as that of the equivalent voltage in DC Voltage Function (*Sub-section 7.3*).

7.17.2 Logic-Levels DC Signal Voltage Boundaries

Logic Type	Signal Level	Screen Indication	Default Value ('H' or 'L')	Boundaries	Adjustment Limits
TTL	High	HIGH LVL	+5.00V	$V \geq +2.00V$	+5.50V
	Intermediate	---	---	$+0.8V < V < +2.00V$	---
	Low	LOW LVL	0.00V	$V \leq 0.8V$	0.00V
CMOS	High	HIGH LVL	+5.00V	$V \geq +3.50V$	+6.00V
	Intermediate	---	---	$+1.5V < V < +3.50V$	---
	Low	LOW LVL	0.00V	$V \leq 1.5V$	0.00V
ECL	High	HIGH LVL	-0.9V	$V \geq -1.11V$	0.00V
	Intermediate	---	---	$-1.48V < V < -1.11V$	---
	Low	LOW LVL	-1.75V	$V \geq -1.48V$	-5.20V

Final Width = 215mm

7.18 Insulation/Continuity Specifications

7.18.1 Insulation Resistance Accuracy and Resolution (Super I)

Resistance Output	Accuracy ± % of Output 1Year — Tcal ±5°C [1]	Absolute Resolution	Source Current Limits
100.0 kΩ to 299.9 kΩ	0.1%	100 Ω	200µA to 10mA
300.0 kΩ to 2.999 MΩ	0.1%	1 kΩ	90µA to 4mA
3.000 MΩ to 29.99 MΩ	0.3%	10 kΩ	9µA to 400µA
30.00 MΩ to 299.9 MΩ	0.5%	100 kΩ	900nA to 40µA
300.0 MΩ to 2.000 GΩ	0.7%	1 MΩ	90nA to 4µA

7.18.2 Other Insulation Resistance Specifications

Maximum Measurement Voltage:	1350VDC: 1 x R < 1350V
Voltage Measurement:	Range: 0V to 1350V Accuracy: ±(0.6% of Output + 1V)
Current Measurement:	Range: 1µA to 2.3mA Accuracy: ±1.5%

Final Width = 215mm

7.18 Insulation/Continuity Specifications (Contd.)

7.18.3 Continuity Resistance Accuracy and Resolution (4-wire connection)

Resistance Output	Accuracy ±(% of Output + Floor) 1Year — Tcal ±5°C [1]	Absolute Resolution
00.0000 Ω to 40.0000 Ω	0.1 + 50mΩ	0.1mΩ
040.001 Ω to 400.000 Ω	0.035 + 100mΩ	1mΩ
0.40001 kΩ to 4.00000 kΩ	0.035 + 200mΩ	10mΩ

7.18.4 Continuity Resistance Source Current — Limits

Hardware Configuration Limits on Span of Output Resistance	Source Current Limits
00.0000 Ω to 40.0000 Ω	25mA to 350mA
040.001 Ω to 400.000 Ω	5mA to 70mA
0.40001 kΩ to 4.00000 kΩ	500µA to 7mA

7.18.5 Other Continuity Resistance Specifications

Maximum Measurement Voltage:	10V
Current Measurement:	Range: 100µA to 350mA Accuracy: ±1%

Final Width = 215mm

7.19 Power Specifications

The following specifications refer to the Voltage and Current outputs available from the Auxiliary channel — i.e. the I+ and I- outputs of the Model 9100 when the Power function is active. They should not be confused with the normal Voltage and Current output specifications.

Where no parameter or caveat is stated, the specification is as 9100.

7.19.1 Auxiliary DC Voltage Accuracy

Output Voltage +ve or -ve	Accuracy ± (% Output + Floor)	Compliance Current mA (O/P Impedance)
00.00mV to 32.00mV	0.012% + 3µV	10 Ω
32.00mV to 320.0mV	0.006% + 5µV	<20mA
0.320V to 3.200V	0.006% + 41.6µV	<20mA
3.200V to 7.500V	0.030% + 90µV	<20mA

7.19.2 Auxiliary DC Voltage (Representing DC Current Output) Accuracy

Output Current	Accuracy ± (% Output + Floor)	Compliance Current mA
0.00 to 32.00A @ ≥1mV/Amp	0.012% + 0.003A	10 Ω
32.0 to 320.0A @ ≥1mV/Amp	0.006% + 0.005A	<20mA
320.0A to 3.2kA @ ≥1mV/Amp	0.006% + 0.042A	<20mA
0 to 160A @ 0.2mV to 1mV/Amp	0.006% + 0.021A	<20mA
160.1A to 3.2kA @ 0.2mV to 1mV/Amp	0.006% + 0.21A	<20mA
>3.2kA	0.03% + 0.42A	<20mA

Final Width = 215mm

NOTES: Improved specs are available at intermediate points depending on scaling factor.
Auxiliary DC Voltage is primarily a simulation of the output of a resistive shunt, and for Power is therefore expressed as being equivalent to Amps.

7.19.3 Auxiliary AC Voltage Accuracy (Sinusoidal Waveshape)

Output Voltage	Frequency Band	Accuracy ± (% Output + Floor)	Compliance Current mA (O/P Impedance)
0.32mV to 3.20mV	10 - 3K	0.12% + 10µV	10 Ω
3.21 to 32.00mV	10 - 3K	0.12% + 10µV	10 Ω
32.0mV to 320.0mV	10 - 3K	0.04% + 19.2µV	<20mA
0.320V to 3.200V	10 - 3K	0.04% + 192µV	<20mA
3.200V to 7.500V	10 - 3K	0.06% + 400µV	<7mA @ 7V

NOTES: Also directly available as a voltage harmonic output. When used as a harmonic with n>1, add 0.04% to percentage of output specifications.
The lowest AC range functions down to zero, but the floor spec is doubled below 0.32 mV.

7.19.4 Auxiliary AC Voltage (Representing AC Current Output) Accuracy

Output Current	Frequency Band	Accuracy ± (% Output + Floor)	Compliance Current mA (O/P Impedance)
0.32A to 3.20A	10 - 3K	0.12% + 0.01A	10 Ω
3.21A to 32.00A	10 - 3K	0.12% + 0.01A	10 Ω
32.1 to 320.0A @ ≥1mV/Amp	10 - 3K	0.04% + 0.02A	<20mA
321A to 3.2KA @ ≥1mV/Amp	10 - 3K	0.04% + 0.2A	<20mA
0 to 160.0A @ 0.2mV to 1mV/Amp	10 - 3K	0.04% + 0.1A	<20mA
160A to 3.2kA @ 0.2mV to 1mV/Amp	10 - 3K	0.04% + 1A	<20mA
>3.2kA	10 - 3K	0.06% + 2A	<7mA @ 7V

NOTES: Improved specs are available at intermediate points depending on scaling factor.
 Auxiliary AC voltage is available as a simulation of the output of a resistive shunt, and can therefore be expressed as being equivalent to Amps.
 Also directly available as a voltage harmonic output. When used as a harmonic with n>1, add 0.04% to percentage of output specifications.

7.19.5 Other Voltage Waveshapes

All subject to 65Hz/1kHz maximum as defined in main Model 9100 specification tables.
 Note that all waveshapes are specified to 4.525 pk only (4 ranges; equivalent to the 3.2V sinewave range peak).
 Functionality above this limit is available but unspecified.

The 4.525 mV pk range is allowed to function down to zero.
 Specifications as main 9100 ranges.

Final Width = 215mm

7.19.6 DC Current Accuracy

Output Current	Accuracy ± (% Output + Floor)
0 to 320.0mA	0.016 + 9.6µA
0.320A to 3.200A	0.06 + 118µA
3.20A to 10.50A	0.055 + 940µA
10.50A to 20.00A	0.055 + 4.5mA
3.200 to 32.00A, 10t coil	0.26 + 1.18mA
32.00 to 200.0A, 10t coil	0.255 + 45mA
16.00 to 160.0A, 50t coil	0.26 + 5.9mA
160.0 to 1000A, 50t coil	0.255 + 225mA

7.19.7 AC Current Accuracy (sine)

Output Current	Frequency Band	Accuracy ± (% Output + Floor)
0 to 320.0mA	10 - 1k	0.08 + 32µA
0.320 to 3.200A	10 - 1k	0.08 + 480µA
3.200 to 10.500A	10 - 100	0.11 + 3mA
	100 - 1k	0.15 + 3mA
10.50 to 20.00A	10 - 100	0.11 + 6.9mA
	100 - 1k	0.15 + 6.9mA
3.20 to 32.00A, 10t coil	10 - 100	0.40 + 9.7mA
	100 - 440	0.98 + 27mA
32.0 to 200.0A, 10t coil	10 - 100	0.40 + 90mA
	100 - 440	0.87 + 250mA
16.0 to 160.0A, 50t coil	10 - 100	0.42 + 48mA
160.1 to 1000A, 50t coil	10 - 100	0.42 + 450mA

Note that above specs are subject to maximums as specified in the Amp.Hz profile.

Performance above 1kHz not specified to user; nominally Gain is as 9100 and Floors as above.

All other specifications as 9100 **except** that the 0.2% adder for the Option 200 coils has been **included** in the table above.

Also directly available as a voltage harmonic output. When used as a harmonic with $n > 1$, add 0.04% to percentage of output specifications.

7.19.8 Other Current Waveshapes

All subject to maximum frequencies as per the main 9100 specification tables.

Ranges available start at the 45.25mA to 452.5mA pk range.

This is allowed to function down to zero.

Performance as in main 9100 specifications.

Final Width = 215mm

7.19.9 Phase Accuracy (Sinusoidal Waveshape)

Voltage Output	Frequency Band (Hz)	Output Phase Uncertainty (degrees)
0.30000V to 105.000V	10 - 65	0.07°
105.001V to 750.000V ^[1]	65 - 1k	0.07 + 0.001 x (f - 65)°
	45 - 65	0.16°
	65 - 1k	0.16 + 0.0037 x (f - 65)°

Current Output	Frequency Band (Hz)	Output Phase Uncertainty (degrees) ^[2]
0.00000A to 20.0000A	10 - 65	0.08°
03.2000A to 1000.00A ^[3]	65 - 1k	0.08 + 0.0008 x (f - 65)°
	>1k	0.08 + 0.0012 x (f - 65)°
	10 - 65	0.23°
	65 - 440	0.23 + 0.003 x (f - 65)°

Auxiliary Channel Voltage Output	Frequency Band (Hz)	Output Phase Uncertainty (degrees) ^[2]
0.32mV to 7.500A	10 - 65	0.07°
	65 - 1k	0.07 + 0.001 x (f - 65)°
	>1k	0.07 + 0.0015 x (f - 65)°

NOTES: [1] Maximum load current: 2mA. Maximum load capacitance: 200pF

[2] To obtain the Output Phase Uncertainty with respect to PHASE LOCK OUT or PHASE LOCK IN when operating in POWER mode, add 0.07°.

[3] With the 10-turn or 50-turn coil output selected (Option 200).

Final Width = 215mm

7.19.10 Calculating Power Uncertainty

The Power Uncertainty is based on the root sum square (rss) of the following three uncertainties (expressed in %):

1. Voltage (Main) Channel Amplitude Uncertainty
2. Current (Auxiliary) Channel Amplitude Uncertainty
3. Amplitude Uncertainty due to Phase Error

$$\text{Power Uncertainty} = \sqrt{U_{\text{Voltage}}^2 + U_{\text{Current}}^2 + U_{\text{Phase}}^2}$$

The following examples demonstrate how to calculate the power uncertainty at a specific calibration point. (Note: All specifications used are 1 year specifications).

Example 1:

Calibrator Output 100V, 3A (at 60Hz) Power Factor 1.0 ($\emptyset = 0^\circ$).

Final Width = 215mm

1. Voltage Amplitude Uncertainty (From Section 7.4.1)

$$\begin{aligned} 100V \text{ Specification : } &= 0.04\% \text{Rdg} &+& 6.3\text{mV(Floor)} \\ &= 0.04\% &+& (6.3\text{mV}/100\text{V}) \times 100 \\ &= 0.04\% &+& 0.0063\% \\ &= 0.0463\% \end{aligned}$$

2. Current Amplitude Uncertainty (From Section 7.19.7)

$$\begin{aligned} 3A \text{ Specification : } &= 0.08\% \text{Rdg} &+& 480\mu\text{A(Floor)} \\ &= 0.08\% &+& (480\mu\text{A}/3\text{A}) \times 100 \\ &= 0.08\% &+& 0.016\% \\ &= 0.096\% \end{aligned}$$

3. Amplitude Uncertainty due to Phase Error (From Section 7.19.9)

Specifications:	Voltage Channel Phase Uncertainty	0.07°
	Current Channel Phase Uncertainty	0.08°

Combined Phase Uncertainty		
\emptyset_{ERROR}	= 0.07°	+ 0.08°
	= 0.15°	

The equation yielding the actual amplitude uses the term $\text{Cos}(\theta + \theta_{\text{ERROR}})$. The equation yielding the error free amplitude uses the term $\text{Cos}(\theta)$. These have to be combined to yield a percentage error.

$$\begin{aligned}
 \text{Amplitude uncertainty} &= 100 \times \left[1 - \frac{\text{Cos}(\theta + \theta_{\text{ERROR}})}{\text{Cos} \theta} \right] \\
 &= 100 \times \left[1 - \frac{\text{Cos}(0 + 0.15)}{\text{Cos} 0} \right] \\
 &= 100 \times \left[1 - \frac{0.999996573}{1} \right] \\
 &= 0.0003427\%
 \end{aligned}$$

The Total Power Uncertainty is therefore the rss of the individual contributions :

$$\begin{aligned}
 \text{Final Width} = 215\text{mm} &= \sqrt{(0.0463)^2 + (0.096)^2 + (0.0003427)^2} \\
 &= 0.107\%
 \end{aligned}$$

Example 2:

Calibrator Output 100V, 3A (at 400Hz) Power Factor 0.5 ($\theta = 60^\circ$).

1. Voltage Amplitude Uncertainty (From Section 7.4.1)

$$\begin{aligned}
 100\text{V Specification :} &= 0.04\% \text{Rdg} + 6.3\text{mV(Floor)} \\
 &= 0.04\% + (6.3\text{mV}/100\text{V}) \times 100 \\
 &= 0.04\% + 0.0063\% \\
 &= 0.0463\%
 \end{aligned}$$

2. Current Amplitude Uncertainty (From Section 7.19.7)

$$\begin{aligned}
 3\text{A Specification :} &= 0.08\% \text{Rdg} + 480\mu\text{A(Floor)} \\
 &= 0.08\% + (480\mu\text{A}/3\text{A}) \times 100 \\
 &= 0.08\% + 0.016\% \\
 &= 0.096\%
 \end{aligned}$$

3. Amplitude Uncertainty due to Phase Uncertainty (From Section 7.19.9)

Specifications: Voltage Phase Uncertainty = $0.07^\circ + 0.001 \times (400-65)^\circ$
 = 0.405°

Current Phase Uncertainty = $0.08^\circ + 0.0008 \times (400-65)^\circ$
 = 0.348°

Combined Phase Uncertainty
 $\phi_{\text{ERROR}} = 0.405^\circ + 0.348^\circ$
 = 0.753°

Again, the equation yielding the actual amplitude uses the term $\text{Cos}(\phi + \phi_{\text{ERROR}})$. These have to be combined to yield a percentage error.

Amplitude uncertainty = $100 \times \left[1 - \frac{\text{Cos}(\phi + \phi_{\text{ERROR}})}{\text{Cos } \phi} \right]$
 = $100 \times \left[1 - \frac{\text{Cos}(60 + 0.753)}{\text{Cos } 60} \right]$
 = $100 \times \left[1 - \frac{0.488575}{0.5} \right]$
 = 2.285%

Final Width = 215mm

The Total Power Uncertainty is therefore the rss of the individual contributions :

= $\sqrt{(0.0463)^2 + (0.096)^2 + (2.285)^2}$
 = 2.287%

It is clear that at lower power factors the contribution from the Phase Uncertainty dominates. This demonstrates why most calibrations are performed at Unity Power Factor (0° phase difference between channels). The following table illustrates the amplitude uncertainties introduced due to a phase difference. The user can optimise the total power uncertainty by calibrating at higher power factors.

Corresponding Power Factor	Channel Phase Difference	Amplitude Uncertainty due to Phase*	
		Voltage <105V Current <20A	Voltage >105V Current <20A
1	0°	0.0003%	0.0009%
0.95	18.19°	0.0864%	0.1385%
0.90	25.84°	0.1271%	0.2037%
0.86	30.00°	0.1515%	0.2427%
0.80	36.87°	0.1967%	0.3150%
0.70	45.57°	0.2674%	0.4282%
0.60	53.13°	0.3494%	0.5594%
0.50	60.00°	0.4538%	0.7264%
0.25	75.52°	1.0141%	1.6229%

Final Width = 215mm

* For Calibrator output <65Hz

Final Width = 215mm

Section 8 Model 9100 — Routine Maintenance and Test

8.1 About Section 8

Section 8 gives first-level procedures for maintaining a Model 9100, performing the Selftest operations and dealing with their results. We shall recommend maintenance intervals, methods and parts, and detail the routine maintenance procedures. Section 8 is divided into the following sub-sections:

- 8.2 Routine Maintenance and Repair.
 - 8.2.1 General Cleaning
 - 8.2.2 Air Intake Filter — Description and Maintenance Intervals
 - 8.2.2.1 Removing the Instrument Top Cover
 - 8.2.2.2 Calibration Seal — **Caution!**
 - 8.2.2.3 Removing the Filter Element
 - 8.2.2.4 Cleaning the Filter Element
 - 8.2.2.5 Refitting the Filter Element
 - 8.2.2.6 Refitting the Top Cover
 - 8.2.2.7 Replacement Parts
 - 8.2.3 Firmware Upgrade — Procedure
 - 8.2.3.1 Introduction
 - 8.2.3.2 Procedure
 - 8.2.4 Fuse Replacement — Procedure
 - 8.2.4.1 Introduction
 - 8.2.4.2 Replacement Fuses
 - 8.2.4.3 Diagnosing Blown Output Fuses
 - 8.2.4.4 Replacing Hi and Lo Terminal Fuses
 - 8.2.4.5 Replacing I+ and I- Terminal Fuses
- 8.3 Model 9100 Test and Selftest
 - 8.3.1 Types of Test
 - 8.3.1.1 Entry to Test Mode.
 - 8.3.2 Fast/Full Selftest
 - 8.3.2.1 Aborting the Selftest.
 - 8.3.2.2 Selftest Runs to Completion.
 - 8.3.2.3 Viewing the Test Results.
 - 8.3.2.4 Printing the Test Results.
 - 8.3.3 Selftest at Power-on.
 - 8.3.4 Interface Test.
 - 8.3.4.1 Access to Interface Tests.
 - 8.3.4.2 Display Memory Checks.
 - 8.3.4.3 Keyboard Checks.
 - 8.3.4.4 Display Checks.
 - 8.3.4.5 Memory Card Checks.
 - 8.3.4.6 Tracker Ball Checks.
 - 8.3.4.7 Printer Checks.
- 8.4 Printing Selftest Results.
 - 8.4.1 Parallel Port J103.
 - 8.4.2 Printing Setup.
 - 8.4.2.1 Printer Type.
 - 8.4.2.2 Data Formatting.
 - 8.4.3 Results Printout.

Appendix A: Error Reporting Subsystem.

Final Width = 215mm

8.2 Routine Maintenance

8.2.1 General Cleaning

The instrument surfaces should be kept clean, as the front panel controls are likely to be in continuous use within a working environment. Clean when required.

Remove dust from the top cover using a soft brush (do not use a cloth unless it is lint-free). Keep the controls clean using a soft, lint-free cloth, dampened with a non-toxic, non-corrosive detergent. The display screen should be cleaned using a soft, lint-free cloth, dampened with an anti-static cleanser; avoid extreme pressure on the face of the screen and do not spray the screen directly.

8.2.2 Air Intake Filter

N.B. Do not remove any covers without first disconnecting the line power lead.

The internal airflow is powered by an axial fan which blows cooling air through a heatsink to be exhausted on the left side via a cover grille. Replacement air is drawn into the instrument through holes in the right side of the top cover, then through a 20ppi (pores per inch) reticulated filter. This filter is accessed by removing the top cover.

Once the cover is removed, an expanded metal grille can be seen, welded to the right side of the chassis assembly, covering two rectangular apertures into the main and rear cavities. The reticulated filter is located over this grille and attached through it to the chassis assembly, by five black nylon snap rivets.

The filter should not be allowed to become clogged with dust and dirt, as this will restrict the designed airflow through the instrument. Dust can be removed using a small vacuum cleaner to create a reverse airflow, but this will not clean off grease and other dirt which will accumulate over time.

It is recommended that the filter element should be inspected and cleaned by vacuuming at intervals of no more than 90 days, and should be removed for cleaning at least once per year, immediately prior to routine calibration of the unit.

8.2.2.1 Removing the Top Cover

The side edges of the top cover are located in slots in both side extrusions, and secured to the rear panel by two screws. A solid plastic block protects each of the rear corners.

To access the filter element, remove the top cover as follows:

1. Release the four screws securing the two rear-corner blocks and remove the blocks.
2. Release the two screws securing the top cover to the rear panel.
3. Pull the top cover to the rear to clear the front bezel, then lift off to the rear.

Final Width = 215mm

8.2.2.2 Calibration Seal

Caution!

With the cover removed, a 'Calibration seal' can be seen covering a countersunk screwhead on the left side of the chassis assembly, at the top. This is one of the securing screws for the top guard shield. The seal is set in position following a calibration of the instrument, so that removal of the guard shield can be detected.

The calibration seal must **NOT** be broken unless the guard shield is to be removed for **Authorized** work inside the chassis assembly. **Removal of the guard shield will compromise the traceable calibration of the instrument, and a full recalibration of the 9100 will be required.**

8.2.2.3 Removing the Filter Element

The filter is removed as follows:

Carefully lever out the center pin of each of the five black nylon snap rivets and pull out the snap latches. Lift off the filter element.

8.2.2.4 Cleaning the Filter Element

Once the filter is removed, wash it in warm water and household detergent, rinse thoroughly and allow to dry.

8.2.2.5 Refitting the Filter Element

1. Hold the filter element in position over the expanded metal grille so that it overlaps both main and rear apertures, and the five securing holes. Separate the latch and center pin of a black nylon snap rivet, and push the latch through the filter into the center securing hole in the top row. Fit the center pin into the latch and push fully home, so that the pin opens the splits in the rear of the latch.
2. *Slightly* stretch the filter element into the correct position; fit and secure the other four snap rivets.

8.2.2.6 Refitting the Top Cover

Carefully refit the top cover into the slots in the side extrusions, with the front edge immediately behind the front bezel; push forward to locate inside the bezel, and secure to the rear panel using the two screws. Refit and secure the corner blocks.

8.2.2.7 Replacement Parts

Should the filter or snap rivets become damaged by removal or refitting, the following parts can be ordered through your Wavetek Sales and Service Center:

Part No.	Description	Manufacturer	Type	Quantity
451004	20ppi Reticulated Foam Filter	-----	-----	1
617020	Snap Rivet, Black Nylon	Richco.	SR4050B	5

Final Width = 215mm

8.2.3 Firmware Upgrade

8.2.3.1 Introduction

The Model 9100 firmware can be upgraded using a 'Personal Computer Memory Card Interface Adaptor' (PCMCIA). To do this, the Model 9100 has been fitted with FLASH memory chips to provide the update capability.

If an upgrade is required for your Model 9100 unit(s), your Service Center will inform you and provide the appropriate PCMCIA card.

This Sub-Section describes the routine procedure for upgrading the firmware. Note that the Full Self Test appears *twice* in the procedure: before and after carrying out the upgrade. This is included on two occasions to determine whether any difficulties were present before the upgrade, or whether they have arisen as a result of the upgrade.

8.2.3.2 Procedure

1. Full Self Test (Refer to paras 8.3.1 & 8.3.2):

Execute a Full Self Test and record any errors. If printing facilities are available, select the **PRINT** option to obtain a hard copy of the results.

2. Prepare the 9100:

- Switch 9100 Power **OFF**.
- Locate the **FACTORY SET** switches on the 9100 rear panel:

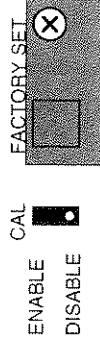

- Remove the switch cover by releasing its retaining screw.

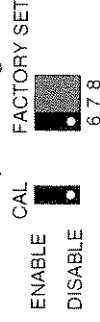

- Set **Switch 6** to the **ENABLE** position (up) Do not disturb any of the other switches.

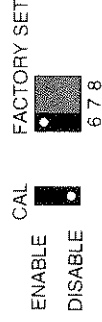

3. Insert the PCMCIA Card:

- Locate the '**PROCEDURE MEMORY CARD**' slot in the 9100 front panel.
- Insert the PCMCIA card into the '**PROCEDURE MEMORY CARD**' slot, exerting just enough pressure to push out the black button by the side of the slot.

4. Re-Program the Firmware:

- a. Switch 9100 Power ON.
- b. Observe the following growth pattern on the 9100 LCD display:



The process takes approximately 1 minute 10 seconds to complete. When complete, a repetitive, pulsed audible tone will be heard.

If for any reason a continuous audible tone is heard, the update has not been successful. Note the current state of the growth pattern on the display, and relay this information back to the Service Center.

5. Recover the Operational State of the 9100:

- a. Switch 9100 Power OFF.
- b. Return Switch 6 to the **DISABLE** position. Do not disturb any of the other switches.
- c. Replace and secure the switch cover.
- d. Remove the PCMCIA card, switch the 9100 Power ON and wait for approximately 1 minute until the Power-On Selftest is complete.
- e. On the right of the 9100 front panel, press the **Mode** key.
- f. At the bottom of the 9100 LCD display, press the soft **CONFIG** key, and check that the firmware issue, shown on the screen, matches that on the PCMCIA card.
- g. Transfer back to the Mode Selection screen by pressing the **Mode** key.

6. Full Self Test (Refer to paras 8.3.1 & 8.3.2):

- a. Execute a Full Self Test and record any errors. If printing facilities are available, select the **PRINT** option to obtain a hard copy of the results (*refer also to paras 8.4*).
- b. Note any differences between the self tests at items 1 and 6.
- c. Report the results of the upgrade procedure back to the Service Center.

The Model 9100 firmware upgrade is now complete. Please return your PCMCIA to the Service Center.

Final Width = 215mm

8.2.4 Output Fuse Replacement

Warning! Fuse replacement should be carried out by a suitable skilled and competent person.

8.2.4.1 Introduction

The Model 9100 outputs are protected by internal fuses.

Access to five fuses is provided:

- The Hi and Lo Terminal lines are protected by two fuses, concealed behind a small cover underneath the instrument.
- The I+ and I- Terminal lines are protected by three fuses which protrude through the top guard shield under the top cover.

The following paragraphs deal with diagnosing blown output fuses, access and procedures for replacement.

8.2.4.2 Replacement Fuses

The following fuses can be ordered through your Wavetek Sales and Service Center:

Function	Part No.	Description	IEC Designation	Manufacturer	Type
Hi Terminal Fuse	920293	500mA 250V TR5 (F)	F0.5AL	Wickmann	19370-500
Lo Terminal Fuse	920293	500mA 250V TR5 (F)	F0.5AL	Wickmann	19370-500
I- Terminal Fuse (Low Currents)	920208	1A 250V 20mm (F)	F1AL	Belling Lee	L1427B/1A
I+ Terminal Fuse (Low Currents)	920294	500mA 250V 20mm (F)	F0.5AL	Schurter	0034.1513
I+ Terminal Fuse (High Currents)	920295	4A 250V 20mm (F)	F4AL	Schurter	0034.1522

Final Width = 215mm

8.2.4.3 Diagnosing Blown Output Fuses

1. Hi and Lo Terminal Fuses

These fuses are placed in the Hi and Lo output lines, between the final output switching relays and the terminals. Suspect that these fuses have blown, if the output from the terminals is grossly incorrect, but the Self Test indicates no fault.

2. I+ and I- Terminal Low Current Fuses

(when operating in AC or DC Current function, except for the 3A and 20A Spans)

These fuses are placed in the output lines for I+ and I-, except when the 3A and 20A Spans are in use. The positions are shown on the top inside cover. If either has blown, the over-compliance error message will be generated.

3. I+ Terminal High Current Fuse

(when operating in AC or DC Current function, working in the 3A Span)

This fuse is placed in the output line for I+, only when the 3A Span is in use. The position is shown on the top inside cover. If it has blown, the over-compliance error message will be generated.

4. In General:

Sometimes a blown fuse can cause a 'Fatal Error' (refer to Appendix A to this Section 8).

The internal fuses are unlikely to be blown as a result of an internal fault. The most likely cause of failure is the inadvertent application of power from an external source.

The 20A Span is driven from a separate heavily-protected output stage, and the output is not fused.

8.2.4.4 Replacing Hi and Lo Terminal Fuses

1. **Access**
 - a. Switch 9100 Power **OFF** and disconnect the line power lead.
 - b. Lift the left side of the 9100 to stand on its right side. Rotate the instrument to give good access to the small panel (Fig. 8.2.1) on the underside:

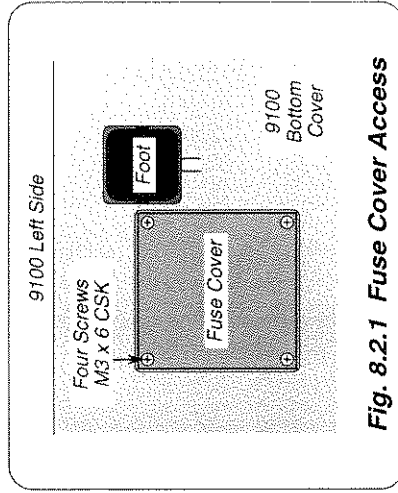

Fig. 8.2.1 Fuse Cover Access

- i. Pull the tilt stand out for better access.
 - ii. Unscrew four M3 x 6 Pozi-Countersunk screws to release the panel.

2. Fuse Removal

- a. Ensure that 9100 Power is still **OFF**.
- b. Locate the two fuse caps (Fig. 8.2.2) in the recess:
 - i. Unscrew the relevant fuse cap(s).
 - ii. Remove the fuse(s) by pulling carefully on the cylindrical fuse body.

3. Fuse Testing

- a. Check each removed fuse for continuity and correct type.
- b. Decide whether the fuse is to be re-fitted or replaced.

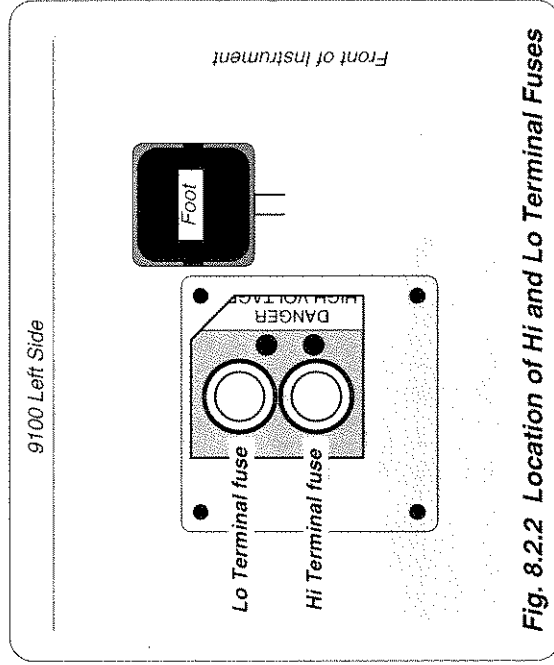

Fig. 8.2.2 Location of Hi and Lo Terminal Fuses

4. Fuse Fitting

WARNING
MAKE SURE THAT ONLY FUSES WITH THE REQUIRED RATED CURRENT AND OF THE SPECIFIED TYPE ARE USED FOR REPLACEMENT.
THE FUSE-HOLDERS ARE NOT TO BE SHORT-CIRCUITED. THIS PRACTICE WILL RENDER THE WARRANTY VOID.

- a. Ensure that 9100 Power is still **OFF**.
- b. Locate the two fuse holders in the recess:
 - i. Fit each fuse by inserting its two pins into the holder holes, then carefully push the fuse body home.
 - ii. Screw on the relevant fuse cap(s).

Final Width = 215mm

8.2.4.5 Replacing I+ and I- Terminal Fuses

1. Access

- a. Switch 9100 Power **OFF** and disconnect the line power lead.
- b. Remove the Top Cover
The side edges of the top cover are located in slots in both side extrusions, and secured to the rear panel by two screws. A solid plastic block protects each of the rear corners.

To access the I+ and I- Terminal Fuses, remove the top cover as follows:

- i. Release the four screws securing the two rear-corner blocks and remove the blocks.
- ii. Release the two screws securing the top cover to the rear panel.
- iii. Pull the top cover to the rear to clear the front bezel, then lift off to the rear.

Final Width = 215mm

- c. Calibration Seal
Caution!

With the cover removed, a 'Calibration seal' can be seen covering a countersunk screwhead on the left side of the chassis assembly, at the top. This is one of the securing screws for the top guard shield. The seal is set in position following a calibration of the instrument, so that removal of the guard shield can be detected.

The calibration seal must **NOT** be broken unless the guard shield is to be removed for **Authorized** work inside the chassis assembly. **Removal of the guard shield will compromise the traceable calibration of the instrument, and a full recalibration of the 9100 will be required.**

- d. Locate the Fuses

The fuses are located at the left front of the top guard shield, beneath the ribbon cable which links to the Interconnection PCB on the rear panel, and protruding through grommets in the guard shield (Fig 8.2.3).

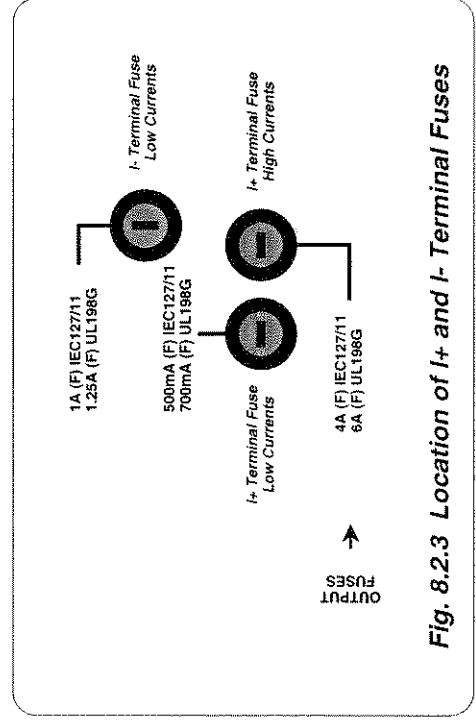

Fig. 8.2.3 Location of I+ and I- Terminal Fuses

2. Disconnect the Ribbon Cable

- a. Ensure that 9100 Power is still OFF.
- b. Locate the ribbon cable connector and latch levers on the Interconnection PCB attached to the rear panel:
 - i. Carefully push both latch levers outwards at the same time. This will ease the connector out of its housing.
 - ii. Release the connector and pull the ribbon cable towards the front of the instrument to reveal the fuse holders beneath.

3. Fuse Removal

- a. Ensure that 9100 Power is still OFF.
- b. Locate the three bayonet fuse caps (Fig. 8.2.3):
 - i. Release the relevant fuse cap(s) by pushing down, turning counter-clockwise.
 - ii. Remove the fuse(s) by pulling carefully.

4. Fuse Testing

- a. Check each removed fuse for continuity and correct type.
- b. Decide whether the fuse is to be re-fitted or replaced.

5. Fuse Fitting

WARNING

MAKE SURE THAT ONLY FUSES WITH THE REQUIRED RATED CURRENT AND OF THE SPECIFIED TYPE ARE USED FOR REPLACEMENT.

THE FUSE-HOLDERS ARE NOT TO BE SHORT-CIRCUITED. THIS PRACTICE WILL RENDER THE WARRANTY VOID.

- a. Ensure that 9100 Power is still OFF.
- b. Locate the three bayonet fuse holders (Fig. 8.2.3):
 - i. Fit each correct fuse by inserting it into the holder, and carefully push the fuse home.
 - ii. Secure the relevant fuse cap(s) by pushing down and turning clockwise.

6. Reconnect the Ribbon Cable

- a. Ensure that 9100 Power is still OFF.
- b. Locate the ribbon cable connector across the top of the instrument, and into its housing on the Interconnection PCB attached to the rear panel:
 - i. Carefully push the connector into its housing. This will cause the latch levers to move together and latch as the connector is driven fully home.
 - ii. Finally, push the latch levers together to ensure that both latches are fully home, with the connector correctly housed.

7. Refitting the Top Cover

Carefully refit the top cover into the slots in the side extrusions, with the front edge immediately behind the front bezel; push forward to locate inside the bezel, and secure to the rear panel using the two screws. Refit and secure the corner blocks.

Final Width = 215mm

8.3 Model 9100 Test and Selftest

8.3.1 Types of Test

There are two main types of selftest, 'Fast' and 'Full'. The Fast selftest is also performed automatically at power-on. In addition, the interface for front panel operation can be selectively tested, covering such areas as display memory integrity, keyboard operation, the display itself, integrity and formatting of static RAM memory cards for Procedure mode, the correct operation of a connected tracker-ball, and the correct operation of a connected printer. These tests are detailed in the following paragraphs:

8.3.1.1 Entry to Test Mode

Test mode is selected from the Mode Selection menu, which is displayed by pressing the front panel 'Mode' key, highlighted in Fig 8.3.1, below:

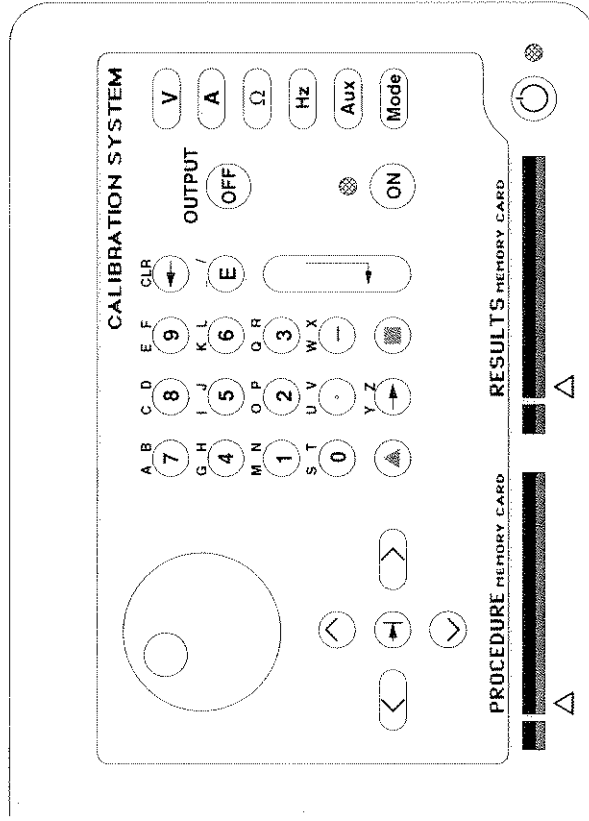
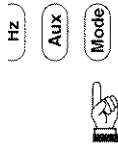

Fig. 8.3.1 'Mode' Key

8.3.1.1 Entry to Test Mode (Contd.)

The Mode key sets up a special menu display, offering selection from five primary modes. This menu can be exited **only** by pressing one of the five screen keys.



Mode Selection Select required mode using softkeys.						
TODAY'S DATE	TIME	PROC	MANUAL	CONFIG	CALIB	TEST

TEST

This key enters Test mode, displaying the following screen:

Selftest Select required test using softkeys.				
TODAY'S DATE	TIME	FAST	FULL	INTER- FACE

FAST runs a FAST selftest.

FULL runs a FULL selftest.

INTERFACE allows checks of the display and display memory, the front panel keyboard, the (Procedure mode) memory card slots, the tracker ball and printer interfaces.

Final Width = 215mm

Continued Overleaf

8.3.2 Fast/Full Selftest

Both Fast and Full selftests follow the same format. By pressing the **FAST** or **FULL** screen key on the 'Select required test' menu screen, the 9100 runs the selected selftest. The first screen shows the pathway under test and the number of tests remaining, for the selected selftest:

Selftest	
Running FAST test. Testing pathway no. XXX.XXX Tests remaining: XX	
TODAY'S DATE	TIME
ABORT	

Selftest.	
Running FULL test. Testing pathway no. XXX.XXX Tests remaining: XX	
TODAY'S DATE	TIME
ABORT	

8.3.2.1 Aborting the Selftest

ABORT stops the selftest and displays the appropriate 'ABORTED' screen:

Selftest.	
Test ABORTED with no failures.	
TODAY'S DATE	TIME
EXIT	PRINT

Selftest.	
Test ABORTED with failures. Number of failures: XX Use the softkeys to view the results.	
TODAY'S DATE	TIME
EXIT	PRINT
VIEW FAILS	

If there were no failures up to the point of aborting, this is shown on the screen.

EXIT returns to the 'Select selftest' menu screen.

PRINT prints out the results of the test, up to the point of aborting.
Refer to *Sub-section 8.4.*

If failures were encountered up to the point of aborting, **EXIT** and **PRINT** are available. Also, the number of failures is shown on the screen, and an extra selection will be available:

VIEW FAILS sets up a special screen for detailing the parameters of the failures encountered (*described later in Paras 8.3.2.3*).

Final Width = 215mm

8.3.2.2 Selftest Runs to Completion

If the selftest is not aborted, it will run to completion, and if the test is successful with no failures, the following screen will appear for either Fast and Full test:

Selftest.		
Test completed with no failures.		
EDDAYS DATE	TIME	
EXIT	PRINT	

If failures were encountered during the test, the 9100 will display the following screen:

Selftest.		
Selected test has FAILED. Number of failures: XX		
Use the softkeys to view the results.		
EDDAYS DATE	TIME	VIEW FAILS
EXIT	PRINT	

Final Width = 215mm

EXIT returns to the 'Select selftest' menu screen.

PRINT prints out the results of the test, whether Full or Fast.
Refer to *Sub-section 8.4.*

If failures were encountered, **EXIT** and **PRINT** remain available. Also, the number of failures is shown on the screen, and an extra selection will be available:

VIEW FAILS sets up a special screen for detailing the parameters of the failures encountered (*described later in Paras 8.3.2.3*).

Continued Overleaf

8.3.2.3 Viewing the Test Results

By pressing the **VIEW FAILS** screen key, each of the failed tests can be viewed in turn, on a screen which shows the test number (pathway), averaged measured value, upper and lower limits, and the values of the two measurements which were used to derive the 'Measured value'. A brief description of the test is also given.

The screen for viewing the test results is shown below. This can also be used when a test has been aborted.

Selftest.			
Test no. XXX:XXX FAIL.			
Measured value: XXXXXXXX			
Upper Limit: XXXXXXXX			
Lower Limit: XXXXXXXX			
Measurement A: XXXXXXXX			
Measurement B: XXXXXXXX			
(Description of test)			
TIME			
STATUS:DATE	EXIT	PRINT	NEXT FAILURE

Final Width = 215mm

N.B. If the cause of failure is not immediately obvious, and it is intended to consult your Wavetek Service Center, please ensure that you *either*: copy the details from the screen for all the reported failures, *or*: print out the results. No second viewing of the same failure is allowed, although all the test results remain available for printing.

NEXT FAILURE

Once the details of the first failure have been noted, the next failure in the list can be viewed by pressing the **NEXT FAILURE** screen key. Only one pass through the list of failures is allowed. Once the last failure in the list is on the screen, and the **NEXT FAILURE** screen key is pressed, the following error message will appear in the top right of the screen:

No more failures to view

Pressing the **NEXT FAILURE** screen key will have no further effect. The user must either exit back to the 'Select selftest' screen, or print out the results.

8.3.2.4 Printing the Test Results

The **PRINT** screen key is present on all screens after the test has run to completion or has been aborted. Pressing the **PRINT** key will print out all the available results.

Printing will only be possible if a suitable printer is set up, connected and on line. Refer to *Sub-section 8.4*.

8.3.3 Selftest at Power-On

N.B. Certain catastrophic 'Fatal System Errors' may cause the display to flash on and off, at the point of setting power on. In this case, **immediately switch Power Off** and report the fault to your Service Center.

The first normal action at power on is to show the Wavetek logo, and then the 9100 will run a fast selftest. The user is requested to wait until the selftest is finished:

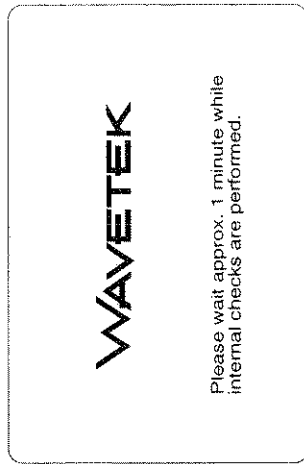

If no failures are found, the 9100 will revert to the default power-up mode, which is either Manual mode or Procedure mode.

If failures are encountered (including other 'Fatal System Errors' — refer to Appendix A to this Section 8), the 9100 will lapse into Test mode at the following stage:

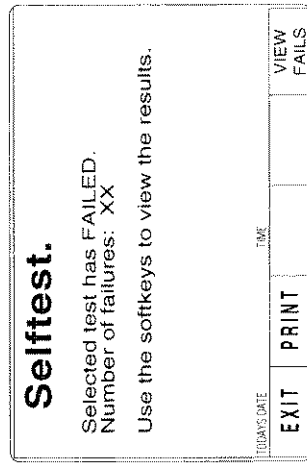

Subsequent action to view the failures and print the results follows as for a Fast selftest which has run to completion (refer to paras 8.3.2.2/3).

EXIT will return to the 'Select selftest' menu screen, where, to return to the 'Mode Selection' menu screen, merely press the front panel **Mode** key.

PRINT can be used to print out the results of the power-on Fast test. Refer also to Sub-section 8.4.

Final Width = 215mm

8.3.4 Interface Test

The interface test selectively checks the 9100 front panel operations, covering display memory integrity, keyboard operation, the display itself, integrity and formatting of static RAM memory cards for Procedure mode, the correct operation of a connected tracker-ball, and the correct operation of a connected printer.

8.3.4.1 Access to Interface Tests

Once the Test mode has been selected, Interface Test can be selected by pressing the **INTERFACE** screen key in the 'Select required test' menu:

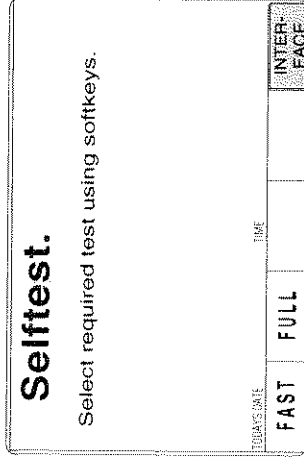

Pressing **INTERFACE** transfers to the 'Select test' menu screen:

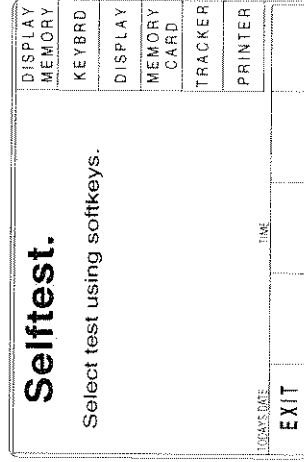

The required check can be selected from the list on the right of the screen, using the corresponding screen key.

EXIT returns to the previous 'Select required test' menu screen.

The six available checks are detailed, in list order, in the following paragraphs.

Final Width = 215mm

8.3.4.2 Display Memory Checks

Pressing the DISPLAY MEMORY key on the 'Select test' menu screen transfers to the 'Memory test' screen, and the sequence of tests begins. The test in progress is reported on the screen:

Selftest.	
Select test using softkeys	
DISPLAY MEMORY	TIME
KEYBRD	
DISPLAY	
MEMORY CARD	
TRACKER	
PRINTER	
TODAY'S DATE	
EXIT	

Memory test.	
Performing READ/WRITE test 1.	
TODAY'S DATE	TIME
EXIT	

The other tests reported are:

- Performing WALKING ONES test 1.
- Performing READ/WRITE test 2.
- Performing WALKING ONES test 2.

The result of the whole Memory test is reported once testing is complete:

Memory test.	
Display memory PASSED.	
TODAY'S DATE	TIME
EXIT	

Memory test.	
Display memory FAILED.	
TODAY'S DATE	TIME
EXIT	

If a failure is reported, rectification will require access to the internal circuitry, so no further user action is recommended, except to report the result to your Wavetek Service Center.

EXIT returns to the Interface 'Select test' menu screen.

Final Width = 215mm

8.3.4.3 Keyboard Checks

Keyboard checks are initiated by pressing the KEYBOARD key on the 'Select test' menu screen:

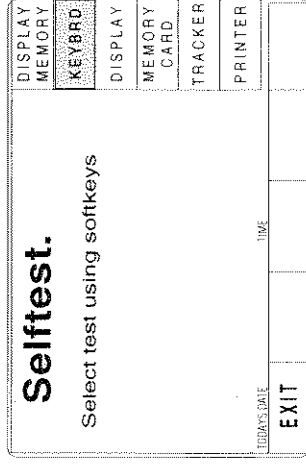

Selecting 'KEYBRD' transfers to the 'Keyboard test' screen. This invites a user to press the front panel key to be tested, and reports on the screen the details of the last key to be pressed:

Final Width = 215mm

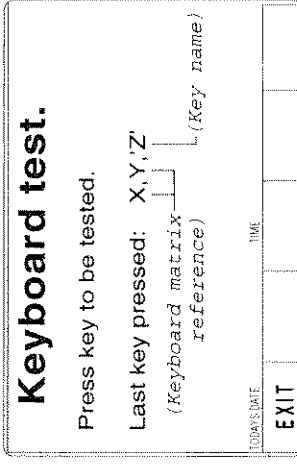

The 'Keyboard matrix reference' (X,Y) relates to the electronic matrix which is used to transfer keypress information to the internal processor, and does not relate closely to the physical layout of keys. The 'Key name' (Z) is the name, in words, which describes the last key to be pressed.

If the reported key name does not coincide with the function of the last key to be physically pressed, a failure is implied. Rectification will require access to the internal circuitry, so no further user action is recommended, except to report the result to your Wavetek Service Center.

EXIT returns to the Interface 'Select test' menu screen.

8.3.4.4 Display Checks

Display checks are initiated by pressing the DISPLAY key on the 'Select test' menu screen:

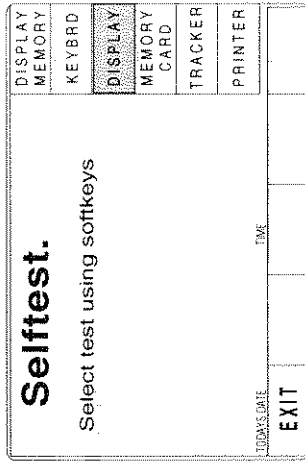

Selecting 'DISPLAY' transfers to the 'Display test.' screen. This invites a user to use the front panel 'tab' (⇧) key to move the dark band down the screen, up to the top, and down again, thus testing all the display elements on the screen:

Final Width = 215mm

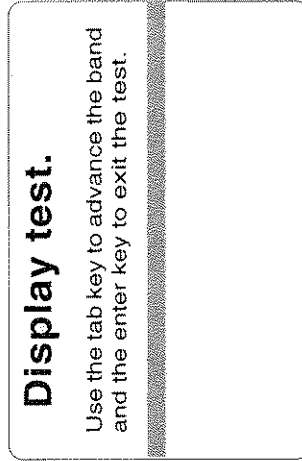

The screen text will shift automatically so as not to obscure the band as it jumps back to the top of the screen. If there are elements of the screen which do not show light in the light background or dark in the dark band as it is advanced down the screen, then this implies a failure. Rectification will require access to the internal circuitry, so no further user action is recommended, except to report the result to your Wavetek Service Center.

The 'Enter' Key (↵) returns to the Interface 'Select test' menu screen.

8.3.4.5 Memory Card Checks

Memory Card checks are initiated by pressing the MEMORY CARD key on the 'Select test' menu screen:

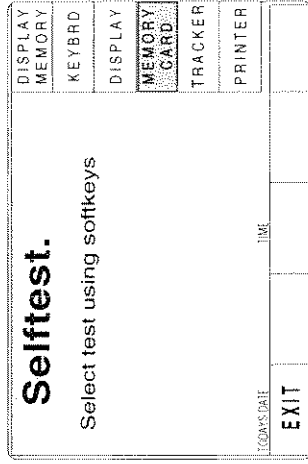

Pressing the MEMORY CARD key on the 'Select test' menu screen transfers to the 'Card slot test.' screen. This invites a user to select the memory card slot to be tested, and presents an 'Overwrite' warning:

Final Width = 215mm

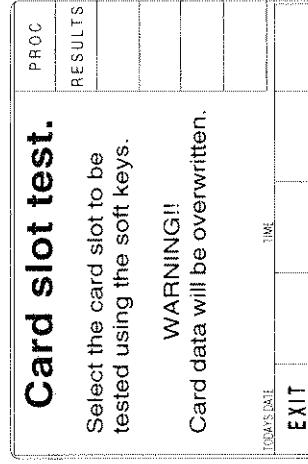

PROC selects the PROCEDURE slot for testing.

RESULTS selects the RESULTS slot for testing.

EXIT returns to the Interface 'Select test' menu screen.

Either slot can be used for the test. If one particular slot is suspect then that, naturally, will be the one to choose.

The warning gives notice that the inserted memory card will be overwritten by this test. This is because reformatting is required to perform the checks and the card inserted into the slot will be reformatted as a Results card.

It is not possible to format a Procedure card using this test, as procedures are written onto cards by a different process (Wavetek Model 9010).

The 9100 first checks for the presence of the correct SRAM card. If there is no card in the slot, if the card in the slot is not a SRAM card, or if it is a SRAM card but not write-enabled, then the following screen is displayed:

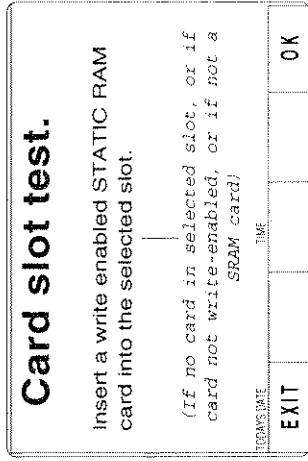

After correcting the defect, press the OK screen key. This transfers to a new screen, and the sequence of tests begins. The test in progress is reported on the screen:

The 9100 first checks the state of the card's internal battery. If the battery voltage is low, this will be stated on the screen:

Final Width = 215mm

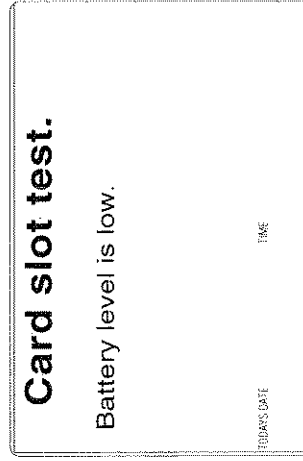

If there is no battery in the card, or if the battery cannot support read/write operations, then the statement will be 'Battery level is dead.'

Note:

For a re-chargeable card with a low battery, the low/dead message may take several minutes to clear after pressing **OK**.

Continued Overleaf

8.3.4.5 Memory Card Checks (Contd.)

The next test is to check the size of the card memory. While the 9100 is checking, it will place the following message on the screen:



Once the size check is completed, the 9100 starts on a 'read/write' check; meanwhile the display changes to:

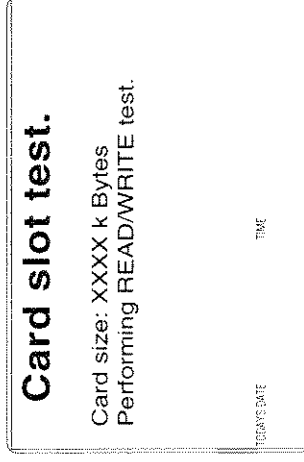

After the read/write check, the 9100 starts on a 'walking ones' check, and the message on the display changes to:

Performing WALKING ONES test.

The test continues, this time to format the memory into 'Results Card' format. A new message appears on the display:

Performing RESULTS CARD format.

Final Width = 215mm

Providing that the full range of tests and formatting is completed successfully, the PASS statement is added to the screen:

Card slot test.	
Card size: XXXX k Bytes	
Performing RESULTS CARD format.	
Selected card interface PASSED.	
LOGANS DATE	TIME
EXIT	

EXIT returns to the Interface 'Select test' menu screen.

If the test fails at any point, then the test will stop, leaving the heading for the failed test on the screen, followed by a failure statement. For example, if the failure occurred during the 'walking ones' check, then the following screen would be presented:

Final Width = 215mm

Card slot test.	
Card size: XXXX k Bytes	
Performing WALKING ONES test.	
Selected card interface FAILED.	
LOGANS DATE	TIME
EXIT	

To diagnose the reason for a failure, there are several further checks which can be made to localize the fault. Firstly, an attempt should be made to re-check the same card in the other slot, then if this is successful, check a new card in the original slot. This should narrow the fault down to one slot or one card. If it is suspected that the 9100 is at fault, it is wise to report the result to your Wavetek Service Center.

EXIT returns to the Interface 'Select test' menu screen.

8.3.4.6 Tracker Ball Checks

Checks of a connected tracker ball are initiated by pressing the TRACKER key on the 'Select test' menu screen:

Selftest.		DISPLAY	MEMORY
Select test using softkeys		KEYBRD	DISPLAY
		MEMORY	CARD
		TRACKER	PRINTER
LOGS DATE	TIME		
EXIT			

Selecting 'TRACKER' transfers to the 'Tracker test' screen. This invites a user to use a tracker ball to test the interface, and reports on the screen the details of the last key to be pressed, and the last movement of the ball:

Tracker test.			
Use a tracker ball to test interface.			
Last key pressed: LEFT/RIGHT			
Last direction: UP/DOWN/LEFT/RIGHT			
LOGS DATE	TIME		
EXIT			

The possible responses are shown on the diagram. Note that the center key on the tracker has no function in its operation with the 9100, and is not tested, so pressing this key should have no effect, unless the tracker is defective.

If the last key to be named does not coincide with the last key to be physically pressed, or if the last direction shown does not correspond to the last physical movement; then a failure is implied. It is possible to diagnose the defect source by checking a second tracker unit on the same 9100, or the same tracker unit on a different 9100. Rectification may require access to the internal circuitry of the 9100 or tracker unit, so no further user action is recommended, except to report the result to your Wavetek Service Center.

EXIT returns to the Interface 'Select test' menu screen.

Final Width = 215mm

8.3.4.7 Printer Checks

Checks of a connected printer are initiated by pressing the PRINTER key on the 'Select test' menu screen:

Selftest.		DISPLAY MEMORY
Select test using softkeys		KEYBRD
		DISPLAY
		MEMORY CARD
		TRACKER
		PRINTER
TODAY'S DATE	TIME	
EXIT		

Selecting 'PRINTER' transfers to the 'Printer test' screen. This invites a user to use a printer to test the interface (e.g. by switching the printer off-line, or removing the paper), and reports on the status of the printer:

Printer test.	
Use a printer to test interface. Press EXIT to stop printout. Printer status: PRINTING/ NOT RESPONDING/ OUT OF PAPER	
TODAY'S DATE	TIME
EXIT	

Final Width = 215mm

Note: If the printer is disabled (Config mode — *Volume 1, Section 3, paras 3.3.2.5*), the printer will not be set up when starting to print for the first time.

The possible responses are shown on the diagram. They are updated automatically as the printer status changes. When operating correctly, the printer will print a character-set continuously until the EXIT screen key is pressed.

If the reported status of the printer interface does not match the known physical status, then this implies a failure. It is possible to diagnose the defect source by checking a second printer unit on the same 9100, or the same printer unit on a different 9100. Rectification may require access to the internal circuitry of the 9100 or printer unit, so no further user action is recommended, except for obvious setup errors. Otherwise it is advisable to report the result to your Wavetek Service Center.

EXIT returns to the Interface 'Select test' menu screen.

8.4 Printing Selftest Results

The results of Full and Fast selftests can be printed out by a printer connected to the parallel port J103 on the rear panel. It can also be used to print out certificates for UUTs calibrated in Procedure mode.

8.4.1 Parallel Port J103 (Rear Panel)

Pin Layout

This 25 way D-Type socket is located beneath the IEEE-488 connector on the rear panel. Its connections are similar to the 25-way printer port on PCs, carrying control and data for an external printer as designated in the table.

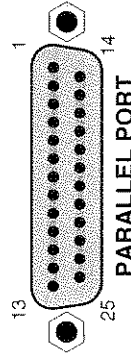

Pin Designations

9100 Pin No.	9100 Signal Name	9100 I/O	Description or Common Meaning
1	STROBE_L	Output	1µs pulse to cause printer to read one byte of data from data bus DO1 — DO8.
2	DO1	Output	Data bit 1
3	DO2	Output	Data bit 2
4	DO3	Output	Data bit 3
5	DO4	Output	Data bit 4
6	DO5	Output	Data bit 5
7	DO6	Output	Data bit 6
8	DO7	Output	Data bit 7
9	DO8	Output	Data bit 8
10	ACKNLG_L	Input	Pulse to indicate that the printer has accepted a data byte, and is ready for more data.
11	BUSY_H	Input	Printer is temporarily busy and cannot receive data.
12	P_END_H	Input	Printer is out of paper.
13	SLCT_H	Input	Printer is in online state, or connected.
14	AUTO_FEED_L	Output	Paper is automatically fed 1 line after printing. This line is fixed _H (high) by the 9100 to disable autotofeet.
15	ERROR_L	Input	Printer is in 'Paper End', 'Offline' or 'Error' state.
16	INIT_L	Output	Commands printer to reset to power-up state, and in most printers to clear its print buffer.
17	SLCT_IN_L	Output	Commands some printers to accept data. This line is fixed _L (low) by the 9100.
18-25	0V_F	Output	Digital Common

_H = Logic-1 active; _L = Logic-0 active.

Final Width = 215mm

8.4.2 Printing Setup

The results of Full and Fast selftest operations can be printed directly via the rear panel parallel port J103. A suitable printer must be connected and switched on-line; then the 9100 internal program will generate the required results.

8.4.2.1 Printer Type

The printer to be used should be capable of printing 120 characters per line, and must be able to print the Code Page 437 character set. Most printers compatible with Epson FX, Canon Bubble-Jet or Hewlett-Packard Desk-Jet are suitable.

8.4.2.2 Data Formatting

The required printout style, format and data is pre-determined depending on whether Full or Fast test results are being printed, and on the type of printer to be used. It is necessary to *enable* a particular printer type via Configuration mode, only if the format for that printer is required.

Note: If the printer is disabled (Config mode — *Volume 1, Section 3, paras 3.3.2.6*), the printer will not be set up when starting to print for the first time.

8.4.3 Results Printout

Apart from the heading, both Full and Fast test results have the same printed layout. The results of tests on all test pathways are collected together in a table. Typical samples of tables are given below:

Find Width = 215mm

Serial No: XXXXXX S/W Issue: X.XX Date: XX/YY/ZZZZ Time: 12:41 Type: FAST

TEST PT	MEAS VALUE	MAX LIMIT	MIN LIMIT	NOMINAL	RESULT A	RESULT B	ERROR %	FAILURES
A04.001	-0.000044	+0.001500	-0.001500	0.000000	0.000041	-0.000048	-3	
A01.001	+6.553340	+6.602800	+6.504400	+6.553600	+6.553363	+6.553316	0	
P05.001	+5.115005	+5.725000	+4.675000	+5.200000	+5.114981	+5.115029	-16	

Serial No: XXXXXX S/W Issue: X.XX Date: XX/YY/ZZZZ Time: 12:41 Type: FULL

TEST PT	MEAS VALUE	MAX LIMIT	MIN LIMIT	NOMINAL	RESULT A	RESULT B	ERROR %	FAILURES
A01.001	+6.553292	+6.564493	+6.552743	+6.553670	+6.553292	+6.553292	-3	
A01.002	+6.553137	+6.566200	+6.541000	+6.553600	+6.553173	+6.553181	-4	
A01.003	-6.553888	-6.537325	-6.569875	-6.553600	-6.553864	-6.553912	-2	

ERROR % gives the achieved percentage of full tolerance for that test.

FAILURES In this column a failure is shown by the figure '1' against the relevant test.

Error Reporting Subsystem

Note to users: For the sake of completeness, this appendix collects together the error codes which might be generated either on the instrument front panel, or via the IEEE 488 system bus.

8.A.1 Error Detection

All errors which cannot be recovered without the user's knowledge, result in some system action to inform the user via a message, and where possible restore the system to an operational condition. Errors are classified by the method with which they are handled. Recoverable errors report the

error and then continue. System errors which cannot be recovered cause the system to reset via the Power-on state to a fatal error report state, from which a 'resume' may clear the error, but generally such messages are caused by hardware or software faults, which require user action.

8.A.2 Error Messages

8.A.2.1 Fatal System Errors

For all fatal system errors, the error condition is reported only via the front panel. The error will pull the processor reset line to restart the system as at power-on. The screen will display a message indicating that there has been a fatal error and thus the processor has been reset. A user may continue by use of

the 'resume' key, or from power on, and initiate repair if the fault persists.

The following is a list of error numbers, which will be displayed with their fault descriptions:

ALWAYS: record the total message content for possible use by the Service Center.

9501 - DAC Default Charactn. Failed	9508 - UNEXPECTED Power amp overload
9502 - Failed to clear Flash RAM	9509 - UNEXPECTED compliance flag
9503 - UNEXPECTED multiple fail flags	9510 - Measurement command flushed
9504 - No A/D ready bit after 160ms	9511 - UNEXPECTED Output clamp overload
9505 - Flash RAM protected by switch	9990 - UNEXPECTED case in switch statement
9506 - UNEXPECTED over temperature flag	UNDEFINED FATAL ERROR) An error number will be
9507 - UNEXPECTED HV power supply flag	OPERATING SYSTEM ERROR) allocated at run time

8.A.2.2 Recoverable Errors

8.A.2.2.1 Type of Errors

These consist of **Command Errors**, **Execution Errors**, **Query Errors** and **Device-Dependent Errors**. Command, Query and Execution Errors are generated due to incorrect remote programming. Device-Dependent Errors can be generated by manual as well as remote operation. Each of the reportable errors is identified by a code number.

8.A.2.2.2 Error Reporting

In response to a bus or a keyboard error, there are certain categories of error reporting. Primarily, the error will be reported to the original source of the error, but in some cases will be reported to both local and remote operators. Locally, the error will be displayed on the front-panel screen; remotely, it will set the relevant ESR bit, and add the error to the Error Queue.

Note about the ERROR Queue (accessible via the IEEE-488 Interface)

The Error Queue is a sequential memory stack. Each reportable error has been given a listed number and explanatory message, which are entered into the error queue as the error occurs. The queue is read destructively as a First-In/First-Out stack, using the query command: `SYSTEM:ERROR?` to obtain a code number and message.

Repeated use of the query: `SYSTEM:ERROR?` will read successive Device-Dependent, Command and Execution errors until the queue is empty, when the 'Empty' message (0, "No error") will be returned.

It would be good practice to repeatedly read the Error Queue until the 'Empty' message is returned.

The common command `*CLS` clears the queue.

Final Width = 215mm

8.A.2.2.3 Command Errors (CME)

(Remote operation only)

Command Error Generation

A Command Error is generated when the remote command does not conform, either to the device command syntax, or to the IEEE 488.2 generic syntax. The CME bit (5) is set *true* in the Standard-defined Event Status Byte, and the error code number is appended to the Error Queue.

- 100, "Command error"
- 101, "Invalid character"
- 103, "Invalid separator"
- 104, "Data type error"
- 105, "GET not allowed"
- 108, "Parameter not allowed"
- 110, "Command header error"
- 111, "Header separator error"

Command Error Reporting

The error is reported by the mechanisms described earlier in *Section 6, Sub-section 6.5*, which deals with status reporting.

The Command Errors implemented in the 9100 are listed below; their error numbers conform to those defined in the SCPI Standard document:

- 113, "Undefined header"
- 120, "Numeric data error"
- 121, "Invalid character in number"
- 123, "Exponent too large"
- 124, "Too many digits"
- 150, "String data error"
- 160, "Block data error"
- 161, "Invalid block data"
- 178, "Expression data not allowed"

ALWAYS: record the total message content for possible use by the Service Center.

8.A.2.2.4 Execution Errors (EXE) (Remote operation only)

Execution Error Generation

An Execution Error is generated if a received command cannot be executed due to it being incompatible with the current device state, or because it attempts to command parameters which are out-of-limits.

In remote operation, the EXE bit (4) is set *true* in the Standard-defined Event Status Byte, and the error code number is appended to the Error queue.

Execution Error Reporting

The error is reported by the mechanisms described earlier in Section 6, Sub-section 6.5, which deals with status reporting.

The Execution Error numbers are given below, with their associated descriptions.

- 220, "Parameter error"
- 221, "Settings conflict"
- 222, "Data out of range"
- 223, "Too much data"
- 258, "Media protected"

8.A.2.2.5 Query Errors (QYE) (Remote operation only)

Query Error Generation

A Query Error is generated when the controller fails to follow the Message Exchange Control Protocol as follows:

- **DEADLOCK State**
The device has been asked to buffer more data than it has room to store; the Output Queue is full, blocking the Response Formatter, Execution Control and Parser; the Input Buffer is full, and the controller is waiting to send more data bytes to the device.
- **UNTERMINATED Action**
The controller attempts to read a Response Message from the device without first having sent a complete Query Message, including the Program Message Terminator.
- **INTERRUPTED Action**
The device is interrupted by a new Program Message before it finishes sending a Response Message.

Final Width = 215mm

Query Error Reporting

The QYE bit (2) is set *true* in the Standard-defined Event Status Byte, and the error code number is appended to the Error queue. The error is reported by the mechanisms described earlier in Section 6, Sub-section 6.5, which deals with status reporting.

The specific reason for a query error must be determined by inspection of the command program. No error codes are provided from within the 9100.

ALWAYS: record the total message content for possible use by the Service Center.

8.A.2.2.6 Device-Dependent Errors (DDE)

A Device-Dependent Error is generated if the device detects an internal operating fault (eg. during self-test). The DDE bit (3) is set *true* in the Standard-defined Event Status Byte, and the error code number is appended to the Error queue. The

error description appears on the display, remaining visible until the next key-press or remote command.

Errors are reported by the mechanisms described earlier in Section 6, *Sub-section 6.5*, which deals with status reporting.

8.A.2.2.7 Device-Dependent Errors Reported only Locally on the Front Panel Screen

The error list for local operations, which are not reported to the remote operator, is given below:

Note that the error *number* will not be presented on the screen

-7001, "Entry contains illegal characters"
-7002, "Entered value is outside the allowed range"
-7016, "Bus address must be within the range 0 - 30"
-7018, "Borderline must be within the range 10.00 - 99.99 %"
-7019, "Entry does not match previous password entry"
-9001, "Target too big"
-9002, "Target too small"
-9003, "Frequency too high"
-9004, "Frequency too small"
-9005, "Level too big"
-9006, "Level too small"
-9007, "Deviation too big"
-9008, "Deviation too small"
-9009, "Width too big"
-9010, "Width too small"
-9011, "Period too big"
-9012, "Period too small"
-9013, "Duty too big"
-9014, "Duty too small"
-9015, "Temperature too big"
-9016, "Temperature too small"
-9017, "High volt lvl equals low volt lvl"
-9019, "High volt lvl below low volt lvl"
-9020, "Low volt lvl above high volt lvl"
-9021, "Outside amp x freq profile"
-9022, "Syntax error"
-9023, "Number too big"
-9024, "Reached upper boundary"
-9025, "Reached lower boundary"
-9026, "Up range required"
-9027, "Down range required"
-9028, "No more ranges"

-9029, "Top of range"
-9030, "Bottom of range"
-9031, "Maximum value"
-9032, "Minimum value"
-9033, "Illegal rep/width combination"
-9034, "Illegal duty/width combination"
-9036, "No calibration for this function"
-9037, "THERMAL limit: reduced output"
-9038, "Printer is not responding"
-9039, "Printer out of paper"
-9040, "Invalid test number"
-9041, "Invalid loop counter"
-9042, "Illegal offset"
-9043, "No more failures to view"
-9044, "No more tests to execute"
-9045, "Nominal Resistance too big"
-9046, "Nominal Resistance too small"
-9047, "Maximum positive phase angle"
-9048, "Maximum negative phase angle"
-9049, "Cannot change: Φ ref out still selected"

-9050, "Cannot change: delta Φ still selected"

-9051, "Freq too big: 1kHz max when Φ ref out active"

-9052, "Freq too big: 1kHz max when delta Φ active"

-9053, "Previous test point failed: exceeded UUT spec. limits"

-9054, "Target factor is corrupt - select defaults"

-9055, "Only a restricted setting allowed"

-9056, "No frequency change allowed"

-9057, "Time marker period too big"

-9058, "Time marker period too small"

-9059, "Invalid no. of divisions"

Final Width = 215mm

ALWAYS: record the total message content for possible use by the Service Center.

-9060, "Invalid V/div value"
 -9061, "Illegal V/div, no. of div's combination"
 -9062, "-ve edge not available with 1M\352 load"
 -9063, "Frequency too big for 1M\352 load"
 -9064, "Amplitude too big for 50\352 load"
 -9065, "Frequency too big for present amplitude"
 -9066, "Entered number exceeds limits"
 -9067, "Search procedure - NO Test point"
 -9068, "Search procedure - Function ID Expected"
 -9069, "Harmonic frequency cannot exceed 3000 Hz"
 -9070, "Cannot change: phase too high".
 -9070, "Cannot change: phase at 0\370"
 -9071, "Cannot change: phase at \36190\370"
 -9072, "Cannot change: phase at \361180\370"
 -9073, "Cannot change: aux channel at zero"

8.A.2.2.8 Device-Dependent Errors Reported only Remotely via the IEEE-488 Interface

The error list for remote operations, which are not reported on the front panel screen, is given below:

-300, "Device specific error"
 -312, "PUD memory lost"
 -315, "Selftest failed"
 -330, "Configuration memory lost"
 -350, "Queue overflow"

8.A.2.2.9 Device-Dependent Errors Reported both Locally and Remotely

Errors are reported both on the front panel screen and via the IEEE-488 interface. Note that the locally-presented error message will not include the error *number*.

General

1001, "Overload of power amp"
 1002, "Over temperature"
 1003, "Over compliance"
 1006, "Overload of HV power supply"
 1008, "Overload of output clamp"
 1009, "MULTIPLE analogue fail flags"
 1010, "Softkey label too long"
 1011, "Confirm with ON"
 1014, "Power output not allowed with 9105 work-mat"
 1020, "Unknown keycode"
 5010, "Priority OFF received"

Calibration

4001, "Corrupt factors:- substitution"
 4003, "Password incorrect"
 4004, "Cal switch not enabled"
 4005, "Factory password incorrect"
 4006, "Correction block:- invalid"
 4007, "Amplitude outside limits"
 4008, "Cal is password protected"
 4009, "Frequency outside limits"
 4024, "Failed to save (act) factor"
 4025, "Failed to save (tgt) factor"
 4026, "Failed to save (frq) factor"
 4027, "Failed to save (R-egv) factor"
 4028, "Limits: R-egv"
 4029, "Failed to save (act) R-derivd"
 4030, "Failed to save (tgt) R-derivd"
 4031, "Failed to save (act) C-ref"
 4032, "Failed to save (tgt) C-ref"
 4033, "Failed to save (frq) C-ref"
 4034, "Failed to save (C-egv) factor"
 4035, "Failed to save (cjc) factor"
 4051, "Cap meas no 1st reading"
 4052, "Cap meas no 2nd reading"
 4053, "Cap meas outside limits"
 4055, "Corrupt cal factors"
 4056, "Failed -----"
 4057, "Corrupt selfcal factor"
 4058, "Corrupt res. ref. factor"
 4059, "Corrupt cold junc diff factor"

Continued Overleaf

ALWAYS: record the total message content for possible use by the Service Center.

8.A.2.2.9 Device-Dependent Errors Reported both Locally and Remotely (Contd.)

Calibration (continued)

4060, "Corrupt offset DAC factor"
4061, "Using default DAC factors"
-7021, "Temperature must be in the range
00.00 - 50.00"
-7022, "A valid Cold Junction temperature
is required"

DAC Compensation

5001, "Corrupt main DAC gain"
5002, "Corrupt trim DAC gain"
5003, "Corrupt composite DAC zero"
5004, "Corrupt lookup table"
5005, "Corrupt Vmax. Vmin"
5006, "Corrupt +ve zero (DAC)"
5007, "Corrupt -ve zero (DAC)"
5008, "Corrupt polarity gain (DAC)"
5009, "Corrupt LFAC correction"
5011, "Gain request limited"
5012, "Failed to read from flash RAM"

Characterization

4501, "Limits: main DAC gain"
4502, "Limits: composite DAC zero"
4503, "Limits: trim DAC gain"
4504, "Limits: offset DAC gain"
4505, "Limits: main DAC linearity"
4506, "Failed to write to flash RAM"
4507, "Limits: gain of 2 zero"
4508, "Limits: gain of 0.5 zero"
4509, "Limits: DAC output zero"
4510, "Limits: 0.75 buffer zero"
4511, "Limits: DAC positive zero"
4512, "Limits: DAC negative zero"
4513, "Limits: DAC positive FR"
4514, "Limits: DAC negative FR"
4515, "Limits: DAC \361FR ratio"
4516, "Limits: DAC max - DAC min"
4517, "Limits: resistor ratios"
4518, "Failed to save resistor ratios"
4519, "Limits: main DAC offset"
4520, "Failed to save impedance offset"
4521, "LF AC Chrcn impossible: default set"
4522, "Excess LF AC flatness"
4523, "Failed to save DDS lfac error"
4524, "Limits: Gain of 1 zero"
4525, "Limits: PWR DAC gain"
4526, "Limits: PWR trim DAC gain"
4527, "Limits: PWR DAC zero"
4528, "Limits: PWR DAC linearity"

Cold Junction Compensation

5020, "Invalid CJC measurement -
default to 25°C"
5021, "Temperature table: no entry found"

Configuration

4002, "Failed to save configuration"
-7003, "Day entry is not a valid number"
-7004, "Day separator is incorrect"
-7005, "Month entry is not a valid number"
-7006, "Month separator is incorrect"
-7007, "Century entry is not a valid
number"
-7008, "Year entry is not a valid number"
-7009, "Year separator is incorrect"
-7010, "Month entry is not a valid month"
-7011, "Day entry is not a valid day"
-7012, "Hours entry is not a valid number"
-7013, "Minutes entry is not a valid
number"
-7014, "Entry does not give a valid time
setting"
-7017, "Safety Voltage must be in the
range 10.00 V -110.000 V"
-7031, "The transducer scaling factor must
be between 45 uV and 10 mV"

Final Width = 215mm

ALWAYS: record the total message content for possible use by the Service Center.

Section 9 Verifying the Model 9100 Specification

9.1 About Section 9

Section 9 introduces the principles involved in verification of Model 9100 performance, including the issue of traceability.

9.2 Need for Verification

9.2.1 Factory Calibration and Traceability

Factory calibration of the Model 9100 ensures full traceability up to and including National Standards. Its traceable accuracy figures are quoted in the specifications given in *Section 7*, and all relate to a 1-year calibration interval. These figures include all calibration uncertainties, including those of National Standards, and therefore constitute absolute accuracies.

9.2.2 Verification on Receipt from the Factory

Each 9100 is despatched from Wavetek with a Certificate of Calibration, which gives detailed results of its pre-shipment performance. However, many organizations wish to confirm that all instruments perform within published specifications, on receipt from their manufacturer. This not only confirms the value of their purchase, but also gives a confident starting point for subsequent instrument use.

Such verification is only possible, however, if the user's organization is in possession of suitable standards equipment, of the necessary traceable accuracy. In the absence of such standards, users may rely on external support organizations to verify the 9100's accuracy, probably also using these organizations to recalibrate the unit at appropriate intervals. For users who wish to carry out verification or recalibration of a 9100 on-site, without having to ship the 9100 to a calibration laboratory, the Wavetek Model 4950 Multifunction Transfer Standard can be used automatically to calibrate and/or verify the 9100's accuracy using the PC-based Model 4950 MTS Control Software.

9.2.3 Verification after User-Calibration

When a 9100 is calibrated against calibration standards as detailed in *Section 10* of this handbook, its pre-calibration and post-calibration performance at each calibration point can be easily assessed as part of the calibration procedure. However, some organizations may prefer to carry out separate pre- and post-calibration performance verifications.

Final Width = 215mm

9.3 Equipment Requirements

As stated earlier, the calibration standards required to verify that a 9100 is within its published accuracy specifications must possess the necessary traceable accuracy. The generally accepted minimum test uncertainty ratio (the ratio between the accuracy of the 9100 at a verification point and the absolute accuracy of the standard used to verify it at that point) is 3:1, which must apply at all points being used to verify the 9100's accuracy.

Also note that the measuring equipment must operate within the optimum output conditions of the 9100, as defined in the accuracy tables given in *Section 7* of this handbook—i.e. the measurement equipment should be able to operate within the relevant 9100's compliance limits so that no additional accuracy figures have to be taken into account.

9.4 Interconnections

The form of interconnection required to ensure optimum conditions for verification measurements will depend on the 9100 function being verified and on the measuring equipment connected to the 9100's terminals. For functions which can be directly calibrated (DC and AC Voltage, DC and AC Current, Resistance and Capacitance) suitable connections are illustrated in the appropriate part of *Section 10: Calibrating the 9100*, in this handbook.

Final Width = 215mm

9.5 Verification Points

The accuracy specifications detailed in *Section 7* of this handbook cover the full range of output values which can be generated by the 9100, and its accuracy can therefore be verified against the specification at any number of points in these output ranges.

As the actual verification points chosen will depend to a large extent on the traceable accuracy of the measuring equipment used to measure the 9100's outputs, it is beyond the scope of this handbook to define a precise set of verification points for each of the 9100's functions. However, when selecting verification points the following guidelines should be followed:-

- 1) Where the 9100's specification is broken up into several different output amplitude and/or frequency bands, verification points should be close to the top and bottom of these spans.

For 9100 functions which can be directly calibrated (DC and AC Voltage, DC and AC Current, Resistance and Capacitance) the default or recommended 'calibration targets' detailed in *Section 10: Calibrating the 9100* can be used as suitable verification points.

- 2) Capacitance bridges are not generally suited to verifying the 9100's capacitance outputs for a number of reasons. Firstly, capacitance bridges are too inaccurate at the extremes of frequency and impedance required to verify the full range of 9100 capacitance outputs (0.5nF to 40mF). Secondly, bridges often ground one of the 9100's output terminals, which prevents the calibrator from operating correctly (the 9100 is designed to drive fully floating loads.) A suitable transfer measurement technique, using a set of standard capacitors and a floating capacitance meter, is detailed in the capacitance calibration sub-section of *Section 10: Calibrating the Model 9100*, in this handbook.

Final Width = 215mm

9.6 Calculating Absolute Specification Limits

For each chosen verification point it will be necessary to calculate absolute measurement limits which can be used to judge whether or not the 9100 is performing within its specification. As mentioned earlier, the accuracy specifications detailed in *Section 7* of this handbook are absolute accuracies which incorporate all the uncertainties involved in calibrating the 9100 up to and including those of National Standards.

If verification results are to be at all meaningful, the measuring equipment which is used to verify the 9100's accuracy must have separate traceability to the same National Standards, and the uncertainties involved in this traceability must be taken into account when determining the absolute verification limits required at the chosen verification points.

To ensure that worst-case conditions are taken into account, these verification limits should be calculated as follows (an example is given alongside each step to aid understanding):-

1. By referring to the appropriate function table in *Section 7* of this manual, locate the 9100 output band in which the required verification point is located. Note the accuracy of the 9100 in this band, which is given in the form of a fraction of output value plus a floor (offset) value.
2. Multiply the verification point value by the **fraction of Output** figure in the specification.
3. Add the **Floor** figure in the specification to the result obtained in step (2), taking into account any 'engineering unit' multiplier such as μ ($\times 10^{-6}$), m ($\times 10^{-3}$) etc. specified in the **Floor** value. This will give you a combined **Fraction of Output + Floor** uncertainty specification for the 9100 at the verification point value.
4. Add the result obtained in step (3) to the verification point value to obtain a 'high' output limit for the 9100 output.
5. Subtract the result obtained in step (3) from the verification point value to obtain a 'low' output limit for the 9100 output.

Example: For a verification point value of 2V, the 9100 accuracy specification is:-
 $0.006\% + 41.6\mu\text{V}$

$$\frac{2 \times 0.006}{100} = 0.00012$$

$$0.00012 + 41.6 \times 10^{-6} = 0.0001616$$

$$2 + 0.0001616 = 2.0001616$$

$$2 - 0.0001616 = 1.9998384$$

Final Width = 215mm

Provided that the actual output lies between the high and low limits calculated in steps (4) and (5) above, the 9100 will be within its published accuracy specification. However, in deciding on test limits applicable to the verification measurement you must also take into account the accuracy with which the measuring equipment can measure this output. For example, if the 9100's 2V DC Voltage output was actually 2.0001616V, it would still be within its accuracy specification. However, a voltmeter with a traceable accuracy of 10ppm at 2V could measure this value as 2.0001816V, leading you to believe that the 9100 was outside its specified accuracy. To obtain true limits for the verification measurements you must therefore add the total uncertainty of the measuring equipment to limits obtained in steps (4) and (5) above as follows:

- | | |
|--|---|
| <p>6. Determine the traceable absolute accuracy (including National Standards uncertainties) of the measuring equipment at the verification point value.</p> | <p>For a voltmeter traceable to 10ppm, absolute accuracy at 2V is 0.00002V.</p> |
| <p>7. Add the figure determined in step (6) to the high output limit obtained in step (4) to obtain the high verification limit.</p> | <p>$2.0001616 + 0.00002$
= 2.0001816</p> |
| <p>8. Subtract the figure determined in step (6) from the low output limit obtained in step (5) to obtain the low verification limit.</p> | <p>$1.9998384 - 0.00002$
= 1.9998184</p> |
| <p>9. Check that the reading obtained on the measuring equipment, when it is used to measure the 9100 output, is between the high and low verification limits obtained in steps (7) and (8) above.</p> | <p>If the reading on the voltmeter is less than 1.9998184V or greater than 2.0001816V then the 9100 is <i>outside</i> its accuracy specification at 2V.</p> |

Final Width = 215mm

- | | |
|---|---|
| <p>10. To be <i>absolutely certain</i> that the 9100 is <i>within</i> its specification limits, then the uncertainty of the measuring equipment must be totally discounted. This means that in step (7), when we added the measuring equipment's accuracy derived in step (6), we must now subtract it [and in step (8), it must be added].</p> | <p>$2.0001616 - 0.00002$
= 2.0001416</p> <p>$1.9998384 + 0.00002$
= 1.9998584</p> |
|---|---|

Note: At step (9), we can say that the 9100 achieves its accuracy specification, but with 2 times the measuring equipment uncertainty. At step (10), we have removed the 2-times uncertainty, so if its reading is within the limits, the 9100 achieves 100% accuracy specification.

Section 10 Calibrating the Model 9100

10.1 About Section 10

Section 10 outlines general procedures for calibrating the Model 9100. In it you will find the recommended calibration methods, details of the parameters that require calibration and the procedures needed to calibrate them.

This section is divided into the following sub-sections:

- 10.2 The Model 9100's Calibration Mode
Selection of Calibration Mode, Special Calibration and Standard Calibration.
- 10.3 Standard Calibration — Basic Sequences
Using the function, target selection and calibrate screens
- 10.4 Front-panel Calibration of Model 9100 Functions
Lists of calibration points, equipment requirements, interconnections, procedures and recording for all Functions requiring calibration.
- 10.5 Remote Calibration of the Model 9100 via the IEEE-488 Interface
The Model 4950 MTS System.

Final Width = 215mm

10.2 The Model 9100 Calibration Mode

10.2.1 Introduction

This section is a guide to the use of the Model 9100's Calibration Mode. The following topics are covered:

- 10.2.2 Mode Selection
 - 10.2.2.1 'Mode' Key
 - 10.2.2.2 'Mode Selection' Screen
- 10.2.3 Selection of Calibration Mode
 - 10.2.3.1 Calibration Enable Switch
 - 10.2.3.2 Password
 - 10.2.3.3 Calibration Mode Display
 - 10.2.3.4 Calibration Mode Screen Softkeys
- 10.2.4 Special Calibration
 - 10.2.4.1 Selecting Special Calibration
 - 10.2.4.2 The Characterise DAC Screen Display
 - 10.2.4.3 Characterise DAC Errors
- 10.2.5 Cold Junction Calibration
 - 10.2.5.1 Rationale
 - 10.2.5.2 Selecting COLD JUNC CALIB
 - 10.2.5.3 Entering Temperature Values
 - 10.2.5.4 CJC Pod Identification
 - 10.2.5.5 Equipment Requirements
 - 10.2.5.6 Error Reduction
 - 10.2.5.7 Cold Junction Calibration Procedure
- 10.2.6 Standard Calibration
 - 10.2.6.1 Function Selection
 - 10.2.6.2 Cal Mode Function Screens
 - 10.2.6.3 Hardware Configurations
- 10.2.7 Overview of Calibration Operations

Final Width = 215mm

10.2.2 Mode Selection

10.2.2.1 'Mode' Key

Selection of any one of the Model 9100's five operating 'Modes' is enabled by pressing the 'Mode' key at the bottom right of the 'CALIBRATION SYSTEM' key panel. This results in display of the mode selection screen shown below.

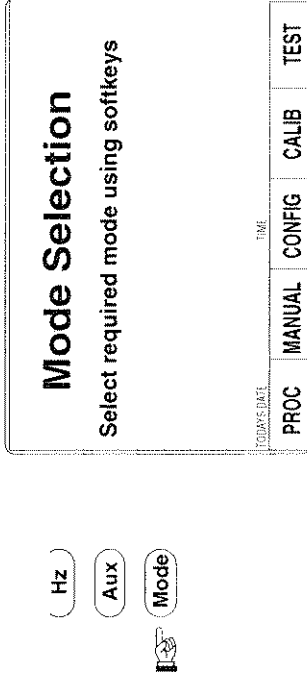

Final Width = 215mm

10.2.2.2 'Mode Selection' Screen

The Mode Selection menu screen allows you to select any one of the following operating modes:-

- PROC Procedure mode
- MANUAL Manual mode
- CONFIG Configure mode
- CALIB Calibration mode
- TEST Selftest mode

Each mode is selected by pressing the appropriate screen softkey, after which a new menu screen relating specifically to that mode will be displayed. (Note: for the calibration menu screen to appear, certain other conditions must be satisfied — see opposite.)

10.2.3 Selection of Calibration Mode

The following two conditions must be satisfied before the Calibration mode menu screen can be accessed:-

- a. The rear-panel Calibration Enable switch must be in the 'ENABLE' position.
- b. A valid password must have been entered via the front panel keypad.

10.2.3.1 Calibration Enable Switch

The Calibration Enable DIP-switch is accessible, using a small screwdriver, through a recess on the Model 9100's rear panel.

Cal Key Disabled With the Calibration Enable switch in the 'DISABLE' position, any attempt to select Calibration mode by pressing the 'CALIB' screen softkey will result in the screen prompt "**Calibration switch not enabled!**" being displayed, and access to the calibration mode will be denied.

Cal Key Enabled With the Calibration Enable switch in the 'ENABLE' position, pressing the 'CALIB' screen key will result in the 'Password Entry for Calibration' user prompt screen being displayed.

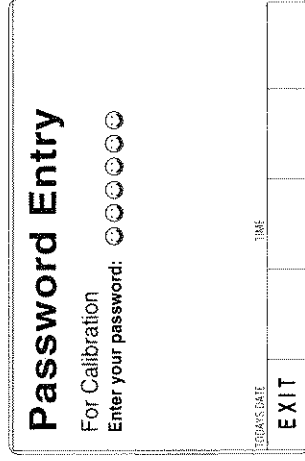

10.2.3.2 Password

Before the Calibration mode menu screen can be displayed you must now enter a valid password using the Model 9100's alphanumeric keyboard. For information about the initial 'shipment' password, and about the method of changing this to a custom password, refer to Section 3.3.2.23 of the *Model 9100 Universal Calibration System User's Handbook - Volume 1 - Operation*.

As each character in the password is entered, security code icons will appear on the screen as shown above. Once the correct password has been entered, pressing the 'J' (Enter) key will result in the Calibration Mode menu screen being displayed. If the password is incorrect, the error message "PASSWORD INCORRECT" will be displayed and the security code character icons will disappear, enabling you to attempt correct password entry again.

The 'EXIT' screen softkey will take you back to the Mode Selection screen.

Final Width = 215mm

10.2.3.3 Calibration Mode Display

When Calibration mode has been successfully entered by setting the CAL ENABLE switch to the ENABLE position and entering the correct Password, the 'Calibration Mode' menu screen shown below will be displayed:

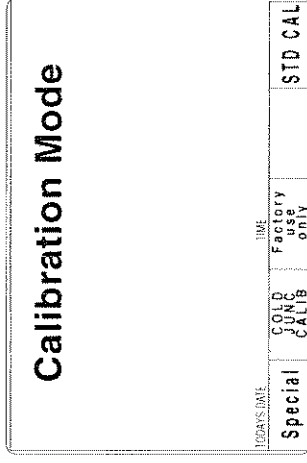

10.2.3.4 Calibration Mode Screen Softkeys

The following screen softkeys are active:-

Special

Accesses the Special Calibration menu so that you can perform the 'Chse DAC' (Characterise Digital-to-Analog Converter) calibration operation, which must be performed immediately before carrying out routine recalibration of the Model 9100.

COLD JUNC CALIB

The Reference Junctions used in the Thermocouple Temperature function are housed in an external module, whose internal temperature is monitored automatically by the 9100. This facility permits the monitor circuitry to be calibrated, while in use. The calibration is performed by measuring the temperature of the reference junctions externally, then entering the measured value via the front panel, or remotely via the IEEE-488 bus.

Factory use only

Accesses 'factory-set' calibration operations which can only be entered by a special password. These calibration operations only need to be performed when the instrument is manufactured, or after certain types of repair have been carried out on it.

STD CAL

Accesses the user control screens for routine external calibration of each Model 9100 function which can be calibrated.

Final Width = 215mm

10.2.4 Special Calibration

10.2.4.1 Selecting Special Calibration

Pressing the **Special** softkey in the **Calibration Mode** screen results in the **Special Calibration** screen shown below being displayed, in which the only active softkey is the one labelled **Chse — DAC** (Characterise DAC).

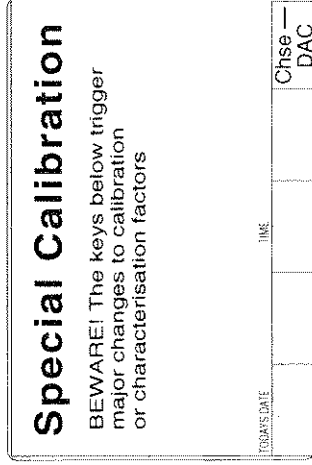

The Characterise DAC operation comprises a set of fully automatic internal adjustments which, using radiometric techniques, calibrates resistor ratios and AC frequency responses. **Chse—DAC** also checks and calibrates the linearity of the Model 9100's 20-bit D/A converter which is used to set the amplitude of its analog output functions. These adjustments are only required immediately prior to routine Standard Calibration of the Model 9100 as detailed in subsequent sub-sections of this handbook.

CAUTION! Do not press the **Chse — DAC** softkey unless you are doing so as part of an authorized recalibration of the Model 9100. Although the internal adjustment operations which it initiates will not dramatically change the overall calibration of the instrument, they will introduce a very small 'artificial' step into its apparent drift performance. If your company maintains historical records on each calibrator's drift performance between calibrations (for example, for the purposes of statistical process control in a total quality management system) this artificial step would need to be determined and suitably recorded in these records. There are no performance advantages to be gained by performing the Characterise DAC operation other than when Standard Calibration of the Model 9100's functions is also performed.

Final Width = 215mm

10.2.4.2 The 'Characterise DAC' Screen Display

Listed below are the screen messages which will be displayed as the Characterise DAC operation proceeds, together with the associated internal operations which are performed:-

Characterisation clear RAM Clears all existing calibration constants associated with the Characterise DAC operation.

Characterisation polarity Establishes a true zero for the DAC output.

Characterisation impedance Establishes the true ratios of several resistive dividers which are required to produce certain Model 9100 outputs.

Characterisation LF AC flatness Establishes a flat frequency response in the Model 9100's direct digital synthesis of low frequency AC outputs.

Characterisation DAC gains
followed by

Characterisation n = xxxxx
Measures the output of the DAC at over 4,000 different points and corrects any linearity errors detected. The displayed number 'n' represents the current test number.

When all Characterise DAC operations are complete (note that the entire process takes around 20 minutes), you will be returned to the Model 9100's **Mode Selection** screen.

Final Width = 215mm

10.2.4.3 'Characterise DAC' Errors

If for any reason the Model 9100 is unable to complete one or more of the Characterise DAC operations, error messages similar to that shown below will be displayed and default correction factors will be written to the Model 9100's non-volatile calibration memory.

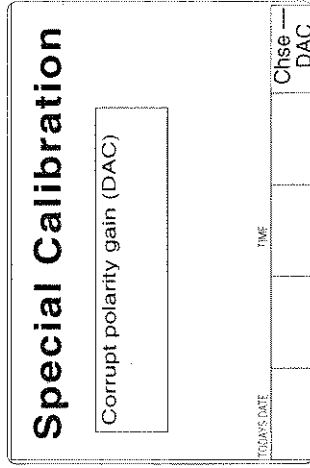

Although these default correction factors will allow the Model 9100 to remain functional, you should **not** proceed with calibration until the cause of the error has been established and rectified. In most cases, occurrence of this type of error will mean that the Model 9100 has developed a fault, in which case you should consult your local Wavetek Service Center for assistance. However, before doing so it is worth repeating the Characterise DAC process to make sure that the failure was 'real' and not caused by external influences such as a disturbance in the Model 9100's line supply.

Final Width = 215mm

10.2.5 Cold Junction Calibration

10.2.5.1 Rationale

The Cold Reference Junctions used in the Thermocouple Temperature function are housed in an external module ('CJC Pod'), whose internal temperature is monitored automatically by the host 9100. A CJC pod is calibrated for use with a particular host 9100 unit, and is *not* interchangeable between 9100s unless a recalibration is carried out. The calibration is performed by measuring the temperature of the reference junctions externally, then entering the measured value via the front panel, or remotely via the IEEE-488 bus.

10.2.5.2 Selecting COLD JUNC CALIB

Pressing the **COLD JUNC CALIB** softkey in the **Calibration Mode** screen presents the **CJ Temperature Cal** screen, with two active screen keys: **EXIT** and **CALIB**:

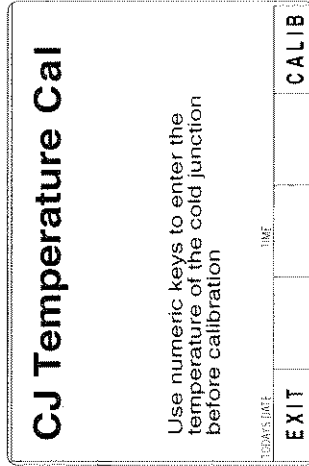

EXIT returns to the Calibration Mode screen.

CALIB performs the calibration, as part of the procedure at *paras 10.2.5.7*.

10.2.5.3 Entering Temperature Values

While performing the calibration, there are three major errors which could give rise to screen messages. These appear in a rectangle above the text already on the screen:

- If the 'CALIB' screen key is pressed before a numeric value has been fully entered (including pressing the ↵ key), then the following message will appear:

A valid Cold Junction temperature is required
- If the 'CALIB' screen key is pressed after entering a numeric value, but when the Reference Junction module is not plugged in, then the following message will appear:

Invalid CJC measurement — default to 25°C
- If the 'CALIB' screen key is pressed after entering a numeric value which is outside the range 0-50, then the following message will appear:

Temperature must be within the range 00.00-50.00

10.2.5.4 CJC Pod Identification

Because a CJC pod is calibrated together with a particular host 9100 unit, and the pod's correction data is held in the host's non-volatile memory, traceability is maintained only when the pod is used with that host. Where an organisation holds more than one 9100 and pod, there is a need to identify each pod's host 9100.

To encourage user organisations to register the association of each pod with a particular 9100, the label affixed to each pod has the serial number of the pod, plus a blank space for recording the serial number of the 9100 with which it is calibrated.

Part of the calibration procedure in *paras 10.2.5.7*, gives an instruction to record the serial number of the host 9100 in the space on the label.

10.2.5.5 Equipment Requirements

To calibrate using front panel controls, the procedure requires a traceably-calibrated Resistance Temperature Detector (RTD) equipped with a special $0.385\Omega/^\circ\text{C}$, 3mm diameter Platinum Resistance Thermometer (PRT Sensor Assembly — Wavetek part no. 401233 — traceably calibrated to an accuracy of $\pm 10\text{m}\Omega$ at 100Ω). The test uncertainty ratio of this combination over the 9100 RTD function specification must be at least 3:1, at the required calibration temperature between 0°C and 50°C .

Alternatively, the same PRT can be used with a DMM (e.g. Wavetek Model 1271), whose 100Ω or $1\text{k}\Omega$ range is traceably-calibrated at 100Ω to an accuracy of better than 0.013Ω . The source current must be limited to $1\text{mA} \pm 20\%$ to avoid self-heating errors in the PRT. A formula for conversion from resistance to temperature is given with the procedure in *paras. 10.2.5.7*.

For remote calibration, the Wavetek Model 4950 Multifunction Transfer Standard can be used, in conjunction with the MTS Control Software, to support this procedure automatically.

10.2.5.6 Error Reduction

Any errors in taking external measurements of the Reference Junction temperature can be attributed to environmental conditions and/or bad practice. To minimize these errors the following techniques should be implemented:

- Minimize all handling of the module, PRT element and leads, hence avoiding variations of temperature.
- Throughout all measurements shield the Reference Junction module from draughts, especially from fans in the vicinity.
- Before recording any results, be patient and allow the readings to stabilize.

Final Width = 215mm

Continued overleaf

10.2.5.7 Cold Junction Calibration Procedure

1. Test Setup Set up the calibration equipment as shown in *Fig. 10.2.5.1*, and allow to stabilize thermally for 1 hour, to eliminate any effects of being located at other temperatures.
2. 9100 On the **Calibration Mode** screen, select **COLD JUNC CALIB** to see the **CJ Temperature Cal** screen.
Operation (3) applies only when an RTD is being used for temperature measurement:
3. RTD Take measurements of the temperature until the readings have settled, then record the final reading.
Operations (4 & 5) apply only when a DMM is being used for resistance measurement:
4. DMM Take measurements of the PRT resistance until the readings have settled, then record the final reading.
5. DMM Reading Use the following formula to calculate the temperature of the PRT:
PRT Temp. (°C) =
$$\frac{(C - A) R - (BC + DA)}{D - B}$$

Final Width = 215mm

- Where: A = Actual Temperature (°C) of the PRT nominal 0°C calibration point;
B = Actual calibrated resistance at temperature 'A';
C = Actual Temperature (°C) of the PRT nominal upper calibration point;
D = Actual calibrated resistance at temperature 'C';
R = Measured resistance value recorded in operation (4), above.
6. 9100
 - a. Use the numeric keys to enter the resulting Reference Junction temperature (the number of degrees Celsius to two places of decimals). The numbers will appear inside a rectangle at the bottom of the screen.
 - b. Press the \downarrow key. The entered number will remain, but the rectangle will disappear.
 - c. Immediately press the **CALIB** screen key to perform the calibration.
 7. RTD/DMM If the PRT temperature has changed by 0.03°C or more (DMM reading by more than 0.01Ω) while calculating/entering the PRT temperature and pressing the CALIB key, repeat operations (5), (6), and this operation (7).
 8. 9100 Press the **EXIT** screen key to return to the Calibration Mode screen.
 9. CJC Pod Ensure that the correct 9100 serial number is written on the pod identification label. If not, erase the old number and write in the correct number. Also ensure that any other relevant records reflect the 9100/pod association.

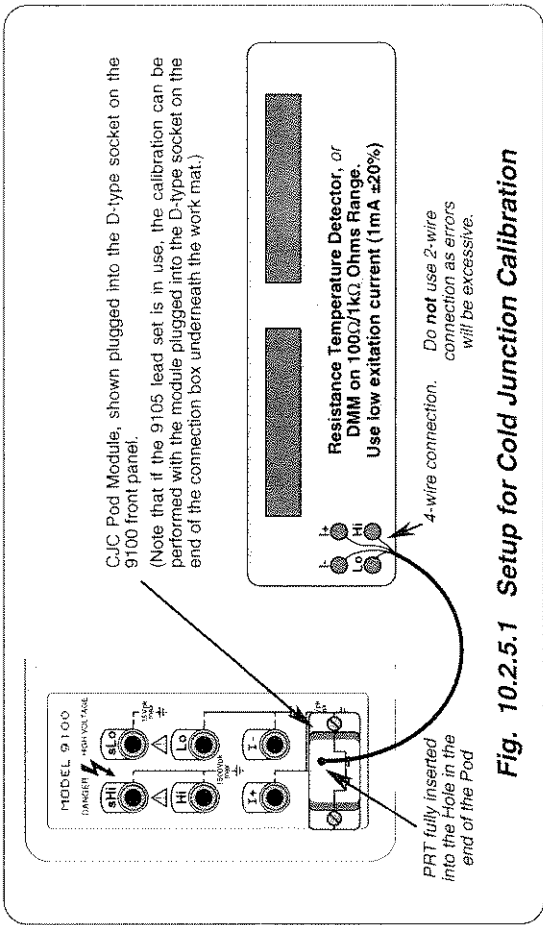

Fig. 10.2.5.1 Setup for Cold Junction Calibration

Final Width = 215mm

10.2.6 Standard Calibration (STD CAL)

10.2.6.1 Function Selection

Pressing the 'STD CAL' screen softkey displays the DC Voltage CAL mode function screen shown below, which always appears when you first enter Standard Calibration.

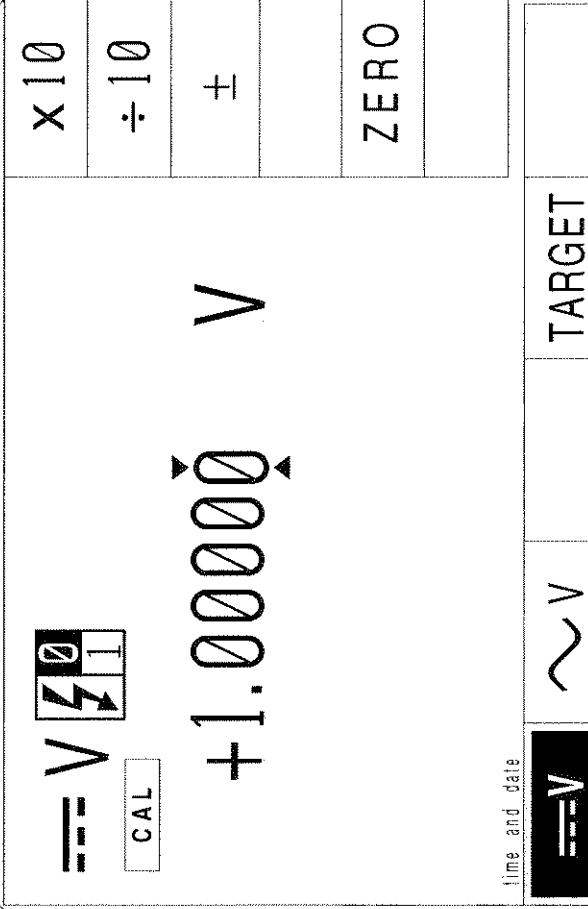
 <p>The screen displays a large 'V' with a lightning bolt symbol, a 'CAL' button, and a reading of '+1.00000 V'. Below the reading are four buttons: 'x10', '÷10', '±', and 'ZERO'. At the bottom, there is a 'time and date' label, a 'V' button, and a 'TARGET' label.</p>	
time and date	TARGET

If you wish to calibrate other functions which are available for user-calibration, they can be selected in the same way as for normal operation — i.e. Voltage, Current and Resistance are selected simply by pressing their corresponding front-panel push-button. AC Voltage is selected from the DC Voltage function screen, and Capacitance is selected via the Aux push-button and Auxiliary Function menu screen (see Section 4 of the *Model 9100 Universal Calibration System User's Handbook - Volume 1 - Operation*.)

Note that the Model 9100's Frequency, Conductance, Temperature and Logic functions cannot be externally calibrated (they are either derived directly from functions that *can* be calibrated or are calibrated 'for life' during manufacture). Attempting to select these functions while the Model 9100 is in CAL mode will result in an error message being displayed:-

No calibration for this function

Final Width = 215mm

10.2.6.2 Cal Mode Function Screens

Output-value control in the CAL mode of each function screen is essentially the same as for normal operation of the function. For example, the **x10** and **+10** softkeys respectively multiply and divide the currently displayed output value by 10, the \pm key changes the polarity of the output, and the **ZERO** key sets the output to zero. There is no 'Deviation' ($\Delta\%$) or 'Offset' (ΔV , $\Delta\Omega$ etc.) key, but there is a new softkey, which appears only in CAL mode, labelled **TARGET**.

In CAL mode, the purpose of the function screens is simply to allow you to set the 9100 into the various 'hardware configurations' required during calibration.

10.2.6.3 'Hardware Configurations'

Although all functions in the 9100 appear to the operator to have a single continuous range which covers the entire span of output values from the lowest value to the highest value (for example, for DC Voltage from -1050V to +1050V), the 9100 has internal devices such as voltage dividers and power amplifiers which must be switched in and out of its circuitry to achieve some parts of this total span. As each of these circuits is switched in or out, the 'hardware configuration' of 9100 therefore changes.

Because each of these circuits also introduces slight offset and gain errors into the 9100 output, these errors must be compensated in order to maintain the 9100's very high level of performance. Calibration of the 9100 allows the offset and gain errors associated with each 'hardware configuration' to be determined, so that they can be digitally compensated for by the instrument's embedded control microprocessor. The microprocessor does this by applying digital correction factors to the output value selected by the operator, so that the 9100's actual analog output accurately matches the selected value. The result is a highly accurate and linear output response across each function's entire output span.

Individual 'hardware configurations' are calibrated by accurately measuring their analog outputs at two or more points using a higher order calibration standard (for example, a long scale length 'standards laboratory' digital multimeter). In most cases these 'target calibration values' are values close to the negative and positive extremes of the hardware configuration's output capability (for example at -1000V and +1000V for the DC Voltage function when the power amplifier is switched in.)

Final Width = 215mm

10.2.7 Overview of Calibration Operations

In general, calibration of each of the 9100's hardware configurations' can be broken down into three distinct stages as follows:-

- 1) Selection of the required 'hardware configuration'
- 2) Selection of two or more 'target' values at which this hardware configuration will be calibrated.
- 3) Determination of the 9100's output error at each of these target values.

As mentioned earlier, the introductory **function screen** allows you to select the correct hardware configuration.

Pressing the **TARGET** softkey transfers you to the **targetselection** screen where you can opt to use Wavetek's recommended target calibration values or the target values used during the last calibration.

Selecting one of the target values displayed in the target selection screen (by pressing its corresponding **Factor** softkey) transfers you to the '**calibrate**' screen, where you can optionally alter the target value before measuring the output error and generating a compensating correction factor.

These three stages are described in more detail in *Section 10.3*, while descriptions of the calibration sequences for each individual function are provided in *Section 10.4*.

The flow chart shown opposite summarizes the operator actions needed to enter Calibration mode, and to then select an appropriate function for calibration.

Final Width = 215mm

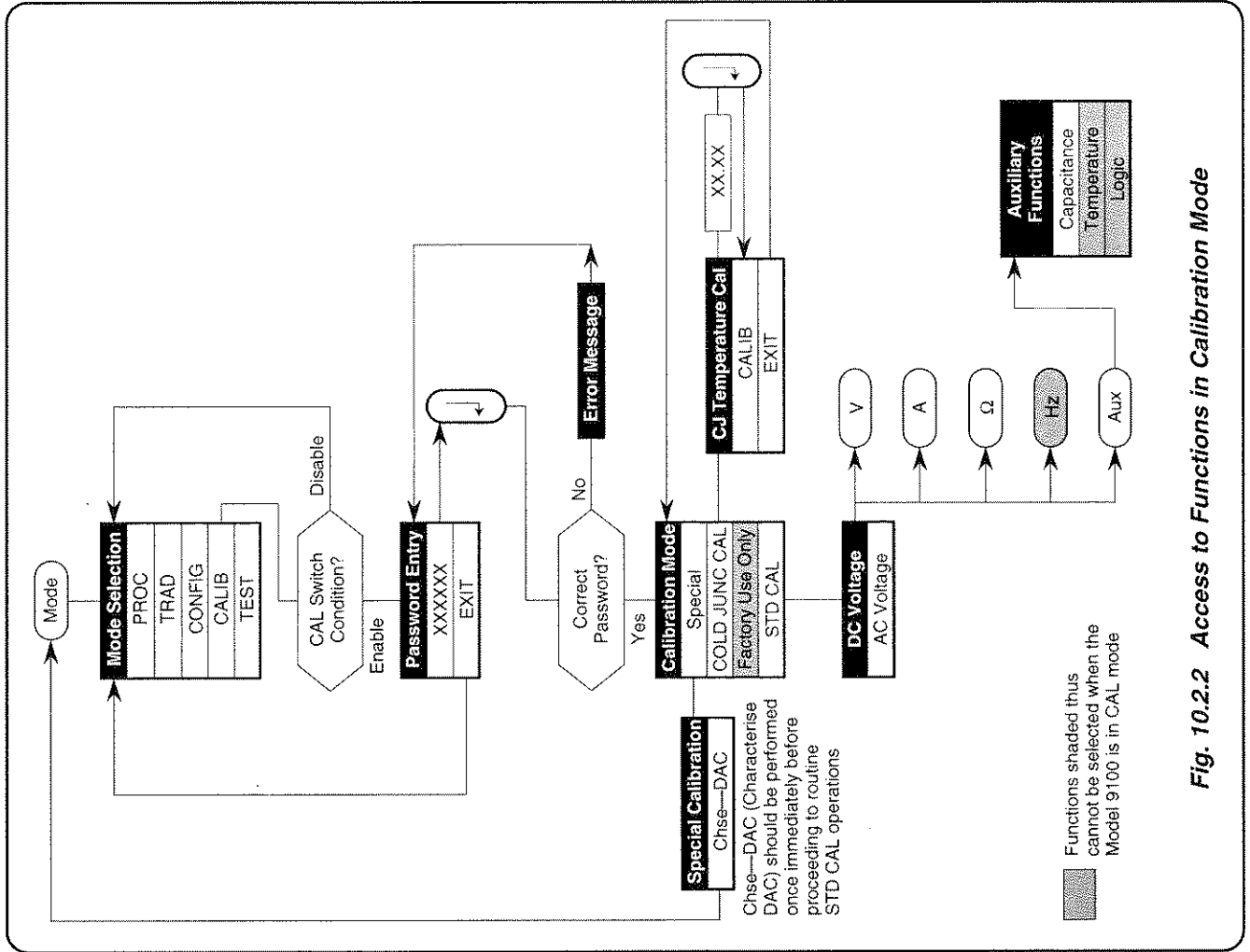

Fig. 10.2.2 Access to Functions in Calibration Mode

10.3 Standard Calibration — Basic Sequences

This sub-section describes in more detail the main processes involved when calibrating each of the Model 9100's 'hardware configurations' from the instrument's front panel.

The following topics are covered:

- 10.3.1 Introduction
 - 10.3.1.1 Aim of Calibration
 - 10.3.1.2 General Calibration Process
- 10.3.2 Selecting Hardware Configurations
- 10.3.3 Selecting Target Calibration Values
 - 10.3.3.1 The Target Selection Screen
 - 10.3.3.2 Using the Saved Calibration Targets
 - 10.3.3.3 Using the Default Calibration Targets
- 10.3.4 Calibrating the Model 9100 at Target Values
 - 10.3.4.1 The Calibration Screen
 - 10.3.4.2 Changing the Target Value
 - 10.3.4.3 Determining the Output Error at the Selected Target Value
 - 10.3.4.4 Calibration Errors
- 10.3.5 Standard Calibration of AC Functions
 - 10.3.5.1 Output Frequency Synthesis
 - 10.3.5.2 Changing the Output Frequency of Target Calibration Points
- 10.3.6 Exit from Calibration - Cal Date and Cal Due Date
 - 10.3.6.1 Exit: Mode Key — Warning Screen
 - 10.3.6.2 Exit Only
 - 10.3.6.3 Update the Date Stamp on a Certificate
 - 10.3.6.4 Setting the Cal Due Date and Advance Warning Period

Final Width = 215mm

10.3.1 Introduction

10.3.1.1 Aim of Calibration

The aim of calibrating the Model 9100 Universal calibrator is to determine the accuracy of its outputs, and if necessary adjust them so that they are within specification. If this calibration is to be traceable, then the 9100's outputs must be compared with calibration standards whose higher accuracy ('Test Uncertainty Ratio' at least 3:1 with respect to the 9100) has been traceably calibrated to National or International Standards.

10.3.1.2 General Calibration Process

As mentioned earlier in *Section 10.2*, calibrating each of the 9100's functions can be broken down into three distinct stages as follows:

- 1) Select the required hardware configuration.
- 2) Select target values at which this hardware configuration will be calibrated.
- 3) Determine the 9100's output error at each of these target values, and generate a suitable compensating correction factor.

This sub-section *10.3* describes the *general* process of calibrating the 9100 using front-panel controls.

To demonstrate this process, the following description uses, as an example, the 9100's DC Voltage hardware configuration which generates output voltages in the range -3.20000V to +0.32001V and from +0.32001V to +3.20000V. This hardware configuration requires two target-value calibration points, and two associated correction factors. The factors are stored in non-volatile memory, and subsequently used to correct all outputs which employ the hardware configuration.

We will start by assuming that the 'Cal' mode of the DC Voltage function has been selected as described in *Section 10.2* of this handbook. This presents a Cal mode function screen, similar to that illustrated opposite.

Final Width = 215mm

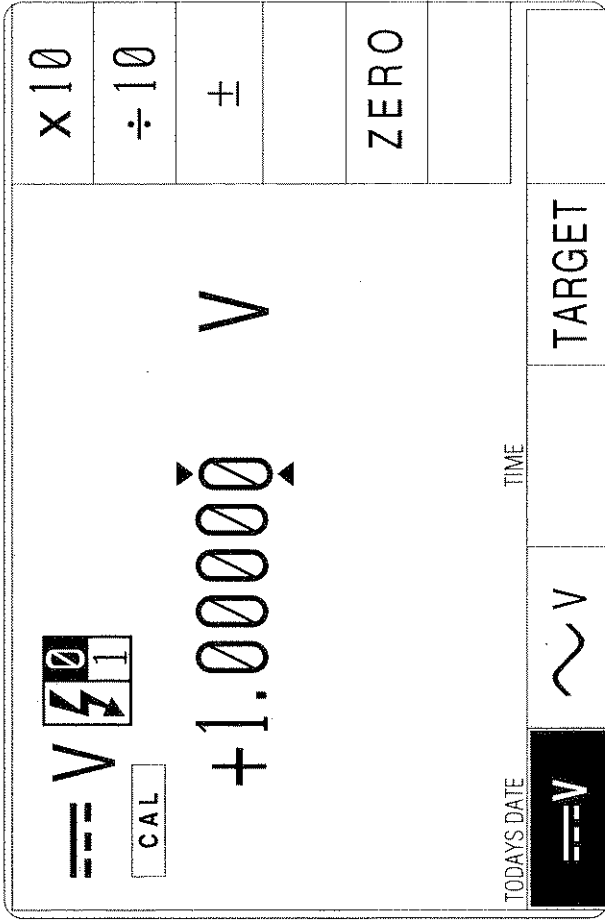

Final Width = 215mm

10.3.2 Selecting Hardware Configurations

For a given function, setting the 9100 output value selects the relevant hardware configuration which will generate the required span of the function's total output range.

For example, the total output range in DC Voltage is generated using five separate hardware configurations that generate the following spans:

1:	zero	to	±320.000 mV
2:	±0.32001 V	to	±3.20000 V
3:	±3.2001 V	to	±32.0000 V
4:	±32.001 V	to	±320.000 V
5:	±320.01 V	to	±1000 00V

Hence hardware configuration (1) can be selected by setting the output amplitude to any value in the range zero to ±320 mV, hardware configuration (2) by setting the output to any value in the range -3.20000 V to +0.32001 V or +0.32001 V to +3.20000 V etc..

Output control in the 'Cal' mode of the function screens is exactly the same as in normal operation of the 9100, being performed either by the digit edit method (cursor controls/spinwheel), the direct edit method (numeric keypad), or by use of the x10, +10, ± and ZERO softkeys. For further information see *Section 3.4 of the Model 9100 Universal Calibration System User's Handbook — Volume 1 — Operation.*

Final Width = 215mm

Suitable output values which can be used to establish all the required hardware configurations for each function are given in the detailed calibration procedures contained in *Section 10.4* of this handbook. Note that the initial output value of +1.00000V, provided in the introductory DC Voltage screen, puts the 9100 into the ±0.32001V to ±3.20000 V hardware configuration.

10.3.3 Selecting Target Calibration Values

10.3.3.1 The Target Selection Screen

Once the correct hardware configuration has been established by setting the 9100 output control display to a suitable output value, pressing the **TARGET** softkey will present a 'target selection' screen similar to that shown below. This screen shows those target values at which the selected hardware configuration was last calibrated, indicated by the "SAVED CALIBRATION TARGETS" title positioned above these target values.

		Factor 1
CAL	+1.00000 V	Factor 2
SAVED CALIBRATION TARGETS		
1 → -	3.05426	low
2 → +	3.05426	high
TODAYS DATE	TIME	
V	TARGET	DEFLT

Final Width = 215mm

The currently-selected output value (and, in the case of AC Voltage or AC Current the frequency value) is compressed to smaller characters, and the digit cursor is deactivated so that these values cannot be changed while this screen is presented.

Depending on the selected function and hardware configuration, the screen can display up to four target values, numbered sequentially from top to bottom. Also, the screen will show the same **number of Factor** keys, labelled **Factor 1**, **Factor 2**, **Factor 3** etc., plus an additional screen key labelled **DEFLT**.

At this point you have two options in selecting the target calibration points for use in calibrating this hardware configuration.

You can:-

- 1) use the same target points (the Saved Calibration Targets) at which this hardware configuration was last calibrated — see *Section 10.3.3.2*.
- 2) use default target points which are pre-programmed into the Model 9100's firmware — see *Section 10.3.3.3*.

Note that the 9100 also provides you with a third option, which is to change the existing calibration targets to new values. However, this option only becomes available when you move on to the **Calibration** screen — see *Section 10.3.4*.

At any time you can return to the introductory function screen by re-pressing the **TARGET** softkey.

10.3.3.2 Using the Saved Calibration Targets

To use the 'Saved Calibration Targets' displayed on the target selection screen, there is no need to modify that screen. All that is required, to select one of the displayed target values, is to press the corresponding **Factor** softkey (i.e. the **Factor 1** key to calibrate at target value one, the **Factor 2** key to calibrate at target value two, etc..)



This will transfer you to a '**Calibrate**' screen, which you can use to determine the output error, and correct it — see *Section 10.3.4*.

When you have finished calibrating one target value you will be returned to the function screen, from which you can:

either calibrate the remaining target values for the selected hardware configuration;
or select a new hardware configuration by changing the displayed output value.

10.3.3.3 Using the Default Calibration Targets

As mentioned earlier, the Model 9100's firmware contains a complete set of recommended target calibration values, for every hardware configuration of every function that can be directly calibrated. If you wish to use these 'default' values, rather than the values at which your 9100 was previously calibrated (assuming that the 'saved' and 'default' values are different), simply press the **DEFLT** (Default) softkey which appears in the target selection screen. The **Default Calibration Targets** for the selected hardware configuration will be displayed as shown below. Re-pressing the **DEFLT** will take you back to the display of **Saved Calibration Targets** — i.e. the **DEFLT** key toggles between the 'Saved' and 'Default' sets of target values.

		Factor
CAL		1
+1.00000 V		Factor
DEFLT CALIBRATION FACTORS		2
1 → -3.00000	low	
2 → +3.00000	high	
TODAYS DATE		
		
TARGET		DEFLT

Final Width = 215mm

To select one of the displayed 'default' target values for calibration, press the corresponding **Factor** softkey (i.e. the **Factor 1** key to calibrate at target value one, the **Factor 2** key to calibrate at target value two, etc..)

This will transfer you to a **Calibrate** screen, in which you can determine the output error and correct it — see [Section 10.3.4](#).

When you have finished calibrating one target value you will be returned to the function screen, from which you can:

either calibrate the remaining target values for the selected hardware configuration;
or select a new hardware configuration by changing the displayed output value.



Before deciding to change from 'Saved' calibration target values back to the 'Default' target values, consider that there may be good reasons for choosing values other than the default values at the previous calibration. Your organization's calibration standards may be uniquely characterized at particular target values (for example, three series connected standard cells which provide a calibration point voltage of $\pm 3.05426\text{V}$ rather than the default value of the $\pm 3.00000\text{V}$ for the $\pm 0.32001\text{V}$ to $\pm 3.20000\text{V}$ DC Voltage hardware configuration). Changing the default target values back to $\pm 3.00000\text{V}$ may reduce the usefulness of historical calibration records for this 9100 unit, if it normally uses $\pm 3.05426\text{V}$ as the target value.

Final Width = 215mm

10.3.4 Calibrating the Model 9100 at Target Values

10.3.4.1 The Calibration Screen

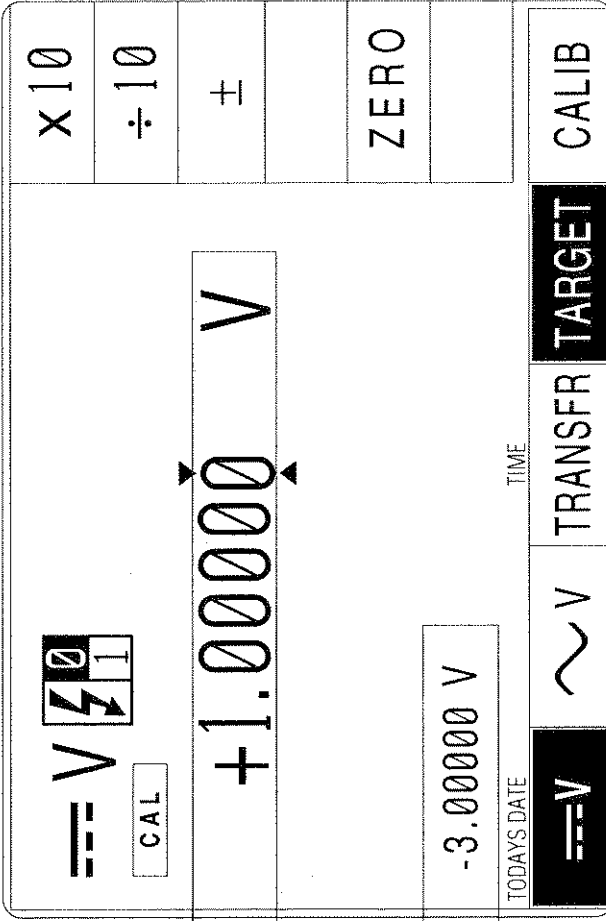
Pressing a **Factor** key on the 'target selection' screen presents the 'Calibration' screen. The resultant screen for **Factor 1** of the DC Voltage, $\pm 0.32001V$ to $\pm 3.20000V$ hardware configuration is shown below, using the default target value of $-3.00000V$. Note that the output value of $1.00000V$ remains displayed, (this appeared on first entering Cal mode, and was then used to place the 9100 into the correct hardware configuration). A smaller-sized version of the selected factor's target value appears in the lower left corner:

OUTPUT CONTROL VALUE		$\times 10$ $\div 10$ \pm ZERO
TARGET VALUE	-3.00000 V	TODAY'S DATE 

Final Width = 215mm

CAUTION! Do not press the **CALIB** softkey while using the **Calibrate** screen unless you are sure that you wish to perform an authorized recalibration of the selected hardware configuration at the selected target value. To prevent accidental calibrations taking place due to inadvertent use of the **CALIB** key, and for your own safety, it is best to carry out all hardware configuration, target value selection and initial use of the calibrate screen with the 9100 output **OFF**. If you accidentally press the **CALIB** key, or attempt a calibration without first turning the 9100 output on, the following error message will be shown:

Output must be ON for CAL

Under output-off conditions, the existing, stored calibration corrections will remain unchanged.

10.3.4.2 Changing the Target Value

As mentioned earlier, in addition to selecting either:

- the previously-saved calibration target values *or*
 - default calibration targets,
- a new target value can be defined. This is achieved on the Calibrate screen, for the selected factor, by editing the target value.

To do this, first transfer cursor control to the target value displayed in the lower left of the screen by pressing the Tab \leftarrow key. (Note: the Tab \leftarrow key moves the cursor between alternate fields, so that re-pressing it will return cursor control to the output amplitude control display.)

With the cursor on the displayed target value, you can now alter the target value using digit or direct edit employed in normal operation — (*Model 9100 Universal Calibration System User's Handbook, Volume 1, Operation, Section 3, sub-section 3.4*).

Note that although the **x10**, **÷10** and \pm softkeys remain active, pressing them will always result in the error message:

Target too big or Target too small

being displayed, as they would move the value out of the permissible target range. Pressing the **ZERO** softkey will also produce this error message, unless the default target value is already zero (as would be the case, for example, for Factor 1 of the DC Voltage, 0V to $\pm 320.000\text{mV}$ hardware configuration).

Final Width = 215mm

10.3.4.3 Determining the Output Error at the Selected Target Value

The output error of the 9100 is determined by connecting a suitable measuring instrument to the calibrator's front-panel terminals to measure the actual analog output value, then determining the difference between this measured value and the selected target value.

N.B. The chosen measuring instrument must have an absolute accuracy considerably better than the accuracy specification of the 9100. (For information on suitable measuring equipment see *Appendix 10-A1* at the end of *Section 10* in this handbook.)

The process of calibrating the 9100 will correct this output error. The procedure has 3 stages:

1. Set the displayed output value (output control value) to the target value by pressing the **TRANSFR** (Transfer) key, then turn the calibrator output **ON**.
2. Increment or decrement the calibrator output using the cursor controls and/or spinwheel until the externally measured value is equal to the target value displayed in the lower left corner of the 9100 screen.
3. Press the **CALIB** (Calibrate) screen key.

The 9100 reverts to show a function screen with the displayed output value equal to the target value, and both equal to the externally-measured output value (to within normal measurement errors; e.g. within noise limits). The 9100 is now calibrated at that Factor's target value, and the corresponding (digital) correction value has been stored in non-volatile RAM.

This correction factor is derived from the amount that the output value had to be incremented or decremented in stage (2) of the calibration process, in order to obtain an external measurement equal to the target value (a measure of the output error before calibration).

In order to correct the full span of values generated by the hardware configuration, the calibration process is repeated for each of the configuration's 'Factors', and the corresponding corrections are stored. Subsequently, when in normal operation, the 9100 applies all the stored correction factors to the output in proportions determined by an internal algorithm; ensuring that the hardware configuration generates outputs which are all within the accuracy specification.

After a successful calibration of the 9100 at a target calibration value, the new target value will replace the corresponding old target value in the 'SAVED CALIBRATION FACTORS' display. Note that on the target selection screen the target value will change only if the new and the old target values were different.

Final Width = 215mm

10.3.4.4 Calibration Errors

In stage (2) of the calibration procedure, the output of the 9100 is incremented or decremented by the necessary amount to obtain a measured output equal to the target value. In the process, a condition may arise which prevents generation of a suitable correction factor, due to predefined internal limits for that 'Factor' being exceeded. If this is the case, the error message:

Amplitude outside limits

will be displayed when you press the **CALIB** screen key, and the previously-stored calibration correction for this target value will remain unaltered.

The predefined limits, programmed into the 9100 firmware, are sufficiently wide to cope with all normal output errors likely to arise during recalibration. If the above error message appears, it will probably be due to one of two causes:-

1. the Model 9100 has developed a fault.
2. the measuring instrument has developed a fault, is incorrectly set up, or is incorrectly connected to the Model 9100's terminals.

The cause should be determined and rectified before proceeding.

Final Width = 215mm

10.3.5 Standard Calibration of AC Functions

Standard calibration of the AC Voltage and AC Current functions in the 9100 uses the same procedure as that described in Sections 10.3.1 to 10.3.4 of this section except that the frequency of the target calibration points must also be set.



10.3.5.1 Output Frequency Synthesis

The frequency of the Model 9100's AC Voltage and AC Current outputs is derived digitally from an internal reference frequency crystal, which is sufficiently stable for the output frequencies of these functions not to require any routine calibration throughout the lifetime of the instrument. Option 100 introduces an alternative, high-stability reference crystal.

10.3.5.2 Changing the Output Frequency of Target Calibration Points.

When you display target selection screens for AC functions (by pressing the **TARGET** screen key while in the Cal mode of the function screen), you will notice that the Saved Calibration Targets and Default Calibration Targets all include a target calibration point frequency. As an example, the default calibration targets for the AC Voltage 0.32001 V to 3.20000 V, 0.0100 kHz to 3.2000 kHz hardware range are illustrated in the screen shown below.

Final Width = 215mm

		Factor 1
CAL 1.00000 V 1.0000 kHz		Factor 2
DEFAULT CALIBRATION TARGETS 1 → 3.00000 V 1.0000 kHz flat 2 → 3.00000 V 30.0000 kHz flat 3 → 3.00000 V 100.0000 kHz flat		Factor 3
TODAYS DATE	TIME	
		TARGET
		DEFLT

When you select one of these calibration points by pressing its corresponding **Factor** key, the target calibration point voltage and frequency will be displayed below the current output voltage and frequency settings as shown in the following screen illustration.

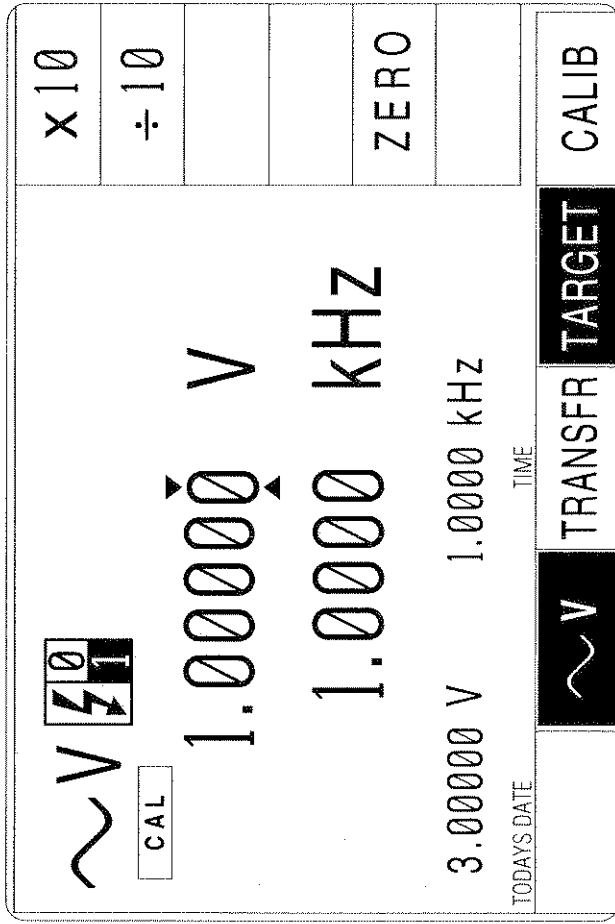

Final Width = 215mm

You should now set the current output voltage and frequency settings to the target values by pressing the **TRANSFER** softkey, as you would when calibrating any other function. If you now wish to change the calibration point frequency, this must be done by directly editing the output frequency setting, **not** by editing the displayed target frequency.

To do this you must first transfer cursor control to the displayed output frequency setting by pressing the Tab key. (Note: depending on the current position of the digit cursor you may need to press the Tab key one or two times to shift it to the output frequency setting.) You can now alter the frequency setting using the same digit edit (cursor controls/spinwheel) method or direct edit (numeric keypad) method used to change frequency values in normal operation of the Model 9100 — see Section 3.4 of the *Model 9100 Universal Calibration System User's Handbook — Volume 1 — Operation*.

Note that although the **x10** and **+10** softkeys remain active, pressing them will always result in the error message:

Frequency too big or **Frequency too small**

being displayed, as they would move the target frequency out of the permissible range.

You can now continue with the calibration as detailed in *Section 10.3.4.3.-stage 2*.

Final Width = 215mm

10.3.6 Exit from Calibration - Cal Date and Cal Due Date

Once all calibration has been completed, you will wish to return to normal operation, which requires a short 'exit' process. The normal means of exit from Calibration mode is to press the **Mode** key on the right of the front panel. When you do this, the 9100 will present a **Warning** screen to indicate that the 9100 calibration may have changed, and to offer you the following options:

- altering the date-stamp on any directly-printed results certificate (or not),
- entering or altering the calibration due date,
- indicate the advance warning period required before the cal due date.

The following paragraphs show the screens, required actions and consequences.

10.3.6.1 Exit: Mode Key — Warning Screen

To exit from Calibration, press the **Mode** key on the right of the front panel. The 9100 will present a 'Warning' display on the screen:

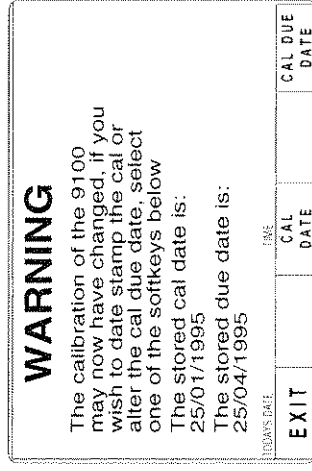

10.3.6.2 Exit Only

If you do not wish to alter the date-stamp, and do not wish to alter the cal due date or its advance warning period, press the **EXIT** key. This terminates the calibration session, and you will be returned to the **Mode Selection** screen to select another mode.

10.3.6.3 Update the Date Stamp on a Certificate

If you wish to update the date stamp to today's date, press the **CAL DATE** key.

The 9100 presents the Cal Date screen →

The alpha-numeric keypad is locked out.

If updating the date-stamp is all that is required, without altering the due date, press the **EXIT** screen key to return to the **Mode Selection** screen.

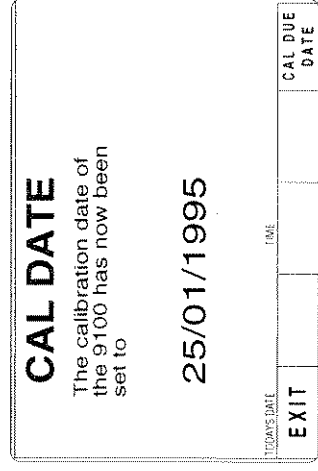

10.3.6.4 Setting the Cal Due Date and Advance Warning Period

N.B. If these parameters are not altered, those parameters which are already stored will be presented on any directly-printed certificate.

To alter the CAL DUE date, press the **CAL DUE DATE** key. The 9100 will present the CAL DUE DATE screen → This screen also displays the stored CAL DATE as a reminder when calculating the cal due date.

CAL DUE DATE		7 DAYS
Change the date by using direct editing only.		14 DAYS
Present due date warning period is highlighted.		30 DAYS
The stored cal date is:		60 DAYS
25/01/1995		
25/04/1995		
EXIT	CAL DATE	CAL DUE DATE

If you change your mind and do not wish to update the **CAL DUE DATE**, press the **EXIT** screen key.

Setting the Cal Due Date

To set a new **CAL DUE DATE**, use the alpha-numeric keypad to type in the required due date, then press the Enter (↵) key. Note that the screen presentation is couched in the 'DATE TIME' format set in Configuration mode, and should be observed when entering the date, otherwise the advance warning period could be calculated from an incorrect date! — refer to *User's Handbook Volume 1, Section 3, paras 3.3.2.10*.

Advance Warning Period

In order to inform a user that the future due date for calibration is approaching, the 9100 will place a warning on the screen, starting at a period of time before the due date. During normal use, a suitable message will appear in a comment box at the top of the screen, after the warning is due, on three types of occasion:

- Every time the 9100 is powered on;
- Every function change into DC Voltage function;
- Every function change into AC Voltage function.

Setting the Advance Warning Period

During the exit process from Calibration mode, the present setting of the number of days in advance of the due date appears on the screen above, shown highlighted against one of the right screen keys. This period can be altered by pressing the appropriate right screen key.

Final Exit from Calibration Mode

When you are satisfied that the **CAL DUE DATE** and advance warning period are correct, press the **EXIT** screen key to terminate calibration and return to the **Mode Selection** screen.

The stored Cal Date and Cal Due Date will appear on any directly-printed certificate for this calibration.

10.4 Front Panel Calibration by Functions

10.4.1 Introduction

Sub-section 10.4 is a guide to the process of calibrating the Model 9100's functions from the front panel. The following topics are covered:

- 10.4.2 Summary of Calibration Process
 - 10.4.2.1 General Procedure
 - 10.4.2.2 Sequencing Calibrations
- 10.4.3 DC Voltage Calibration
- 10.4.4 AC Voltage Calibration
- 10.4.5 DC Current Calibration
- 10.4.6 AC Current Calibration
- 10.4.7 Resistance Calibration
- 10.4.8 Capacitance Calibration

Other Functions

No calibration is required for the following functions, as they are either calibrated for life at manufacture, or calibrated automatically as a result of calibrating the functions listed above, as shown in the table:

Function	Calibration Performed
Capacitance	optionally via Resistance
Conductance	via Resistance
Frequency	at manufacture
Mark/Period	at manufacture
% Duty	at manufacture
Temperature - Thermocouple	via DC Voltage
Temperature - RTD	via Resistance
Logic Pulses	at manufacture
Logic Levels	via DC Voltage

For functions other than capacitance (which can either be calibrated directly or calibrated via Resistance) there are therefore no calibration procedures, although confidence checks for them can be performed (e.g. the Full Selftest procedure detailed in Section 8, sub-section 8.3).

CJC Pod Calibration

Calibration of the CJC Pod (the external module which contains the Reference Junction on its iso-thermal block for use with the Thermocouple function) is purely ratiometric, and not dependent on the STD CAL of any function. The calibration should be performed annually, close to the time of STD CAL. The CJC Pod calibration procedure can be found in this section 10; sub-section 10.2.5.

Final Width = 215mm

10.4.2 Summary of Calibration Process

10.4.2.1 General Procedure

Subsections 10.2 and 10.3 introduced the general calibration process for the Model 9100, described how to select and perform the 'Characterise DAC' special calibration operation, and how to calibrate the CJC Pod temperature monitor for the Reference Junction. They also outlined the methods used to select functions, hardware configurations and target calibration points, and how to calibrate the 9100 at these target points.

This entire process is outlined again here as a sequence of simple steps:-

1. Ensure that the 9100 output is **OFF**.
2. Connect the necessary measuring equipment to the 9100's output terminals, and set it to the required measurement function and range.
3. Ensure that the rear-panel **CAL** (Calibration) switch is set to the **ENABLE** position.
4. Press the front panel **Mode** key to display the **Mode Selection** screen.
5. Press the **CALIB** screen key to display the **Password Entry for Calibration** screen.
6. Enter the correct password and press the  key to display the **Calibration Mode** screen.
7. Press the **Special** screen key to display the **Special Calibration** screen.
8. Press the **Chse-DAC** screen key to initiate the Characterise DAC operations and wait until these automatic internal adjustments have been successfully completed. This process will take approximately 20 minutes to complete.

IMPORTANT NOTE: The Characterise DAC operation should be performed once only, immediately before performing Standard Calibration of the 9100. It should **not** be repeated before calibrating each individual function of the 9100.

9. Press the front panel **Mode** key to display the **Mode Selection** screen.
10. Press the **CALIB** screen key to display the **Password Entry for Calibration** screen.
11. Re-enter the appropriate password and press the  key to display the **Calibration Mode** screen.
12. Press the **STD CAL** screen key to see the Standard Calibration initial default screen — the **DC Voltage** function screen.

Final Width = 215mm

13. Standard Calibration can only be carried out for the following functions:

- DC Voltage
- AC Voltage
- DC Current
- AC Current
- Resistance
- Capacitance

If you are calibrating a function other than DC Voltage, select the required function to see its corresponding function screen. (For selection method, refer to the Model 9100 Universal Calibration System User's Handbook — Volume 1 — Operation, Section 4, subsections 4.4 [ACV], 4.5 [DC Current], 4.6 [AC Current], 4.7 [Resistance] and 4.13 [Capacitance].)

14. Select the required hardware configuration by setting the 9100 output to a value that uses the hardware configuration. (Details of each function's hardware configurations and suitable output values to select them can be found in the detailed procedures provided later in this section.)

15. Press the **TARGET** screen key to display the hardware configuration's target selection screen.

16. a) If you wish to use the target calibration points used during the previous calibration of the 9100, press the **Factor** screen key corresponding to the required target value, which will display a 'calibrate' screen for the target value.

b) If you wish to use the default target calibration points defined for this hardware configuration, press the **DEFLT** screen key and then press the **Factor** screen key corresponding to the required target value, which will display a calibrate screen for the target value.

17. If you wish to change the amplitude of the target calibration point, press the **TAB** key one or more times until the cursor is positioned on the target value amplitude. Now use any of the 9100's normal editing modes to change this value. (Note that the new value must lie within the limits specified in the detailed procedures provided later in this section.)

18. Press the **TRANSFER** screen key to transfer the target calibration point values (amplitude or amplitude and frequency) to the 9100's output control displays.

Final Width = 215mm

continued overleaf

10.4.3.4 Calibration Setup

- Connections** Ensure that the 9100 is connected to the Standards DMM as shown in Fig. 10.4.3.1, and that both instruments are powered on and warmed up.
- 9100** Ensure that the 9100 is in STANDARD CAL mode and then select the DC Voltage function by pressing the 'V' key on the right of the front panel.

Final Width = 215mm

Table 10.4.3.1: DC Voltage (Zero to 320V) Hardware Configurations and Calibration Points

Output span covered by hardware configuration	Suitable output to select hardware configuration	Calibration Targets			Factor Number
		Default	Minimum	Maximum	
000.000mV to ± 320.000 mV	100mV	000.000mV	-0.080mV	10.000mV	1
		+300.000mV	180.000mV	320.000mV	2
± 0.32001 V to ± 3.20000 V	1V	-3.00000V	-3.20000V	-1.80000V	1
		+3.00000V	+1.80000V	+3.20000V	2
± 3.2001 V to ± 32.0000 V	10V	-30.0000V	-32.0000V	-18.0000V	1
		+30.0000V	+18.0000V	+32.0000V	2
± 32.001 V to ± 320.000 V	100V	-300.000V	-320.000V	-180.000V	1
		+300.000V	+180.000V	+320.000V	2

Table 10.4.3.2: DC Voltage (320V to 1050V) Hardware Configurations and Calibration Points

Output span covered by hardware configuration	Suitable output to select hardware configuration	Calibration Targets			Factor Number
		Default	Minimum	Maximum	
± 320.01 V to ± 1050.00 V	1000V	-1000.00V	-1050.00V	-700.00V	1
		+1000.00V	+700.00V	+1050.00V	2

10.4.3.5 Calibration Procedure

1. Select the required hardware configuration by setting the 9100 output to a suitable value that uses the hardware configuration.
2. Set the Standards DMM to the appropriate measurement range.
3. Press the 9100's **TARGET** screen key to display the hardware configuration's target selection screen.
4. Use (a) or (b):
 - a. To use the target calibration points used during the *previous calibration* (indicated by the displayed **SAVED CALIBRATION TARGETS**), press the **Factor** screen key corresponding to the required target value, to display a 'calibrate' screen for the target value.
 - b. To use the *default* target calibration points defined for this hardware configuration, press the **DEFLT** screen key and then press the **Factor** screen key corresponding to the required target value, to display a 'calibrate' screen for the target value.
5. To change the amplitude of the target calibration point, press the **TAB** key to position the cursor on the target value amplitude. Now use any of the 9100's normal editing modes to change this value. (Note that the new value must lie within the minimum and maximum limits specified in the tables opposite)
6. Press the **TRANSFR** screen key to transfer the target calibration point value to the 9100's output control display.
7. Press the **ON** key to turn the 9100 output on.
8. Press the **TAB** key to return the cursor to the 9100 output amplitude display, and increment or decrement this value using the cursor controls and/or spinwheel until the reading on the Standards DMM connected to the 9100 front-panel terminals is the same as the displayed target value. (Note: make sure to allow for any settling time required by the external measuring instrument.)
9. When you are satisfied with the measurement, press the **CALIB** key to generate and implement the correction factor required by the 9100, to ensure that its displayed output value and actual output value coincide. The screen will revert to the **CAL** mode of the normal function screen, and the measured value should now be equal to the displayed output value.
10. Press the **OFF** key to turn the 9100 output off.
11. Repeat steps (2) to (10) for each of the target values displayed in the target selection screen.
12. Repeat steps (1) to (11) for each of the hardware configurations detailed in the tables opposite (also see note below).

Note: If other functions are being calibrated in addition to DC Voltage, refer to *Table 10.4.2.1 on page 10.4.5* for information on sequencing calibrations.

Final Width = 215mm

10.4.3.6 Calibration of Auxiliary DC Voltage (for Power Option)

Calibration Setup

1. **Connections** Ensure that the 9100 is connected to the Standards DMM as shown in *Fig. 10.4.3.2*, and that both instruments are powered on and warmed up.
2. **9100** Ensure that the 9100 is in STANDARD CAL mode and then select Power and DC Volts by pressing the front-panel **AUX** key followed by the softkey sequence **POWER***, **===W^{CHANNEL}**, **VOLTAGE**. Refer also to *Fig. 10.2.2*.

* This keystroke is only required if one of the oscilloscope calibration options (Option 250 or Option 600) is fitted.

Final Width = 215mm

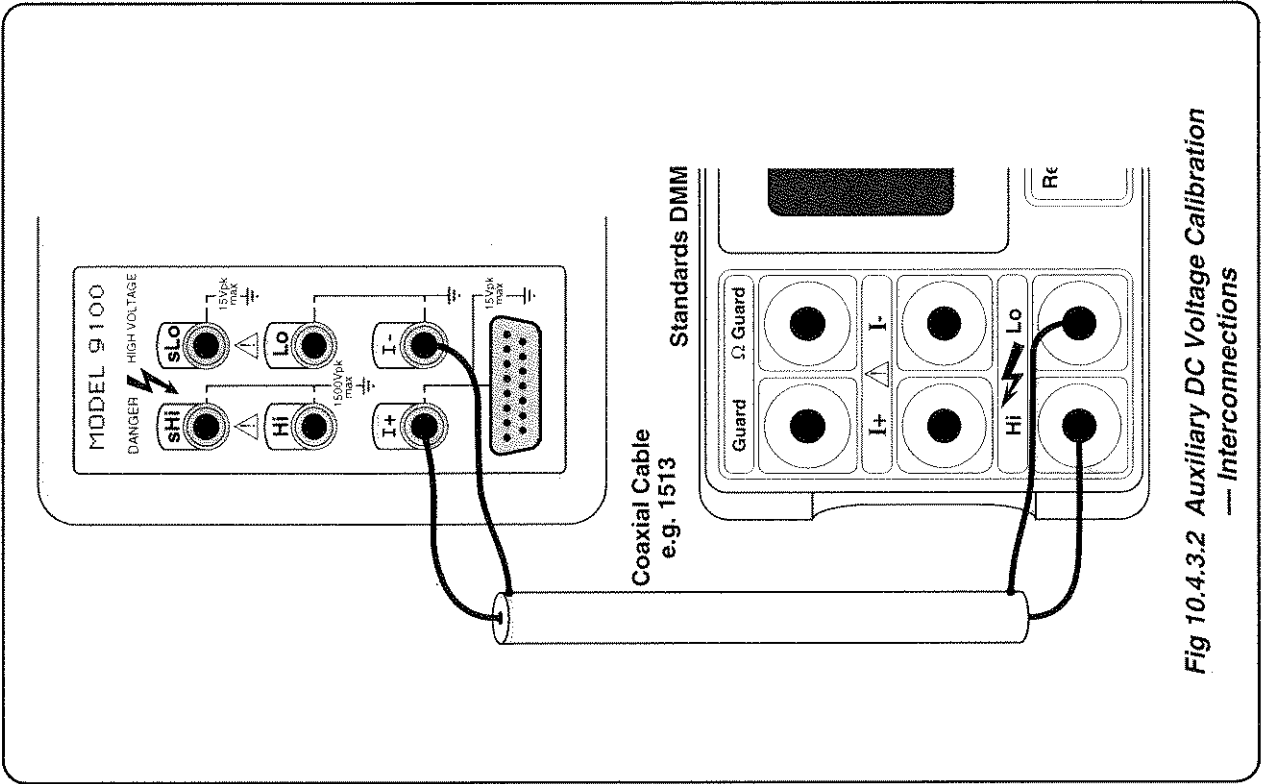

Fig 10.4.3.2 Auxiliary DC Voltage Calibration
 --- Interconnections

Final Width = 215mm

Table 10.4.3.3: Auxiliary DC Voltage Calibration Points

Hardware Spans	Calibration Targets		
	Default	Minimum	Maximum
0.000 to 32.00mV	-30.00000mV +30.00000mV	-32.00000mV +18.00000mV	-18.00000mV +32.00000mV
32.1mV to 320.0mV	-300.0000mV +300.0000mV	-320.0000mV +180.0000mV	-180.0000mV +320.0000mV
0.321V to 3.200V	-3.00000V +3.00000V	-3.20000V +1.80000V	-1.80000V +3.20000V
3.201V to 7.500V	-6.00000V +6.00000V	-6.50000V +4.00000V	-4.00000V +6.50000V

Final Width = 215mm

Calibration Procedure

1. Select the required hardware configuration by setting the 9100 output to a suitable value that uses the hardware configuration.
2. Set the Standards DMM to the appropriate measurement range.
3. Press the 9100's **TARGET** screen key to display the hardware configuration's target selection screen.
4. Use (a) or (b):
 - a. To use the target calibration points used during the *previous calibration* (indicated by the displayed **SAVED CALIBRATION TARGETS**), press the **Factor** screen key corresponding to the required target value, to display a 'calibrate' screen for the target value.
 - b. To use the *default* target calibration points defined for this hardware configuration, press the **DEFLT** screen key and then press the **Factor** screen key corresponding to the required target value, to display a 'calibrate' screen for the target value.
5. To change the amplitude of the target calibration point, press the **TAB** (↔) key to position the cursor on the target value amplitude. Now use any of the 9100's normal editing modes to change this value. (Note that the new value must lie within the minimum and maximum limits specified in the tables opposite)
6. Press the **TRANSFR** screen key to transfer the target calibration point value to the 9100's output control display.
7. Press the **ON** key to turn the 9100 output on.
8. Press the **TAB** (↔) key to return the cursor to the 9100 output amplitude display, and increment or decrement this value using the cursor controls and/or spinwheel until the reading on the Standards DMM connected to the 9100 front-panel terminals is the same as the displayed target value. (Note: make sure to allow for any settling time required by the external measuring instrument.)
9. When you are satisfied with the measurement, press the **CALIB** key to generate and implement the correction factor required by the 9100, to ensure that its displayed output value and actual output value coincide. The screen will revert to the **CAL** mode of the normal function screen, and the measured value should now be equal to the displayed output value.
10. Press the **OFF** key to turn the 9100 output off.
11. Repeat steps (2) to (10) for each of the target values displayed in the target selection screen.
12. Repeat steps (1) to (11) for each of the hardware configurations detailed in the tables opposite (also see note below).

Note: If other functions are being calibrated in addition to DC Voltage, refer to *Table 10.4.2.1 on page 10.4-5* for information on sequencing calibrations.

Final Width = 215mm

10.4.4 AC Voltage Calibration

10.4.4.1 Introduction

This section is a guide to calibrating the Model 9100 AC Voltage Function using its front panel controls. The following topics are covered:

- 10.4.4.2 Calibration Equipment Requirements
- 10.4.4.3 Interconnections
- 10.4.4.4 Calibration Setup
- 10.4.4.5 Calibration Procedure

10.4.4.2 Calibration Equipment Requirements

A traceably characterized, long scale-length, Standards DMM connected to the Model 9100 output terminals by a short, high-quality coaxial cable. For example, a Wavetek Model 1281 Digital Multimeter.

10.4.4.3 Interconnections

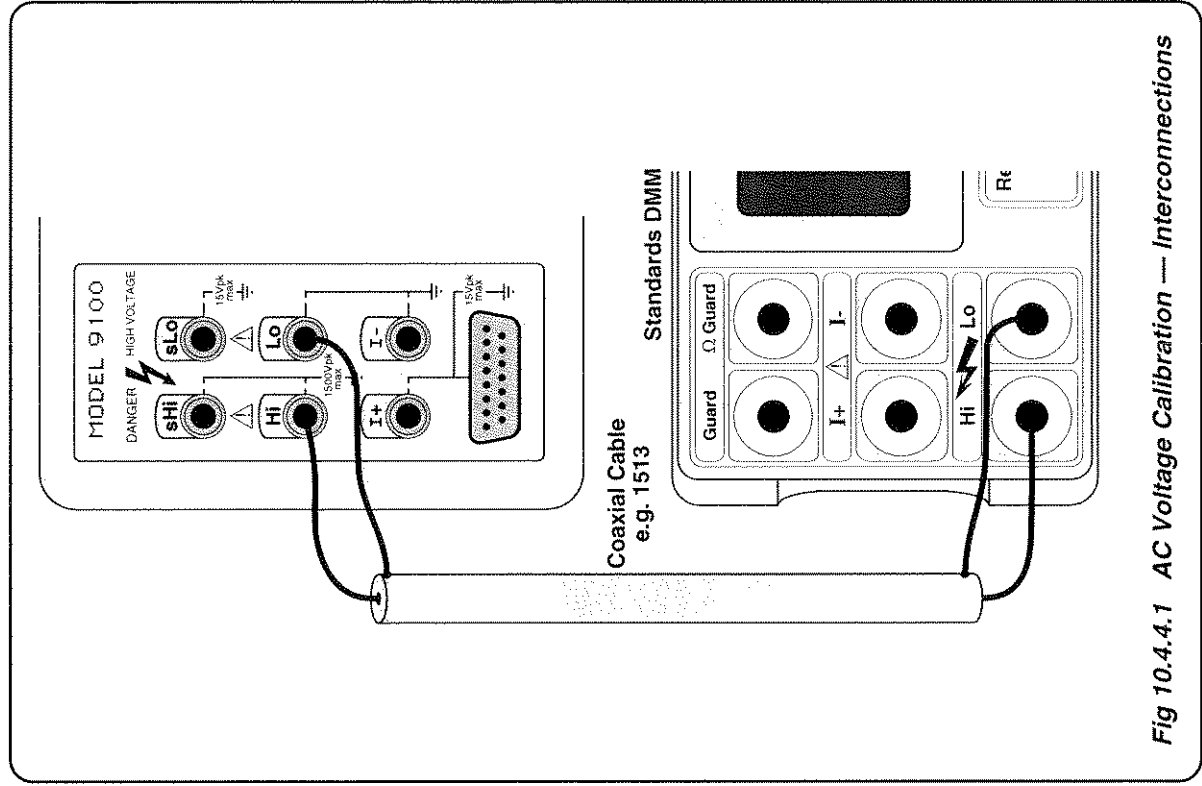

Fig 10.4.4.1 AC Voltage Calibration — Interconnections

10.4.4.4 Calibration Setup

1. **Connections** Ensure that the 9100 is connected to the Standards DMM as shown in Fig. 10.4.4.1, and that both instruments are powered on and warmed up.
 - a. Ensure that the 9100 is in STANDARD CAL mode and then select the AC Voltage function by pressing the 'V' key on the right of the front panel, followed by pressing the ΔV screen key adjacent to the display.
 - b. Ensure that *Sinusoidal* waveshape is *selected*, and that the *Phase* facility is *deselected* ($\Delta\Phi$ label dark lettering on light background).
2. **9100**

Table 10.4.4.1: AC Voltage (Zero to 320V) Hardware Configurations and Calibration Points

Output span covered by hardware configuration	Output to select hardware config.	Calibration Targets									Factor Number
		Amplitude			Frequency						
		Default	Minimum	Maximum	Default	Minimum	Maximum				
000.000mV to 320.000mV	100mV	300.000mV	180.000mV	320.000mV	1.0000kHz	150.00Hz	5.000kHz	1			
		300.000mV	180.000mV	320.000mV	30.000kHz	15.000kHz	45.00kHz	2			
		300.000mV	180.000mV	320.000mV	100.00kHz	65.00kHz	100.00kHz	3			
0.32001V to 3.20000V	1V	3.00000V	1.80000V	3.20000V	1.0000kHz	150.00Hz	5.000kHz	1			
		3.00000V	1.80000V	3.20000V	30.000kHz	15.000kHz	45.00kHz	2			
		3.00000V	1.80000V	3.20000V	100.00kHz	65.00kHz	100.00kHz	3			
3.2001V to 32.0000V	10V	30.0000V	18.0000V	32.0000V	1.0000kHz	150.00Hz	5.000kHz	1			
		30.0000V	18.0000V	32.0000V	30.000kHz	15.000kHz	45.00kHz	2			
		30.0000V	18.0000V	32.0000V	100.00kHz	65.00kHz	100.00kHz	3			
32.001V to 105.000V	100V	100.000V	70.000V	105.000V	1.0000kHz	150.00Hz	5.000kHz	1			
		100.000V	70.000V	105.000V	30.000kHz	15.000kHz	45.00kHz	2			
		100.000V	70.000V	105.000V	100.00kHz	65.00kHz	100.00kHz	3			
105.001V to 320.000V	150V	300.000V	180.000V	320.000V	40.00Hz	40.00Hz	75.00Hz	1			
		300.000V	180.000V	320.000V	200.00Hz	150.00Hz	250.00Hz	2			
		300.000V	180.000V	320.000V	10.000kHz	3.0000kHz	20.000kHz	3			
		300.000V	180.000V	320.000V	30.000kHz	25.000kHz	30.000kHz	4			

Table 10.4.4.2: AC Voltage (320V to 1050V) Hardware Configurations and Calibration Points

Output span covered by hardware configuration	Output to select hardware config.	Calibration Targets									Factor Number
		Amplitude			Frequency						
		Default	Minimum	Maximum	Default	Minimum	Maximum				
320.01V to 1050.00V	500V	750.00V	700.00V	1050.00V	40.00Hz	40.00Hz	75.00Hz	1			
		750.00V	700.00V	1050.00V	200.00Hz	150.00Hz	250.00Hz	2			
		750.00V	700.00V	1050.00V	10.000kHz	3.0000kHz	20.000kHz	3			
		330.00V	320.10V	350.00V	30.000kHz	25.000kHz	30.000kHz	4			

10.4.4.5 Calibration Procedure

1. Select the required hardware configuration by setting the 9100 output to a suitable value that uses the hardware configuration.
 2. Set the Standards DMM to the appropriate measurement range.
 3. Press the 9100's **TARGET** screen key to display the hardware configuration's target selection screen.
 4. Use (a) or (b):
 - a. To use the target calibration points used during the previous calibration (as indicated by the displayed **SAVED CALIBRATION TARGETS**), press the **Factor** screen key corresponding to the required target value to display a calibrate screen for the target value.
 - b. To use the default target calibration points defined for this hardware configuration, press the **DEFLT** screen key and then press the **Factor** screen key corresponding to the required target value to display a calibrate screen for the target value.
 5. To change the amplitude of the target calibration point, press the **TAB** key one or more times until the cursor is positioned on the target value amplitude. Now use any of the 9100's normal editing modes to change this value. (Note that the new value must lie within the minimum and maximum limits specified in the tables opposite.)
 6. Press the **TRANSFER** screen key to transfer the target calibration point amplitude and frequency to the 9100's output control display.
 7. If you wish to change the target calibration point frequency, press the **TAB** key one or more times until the cursor is positioned on the output frequency control display. Now use any of the 9100's normal editing modes to change this frequency value. (Note that the new value must lie within the limits specified in the tables opposite.)
 8. Press the **ON** key to turn the Model 9100 output on.
 9. Ensure that cursor control is returned to the 9100 output amplitude display, and increment or decrement this value using the cursor controls and/or spinwheel until the reading on the Standards DMM connected to the 9100 front-panel terminals is the same as the displayed target value. (Note: make sure to allow for any settling time required by the external measuring instrument.)
 10. When you are satisfied with the measurement, press the **CALIB** key to generate and implement the correction factor required by the 9100 to ensure that its displayed output value and actual output value coincide. The screen will revert to the **CAL** mode of the normal function screen, and the measured value should now be equal to the displayed output value.
 11. Press the **OFF** key to turn the Model 9100 output off.
 12. Repeat steps (2) to (11) for each of the target values displayed on the target selection screen.
 13. Repeat steps (1) to (11) for each of the hardware configurations detailed in the tables opposite (also see the note below).
- Note:** If other functions are to be calibrated in addition to AC Voltage, refer to *Table 10.4.2.1 on page 10.4-5* for information on sequencing calibrations.

10.4.4.6 Calibration of Auxiliary AC Voltage (for Power Option)

Calibration Setup

- Connections** Ensure that the 9100 is connected to the Standards DMM as shown in Fig. 10.4.3.2, and that both instruments are powered on and warmed up.
- 9100** Ensure that the 9100 is in STANDARD CAL mode and then select Power and AC Volts by pressing the front-panel **AUX** key followed by the softkey sequence **POWER***, **~**, **W**, **CHANNEL**, **VOLTAGE**. Refer also to Fig. 10.2.2.

* This keystroke is only required if one of the oscilloscope calibration options (Option 250 or Option 600) is fitted.

Table 10.4.4.3: Auxiliary AC Voltage Calibration Points

Hardware Spans	Calibration Targets							
	Level				Frequency			
	Default	Minimum	Maximum	Default	Minimum	Maximum		
0.000mV to 3.200mV	3.00000mV	1.80000mV	3.20000mV	40	35	45		
	3.00000mV	1.80000mV	3.20000mV	150	140	160		
	3.00000mV	1.80000mV	3.20000mV	1000	900	1100		
	3.00000mV	1.80000mV	3.20000mV	3000	2500	3000		
3.21mV to 32.00mV	30.00000mV	18.00000mV	32.00000mV	40	35	45		
	30.00000mV	18.00000mV	32.00000mV	150	140	160		
	30.00000mV	18.00000mV	32.00000mV	1000	900	1100		
	30.00000mV	18.00000mV	32.00000mV	3000	2500	3000		
32.1mV to 320.0mV	300.000mV	180.000mV	320.000mV	40	35	45		
	300.000mV	180.000mV	320.000mV	150	140	160		
	300.000mV	180.000mV	320.000mV	1000	900	1100		
	300.000mV	180.000mV	320.000mV	3000	2500	3000		
0.321V to 3.200V	3.00000V	1.80000V	3.20000	40	35	45		
	3.00000V	1.80000V	3.20000	150	140	160		
	3.00000V	1.80000V	3.20000	1000	900	1100		
	3.00000V	1.80000V	3.20000	3000	2500	3000		
3.201V to 7.500V	6.00000V	4.00000V	6.50000V	40	35	45		
	6.00000V	4.00000V	6.50000V	150	140	160		
	6.00000V	4.00000V	6.50000V	1000	900	1100		
	6.00000V	4.00000V	6.50000V	3000	2500	3000		

Calibration Procedure

1. Select the required hardware configuration by setting the 9100 output to a suitable value that uses the hardware configuration.
 2. Set the Standards DMM to the appropriate measurement range.
 3. Press the 9100's **TARGET** screen key to display the hardware configuration's target selection screen.
 4. Use (a) or (b):
 - a. To use the target calibration points used during the previous calibration (as indicated by the displayed **SAVED CALIBRATION TARGETS**), press the **Factor** screen key corresponding to the required target value to display a calibrate screen for the target value.
 - b. To use the default target calibration points defined for this hardware configuration, press the **DEFLT** screen key and then press the **Factor** screen key corresponding to the required target value to display a calibrate screen for the target value.
 5. To change the amplitude of the target calibration point, press the **TAB** \leftarrow key one or more times until the cursor is positioned on the target value amplitude. Now use any of the 9100's normal editing modes to change this value. (Note that the new value must lie within the minimum and maximum limits specified in the tables opposite.)
 6. Press the **TRANSFER** screen key to transfer the target calibration point amplitude and frequency to the 9100's output control display.
 7. If you wish to change the target calibration point frequency, press the **TAB** \rightarrow key one or more times until the cursor is positioned on the output frequency control display. Now use any of the 9100's normal editing modes to change this frequency value. (Note that the new value must lie within the limits specified in the tables opposite.)
 8. Press the **ON** key to turn the Model 9100 output on.
 9. Ensure that cursor control is returned to the 9100 output amplitude display, and increment or decrement this value using the cursor controls and/or spinwheel until the reading on the Standards DMM connected to the 9100 front-panel terminals is the same as the displayed target value. (Note: make sure to allow for any settling time required by the external measuring instrument.)
 10. When you are satisfied with the measurement, press the **CALIB** key to generate and implement the correction factor required by the 9100 to ensure that its displayed output value and actual output value coincide. The screen will revert to the **CAL** mode of the normal function screen, and the measured value should now be equal to the displayed output value.
 11. Press the **OFF** key to turn the Model 9100 output off.
 12. Repeat steps (2) to (11) for each of the target values displayed on the target selection screen.
 13. Repeat steps (1) to (11) for each of the hardware configurations detailed in the tables opposite (also see the note below).
- Note:** If other functions are to be calibrated in addition to AC Voltage, refer to *Table 10.4.2.1* on page 10.4-5 for information on sequencing calibrations.

10.4.5 DC Current Calibration

10.4.5.1 Introduction

This section is a guide to calibrating the Model 9100's DC Current Function using its front panel controls. The following topics are covered:

- 10.4.5.2 Calibration Equipment Requirements
- 10.4.5.3 Interconnections
- 10.4.5.4 Calibration Setup
- 10.4.5.5 Calibration Procedure

10.4.5.2 Calibration Equipment Requirements

A traceably characterized, long scale-length, Standards DMM connected to the 9100 output terminals by short, high-quality leads. For example, a Wavetek Model 1281 Digital Multimeter. Note that some DMM's may require a precision current shunt to measure up to 10A.

Final Width = 215mm

10.4.5.3 Interconnections

Interconnections for Low Current Outputs ($\leq 1A$)

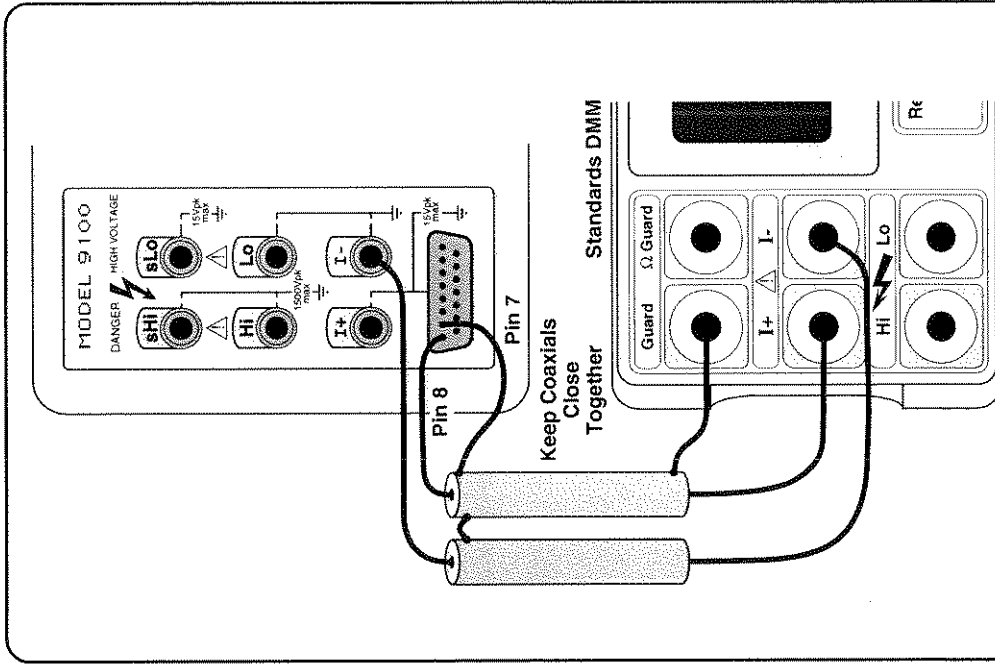

Fig. 10.4.5.1 DC Low Current Calibration — Interconnections

Interconnections for High Current Outputs ($>1A$)

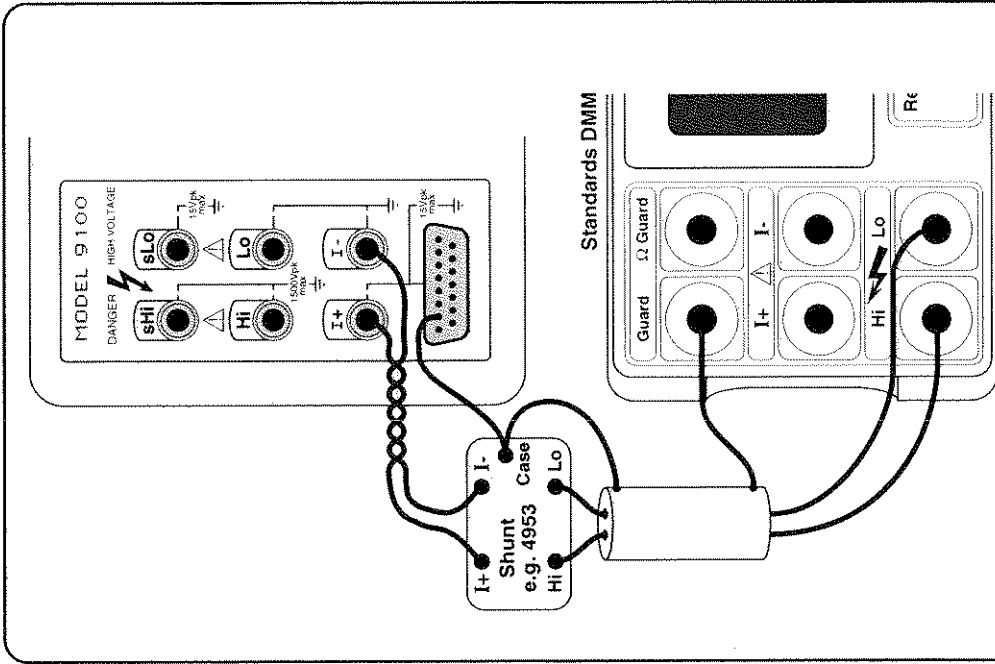

Fig. 10.4.5.2 DC High Current Calibration — Interconnections

10.4.5.4 Calibration Setup

- Connections** Ensure that the 9100 is connected to the Standards DMM as shown in *Fig. 10.4.5.1* or *Fig. 10.4.5.2* (depending on the magnitude of current being calibrated), and that both instruments are powered on and warmed up. If the measuring instrument has a switchable signal guarding facility it should be switched to remote guard. If it does not have a guard facility, there can be no guard lead to the DMM.
- Model 9100** Ensure that the 9100 is in STANDARD CAL mode and then select the DC Current function by pressing the 'A' key on the right of the front panel.

Final Width = 215mm

Table 10.4.5.1: DC Current (Zero to 320mA) Hardware Configurations and Calibration Points

Output span covered by hardware configuration	Suitable output to select hardware configuration	Calibration Targets			Factor Number
		Default	Minimum	Maximum	
000.000 μ A to \pm 320.000 μ A	100 μ A	000.000 μ A	-0.080 μ A	32.000 μ A	1
		+190.000 μ A	180.000 μ A	320.000 μ A	2
\pm 0.32001mA to \pm 3.20000mA	1mA	-1.90000mA	-3.20000mA	-1.80000mA	1
		+1.90000mA	+1.80000mA	+3.20000mA	2
\pm 3.2001mA to \pm 32.0000mA	10mA	-19.0000mA	-32.0000mA	-18.0000mA	1
		+19.0000mA	+18.0000mA	+32.0000mA	2
\pm 32.001mA to \pm 320.000mA	100mA	-190.000mA	-320.000mA	-180.000mA	1
		+190.000mA	+180.000mA	+320.000mA	2

Table 10.4.5.2: DC Current (0.32A to 20A) Hardware Configurations and Calibration Points

Output span covered by hardware configuration	Suitable output to select hardware configuration	Calibration Targets			Factor Number
		Default	Minimum	Maximum	
\pm 0.32001A to \pm 3.20000A	1A	-1.90000A	-3.20000A	-1.80000A	1
		+1.90000A	+1.80000A	+3.20000A	2
\pm 3.2001A to \pm 20.0000A	10A	-10.0000A	-10.5000A	-7.0000A	1
		+10.0000A	+7.0000A	+10.5000A	2

10.4.5.5 Calibration Procedure

1. Select the required hardware configuration by setting the 9100 output to a suitable value that uses the hardware configuration.
2. Set the Standards DMM to the appropriate measurement range.
3. Press the 9100's **TARGET** screen key to display the hardware configuration's target selection screen.
4. Use (a) or (b):
 - a. To use the target calibration points used during the previous calibration (as indicated by the displayed **SAVED CALIBRATION TARGETS**), press the **Factor** screen key corresponding to the required target value, to display a 'calibrate' screen for the target value.
 - b. To use the default target calibration points defined for this hardware configuration, press the **DEFLT** screen key and then press the **Factor** screen key corresponding to the required target value, to display a 'calibrate' screen for the target value.
5. To change the amplitude of the target calibration point, press the **TAB** \oplus key to position the cursor on the target value amplitude. Now use any of the 9100's normal editing modes to change this value. (Note that the new value must lie within the minimum and maximum limits specified in the tables opposite.)
6. Press the **TRANSFR** screen key to transfer the target calibration point value to the Model 9100's output control display.
7. Press the **ON** key to turn the 9100 output on.
8. Press the **TAB** \oplus key to return the cursor to the 9100 output amplitude display, and increment or decrement this value using the cursor controls and/or spinwheel until the reading on the Standards DMM connected to the 9100 front-panel terminals is the same as the displayed target value. (Note: make sure to allow for any settling time required by the external measuring instrument.)
9. When you are satisfied with the measurement, press the **CALIB** key to generate and implement the correction factor required by the 9100 to ensure that its displayed output value and actual output value coincide. The screen will revert to the **CAL** mode of the normal function screen, and the measured value should now be equal to the displayed output value.
10. Press the **OFF** key to turn the 9100 output off.
11. Repeat steps (2) to (10) for each of the target values displayed on the target selection screen.
12. Repeat steps (1) to (11) for each of the hardware configurations detailed in the tables opposite (also see note below).

Note: If other functions are being calibrated in addition to DC Current, refer to *Table 10.4.2.1* on page 10.4.5 for information on sequencing calibrations.

Final Width = 215mm

10.4.5.6 Calibration of Auxiliary DC Current (for Power Option)

Calibration Setup

- 1. Connections** For the **320mA range** connect the 9100 to the Standards DMM as shown in Fig. 10.4.5.3 opposite. If the DMM has a Remote/Local Guard facility, switch it to Local Guard.

For **all other ranges** connect the 9100 to the Standards DMM as shown in Fig. 10.4.5.4 opposite. If the DMM has a Remote/Local Guard facility, it should be switched to Remote Guard when a connection to the shunt's case can be made. If it does not have a guard facility, there can be no guard lead to the DMM.

Ensure that both instruments are powered on and warmed up.
- 2. Model 9100** Ensure that the 9100 is in STANDARD CAL mode and then select Power and DC Current by pressing the front-panel **AUX** key followed by the softkey sequence **POWER***, **---W**, **CHANNEL**, **CURRENT**. Refer also to Fig. 10.2.2.

* This keystroke is only required if one of the oscilloscope calibration options (Option 250 or Option 600) is fitted.

Final Width = 215mm

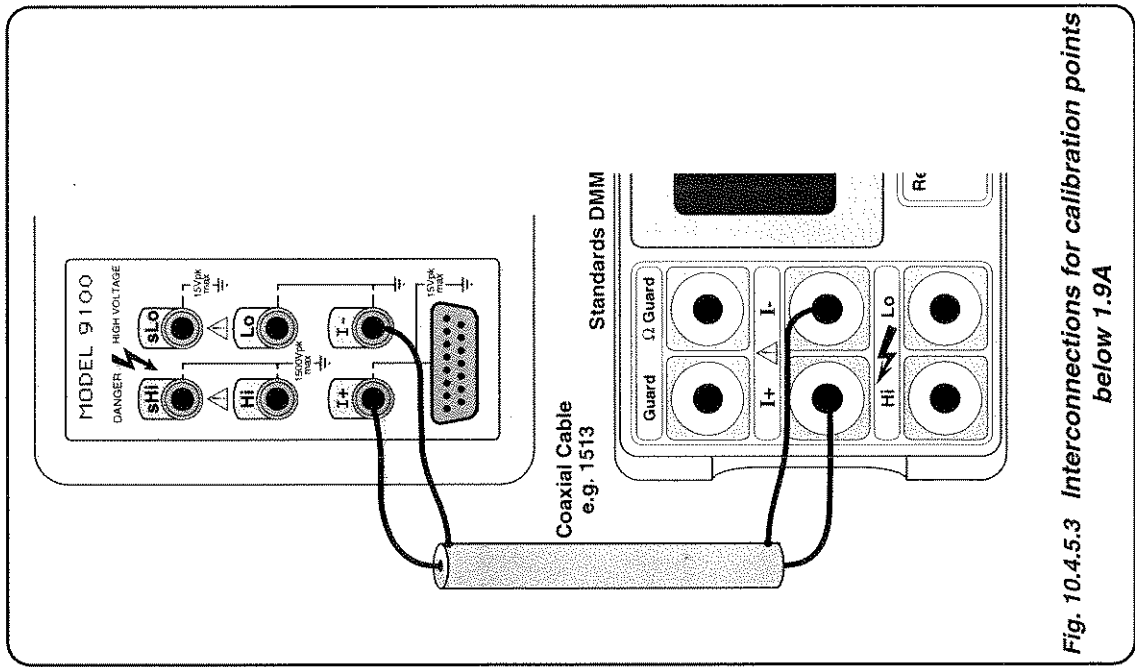

Fig. 10.4.5.3 Interconnections for calibration points below 1.9A

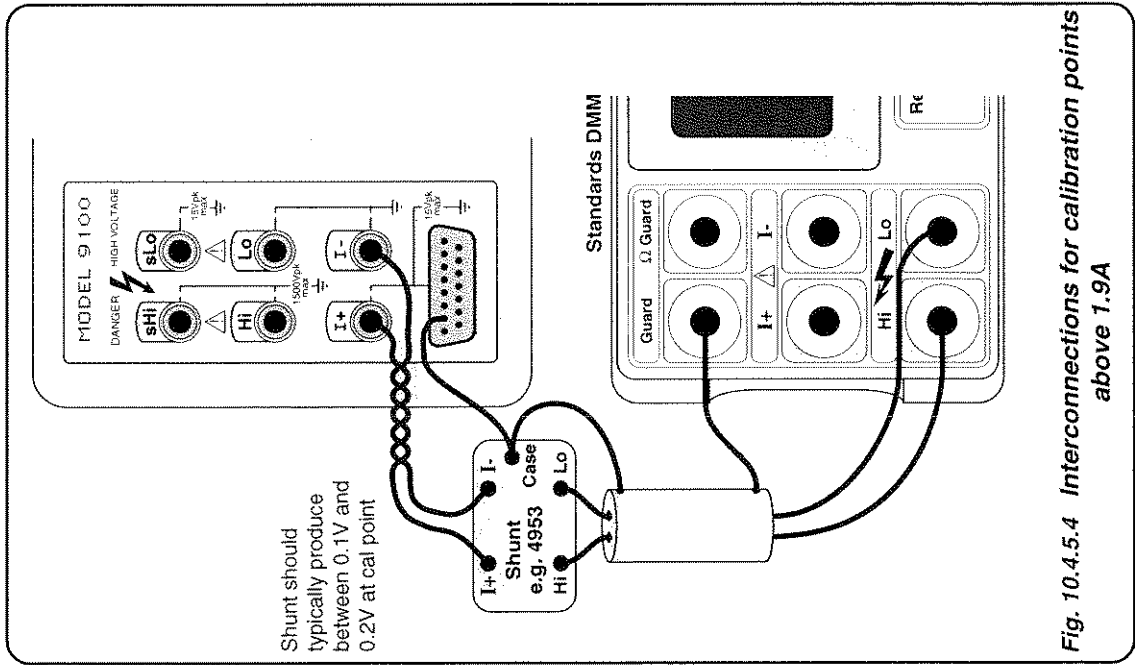

Fig. 10.4.5.4 Interconnections for calibration points above 1.9A

Final Width = 215mm

Table 10.4.5.3: Auxiliary DC Current Calibration Points

Hardware Spans	Calibration Targets		
	Default	Minimum	Maximum
0.000mA to ± 320.0 mA (one range)	-300.000mA +300.000mA	-320.000mA +180.000mA	-180.00mA +320.000mA
± 0.321 A to ± 3.200 A	-3.00000A +3.00000A	-3.20000A +1.80000A	-1.80000A +3.20000A
± 3.21 to ± 32.00 A	-10.0000A +10.0000A	-10.5000A +7.00000A	-7.00000A +10.5000A

Final Width = 215mm

Calibration Procedure

1. Select the required hardware configuration by setting the 9100 output to a suitable value that uses the hardware configuration.
2. Set the Standards DMM to the appropriate measurement range.
3. Press the 9100's **TARGET** screen key to display the hardware configuration's target selection screen.
4. Use (a) or (b):
 - a. To use the target calibration points used during the previous calibration (as indicated by the displayed **SAVED CALIBRATION TARGETS**), press the **Factor** screen key corresponding to the required target value, to display a 'calibrate' screen for the target value.
 - b. To use the default target calibration points defined for this hardware configuration, press the **DEFLT** screen key and then press the **Factor** screen key corresponding to the required target value, to display a 'calibrate' screen for the target value.
5. To change the amplitude of the target calibration point, press the **TAB** key to position the cursor on the target value amplitude. Now use any of the 9100's normal editing modes to change this value. (Note that the new value must lie within the minimum and maximum limits specified in the tables opposite.)
6. Press the **TRANSFR** screen key to transfer the target calibration point value to the Model 9100's output control display.
7. Press the **ON** key to turn the 9100 output on.
8. Press the **TAB** key to return the cursor to the 9100 output amplitude display, and increment or decrement this value using the cursor controls and/or spinwheel until the reading on the Standards DMM connected to the 9100 front-panel terminals is the same as the displayed target value. (Note: make sure to allow for any settling time required by the external measuring instrument.)
9. When you are satisfied with the measurement, press the **CALIB** key to generate and implement the correction factor required by the 9100 to ensure that its displayed output value and actual output value coincide. The screen will revert to the **CAL** mode of the normal function screen, and the measured value should now be equal to the displayed output value.
10. Press the **OFF** key to turn the 9100 output off.
11. Repeat steps (2) to (10) for each of the target values displayed on the target selection screen.
12. Repeat steps (1) to (11) for each of the hardware configurations detailed in the tables opposite (also see note below).

Note: If other functions are being calibrated in addition to DC Current, refer to *Table 10.4.2.1 on page 10.4-5* for information on sequencing calibrations.

10.4.6 AC Current Calibration

10.4.6.1 Introduction

This section is a guide to calibrating the Model 9100's AC Current Function using its front panel controls. The following topics are covered:

- 10.4.6.2 Calibration Equipment Requirements
- 10.4.6.3 Interconnections
- 10.4.6.4 Calibration Setup
- 10.4.6.5 Calibration Procedure

10.4.6.2 Calibration Equipment Requirements

A traceably characterized, long scale-length, Standards DMM connected to the 9100 output terminals by a short, high-quality coaxial cable. For example, a Wavetek Model 1281 Digital Multimeter. Note that some DMMs may require a precision AC Current shunt to measure up to 10A.

Final Width = 215mm

10.4.6.3 Interconnections

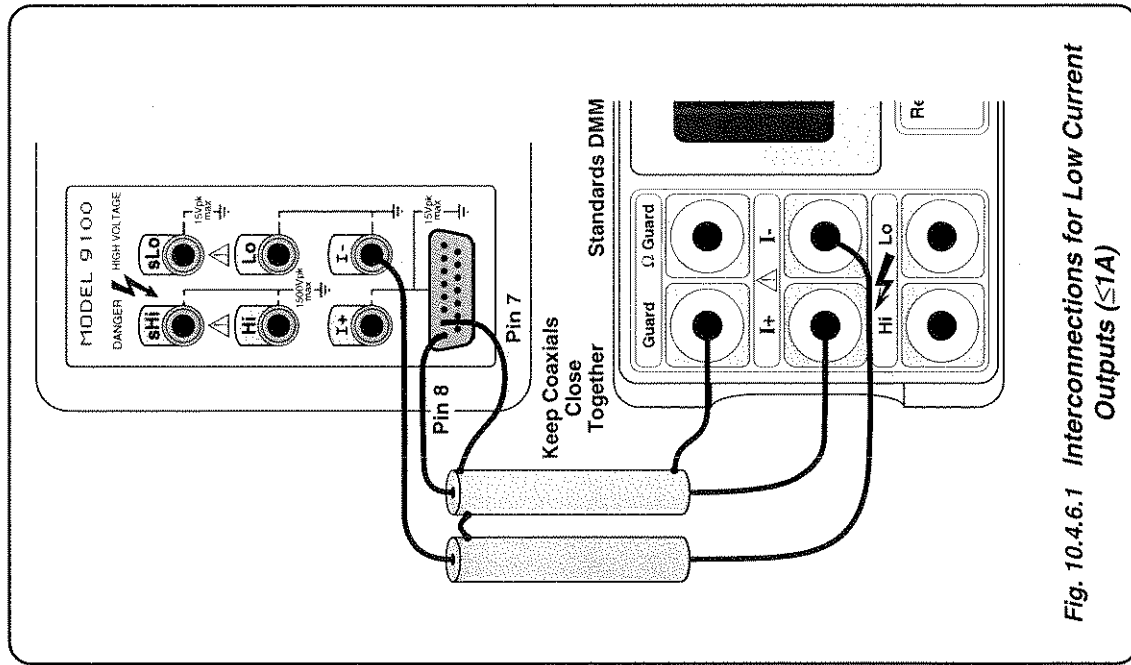

Fig. 10.4.6.1 Interconnections for Low Current Outputs ($\leq 1A$)

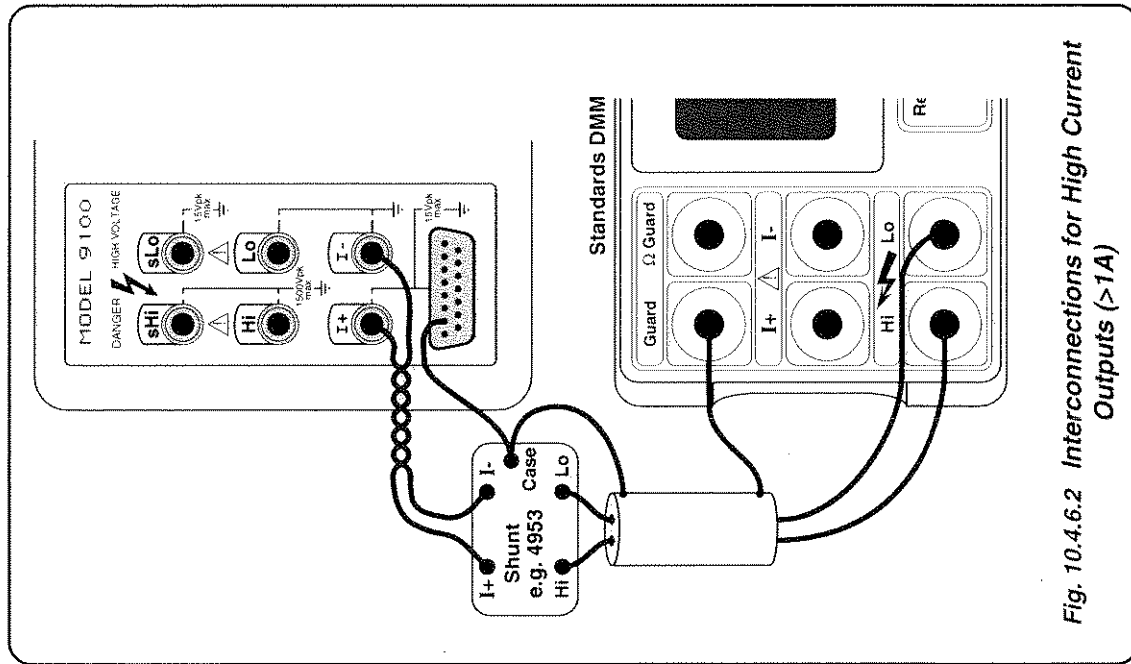

Fig. 10.4.6.2 Interconnections for High Current Outputs ($> 1A$)

Final Width = 215mm

10.4.6.4 Calibration Setup

1. **Connections** Ensure that the Model 9100 is connected to the Standards DMM as shown in Fig. 10.4.6.1 or 10.4.6.2 (depending on the current being calibrated), and that both instruments are powered on and warmed up. If the measuring instrument has a switchable signal guarding facility it should be switched to remote guard. If it does not have a guard facility, there can be no guard lead to the DMM.
2. **9100**
 - a. Ensure that the 9100 is in STANDARD CAL mode and then select the AC Current function by pressing the 'A' key on the right of the front panel, followed by pressing the '√A' screen key adjacent to the display.
 - b. Ensure that *Sinusoidal* waveshape is *selected*, and that the *Phase* facility is *deselected* ($\Delta\Phi$ label dark lettering on light background).

Table 10.4.6.1: AC Current (Zero to 320mA) Hardware Configurations and Calibration Points

Output span covered by hardware configuration	Output to select hardware config.	Calibration Targets									Factor Number
		Amplitude			Frequency			Frequency			
		Default	Minimum	Maximum	Default	Minimum	Maximum	Default	Minimum	Maximum	
000.000µA to 320.000µA	100µA	300.000µA	180.000µA	320.000µA	110.00Hz	10.00Hz	320.00Hz	10.00Hz	1.000kHz	5.000kHz	1
		300.000µA	180.000µA	320.000µA	3.000kHz	20.000kHz	30.000kHz	1.000kHz	1.000kHz	5.000kHz	2
		300.000µA	180.000µA	320.000µA	30.000kHz	20.000kHz	30.000kHz	20.000kHz	20.000kHz	30.000kHz	3
0.32001mA to 3.20000mA	1mA	3.00000mA	1.80000mA	3.20000mA	110.00Hz	10.00Hz	320.00Hz	10.00Hz	1.000kHz	5.000kHz	1
		3.00000mA	1.80000mA	3.20000mA	3.000kHz	20.000kHz	30.000kHz	1.000kHz	1.000kHz	5.000kHz	2
		3.00000mA	1.80000mA	3.20000mA	30.000kHz	20.000kHz	30.000kHz	20.000kHz	20.000kHz	30.000kHz	3
3.2001mA to 32.0000mA	10mA	30.0000mA	18.0000mA	32.0000mA	110.00Hz	10.00Hz	320.00Hz	10.00Hz	1.000kHz	5.000kHz	1
		30.0000mA	18.0000mA	32.0000mA	3.000kHz	20.000kHz	30.000kHz	1.000kHz	1.000kHz	5.000kHz	2
		30.0000mA	18.0000mA	32.0000mA	30.000kHz	20.000kHz	30.000kHz	20.000kHz	20.000kHz	30.000kHz	3
32.001mA to 320.000mA	100mA	300.000mA	180.000mA	320.000mA	110.00Hz	10.00Hz	320.00Hz	10.00Hz	1.000kHz	5.000kHz	1
		300.000mA	180.000mA	320.000mA	3.000kHz	20.000kHz	30.000kHz	1.000kHz	1.000kHz	5.000kHz	2
		300.000mA	180.000mA	320.000mA	30.000kHz	20.000kHz	30.000kHz	20.000kHz	20.000kHz	30.000kHz	3

Table 10.4.6.2: AC Current (0.32A to 20A) Hardware Configurations and Calibration Points

Output span covered by hardware configuration	Output to select hardware config.	Calibration Targets									Factor Number
		Amplitude			Frequency			Frequency			
		Default	Minimum	Maximum	Default	Minimum	Maximum	Default	Minimum	Maximum	
0.32001A to 3.20000A	1A	3.00000A	1.80000A	3.20000A	110.00Hz	10.00Hz	320.00Hz	10.00Hz	2.000kHz	4.000kHz	1
		3.00000A	1.80000A	3.20000A	3.000kHz	7.000kHz	10.000kHz	2.000kHz	7.000kHz	10.000kHz	2
		3.00000A	1.80000A	3.20000A	10.000kHz	7.000kHz	10.000kHz	7.000kHz	7.000kHz	10.000kHz	3
3.2001A to 20.0000A	10A	10.0000A	7.0000A	10.5000A	110.00Hz	10.00Hz	320.00Hz	10.00Hz	2.000kHz	4.000kHz	1
		10.0000A	7.0000A	10.5000A	3.000kHz	7.000kHz	10.000kHz	2.000kHz	7.000kHz	10.000kHz	2
		10.0000A	7.0000A	10.5000A	10.000kHz	7.000kHz	10.000kHz	7.000kHz	7.000kHz	10.000kHz	3

Final Width = 215mm

10.4.6.5 Calibration Procedure

1. Select the required hardware configuration by setting the 9100 output to a suitable value that uses the hardware configuration.
2. Set the Standards DMM to the appropriate measurement range.
3. Press the 9100's **TARGET** softkey to display the hardware configuration's target selection screen.
4. Use (a) or (b):
 - a. To use the target calibration points used during the previous calibration (as indicated by the displayed **SAVED CALIBRATION TARGETS**), press the **Factor** softkey corresponding to the required target value to display a calibrate screen for the target value.
 - b. To use the default target calibration points defined for this hardware configuration, press the **DEFLT** softkey and then press the **Factor** softkey corresponding to the required target value to display a calibrate screen for the target value.
5. To change the amplitude of the target calibration point, press the **TAB** \ominus key one or more times until the cursor is positioned on the target value amplitude. Now use any of the 9100's normal editing modes to change this value. (Note that the new value must lie within the minimum and maximum limits specified in the tables opposite.)
6. Press the **TRANSFR** softkey to transfer the target calibration point amplitude and frequency to the 9100 output control display.
7. To change the target calibration point frequency, press the **TAB** \oplus key one or more times until the cursor is positioned on the output frequency control display. Now use any of the 9100's normal editing modes to change this frequency value. (Note that the new value must lie within the limits specified in the tables opposite.)
8. Press the **ON** key to turn the 9100 output on.
9. Ensure that cursor control is returned to the 9100 output amplitude display, and increment or decrement this value using the cursor controls and/or spinwheel until the reading on the Standards DMM connected to the 9100's front-panel terminals is the same as the displayed target value. (Note: make sure to allow for any settling time required by the external measuring instrument.)
10. When you are satisfied with the measurement, press the **CALIB** key to generate and implement the correction factor required by the 9100 to ensure that its displayed output value and actual output value coincide. The screen will revert to the **CAL** mode of the normal function screen, and the measured value should now be equal to the displayed output value.
11. Press the **OFF** key to turn the 9100 output off.
12. Repeat steps (2) to (11) for each of the target values displayed in the target selection screen.
13. Repeat steps (1) to (12) for each of the hardware configurations detailed in the tables opposite (also see note below).

Note: If other functions are being calibrated in addition to AC Current, refer to *Table 10.4.2.1 on page 10.4-5* for information on sequencing calibrations.

Final Width = 215mm

10.4.6.6 Calibration of Auxiliary AC Current (for Power Option)

Calibration Setup

- 1. Connections**

For the 320mA range connect the 9100 to the Standards DMM as shown in *Fig. 10.4.6.3* opposite. If the DMM has a Remote/Local Guard facility, switch it to Local Guard.

For all other ranges connect the 9100 to the Standards DMM as shown in *Fig. 10.4.6.4* opposite. If the DMM has a Remote/Local Guard facility, it should be switched to Remote Guard when a connection to the shunt's case can be made. If it does not have a guard facility, there can be no guard lead to the DMM.

Ensure that both instruments are powered on and warmed up.

- 2. Model 9100**

Ensure that the 9100 is in STANDARD CAL mode and then select Power and AC Current by pressing the front-panel **AUX** key followed by the softkey sequence **POWER***, \sim **W**^{AUX}, **CHANNEL**, **CURRENT**. Refer also to *Fig. 10.2.2*.

* This keystroke is only required if one of the oscilloscope calibration options (Option 250 or Option 600) is fitted.

Final Width = 215mm

Interconnections for the 320mA range

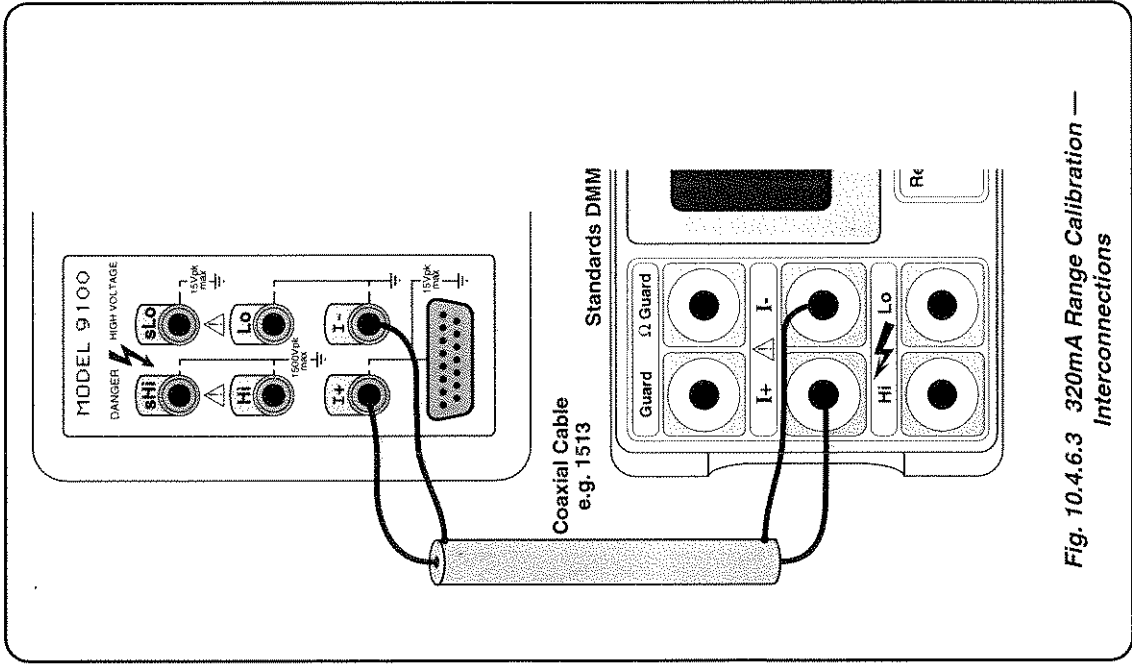

Fig. 10.4.6.3 320mA Range Calibration — Interconnections

Interconnections for ranges above 320mA

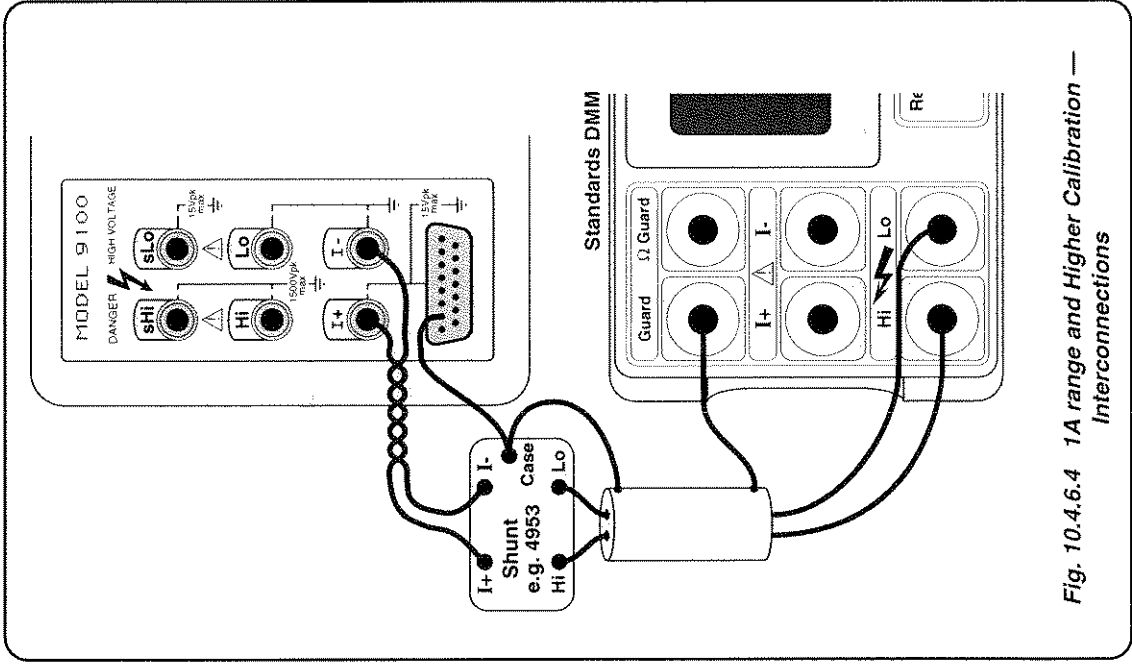

Fig. 10.4.6.4 1A range and Higher Calibration — Interconnections

Final Width = 215mm

Table 10.4.6.3: Auxiliary AC Current Calibration Points

Output span covered by hardware configuration	Calibration Targets								
	Amplitude				Frequency				
	Default	Minimum	Maximum	Default	Minimum	Maximum	Default	Minimum	Maximum
0.000mA to 320.0mA (one range)	300.000mA	180.000mA	320.000A	40Hz	35Hz	45Hz	40Hz	35Hz	45Hz
	300.000mA	180.000mA	320.000A	150Hz	140Hz	160Hz	150Hz	140Hz	160Hz
	300.000mA	180.000mA	320.000A	1000Hz	900Hz	1100Hz	1000Hz	900Hz	1100Hz
	300.000mA	180.000mA	320.000A	3000Hz	2700Hz	3000Hz	3000Hz	2700Hz	3000Hz
0.3201A to 3.200A	3.00000A	1.80000A	3.20000A	40Hz	35Hz	45Hz	40Hz	35Hz	45Hz
	3.00000A	1.80000A	3.20000A	150Hz	140Hz	160Hz	150Hz	140Hz	160Hz
	3.00000A	1.80000A	3.20000A	1000Hz	900Hz	1100Hz	1000Hz	900Hz	1100Hz
	3.00000A	1.80000A	3.20000A	3000Hz	2700Hz	3000Hz	3000Hz	2700Hz	3000Hz
3.21 to 20.00A	10.0000A	7.00000A	10.5000A	40Hz	35Hz	45Hz	40Hz	35Hz	45Hz
	10.0000A	7.00000A	10.5000A	150Hz	140Hz	160Hz	150Hz	140Hz	160Hz
	10.0000A	7.00000A	10.5000A	1000Hz	900Hz	1100Hz	1000Hz	900Hz	1100Hz
	10.0000A	7.00000A	10.5000A	3000Hz	2700Hz	3000Hz	3000Hz	2700Hz	3000Hz

Final Width = 215mm

Calibration Procedure

1. Select the required hardware configuration by setting the 9100 output to a suitable value that uses the hardware configuration.
2. Set the Standards DMM to the appropriate measurement range.
3. Press the 9100's **TARGET** softkey to display the hardware configuration's target selection screen.
4. Use (a) or (b):
 - a. To use the target calibration points used during the previous calibration (as indicated by the displayed **SAVED CALIBRATION TARGETS**), press the **Factor** softkey corresponding to the required target value to display a calibrate screen for the target value.
 - b. To use the default target calibration points defined for this hardware configuration, press the **DEFLT** softkey and then press the **Factor** softkey corresponding to the required target value to display a calibrate screen for the target value.
5. To change the amplitude of the target calibration point, press the **TAB** \oplus key one or more times until the cursor is positioned on the target value amplitude. Now use any of the 9100's normal editing modes to change this value. (Note that the new value must lie within the minimum and maximum limits specified in the tables opposite.)
6. Press the **TRANSFER** softkey to transfer the target calibration point amplitude and frequency to the 9100 output control display.
7. To change the target calibration point frequency, press the **TAB** \oplus key one or more times until the cursor is positioned on the output frequency control display. Now use any of the 9100's normal editing modes to change this frequency value. (Note that the new value must lie within the limits specified in the tables opposite.)
8. Press the **ON** key to turn the 9100 output on.
9. Ensure that cursor control is returned to the 9100 output amplitude display, and increment or decrement this value using the cursor controls and/or spinwheel until the reading on the Standards DMM connected to the 9100's front-panel terminals is the same as the displayed target value. (Note: make sure to allow for any settling time required by the external measuring instrument.)
10. When you are satisfied with the measurement, press the **CALIB** key to generate and implement the correction factor required by the 9100 to ensure that its displayed output value and actual output value coincide. The screen will revert to the **CAL** mode of the normal function screen, and the measured value should now be equal to the displayed output value.
11. Press the **OFF** key to turn the 9100 output off.
12. Repeat steps (2) to (11) for each of the target values displayed in the target selection screen.
13. Repeat steps (1) to (12) for each of the hardware configurations detailed in the tables opposite (also see note below).

Note: If other functions are being calibrated in addition to AC Current, refer to *Table 10.4.2.1 on page 10.4-5* for information on sequencing calibrations.

10.4.7 Resistance Calibration

10.4.7.1 Introduction

This section is a guide to calibrating the Model 9100's Resistance Function using its front panel controls. The following topics are covered:

- 10.4.7.2 Source Currents
- 10.4.7.3 Target Calibration Points
- 10.4.7.4 Calibration Equipment Requirements
- 10.4.7.5 Interconnections
- 10.4.7.6 Calibration Setup
- 10.4.7.7 Calibration of UUTi High Source Current Hardware Configurations
- 10.4.7.8 Calibration of UUTi Low Source Current Hardware Configurations

Final Width = 215mm

10.4.7.2 Source Currents

The 9100 synthesizes resistance by sensing the current (I_{source}) flowing into its terminals, and then driving its terminal voltage to a value given by the equation:

$$V_{terminals} = I_{source} \times R$$

Where R is the output value set on the 9100 display.

To cope with the wide range of source currents used by different UUTs, most of the hardware configurations (spans of output resistance) associated with the Resistance function have user-selectable 'UUTi Low', 'UUTi High' and 'UUTi Super' source current operating modes.

These hardware configurations, and their corresponding ranges of UUTi source currents used during normal operation of the 9100 are shown in *Table 10.4.7.1*. The 9100 is switched between UUTi source currents by pressing the **CHANGE CURRENT** screen key.

Final Width = 21.5mm

Hardware Configuration Limits on Span of Output Resistance	Constant Source Current Limits		
	UUTi Low	UUTi High	UUTi Super
00.0000 Ω to 40.0000 Ω	250μA to 3.5mA	2.5mA to 35mA	25mA to 350mA
040.001 Ω to 400.000 Ω	25μA to 320μA	250μA to 3.5mA	2.5mA to 35mA
0.40001 kΩ to 4.00000 kΩ	25μA to 320μA	250μA to 3.5mA	2.5mA to 35mA
04.0001 kΩ to 40.0000 kΩ	2.5μA to 32μA	25μA to 350μA	250μA to 3.5mA
040.001 kΩ to 400.000 kΩ	250nA to 3.2μA	2.5μA to 35μA	25μA to 350μA
0.40001 MΩ to 4.00000 MΩ	25nA to 320nA	250nA to 3.5μA	2.5μA to 35μA
04.0001 MΩ to 40.0000 MΩ	8nA to 32nA	25nA to 350nA	250nA to 3.5μA
040.001 MΩ to 400.000 MΩ	4nA to 32nA	25nA to 200nA	N/A

Table 10.4.7.1: Resistance Spans and Source Current Limits in Normal Operation

Output Voltage Limitation

The terminal voltage compliance in the Resistance function is limited to 10V. As a result, if the product ($I_{source} \times R$) is greater than 10V, the output will saturate and the apparent output resistance will be less than the value indicated on the screen. Under these conditions the following error message will be displayed:

```

===== WARNING =====
UUT sense current is high.
Internal circuits saturated.
Change current setting.

```

10.4.7.3 Target Calibration Points

All Resistance function hardware configurations, except the one which produces outputs in the range 00.00000Ω to 40.00000Ω , have 'UUTi High' and 'UUTi Low' source current modes which can be calibrated separately using appropriate source currents. It is not advisable to calibrate the 'UUTi Super' source current mode externally, as this requires high source voltages. Because of this, the 'UUTi Super' calibration is done internally from the UUTi High and Low calibrations, and external calibration is not necessary. Because these source currents are driven into the 9100 front-panel terminals by the calibration equipment, it is essential that the calibration equipment's range is selected on the basis of the source current which it generates and not solely on the basis of its resistance measurement range.

To create optimum calibration conditions, the calibration equipment range must be selected so that it:

- a. generates a source current which lies within the range required by the 9100 selected hardware configuration and
 - b. allows measurement of the 9100 output to be made at as high a percentage of the calibration equipment's range as possible.
- For example, suppose your calibration equipment is a standards laboratory DMM which generates a source current of $10\mu\text{A}$ on its $1\text{M}\Omega$ range and $1\mu\text{A}$ on its $10\text{M}\Omega$ range. Its $10\text{M}\Omega$ range should be used to calibrate both the $40.001\text{k}\Omega$ to $400.000\text{k}\Omega$ UUTi Low source current hardware configuration and the $0.40000\text{M}\Omega$ to $4.00000\text{M}\Omega$ UUTi High source current hardware configuration, as both of these require a source current during calibration between 500nA and $2\mu\text{A}$ (see *Table 10.4.7.3* and *Table 10.4.7.2* respectively). Although it would appear that the DMM could measure the $40.001\text{k}\Omega$ to $400.000\text{k}\Omega$ hardware configuration outputs more accurately on its $1\text{M}\Omega$ range, this range cannot be used because its source current is too high.

Final Width = 215mm

Table 10.4.7.2 and *Table 10.4.7.3* list both the default calibration targets and a set of recommended calibration targets, together with the source current limits which are applicable during calibration of the 9100.

The default calibration targets are 'ideal' values which give optimum calibration conditions, but are only usable if suitable calibration equipment is available — i.e. calibration equipment which generates the correct source currents and is traceably calibrated at these target values. The recommended calibration targets are devised to enable measuring instruments with decade ranges (for example, DMMs) to be used as the calibration equipment, while employing high-accuracy points on their ranges.

10.4.7.4 Calibration Equipment Requirements

The procedure is based on the use of a traceably-characterized, long scale-length Standards DMM, using short leads to deliver the 9100 output to the DMM input using a 4-wire connection. For example, a Wavetek Model 1281 Digital Multimeter.

10.4.7.5 Interconnections

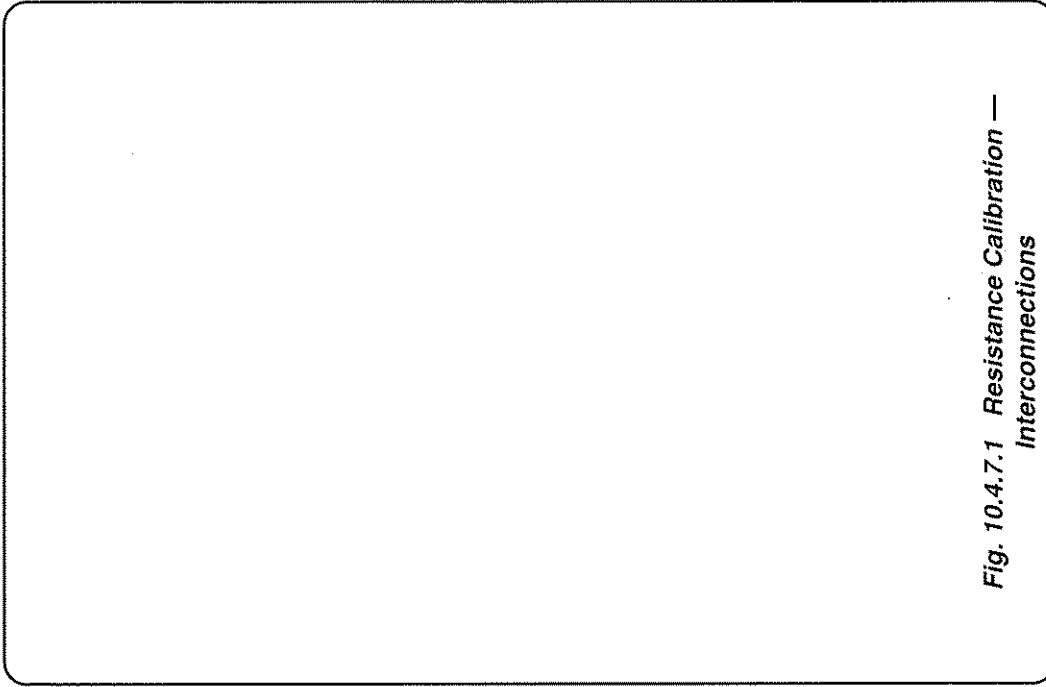

**Fig. 10.4.7.1 Resistance Calibration —
Interconnections**

Final Width = 215mm

10.4.7.6 Calibration Setup

1. **Connections** Ensure that the 9100 is connected to the Standards DMM as shown in Fig. 10.4.7.1, and that both instruments are powered on and warmed up.
2. **9100** Select the Resistance Function by pressing the Ω key on the right of the front panel.

10.4.7.7 Calibration of 'UUTi High' Source Current Hardware Configurations

If both UUTi High and UUTi Low source current hardware configurations are being calibrated, the UUTi High source current calibrations shown in Table 10.4.7.2 below should be performed **before** the UUTi Low source current calibrations.

Table 10.4.7.2: Resistance — 'UUTi High' Source Current Hardware Configurations and Calibration Points

Output span covered by hardware configuration	Output to select hardware config.	Calibration Targets						Factor Number
		Amplitude		Recommended		Source Current		
		Default	Minimum	Maximum	Recommended	Minimum	Maximum	
00.0000 Ω to 40.0000 Ω	10 Ω	1.0000 Ω	0.0100 Ω	7.5000 Ω	0.1000 Ω	500 μ A	2.0mA	1
		30.0000 Ω	10.0000 Ω	39.0000 Ω	38.0000 Ω	500 μ A	2.0mA	2
40.001 Ω to 400.000 Ω	100 Ω	60.000 Ω	41.000 Ω	75.000 Ω	45.000 Ω	500 μ A	2.0mA	1
		300.000 Ω	100.000 Ω	390.000 Ω	380.000 Ω	500 μ A	2.0mA	2
0.40001k Ω to 4.00000k Ω	1k Ω	0.60000k Ω	0.41000k Ω	0.75000k Ω	0.45000k Ω	500 μ A	2.0mA	1
		3.00000k Ω	1.00000k Ω	3.90000k Ω	1.95000k Ω	500 μ A	2.0mA	2
4.0001k Ω to 40.0000k Ω	10k Ω	6.0000k Ω	4.1000k Ω	7.5000k Ω	4.5000k Ω	50 μ A	200 μ A	1
		30.0000k Ω	10.0000k Ω	39.0000k Ω	38.0000k Ω	50 μ A	200 μ A	2
40.001k Ω to 400.000k Ω	100k Ω	60.000k Ω	41.000k Ω	75.000k Ω	45.000k Ω	5.0 μ A	20 μ A	1
		300.000k Ω	100.000k Ω	390.000k Ω	380.000k Ω	5.0 μ A	20 μ A	2
0.40000M Ω to 4.00000M Ω	1M Ω	0.60000M Ω	0.41000M Ω	0.75000M Ω	0.45000M Ω	500nA	2.0 μ A	1
		3.00000M Ω	1.00000M Ω	3.90000M Ω	3.80000M Ω	500nA	2.0 μ A	2
4.0001M Ω to 40.0000M Ω	10M Ω	6.0000M Ω	4.1000M Ω	7.5000M Ω	4.5000M Ω	50nA	200nA	1
		30.0000M Ω	10.0000M Ω	39.0000M Ω	38.0000M Ω	50nA	200nA	2
40.001M Ω to 400.000M Ω	100M Ω	60.000M Ω	41.000M Ω	70.000M Ω	45.000M Ω	50nA	100nA	1
		300.000M Ω	76.500M Ω	390.000M Ω	80.000M Ω	50nA	100nA	2 ^[1]

Notes:

[1] This calibration point is limited by the maximum source current. If the actual source current is less than the indicated maximum, the output value can be raised in inverse proportion. For example, a 50nA source current would allow the calibration point to be increased to 160M Ω .

Final Width = 215mm

Calibration Procedure

1. Select the required hardware configuration by setting the 9100 output to a suitable value that uses the hardware configuration.
2. Set the Standards DMM to the appropriate measurement range.
3. Press the 9100's **TARGET** screen key to display the hardware configuration's target selection screen.
4. Use (a) or (b):
 - a. To use the target calibration points used during the previous calibration (as indicated by the displayed **SAVED CALIBRATION TARGETS**), press the **Factor** screen key corresponding to the required target value, to display a 'calibrate' screen for the target value.
 - b. To use the default target calibration points defined for this hardware configuration, press the **DEFLT** screen key and then press the **Factor** screen key corresponding to the required target value, to display a 'calibrate' screen for the target value.
5. To change the amplitude of the target calibration point, press the **TAB** key to position the cursor on the target value amplitude. Now use any of the 9100's normal editing modes to change this value. (Note that the new value must lie within the minimum and maximum limits specified in the table opposite.)
6. Press the **TRANSFR** screen key to transfer the target calibration point value to the 9100 output control display.
7. Press the **ON** key to turn the 9100 output on.
8. Press the **TAB** key to return the cursor to the 9100 output amplitude display, and increment or decrement this value using the cursor controls and/or spinwheel until the reading on the Standards DMM connected to the 9100 front-panel terminals is the same as the displayed target value. (Note: make sure to allow for any settling time required by the external measuring instrument.)
9. When you are satisfied with the measurement, press the **CALIB** key to generate and implement the correction factor required by the 9100 to ensure that its displayed output value and actual output value coincide. The screen will revert to the **CAL** mode of the normal function screen, and the measured value should now be equal to the displayed output value.
10. Press the **OFF** key to turn the 9100 output off.
11. Repeat steps (2) to (10) for each of the target values displayed in the target selection screen.
12. Repeat steps (1) to (11) for each of the hardware configurations detailed in the table opposite (also see note below).

Note: If other functions are being calibrated in addition to Resistance, refer to *Table 10.4.2.1 on page 10.4-5* for information on sequencing calibrations.

10.4.7.8 Calibration of 'UUTi Low' Source Current Hardware Configuration

If both UUTi High source current and UUTi Low source current hardware configurations are being calibrated, the UUTi Low source current calibrations shown in Table 10.4.7.3 below should be performed **after** the UUTi High source current calibrations. (See Note [2] below)

Table 10.4.7.3: Resistance — 'UUTi Low' Source Current Hardware Configurations and Calibration Points

Output span covered by hardware configuration	Output to select hardware config.	Calibration Targets								Factor Number
		Amplitude				Source Current				
		Default	Minimum	Maximum	Recommended	Minimum	Maximum			
40.001Ω to 400.000Ω	100Ω	60.000Ω	41.000Ω	75.000Ω	45.000Ω	50μA	200μA	1		
		300.000Ω	100.000Ω	390.000Ω	380.000Ω	50μA	200μA			
0.40001kΩ to 4.00000kΩ	1kΩ	0.60000kΩ	0.41000kΩ	0.75000kΩ	0.45000kΩ	50μA	200μA	1		
		3.00000kΩ	1.00000kΩ	3.90000kΩ	3.80000kΩ	50μA	200μA			
4.0001kΩ to 40.0000kΩ	10kΩ	6.0000kΩ	4.1000kΩ	7.5000kΩ	4.5000kΩ	5.0μA	20μA	1		
		30.0000kΩ	10.0000kΩ	39.0000kΩ	38.0000kΩ	5.0μA	20μA			
40.001kΩ to 400.000kΩ	100kΩ	60.000kΩ	41.000kΩ	75.000kΩ	45.000kΩ	500nA	2.0μA	1		
		300.000kΩ	100.000kΩ	390.000kΩ	380.000kΩ	500nA	2.0μA			
0.40000MΩ to 4.00000MΩ	1MΩ	0.60000MΩ	0.41000MΩ	0.75000MΩ	0.45000MΩ	50nA	200nA	1 ^[2]		
		3.00000MΩ	1.00000MΩ	3.90000MΩ	3.80000MΩ	50nA	200nA			
4.0001MΩ to 40.0000MΩ	10MΩ	6.0000MΩ	4.1000MΩ	7.5000MΩ	4.5000MΩ	5.0nA	20nA	1 ^[2]		
		30.0000MΩ	10.0000MΩ	39.0000MΩ	38.0000MΩ	5.0nA	20nA			
40.001MΩ to 400.000MΩ	100MΩ	60.000MΩ	41.000MΩ	75.000MΩ	45.000MΩ	5.0nA	20nA	1 ^[2]		
		300.000MΩ	100.000MΩ	390.000MΩ	380.000MΩ	5.0nA	20nA			

Notes:

[2] Calibration of these UUTi Low source current hardware configurations may be omitted if the Standards DMM has no suitable range, as they are automatically calibrated by internal transfers, to an accuracy greater than that obtainable using the majority of DMMs, when the corresponding UUTi High source current hardware configurations are calibrated. (When the 4MΩ UUTi High source current hardware configuration is calibrated, the 4MΩ UUTi Low source current hardware configuration is automatically calibrated. When the 40MΩ UUTi High source current hardware configuration is calibrated, the 40MΩ and 400MΩ UUTi Low source current hardware configurations are automatically calibrated.)
 If these UUTi Low source current hardware configurations are being calibrated against an external standard as detailed in the table above, the calibration operations must be performed after the corresponding UUTi High source current hardware configurations have been calibrated. Otherwise the calibration correction factors produced will be overwritten by those generated automatically by the UUTi High source current calibrations.

Final Width = 215mm

Calibration Procedure

1. Select the required hardware configuration by setting the 9100 output to a suitable value that uses the hardware configuration.
2. Set the Standards DMM to the appropriate measurement range.
3. Press the 9100's **TARGET** screen key to display the hardware configuration's target selection screen.
4. Use (a) or (b):
 - a. To use the target calibration points used during the previous calibration (as indicated by the displayed **SAVED CALIBRATION TARGETS**), press the **Factor** screen key corresponding to the required target value, to display a 'calibrate' screen for the target value.
 - b. To use the default target calibration points defined for this hardware configuration, press the **DEFLT** screen key and then press the **Factor** screen key corresponding to the required target value, to display a 'calibrate' screen for the target value.
5. To change the amplitude of the target calibration point, press the **TAB** key to position the cursor on the target value amplitude. Now use any of the 9100's normal editing modes to change this value. (Note that the new value must lie within the minimum and maximum limits specified in the tables opposite.)
6. Press the **TRANSFR** screen key to transfer the target calibration point value to the 9100 output control display.
7. Press the **ON** key to turn the 9100 output on.
8. Press the **TAB** key to return the cursor to the 9100 output amplitude display, and increment or decrement this value using the cursor controls and/or spinwheel until the reading on the Standards DMM connected to the 9100 front-panel terminals is the same as the displayed target value. (Note: make sure to allow for any settling time required by the external measuring instrument.)
9. When you are satisfied with the measurement, press the **CALIB** key to generate and implement the correction factor required by the 9100 to ensure that its displayed output value and actual output value coincide. The screen will revert to the **CAL** mode of the normal function screen, and the measured value should now be equal to the displayed output value.
10. Press the **OFF** key to turn the 9100 output off.
11. Repeat steps (2) to (10) for each of the target values displayed in the target selection screen.
12. Repeat steps (1) to (11) for each of the hardware configurations detailed in the table opposite (also see note below).

Note: If other functions are being calibrated in addition to Resistance, refer to *Table 10.4.2.1 on page 10.4-5* for information on sequencing calibrations.

Final Width = 215mm

10.4.7.9 Verification procedures

A full Verification is available at a Wavetek service centre, and this is the preferred method. The user may adopt the following procedural guidance to give a high confidence level that the 9100 is functioning within its specification. Whether an acceptance test or verification test is required, the procedure is the same. The primary points for verification are the calibration points. These are usually multiples of threes. If preferred, the user may use the multiple of 1.9 immediately below; this usually gives slightly better uncertainty, due to better specifications from the 1281. The chosen points should be measured using a wavetek 1281, 1271 or 4950. A 1281 (or 1271 within 24 hours of self cal) will usually be preferred by the user for reasons of availability and speed. If it is desired to verify the 10A range, the use of a Wavetek 4953 shunt is recommended.

The specifications which determine acceptable performance at $23^{\circ}\text{C} \pm 2^{\circ}\text{C}$ for the auxiliary functions are simply those published in the handbook. For verification purposes, the errors of the 1281 or 1271 are compensated for by the fact that the handbook spec is for five degrees. The 3° margin allows for the 1281 errors.

Final Width = 215mm

10.4.8 Capacitance Calibration

10.4.8.1 Introduction

This section is a guide to calibrating the Model 9100's Capacitance Function using its front panel controls. The following topics are covered:

- 10.4.8.2 Calibration Equipment Requirements
- 10.4.8.3 Interconnections
- 10.4.8.4 Calibration Setup
- 10.4.8.5 Calibration of 'UUTi Low' Source Current Hardware Configuration
- 10.4.8.6 'UUTi Low' Source Current Hardware Configuration — Calibration Procedure
- 10.4.8.7 Calibration of 'UUTi Super' Source Current Hardware Configuration
- 10.4.8.8 'UUTi Super' Source Current Hardware Configuration — Calibration Procedure

Is a Local External User-Calibration Really Necessary?

It should be noted that all the hardware configurations associated with the 9100 Capacitance function are automatically calibrated whenever the Resistance function is calibrated. If both the Capacitance and Resistance functions are being separately calibrated against external standards, Capacitance must be calibrated after Resistance to prevent overwriting of the Capacitance function's calibration correction factors.

Due to the cost of maintaining a suitable set of standard capacitors, (2 per 9100 capacitance span), it is not really practicable to use this technique for values above about 400 μ F. Specially-designed equipment is used at manufacture to calibrate the 9100 before shipment.

10.4.8.2 Calibration Equipment Requirements

A set of traceably calibrated standard capacitors at values between the minimum and maximum calibration targets defined in *Table 10.4.8.1* overleaf, and a 3-1/2 digit or better capacitance meter (for example, a Wavetek DM97 Digital Multimeter for UUTi Low source current, and a Wavetek DM28 Digital Multimeter for UUTi Super source current) which is used to make transfer measurements between these standard capacitors and the 9100.

Final Width = 215mm

10.4.8.3 Interconnections

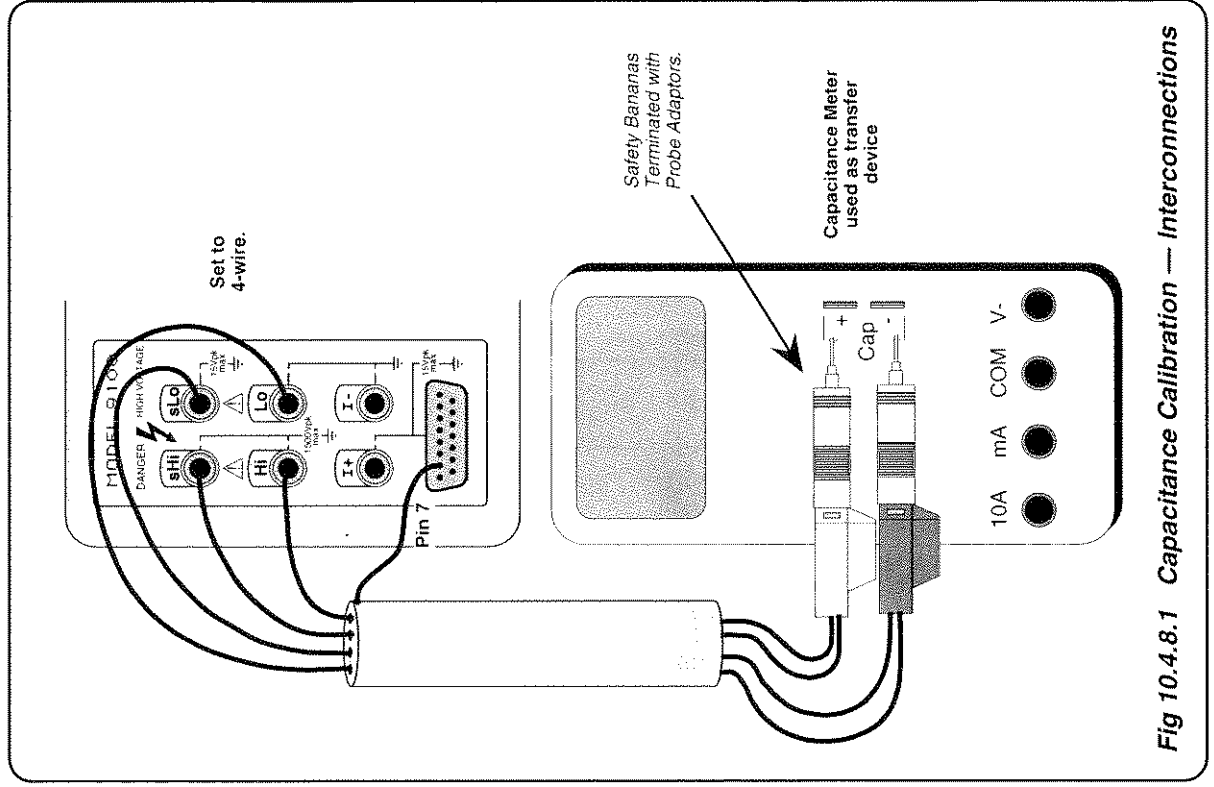

Fig 10.4.8.1 Capacitance Calibration — Interconnections

Final Width = 215mm

10.4.8.4 Calibration Setup

1. **Connections** Ensure that the 9100 is connected to the capacitance meter as shown in *Fig. 10.4.8.1*, and that both instruments are powered on and warmed up.
2. **9100** Ensure that the 9100 is in STANDARD CAL mode and then select the Capacitance function by pressing the 'Aux' key on the right of the front panel followed by the '←' screen key adjacent to the display.

10.4.8.5 Calibration of 'UUTi Low' Source Current Hardware Configurations

For calibration of UUTi Low source current hardware configurations use *Table 10.4.8.1*.

Table 10.4.8.1: Capacitance UUTi Low Hardware Configurations and Calibration Points

Output span covered by hardware configuration	Suitable output to select hardware configuration	Calibration Targets			Factor Number
		Recommended	Minimum	Maximum	
0.5000nF to 4.00000nF	1nF	0.6000nF	0.5200nF	0.8000nF	1
		3.0000nF	2.5000nF	3.9000nF	2
4.0001nF to 40.0000nF	10nF	6.000nF	4.100nF	8.000nF	1
		30.000nF	25.000nF	39.000nF	2
40.001nF to 400.000nF	100nF	60.00nF	41.00nF	80.00nF	1
		300.00nF	250.00nF	390.00nF	2
0.40001μF to 4.00000μF	1μF	0.6000μF	0.4100μF	0.8000μF	1
		3.0000μF	2.5000μF	3.9000μF	2
4.0001μF to 40.0000μF	10μF	6.000μF	4.100μF	8.000μF	1
		30.000μF	25.000μF	39.000μF	2
40.001μF to 400.000μF	100μF	60.00μF	41.00μF	80.00μF	1
		300.00μF	250.00μF	390.00μF	2
0.40001mF to 4.00000mF	1mF	0.6000mF	0.4100mF	0.8000mF	1
		3.0000mF	2.5000mF	3.9000mF	2
4.0001mF to 40.0000mF	10mF	6.000mF	4.100mF	8.000mF	1
		30.000mF	25.000mF	39.000mF	2

Final Width = 215mm

10.4.8.6 'UUTi Low' Source Current Hardware Configurations — Calibration Procedure

1. Select the required hardware configuration by setting the 9100 output to a suitable value that uses the hardware configuration. Select 'UUTi Low' source current (*refer to Model 9100 Universal Calibration System User's Handbook, Volume 1, Section 4, page 4.13-11*).
2. Set the capacitance meter to the appropriate measurement range.
3. Press the 9100's **TARGET** screen key to display the hardware configuration's target selection screen.
4. Press the **Factor** screen key corresponding to the required target value to display a calibrate screen for the target value.
5. If the displayed target value is not the same as the value of your standard capacitor for this calibration point, press the **TAB** key to position the cursor on the target value and use any of the 9100's normal editing modes to change the target value to that of the standard capacitor. (Note that the new value must lie within the minimum and maximum limits specified in the table opposite.)
6. Press the **TRANSFR** screen key to transfer the target calibration point value to the 9100 output control display.
7. Connect the capacitance meter to the standard capacitor and note its reading. (Note: make sure to allow for any settling time required by the capacitance meter.)
8. Reconnect the capacitance meter to the 9100.
9. Press the **ON** key to turn the 9100 output on.
10. Ensure that the cursor is on the 9100 output amplitude display (press the **TAB** key if necessary), and increment or decrement this value using the cursor controls and/or spinwheel until the reading on the capacitance meter is the same as that noted in step (7) above. (Note: make sure to allow for any settling time required by the capacitance meter.)
11. When you are satisfied with the measurement, press the **CALIB** key to generate and implement the correction factor required by the 9100.
12. Press the **OFF** key to turn the 9100 output off.
13. Repeat steps (2) to (12) for each of the target values displayed in the target selection screen.
12. Repeat steps (1) to (13) for each of the hardware configurations detailed in the tables opposite (also see note below).

Note: If other functions are being calibrated in addition to Capacitance, refer to *Table 10.4.2.1 on page 10.4-5* for information on sequencing calibrations.

Final Width = 215mm

10.4.8.7 Calibration of 'UUTi Super' Source Current Hardware Configurations

For calibration of UUTi Super source current hardware configurations use *Table 10.4.8.2.*

Table 10.4.8.2: Capacitance UUTi Super Hardware Configurations and Calibration Points

Output span covered by hardware configuration	Suitable output to select hardware configuration	Calibration Targets			Factor Number
		Recommended	Minimum	Maximum	
40.0001 μ F to 400.0000 μ F	100 μ F	60.0000 μ F	41.0000 μ F	80.0000 μ F	1
		190.0000 μ F	250.0000 μ F	390.0000 μ F	2
0.400001mF to 4.000000mF	1mF	0.600000mF	0.410000mF	0.800000mF	1
		1.900000mF	2.500000mF	3.900000mF	2
4.00001mF to 40.00000mF	10mF	6.00000mF	4.10000mF	8.00000mF	1
		19.00000mF	25.00000mF	39.00000mF	2

Final Width = 215mm

10.4.8.8 'UUTi Super' Source Current Hardware Configurations — Calibration Procedure

1. Select the required hardware configuration by setting the 9100 output to a suitable value that uses the hardware configuration. Select 'UUTi Super' source current (*refer to Model 9100 Universal Calibration System User's Handbook, Volume I, Section 4, page 4.13-11*).
2. Set the capacitance meter to the appropriate measurement range.
3. Press the 9100's **TARGET** screen key to display the hardware configuration's target selection screen.
4. Press the **Factor** screen key corresponding to the required target value to display a calibrate screen for the target value.
5. If the displayed target value is not the same as the value of your standard capacitor for this calibration point, press the **TAB** key to position the cursor on the target value and use any of the 9100's normal editing modes to change the target value to that of the standard capacitor. (Note that the new value must lie within the minimum and maximum limits specified in the table opposite.)
6. Press the **TRANSFR** screen key to transfer the target calibration point value to the 9100 output control display.
7. Connect the capacitance meter to the standard capacitor and note its reading. (Note: make sure to allow for any settling time required by the capacitance meter.)
8. Reconnect the capacitance meter to the 9100.
9. Press the **ON** key to turn the 9100 output on.
10. Ensure that the cursor is on the 9100 output amplitude display (press the **TAB** key if necessary), and increment or decrement this value using the cursor controls and/or spinwheel until the reading on the capacitance meter is the same as that noted in step (7) above. (Note: make sure to allow for any settling time required by the capacitance meter.)
11. When you are satisfied with the measurement, press the **CALIB** key to generate and implement the correction factor required by the 9100.
12. Press the **OFF** key to turn the 9100 output off.
13. Repeat steps (2) to (12) for each of the target values displayed in the target selection screen.
12. Repeat steps (1) to (13) for each of the hardware configurations detailed in the table opposite (also see note below).

Note: If other functions are being calibrated in addition to Capacitance, refer to *Table 10.4.2.1 on page 10.4-5* for information on sequencing calibrations.

Final Width = 215mm

10.4.9 Insulation Resistance Calibration

10.4.9.1 Introduction

This sub-section is a guide to calibrating the Model 9100's Insulation Resistance function (part of Option 135) using the front panel controls.

Due to the high voltages and high resistance values required, it is not practical to calibrate the Option 135 Insulation Resistance function using a standard resistance meter. Special equipment is used at manufacture to calibrate this function of the Model 9100 before shipment.

The following topics are covered in this sub-section:

- 10.4.9.2 Calibration Equipment Requirements
- 10.4.9.3 Interconnections
- 10.4.9.4 Calibration Setup
- 10.4.9.5 Calibration Procedure
- 10.4.9.6 Verification of Output Voltage Display

Final Width = 215mm

10.4.9.2 Calibration Equipment Requirements

- A set of traceably calibrated standard resistors at values between the minimum and maximum targets defined in the following table, capable of withstanding at least 1000V DC for a prolonged period.
- A 3½ digit (or better) insulation test meter (for example, a Yokogawa 2426). This is used to make transfer measurements between the standard resistors and the Model 9100.

Final Width = 215mm

10.4.9.3 Interconnections

Connect the positive output terminal of the insulation meter to the HI terminal of the 9100 and the negative output terminal of the insulation meter to the LO terminal of the 9100 as shown in Fig. 10.4.9.1 below.

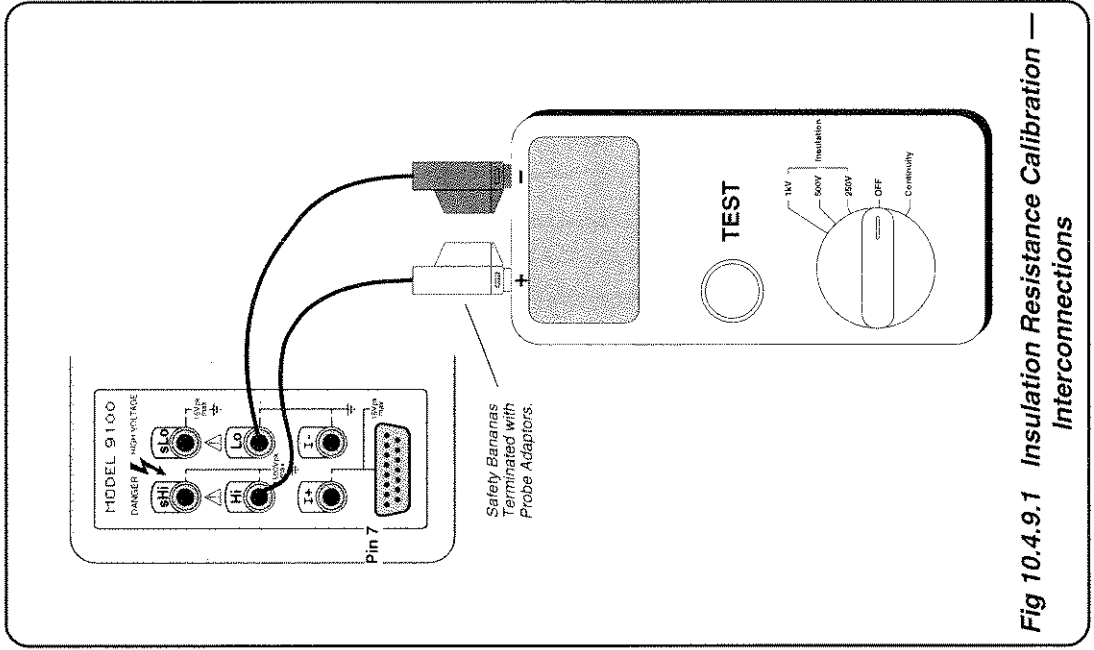

Final Width = 215mm

Fig 10.4.9.1 Insulation Resistance Calibration — Interconnections

10.4.9.4 Calibration Setup

1. **Connections** Ensure that the 9100 is connected to the insulation tester as shown in *Fig. 10.4.9.1* and that both instruments are powered on and warmed up.
2. **9100** Ensure that the 9100 is in STANDARD CAL mode and then select the Insulation Resistance function by pressing the **AUX** key on the right of the front panel followed by the  softkey.

Table 10.4.9.1: Insulation Resistance Hardware Configurations and Calibration Point:

Output span covered by hardware configuration	Suitable output to select h/w configuration	Recommended	Minimum	Maximum	Factor Number
100.0K	200.0K	110.0K 270.0K	100.0K 240.0K	120.0K 299.9K	1 2
300.0K	2.000M	330.0K 1.000M	300.0K 0.900M	360.0K 1.100M	1 2
3.000M	20.00M	3.300M 10.00M	3.000M 9.000M	3.600M 11.00M	1 2
30.00M	200.0M	33.00M 100.0M	30.00M 90.00M	36.00M 110.0M	1 2
300.0M	0.600G	660.0M 1.800G	600.0M 1.600G	720.0M 2.000G	1 2

Final Width = 215mm

10.4.9.6 Calibration Procedure

1. Select the required hardware configuration by setting the 9100 output to a suitable value that uses the hardware configuration.
2. Set the insulation tester to the appropriate measurement range (note that the '1000V' range will provide best accuracy when calibrating the 9100).
3. Press the 9100 **TARGET** softkey to display the hardware configuration's target selection screen.
4. Press the **FACTOR** softkey corresponding to the required target value to display the calibration screen for this value.
5. If the displayed target value is not the same as the value of your standard resistor for this calibration point, press the **TAB** key to position the cursor on the target value and edit this value to that of your standard resistor.
6. Press the **TRANSFER** softkey to transfer the target calibration point to the 9100 output control display.
7. Connect the insulation tester to the standard resistor, press the **TEST** button and note its reading (allow for the settling time of the insulation test meter).
8. Release the **TEST** button and reconnect the insulation tester to the 9100.
9. Press the **ON** key to turn the 9100 output on. Press the **TEST** button on the insulation tester and note the reading.
10. Adjust the 9100 output amplitude until the reading on the insulation tester is the same as that noted in step (7) (allowing for the settling time of the insulation test meter).
11. When you are satisfied with the measurement, press the **CALIB** softkey to generate and implement the correction factor required by the 9100.
12. Press the **OFF** key to turn the 9100 output off.
13. Repeat steps (2) through (12) for both of the target factor values displayed in the target selection screen.
14. Repeat steps (1) through (13) for each of the hardware configurations detailed in the table opposite.

Final Width = 21.5mm

10.4.9.6 Verification of Output Voltage Display

It is not possible to adjust the factors which scale the display of output voltage in the 9100's Insulation Resistance mode. However, a suitable method of verification is as follows:

1. Connect the insulation tester across the HI and LO terminals of the 9100 as shown in *Fig. 10.4.9.1*.
2. Set the 9100 to MANUAL mode and select the insulation resistance function.
3. Connect a 1271 (or equivalent long scale DMM across the HI and LO terminals of the 9100, with the 1271 input switched to DCV on the 1000 volt range (i.e. the 1271 is connected in parallel with the 9100 output terminals).
4. Set the 9100 output impedance to be 1.000M Ω .
5. Select the 500V test range on the insulation tester.
6. Turn the 9100 output ON.
7. Press the **TEST** button on the insulation tester.
8. Note the voltage displayed on the 9100 output screen versus the voltage displayed on the 1271 and confirm that the 9100 displayed voltage is within its published specification of $\pm(0.6\% + 1.5V)$.
9. You will note that the insulation tester will display an impedance of approximately 0.91M Ω - this is because of the 10M Ω input impedance of the 1271 seen in parallel with the 1M Ω impedance being generated by the 9100.
10. Release the **TEST** button on the insulation tester.
11. Turn the 9100 output **OFF**.

Final Width = 215mm

10.4.10 Continuity Calibration

10.4.10.1 Introduction

This sub-section is a guide to calibrating the Model 9100's Continuity function (part of Option 135) using the front panel controls.

The following topics are covered in this sub-section:

- 10.4.10.2 Calibration Equipment Required
- 10.4.10.3 Interconnections
- 10.4.10.4 Calibration Setup
- 10.4.10.5 Calibration Procedure
- 10.4.10.6 Verification of Output Current Display

Final Width = 215mm

10.4.10.2 Calibration Equipment Required

- A set of traceably calibrated standard resistors at values between the minimum and maximum targets defined in the following table, capable of passing at least 350mA DC.
- A 3 1/2 digit (or better) continuity test meter (for example a Yokogawa 2426). This is used to make transfer measurements between the standard resistors and the 9100.

Final Width = 215mm

10.4.10.3 Interconnections

Connect the positive output terminal of the insulation meter to the HI terminal of the 9100 and the negative output terminal of the insulation meter to the LO terminal of the 9100 as shown in Fig. 10.4.9.1 below.

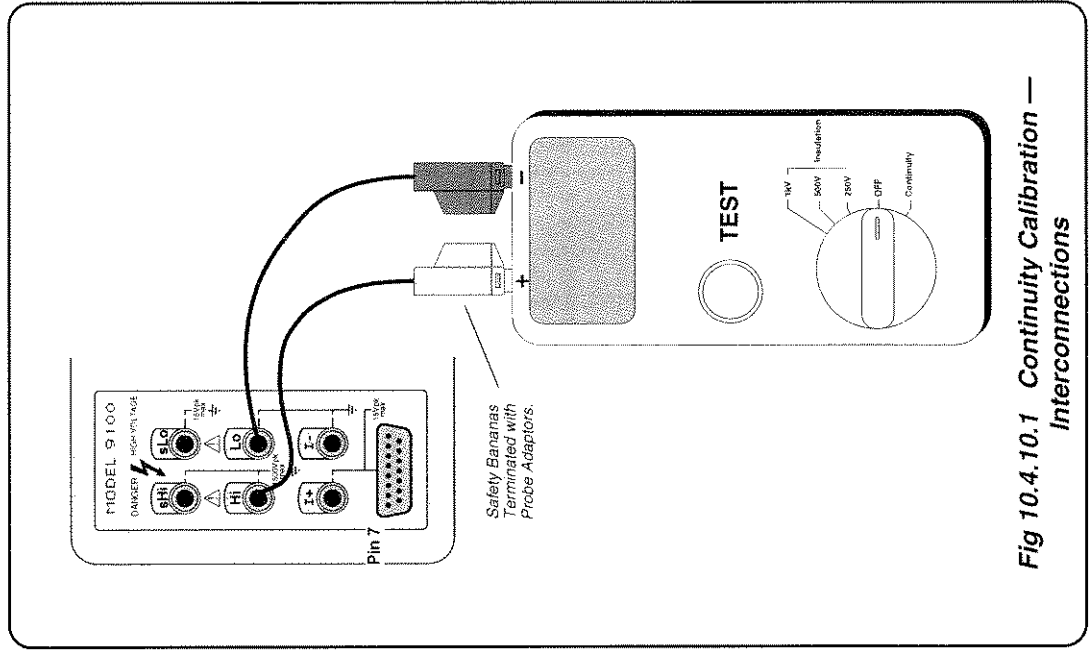

Final Width = 215mm

Fig 10.4.10.1 Continuity Calibration — Interconnections

10.4.9.4 Calibration Setup

1. **Connections** Ensure that the 9100 is connected to the continuity tester as shown in Fig. 10.4.10.1 and that both instruments are powered on and warmed up.
2. **9100** Ensure that the 9100 is in STANDARD CAL mode and then select the Continuity function by pressing the **AUX** key on the right of the front panel followed by the **Ω** softkey.

Table 10.4.9.2: Continuity Hardware Configurations and Calibration Points

Output span covered by hardware configuration	Suitable output to select h/w configuration	Recommended	Minimum	Maximum	Factor Number
00.00000Ω	10Ω	1.00Ω	0.01Ω	7.50Ω	1
		30.00Ω	10.00Ω	39.0Ω	2
40.001Ω	100Ω	60.00Ω	41.00Ω	75.00Ω	1
		300.0Ω	100.0Ω	390Ω	2
0.40001kΩ	1kΩ	600.0Ω	410.0Ω	750.0Ω	1
		3.000kΩ	1.000kΩ	3.900kΩ	2

Final Width = 215mm

10.4.10.3 Calibration Procedure

1. Select the required hardware configuration by setting the 9100 output to a suitable value that uses the hardware configuration.
2. Set the continuity tester to the appropriate measurement range
3. Press the **TARGET** softkey to display the hardware configuration's target selection screen.
4. Press the **FACTOR** softkey corresponding to the required target value to display the calibration screen for this value.
5. If the displayed target value is not the same as the value of your standard resistor for this calibration point, press the **TAB** key to position the cursor on the target value and edit this value to that of your standard resistor.
6. Press the **TRANSFER** softkey to transfer the target calibration point to the 9100 output control display.
7. Connect the continuity tester to the standard resistor, press the **TEST** button and note its reading (allow for the settling time of the test meter).
8. Release the **TEST** button and reconnect the continuity tester to the 9100 using the same test leads.
9. Press the **ON** key to turn the 9100 output on. Press the **TEST** button on the continuity tester and note the reading.
10. Adjust the 9100 output amplitude until the reading on the continuity tester is the same as that noted in step (7)
11. When you are satisfied with the measurement, press the **CALIB** softkey to generate and implement the correction factor required by the 9100.
12. Press the **OFF** key to turn the 9100 output off.
13. Repeat steps (2) through (12) for both of the target values displayed in the target selection screen.
14. Repeat steps (1) through (13) for each of the hardware configurations detailed in the table opposite.

Finel Width = 2/5mm

10.4.10.4 Verification of Output Current Display

1. Connect a 1271/1281 or similar long-scale meter between the 9100 and the continuity meter
2. Select the 1A range on the 1271
3. Set the 9100 output to zero ohms
4. Turn the 9100 output ON
5. Press the TEST button on the continuity meter and confirm that the current reading displayed by the 9100 is within 1.5% of the current displayed on the reference meter.

Final Width = 215mm

10.5 Remote Calibration of the Model 9100 via the IEEE 488 Interface

10.5.1 Model 4950 MTS System

The Model 4950 System is a self-contained, programmable Transfer Standard, capable of fully-traceable, high-accuracy calibration of the latest generation of high-performance multifunction calibrators. It is used to transfer traceable accuracy from standards laboratories to multifunction calibrators at remote locations, and has the following features:

- **Wide Application** - supports all Wavetek calibrators, and other manufacturers' calibrators.
- **Transfer Traceability** - transfers traceable accuracy directly to the calibrator output terminals for all ranges and functions.
- **Fully Automated** - fully automates the calibration process and provides data for Statistical Process Control in order to define tailored certification intervals. Operates in industry-standard PC environment.
- **Portability** - specifically designed and constructed for extensive travel.
- **Cost-Effective** - provides 'on-site' calibration, drastically reducing calibrator downtime.
- **High Confidence Levels** - utilizes a closed-loop calibration process.

Calibration procedures for the Model 9100 are included in the Model 4950 Support Software. For further details of the Model 4950, please contact your local Wavetek Sales/Service center.

Final Width = 215mm

WAVETEK TEST & MEASUREMENT DIVISION — SALES AND SERVICE REPRESENTATIVES WORLDWIDE

ARGENTINA

Reycom Electronica SA
B de Irigoyen 972 ZDO Piso C,
1304 Buenos Aires
Tel: 54 1 300 2013
Fax: 54 1 300 2010

AUSTRALIA

Scientific Devices Pty. Ltd
PO Box 163,
Oakleigh MDC VIC. 3166,
118 Atkinson Street,
Oakleigh, Victoria 3166
Tel: 61 3 9569 1366
Fax: 61 3 9563 4728

AUSTRIA

Wavetek Gesellschaft mbH.
Pharos Haus
Nordbahnstrasse 36/TOP 1.4
A-1020 Vienna, Austria
Tel: 43 1 2145 110
Fax: 43 1 2145 109

AUSTRIA

Walter Rektirsch, und Co.
Vertriebs KG, Obachgasse 28,
1220 Wien
Tel: 43 1 259 7270
Telex: -----
Fax: 43 1 259 7275

BANGLADESH

Sisco International Ltd.
13/2 Toyenbee Circular Road,
Mithibee Commercial Area,
GPO Box 2545
Tel: 880 2 241 491
Telex: 930 632157 WIREJ
Fax: 880 2 833 041

BENELUX

Air Parts International BV
PO Box 255, Kalkovenweg 12,
2400 AG Alphen aan den Rijn
Tel: 31 1 72 422 455
Telex: 844 39564
Fax: 31 1 72 421 022

ECUADOR

Dimatronic SA,
Junin 430 Y Cordova
Guayaquil
Tel: 593 4 301 863
Fax: 593 4 563 664

EASTERN EUROPE

Wavetek GmbH
A-1020 Wien, Pharos Haus,
Nordbahnstraße 36, Top 1.4,
Austria
Tel: 43 1 214 51 10
Fax: 43 1 214 51 09

EGYPT & MIDDLE EAST

Computek Test & Measurement
Instruments Division
23, Amer Street, Dokki,
Giza, Cairo.
Tel: 202 3602234
Fax: 202 349 8563

FINLAND

Teleinstrument Nordic Group
Div. Tecono
Sinkalhorhe 11, Box 51
FIN-02631 Espoo
Tel: 358 9 502 2093
Fax: 358 9 502 2094

FRANCE (1)

Wavetek S. A.
Immeuble le Seine St Germain
12, Bd des îles,
Bat. B 3ème étage,
92130 ISSY LES MOULINEAUX
Tel: 33 1 90 66 66
Fax: 33 1 90 66 50

FRANCE (2)

Wavetek S. A.
34 rue Necker
42000 Saint-Etienne, France
Tel: 33 77 47 89 00
Fax: 33 77 47 89 70

FRANCE (3)

M. B. Electronique
606 Rue Fourry-BP31, Z.I. de Buc,
78533 BUC CEDEX
Tel: 33 1 39 56 81 31
Telex: 842 655414
Fax: 33 1 39 56 53 44

GERMANY

WAVETEK GmbH
Gutenbergstraße 2-4,
85737 Ismaning
Tel: 49-89-99641-0
Fax: 49-89-99641-160

GREECE

American Technical
Enterprises SA
PO Box 3156
Agiou Konstantinou 39,
Athens 10210.
Tel: 30 1 524 8629
30 1 524 0740
Telex: 863 216046 ATE GR
Fax: 30 1 524 9995

GUATEMALA

Celca, SA
20 Calle 16-03, Zona 10,
01010 Guatemala City
Tel: 502 2 335 682
Tel: 502 2 335 683
Tel: 502 2 335 691
Fax: 502 2 335 690

HONG KONG (1)

Wavetek Hong Kong Ltd.
3A, HKPC Building,
78 Tat Chee Avenue,
Kowloon, Hong Kong
Tel: 852 2788 5221
Fax: 852 2788 5220

HONG KONG (2)

Euro Tech (Far East) Ltd
18/F., Gee Chang Hong Centre,
65 Wong Chuk Hang Road,
Hong Kong
Tel: 852 814 8311
Telex: 780 72449 ETELE HK
Fax: 852 873 5974

Final Width = 215mm

ICELAND

Raftus HF
Fiskistod 94
101 Reykjavik
Tel: 354 1 621 616
Fax: 354 1 627 366

INDIA

Technical Trade Links
#170, 1st Floor, 9th Cross,
1st Stage, Indiranagar,
Bangalore - 560038
Tel: 91 80 525 9061
Fax: 91 80 525 1226

INDONESIA

PT Marketlinkindo Persada,
Mecomb Teknik Division
Kawasan Komersial Cilandak
Ged. #304,
Jl. KKO Raya, Cilandak,
Jakarta 12560.
Tel: 62 21 780 8008
Fax: 62 21 780 1040

IRELAND

Euro Electronic Systems
Unit 1, Sandymore Park,
Sandymore Industrial Estate
Dublin 18.
Tel: 353 12 952 326
Fax: 353 12 952 246

ISRAEL

DAN-EL Technologies Ltd.
PO Box 13144, Office 60,
Tel-Aviv 661131.
Tel: 972 3 647 8770
Fax: 972 3 647 8771

ITALY

DELO Instruments
Via Piemonte 14
20090 Fizzonasco Pieve E,
Milano
Tel: 39 2 907 22441
Fax: 39 2 907 22742

JAPAN (Calibration Instruments)

Yokogawa Electric Corporation
155 Takamuro-Cho, Kofu-Shi,
Yamanashi-Ken 400
Tel: 81 552 43 0311
Fax: 81 552 43 0396

JAPAN (GPT Instruments)

Toyo Corporation
26-9, Yushima-Cho
Bunkyo-Ku, Tokyo 113
Tel: 81 356 86 6800
Fax: 81 356 86 6800

KENYA

GES Engsales Kenya Ltd.
P O Box 46658,
Waiyaki Way, ABC Place,
Niarobi
Tel: 254 2 441 209
254 2 448 814
Fax: 254 2 448 815

KOREA

Myoung Corporation
25-4 Yeo Eui Do Dong,
Young Dng Po-Ku
PO Box 14,
Young Dng Po-Ku, Seoul
Tel: 82 2 784 9942
Telex: K24283 WYISG
Fax: 82 2 784 2387

KUWAIT

Tareq Company
PO Box 20506 Safat,
13066 Safat
Tel: 965 243 6100
Telex: 2231 RT ZWIWER
Fax: 965 243 7700

LEBANON

Mabek
PO Box 13-5657,
Beirut
Tel: 961 1 864 487
Telex: 22889 LE MABEK
Fax: 961 1 863 129

MALAYSIA

CNN SDN. BHD,
17D, 2nd Floor,
Lebuhraya Batu Lintang,
11600 Penang
Tel: 60 4 657 9584
Fax: 60 4 657 0835

MEXICO

Mexitex, S.A.
Porfirio Diaz 53, Col. Del Valle,
APDO, Postal 12-1012
Mexico, D.F. 03100
Tel: 525 575 9929
525 575 0312
525 575 9269
Fax: 525 575 9981

MOROCCO

Mimhol SA
64 Rue El Mortada,
Casablanca 02.
Tel: 212 2 25 52 92
212 2 25 55 13
212 2 25 49 69
Telex: 24064M
Fax: 212 2 25 49 92

NEW ZEALAND

Nilsen Technologies (NZ) Ltd.
Unit 1, 59-61 Marsden St.
Lower Hutt.
Tel: 64 4 569 4676
Fax: 64 4 569 4129

NIGERIA

Boladel Doksfad Nigeria Ltd.
8 Eleyele Street,
Eleyele Lay-Out
PO Box 407,
Ile-Ife,
Osun State
Tel: 234 36 232 077

NORWAY

Metric A/S
Scandia Metric Group
Postboks 164, Holmlia
Nordaaerveien 5
N-1203 Oslo.
Tel: 47 22 76 40 00
Fax: 47 22 76 40 50

PAKISTAN (1)

Mushko Electronics (Pvt) Ltd.
Gosman Chambers,
Abdullah Haroon Road,
Karachi 74400
Tel: 92 21 524 131
Telex: 230934 MUEKTI PK
Fax: 92 21 568 2298

PAKISTAN (2)

M/S Intermark (Pvt) Ltd.
Hakimsons Building,
19 West Wharf Road,
PO Box 6159
Karachi 2
Tel: 92 21 201 725
92 21 201 043
92 21 201 045
Telex: 952 823649 YADINPK
Fax: 92 21 231 0450

PERU

BMP Ingenieros SA
Ave Del Parque Sur No 552,
Lima 41
Tel: 51 14 901 224
Fax: 51 14 757 026

PHILIPPINES

Spark Electronics Corp
P.O. Box 610
Greenhills
Metro Manila 1502
Tel: 63 2 7240621-26
Fax: 63 2 7232669/7210491

Final Width = 215mm

PORTUGAL

Década - Equipamentos de Electrónica e Científicos, SA Instrumentação
 Taguspark, Edifício Tecnologia III,
 54 - 2780 OERAS.
Tel: 351 1 421 0111
Fax: 351 1 421 1213

SAUDI ARABIA

Electronic Equipment Marketing Co.
 PO Box 3750,
 No. 28 Al Baroudi Lane
 Thalateen St, Suleimanieh
 Riyadh 11481,
Tel: 966 1 477 1650
Telex: 928 401120 ZHAKESJ
Fax: 966 1 478 5140

SINGAPORE (1)

Wavetek Asia-Pacific Pte Ltd
 51 Goldhill Plaza # 14-04/05
 Singapore 308900
Tel: 65 356 2522
Fax: 65 356 2523

SINGAPORE (2)

O'Connor's Singapore Pte Ltd
 O'Connor's House,
 98, Pasir Panjang Road,
 Singapore 118516
Tel: 65 473 7944
Telex: RS 21023 BCGNIN
Fax: 65 472 4508

SOUTH AFRICA

Altech Instruments Pty Ltd
 PO Box 2097,
 Boksburg 1460
 Transvaal
Tel: 27 11 914 4525
Fax: 27 11 914 1475

SPAIN

Equipos y Sistemas SA (ESSA)
 Avda. De Fuencarral, Km. 15,700
 Edificio Europa, 2º - 5
 28100 Alcobendas, Madrid
Tel: 34 1 657 2215
Fax: 34 1 657 2222

SWEDEN

Kaliber AB
 Maltesholmvägen 136,
 Box 4443 S-165 15 Hasselby
 Stockholm
Tel: 46 8 380 350
Fax: 4 68 380 320

SWITZERLAND

Computer Controls AG
 PO Box 314
 Probusweg 2, CH-8057
 Zurich
Tel: 41 1 308 66 66
Fax: 41 1 308 66 55

TAIWAN

Quatek Co., Ltd.
 2nd Fl, 32, Lane 583, Jui Kwang Road
 Nei-Hu, Taipei
 Taiwan 114, R.O.C.
Tel: 886 2 2797 3357
Fax: 886 2 2797 3957

THAILAND

Schmidt Scientific (Thailand) Ltd.
 69/5 Soi Seuksavitaya
 North Sathorn Road,
 Bangkok 10500.
Tel: 662 236 7784
Fax: 662 237 2627

UNITED ARAB EMIRATES

Al Sanani Trading Establishment
 Old Passport Road,
 PO Box 47187,
 Abu Dhabi
Tel: 971 2 319161
Telex: 958 23966 SANANEM
Fax: 971 2 31554

UNITED KINGDOM

Wavetek Test & Measurement Division
 52 Hurricane Way,
 Norwich Airport,
 Norwich, Norfolk NR6 6JB,
 England
Tel: 44 1603 404 824
Fax: 44 1603 483 670

UNITED STATES OF AMERICA

Wavetek Test & Measurement Division (Service Only)
 c/o Wavetek CATV Division
 5808 Churchman Bypass,
 Indianapolis, IN 46203
Tel: 317 788 9351
Fax: 317 782 4607

North American

Sales & Service
 9045 Balboa Avenue,
 San Diego, CA 92123
Tel: 619 279 2200
Fax: 619 459 0325

VENEZUELA

Onimex C.A.
 2 Avenue Entre,
 3 & 4 Transversal,
 Los Palos Grandes,
 Apartado Postal 61421
 Caracas 1062
Tel: 58 2 285 8641
Fax: 58 2 285 8417

WEST INDIES

WISCO International Ltd.
 690 West 28th Street,
 Hialeah FL 33010,
 USA
Tel: 305 888 1676
Fax: 305 888 1677
Fax: 305 887 1624

WEB SITE

www.wavetek.com

FOR CUSTOMERS IN COUNTRIES NOT LISTED, PLEASE CONTACT WAVETEK TEST AND MEASUREMENT DIVISION IN THE UNITED KINGDOM:

Wavetek Test & Measurement Division

52 Hurricane Way,
 Norwich Airport,
 Norwich, Norfolk NR6 6JB,
 England
Tel: 44 1603 256 680
Fax: 44 1603 483 670

Final Width = 215mm

WAVETEK CORPORATION

Corporate Office
 11995 El Camino Real,
 Ste. 301, San Diego,
 CA 92130, U.S.A. 2310
Tel: 1 619 793 2300
Fax: 1 619 793 2310

